



GAS COMPONENTS



ELECTRIC COMPONENTS



WATER TECHNOLOGY



MECHANICAL COMPONENTS



TOOLS

Spare parts suitable for

CEADO

Find the complete and up-to-date range of products in our GEV Webshop



Manufacturer catalogue

The most important spare parts and accessories arranged clearly for every manufacturer

- ✓ Complete product range and all appliance data always up to date in the GEV Webshop
- ✓ Alphabetical Index at the end of the catalogue

GEV Webshop

www.gev-online.co.uk

www.gev-online.com



- 🔍 Add to Favourites
- 🔍 Sign In with email address and usual password
- 🔍 Easy-order – place several items in your basket at the same time
- 🔍 Quick Item search – no login needed



heating elements

quartz heating elements

1 			
GEV No.	420274	Ref. No.	50111
description	quartz heating element 500W 110V L 370mm ø 10mm connection male faston 6.3mm		

switches and momentary switches



rocker/momentary rocker switches

19x13mm			
1 			
GEV No.	347978	Ref. No.	50108 M98
description	rocker switch mounting measurements 19x13mm black 2NO 240V 6A connection male faston 4.8mm ambient temperature max. 125°C protection IP40		
For models:	E37, E37-Elettronico		

30x11mm			
1 			
GEV No.	347350	Ref. No.	50113
description	rocker switch mounting measurements 30x11mm black 1CO 250V 16A I O connection male faston 6.3mm ambient temperature max. 90°C protection IP40		

push/momentary push switches

19x13mm			
1 			
GEV No.	347283	Ref. No.	50171
description	momentary push switch mounting measurements 19x13mm black 1NO 250V 10A connection male faston 2.8mm ambient temperature max. 120°C protection IP40		
For models:	E10ADX-Grigio, E6A-Destro-Grigio, E6TDX-Grigio, E7A-Destro-Grigio, E7T-Destro-Grigio, E8ADX-Grigio, E8TDX-Grigio, E9ADX-Grigio		

ø16mm			
1 			
GEV No.	301310	Ref. No.	50141+50137+50148 90125
description	push switch mounting ø 16mm chrome 1NO 250V 16A connection male faston 6.3mm protection IP40 ambient temperature max. 150°C		
spare parts for	301310		
	GEV No.	347676	Ref. No. 50141
switch 1NO 250V 16A connection male faston 6.3mm			

1 			
GEV No.	301309	Ref. No.	90124
description	push switch mounting ø 16mm chrome 2NO 250V 16A connection male faston 6.3mm protection IP40 ambient temperature max. 150°C		

ø25mm			
1 			
GEV No.	345160 ¹	Ref. No.	50132
description	push switch mounting ø 25mm red 2NO 250V 16A illuminated connection male faston 6.3mm ambient temperature max. 85°C protection IP40		

¹illuminated

miscellaneous			
1 			
GEV No.	347977	Ref. No.	50175
description	momentary push switch mounting ø 12mm black 1NC 250V 16A connection male faston 6.3mm ambient temperature max. 85°C protection IP40		

1 			
GEV No.	347979	Ref. No.	50174 E2054
description	momentary push switch mounting ø 12mm black 1NO 250V 16A connection male faston 6.3mm ambient temperature max. 85°C protection IP40		

1 			
GEV No.	347980	Ref. No.	50151
description	momentary push switch mounting ø 12mm black 1NO 250V 16A connection male faston 6.3mm ambient temperature max. 85°C protection IP40		



toggle switches

M12x0.75



GEV No.	346516	Ref. No.	50134
description	toggle switch thread M12x0.75 1NO 250V 15A ON-OFF male faston 6.3mm		



GEV No.	346521	Ref. No.	50133
description	toggle switch thread M12x0.75 2CO 250V 15A ON-OFF-MOM male faston with neutral position		

accessories



GEV No.	347679	Ref. No.	50143
description	protection cap for toggle switch thread M12x0.75		

microswitches

lever actuated



GEV No.	347285	Ref. No.	50327
description	microswitch with cable 250V 16A 1NO connection with cable ambient temperature max. 85°C lever length 36mm		
For models:	E10ADX-Grigio, E6A-Destro-Grigio, E7A-Destro-Grigio, E8ADX-Grigio, E9ADX-Grigio		



GEV No.	580078	Ref. No.	50123 83261045
description	microswitch with lever 250V 16A 1CO connection male faston 4.8mm L 68mm ambient temperature max. 125°C mounting distance 22.2mm type 83261 actuating force: 30g		
For models:	E37, E37-Elettronico		



GEV No.	347677	Ref. No.	50105
description	microswitch with lever 250V 16A 1CO connection male faston 6.3mm L 33mm ambient temperature max. 85°C mounting distance 22mm type 83263 actuating force: 35g lever length 25mm		

pin-plunger actuated

non-standard



GEV No.	347284	Ref. No.	50324
description	microswitch with plunger 250V 5A 1NO connection soldering connection ambient temperature max. 85°C with cable cable length 370mm		
For models:	E10ADX-Grigio, E6A-Destro-Grigio, E7A-Destro-Grigio, E8ADX-Grigio, E9ADX-Grigio		

non-standard



GEV No.	347606	Ref. No.	90505
description	microswitch 250V 1NO with cable cable length 350mm		
For models:	E10ADX-Grigio, E6A-Destro-Grigio, E7A-Destro-Grigio, E8ADX-Grigio, E9ADX-Grigio		

system switches (ROLD)





GEV No.	347308	Ref. No.	50137
description	element holder mounting ø 16mm arched black ø 15.9mm ED ø 20mm H 23.5mm		





GEV No.	347282	Ref. No.	50138
description	push button ø 11.9mm chrome-plated 0-1 shaft L 4mm shaft 3.7x3.7mm		
For models:	E10ADX-Grigio, E10SDX-Grigio, E6A-Destro-Grigio, E6S-Destro-Grigio, E6TDX-Grigio, E7A-Destro-Grigio, E7S-Destro-Grigio, E7T-Destro-Grigio, E8ADX-Grigio, E8SDX-Grigio, E8TDX-Grigio, E9ADX-Grigio, E9SDX-Grigio		



			
1			
GEV No.	347680	Ref. No.	50148
description	push button ø 11.9mm chrome-plated 1-2 shaft L 4mm shaft 3.7x3.7mm		

			
1			
GEV No.	345722	Ref. No.	50178
description	switch 1NO 250V 16A connection male faston 6.3mm		
For models:	E6TDX-Grigio, E7T-Destro-Grigio, E8TDX-Grigio		

			
1			
GEV No.	347676	Ref. No.	50141
description	switch 1NO 250V 16A connection male faston 6.3mm		

			
1			
GEV No.	345720	Ref. No.	50170
description	switch 2NO 250V 16A connection male faston 6.3mm		
For models:	E10ADX-Grigio, E10SDX-Grigio, E6A-Destro-Grigio, E6S-Destro-Grigio, E7A-Destro-Grigio, E7S-Destro-Grigio, E8ADX-Grigio, E8SDX-Grigio, E9ADX-Grigio, E9SDX-Grigio		

			
1			
GEV No.	347678	Ref. No.	50140
description	switch 2NO 250V 16A connection male faston 6.3mm black latching triggering pressure 1500mbar ambient temperature max. 150°C series CM		

timers

mechanical timers

			
1			
GEV No.	350039	Ref. No.	50112 M215M2C41
description	timer M2 2-pole operation time 15min impulse spring 2NO at 250V 16A shaft ø 3.6mm shaft squaremm shaft L 16.5mm mounting distance 29mm mounting thread M4 connection male faston 6.3mm ambient temperature max. 125°C 250V		

relays

power relays

with bracket mounting

			
1			
GEV No.	380702	Ref. No.	50153
description	power relays FINDER 230VAC 16A 3NO connection male faston 6.3mm flange dimensions 36x38x68mm manuf. no. 62.83.8.230.0300 230V		

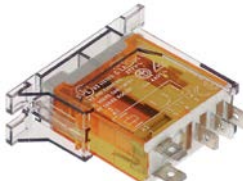
			
1			
GEV No.	381226	Ref. No.	4346.618.230.0040 + 4304605 50155
description	relay FINDER 230VAC 16A 1CO connection male faston 4.8mm flange manuf. no. 46.61.8.230.0040		

electronics

PCBs

			
1			
GEV No.	403441	Ref. No.	50130
description	PCB espresso machine V90 L 65mm W 46mm suitable for CEADO 50Hz voltage input 230V vottage output 230V 230V H 22mm type 1220001 voltage AC Qty 1 pcs		



1

GEV No.	403085	Ref. No.	50162
description	PCB for blenders L 65mm W 35.5mm		



1

GEV No.	402430	Ref. No.	50177
description	PCB for coffee grinder 230V 12V		
For models:	E10ADX-Grigio, E6A-Destro-Grigio, E6TDX-Grigio, E7A-Destro-Grigio, E7T-Destro-Grigio, E8ADX-Grigio, E8TDX-Grigio, E9ADX-Grigio		

fans

axial fans

import



1

GEV No.	601604 ¹	Ref. No.	12032ASTAD 50193
description	axial fan L 119mm W 119mm H 38mm 230VAC 50/60Hz 17/15W bearing slide bearing manuf. no. AA1282HS-AT connection cable 300mm fan wheel ø 110mm temp.-resist. 70°C input current 0.1A airflow 130m ³ /h 2600rpm		
For models:	E10ADX-Grigio, E10SDX-Grigio, E8ADX-Grigio, E8SDX-Grigio, E8TDX-Grigio, E9ADX-Grigio, E9SDX-Grigio		

¹with slide bearings

motors

gear motors

for ice crusher



1

GEV No.	499203	Ref. No.	30107 30107+75501+75508
description	gear motor for ice crusher CIARAMELLA type 624017 220/240V voltage AC 50/60Hz shaft ø 8mm shaft length 33mm mounting distance 34mm with fan wheel		

motors

for bar blender



1

GEV No.	501455	Ref. No.	30103
description	motor for bar blender 220V 450W 50Hz 800rpm thread M6L shaft ø 8mm mounting distance 36mm H 60mm L 165mm W 80mm mounting thread M4 Dragone CEADO		



1

GEV No.	501456	Ref. No.	30108
description	motor for bar blender 230V 1500W 50Hz 2800rpm 1 phase thread M6L shaft ø 8mm mounting distance 55mm H 100mm L 160mm W 90mm CEADO		



1

GEV No.	499202	Ref. No.	90115
description	motor for mixer 230V 50Hz 1 phase shaft ø 10mm shaft length 125mm H 117mm L 70mm W 62mm		



pumps

booster pumps II

accessories



1

GEV No.	365015	Ref. No.	50104
description	operating capacitor capacity 10µF 400V tolerance 5%Hz ambient temperature max. -25 to +85°C ø 35.5mm L 59mm M8 plastic connection male faston 6.3mm protection		
For models:	E6A-Destro-Grigio, E6S-Destro-Grigio, E7A-Destro-Grigio, E7S-Destro-Grigio, E7T-Destro-Grigio		

condensators & interference suppression filters

operating capacitors

plastic



1

GEV No.	365015	Ref. No.	50104
description	operating capacitor capacity 10µF 400V tolerance 5%Hz ambient temperature max. -25 to +85°C ø 35.5mm L 59mm M8 plastic connection male faston 6.3mm protection		
For models:	E6A-Destro-Grigio, E6S-Destro-Grigio, E7A-Destro-Grigio, E7S-Destro-Grigio, E7T-Destro-Grigio		



1

GEV No.	365021	Ref. No.	50173
description	operating capacitor capacity 16µF 425V tolerance 5% 50/60Hz ambient temperature max. -25 to +85°C ø 35mm L 73mm single M8 plastic connection male faston 6.3mm 416.10.99 protection		
For models:	E10ADX-Grigio, E10SDX-Grigio, E8ADX-Grigio, E8SDX-Grigio, E8TDX-Grigio, E9ADX-Grigio, E9SDX-Grigio		

equipment-specific units

for bar blender

blenders

jar components

jars

complete



1

GEV No.	696347	Ref. No.	90105
description	blender jar plastic 1500ml with blade		



1

GEV No.	696437	Ref. No.	90106
description	blender jar plastic 1500ml with mixer disc		

gaskets



1

GEV No.	651007	Ref. No.	75503
----------------	--------	-----------------	-------

description	gasket ED \varnothing 75mm ID \varnothing 55mm thickness 3mm Qty 1 pcs		
--------------------	--	--	--

holders



1

GEV No.	651052	Ref. No.	70101
----------------	--------	-----------------	-------

description	bracket for jar \varnothing 87mm nominal- \varnothing 60mm plastic		
--------------------	--	--	--

blades

blades with adaptor (complete)



1

GEV No.	651054	Ref. No.	90134
----------------	--------	-----------------	-------

description	slicing unit complete bar blender \varnothing 70mm SS		
--------------------	---	--	--



1

GEV No.	696501	Ref. No.	90101
----------------	--------	-----------------	-------

description	slicing unit complete for blenders \varnothing 73mm		
--------------------	---	--	--

mixer discs (complete)



1

GEV No.	696542	Ref. No.	90102
----------------	--------	-----------------	-------

description	mixer disc complete \varnothing 73mm hole \varnothing 6mm		
--------------------	---	--	--

actuators

group 1



1

GEV No.	651041	Ref. No.	45107
----------------	--------	-----------------	-------

description	mixer coupling \varnothing 22mm H 13mm IT M6L teeth 4 stainless steel		
--------------------	---	--	--

group 2



1

GEV No.	651042	Ref. No.	70103
----------------	--------	-----------------	-------

description	mixer coupling \varnothing 32.5mm H 12mm teeth 4 rubber		
--------------------	---	--	--

mixers

miscellaneous



1

GEV No.	698344	Ref. No.	70124
----------------	--------	-----------------	-------

description	bumper for mixer L 63mm W 30mm plastic ID \varnothing 25mm		
--------------------	--	--	--



1

GEV No.	698342	Ref. No.	40110
----------------	--------	-----------------	-------

description	distance washers for mixer L 20mm ID \varnothing 8mm ED \varnothing 10mm		
--------------------	--	--	--



1

GEV No.	698343	Ref. No.	75107
----------------	--------	-----------------	-------

description	threaded shaft for mixer L 45mm nylon ED \varnothing 7.5mm		
--------------------	--	--	--

for juicers/centrifuges

centrifuge baskets

grating discs



1

GEV No.	696499	Ref. No.	20188
description	grating disc for juicer ø 120mm seat ø 14x12mm		

plungers



1

GEV No.	650292	Ref. No.	40213
description	plunger ø 76mm L 177mm total length 200mm		

for ice crusher

motors



1

GEV No.	499203	Ref. No.	30107 30107+75501+75508
description	gear motor for ice crusher CIARAMELLA type 624017 220/240V voltage AC 50/60Hz shaft ø 8mm shaft length 33mm mounting distance 34mm with fan wheel		

for coffee grinders

grinding burrs

grinding burrs straight

standard



1

GEV No.	525524	Ref. No.	40185 90302
description	grinding burrs pair turn direction right D1 ø 64mm ID ø 38mm H 9mm tooth spacing 3mm hole ø 5.5mm bore ø 9mm mounting ø 49 straight suitable for CEADO E6		
For models:	E6A-Destro-Grigio, E6S-Destro-Grigio, E6TDX-Grigio		



1

GEV No.	525525	Ref. No.	40168
description	grinding burrs pair turn direction right D1 ø 64mm ID ø 38mm H 9mm tooth spacing 3mm hole ø 5.5mm bore ø 9mm mounting ø 49 straight suitable for CEADO E7		
For models:	E37, E37-Elettronico, E7A-Destro-Grigio, E7S-Destro-Grigio, E7T-Destro-Grigio		



1

GEV No.	525526	Ref. No.	40180
description	grinding burrs pair turn direction right D1 ø 82.5mm ID ø 49.2mm H 9.5mm tooth spacing 3mm hole ø 6mm bore ø 10.2mm mounting ø 65.5 suitable for CEADO E8		
For models:	E10ADX-Grigio, E10SDX-Grigio, E8ADX-Grigio, E8SDX-Grigio, E8TDX-Grigio, E9ADX-Grigio, E9SDX-Grigio		

screws

1

GEV No.	526921	Ref. No.	45315
description	cylinder head bolt thread M4 thread L 10mm head ø 7mm zinc-coated steel Qty 1 pcs intake slotted head thickness 2.5mm		

1 

GEV No.	526922	Ref. No.	45316
description	flat-headed bolt thread M5 thread L 10mm steel Qty 1 pcs intake slotted head ø 8mm head thickness 3mm		

dosing containers

dosing container lids



1

GEV No.	525517	Ref. No.	70146
description	lid for coffee beans container ø 200mm		
For models:	E10ADX-Grigio, E10SDX-Grigio, E37, E37-Elettronico, E6A-Destro-Grigio, E6S-Destro-Grigio, E6TDX-Grigio, E7A-Destro-Grigio, E7S-Destro-Grigio, E7T-Destro-Grigio, E8ADX-Grigio, E8SDX-Grigio, E8TDX-Grigio, E9ADX-Grigio, E9SDX-Grigio		



1

GEV No.	525519	Ref. No.	70141
description	lid for dosing container ø 120mm		
For models:	E10ADX-Grigio, E10SDX-Grigio, E6A-Destro-Grigio, E6S-Destro-Grigio, E6TDX-Grigio, E7A-Destro-Grigio, E7S-Destro-Grigio, E7T-Destro-Grigio, E8ADX-Grigio, E8SDX-Grigio, E8TDX-Grigio, E9ADX-Grigio, E9SDX-Grigio		

springs

group 1



1

GEV No.	525523	Ref. No.	45507
description	torsion spring ø 28mm wire gauge ø 2mm		
For models:	E10ADX-Grigio, E10SDX-Grigio, E6A-Destro-Grigio, E6S-Destro-Grigio, E6TDX-Grigio, E7A-Destro-Grigio, E7S-Destro-Grigio, E7T-Destro-Grigio, E8ADX-Grigio, E8SDX-Grigio, E8TDX-Grigio, E9ADX-Grigio, E9SDX-Grigio		

glass cylinders



1

GEV No.	525518	Ref. No.	70142
description	cylinder for dosing unit ø 118mm H 60mm plexiglas		
For models:	E10ADX-Grigio, E10SDX-Grigio, E6A-Destro-Grigio, E6S-Destro-Grigio, E6TDX-Grigio, E7A-Destro-Grigio, E7S-Destro-Grigio, E7T-Destro-Grigio, E8ADX-Grigio, E8SDX-Grigio, E8TDX-Grigio, E9ADX-Grigio, E9SDX-Grigio		
accessories for	525518		
	GEV No.	525519	Ref. No.
			70141
	lid for dosing container ø 120mm		

coffee presses

coffee presses



1

GEV No.	525520	Ref. No.	10361
description	coffee press ø 53mm H 16mm aluminium		
For models:	E10ADX-Grigio, E10SDX-Grigio, E6A-Destro-Grigio, E6S-Destro-Grigio, E6TDX-Grigio, E7A-Destro-Grigio, E7S-Destro-Grigio, E7T-Destro-Grigio, E8ADX-Grigio, E8SDX-Grigio, E8TDX-Grigio, E9ADX-Grigio, E9SDX-Grigio		



1

GEV No.	525521	Ref. No.	10362
description	coffee press ø 57mm H 16mm aluminium		
For models:	E10ADX-Grigio, E10SDX-Grigio, E6A-Destro-Grigio, E6S-Destro-Grigio, E6TDX-Grigio, E7A-Destro-Grigio, E7S-Destro-Grigio, E7T-Destro-Grigio, E8ADX-Grigio, E8SDX-Grigio, E8TDX-Grigio, E9ADX-Grigio, E9SDX-Grigio		





coffee beans containers

coffee beans containers



1

GEV No.	525516	Ref. No.	70147
description	coffee beans container ø 200mm H 267mm seat ø 57mm		
For models:	E10ADX-Grigio, E10SDX-Grigio, E37, E37-Elettronico, E6A-Destro-Grigio, E6S-Destro-Grigio, E6TDX-Grigio, E7A-Destro-Grigio, E7S-Destro-Grigio, E7T-Destro-Grigio, E8ADX-Grigio, E8SDX-Grigio, E8TDX-Grigio, E9ADX-Grigio, E9SDX-Grigio		
accessories for	525516		
	GEV No.	525517	Ref. No. 70146
	lid for coffee beans container ø 200mm		
	GEV No.	525522	Ref. No. 70145
	catch for coffee beans container L 122mm W 50mm thickness 6mm plastic		

locks



1

GEV No.	525522	Ref. No.	70145
description	catch for coffee beans container L 122mm W 50mm thickness 6mm plastic		
For models:	E10ADX-Grigio, E10SDX-Grigio, E37, E37-Elettronico, E6A-Destro-Grigio, E6S-Destro-Grigio, E6TDX-Grigio, E7A-Destro-Grigio, E7S-Destro-Grigio, E7T-Destro-Grigio, E8ADX-Grigio, E8SDX-Grigio, E8TDX-Grigio, E9ADX-Grigio, E9SDX-Grigio		

gaskets

sealing washers

silicone gaskets



1

GEV No.	651007	Ref. No.	75503
description	gasket ED ø 75mm ID ø 55mm thickness 3mm Qty 1 pcs		

shaft gaskets

v-rings



1

GEV No.	698360	Ref. No.	75508
description	V-ring for shaft ø 14mm ID ø 12.5mm ED ø 18.5mm thickness 5.5mm		

shaft gaskets



1

GEV No.	698359	Ref. No.	75501
description	shaft sealing ID ø 15mm ED ø 24mm thickness 7mm		

springs

torsion springs



1

GEV No.	525523	Ref. No.	45507
description	torsion spring ø 28mm wire gauge ø 2mm		
For models:	E10ADX-Grigio, E10SDX-Grigio, E6A-Destro-Grigio, E6S-Destro-Grigio, E6TDX-Grigio, E7A-Destro-Grigio, E7S-Destro-Grigio, E7T-Destro-Grigio, E8ADX-Grigio, E8SDX-Grigio, E8TDX-Grigio, E9ADX-Grigio, E9SDX-Grigio		

fastening material

screws

flat-headed bolts



1

GEV No.	526922	Ref. No.	45316
description	flat-headed bolt thread M5 thread L 10mm steel Qty 1 pcs intake slotted head ø 8mm head thickness 3mm		

cylinder head bolts

miscellaneous



1

GEV No.	526921	Ref. No.	45315
description	cylinder head bolt thread M4 thread L 10mm head ø 7mm zinc-coated steel Qty 1 pcs intake slotted head thickness 2.5mm		

A

axial fans 6

B

booster pumps II 7

C

condensators & interference suppression filters 7

cylinder head bolts 12

F

fans 6

fastening material 11

flat-headed bolts 11

H

heating elements 3

M

mechanical timers 5

microswitches 4

motors 6

O

operating capacitors 7

P

pumps 7

push/momentary push switches 3

Q

quartz heating elements 3

R

relays 5

rocker/momentary rocker switches 3

S

screws 11

sealing washers 11

shaft gaskets 11

switches and momentary switches 3

system switches (ROLD) 4

T

timers 5

toggle switches 4