



**GAS COMPONENTS**



**ELECTRIC COMPONENTS**



**WATER TECHNOLOGY**



**MECHANICAL COMPONENTS**



**TOOLS**

Spare parts suitable for

**CASTA**

Find the complete and up-to-date range of products in our GEV Webshop



# Manufacturer catalogue

The most important spare parts and accessories arranged clearly for every manufacturer

- ✓ Complete product range and all appliance data always up to date in the GEV Webshop
- ✓ Alphabetical Index at the end of the catalogue

## GEV Webshop

[www.gev-online.co.uk](http://www.gev-online.co.uk)

[www.gev-online.com](http://www.gev-online.com)



- 🔍 Add to Favourites
- 🔍 Sign In with email address and usual password
- 🔍 Easy-order – place several items in your basket at the same time
- 🔍 Quick Item search – no login needed



## thermostats

### control and safety thermostats

EGO

control thermostats

55.10/19\_series



<b>GEV No.</b>	390046	<b>Ref. No.</b>	08/99900129
<b>description</b>	thermostat t.max. 190°C temperature range 104-190°C 1-pole 1NO 16A probe ø 6mm probe L 133mm capillary pipe 870mm capillary pipe isolatedmm gland nut M9x1 shaft ø 6x4.6mm shaft L 23mm shaft position lower rotation 270° probe material SS		

55.34\_series



<b>GEV No.</b>	375384	<b>Ref. No.</b>	08/85900009
<b>description</b>	thermostat t.max. 275°C temperature range 50-275°C 3-pole 3NO 16A probe ø 3mm probe L 219mm capillary pipe 900mm capillary pipe isolated 900mm gland nut shaft ø 6x4.6mm shaft L 23mm shaft position lower rotation 318° probe material SS		

safety thermostats

55.13\_series



<b>GEV No.</b>	375115	<b>Ref. No.</b>	99900159
<b>description</b>	safety thermostat switch-off temp. 145°C 1-pole 1NO 16A probe ø 6mm probe L 73mm capillary pipe 830mm capillary pipe isolatedmm gland nut probe SS		

**accessories for** 375115



<b>GEV No.</b>	551083	<b>Ref. No.</b>	—
cap for safety thermostat thread M8x1			

55.32\_series



<b>GEV No.</b>	375228	<b>Ref. No.</b>	85900019
<b>description</b>	safety thermostat switch-off temp. 350°C 3-pole 20A probe ø 3mm probe L 188mm capillary pipe 900mm capillary pipe isolated 900mm gland nut probe SS		

## switches and momentary switches

### cam switches

operation switches



<b>GEV No.</b>	300002	<b>Ref. No.</b>	09/85900009
<b>description</b>	cam switch 2 operating positions 4NO 16A sequence 0-1 shaft ø 6x4.6mm shaft L 23mm connection male faston 6.3mm ceramic		

## lamps

### indicator lights

indicator lights (complete)

ø12mm

with screw socket



<b>GEV No.</b>	359048	<b>Ref. No.</b>	14/99901629
<b>description</b>	indicator light ø 12mm 230V yellow connection male faston 6.3mm		



## timers











### audible timers





			
1			
<b>GEV No.</b>	350090	<b>Ref. No.</b>	770033
<b>description</b>	audible timer operation time 60min ø 58mm shaft ø 5x7mm shaft L 15mm mounting distance 28mm		

## gas taps

### PEL

#### 21S series

			
1			
<b>GEV No.</b>	101397	<b>Ref. No.</b>	16/99600059 700003
<b>description</b>	gas tap PEL type 21S gas inlet M16x1.5 (tube ø 10mm) bypass nozzle ø 0.35mm gas outlet M16x1.5 (tube ø 10/8mm) thermocouple connection M9x1 pilot connection M10x1 shaft ø 8x6.5mm shaft L 22/15mm shaft flat lower		
<b>spare parts for</b>	101397		
	<b>GEV No.</b>	100408	<b>Ref. No.</b> —
	bypass nozzle type PEL20/21 bore ø 0.35mm thread M5x0.5		
	<b>GEV No.</b>	101060	<b>Ref. No.</b> —
	magnet unit standard L 39mm D1 ø 15.4mm D2 ø 11mm suitable for PEL20-21/JUNKERS/EGA		
	<b>GEV No.</b>	101206	<b>Ref. No.</b> —
	gas tap front part shaft ø 8x6.5mm shaft L 22/15mm shaft flat upper/lower suitable for PEL21		
	<b>GEV No.</b>	101231	<b>Ref. No.</b> —
	thermocouple nut T1: M9x1 T2: M18x1		
<b>accessories for</b>	101397		
	<b>GEV No.</b>	100908	<b>Ref. No.</b> —
	union screw thread M10x1 for pipe ø 4mm Qty 1 pcs		
	<b>GEV No.</b>	100909	<b>Ref. No.</b> —
	union screw thread M10x1 for pipe ø 6mm Qty 1 pcs		
	<b>GEV No.</b>	101246	<b>Ref. No.</b> —
	olive for pipe ø 4mm Qty 1 pcs		
	<b>GEV No.</b>	101278	<b>Ref. No.</b> 14/99900049
	olive for pipe ø 10mm Qty 1 pcs		
	<b>GEV No.</b>	101286	<b>Ref. No.</b> —
	olive ID ø 6mm Qty 1 pcs		

<b>accessories for</b>	101397		
	<b>GEV No.</b>	101300	<b>Ref. No.</b> 13/10030019 700008
	union nut thread M16x1.5 tube ø 10mm		
	<b>GEV No.</b>	101450	<b>Ref. No.</b> —
	olive for pipe ø 8mm L 12.7mm Qty 1 pcs ED ø 10mm		
	<b>GEV No.</b>	101451	<b>Ref. No.</b> —
	union nut thread M16x1.5 tube ø 8mm		
	<b>GEV No.</b>	110081	<b>Ref. No.</b> 700001
	knob ø 70mm shaft ø 8x6.5mm shaft flat universal		
	<b>GEV No.</b>	112206	<b>Ref. No.</b> —
	knob dial plate silver gas tap PEL21/22/23 t.max.°C ED ø 63mm ID ø 45.5mm		

## gas thermostats

### SIT

#### 630 Eurosit series

















			
1			
<b>GEV No.</b>	101125	<b>Ref. No.</b>	770032
<b>description</b>	gas thermostat type 630 Eurosit series t.max. 340°C 100-340°C gas inlet 3/8" gas outlet 3/8" thermocouple connection M9x1 pilot connection M10x1 probe ø 4mm probe L 72mm capillary pipe 1050mm SIT		
<b>accessories for</b>	101125		
	<b>GEV No.</b>	100825	<b>Ref. No.</b> —
	gas tap spindle shaft ø 8x6.5mm shaft L 22/14mm suitable for EUROSIT		
	<b>GEV No.</b>	100904	<b>Ref. No.</b> —
	locking screw M10x1 for pipe ø 4mm Qty 1 pcs		
	<b>GEV No.</b>	100905	<b>Ref. No.</b> —
	locking screw M10x1 for pipe ø 6mm Qty 1 pcs		
	<b>GEV No.</b>	100949	<b>Ref. No.</b> —
	gasket suitable for 630 Eurosit series		
	<b>GEV No.</b>	101273	<b>Ref. No.</b> —
	olive for pipe ø 12mm L 9.5mm brass Qty 1 pcs suitable for universal		
	<b>GEV No.</b>	101276	<b>Ref. No.</b> —
	union screw thread 3/8" tube ø 12mm Qty 1 pcs		
	<b>GEV No.</b>	101333	<b>Ref. No.</b> —
	plug thread 3/8" with O-ring		
	<b>GEV No.</b>	101390	<b>Ref. No.</b> —
	gas tap spindle shaft ø 6x4.6mm shaft L 32/15mm gas tap with ignition flame suitable for ZANUSSI, MARENO for gas thermostat EUROSIT		

Table continues overleaf



accessories for		101125	
	GEV No.	101392	Ref. No. —
adapter suitable for 630 Eurosit series			
	GEV No.	110357	Ref. No. —
gas tap spindle shaft ø 8x6.5mm shaft L 36/12mm suitable for 630 Eurosit series			
	GEV No.	110358	Ref. No. —
adapter shaft ø 10x8mm shaft L 29/18mm suitable for 630 Eurosit series			













accessories for		106902	
	GEV No.	102110	Ref. No. —
pilot tube copper pipe ø 4mm thickness 1mm L 3000mm			
	GEV No.	102111	Ref. No. —
pilot tube copper pipe ø 6mm thickness 1mm L 3000mm			
	GEV No.	107171	Ref. No. —
pilot burner nozzle SIT natural/liquid gas bore ø 0.25mm Qty 1 pcs			
	GEV No.	107700	Ref. No. —
pilot burner bottom part SIT 100 series nozzle ø 0.25mm			
	GEV No.	107702	Ref. No. —
pilot burner bottom part SIT 100 series nozzle ø 0.35mm			

## ignition parts

### pilot burners

#### SIT

#### 100 series

			
1			
<b>GEV No.</b>	106902	<b>Ref. No.</b>	700011
<b>description</b>	pilot burner SIT type 100 series 2 flames nozzle ø 0.2mm gas connection 6mm		
<b>spare parts for</b>	106902		
	GEV No.	100245	Ref. No. 700012
pilot burner nozzle LPG code 20 bore ø 0.2mm Qty 1 pcs thread M8x0.75			
	GEV No.	100842	Ref. No. —
pilot burner cap 2 flames Qty 1 pcs			
	GEV No.	100885	Ref. No. —
air mixing sleeve for pilot burner Qty 1 pcs			
	GEV No.	100916	Ref. No. —
compression spring for pilot burner Qty 1 pcs			
	GEV No.	100917	Ref. No. —
gasket for pilot burner Qty 1 pcs aluminium			
	GEV No.	100918	Ref. No. —
screw for pilot burner			
	GEV No.	107161	Ref. No. —
pilot burner cap SIT 2 flames Hmm Lmm Qty 1 pcs			
	GEV No.	107701	Ref. No. —
pilot burner bottom part SIT 100 series nozzle ø 0.2mm			
<b>accessories for</b>	106902		
	GEV No.	100246	Ref. No. —
pilot burner nozzle natural gas bore ø 0.35mm Qty 1 pcs thread M8x0.75			
	GEV No.	100904	Ref. No. —
locking screw M10x1 for pipe ø 4mm Qty 1 pcs			
	GEV No.	100905	Ref. No. —
locking screw M10x1 for pipe ø 6mm Qty 1 pcs			

			
1			
<b>GEV No.</b>	106906	<b>Ref. No.</b>	770025
<b>description</b>	pilot burner SIT type 100 series 3 flames nozzle ø 0.2mm gas connection 6mm		
<b>spare parts for</b>	106906		
	GEV No.	100245	Ref. No. 700012
pilot burner nozzle LPG code 20 bore ø 0.2mm Qty 1 pcs thread M8x0.75			
	GEV No.	100855	Ref. No. —
pilot burner bracket triple			
	GEV No.	100885	Ref. No. —
air mixing sleeve for pilot burner Qty 1 pcs			
	GEV No.	100916	Ref. No. —
compression spring for pilot burner Qty 1 pcs			
	GEV No.	100917	Ref. No. —
gasket for pilot burner Qty 1 pcs aluminium			
	GEV No.	100918	Ref. No. —
screw for pilot burner			
	GEV No.	107162	Ref. No. —
pilot burner cap SIT 3 flames Hmm Lmm Qty 1 pcs			
	GEV No.	107701	Ref. No. —
pilot burner bottom part SIT 100 series nozzle ø 0.2mm			
<b>accessories for</b>	106906		
	GEV No.	100245	Ref. No. 700012
pilot burner nozzle LPG code 20 bore ø 0.2mm Qty 1 pcs thread M8x0.75			
	GEV No.	100246	Ref. No. —
pilot burner nozzle natural gas bore ø 0.35mm Qty 1 pcs thread M8x0.75			

Table continues overleaf

accessories for		106906	
	GEV No.	100904	Ref. No. —
locking screw M10x1 for pipe ø 4mm Qty 1 pcs			
	GEV No.	100905	Ref. No. —
locking screw M10x1 for pipe ø 6mm Qty 1 pcs			
	GEV No.	102110	Ref. No. —
pilot tube copper pipe ø 4mm thickness 1mm L 3000mm			
	GEV No.	102111	Ref. No. —
pilot tube copper pipe ø 6mm thickness 1mm L 3000mm			
	GEV No.	107171	Ref. No. —
pilot burner nozzle SIT natural/liquid gas bore ø 0.25mm Qty 1 pcs			
	GEV No.	107700	Ref. No. —
pilot burner bottom part SIT 100 series nozzle ø 0.25mm			
	GEV No.	107702	Ref. No. —
pilot burner bottom part SIT 100 series nozzle ø 0.35mm			

accessories			
pilot burner nozzles			
	1		
GEV No.	100245	Ref. No.	700012
description	pilot burner nozzle LPG code 20 bore ø 0.2mm Qty 1 pcs thread M8x0.75		

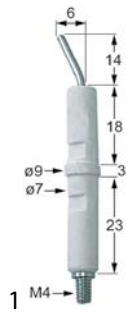
ignition electrodes			
	1		
GEV No.	100706	Ref. No.	770026
description	ignition electrode connection M4 Qty 1 pcs		

## electrodes

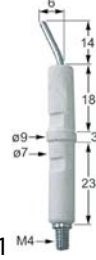

	1		
GEV No.	100706	Ref. No.	770026
description	ignition electrode connection M4 Qty 1 pcs		

	1		
GEV No.	100714	Ref. No.	700016
description	ignition electrode D1 ø 7mm connection M2 to clip		

## ignition cables

pre-assembled cables			
	1		
GEV No.	100193	Ref. No.	770027
description	ignition cable cable length 1200mm connection ø2.4mm / ø4mm		

## piezoelectric igniters

mounting diameter 22mm			
	1		
GEV No.	100013	Ref. No.	770034
description	piezoelectric igniter body plastic blowing mounting ø 22mm connection ø2.4mm cable lengthmm		
accessories for	100013		
	GEV No.	100023	Ref. No. —
female bullet size 2.3mm 0.5-1.5mm <sup>2</sup> CuZn t.max. 125°C Qty 20 pcs			



thermocouples

plug-in thermocouples

plug-in thermocouples standard

with barrel socket ø6(6.5)mm

thermocouples SIT

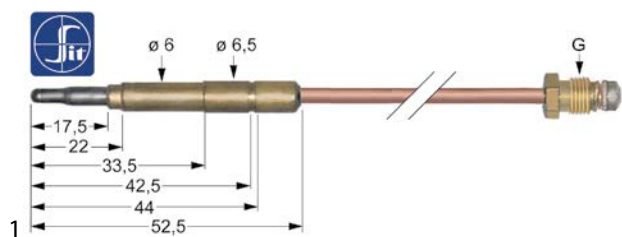

<b>GEV No.</b>	107613	<b>Ref. No.</b>	700010 770024
<b>description</b>	thermocouple SIT M9x1 L 1200mm plug connection ø6.0(6.5)mm		

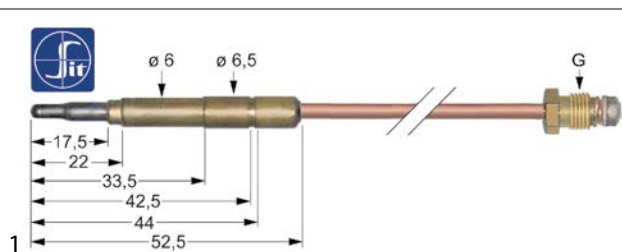

<b>GEV No.</b>	107609	<b>Ref. No.</b>	17/99900649
<b>description</b>	thermocouple SIT M9x1 L 600mm plug connection ø6.0(6.5)mm		

gas burners

hob burners

producer-specific hob burners

CASTA





universal







<b>GEV No.</b>	105425	<b>Ref. No.</b>	68/5080001 700017
----------------	--------	-----------------	----------------------

**description** air mixing sleeve









**accessories for** 105425

	<b>GEV No.</b>	100792	<b>Ref. No.</b>	700416
gas injector thread M10x1 WS 11 bore ø 1.35mm LPG gas pressure 50mbar				
	<b>GEV No.</b>	100793	<b>Ref. No.</b>	700316
gas injector thread M10x1 WS 11 bore ø 1.5mm				
	<b>GEV No.</b>	100794	<b>Ref. No.</b>	700016
gas injector thread M10x1 WS 11 bore ø 2.35mm natural gas gas pressure 20mbar				
	<b>GEV No.</b>	100795	<b>Ref. No.</b>	700116 700216
gas injector thread M10x1 WS 11 bore ø 2.6mm natural gas gas pressure 20mbar				
	<b>GEV No.</b>	102772	<b>Ref. No.</b>	700116
gas injector thread M10x1 WS 11 bore ø 2.5mm				



<b>accessories for</b>	105425			
	<b>GEV No.</b>	105423	<b>Ref. No.</b>	04/99900109 04/99900109 + 14/99700021 40/99900109 700020
round burner C ø 175mm 9.5kW pipe connection ø 31mm				
	<b>GEV No.</b>	105424	<b>Ref. No.</b>	04/99900309 700019
venturi gas burner				
	<b>GEV No.</b>	105426	<b>Ref. No.</b>	13/99901039 700015
nozzle holder nozzle mounting M10x1 tube ø 10mm gas inlet M16x1.5 gas outlet M14x1				

	<b>GEV No.</b>	105426	<b>Ref. No.</b>	13/99901039 700015
<b>description</b> nozzle holder nozzle mounting M10x1 tube ø 10mm gas inlet M16x1.5 gas outlet M14x1				

<b>accessories for</b>	105426			
	<b>GEV No.</b>	100792	<b>Ref. No.</b>	700416
gas injector thread M10x1 WS 11 bore ø 1.35mm LPG gas pressure 50mbar				
	<b>GEV No.</b>	100793	<b>Ref. No.</b>	700316
gas injector thread M10x1 WS 11 bore ø 1.5mm				
	<b>GEV No.</b>	100794	<b>Ref. No.</b>	700016
gas injector thread M10x1 WS 11 bore ø 2.35mm natural gas gas pressure 20mbar				
	<b>GEV No.</b>	100795	<b>Ref. No.</b>	700116 700216
gas injector thread M10x1 WS 11 bore ø 2.6mm natural gas gas pressure 20mbar				
	<b>GEV No.</b>	101278	<b>Ref. No.</b>	14/99900049
olive for pipe ø 10mm Qty 1 pcs				
	<b>GEV No.</b>	101300	<b>Ref. No.</b>	13/10030019 700008
union nut thread M16x1.5 tube ø 10mm				
	<b>GEV No.</b>	102772	<b>Ref. No.</b>	700116
gas injector thread M10x1 WS 11 bore ø 2.5mm				
	<b>GEV No.</b>	105423	<b>Ref. No.</b>	04/99900109 04/99900109 + 14/99700021 40/99900109 700020
round burner C ø 175mm 9.5kW pipe connection ø 31mm				
	<b>GEV No.</b>	105424	<b>Ref. No.</b>	04/99900309 700019
venturi gas burner				
	<b>GEV No.</b>	105425	<b>Ref. No.</b>	68/5080001 700017
air mixing sleeve				

			
<b>GEV No.</b>	105423	<b>Ref. No.</b>	04/99900109 04/99900109 + 14/99700021 40/99900109 700020
<b>description</b>	round burner C ø 175mm 9.5kW pipe connection ø 31mm		
<b>accessories for</b>	105423		
	<b>GEV No.</b>	100792	<b>Ref. No.</b> 700416
	gas injector thread M10x1 WS 11 bore ø 1.35mm LPG gas pressure 50mbar		
	<b>GEV No.</b>	100793	<b>Ref. No.</b> 700316
	gas injector thread M10x1 WS 11 bore ø 1.5mm		
	<b>GEV No.</b>	100794	<b>Ref. No.</b> 700016
	gas injector thread M10x1 WS 11 bore ø 2.35mm natural gas gas pressure 20mbar		
	<b>GEV No.</b>	100795	<b>Ref. No.</b> 700116 700216
	gas injector thread M10x1 WS 11 bore ø 2.6mm natural gas gas pressure 20mbar		
	<b>GEV No.</b>	102772	<b>Ref. No.</b> 700116
	gas injector thread M10x1 WS 11 bore ø 2.5mm		
	<b>GEV No.</b>	105424	<b>Ref. No.</b> 04/99900309 700019
	venturi gas burner		
	<b>GEV No.</b>	105425	<b>Ref. No.</b> 68/50800001 700017
	air mixing sleeve		
	<b>GEV No.</b>	105426	<b>Ref. No.</b> 13/99901039 700015
	nozzle holder nozzle mounting M10x1 tube ø 10mm gas inlet M16x1.5 gas outlet M14x1		

			
<b>GEV No.</b>	105424	<b>Ref. No.</b>	04/99900309 700019
<b>description</b>	venturi gas burner		
<b>accessories for</b>	105424		
	<b>GEV No.</b>	100792	<b>Ref. No.</b> 700416
	gas injector thread M10x1 WS 11 bore ø 1.35mm LPG gas pressure 50mbar		
	<b>GEV No.</b>	100793	<b>Ref. No.</b> 700316
	gas injector thread M10x1 WS 11 bore ø 1.5mm		
	<b>GEV No.</b>	100794	<b>Ref. No.</b> 700016
	gas injector thread M10x1 WS 11 bore ø 2.35mm natural gas gas pressure 20mbar		
	<b>GEV No.</b>	100795	<b>Ref. No.</b> 700116 700216
	gas injector thread M10x1 WS 11 bore ø 2.6mm natural gas gas pressure 20mbar		
	<b>GEV No.</b>	102772	<b>Ref. No.</b> 700116
	gas injector thread M10x1 WS 11 bore ø 2.5mm		

<b>accessories for</b>	105424		
	<b>GEV No.</b>	105423	<b>Ref. No.</b> 04/99900109 04/99900109 + 14/99700021 40/99900109 700020
	round burner C ø 175mm 9.5kW pipe connection ø 31mm		
	<b>GEV No.</b>	105425	<b>Ref. No.</b> 68/50800001 700017
	air mixing sleeve		
	<b>GEV No.</b>	105426	<b>Ref. No.</b> 13/99901039 700015
	nozzle holder nozzle mounting M10x1 tube ø 10mm gas inlet M16x1.5 gas outlet M14x1		

<b>reducers for pan supports</b>			
			
<b>GEV No.</b>	210171	<b>Ref. No.</b>	01/99900008 744002 RID. GRI. - 01/99900008
<b>description</b>	reducer for pan support L 375mm W 375mm suitable for wok range		

			
<b>GEV No.</b>	210178	<b>Ref. No.</b>	01/99900007 706002
<b>description</b>	reducer for pan support ø 340mm ring ø 190mm foot length 75mm cast iron suitable for wok range		

<b>height extensions</b>			
			
<b>GEV No.</b>	210169	<b>Ref. No.</b>	01/99900006 744001 GRIGLIA.CINESE GRIGLIA/CC - 01/99900006
<b>description</b>	attachment ring ø 380mm H 75mm suitable for wok range		

			
<b>GEV No.</b>	210170	<b>Ref. No.</b>	01/99900019 744003 CERCHIO/CC
<b>description</b>	pan support ø 370mm suitable for wok range		





accessories			
reducers for pan supports			
			
1			
<b>GEV No.</b>	210171	<b>Ref. No.</b>	01/99900008 744002 RID. GRI. - 01/99900008
<b>description</b>	reducer for pan support L 375mm W 375mm suitable for wok range		

			
1			
<b>GEV No.</b>	210178	<b>Ref. No.</b>	01/99900007 706002
<b>description</b>	reducer for pan support ø 340mm ring ø 190mm foot length 75mm cast iron suitable for wok range		



pan supports			
			
1			
<b>GEV No.</b>	210170	<b>Ref. No.</b>	01/99900019 744003 CERCHIO/CC
<b>description</b>	pan support ø 370mm suitable for wok range		

accessories			
nozzle holders			
			
1			
<b>GEV No.</b>	105426	<b>Ref. No.</b>	13/99901039 700015
<b>description</b>	nozzle holder nozzle mounting M10x1 tube ø 10mm gas inlet M16x1.5 gas outlet M14x1		
<b>accessories for</b>	105426		
	<b>GEV No.</b>	100792	<b>Ref. No.</b> 700416
	gas injector thread M10x1 WS 11 bore ø 1.35mm LPG gas pressure 50mbar		
	<b>GEV No.</b>	100793	<b>Ref. No.</b> 700316
	gas injector thread M10x1 WS 11 bore ø 1.5mm		

<b>accessories for</b>	105426		
	<b>GEV No.</b>	100794	<b>Ref. No.</b> 700016
	gas injector thread M10x1 WS 11 bore ø 2.35mm natural gas gas pressure 20mbar		
	<b>GEV No.</b>	100795	<b>Ref. No.</b> 700116 700216
	gas injector thread M10x1 WS 11 bore ø 2.6mm natural gas gas pressure 20mbar		
	<b>GEV No.</b>	101278	<b>Ref. No.</b> 14/99900049
	olive for pipe ø 10mm Qty 1 pcs		
	<b>GEV No.</b>	101300	<b>Ref. No.</b> 13/10030019 700008
	union nut thread M16x1.5 tube ø 10mm		
	<b>GEV No.</b>	102772	<b>Ref. No.</b> 700116
	gas injector thread M10x1 WS 11 bore ø 2.5mm		
	<b>GEV No.</b>	105423	<b>Ref. No.</b> 04/99900109 04/99900109 + 14/99700021 40/99900109 700020
	round burner C ø 175mm 9.5kW pipe connection ø 31mm		
	<b>GEV No.</b>	105424	<b>Ref. No.</b> 04/99900309 700019
	venturi gas burner		
	<b>GEV No.</b>	105425	<b>Ref. No.</b> 68/50800001 700017
	air mixing sleeve		

## gas nozzles

### main nozzles

gas nozzles M10x1			
			
1			
<b>GEV No.</b>	102867	<b>Ref. No.</b>	770321
<b>description</b>	gas injector thread M10x1 WS 11 bore ø 1.65mm		
			
1			
<b>GEV No.</b>	102868	<b>Ref. No.</b>	770021
<b>description</b>	gas injector thread M10x1 WS 11 bore ø 2.55mm		
			
1			
<b>GEV No.</b>	102869	<b>Ref. No.</b>	770221
<b>description</b>	gas injector thread M10x1 WS 11 bore ø 2.9mm		





			
1			
<b>GEV No.</b>	100792	<b>Ref. No.</b>	700416
<b>description</b>	gas injector thread M10x1 WS 11 bore ø 1.35mm LPG gas pressure 50mbar		

			
1			
<b>GEV No.</b>	102774	<b>Ref. No.</b>	700421
<b>description</b>	gas injector thread M10x1 WS 11 bore ø 1.45mm		

			
1			
<b>GEV No.</b>	100793	<b>Ref. No.</b>	700316
<b>description</b>	gas injector thread M10x1 WS 11 bore ø 1.5mm		

			
1			
<b>GEV No.</b>	102773	<b>Ref. No.</b>	700321
<b>description</b>	gas injector thread M10x1 WS 11 bore ø 1.65mm G20-25		

			
1			
<b>GEV No.</b>	100794	<b>Ref. No.</b>	700016
<b>description</b>	gas injector thread M10x1 WS 11 bore ø 2.35mm natural gas gas pressure 20mbar		

			
1			
<b>GEV No.</b>	102775	<b>Ref. No.</b>	700021
<b>description</b>	gas injector thread M10x1 WS 11 bore ø 2.55mm		

			
1			
<b>GEV No.</b>	102772	<b>Ref. No.</b>	700116
<b>description</b>	gas injector thread M10x1 WS 11 bore ø 2.5mm		

			
1			
<b>GEV No.</b>	102776	<b>Ref. No.</b>	700121
<b>description</b>	gas injector thread M10x1 WS 11 bore ø 2.65mm		

			
1			
<b>GEV No.</b>	100795	<b>Ref. No.</b>	700116 700216
<b>description</b>	gas injector thread M10x1 WS 11 bore ø 2.6mm natural gas gas pressure 20mbar		

			
1			
<b>GEV No.</b>	102777	<b>Ref. No.</b>	700221
<b>description</b>	gas injector thread M10x1 WS 11 bore ø 2.9mm		

### pilot burner nozzles

#### pilot burner nozzles SIT





##### 100 series

			
1			
<b>GEV No.</b>	100245	<b>Ref. No.</b>	700012
<b>description</b>	pilot burner nozzle LPG code 20 bore ø 0.2mm Qty 1 pcs thread M8x0.75		

### auxiliary gas parts



#### screw connections

##### olives

				
1				
<b>GEV No.</b>	101278	<b>Ref. No.</b>	14/99900049	
<b>description</b>	olive for pipe ø 10mm Qty 1 pcs			
<b>accessories for</b>	101278			
	<b>GEV No.</b>	100943	<b>Ref. No.</b>	—
	union nut thread M17x1 tube ø 10mm			
	<b>GEV No.</b>	101300	<b>Ref. No.</b>	13/10030019 700008
	union nut thread M16x1.5 tube ø 10mm			
	<b>GEV No.</b>	101478	<b>Ref. No.</b>	—
	union nut thread 3/8" for pipe ø 10mm			



union nuts

 <p>1</p>			
<b>GEV No.</b>	101300	<b>Ref. No.</b>	13/10030019 700008
<b>description</b>	union nut thread M16x1.5 tube ø 10mm		
<b>accessories for</b>	101300		
 <p>olive for pipe ø 10mm Qty 1 pcs</p>			
<b>GEV No.</b>	101278	<b>Ref. No.</b>	14/99900049

knobs

producer-specific knobs

CASTA

 <p>1</p>			
<b>GEV No.</b>	110081	<b>Ref. No.</b>	700001
<b>description</b>	knob ø 70mm shaft ø 8x6.5mm shaft flat universal		

pullouts

rollers

roller with holder

 <p>1</p>			
<b>GEV No.</b>	692105	<b>Ref. No.</b>	15/99902099
<b>description</b>	roller rollerø 24mm mounting pos. lower		

gaskets

gaskets for heated units

door seals

 <p>1</p>			
<b>GEV No.</b>	900682	<b>Ref. No.</b>	2510685
<b>description</b>	door seal W 250mm L 550mm 3-sided		

measuring equipment

thermometers

built-in thermometers

ø60mm

 <p>1</p>			
<b>GEV No.</b>	541399	<b>Ref. No.</b>	770037
<b>description</b>	thermometer mounting ø 60mm t.max. 350°C 0 up to +350°C probe ø 6.5mm probe L 20mm capillary pipe 1500mm		



**A**

audible timers 4

**C**

cam switches 3

control thermostats 3

**D**

door seals 11

**G**

gas burners 7

gas nozzles 9

gas taps 4

gas thermostats 4

gaskets for heated units 11

**H**

hob burners 7

**I**

ignition cables 6

indicator lights 3

indicator lights (complete) 3

**L**

lamps 3

**M**

measuring equipment 11

**P**

piezoelectric igniters 6

pilot burners 5

**S**

safety thermostats 3

switches and momentary switches 3

**T**

thermocouples 7

thermostats 3

timers 4