



GAS COMPONENTS



ELECTRIC COMPONENTS



WATER TECHNOLOGY



MECHANICAL COMPONENTS



TOOLS

Spare parts suitable for

CAPIC

Find the complete and up-to-date range of products in our GEV Webshop



Manufacturer catalogue

The most important spare parts and accessories arranged clearly for every manufacturer

- ✓ Complete product range and all appliance data always up to date in the GEV Webshop
- ✓ Alphabetical Index at the end of the catalogue

GEV Webshop

www.gev-online.co.uk

www.gev-online.com



- 🔍 Add to Favourites
- 🔍 Sign In with email address and usual password
- 🔍 Easy-order – place several items in your basket at the same time
- 🔍 Quick Item search – no login needed



heating elements

heating elements for ovens



GEV No.	418947	Ref. No.	E150596
description	heating element 1000W 230V heating circuits 1 L 400mm W 90mm thread M12x1 mounting distance 82mm tube ø 8mm connection M4 oven 2 hole fixing dry heating element		



GEV No.	418944	Ref. No.	E150572
description	heating element 1000W 230V L 550mm W 110mm H 75mm L1 257mm L2 35mm 2 hole fixing mounting distance 27mm connection M4 tube ø 8mm heating circuits 1 dry heating element thread M12x1 oven		



GEV No.	418847	Ref. No.	E150855
description	heating element 1500W 230V heating circuits 1 L 450mm W 60mm H 60mm connection distance 45mm tube ø 16mm dry heating element connection with screw connection length 28mm		



GEV No.	418949	Ref. No.	E150846
description	heating element 1500W 230V heating circuits 1 L 580mm W 110mm thread M14x1.25 mounting distance 100mm tube ø 10mm connection M4 oven 2 hole fixing dry heating element		

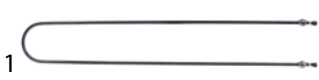

GEV No.	418948	Ref. No.	E150852
description	heating element 1500W 230V heating circuits 1 L 730mm W 110mm thread M12x1 mounting distance 102mm tube ø 8mm connection M4 oven mounting pos. lower 2 hole fixing dry heating element		



GEV No.	418952	Ref. No.	E150866
description	heating element 2000W 230V heating circuits 1 L 1300mm W 65mm thread M14x1 mounting distance 55mm tube ø 10mm connection M5 oven 2 hole fixing dry heating element		



GEV No.	418950	Ref. No.	E150860
description	heating element 2000W 230V heating circuits 1 L 900mm W 115mm thread M14x1.25 mounting distance 105mm tube ø 10mm connection M4 oven 2 hole fixing dry heating element		



GEV No.	418951	Ref. No.	E151107
description	heating element 2250W 230V heating circuits 1 L 700mm W 90mm thread M14x1.25 mounting distance 80mm tube ø 10mm connection M4 oven 2 hole fixing dry heating element		



GEV No.	418953	Ref. No.	E151170
description	heating element 3000W 230V heating circuits 1 L 1295mm W 60mm thread M14x1.25 mounting distance 50mm tube ø 10mm connection M4 oven 2 hole fixing dry heating element		



GEV No.	418954	Ref. No.	E151465
description	heating element 4000W 230V heating circuits 1 L 850mm W 105mm thread M14x1 mounting distance 95mm tube ø 10mm connection M4 oven 2 hole fixing dry heating element		



GEV No.	418943	Ref. No.	E150515
description	heating element 500W 230V heating circuits 1 L 400mm W 110mm L1 45mm L2 355mm W1 31mm W2 40mm flange length 70mm flange width 22mm hole distance 56mm hole ø 6mm tube ø 6.5mm connection M4 connection length 26mm windings 2 rectangular flange dry heating element oven		



GEV No.	418945	Ref. No.	E150514
description	heating element 500W 230V heating circuits 1 L 695mm thread M12x1 tube ø 8mm connection M4 oven 1 hole fixing dry heating element Wmm		





GEV No.	418941	Ref. No.	E150564
description	heating element 850W 220V L 650mm W 148mm L1 100mm L2 545mm W1 55mm W2 38mm bridge length 180mm windings 2 connection plug-in connection heating circuits 1 tube ø 6.5mm flange oven heating element		



GEV No.	418942	Ref. No.	E150556
description	heating element 850W 230V heating circuits 1 L 645mm W 145mm L1 100mm L2 545mm W1 57mm W2 31mm flange length 70mm flange width 22mm hole distance 56mm bridge length 160mm hole ø 6mm tube ø 6.3mm connection M5 connection length 40mm windings 2 rectangular flange dry heating element oven heating element		
For models:	W380151, W380152, W380251, W380351, W380443, W380451, W380541, W380644, W380656, W380741, W380941, W380942, W380944, W380945, W380946, W380947, W380949, W381641, W382551, W382552, W382562, W382651, W382652, W382662, W383041, W383051		



1

GEV No.	550404	Ref. No.	E150565
description	power socket I-II phase 240V max. 16A countries I with screw connection for heating element		
accessories for	550404		
	GEV No.	510408	Ref. No. E153011
	O-ring EPDM thickness 5.34mm ID ø 47mm Qty 1 pcs		
	GEV No.	510562	Ref. No. —
	O-ring silicone thickness 5.34mm ID ø 47mm Qty 1 pcs		

heating elements for bain maries





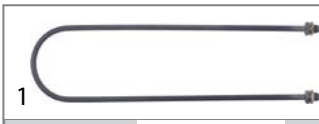

1

GEV No.	420164	Ref. No.	E150570
description	heating element 1000W 230V heating circuits 1 L 483mm W 110mm flange length 160mm flange width 30mm hole distance 139.5mm connection length 38mm connection M5 tube ø 10mm 2 hole flange hole ø 6.5mm dry heating element for bain marie		



1

GEV No.	420165	Ref. No.	E150806
description	heating element 1600W 230V heating circuits 1 L 395mm W 110mm connection length 20mm connection M4 tube ø 8mm 2 hole fixing thread M12x1 immersion heater for bain marie mounting distance 102mm		
For models:	W380811, W380815, W380821, W380825, W380831, W380835		
accessories for	420165		
	GEV No.	520229	Ref. No. —
	nut thread M12x1 H 4mm WS 16 zinc-coated steel Qty 1 pcs		
	GEV No.	521110	Ref. No. —
	flat gasket fibre ED ø 20mm ID ø 13mm thickness 2mm Qty 1 pcs		
	GEV No.	521131	Ref. No. —
	nut thread M12x1 H 3.5mm WS 17 SS Qty 1 pcs		



1

GEV No.	418844	Ref. No.	E150540
description	heating element 700W 230V heating circuits 1 L 395mm W 105mm flange length 70mm flange width 22mm hole distance 56mm connection with screw tube ø 6.25mm rectangular flange hole ø 6mm dry heating element L1 35mm L2 360mm W1 31mm W2 36mm		



1

GEV No.	420163	Ref. No.	E150544
description	heating element 750W 230V heating circuits 1 L 482mm W 110mm flange length 160mm flange width 30mm hole distance 139.5mm connection length 37mm connection M5 tube ø 10mm 2 hole flange hole ø 6.5mm dry heating element for bain marie		

heating elements for frying pans

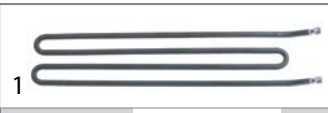

1

GEV No.	418939	Ref. No.	E151112
description	heating element 2500W 230V heating circuits 1 L 575mm W 115mm connection M5 tube ø 12.8mm dry heating element L1 30mm L2 545mm H 30mm connection distance 102mm		



1

GEV No.	418940	Ref. No.	E151455
description	heating element 3500W 230V heating circuits 1 L 515mm W 150mm connection M5 tube ø 13.5mm dry heating element L1 35mm L2 480mm H 36mm connection distance 117mm		

heating elements for chip scuttles



1

GEV No.	420162	Ref. No.	E150510
description	heating element 500W 230V heating circuits 1 L 442mm Wmm connection length 16mm connection male faston 6.3mm tube ø 10mm 1 hole fixing thread M14x1 dry heating element		
For models:	W382211, W382221, W382231		

heating elements for fryers



1

GEV No.	420495	Ref. No.	E152060
description	heating element 10000W 230V heating circuits 1 L 405mm W 142mm H 265mm threaded connection cable hole distance 67mm hole ø 5mm flange length 80mm flange width 40mm cable length 270mm		
For models:	W381031, W382031, W382032		



2 hole fixing

GEV No.	418957	Ref. No.	E152009
description	heating element 4000W 230V heating circuits 1 L 475mm W 80mm H 280mm M11x1 connection male faston fryer heaters L1 60mm L2 55mm L3 360mm H1 40mm H2 200mm H3 40mm tube ø 6.5mm thread M12x1 mounting distance 54mm connection length 30mm windings 4		

GEV No.	418958	Ref. No.	E152050
description	heating element 8000W 220V heating circuits 3 L 490mm W 230mm H 270mm L1 135mm L2 355mm W1 82mm W2 65mm H1 70mm H2 200mm special fixing tube ø 10mm connection M4 fryer heaters		

heating elements for griddles

GEV No.	490196	Ref. No.	E154046
description	griddle 5000W 400V L 620mm W 305mm		
For models:	W380911, W380921, W380931, W380941		

GEV No.	418960	Ref. No.	E150587
description	heating element 1000W 230V heating circuits 1 L 750mm W 110mm Hmm tube ø 8mm connection M4 thread M12x1 mounting distance 102mm dry heating element		

GEV No.	418845	Ref. No.	E150840
description	heating element 1500W 230V heating circuits 1 L 480mm W 70mm Hmm connection length 15mm connection screw tube ø 6.3mm 2 hole fixing thread M10x1 dry heating element mounting distance 64mm		
For models:	W380141, W380142, W380241, W380341, W380441, W380646, W381541, W381545, W383043		

GEV No.	420493	Ref. No.	E1511885
description	heating element 2850W 230V heating circuits 1 L 115mm W 490mm H 85mm tube ø 13.5mm		

GEV No.	418937	Ref. No.	E151138
description	heating element 3000W 230V heating circuits 1 L 430mm W 320mm H 58mm tube ø 13.5mm W1 82mm W2 156mm connection M5 grill connection distance 125mm dry heating element		

heating elements for tilting bratt pan

GEV No.	420494	Ref. No.	E150813
description	heating element 1400W 230V 50Hz L 330mm W 135mm H 85mm suitable for CAPIC heating circuits 1		

GEV No.	418938	Ref. No.	E151125
description	heating element 2500W 230V L 520mm W 110mm H 35mm connection M5 dry heating element heating circuits 1 tube ø 13.5mm L1 40mm L2 480mm connection distance 67mm		

GEV No.	420167	Ref. No.	E151135
description	heating element 3000W 230V L 425mm W 190mm H 30mm connection M5 dry heating element heating circuits 1 tube ø 13mm L1 40mm L2 385mm connection length 13mm connection distance 177mm		

heating elements for heated cabinets

GEV No.	418845	Ref. No.	E150840
description	heating element 1500W 230V heating circuits 1 L 480mm W 70mm Hmm connection length 15mm connection screw tube ø 6.3mm 2 hole fixing thread M10x1 dry heating element mounting distance 64mm		
For models:	W380141, W380142, W380241, W380341, W380441, W380646, W381541, W381545, W383043		



			
GEV No.	418946	Ref. No.	E150532
description	heating element 700W 230V heating circuits 1 L 745mm W 110mm connection length 35mm connection M4 tube ø 8mm 2 hole fixing thread M12x1 dry heating element heated cabinet mounting distance 102mm		
For models:	W380648, W383045		

heater battery

			
GEV No.	415122	Ref. No.	E254001
description	heater battery mounting distance 185mm W 40mm H 35mm 2000W 230V temperature restriction 105°C heating circuits 2 connection cable cable length 340mm L 197mm for cross flow fan		

contact heaters



			
GEV No.	416237	Ref. No.	L201017
description	contact heater 1400W 230V heating circuits 1 L 133mm W 120mm H 10mm dishwasher connection soldering connection connection distance 76mm connection length 37mm heat-conducting paste included hole ø 7mm dry heating element		



quartz heating elements

			
GEV No.	420168	Ref. No.	E302112
description	quartz tube WV L 458mm ID ø 9mm ED ø 11mm		

immersion heating elements







3 hole flange ø57.5mm

				
GEV No.	415035	Ref. No.	L201005	
description	heating element 3000W 230V mounting ø 57.5mm heating circuits 3 L 207mm W 40mm H 46mm number of thermostat sleeves 1 thermostat sleeves ø 7.5mm length thermostat sleeves 185mm thermostat sleeve eccentric, non clinging tube ø 8.5mm hole distance 73mm hole ø 8mm connection M4 3 hole flange immersion heater			
accessories for	415035			
	GEV No.	521103	Ref. No.	—
nut thread M4 H 3mm WS 7 brass Qty 20 pcs				



accessories for	415035			
	GEV No.	521104	Ref. No.	—
washer ID ø 4.3mm ED ø 8mm thickness 0.5mm brass Qty 20 pcs for thread M4				
	GEV No.	560111	Ref. No.	—
plain washer ID ø 4.3mm ED ø 9mm thickness 0.8mm SS Qty 20 pcs DIN 125A for thread M4				
	GEV No.	560131	Ref. No.	—
hexagonal nut thread M4 H 3.2mm WS 7 SS DIN/ISO DIN 934 / ISO 4032/8673 Qty 20 pcs				

			
GEV No.	415846	Ref. No.	L202015
description	heating element 4000W 230V mounting ø 57.5mm heating circuits 3 L 327mm W 36mm H 42mm number of thermostat sleeves 1 thermostat sleeves ø 7mm length thermostat sleeves 320mm thermostat sleeve eccentric, non clinging tube ø 6.3mm hole distance 72mm hole ø 8mm connection M4 3 hole flange immersion heater		



with compression flange 50 x 26mm

				
GEV No.	415151	Ref. No.	L201035	
description	heating element 2500W 230V compression flange flange 50x26mm L 273mm heating circuits 1 H 30mm W 130mm L1 144mm L2 129mm connection M4 immersion heater			
accessories for	415151			
	GEV No.	510387	Ref. No.	—
gasket L 46mm W 22mm ømm EPDM for heating element for flange 50x26mm				
	GEV No.	510388	Ref. No.	—
counterflange ømm hole distancemm perforation ømm L 43mm W 21mm SS for heating element for flange 50x26mm				
	GEV No.	521103	Ref. No.	—
nut thread M4 H 3mm WS 7 brass Qty 20 pcs				
	GEV No.	521104	Ref. No.	—
washer ID ø 4.3mm ED ø 8mm thickness 0.5mm brass Qty 20 pcs for thread M4				
	GEV No.	560111	Ref. No.	—
plain washer ID ø 4.3mm ED ø 9mm thickness 0.8mm SS Qty 20 pcs DIN 125A for thread M4				
	GEV No.	560131	Ref. No.	—
hexagonal nut thread M4 H 3.2mm WS 7 SS DIN/ISO DIN 934 / ISO 4032/8673 Qty 20 pcs				





with expansion flange 40 x 14mm			
			
			
GEV No.	415154	Ref. No.	L201030
description	heating element 2500W 230V flange 40x14mm L 455mm W 37mm Hmm tube ø 8.5mm heating circuits 1 connection male faston 6.3mm immersion heater		

with expansion flange 70 x 18mm			
			
GEV No.	415159	Ref. No.	L201045
description	heating element 2500W 230V heating circuits 2 flange 70x18mm L 285mm W 65mm Hmm connection male faston 6.3mm tube ø 8.5mm immersion heater expansion flange		

with round flange ø47.5mm							
							
GEV No.	418846	Ref. No.	E153010 E153010+E153011				
description	heating element 4500W 230V heating circuits 3 L 395mm W 37mm H 30mm tube ø 6.5mm connection male faston 6.3mm connection length 25mm immersion heater round flange mounting ø 47.5mm						
For models:	W384111, W384112						
accessories for	418846						
		<table border="1"> <tr> <td>GEV No.</td> <td>510408</td> <td>Ref. No.</td> <td>E153011</td> </tr> </table>	GEV No.	510408	Ref. No.	E153011	O-ring EPDM thickness 5.34mm ID ø 47mm Qty 1 pcs
GEV No.	510408	Ref. No.	E153011				



with round flange ø57.5mm							
							
GEV No.	415038	Ref. No.	L202022				
description	heating element 5000W 230V heating circuits 3 mounting ø 57.5mm L 373mm W 44mm H 40mm round flange connection M4 immersion heater tube ø 6.3mm connection length 19mm thermostat sleeves ø 7mm number of thermostat sleeves 1 length thermostat sleeves 328mm thermostat sleeve not clinging						
spare parts for	415038						
		<table border="1"> <tr> <td>GEV No.</td> <td>510409</td> <td>Ref. No.</td> <td>L554120</td> </tr> </table>	GEV No.	510409	Ref. No.	L554120	O-ring EPDM thickness 5.34mm ID ø 56.52mm Qty 1 pcs
GEV No.	510409	Ref. No.	L554120				
accessories for	415038						
		<table border="1"> <tr> <td>GEV No.</td> <td>521103</td> <td>Ref. No.</td> <td>—</td> </tr> </table>	GEV No.	521103	Ref. No.	—	nut thread M4 H 3mm WS 7 brass Qty 20 pcs
GEV No.	521103	Ref. No.	—				
		<table border="1"> <tr> <td>GEV No.</td> <td>521104</td> <td>Ref. No.</td> <td>—</td> </tr> </table>	GEV No.	521104	Ref. No.	—	washer ID ø 4.3mm ED ø 8mm thickness 0.5mm brass Qty 20 pcs for thread M4
GEV No.	521104	Ref. No.	—				
		<table border="1"> <tr> <td>GEV No.</td> <td>550002</td> <td>Ref. No.</td> <td>—</td> </tr> </table>	GEV No.	550002	Ref. No.	—	tension strap H 10mm L 21mm W 10mm hole ø 6.5mm for heating element
GEV No.	550002	Ref. No.	—				

accessories for	415038						
		<table border="1"> <tr> <td>GEV No.</td> <td>560111</td> <td>Ref. No.</td> <td>—</td> </tr> </table>	GEV No.	560111	Ref. No.	—	plain washer ID ø 4.3mm ED ø 9mm thickness 0.8mm SS Qty 20 pcs DIN 125A for thread M4
GEV No.	560111	Ref. No.	—				
		<table border="1"> <tr> <td>GEV No.</td> <td>560131</td> <td>Ref. No.</td> <td>—</td> </tr> </table>	GEV No.	560131	Ref. No.	—	hexagonal nut thread M4 H 3.2mm WS 7 SS DIN/ISO DIN 934 / ISO 4032/8673 Qty 20 pcs
GEV No.	560131	Ref. No.	—				

			
GEV No.	420166	Ref. No.	E150818
description	heating element 1500W 230V heating circuits 1 L 480mm W 105mm thread M12x1 mounting distance 97mm tube ø 8mm connection length 16mm 2 hole fixing immersion heater connection M5		

			
GEV No.	415156	Ref. No.	L201050
description	heating element 2500W 230V heating circuits 1 L 255mm W 42mm H 25mm L1 7mm L2 18mm L3 229mm thread M10x1 mounting distance 36mm tube ø 6.3mm connection male faston 6.3mm 2 hole fixing immersion heater		

spare parts for	415156						
		<table border="1"> <tr> <td>GEV No.</td> <td>510893</td> <td>Ref. No.</td> <td>—</td> </tr> </table>	GEV No.	510893	Ref. No.	—	O-ring EPDM thickness 2.62mm ID ø 9.92mm Qty 1 pcs
GEV No.	510893	Ref. No.	—				

accessories for	415156						
		<table border="1"> <tr> <td>GEV No.</td> <td>510416</td> <td>Ref. No.</td> <td>—</td> </tr> </table>	GEV No.	510416	Ref. No.	—	flat gasket fibre ED ø 19mm ID ø 10.5mm thickness 1.5mm for thread M10 Qty 1 pcs
GEV No.	510416	Ref. No.	—				
		<table border="1"> <tr> <td>GEV No.</td> <td>520231</td> <td>Ref. No.</td> <td>—</td> </tr> </table>	GEV No.	520231	Ref. No.	—	nut thread M10x1 H 6mm WS 14 zinc-coated steel Qty 1 pcs
GEV No.	520231	Ref. No.	—				
		<table border="1"> <tr> <td>GEV No.</td> <td>521129</td> <td>Ref. No.</td> <td>—</td> </tr> </table>	GEV No.	521129	Ref. No.	—	nut thread M10 H 6mm SS WS 17 Qty 1 pcs DIN/ISO DIN 439
GEV No.	521129	Ref. No.	—				

heating elements for convection

			
GEV No.	418848	Ref. No.	E150848 E150850
description	heating element 1500W 230V heating circuits 1 L 335mm W 100mm thread M12x1 connection with screw mounting distance 328mm tube ø 8.5mm convection heating element		



			
1			
GEV No.	418956	Ref. No.	E151131
description	heating element 2700W 230V heating circuits 1 L 410mm W 130mm H 102mm H1 42mm H2 60mm thread M20x1.5 connection length 87mm connection M5 2 hole fixing tube ø 13.5mm convection heating element convection oven		

			
1			
GEV No.	418955	Ref. No.	E150824
description	heating element 1500W 230V heating circuits 1 L 393mm W 70mm connection length 28mm connection M4 tube ø 8mm thread M12x1 2 hole fixing convection heating element convection oven mounting distance 62mm		

hot plates

square & rectangular

with cast edge

with screw connection

			
1			
GEV No.	490078	Ref. No.	E154016
description	hot plate dimensions 300x300mm 3000W 400V with cast edge connection 4 screw clamps square		
For models:	W380311, W380321, W380331, W380341, W380351, W380711, W380721, W380731, W380741		

tiltable

			
1			
GEV No.	490206	Ref. No.	E154011
description	hot plate dimensions 300x300mm 3000W 400V connection 3 screw clamps foldable		

round

with radiused edge

for domestic and commercial kitchens

			
1			
GEV No.	490061	Ref. No.	E154020
description	hot plate ø 300mm 2500W 230V connection 4 screw clamps with 8mm spill ring		

			
1			
GEV No.	490064	Ref. No.	E154021
description	hot plate ø 300mm 3500W 400V with 8mm spill ring		

energy regulators

EGO

1-circuit

			
1			
GEV No.	380019	Ref. No.	E402540
description	energy regulator 240V 13A single-circuit turn direction right shaft ø 6x4.6mm shaft L 23mm mounting thread M4 power release 6-100% no. 50.57071.010		

			
1			
GEV No.	380013	Ref. No.	E402545
description	energy regulator 400V 7A single-circuit turn direction right shaft ø 6x4.6mm mounting thread M4 no. 50.57031.010		
For models:	W384012, W384111, W384112		



DIAMOND



1

GEV No.	380037	Ref. No.	E402516
description	energy regulator 240V 13.5A turn direction right shaft ø 6x4.6mm shaft L 13mm mounting thread 3/8"-24UNF equiv. no. 35ERE101230V		



1

GEV No.	380038	Ref. No.	E402504
description	energy regulator 24V 13.5A turn direction right shaft ø 6x4.6mm mounting thread 3/8"-24UNF equiv. no. 35ERE105024V voltage AC		



1

GEV No.	380039	Ref. No.	E402520	
description	energy regulator 400V 13.5A turn direction right shaft ø 6x4.6mm mounting thread 3/8"-24UNF equiv. no. 35ERE104400V			
accessories for	380039			
	GEV No.	361181	Ref. No.	—
	nut thread 1/8" H 4.5mm nickel-plated brass WS 14 Qty 1 pcs			

thermostats

control and safety thermostats

EGO

control thermostats

55.10/19_series



1

GEV No.	375468	Ref. No.	E401075
description	thermostat t.max. 180°C temperature range 80-180°C 1-pole 1NO 16A probe ø 6mm probe L 135mm capillary pipe 900mm capillary pipe isolatedmm gland nut M9x1 shaft ø 6x4.6mm shaft L 23mm shaft position upper rotation 270°		



1

GEV No.	375664	Ref. No.	E401082
description	thermostat t.max. 287°C temperature range 60-287°C 1-pole 1NO 16A probe ø 3.1mm probe L 226mm capillary pipe 1470mm capillary pipe isolated 350mm gland nut shaft ø 6x4.6mm shaft L 23mm shaft position upper rotation 270°		
For models:	W385013, W385015		

55.13_series



1

GEV No.	390995	Ref. No.	E401077
description	thermostat t.max. 120°C temperature range 30-120°C 1-pole 1NO 16A probe ø 6mm probe L 95mm capillary pipe 900mm capillary pipe isolatedmm gland nut M9x1 shaft ø 6x4.6mm shaft L 23mm shaft position upper rotation 270°		

55.34_series



1

GEV No.	375143	Ref. No.	E401015
description	thermostat t.max. 110°C temperature range 32-110°C 3-pole 3NO 16A probe ø 6mm probe L 138mm capillary pipe 1480mm capillary pipe isolated 1100mm gland nut M9x1 shaft ø 6x4.6mm shaft L 23mm shaft position upper rotation 270°		
For models:	W380811, W380815, W380821, W380825, W380831, W380835, W381131, W381132		



GEV No.	375043	Ref. No.	E401045
description	thermostat t.max. 200°C temperature range 65-200°C 3-pole 3NO 16A probe ø 6mm probe L 77mm capillary pipe 880mm capillary pipe isolated 800mm gland nut M9x1 shaft ø 6x4.6mm shaft L 23mm shaft position upper rotation 270°		



GEV No.	375417	Ref. No.	N/A
description	thermostat t.max. 200°C temperature range 65-200°C 3-pole 3NO 16A probe ø 6mm probe L 79mm capillary pipe 840mm capillary pipe isolated gland nut M9x1 shaft ø 6x4.6mm shaft L 23mm rotation 270°		



GEV No.	375038	Ref. No.	E401060	
description	thermostat t.max. 300°C temperature range 50-300°C 3-pole 3NO 16A probe ø 6mm probe L 79mm capillary pipe 1740mm capillary pipe isolated 800mm gland nut shaft ø 6x4.6mm shaft L 23mm shaft position upper rotation 270°			
accessories for	375038			
	GEV No.	110123	Ref. No.	E401280
	knob thermostat t.max. 300°C ø 50mm shaft ø 6x4.6mm shaft flat upper black temperature range 50-300°C rotation 270°			



GEV No.	375019	Ref. No.	E401011
description	thermostat t.max. 85°C temperature range 30-85°C 3-pole 3NO 16A probe ø 6mm probe L 131mm capillary pipe 1440mm capillary pipe isolated gland nut M9x1 shaft ø 6x4.6mm shaft L 23mm shaft position upper rotation 270°		
For models:	W380141, W380142, W380241, W380341, W380441, W380443, W380541, W380644, W380646, W380648, W380741, W380941, W380942, W380944, W380945, W380946, W380947, W380949, W381541, W381545, W381641, W382552, W382562, W382652, W382662, W383041, W383043, W383045		

safety thermostats

55.11_ series



GEV No.	375109	Ref. No.	E401002
description	safety thermostat switch-off temp. 240°C 1-pole 16A probe ø 4mm probe L 91mm capillary pipe 530mm capillary pipe isolated 350mm gland nut probe SS		

55.13_ series



GEV No.	375981	Ref. No.	E401007
description	safety thermostat switch-off temp. 225°C 1-pole 16A probe ø 6mm probe L 88mm capillary pipe 900mm capillary pipe isolated gland nut probe connection male faston 6.3mm		



GEV No.	375830	Ref. No.	E401003
description	safety thermostat switch-off temp. 365°C 1-pole 1NC 16A probe ø 3mm probe L 160mm capillary pipe 1730mm capillary pipe isolated 1710mm gland nut probe		

55.32_series



GEV No.	375980	Ref. No.	E401008 E401012
description	safety thermostat switch-off temp. 130°C 3-pole 20A probe ø 6mm probe L 88mm capillary pipe 880mm capillary pipe isolatedmm gland nut probe		
For models:	W384111, W384112, W384121, W384122		



GEV No.	375706	Ref. No.	E401090
description	safety thermostat switch-off temp. 400°C 3-pole 3NC 20A probe ø 3.9mm probe L 228mm capillary pipe 1190mm capillary pipe isolatedmm gland nut probe SS		
For models:	W380151, W380152, W380251, W380351, W380451, W380656, W382551, W382552, W382651, W382652, W383051, W385011, W385012, W385013, W385014, W385015		

55.33_series



GEV No.	375467	Ref. No.	E401006
description	safety thermostat switch-off temp. 220°C 3-pole 3NC 20A probe ø 6mm probe L 75mm capillary pipe 1500mm capillary pipe isolatedmm gland nut M9x1 probe SS		
For models:	W381031, W381035, W382031, W382032		

control thermostats with operation switch

55.34_series





GEV No.	375246	Ref. No.	E401084
description	thermostat t.max. 645°C temperature range 100-615/645°C 2-pole 2NO 16A probe ø 4mm probe L 230mm capillary pipe 1100mm capillary pipe isolated 600mm gland nut shaft ø 6x4.6mm shaft L 25mm shaft position lower rotation 270° outer switch 2NO probe material copper		

IMIT / TEMPOMATIC / ARTHERMO

control thermostats



GEV No.	390310	Ref. No.	L455065	
description	thermostat t.max. 85°C temperature range fixed 55°C 1-pole 1CO 16A probe ø 9.5mm probe L 37mm capillary pipe 600mm capillary pipe isolated 540mm gland nut shaft ømm shaft Lmm shaft position rotation° screw-in probe probe thread 3/8" probe material SS			
accessories for	390310			
	GEV No.	506024	Ref. No.	—
	nut thread 3/8" H 6mm SS WS 22 Qty 1 pcs			
	GEV No.	529349	Ref. No.	—
	flat gasket FIBER ED ø 22mm ID ø 16.5mm thickness 2mm for thread 3/8" Qty 1 pcs			



PRODIGY / FIRT

safety thermostats

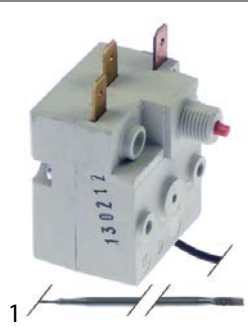

GEV No.	375478	Ref. No.	L454815
description	safety thermostat switch-off temp. 200°C temperature range°C 1-pole 1CO 20A probe ø 3.3mm probe L 190mm capillary pipe 2150mm capillary pipe isolatedmm gland nut probe SS		

accessories

gland nut accessories

ducts



GEV No.	550148	Ref. No.	E401310
description	gland duct ET M12x0.75 IT M9x1 probe ø max. 6.5mm WS 17 silicone		



GEV No.	100820	Ref. No.	G652208
description	gland duct ET M14x1.5 IT M10x0.75 probe ø max. 6.5mm WS 22		

connecting bows



GEV No.	550060	Ref. No.	E401320
description	connecting bow long for thermostat Qty 1 pcs		

switches and momentary switches

rocker/momentary rocker switches

19x13mm



GEV No.	348167	Ref. No.	E053530
description	rocker switch mounting measurements 19x13mm orange 2NO 250V 13A illuminated connection male faston 4.8mm protection IP40		
For models:	W381131, W381132, W381511, W381521, W381531, W381541, W381711, W381721, W381731		



GEV No.	346541	Ref. No.	E053532
description	protective cover for rocker switch external size 23.4x17.4mm internal size 19x13mm H 9.5mm mounting measurementsmm		
For models:	W381131, W381132, W381511, W381521, W381531, W381541, W381711, W381721, W381731		

push/momentary push switches

ø12mm



GEV No.	347567	Ref. No.	E053052
description	momentary push switch mounting ø 12mm white 1NO 250V 4A connection male faston 6.3mm ambient temperature max. 85°C protection IP40		
For models:	W381132		

microswitches

universal



GEV No.	348043	Ref. No.	E053005
description	microswitch with plunger 250V 16A 1CO connection male faston 6.3mm Lmm L1 27.8mm ambient temperature max. 125°C mounting distance 22mm with lever set type MS1-16 actuating force: 100g white		

pin-plunger actuated

M12



GEV No.	347586	Ref. No.	E053040
description	position switch with plunger mounting distance 81mm thread M12x1 thread L 66mm 400V 20A 1CO connection screw stroke 8mm L 50mm ambient temperature max. 85°C actuating force: 500g H 75mm W 18mm		



system switches (ROLD)

1 

GEV No.	345606	Ref. No.	L451243
description	momentary switch unit 2CO 250V 16A connection male faston 6.3mm		

1 

GEV No.	345651	Ref. No.	L451247
description	switch 2CO 250V 16A connection male faston 6.3mm		

cam switches

on/off

1 

GEV No.	300021	Ref. No.	E052505
description	cam switch 4 operating positions 4NO sequence 0-1-0-1 16A shaft ø 6x4.6mm shaft L 23mm connection screw ceramic		

1 

GEV No.	300248	Ref. No.	E052510
description	cam switch ON-OFF 16A shaft ø 6x4.6mm connection screw clamp 3-pole		
For models:	W380811, W380815, W380821, W380825, W380831, W380835		

4-position

1 

GEV No.	300103	Ref. No.	E052520
description	cam switch 4 operating positions 1NO/2CO sequence 0-1-2-3 32A shaft ø 6x4.6mm shaft L 23mm connection screw ceramic		
For models:	W380311, W380321, W380331, W380341, W380351, W380711, W380721, W380731, W380741, W380911, W380921, W380931, W380941		

1 

GEV No.	300104	Ref. No.	E052530
description	cam switch 4 operating positions 3NO/1CO sequence 0-1-2-3 32A shaft ø 6x4.6mm shaft L 23mm connection screw ceramic		
For models:	W380914, W380918, W380924, W380928, W380934, W380938, W380944, W381511, W381521, W381531, W381541		

4 operating positions

1 

GEV No.	347756	Ref. No.	E052525
description	cam switch 4 operating positions 2NO/1CO sequence 0-1-2-3 32A shaft ø 6x6mm shaft L 23mm connection screw ceramic		

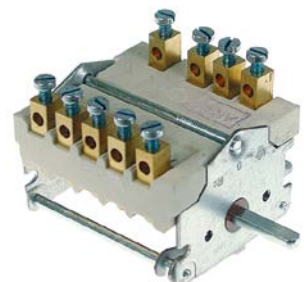
1 

GEV No.	300360	Ref. No.	E052523
description	cam switch 4 operating positions 3NO/1CO sequence 0-1-2-3 32A shaft ø 6x4.6mm shaft L 23mm connection screw ceramic		
For models:	W380151, W380152, W380251, W380351, W380451, W380656, W382551, W382552, W382651, W382652, W383051		



5 operating positions

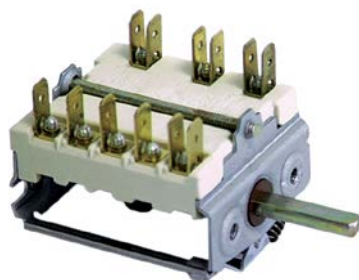

1			
GEV No.	301221	Ref. No.	E052535
description	cam switch 5 operating positions 2NO/1CO sequence 0-4-3-2-1 16A shaft \varnothing 6x4.6mm shaft L 23mm connection male faston 6.3mm ceramic		

operation switches



1			
GEV No.	300200	Ref. No.	E052584
description	operation switch 2 operating positions 2NO 16A sequence 0-1 shaft \varnothing 6x4.6mm shaft L 23mm connection male faston 6.3mm operation switch ceramic		

magnetic switches

23x14mm



1			
GEV No.	348169	Ref. No.	E054075
description	magnetic switch L 23mm W 14mm 1NO 100V 0.5A P max. 12W connection cable length 1000mm		
For models:	W385011, W385012, W385013, W385014, W385015, W385021, W385022, W385023, W385024, W385025		

51x16mm



1			
GEV No.	348168	Ref. No.	E054006
description	magnetic switch L 51mm W 16mm 1NO 240V 2A P max. 12W cable length 350mm		
For models:	W381031, W381131, W381132, W382031, W382032		

accessories

magnets

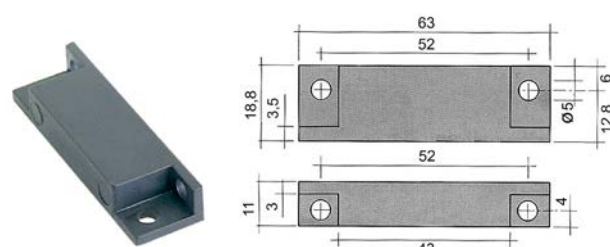

1			
GEV No.	345336	Ref. No.	L453222
description	magnet \varnothing 4.8mm L 63mm H 11mm W 18.8mm hole distance 51mm M4		

control equipment

SCHNEIDER ELECTRIC





push buttons



1			
GEV No.	347809	Ref. No.	E052710 E052772
description	push button mounting measurements \varnothing 22mm with protecting cover black		
For models:	W380111, W380112, W380121, W380122, W380131, W380132, W380141, W380142, W380151, W380152, W380161, W380162, W380211, W380221, W380231, W380241, W380251, W380261, W380411, W380413, W380421, W380423, W380431, W380433, W380441, W380443, W380451, W380461, W380511, W380521, W380531, W380541, W380666, W380912, W380915, W380917, W380919, W380922, W380925, W380927, W380929, W380932, W380935, W380937, W380939, W380942, W380945, W380947, W380949, W381515...(Other models you can see in the webshop)		







 <p>1</p>			
GEV No.	347808	Ref. No.	E052613 E052684
description	contact block TELEMECANIQUE ZB4BZ103 2NO max 600V 3A black with holder		
For models:	W380111, W380112, W380121, W380122, W380131, W380132, W380141, W380142, W380151, W380152, W380161, W380162, W380211, W380221, W380231, W380241, W380251, W380261, W380411, W380413, W380421, W380423, W380431, W380433, W380441, W380443, W380451, W380461, W380511, W380521, W380531, W380541, W380666, W380912, W380915, W380917, W380919, W380922, W380925, W380927, W380929, W380932, W380935, W380937, W380939, W380942, W380945, W380947, W380949, W381132...(Other models you can see in the webshop)		

accessories for	359600		
	GEV No.	359064	Ref. No. —
lamp socket mounting measurements ø22.3mm socket E14 connection screw 250/380V ambient temperature at 1W 100°C ambient temperature at 2W 85°C			
	GEV No.	359685	Ref. No. —
lamp socket mounting measurements ø16.2mm socket E10			
	GEV No.	359832	Ref. No. —
lamp socket mounting measurements ø16.2mm socket Ba9s connection male faston 6.3mm			
	GEV No.	359853	Ref. No. —
lamp socket mounting measurements ø18.2mm socket Ba9s connection male faston 6.3mm			
	GEV No.	359988	Ref. No. —
lamp socket mounting measurements ø30.5mm 250V connection F6.3 temp.-resist. 55°C E14			

TELEMECANIQUE (EFA)			
XB2 series			
signal element			
 <p>1</p>			
GEV No.	345397	Ref. No.	E202042
description	signal element mounting measurements ø22mm red		

 <p>1</p>			
GEV No.	359601	Ref. No.	E201007
description	neon light bulb socket E10 380V clear ø 10mm L 28mm glas		
accessories for	359601		
	GEV No.	359060	Ref. No. —
lamp socket mounting measurements ø16.2mm socket E10 connection screw			
	GEV No.	359063	Ref. No. —
lamp socket mounting measurements ø19.2mm socket E14 connection screw			
	GEV No.	359064	Ref. No. —
lamp socket mounting measurements ø22.3mm socket E14 connection screw 250/380V ambient temperature at 1W 100°C ambient temperature at 2W 85°C			
	GEV No.	359685	Ref. No. —
lamp socket mounting measurements ø16.2mm socket E10			
	GEV No.	359832	Ref. No. —
lamp socket mounting measurements ø16.2mm socket Ba9s connection male faston 6.3mm			
	GEV No.	359853	Ref. No. —
lamp socket mounting measurements ø18.2mm socket Ba9s connection male faston 6.3mm			
	GEV No.	359988	Ref. No. —
lamp socket mounting measurements ø30.5mm 250V connection F6.3 temp.-resist. 55°C E14			

lamps			
indicator lights			
indicator lights 2-piece (lens and indicator lamp)			
indicator lamps for socket type SRZ / SDK / SDY / SFK			
 <p>1</p>			
GEV No.	359130	Ref. No.	L452515
description	indicator lamp 230V clear connection male faston 6.3mm ø 8mm		

indicator lights 3-piece (housing, lens and bulb)			
lamps			
neon light bulbs			
 <p>1</p>			
GEV No.	359600	Ref. No.	E201005
description	neon light bulb socket E10 220V 0.35W clear ø 10mm L 28mm		
accessories for	359600		
	GEV No.	359060	Ref. No. —
lamp socket mounting measurements ø16.2mm socket E10 connection screw			
	GEV No.	359063	Ref. No. —
lamp socket mounting measurements ø19.2mm socket E14 connection screw			

indicator lights (complete)			
ø 6mm			
 <p>1</p>			
GEV No.	359038	Ref. No.	L452522
description	indicator light ø 6mm 230V red		

ø 9mm			
			
1			
GEV No.	360698	Ref. No.	E202092
description	indicator light ø 9mm yellow 380-400V connection 2-wire cable length 200mm temp.-resist.°C		

ø10mm			
with plug-in socket			
			
1			
GEV No.	359139	Ref. No.	E202025
description	indicator light ø 10mm green 230V connection male faston 6.3mm Qty 1 pcs		

			
1			
GEV No.	359019	Ref. No.	E202028
description	indicator light ø 10mm green 400V connection male faston 6.3mm Qty 1 pcs		

			
1			
GEV No.	359140	Ref. No.	E202026
description	indicator light ø 10mm yellow 230V connection male faston 6.3mm Qty 1 pcs		









			
1			
GEV No.	359034	Ref. No.	E202029
description	indicator light ø 10mm yellow 400V connection male faston 6.3mm Qty 1 pcs		

ø12mm			
with screw socket			
			
1			
GEV No.	359893	Ref. No.	E202094
description	indicator light ø 12mm 400V green connection cable 200mm		
For models:	W380141, W380142, W380241, W380341, W380441, W380443, W380541, W380644, W380646, W380648, W380741, W380941, W380942, W380944, W380945, W380946, W380947, W380949, W381131, W381132, W381511, W381521, W381531, W381541, W381545, W381641, W381811, W381821, W381831, W382552, W382562, W382652, W382662, W383041, W383043, W383045, W384111, W384112, W384121, W384122, W385011, W385012, W385013, W385014, W385015, W385021, W385022, W385023, W385024, W385025		

			
1			
GEV No.	357157	Ref. No.	E202098
description	indicator light ø 12mm 380V yellow connection cable cable length 200mm		
For models:	W380311, W380321, W380331, W380341, W380351, W380711, W380721, W380731, W380741, W380815, W380825, W380835, W381611, W381621, W381631, W381641, W381711, W381721, W381731, W384012, W384111, W384112		

screw-on/push-on fit

neon light bulbs

				
1				
GEV No.	359600	Ref. No.	E201005	
description	neon light bulb socket E10 220V 0.35W clear ø 10mm L 28mm			
accessories for	359600			
	GEV No.	359060	Ref. No.	—
lamp socket mounting measurements ø16.2mm socket E10 connection screw				
	GEV No.	359063	Ref. No.	—
lamp socket mounting measurements ø19.2mm socket E14 connection screw				
	GEV No.	359064	Ref. No.	—
lamp socket mounting measurements ø22.3mm socket E14 connection screw 250/380V ambient temperature at 1W 100°C ambient temperature at 2W 85°C				
	GEV No.	359685	Ref. No.	—
lamp socket mounting measurements ø16.2mm socket E10				
	GEV No.	359832	Ref. No.	—
lamp socket mounting measurements ø16.2mm socket Ba9s connection male faston 6.3mm				
	GEV No.	359853	Ref. No.	—
lamp socket mounting measurements ø18.2mm socket Ba9s connection male faston 6.3mm				
	GEV No.	359988	Ref. No.	—
lamp socket mounting measurements ø30.5mm 250V connection F6.3 temp.-resist. 55°C E14				





				
1				
GEV No.	359601	Ref. No.	E201007	
description	neon light bulb socket E10 380V clear ø 10mm L 28mm glas			
accessories for	359601			
	GEV No.	359060	Ref. No.	—
lamp socket mounting measurements ø16.2mm socket E10 connection screw				
	GEV No.	359063	Ref. No.	—
lamp socket mounting measurements ø19.2mm socket E14 connection screw				
	GEV No.	359064	Ref. No.	—
lamp socket mounting measurements ø22.3mm socket E14 connection screw 250/380V ambient temperature at 1W 100°C ambient temperature at 2W 85°C				

Table continues overleaf

accessories for		359601	
GEV No.	359685	Ref. No.	—
	lamp socket mounting measurements ø16.2mm socket E10		
GEV No.	359832	Ref. No.	—
	lamp socket mounting measurements ø16.2mm socket Ba9s connection male faston 6.3mm		
GEV No.	359853	Ref. No.	—
	lamp socket mounting measurements ø18.2mm socket Ba9s connection male faston 6.3mm		
GEV No.	359988	Ref. No.	—
	lamp socket mounting measurements ø30.5mm 250V connection F6.3 temp.-resist. 55°C E14		

light bulbs

for ovens

1			
GEV No.	359610	Ref. No.	359610
description	light bulb t.max. 300°C socket E14 15W 230V ø 22mm L 47mm lens L 20mm for oven lamp type Philips		

for indicator lights

1			
GEV No.	360697	Ref. No.	E201001
description	light bulb t.max.°C socket E10 2W 28V ø 10mm L 28mm lens L 12mm Qty 1 pcs		

oven lamps

universal oven lamps

mounting diameter 35.5mm

1			
GEV No.	359718	Ref. No.	E202055
description	oven lamp mounting ø 35.5mm 230V 15W socket E14 temp.-resist. 300°C connection male faston 6.3mm hard glas		
spare parts for	359718		
GEV No.	359701	Ref. No.	—
	lamp socket socket E14 220-230V mounting ø 35.5mm connection male faston 6.3mm 15W		
GEV No.	359740	Ref. No.	—
	light bulb t.max. 300°C socket E14 15W 230V ø 22mm L 48mm lens L 20mm for oven lamp IMPORT		

1			
GEV No.	359709	Ref. No.	E202056
description	oven lamp glass thr.ø 33.5mm ø 42mm hard glas temp.-resist. 350°C		





55x70mm

1			
GEV No.	357105	Ref. No.	E202046
description	lamp socket socket G9 250V mounting measurements 55x70mm connection male faston 6.3mm H 32mm		
accessories for	357105		
GEV No.	359297	Ref. No.	E202049
	frame L 95mm W 81mm mounting distance 68/83mm thickness 6mm		
GEV No.	359299	Ref. No.	E202048
	gasket L 91mm W 77mm hole ø 3mm for oven lamp		
GEV No.	359937	Ref. No.	—
	lamp glass L 80mm W 65mm mounting measurements 52x67mm		
GEV No.	359945	Ref. No.	—
	halogen lamp socket G9 230V 25W temp.-resist. 300°C		

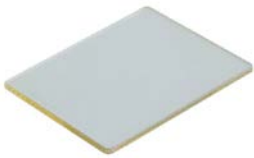
1			
GEV No.	359297	Ref. No.	E202049
description	frame L 95mm W 81mm mounting distance 68/83mm thickness 6mm		
accessories for	359297		
GEV No.	359299	Ref. No.	E202048
	gasket L 91mm W 77mm hole ø 3mm for oven lamp		

1			
GEV No.	359299	Ref. No.	E202048
description	gasket L 91mm W 77mm hole ø 3mm for oven lamp		

			
1			
GEV No.	359296	Ref. No.	E202047
description	lamp glass L 74mm W 58mm thickness 3mm		

			
1			
GEV No.	357105	Ref. No.	E202046
description	lamp socket socket G9 250V mounting measurements 55x70mm connection male faston 6.3mm H 32mm		
accessories for	357105		
	GEV No.	359297	Ref. No. E202049
	frame L 95mm W 81mm mounting distance 68/83mm thickness 6mm		
	GEV No.	359299	Ref. No. E202048
	gasket L 91mm W 77mm hole ø 3mm for oven lamp		
	GEV No.	359937	Ref. No. —
	lamp glass L 80mm W 65mm mounting measurements 52x67mm		
	GEV No.	359945	Ref. No. —
	halogen lamp socket G9 230V 25W temp.-resist. 300°C		



lamps



light bulbs



			
1			
GEV No.	359610	Ref. No.	359610
description	light bulb t.max. 300°C socket E14 15W 230V ø 22mm L 47mm lens L 20mm for oven lamp type Philips		

timers

programme timers



			
1			
GEV No.	360020	Ref. No.	L453520
description	timer CEM HFD4M16 engines 1 chambers 4 operation time 240s 230V shaft ø 6x4.6mm shaft L 17mm manuf. no. HFD4M16 / DTP16 motor type UDS11NE1RH		
spare parts for	360020		
	GEV No.	360112	Ref. No. —
	motor SAIA pinion ø 4mm teeth 12 230V turn direction right motor ø 48mm motor type UDS11NE1RHZ for timer		

			
1			
GEV No.	360028	Ref. No.	L453515
description	timer CEM HFD4M16 engines 1 chambers 4 operation time 270s 230V shaft ø 6x4.6mm shaft L 17mm manuf. no. HFD4M16 / DTP15 motor type UDS11NE1RH		
spare parts for	360028		
	GEV No.	360112	Ref. No. —
	motor SAIA pinion ø 4mm teeth 12 230V turn direction right motor ø 48mm motor type UDS11NE1RHZ for timer		

			
1			
GEV No.	360018	Ref. No.	L453512
description	timer CEM HH4M16 engines 1 chambers 4 operation time 270s 230V manuf. no. HH4M16 / DTP13 motor type UDS11NE1LH		
spare parts for	360018		
	GEV No.	360113	Ref. No. —
	motor SAIA pinion ø 4mm teeth 12 230V turn direction left motor ø 48mm motor type UDS40NE1RNZ165 for timer		





1

GEV No.	360030	Ref. No.	L453528
description	timer CEM HL6M16 engines 2 chambers 6 operation time 60s/120s 230V shaft ømm shaft Lmm manuf. no. HL6M16 / DTP21 motor type UDS11NE1RH / UDS11NE1LH		
spare parts for	360030		
	GEV No.	360112	Ref. No. —
	motor SAIA pinion ø 4mm teeth 12 230V turn direction right motor ø 48mm motor type UDS11NE1RHZ for timer		
	GEV No.	360113	Ref. No. —
	motor SAIA pinion ø 4mm teeth 12 230V turn direction left motor ø 48mm motor type UDS40NE1RNZ165 for timer		

alarm devices

buzzers



1

GEV No.	350219	Ref. No.	E204042
description	buzzer 220VAC/DC connection male faston 6.3mm moulded built-in version thread M28x1dB mounting ø 42.5/32.5mm		

contactors

TELEMECANIQUE (Schneider Electric)

power contactors



1

GEV No.	380479	Ref. No.	E050903
description	power contactor resistive load 25A 230VAC (AC3/400V) 9A/4kW main contacts 3NO auxiliary contacts 1NO/1NC connection screw connection type LC1D09P7		
For models:	W381511, W381521, W381531, W381541, W381611, W381621, W381631, W381641, W381811, W381821, W381831, W385011, W385012		



1

GEV No.	380617	Ref. No.	E050901
description	power contactor resistive load 25A 24VAC (AC3/400V) 9A/4kW main contacts 3NO auxiliary contacts 1NO/1NC connection screw connection type LC1D09B7		



1

GEV No.	381159	Ref. No.	E050904
description	power contactor resistive load 25A 400VAC (AC3/400V) 9A/4kW main contacts 3NO auxiliary contacts 1NO/1NC connection screw connection type LC1D09V7		
For models:	W380916, W380926, W380936, W380946, W381611, W381621, W381631, W381641		



1

GEV No.	380976	Ref. No.	E050932
description	power contactor resistive load 32A 230VAC (AC3/400V) 18A/7.5kW main contacts 3NO auxiliary contacts 1NO/1NC connection screw connection		
For models:	W381031, W381131, W381132, W385013, W385014		



1





GEV No.	380981	Ref. No.	E050869
description	power contactor resistive load 60A 230VAC (AC3/400V) 40A/18.5kW main contacts 3NO auxiliary contacts 1NO/1NC connection screw connection type LC1D40P7		

with male contacts

female contact 2.0mm



1

GEV No.	380377	Ref. No.	E052347	
description	power relays FINDER 220-240VAC 10A 2CO connection F2 plug-in connection manuf. no. 55.32.8.230.0000 94.92.3 250V			
accessories for	380377			
	GEV No.	380341	Ref. No.	—
	relay socket 4-pole contacts 12 300V voltage AC 6A Italiana Relè manuf. no. ZMD4			
	GEV No.	380378	Ref. No.	—
	relay socket 2-pole 55/85 dimensions 70.5x30x27mm 250V voltage AC 10A FINDER manuf. no. 94.72			
	GEV No.	380384	Ref. No.	—
	relay socket 2-pole contacts male faston 2.8mm 250V voltage AC 10A W 23mm for			
	GEV No.	380399	Ref. No.	—
	relay socket 4-pole dimensions 76.2x27x86.1mm 250V voltage AC 1A FINDER manuf. no. 94.94.3			

relays

power relays

with bracket mounting



1

GEV No.	380139	Ref. No.	L451712
description	power relays FINDER 230VAC 16A 2CO connection F6.3 bracket mounting dimensions 68x38.2x35.8mm manuf. no. 62.82.8.230.0000		



1

GEV No.	380808	Ref. No.	L451725
description	power relays FINDER 230VAC 16A 3CO connection male faston 6.3mm bracket mounting manuf. no. 62.83.8.230.0000		



1

GEV No.	380185	Ref. No.	L451715
description	power relays Italiana Relè 230VAC 30A 1NO connection F6.3 bracket mounting dimensions 36.5x32.2x51.8mm manuf. no. A10-230AC-FA		

time relays

time relays



1

GEV No.	380878	Ref. No.	E1Z1E10 E452071
description	time relay FINDER 80.11.0.240 time range 0.1s-20h 12-240V AC/DC 16A mounting measurements DIN railmm 1CO connection grip connection		



electronic controllers

SERSA



1	GEV No.	378545	Ref. No.	E403036
description electronic controller type SSA 96 J2S D-270-24V mounting measurements 90x90mm 24V voltage AC Pt100 built-in depth 95mm up to +270°C display 3 digits				

probes

universal probes

temperature probes

1	GEV No.	378546	Ref. No.	E351625
description temperature probe thermocouple J (Fe-CuNi) probe -50 up to +750°C cable probe ø3 cable length 3m				

producer-specific probes

probes

1	GEV No.	381405	Ref. No.	E403525
description temperature probe Pt100 cable PTFE probe -200 up to +600°C connection 3-wire probe ø5x100mm cable length 2m				

1	GEV No.	379635	Ref. No.	E403514
description temperature probe thermocouple J (Fe-CuNi) cable Vetrotex probe -50 up to +750°C cable -50 up to +350°C connection 2-wire thread probe ø5x100mm cable length 2m				
accessories for 379635				
	GEV No.	379636	Ref. No.	G701005
union screw set thread M8x1 probe ø 5mm				

accessories

screw connections

1	GEV No.	379636	Ref. No.	G701005 G701005+G701006
description union screw set thread M8x1 probe ø 5mm				

electronics

PCBs

1	GEV No.	403140	Ref. No.	E050561
description keypad PCB combi-steamer AC 150- AC 220 L 104mm W 32mm buttons 3				

1	GEV No.	400898	Ref. No.	L453882
description keypad PCB dishwasher LP10/20/30 with display				
accessories for 400898				
	GEV No.	402970	Ref. No.	L454510
ribbon cable 10-pole L 1200mm plug type 2 row coded Qty 1m				

1	GEV No.	403016	Ref. No.	E050555
description keypad PCB fryer JBM L 132mm W 81mm suitable for CAPIC with display buttons 4				



1

GEV No.	403130	Ref. No.	E054059
description	PCB combi-steamer TVTS L 90mm W 70mm level control		
For models:	W384111, W384112, W384121, W384122		



1

GEV No.	403572	Ref. No.	L453812
description	PCB dishwasher Protech 1113/611 TR10 L 178mm W 125mm		



1

GEV No.	403045	Ref. No.	L453812
description	PCB suitable for ELETTOBAR		

keypads

front foils



1

GEV No.	505280	Ref. No.	A504232
description	keypad foil tilting bratt pan blue/yellow suitable for CAPIC L 105mm W 57mm buttons 2		

solenoïd valves

solenoïd valves (water)

TP





























GEV No.	370021	Ref. No.	L601005	
description	solenoid valve double straight 230VAC inlet 3/4" outlet 11.5mm DN10 TP flow regulating valve inlet white			
For models:	W381131, W381132			
spare parts for	370021			
	GEV No.	371013	Ref. No.	—
accessories for	370021			
	GEV No.	371220	Ref. No.	—
description	reducer TP flow rate 3l/min red tolerance ±15%			
	GEV No.	371221	Ref. No.	—
description	reducer TP flow rate 5.5l/min yellow tolerance ±15%			
	GEV No.	371222	Ref. No.	—
description	reducer TP flow rate 6l/min grey tolerance ±15%			
	GEV No.	371223	Ref. No.	—
description	reducer TP flow rate 10l/min white tolerance ±15%			
	GEV No.	371224	Ref. No.	—
description	reducer TP flow rate 12l/min bronze tolerance ±15%			
	GEV No.	371225	Ref. No.	—
description	reducer TP flow rate 16l/min light brown tolerance ±15%			
	GEV No.	371226	Ref. No.	—
description	reducer TP flow rate 20l/min red tolerance ±15%			
	GEV No.	371230	Ref. No.	—
description	reducer TP flow rate 0.25l/min red tolerance ±25%			
	GEV No.	371231	Ref. No.	—
description	reducer TP flow rate 0.35l/min violet tolerance ±25%			
	GEV No.	371232	Ref. No.	—
description	reducer TP flow rate 0.5l/min orange tolerance ±25%			
	GEV No.	371233	Ref. No.	—
description	reducer TP flow rate 0.8l/min white tolerance ±25%			
	GEV No.	371234	Ref. No.	—
description	reducer TP flow rate 1l/min light blue tolerance ±25%			
	GEV No.	371235	Ref. No.	—
description	reducer TP flow rate 1.2l/min brown tolerance ±25%			

Table continues overleaf



accessories for 370021				
GEV No.	371236	Ref. No.	—	
			reducer TP flow rate 1.5l/min light brown tolerance ±25%	
			reducer TP flow rate 2.5l/min yellow tolerance ±25%	
			reducer TP flow rate 3.4l/min dark green tolerance ±25%	
			reducer TP flow rate 5l/min black tolerance ±25%	
			reducer TP flow rate 8l/min blue tolerance ±20%	

  <p>1</p>				
GEV No.	370017	Ref. No.	L600505	
description	solenoid valve single straight 230VAC inlet 3/4" outlet 11.5mm DN10 TP p max 10bar			
spare parts for	370017			
	GEV No.	371013	Ref. No.	—
solenoid coil TP 230VAC 50/60Hz				
accessories for	370017			
	GEV No.	371220	Ref. No.	—
reducer TP flow rate 3l/min red tolerance ±15%				
	GEV No.	371221	Ref. No.	—
reducer TP flow rate 5.5l/min yellow tolerance ±15%				
	GEV No.	371222	Ref. No.	—
reducer TP flow rate 6l/min grey tolerance ±15%				
	GEV No.	371223	Ref. No.	—
reducer TP flow rate 10l/min white tolerance ±15%				
	GEV No.	371224	Ref. No.	—
reducer TP flow rate 12l/min bronze tolerance ±15%				
	GEV No.	371225	Ref. No.	—
reducer TP flow rate 16l/min light brown tolerance ±15%				
	GEV No.	371226	Ref. No.	—
reducer TP flow rate 20l/min red tolerance ±15%				
	GEV No.	371230	Ref. No.	—
reducer TP flow rate 0.25l/min red tolerance ±25%				
	GEV No.	371231	Ref. No.	—
reducer TP flow rate 0.35l/min violet tolerance ±25%				
	GEV No.	371232	Ref. No.	—
reducer TP flow rate 0.5l/min orange tolerance ±25%				

accessories for 370017				
GEV No.	371233	Ref. No.	—	
			reducer TP flow rate 0.8l/min white tolerance ±25%	
			reducer TP flow rate 1l/min light blue tolerance ±25%	
			reducer TP flow rate 1.2l/min brown tolerance ±25%	
			reducer TP flow rate 1.5l/min light brown tolerance ±25%	
			reducer TP flow rate 2.5l/min yellow tolerance ±25%	
			reducer TP flow rate 3.4l/min dark green tolerance ±25%	
			reducer TP flow rate 5l/min black tolerance ±25%	
			reducer TP flow rate 8l/min blue tolerance ±20%	























  <p>1</p>				
GEV No.	370025	Ref. No.	L601015	
description	solenoid valve triple straight 230VAC inlet 3/4" outlet 11.5mm DN10 TP			
spare parts for	370025			
	GEV No.	371013	Ref. No.	—
solenoid coil TP 230VAC 50/60Hz				
accessories for	370025			
	GEV No.	371220	Ref. No.	—
reducer TP flow rate 3l/min red tolerance ±15%				
	GEV No.	371221	Ref. No.	—
reducer TP flow rate 5.5l/min yellow tolerance ±15%				
	GEV No.	371222	Ref. No.	—
reducer TP flow rate 6l/min grey tolerance ±15%				
	GEV No.	371223	Ref. No.	—
reducer TP flow rate 10l/min white tolerance ±15%				
	GEV No.	371224	Ref. No.	—
reducer TP flow rate 12l/min bronze tolerance ±15%				
	GEV No.	371225	Ref. No.	—
reducer TP flow rate 16l/min light brown tolerance ±15%				

Table continues overleaf



accessories for		370025		
	GEV No.	371226	Ref. No.	—
	reducer TP flow rate 20l/min red tolerance ±15%			
	GEV No.	371230	Ref. No.	—
	reducer TP flow rate 0.25l/min red tolerance ±25%			
	GEV No.	371231	Ref. No.	—
	reducer TP flow rate 0.35l/min violet tolerance ±25%			
	GEV No.	371232	Ref. No.	—
	reducer TP flow rate 0.5l/min orange tolerance ±25%			
	GEV No.	371233	Ref. No.	—
	reducer TP flow rate 0.8l/min white tolerance ±25%			
	GEV No.	371234	Ref. No.	—
	reducer TP flow rate 1l/min light blue tolerance ±25%			
	GEV No.	371235	Ref. No.	—
	reducer TP flow rate 1.2l/min brown tolerance ±25%			
	GEV No.	371236	Ref. No.	—
	reducer TP flow rate 1.5l/min light brown tolerance ±25%			
	GEV No.	371237	Ref. No.	—
	reducer TP flow rate 2.5l/min yellow tolerance ±25%			
	GEV No.	371238	Ref. No.	—
	reducer TP flow rate 3.4l/min dark green tolerance ±25%			
	GEV No.	371239	Ref. No.	—
	reducer TP flow rate 5l/min black tolerance ±25%			
	GEV No.	371240	Ref. No.	—
	reducer TP flow rate 8l/min blue tolerance ±20%			

metal				
SIRAI				
solenoid valves steam (water)				
2-way				
L145-R series				
	1			
GEV No.	370324	Ref. No.	E131716	
description	solenoid valve 2-ways 24VAC inlet 3/4" outlet 3/4" connection 3/4" L 79mm DN 16mm slide-on receptacle DIN -60 up to +170°C SIRAI type series L145-R coil type Z534A membranes PTFE (steam) p max 6bar p min 0.4bar			
spare parts for	370324			
	GEV No.	371068	Ref. No.	—
	solenoid coil 24VAC 14VA SIRAI coil type Z534A seat ø 12mm			

spare parts for		370324		
	GEV No.	371165	Ref. No.	—
	membrane connection 3/4" series L145-R membrane type PTFE			
accessories for		370324		
	GEV No.	371090	Ref. No.	—
	power socket plug type DIN 43650A screw			

solenoid valves (gas)

ASCO			
	1		
GEV No.	370710	Ref. No.	E131002
description	solenoid valve gas 2-ways 230VAC inlet 1/8" outlet 1/8" t.max. 60°C connection 1/8" L 33mm Asco coil type 400127-197 p max 15bar membranes FPM type series 256 overall height 53mm		
For models:	W381035, W384121, W384122		

pressure switches for warewashing

ø 58mm with male faston 6.3mm with connection horizontal			
	1		
GEV No.	541013	Ref. No.	L455210
description	pressure control pressure range 55/25mbar connection 6mm ø 58mm pressure connection horizontal warewashing		

	1		
GEV No.	541003	Ref. No.	L455225
description	pressure control pressure range 55/35mbar connection 6mm ø 58mm pressure connection horizontal warewashing pressure connection ø 6mm		



electrodes

			
1			
GEV No.	403674	Ref. No.	E054062
description	level electrode threaded total length 120mm probe L 61mm insulated probe length 24mm ø 4mm		
For models:	W384111, W384112, W384121, W384122		

fans

axial fans

import

			
1			
GEV No.	601080 ¹	Ref. No.	E050571
description	axial fan L 119mm W 119mm H 38mm 230VAC 50/60Hz 23/20W bearing ball bearing connection male faston 2.8mm metal ADDA fan wheel ø 110mm temp.-resist. 70°C		
For models:	W381811, W381821, W381831		
accessories for	601080		
	GEV No.	550898	Ref. No. —
	connecting cable cable length 2000mm connection F 2.8 connection distance 7.9mm for axial flow fan		
	GEV No.	692519	Ref. No. —
	guard L 120mm W 120mm plastic		

¹with ball bearings

cross flow fans

ebm-papst

			
1			
GEV No.	601936	Ref. No.	E254003
description	cross flow fan QLZ06/1800A265-2524 roller ø 60mm roller length 180mm laminated core thickness 28mm motor position right 230V/50Hz 31W refrigeration bearing rubber connection male faston 6.3mm airflow 160m ³ /h 0 up to +60°C 230V 150m ³ /h 50Hz		



accessories for cross flow fans

heater battery

			
1			
GEV No.	415122	Ref. No.	E254001
description	heater battery mounting distance 185mm W 40mm H 35mm 2000W 230V temperature restriction 105°C heating circuits 2 connection cable cable length 340mm L 197mm for cross flow fan		

hot air motors

			
1			
GEV No.	601871	Ref. No.	13390026
description	fan motor 230V 1 phase 50Hz 85kW 2400rpm speeds 1 L1 85mm L2 40mm L3 33mm L4 133.5mm fan wheel ø 180mm at 50Hz 230V at 60Hz 230V at 50Hz 2600rpm at 60Hz 2850rpm type R2E180-AU01-09		

			
1			
GEV No.	500106	Ref. No.	13390026
description	hot air fan 230V 1 phase 50Hz 0.12kW 2600rpm speeds 1 L1 100mm L2 34mm L3 33mm L4 178mm power input 115W 0.51A fan wheel ø 180mm at 50Hz 230V at 60Hz 230V at 50Hz 2600rpm at 60Hz 2850rpm suitable capacitor 3µF400V type R2E180-AH05-06		
accessories for	500106		
	GEV No.	100021	Ref. No. —
	female faston size 2.8x0.8mm 0.5-1.0mm ² CuZn t.max. 125°C Qty 20 pcs		
	GEV No.	365028	Ref. No. —
	operating capacitor capacity 3µF 450V tolerance 5% 50/60Hz ambient temperature max. -25 to +85°C ø 35.5mm L 75mm M8 plastic connection male faston 6.3mm protection		





hot air fans

LEROY SOMER



1

GEV No.	602081	Ref. No.	E254005
description	hot air fan 230/400V 250W 1.05/0.6A 2770rpm L1 115mm L2 95mm type 400870/003		

spare parts for	500037		
	GEV No.	510695	Ref. No. —
	mechanical shaft seal height counter ring 5.5mm ID ø 11mm		
	GEV No.	521203	Ref. No. —
	impellor ø 72mm H 18mm thread M7 shaft ø 11mm shaft length 32mm blades 3		
	GEV No.	521703	Ref. No. —
	pump cover gasket EPDM thickness 2.5mm ID ø 75mm Qty 1 pcs		

motors

spindle motors

SKF/ATB



1

GEV No.	499136	Ref. No.	E020515
description	spindle motor type MAX30-A200415A25200-000 24V voltage DC L 445mm W 185mm H 120mm SKF/ATB		
For models:	W385011, W385013, W385015, W385021, W385023, W385025		



GEV No.	500544	Ref. No.	L350261
description	pump inlet ø 60mm outlet ø 50mm type 4223.1900 230V 50Hz 1 phase 0.73kW 1HP L 225mm rotation direction right capacitor 16µF FIR		
spare parts for	500544		
	GEV No.	365021	Ref. No. —
	operating capacitor capacity 16µF 425V tolerance 5% 50/60Hz ambient temperature max. -25 to +85°C ø 35mm L 73mm single M8 plastic connection male faston 6.3mm 416.10.99 protection		
	GEV No.	510552	Ref. No. —
	pump cover gasket pump type 1292-2/3942/3981/3911/3983		
	GEV No.	510693	Ref. No. L351650
	mechanical shaft seal for shaft ø 12mm slide ring ext. ø 24mm slide ring H 15.5mm slide ring int. ø 11mm counter ring mounting ø 24mm height counter ring 8mm counter ring int. ø 13.5mm		
	GEV No.	518067	Ref. No. —
	impellor ø 103mm H 29mm M7L		
	GEV No.	521512	Ref. No. —
	pump cover FIR inlet ø 60mm outlet ø 50mm		

pumps



wash and rinse pumps

FIR

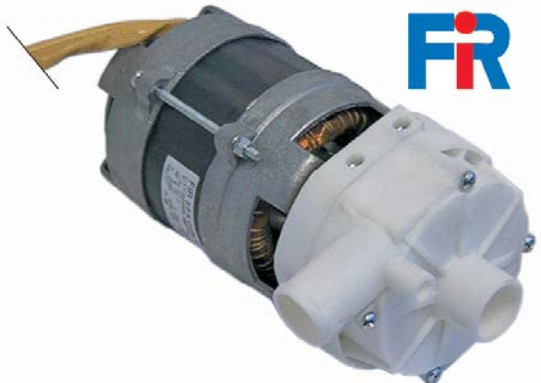



pumps





1



GEV No.	500037	Ref. No.	L350210
description	pump inlet ø 28mm outlet ø 26mm type 2211.1410 230V 50Hz 1 phase 0.074kW 0.1HP L 190mm rotation direction left capacitor 5µF FIR		
spare parts for	500037		
	GEV No.	365017	Ref. No. L452005
	operating capacitor capacity 5µF 450V tolerance 5% 50/60Hz ambient temperature max. -25 to +85°C ø 28mm L 54mm M8 plastic connection male faston 6.3mm 16.10.08 protection		
	GEV No.	510384	Ref. No. —
	pump cover inlet ø 28mm outlet ø 26mm ø 100mm ID ø 76mm		



GEV No.	500117	Ref. No.	L350427
description	pump inlet ø 63mm outlet ø 47mm type 4225.22725 230/400V 50Hz 3 phase 1.4kW 2HP L 280mm rotation direction right FIR		
spare parts for	500117		
	GEV No.	510602	Ref. No. —
	impellor ø 110mm H 34mm rotation direction right thread M8L shaft ø 28mm seat ø 12.2mm blades 6		
	GEV No.	510693	Ref. No. L351650
	mechanical shaft seal for shaft ø 12mm slide ringext. ø 24mm slide ring H 15.5mm slide ring int. ø 11mm counter ring mounting ø 24mm height counter ring 8mm counter ring int. ø 13.5mm		
	GEV No.	521513	Ref. No. —
	pump cover FIR inlet ø 63mm outlet ø 47mm turn direction right ID ø 150mm inner height 32mm		
	GEV No.	524416	Ref. No. L350430
	pump cover gasket thickness 4x4mm Qty 1 pcs		



GEV No.	500258	Ref. No.	L350420
description	pump inlet ø 63mm outlet ø 53mm type 1204.2725 230/400V 50Hz 3 phase 1.5kW 2.01HP L 320mm rotation direction left FIR		
spare parts for	500258		
	GEV No.	510531	Ref. No. L351230
	pump cover FIR inlet ø 63mm outlet ø 53mm auxiliary pressure connection M16x1.5mm supporting pressure open turn direction left ø 185mm ID ø 150mm inner height 37mm		
	GEV No.	510604	Ref. No. —
	impellor ø 118mm H 34mm M8R rotation direction left		





spare parts for	500258		
	GEV No.	510693	Ref. No. L351650
	mechanical shaft seal for shaft ø 12mm slide ringext. ø 24mm slide ring H 15.5mm slide ring int. ø 11mm counter ring mounting ø 24mm height counter ring 8mm counter ring int. ø 13.5mm		
	GEV No.	511667	Ref. No. —
	fan wheel ø 123mm H 17mm shaft intake ø 15mm		
	GEV No.	524416	Ref. No. L350430
	pump cover gasket thickness 4x4mm Qty 1 pcs		

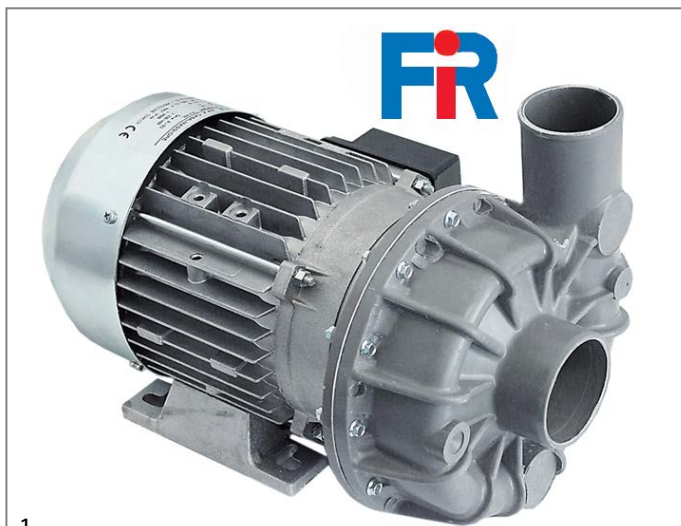

GEV No.	500031	Ref. No.	L350427
description	pump inlet ø 63mm outlet ø 53mm type 1205.2528 230/400V 50Hz 3 phase 2kW 2.7HP L 330mm rotation direction left FIR		
spare parts for	500031		
	GEV No.	510357	Ref. No. L350655
	impellor ø 124mm H 34/16mm thread M8R blades 6		
	GEV No.	510523	Ref. No. —
	fan wheel ø 142mm shaft intake ø 15mm blades 12		
	GEV No.	510531	Ref. No. L351230
	pump cover FIR inlet ø 63mm outlet ø 53mm auxiliary pressure connection M16x1.5mm supporting pressure open turn direction left ø 185mm ID ø 150mm inner height 37mm		
	GEV No.	510693	Ref. No. L351650
	mechanical shaft seal for shaft ø 12mm slide ringext. ø 24mm slide ring H 15.5mm slide ring int. ø 11mm counter ring mounting ø 24mm height counter ring 8mm counter ring int. ø 13.5mm		
	GEV No.	524416	Ref. No. L350430
	pump cover gasket thickness 4x4mm Qty 1 pcs		







1

GEV No.	500111	Ref. No.	L350410
description	pump inlet ø 63mm outlet ø 53mm type 1241.2500 230/400V 50Hz 3 phase 1.1kW 1.5HP L 330mm rotation direction left FIR		
spare parts for	500111		
	GEV No.	510531	Ref. No. L351230
	pump cover FIR inlet ø 63mm outlet ø 53mm auxiliary pressure connection M16x1.5mm supporting pressure open turn direction left ø 185mm ID ø 150mm inner height 37mm		
	GEV No.	510612	Ref. No. —
	impellor ø 110mm H 34mm M8R		
	GEV No.	510693	Ref. No. L351650
	mechanical shaft seal for shaft ø 12mm slide ring ext. ø 24mm slide ring H 15.5mm slide ring int. ø 11mm counter ring mounting ø 24mm height counter ring 8mm counter ring int. ø 13.5mm		
	GEV No.	524416	Ref. No. L350430
	pump cover gasket thickness 4x4mm Qty 1 pcs		



1





GEV No.	500324	Ref. No.	L350440
description	pump inlet ø 63mm outlet ø 53mm type 1243.2591 230/400V 50Hz 3 phase 2.35kW 3.2HP L 365mm rotation direction left FIR		
spare parts for	500324		
	GEV No.	510357	Ref. No. L350655
	impellor ø 124mm H 34/16mm thread M8R blades 6		
	GEV No.	510531	Ref. No. L351230
	pump cover FIR inlet ø 63mm outlet ø 53mm auxiliary pressure connection M16x1.5mm supporting pressure open turn direction left ø 185mm ID ø 150mm inner height 37mm		

spare parts for	500324		
	GEV No.	510693	Ref. No. L351650
	mechanical shaft seal for shaft ø 12mm slide ring ext. ø 24mm slide ring H 15.5mm slide ring int. ø 11mm counter ring mounting ø 24mm height counter ring 8mm counter ring int. ø 13.5mm		
	GEV No.	524416	Ref. No. L350430
	pump cover gasket thickness 4x4mm Qty 1 pcs		

LGB



1

GEV No.	500362	Ref. No.	L350429
description	pump inlet ø 62mm outlet ø 50mm type CE150SX 230/400V 50Hz 3 phase 1.1kW 1.5HP L 280mm rotation direction right LGB		
spare parts for	500362		
	GEV No.	510551	Ref. No. —
	pump cover gasket ID ø 158.3mm pump type 1214/1293/1225/2243/1226/1204/3473/1241 thickness 3.53mm EPDM Qty 1 pcs		
	GEV No.	510693	Ref. No. L351650
	mechanical shaft seal for shaft ø 12mm slide ring ext. ø 24mm slide ring H 15.5mm slide ring int. ø 11mm counter ring mounting ø 24mm height counter ring 8mm counter ring int. ø 13.5mm		
	GEV No.	521240	Ref. No. L350667
	impellor ø 110mm H 32mm rotation direction left thread M8L shaft ø 20mm shaft length 10mm seat ø 8.2mm blades 6		
	GEV No.	521536	Ref. No. —
	pump cover ALBA / LGB inlet ø 62mm outlet ø 50mm auxiliary pressure connection 12mm supporting pressure closed turn direction right ø 180mm ID ø 150mm inner height 38mm		
	GEV No.	602013	Ref. No. —
	fan wheel ø 100mm H 28mm shaft intake ø 17.5mm plastic		



booster pumps II

accessories

			
1			
GEV No.	365017	Ref. No.	L452005
description	operating capacitor capacity 5µF 450V tolerance 5% 50/60Hz ambient temperature max. -25 to +85°C ø 28mm L 54mm M8 plastic connection male faston 6.3mm 16.10.08 protection		

condensators & interference suppression filters

operating capacitors

plastic

			
1			
GEV No.	365019	Ref. No.	L452027
description	operating capacitor capacity 20µF 400V tolerance 5% 50/60Hz ambient temperature max. -25 to +85°C ø 39.5mm L 70mm M8 plastic connection male faston 6.3mm 16.10.25. protection		

			
1			
GEV No.	365017	Ref. No.	L452005
description	operating capacitor capacity 5µF 450V tolerance 5% 50/60Hz ambient temperature max. -25 to +85°C ø 28mm L 54mm M8 plastic connection male faston 6.3mm 16.10.08 protection		

electric accessories

cables



nickel wire

up to 350°C

			
1			
GEV No.	550088	Ref. No.	E351515
description	nickel wire 2.5mm ² brown Qty 10m permanent temperature -60 up to +350°C t.max. 400°C rated 300/500V test voltage 2000V conductor nickel wire insulation glass fibre braiding/silicone rubber		

accessories

protection hoses

			
1			
GEV No.	550566	Ref. No.	E303030
description	screw connection for protection hose PG21 ID ø 21.7mm ED ømm nickel-plated brass Qty 1 piece		
For models:	W384012, W385011, W385012, W385013, W385014, W385015		
accessories for	550566		
	GEV No.	550578	Ref. No. E303045
	 nut thread PG21 H 4.6mm WS 32 nickel-plated brass Qty 1 pcs mounting ømm cable ømm		

cable glands

threaded cable glands

fastening nuts

			
1			
GEV No.	550578	Ref. No.	E303045
description	nut thread PG21 H 4.6mm WS 32 nickel-plated brass Qty 1 pcs mounting ømm cable ømm		
For models:	W384012, W385011, W385012, W385013, W385014, W385015		

ribbon cables

group 1

			
1			
GEV No.	402970	Ref. No.	L454510
description	ribbon cable 10-pole L 1200mm plug type 2 row coded Qty 1m		

terminals

connection terminals with screw/faston connections

			
1			
GEV No.	550411	Ref. No.	L450310
description	power terminal block 6-pole max. 40A max 450V connection ø6mm ² / F6.3 temp.-resist. 150°C cross section 6mm ²		



rail-mounted terminals

miscellaneous



GEV No.	551135	Ref. No.	E352521
description	rail-mounted terminal 6mm ² grey H 47mm 1-pole		

accessories for	101459		
	GEV No.	101249	Ref. No. —
	olive for pipe ø 10mm Qty 1 pcs		
	GEV No.	101250	Ref. No. —
	union nut thread M20x1.5 for pipe ø 10mm		
	GEV No.	101251	Ref. No. —
	union nut thread M20x1.5 for pipe ø 12mm		
	GEV No.	101286	Ref. No. G701011
	olive ID ø 6mm Qty 1 pcs		

gas taps

PEL

22N/O series



GEV No.	101459	Ref. No.	G303075
----------------	--------	-----------------	---------

description
gas tap PEL type 22N/O gas inlet pipe flange ø21mm bypass nozzle ø 0.35mm gas outlet M20x1.5 (tube ø 12/10mm) thermocouple connection pilot connection M10x1 shaft ø 8x6.5mm shaft L 39/7mm shaft flat upper

spare parts for 101459

	GEV No.	101237	Ref. No.	—
	flange thread M20x1.5 tube ø 21mm suitable for PEL22			
	GEV No.	101365	Ref. No.	—
	gas connection thread M20x1.5 tube ø 12mm for PEL gas taps horizontal			
	GEV No.	101447	Ref. No.	—
	gas tap front part shaft ø 8x6.5mm shaft flat lateral Spezial			
	GEV No.	101460	Ref. No.	—
	O-ring ø 12.37mm D1 ø 2.62mm suitable for PEL22			
	GEV No.	101461	Ref. No.	—
	screw kit suitable for PEL22 Qty 4 pcs			
	GEV No.	101536	Ref. No.	—
	gasket D1 ø 17mm D2 ø 11.5mm thickness 4.7mm			
accessories for	101459			
	GEV No.	100908	Ref. No.	—
	union screw thread M10x1 for pipe ø 4mm Qty 1 pcs			
	GEV No.	100909	Ref. No.	G701010
	union screw thread M10x1 for pipe ø 6mm Qty 1 pcs			
	GEV No.	101246	Ref. No.	—
	olive for pipe ø 4mm Qty 1 pcs			
	GEV No.	101248	Ref. No.	G701026
	olive for pipe ø 12mm Qty 1 pcs suitable for PEL			

22S/O series



GEV No.	101469	Ref. No.	G304040
----------------	--------	-----------------	---------

description
gas tap PEL type 22S/O gas inlet pipe flange ø21mm bypass nozzle ø 0.35mm gas outlet M20x1.5 (tube ø 12/10mm) thermocouple connection M8x1 pilot connection M10x1 shaft ø 8x6.5mm shaft L 39/7mm shaft flat upper

For models:
W380111, W380112, W380121, W380122, W380131, W380132, W380141, W380142, W380151, W380152, W380161, W380162, W380211, W380221, W380231, W380241, W380251, W380261, W380411, W380413, W380421, W380423, W380431, W380433, W380441, W380443, W380451, W380461, W380511, W380521, W380531, W380541, W381515, W381525, W381535, W381545, W382511, W382551, W382552, W382561, W382562, W382611, W382651, W382652, W382661, W382662, W384021, W384022, W385021, W385022

spare parts for 101469









	GEV No.	101058	Ref. No.	G402060
	magnet unit L 39mm D1 ø 15.4mm D2 ø 13.5mm suitable for PEL22/ EGA24197 standard			
	GEV No.	101231	Ref. No.	—
	thermocouple nut T1: M9x1 T2: M18x1			
	GEV No.	101237	Ref. No.	—
	flange thread M20x1.5 tube ø 21mm suitable for PEL22			
	GEV No.	101365	Ref. No.	—
	gas connection thread M20x1.5 tube ø 12mm for PEL gas taps horizontal			
	GEV No.	101447	Ref. No.	—
	gas tap front part shaft ø 8x6.5mm shaft flat lateral Spezial			
	GEV No.	101460	Ref. No.	—
	O-ring ø 12.37mm D1 ø 2.62mm suitable for PEL22			
	GEV No.	101461	Ref. No.	—
	screw kit suitable for PEL22 Qty 4 pcs			
	GEV No.	101536	Ref. No.	—
	gasket D1 ø 17mm D2 ø 11.5mm thickness 4.7mm			



Table continues overleaf



accessories for		101469		
	GEV No.	100908	Ref. No.	—
	union screw thread M10x1 for pipe ø 4mm Qty 1 pcs			
	GEV No.	100909	Ref. No.	G701010
	union screw thread M10x1 for pipe ø 6mm Qty 1 pcs			
	GEV No.	101246	Ref. No.	—
	olive for pipe ø 4mm Qty 1 pcs			
	GEV No.	101248	Ref. No.	G701026
	olive for pipe ø 12mm Qty 1 pcs suitable for PEL			
	GEV No.	101249	Ref. No.	—
	olive for pipe ø 10mm Qty 1 pcs			
	GEV No.	101250	Ref. No.	—
	union nut thread M20x1.5 for pipe ø 10mm			
	GEV No.	101251	Ref. No.	—
	union nut thread M20x1.5 for pipe ø 12mm			
	GEV No.	101286	Ref. No.	G701011
	olive ID ø 6mm Qty 1 pcs			
	GEV No.	101290	Ref. No.	—
	thermocouple nut T1: M10x1 T2: M18x1 suitable for PEL20/21			

accessories for		101489		
	GEV No.	100908	Ref. No.	—
	union screw thread M10x1 for pipe ø 4mm Qty 1 pcs			
	GEV No.	100909	Ref. No.	G701010
	union screw thread M10x1 for pipe ø 6mm Qty 1 pcs			
	GEV No.	101246	Ref. No.	—
	olive for pipe ø 4mm Qty 1 pcs			
	GEV No.	101248	Ref. No.	G701026
	olive for pipe ø 12mm Qty 1 pcs suitable for PEL			
	GEV No.	101249	Ref. No.	—
	olive for pipe ø 10mm Qty 1 pcs			
	GEV No.	101250	Ref. No.	—
	union nut thread M20x1.5 for pipe ø 10mm			
	GEV No.	101251	Ref. No.	—
	union nut thread M20x1.5 for pipe ø 12mm			
	GEV No.	101286	Ref. No.	G701011
	olive ID ø 6mm Qty 1 pcs			













 <p>1</p>				
GEV No.	101489	Ref. No.	G304045	
description	gas tap PEL type 22S/O gas inlet pipe flange ø27mm bypass nozzle ø 0.35mm gas outlet M20x1.5 (tube ø 14/10mm) thermocouple connection M8x1 pilot connection M10x1 shaft ø 8x6.5mm shaft L 39/7mm shaft flat left			
spare parts for	101489			
	GEV No.	101058	Ref. No.	G402060
	magnet unit L 39mm D1 ø 15.4mm D2 ø 13.5mm suitable for PEL22/ EGA24197 standard			
	GEV No.	101230	Ref. No.	—
	thermocouple nut T1: M8x1 T2: M18x1 aluminium			
	GEV No.	101353	Ref. No.	—
	flange thread M20x1.5 tube ø 27mm suitable for PEL22			
	GEV No.	101366	Ref. No.	—
	gas connection thread M20x1.5 tube ø 14mm for PEL gas taps horizontal			
	GEV No.	101460	Ref. No.	—
	O-ring ø 12.37mm D1 ø 2.62mm suitable for PEL22			
	GEV No.	101461	Ref. No.	—
	screw kit suitable for PEL22 Qty 4 pcs			
	GEV No.	106165	Ref. No.	—
	gasket ø 27mm			



22S/V series				
 <p>1</p>				
GEV No.	107322	Ref. No.	G304047	
description	gas tap PEL type 22S/V gas inlet pipe flange ø21mm bypass nozzle ø 0mm gas outlet M20x1.5 (tube ø 12/10mm) thermocouple connection M9x1 pilot connection M10x1 shaft ø 8x6.5mm shaft L 39/7mm shaft flat upper			
For models:	W380912, W380915, W380917, W380919, W380922, W380925, W380927, W380929, W380932, W380935, W380937, W380939, W380942, W380945, W380947, W380949, W381515, W381525, W381535, W381545, W381815, W381825, W381835			
spare parts for	107322			
	GEV No.	101536	Ref. No.	—
	gasket D1 ø 17mm D2 ø 11.5mm thickness 4.7mm			



23S/O series



GEV No.	101091	Ref. No.	G304048
description	gas tap PEL type 23S/O gas inlet M28x1.5 (tube ø 20mm) bypass nozzle ø 0.35mm gas outlet M24x1.5 (tube ø 16mm) thermocouple connection M9x1 pilot connection M10x1 shaft ø 10x8mm shaft L 35/19mm shaft flat upper		
For models:	W385023, W385024, W385025		
spare parts for	101091		
	GEV No.	100455	Ref. No. —
	bypass nozzle type PEL23/24 bore ø 0.35mm thread M8x0.5		
	GEV No.	101045	Ref. No. —
	magnet unit T1: M9x1 T2: M22x1 L 46mm ø 18mm suitable for PEL23S M9x1		
	GEV No.	101244	Ref. No. —
	gas connection thread M24x1.5 tube ø 12/16mm horizontal for PEL gas taps		
	GEV No.	101336	Ref. No. —
	gas tap front part shaft ø 10x8mm shaft L 35/17mm shaft flat upper/lower suitable for PEL23S		
	GEV No.	101463	Ref. No. —
	screw suitable for PEL23S Qty 4 pcs		
	GEV No.	528455	Ref. No. —
	O-ring Viton thickness 2.62mm ID ø 18.72mm Qty 1 pcs		
accessories for	101091		
	GEV No.	100908	Ref. No. —
	union screw thread M10x1 for pipe ø 4mm Qty 1 pcs		
	GEV No.	100909	Ref. No. G701010
	union screw thread M10x1 for pipe ø 6mm Qty 1 pcs		
	GEV No.	101246	Ref. No. —
	olive for pipe ø 4mm Qty 1 pcs		
	GEV No.	101252	Ref. No. —
	union nut thread M24x1.5 for pipe ø 12mm		
	GEV No.	101253	Ref. No. —
	union nut thread M24x1.5 PEL for pipe ø 16mm		
	GEV No.	101254	Ref. No. —
	union nut thread M28x1.5 tube ø 20mm		
	GEV No.	101255	Ref. No. —
	olive for pipe ø 12mm Qty 1 pcs		
	GEV No.	101256	Ref. No. —
	olive for pipe ø 16mm Qty 1 pcs		
	GEV No.	101257	Ref. No. —
	olive for pipe ø 20mm Qty 1 pcs		

accessories for	101091		
	GEV No.	101286	Ref. No. G701011
	olive ID ø 6mm Qty 1 pcs		
	GEV No.	110080	Ref. No. —
	knob ø 70mm shaft ø 10x8mm shaft flat universal		
	GEV No.	112206	Ref. No. —
	knob dial plate silver gas tap PEL21/22/23 t.max.°C ED ø 63mm ID ø 45.5mm		

STN3R





GEV No.	106184	Ref. No.	G304010
description	gas tap STN3R gas inlet pipe flange ø20mm bypass nozzle ø 0mm gas outlet 3/8" (tube ø 12mm) thermocouple connection M9x1 pilot connection M10x1 shaft ø 10x8mm shaft L 21/12mm shaft flat upper suitable for CAPIC		
spare parts for	106184		
	GEV No.	101964	Ref. No. —
	clamping bracket		

gas thermostats

SIT

710 Minisit series



GEV No.	106931	Ref. No.	G652002
description	gas thermostat SIT type MINISIT 710 t.max. 310°C 70-310°C gas inlet 1/2" gas outlet 3/8" thermocouple connection M9x1 pilot connection M10x1 probe ø 4mm probe L 72mm capillary pipe 1300mm pressure controller no pressure regulator mbar gland nut 0710647 ignition gas 6mm probe material stainless steel		
For models:	W380161, W380162, W380261, W380461, W380666, W382561, W382562, W382661, W382662, W383061		
accessories for	106931		
	GEV No.	101137	Ref. No. G652202
	cover cap without piezoelectric igniter		
	GEV No.	110068	Ref. No. G652225
	knob suitable for Minisit ø 37mm		



GEV No.	101130	Ref. No.	G652006
description	gas thermostat without cap, button and angle SIT type MINISIT 710 t.max. 100°C 30-100°C gas inlet 1/2" gas outlet 3/8" thermocouple connection M9x1 pilot connection M10x1 probe ø 5mm probe L 122mm capillary pipe 1050mm probe type type A1 pressure controller no pressure regulator gland nut		
spare parts for	101130		
	GEV No.	101053	Ref. No. G402010
	magnet unit T1: M9x1 T2: M24x1 L 45mm ø 17mm suitable for Minisit		
	GEV No.	102100	Ref. No. —
	probe 30-100°C probe ø 5mm probe L 122mm capillary pipe 1050mm t.max. 100°C bain marie probe type type A1 suitable for MINISIT 710		
accessories for	101130		
	GEV No.	100809	Ref. No. —
	O-ring EPDM thickness 2mm ID ø 21mm Qty 1 pcs		
	GEV No.	100820	Ref. No. G652208
	gland duct ET M14x1.5 IT M10x0.75 probe ø max. 6.5mm WS 22		
	GEV No.	100904	Ref. No. —
	locking screw M10x1 for pipe ø 4mm Qty 1 pcs		
	GEV No.	100905	Ref. No. —
	locking screw M10x1 for pipe ø 6mm Qty 1 pcs		
	GEV No.	101054	Ref. No. —
	magnet unit T1: M10x1 T2: M24x1 L 45mm ø 17mm suitable for Minisit		
	GEV No.	101136	Ref. No. —
	piezoelectric igniter suitable for Minisit with cover cap ømm connection F6.3x0.8		
	GEV No.	101137	Ref. No. G652202
	cover cap without piezoelectric igniter		
	GEV No.	101267	Ref. No. —
	reducer IT 3/8" ET 1/2" L 21mm		
	GEV No.	101268	Ref. No. —
	gas connection thread 3/8" angled with O-ring MINISIT 710		
	GEV No.	101269	Ref. No. —
	gas connection thread 1/2" angled with O-ring MINISIT 710		
	GEV No.	101270	Ref. No. —
	screw connection IT 3/8" ET 3/8" L 28mm		
	GEV No.	101272	Ref. No. —
	screw connection IT 1/2" ET 3/8" L 57mm		
	GEV No.	101273	Ref. No. —
	olive for pipe ø 12mm L 9.5mm brass Qty 1 pcs suitable for universal		

accessories for	101130		
	GEV No.	101274	Ref. No. —
	olive for pipe ø 16mm Qty 1 pcs		
	GEV No.	101275	Ref. No. —
	union screw thread 1/2" for pipe ø 16mm Qty 1 pcs		
	GEV No.	101276	Ref. No. —
	union screw thread 3/8" tube ø 12mm Qty 1 pcs		
	GEV No.	110068	Ref. No. G652225
	knob suitable for Minisit ø 37mm		

GEV No.	107237	Ref. No.	G652004
description	gas thermostat without cap, button and angle SIT type MINISIT 710 t.max. 210°C 70-210°C gas inlet 1/2" gas outlet 3/8" thermocouple connection M9x1 pilot connection M10x1 probe ø 4mm probe L 122mm capillary pipe 1300mm probe type pressure controller no pressure regulator gland nut		
accessories for	107237		
	GEV No.	101137	Ref. No. G652202
	cover cap without piezoelectric igniter		
	GEV No.	101267	Ref. No. —
	reducer IT 3/8" ET 1/2" L 21mm		
	GEV No.	101268	Ref. No. —
	gas connection thread 3/8" angled with O-ring MINISIT 710		
	GEV No.	110068	Ref. No. G652225
	knob suitable for Minisit ø 37mm		

STN3R



GEV No.	106208	Ref. No.	G652013
description	gas thermostat t.max. 200°C gas inlet 1/2" gas outlet 1/2" probe ø 6mm probe L 120mm capillary pipe 1200mm STN3R		
spare parts for	106208		
	GEV No.	106211	Ref. No. G652220
	knob suitable for STN3R		

Table continues overleaf





spare parts for 106208			
	GEV No.	106212	Ref. No. G652221
knob suitable for STN3R			



GEV No.	106209	Ref. No.	G652012
description	gas thermostat t.max. 300°C gas inlet 1/2" gas outlet 1/2" probe ø 6.5mm probe L 80mm capillary pipe 1200mm STN3R		
spare parts for 106209			
	GEV No.	106211	Ref. No. G652220
knob suitable for STN3R			
	GEV No.	106212	Ref. No. G652221
knob suitable for STN3R			



GEV No.	106210	Ref. No.	G652016
description	gas thermostat t.max. 450°C gas inlet 1/2" gas outlet 1/2" probe ø 6.5mm probe L 250mm capillary pipe 1200mm STN3R		
spare parts for 106210			
	GEV No.	106211	Ref. No. G652220
knob suitable for STN3R			
	GEV No.	106212	Ref. No. G652221
knob suitable for STN3R			







gas valves and ignition boxes

gas control valves









SIT











ELETTROSIT





GEV No.	101124	Ref. No.	G652401
description	gas valve SIT type ELETTROSIT 230V gas inlet 3/4" gas outlet 3/4" thermocouple connection M9x1 pilot connection M10x1 bottom equiv. no. 0.810.122		
spare parts for 101124			
	GEV No.	101312	Ref. No. —
microswitch			
	GEV No.	101352	Ref. No. —
solenoid coil 230V 50Hz suitable for ELETTROSIT			
accessories for 101124			
	GEV No.	100006	Ref. No. —
piezoelectric igniter suitable for ELETTROSIT body plastic blowing connection ø2.4mm ø 14mm			
	GEV No.	100904	Ref. No. —
locking screw M10x1 for pipe ø 4mm Qty 1 pcs			
	GEV No.	100905	Ref. No. —
locking screw M10x1 for pipe ø 6mm Qty 1 pcs			
	GEV No.	101301	Ref. No. —
gas connection thread 1/2" straight ELETTROSIT screw with O-ring			
	GEV No.	101303	Ref. No. —
gas connection straight thread 3/4" ELETTROSIT			
	GEV No.	101309	Ref. No. —
extension			

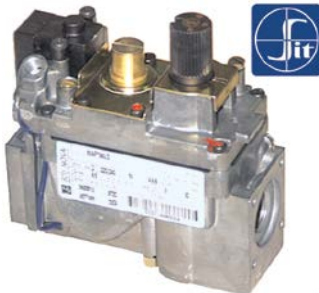

			
1			
GEV No.	101127	Ref. No.	G652405
description	gas valve SIT type ELETTROSIT 230V gas inlet 3/4" gas outlet 3/4" thermocouple connection M9x1 pilot connection M10x1 lateral equiv. no. 0.810.175		
spare parts for	101127		
	GEV No.	101312	Ref. No. —
	microswitch		
	GEV No.	101352	Ref. No. —
	solenoid coil 230V 50Hz suitable for ELETTROSIT		
accessories for	101127		
	GEV No.	100006	Ref. No. —
	piezoelectric igniter suitable for ELETTROSIT body plastic blowing connection ø2.4mm ø 14mm		
	GEV No.	100904	Ref. No. —
	locking screw M10x1 for pipe ø 4mm Qty 1 pcs		
	GEV No.	100905	Ref. No. —
	locking screw M10x1 for pipe ø 6mm Qty 1 pcs		
	GEV No.	101301	Ref. No. —
	gas connection thread 1/2" straight ELETTROSIT screw with O-ring		
	GEV No.	101303	Ref. No. —
	gas connection straight thread 3/4" ELETTROSIT		
	GEV No.	101309	Ref. No. —
	extension		

spare parts for	101162		
	GEV No.	101313	Ref. No. —
	solenoid coil 230V 50Hz		
accessories for	101162		
	GEV No.	100006	Ref. No. —
	piezoelectric igniter suitable for ELETTROSIT body plastic blowing connection ø2.4mm ø 14mm		
	GEV No.	101305	Ref. No. G653033
	gas connection straight 1/2" flange 45x45mm ELETTROSIT/V4400/4600/4605 suitable for SIT/HONEYWELL hole distance 36x36mm		
	GEV No.	101306	Ref. No. G652031
	gas connection angled flange 45x45mm hole distance 36x36mm 1/2" ELETTROSIT/V4400/4600/4605 screw with O-ring suitable for SIT/HONEYWELL		
	GEV No.	101307	Ref. No. —
	gas connection straight flange 45x45mm hole distance 36x36mm 3/4" ELETTROSIT/V4400/4600/4605 screw with O-ring suitable for SIT/HONEYWELL		
	GEV No.	101308	Ref. No. G653032
	gas connection angled flange 45x45mm hole distance 36x36mm 3/4" ELETTROSIT/V4400/4600/4605 screw with O-ring suitable for SIT/HONEYWELL		
	GEV No.	101312	Ref. No. —
	microswitch		
	GEV No.	101314	Ref. No. —
	solenoid coil 24V 50Hz		
	GEV No.	101317	Ref. No. G653035
	plug with cable L 1000mm suitable for NOVASIT		
	GEV No.	101318	Ref. No. —
	cover cap for solenoid coil suitable for NOVASIT		

NOVASIT			
			
1			
GEV No.	101162	Ref. No.	G653030
description	gas valve SIT series Novasit 820 230V 50Hz gas inlet 1/2" gas outlet 1/2" thermocouple connection M9x1 pilot connection M10x1 ignition pressure 3-5mbar pressure range 3-30mbar pressure regulator connection blind equiv. no. 0.820.010		
spare parts for	101162		
	GEV No.	101065	Ref. No. —
	magnet unit with cable L 44mm D1 ø 30mm D2 ø 20mm suitable for NOVASIT		

















			
1			
GEV No.	101908	Ref. No.	G653028
description	gas valve SIT series Novasit 820 230V 50Hz gas inlet 1/2" gas outlet 1/2" thermocouple connection M9x1 pilot connection M10x1 ignition pressurebar pressure regulator connection blind equiv. no. 0.820.018 output pilot burner M10x1 input pressure max. 60bar setting range 3-30bar		
For models:	W381035, W384121, W384122, W385021, W385022, W385023, W385024, W385025		
spare parts for	101908		
	GEV No.	101065	Ref. No. —
	magnet unit with cable L 44mm D1 ø 30mm D2 ø 20mm suitable for NOVASIT		
	GEV No.	101313	Ref. No. —
	solenoid coil 230V 50Hz		



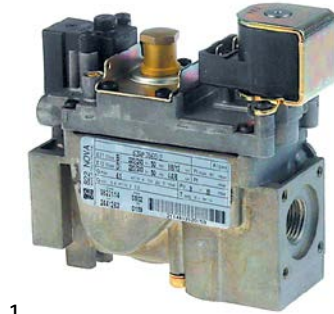

Table continues overleaf





accessories for		101908	
	GEV No.	100006	Ref. No. —
piezoelectric igniter suitable for ELETTROSIT body plastic blowing connection \varnothing 2.4mm \varnothing 14mm			
	GEV No.	101305	Ref. No. G653033
gas connection straight 1/2" flange 45x45mm ELETTROSIT/V4400/4600/4605 suitable for SIT/HONEYWELL hole distance 36x36mm			
	GEV No.	101306	Ref. No. G652031
gas connection angled flange 45x45mm hole distance 36x36mm 1/2" ELETTROSIT/V4400/4600/4605 screw with O-ring suitable for SIT/HONEYWELL			
	GEV No.	101307	Ref. No. —
gas connection straight flange 45x45mm hole distance 36x36mm 3/4" ELETTROSIT/V4400/4600/4605 screw with O-ring suitable for SIT/HONEYWELL			
	GEV No.	101308	Ref. No. G653032
gas connection angled flange 45x45mm hole distance 36x36mm 3/4" ELETTROSIT/V4400/4600/4605 screw with O-ring suitable for SIT/HONEYWELL			
	GEV No.	101312	Ref. No. —
microswitch			
	GEV No.	101314	Ref. No. —
solenoid coil 24V 50Hz			
	GEV No.	101317	Ref. No. G653035
plug with cable L 1000mm suitable for NOVASIT			
	GEV No.	101318	Ref. No. —
cover cap for solenoid coil suitable for NOVASIT			





accessories for		101914	
	GEV No.	101914	Ref. No. G653026
description gas valve SIT series Novasit 822 230V 50Hz gas inlet 1/2" gas outlet 1/2" thermocouple connection pilot connection closed ignition pressure range 3-30mbar pressure regulator connection blind equiv. no. 0.822.144			
spare parts for 101914			
	GEV No.	101313	Ref. No. —
solenoid coil 230V 50Hz			
	GEV No.	101542	Ref. No. —
solenoid coil 50Hz NOVA 822/826/827 suitable for NOVASIT 230V			
accessories for 101914			
	GEV No.	101305	Ref. No. G653033
gas connection straight 1/2" flange 45x45mm ELETTROSIT/V4400/4600/4605 suitable for SIT/HONEYWELL hole distance 36x36mm			
	GEV No.	101306	Ref. No. G652031
gas connection angled flange 45x45mm hole distance 36x36mm 1/2" ELETTROSIT/V4400/4600/4605 screw with O-ring suitable for SIT/HONEYWELL			

accessories for		101914	
	GEV No.	101307	Ref. No. —
gas connection straight flange 45x45mm hole distance 36x36mm 3/4" ELETTROSIT/V4400/4600/4605 screw with O-ring suitable for SIT/HONEYWELL			
	GEV No.	101308	Ref. No. G653032
gas connection angled flange 45x45mm hole distance 36x36mm 3/4" ELETTROSIT/V4400/4600/4605 screw with O-ring suitable for SIT/HONEYWELL			
	GEV No.	101503	Ref. No. —
O-ring EPDM thickness 2mm ID \varnothing 32mm Qty 1 pcs			
	GEV No.	101924	Ref. No. —
plug with cable L 1090mm suitable for NOVA 822/826/827			

accessories			
	1		
GEV No.	101306	Ref. No.	G652031
description	gas connection angled flange 45x45mm hole distance 36x36mm 1/2" ELETTROSIT/V4400/4600/4605 screw with O-ring suitable for SIT/HONEYWELL		
spare parts for 101306			
	GEV No.	517104	Ref. No. —
O-ring EPDM thickness 2.62mm ID \varnothing 31.42mm Qty 1 pcs			

	1		
GEV No.	101308	Ref. No.	G653032
description	gas connection angled flange 45x45mm hole distance 36x36mm 3/4" ELETTROSIT/V4400/4600/4605 screw with O-ring suitable for SIT/HONEYWELL		
For models:	W384121, W384122		

	1		
GEV No.	101305	Ref. No.	G653033
description	gas connection straight 1/2" flange 45x45mm ELETTROSIT/V4400/4600/4605 suitable for SIT/HONEYWELL hole distance 36x36mm		
spare parts for 101305			
	GEV No.	101503	Ref. No. —
O-ring EPDM thickness 2mm ID \varnothing 32mm Qty 1 pcs			

	1		
GEV No.	101674	Ref. No.	G653037
description	knob extension L 57mm NOVA 822/826/827		



			
1			
GEV No.	101317	Ref. No.	G653035
description	plug with cable L 1000mm suitable for NOVASIT		
For models:	W381035, W384121, W384122, W385021, W385022, W385023, W385024, W385025		

			
1			
GEV No.	109128	Ref. No.	G653040
description	pressure controller brass L 25mm ø 11.5mm thread M13x1 for gas valve suitable for gas valves Qty 1 pcs		
For models:	W381035, W384121, W384122, W385021, W385022, W385023, W385024, W385025		

safety valves

SIT				
440 series				
				
1				
GEV No.	101101	Ref. No.	G652415	
description	gas valve pressure range 50mbar gas inlet 3/4" gas outlet 3/4" pilot connection M10x1 (tube ø 6mm) thermocouple connection M9x1 type SIT D3			
accessories for	101101			
	GEV No.	100904	Ref. No.	—
locking screw M10x1 for pipe ø 4mm Qty 1 pcs				
	GEV No.	100905	Ref. No.	—
locking screw M10x1 for pipe ø 6mm Qty 1 pcs				

gas solenoid valves

ASCO			
			
1			
GEV No.	370710	Ref. No.	E131002
description	solenoid valve gas 2-ways 230VAC inlet 1/8" outlet 1/8" t.max. 60°C connection 1/8" L 33mm Asco coil type 400127-197 p max 15bar membranes FPM type series 256 overall height 53mm		
For models:	W381035, W384121, W384122		

ignition parts

pilot burners









SIT				
100 series				
				
1				
GEV No.	106906	Ref. No.	G207510	
description	pilot burner SIT type 100 series 3 flames nozzle ø 0.2mm gas connection 6mm			
spare parts for	106906			
	GEV No.	100245	Ref. No.	—
pilot burner nozzle LPG code 20 bore ø 0.2mm Qty 1 pcs thread M8x0.75				
	GEV No.	100855	Ref. No.	—
pilot burner bracket triple				
	GEV No.	100885	Ref. No.	—
air mixing sleeve for pilot burner Qty 1 pcs				
	GEV No.	100916	Ref. No.	—
compression spring for pilot burner Qty 1 pcs				
	GEV No.	100917	Ref. No.	—
gasket for pilot burner Qty 1 pcs aluminium				
	GEV No.	100918	Ref. No.	—
screw for pilot burner				
	GEV No.	107162	Ref. No.	—
pilot burner cap SIT 3 flames Hmm Lmm Qty 1 pcs				
	GEV No.	107701	Ref. No.	—
pilot burner bottom part SIT 100 series nozzle ø 0.2mm				

Table continues overleaf



accessories for		106906	
	GEV No.	100245	Ref. No. —
pilot burner nozzle LPG code 20 bore ø 0.2mm Qty 1 pcs thread M8x0.75			
	GEV No.	100246	Ref. No. —
pilot burner nozzle natural gas bore ø 0.35mm Qty 1 pcs thread M8x0.75			
	GEV No.	100904	Ref. No. —
locking screw M10x1 for pipe ø 4mm Qty 1 pcs			
	GEV No.	100905	Ref. No. —
locking screw M10x1 for pipe ø 6mm Qty 1 pcs			
	GEV No.	102110	Ref. No. —
pilot tube copper pipe ø 4mm thickness 1mm L 3000mm			
	GEV No.	102111	Ref. No. B400106
pilot tube copper pipe ø 6mm thickness 1mm L 3000mm			
	GEV No.	107171	Ref. No. —
pilot burner nozzle SIT natural/liquid gas bore ø 0.25mm Qty 1 pcs			
	GEV No.	107700	Ref. No. —
pilot burner bottom part SIT 100 series nozzle ø 0.25mm			
	GEV No.	107702	Ref. No. —
pilot burner bottom part SIT 100 series nozzle ø 0.35mm			

accessories

ignition electrodes

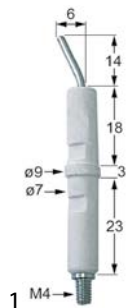



GEV No.	100706	Ref. No.	G207511
description	ignition electrode connection M4 Qty 1 pcs		

HONEYWELL



pilot burners

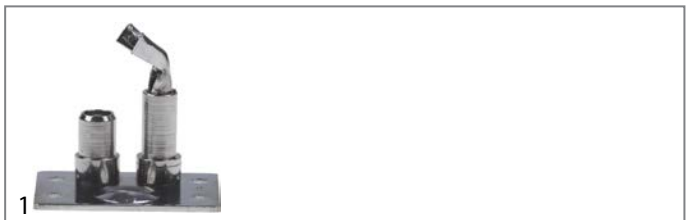

GEV No.	102886	Ref. No.	G207529+G207532
description	pilot burner 1 flame		
accessories for	102886		
	GEV No.	102888	Ref. No. —
pilot burner nozzle HONEYWELL natural gas bore ø 0.51mm model Q349			

accessories for		102886	
	GEV No.	102889	Ref. No. G206925
pilot burner nozzle HONEYWELL LPG bore ø 0.25mm model Q349			
	GEV No.	102892	Ref. No. G207534
ignition electrode D1 ø 6mm L1 22mm BL1 25mm BL2 19mm connection F 2.8x0.8mm M8x10			





GEV No.	106939	Ref. No.	G207529
description	pilot burner HONEYWELL type Q349A1124 1 Typ 27		
For models:	W380111, W380112, W380121, W380122, W380131, W380132, W380141, W380142, W380151, W380152, W380161, W380162, W380261, W380411, W380413, W380421, W380423, W380431, W380433, W380441, W380443, W380451, W380461, W380666, W380912, W380915, W380917, W380919, W380922, W380925, W380927, W380929, W380932, W380935, W380937, W380939, W380942, W380945, W380947, W380949, W381035, W381515, W381525, W381535, W381545, W381815, W381825, W381835, W382511, W382551...(Other models you can see in the webshop)		
accessories for	106939		
	GEV No.	102905	Ref. No. G207532
locking screw thread M11x1 ø 6mm			
	GEV No.	106938	Ref. No. G206932
pilot burner nozzle HONEYWELL natural gas code 0.51 model Q349			

AEM

pilot burners



GEV No.	102480	Ref. No.	G207523
description	pilot burner 1 flame gas connection 6mm mounting thread M4		
accessories for	102480		
	GEV No.	106427	Ref. No. G206942
pilot burner nozzle natural/liquid gas bore ø 0.3mm code 30 thread 7/32" (28G) WS 6			
	GEV No.	106428	Ref. No. G206944
pilot burner nozzle LPG bore ø 0.25mm code 25 thread 7/32" (28G) WS 6			





1

GEV No.	102481	Ref. No.	G207522
description	pilot burner 1 flame gas connection 6mm mounting thread M4		
For models:	W380111, W380112, W380121, W380122, W380131, W380132, W380141, W380142, W380151, W380152, W380161, W380162, W380211, W380221, W380231, W380241, W380251, W380261, W380511, W380521, W380531, W380541, W382511, W382551, W382552, W382561, W382562, W382611, W382651, W382652, W382661, W382662		
accessories for	102481		
	GEV No.	106429	Ref. No. G206946
	pilot burner nozzle natural gas bore \varnothing 0.35mm thread M5x0.75 WS 6		
	GEV No.	107244	Ref. No. G206947
	pilot burner nozzle LPG code 20 bore \varnothing 0.2mm thread M5x0.75 Qty 1 pcs brass		



1



GEV No.	102481	Ref. No.	G207522
description	pilot burner 1 flame gas connection 6mm mounting thread M4		
For models:	W380111, W380112, W380121, W380122, W380131, W380132, W380141, W380142, W380151, W380152, W380161, W380162, W380211, W380221, W380231, W380241, W380251, W380261, W380511, W380521, W380531, W380541, W382511, W382551, W382552, W382561, W382562, W382611, W382651, W382652, W382661, W382662		
accessories for	102481		
	GEV No.	106429	Ref. No. G206946
	pilot burner nozzle natural gas bore \varnothing 0.35mm thread M5x0.75 WS 6		
	GEV No.	107244	Ref. No. G206947
	pilot burner nozzle LPG code 20 bore \varnothing 0.2mm thread M5x0.75 Qty 1 pcs brass		

producer-specific pilot burners

CAPIC



1

GEV No.	102480	Ref. No.	G207523
description	pilot burner 1 flame gas connection 6mm mounting thread M4		
accessories for	102480		
	GEV No.	106427	Ref. No. G206942
	pilot burner nozzle natural/liquid gas bore \varnothing 0.3mm code 30 thread 7/32" (28G) WS 6		
	GEV No.	106428	Ref. No. G206944
	pilot burner nozzle LPG bore \varnothing 0.25mm code 25 thread 7/32" (28G) WS 6		

electrodes

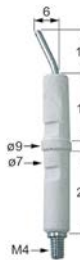

1

GEV No.	100706	Ref. No.	G207511
description	ignition electrode connection M4 Qty 1 pcs		

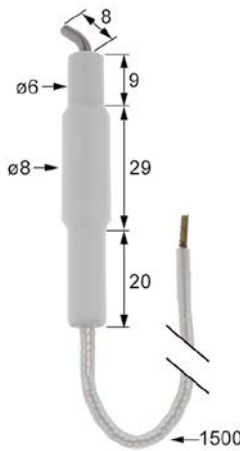

1

GEV No.	107788	Ref. No.	G207554
description	ignition electrode D1 \varnothing 6mm D2 \varnothing 8mm L1 6mm BL1 9mm BL2 29mm BL3 20mm cable length 1500mm connection \varnothing 1.5mm		

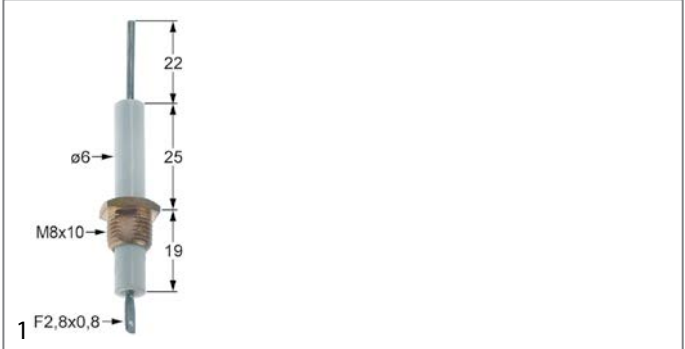

GEV No.	102892	Ref. No.	G207534
description	ignition electrode D1 ø 6mm L1 22mm BL1 25mm BL2 19mm connection F 2.8x0.8mm M8x10		
For models:	W380111, W380112, W380121, W380122, W380131, W380132, W380141, W380142, W380151, W380152, W380161, W380162, W380261, W380411, W380413, W380421, W380423, W380431, W380433, W380441, W380443, W380451, W380461, W380666, W380912, W380915, W380917, W380919, W380922, W380925, W380927, W380929, W380932, W380935, W380937, W380939, W380942, W380945, W380947, W380949, W381035, W381515, W381525, W381535, W381545, W381815, W381825, W381835, W382511, W382511...(Other models you can see in the webshop)		



GEV No.	102907	Ref. No.	G101030
description	ignition electrode D1 ø 7mm connection F 2.8x0.8mm L1 6mm L2 6mm L3 16mm BL1 50mm to clip		
For models:	W380111, W380112, W380121, W380122, W380131, W380132, W380141, W380142, W380151, W380152, W380161, W380162, W380211, W380221, W380231, W380241, W380251, W380261, W380511, W380521, W380531, W380541, W382511, W382551, W382552, W382561, W382562, W382611, W382651, W382652, W382661, W382662		

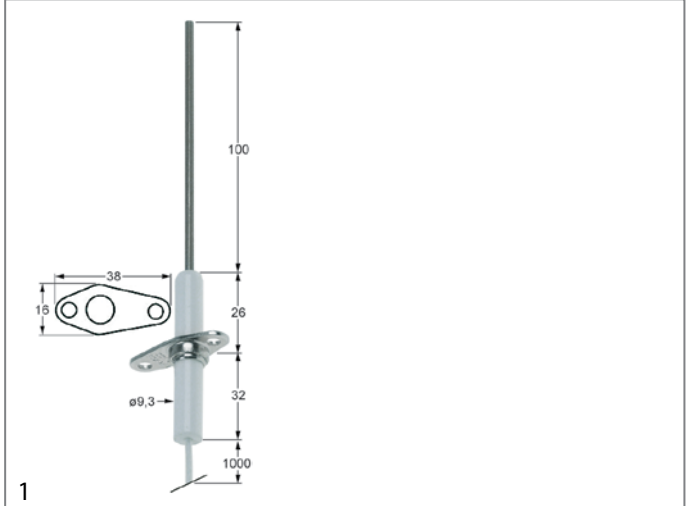

GEV No.	104448	Ref. No.	G207536
description	ignition electrode flange length 38mm flange width 16mm D1 ø 9.3mm L1 100mm BL1 26mm BL2 32mm cable length 1000mm mounting distance 28mm		

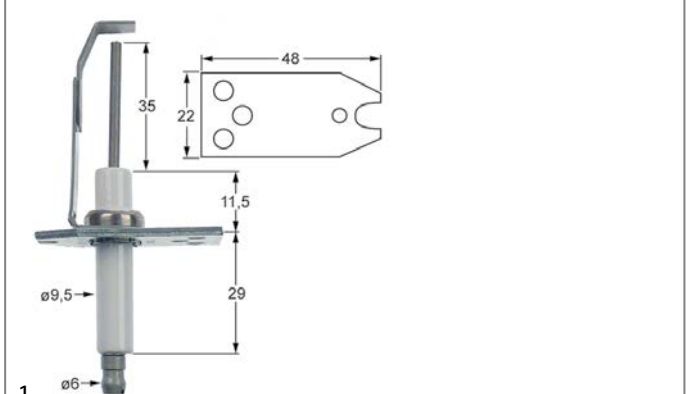



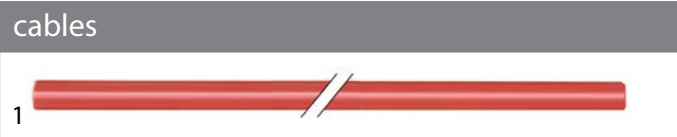

GEV No.	104637	Ref. No.	G101034
description	ignition electrode flange length 48mm flange width 23mm D1 ø 9.5mm L1 35mm BL1 11.5mm BL2 32mm fixing dimensions ø5.5x4.5mm/ø4.5mm flange connection ø 6mm		

ignition cables



GEV No.	100027	Ref. No.	E351610
description	ignition cable Qty 5m 0.34mm ² ED ø 3mm insulation glass fibre t.max. 180°C		

accessories for	100027			
	GEV No.	100021	Ref. No.	—
	female faston size 2.8x0.8mm 0.5-1.0mm ² CuZn t.max. 125°C Qty 20 pcs			
	GEV No.	100022	Ref. No.	—
	female faston size 6.3x0.8mm 0.5-1.0mm ² CuZn t.max. 125°C Qty 20 pcs			
	GEV No.	100023	Ref. No.	—
	female bullet size 2.3mm 0.5-1.5mm ² CuZn t.max. 125°C Qty 20 pcs			
	GEV No.	100024	Ref. No.	—
	female bullet size 4mm 0.25-1.5mm ² CuZn t.max. 125°C Qty 20 pcs			



piezoelectric igniters

miscellaneous



GEV No.	nl ¹	Ref. No.	E050504
description	piezoelectric igniter suitable for Minisit connection F6.3x0.8 ømm		

¹no longer available

ignition units



GEV No.	102485	Ref. No.	E050505
description	ignition unit outputs 2 220-240VAC 0.6VA 50-60Hz		
For models:	W380161, W380162, W380261, W380413, W380423, W380433, W380443, W380461, W380511, W380521, W380531, W380541, W380666, W380912, W380915, W380917, W380919, W380922, W380925, W380927, W380929, W380932, W380935, W380937, W380939, W380942, W380945, W380947, W380949, W381035, W381515, W381525, W381535, W381545, W381815, W381825, W381835, W382561, W382562, W382661, W382662, W383061, W384022, W384121, W384122, W385021, W385022, W385023, W385024, W385025		



GEV No.	102389	Ref. No.	E050506
description	ignition unit outputs 6 230VAC dimensions 135x23x34mm mounting distance 123mm inlet F6.3x0.8 outlet F2.8x0.8 0.6VA 50/60Hz		
For models:	W380111, W380112, W380121, W380122, W380131, W380132, W380141, W380142, W380151, W380152, W380161, W380162, W380211, W380221, W380231, W380241, W380251, W380261, W380411, W380421, W380431, W380441, W380451, W380461, W382511, W382551, W382552, W382561, W382562, W382611, W382651, W382652, W382661, W382662		

thermocouples

thermocouple sets universal



GEV No.	102284	Ref. No.	G401005
description	thermocouple set 8-piece L 900mm		
For models:	W380111, W380112, W380121, W380122, W380131, W380132, W380141, W380142, W380151, W380152, W380161, W380162, W380261, W380411, W380413, W380421, W380423, W380431, W380433, W380441, W380443, W380451, W380461, W380666, W380912, W380915, W380917, W380919, W380922, W380925, W380927, W380929, W380932, W380935, W380937, W380939, W380942, W380945, W380947, W380949, W381035, W381515, W381525, W381535, W381545, W381815, W381825, W381835, W382511, W382551...(Other models you can see in the webshop)		

plug-in thermocouples

plug-in thermocouples standard

with barrel socket ø6(6.5)mm

thermocouples SIT

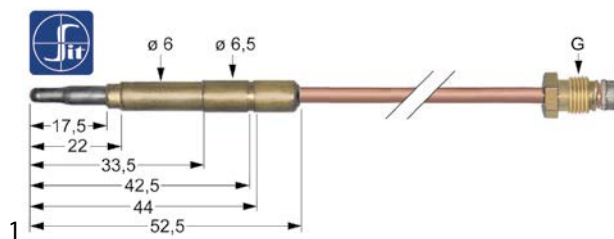

GEV No.	107611	Ref. No.	G401030
description	thermocouple SIT M9x1 L 850mm plug connection ø6.0(6.5)mm		
For models:	W380111, W380112, W380121, W380122, W380131, W380132, W380141, W380142, W380151, W380152, W380161, W380162, W380211, W380221, W380231, W380241, W380251, W380261, W380511, W380521, W380531, W380541, W382511, W382551, W382552, W382561, W382562, W382611, W382651, W382652, W382661, W382662		

gas burners

hob burners

producer-specific hob burners

CAPIC

1200 series



GEV No.	108099	Ref. No.	G205514
description	venturi L 153mm size 4/5 thread M18x1.5 complete		
For models:	W380111, W380121, W380131, W380141, W380151, W380161, W380211, W380221, W380231, W380241, W380251, W380261, W380511, W380521, W380531, W380541, W382511, W382551, W382552, W382561, W382562, W382611, W382651, W382652, W382661, W382662		



851 series



1

GEV No.	107067	Ref. No.	N/A
----------------	--------	-----------------	-----

description	burner type 851 ø 120mm L 120mm complete
--------------------	--



1

GEV No.	107068	Ref. No.	G200520
----------------	--------	-----------------	---------

description	burner type 851 ø 120mm L 175mm complete
--------------------	--



1

GEV No.	108043	Ref. No.	N/A
----------------	--------	-----------------	-----

description	burner head ø 120mm seat ø 114mm with central hole
--------------------	--



1

GEV No.	108017	Ref. No.	G204035
----------------	--------	-----------------	---------

description	burner head ø 120mm seat ø 39mm
--------------------	---------------------------------



1

GEV No.	108016	Ref. No.	G204037
----------------	--------	-----------------	---------

description	burner ring ø 115mm
--------------------	---------------------

854 series



1

GEV No.	108004	Ref. No.	N/A
----------------	--------	-----------------	-----

description	burner cap ø 78mm 5kW mounting ø 72mm
--------------------	---------------------------------------

accessories for	108004
------------------------	--------



GEV No.	108003	Ref. No.	G204006
description	burner head for burner cap ø 78mm seat ø 35mm ID ø 30mm ED ø 83mm		



1

GEV No.	108003	Ref. No.	G204006
----------------	--------	-----------------	---------

description	burner head for burner cap ø 78mm seat ø 35mm ID ø 30mm ED ø 83mm
--------------------	---

accessories for	108003
------------------------	--------



1

GEV No.	108004	Ref. No.	N/A
----------------	--------	-----------------	-----

description	burner cap ø 78mm 5kW mounting ø 72mm
--------------------	---------------------------------------

860 series



1

GEV No.	107008	Ref. No.	G200510
----------------	--------	-----------------	---------

description	burner type 860 ø 80mm complete
--------------------	---------------------------------



1

GEV No.	107042	Ref. No.	N/A
----------------	--------	-----------------	-----

description	burner type 860 ø 80mm L 175mm complete
--------------------	---



1

GEV No.	108006	Ref. No.	G204030
----------------	--------	-----------------	---------

description	burner head ø 80mm mounting ø 32mm
--------------------	------------------------------------



1

GEV No.	108005	Ref. No.	G204032
----------------	--------	-----------------	---------

description	burner ring ø 72mm
--------------------	--------------------

861 series





1



GEV No.	107009	Ref. No.	N/A
----------------	--------	-----------------	-----

description	burner type 861 ø 80mm L 185mm complete
--------------------	---





			
1			
GEV No.	108000	Ref. No.	G204007 G204060
description	burner cap ø 78mm		

			
1			
GEV No.	108078	Ref. No.	G204012 G204027
description	burner cap ø 98mm mounting ø 97mm		

			
1			
GEV No.	108010	Ref. No.	G204060
description	burner cap ø 78mm		
For models:	W380111, W380112, W380121, W380122, W380131, W380132, W380141, W380142, W380151, W380152, W380161, W380162, W380211, W380221, W380231, W380241, W380251, W380261, W380511, W380521, W380531, W380541, W382511, W382551, W382552, W382561, W382562, W382611, W382651, W382652, W382661, W382662		
accessories for	108010		
	GEV No.	108003	Ref. No.
			G204006
	burner head for burner cap ø 78mm seat ø 35mm ID ø 30mm ED ø 83mm		

			
1			
GEV No.	108014	Ref. No.	G204011
description	burner head ø 100mm seat ø 97mm		

			
1			
GEV No.	108056	Ref. No.	G205010
description	burner lower part size 6		

			
1			
GEV No.	108003	Ref. No.	G204006
description	burner head for burner cap ø 78mm seat ø 35mm ID ø 30mm ED ø 83mm		
accessories for	108003		
	GEV No.	108004	Ref. No.
			N/A
	burner cap ø 78mm 5kW mounting ø 72mm		

951 series			
			
1			
GEV No.	107019	Ref. No.	G201025
description	burner type 951 ø 120mm L 215mm complete		
For models:	W380111, W380112, W380121, W380122, W380131, W380132, W380141, W380142, W380151, W380152, W380161, W380162, W380411, W380413, W380421, W380423, W380431, W380433, W380441, W380443, W380451, W380461, W382511, W382551, W382552, W382561, W382562		

			
1			
GEV No.	108056	Ref. No.	G205010
description	burner lower part size 6		

			
1			
GEV No.	107194	Ref. No.	G201035
description	burner type 951 ø 120mm L 245mm complete		

862 series			
			
1			
GEV No.	107119	Ref. No.	G205020 G205515
description	burner type 862 ø 100mm L 185mm complete		

			
1			
GEV No.	107020	Ref. No.	N/A
description	burner type 951 ø 120mm L 275mm complete		





			
1			
GEV No.	108018	Ref. No.	G204055
description	burner cap ø 120mm with central hole		

			
1			
GEV No.	108046	Ref. No.	N/A
description	burner head ø 120mm seat ø 114mm with central hole		

956 series			
			
1			
GEV No.	108022	Ref. No.	G204040
description	burner ø 120mm thread 1" IT		

			
1			
GEV No.	107023	Ref. No.	G201010
description	burner type 956 ø 120mm complete		

			
1			
GEV No.	108017	Ref. No.	G204035
description	burner head ø 120mm seat ø 39mm		

			
1			
GEV No.	108025	Ref. No.	N/A
description	burner head ø 120mm thread 1" IT		

			
1			
GEV No.	108016	Ref. No.	G204037
description	burner ring ø 115mm		

1027 series			
			
1			
GEV No.	107013	Ref. No.	G201018
description	burner type 1027 ø 90mm L 125mm complete		

1028 series			
			
1			
GEV No.	107022	Ref. No.	N/A
description	burner type 1028 ø 120mm L 225mm complete		



			
1			
GEV No.	108020	Ref. No.	N/A
description	burner cap ø 120mm with central hole		



1029 series			
			
1			
GEV No.	107088	Ref. No.	N/A
description	burner type 1029 ø 140mm L 295mm complete		



			
1			
GEV No.	108086	Ref. No.	N/A
description	burner cap ø 140mm with central hole		

			
1			
GEV No.	108049	Ref. No.	N/A
description	burner head ø 142mm seat ø 134mm with central hole		



1030 series			
			
1			
GEV No.	107090	Ref. No.	G201032
description	burner type 1030 ø 200mm L 265mm complete		
accessories for	107090		
	GEV No.	106544	Ref. No. G206540
	gas injector thread 3/8" WS 17 bore ø 2.2mm		
	GEV No.	106556	Ref. No. G206558
	gas injector thread 3/8" WS 17 bore ø 3.3mm		

5000 series			
			
1			
GEV No.	108010	Ref. No.	G204060
description	burner cap ø 78mm		
For models:	W380111, W380112, W380121, W380122, W380131, W380132, W380141, W380142, W380151, W380152, W380161, W380162, W380211, W380221, W380231, W380241, W380251, W380261, W380511, W380521, W380531, W380541, W382511, W382551, W382552, W382561, W382562, W382611, W382651, W382652, W382661, W382662		
accessories for	108010		
	GEV No.	108003	Ref. No. G204006
	burner head for burner cap ø 78mm seat ø 35mm ID ø 30mm ED ø 83mm		

			
1			
GEV No.	107324	Ref. No.	G204062
description	burner head ø 119mm for burner cap ø 78mm		
For models:	W380111, W380112, W380121, W380122, W380131, W380132, W380141, W380142, W380151, W380152, W380161, W380162, W380211, W380221, W380231, W380241, W380251, W380261, W380511, W380521, W380531, W380541, W382511, W382551, W382552, W382561, W382562, W382611, W382651, W382652, W382661, W382662		
accessories for	107324		
	GEV No.	108056	Ref. No. G205010
	burner lower part size 6		

pan supports			
			
1			
GEV No.	210044	Ref. No.	A251010
description	pan support L 300mm W 275mm cast iron		

solid tops			
			
1			
GEV No.	211096	Ref. No.	A254020 A254030
description	solid top ø 260mm H 18mm		

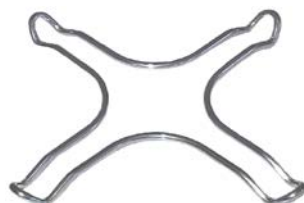
accessories			
reducers for pan supports			
			
1			
GEV No.	210001	Ref. No.	A300503
description	reducer for pan support L 265mm W 265mm SS suitable for universal		



bar burners

bar burners			
			
1			
GEV No.	109200	Ref. No.	G203010
description	bar burner 1-row L 410mm Wmm ø 50mm Hmm flange width 72mm flange length 75mm fryer		

			
1			
GEV No.	109104	Ref. No.	G203005
description	bar burner 1-row L 495mm Wmm ø 50mm Hmm flange width 72mm flange length 75mm fryer		

			
1			
GEV No.	109103	Ref. No.	G203015
description	bar burner 1-row L 650mm Wmm ø 50mm Hmm flange width 72mm flange length 75mm fryer		

ceramic burners

			
1			
GEV No.	105506	Ref. No.	G201045
description	ceramic burner L 585mm W 67mm firing range 549x38mm for salamander/chicken rotisserie		
accessories for	105506		
	GEV No.	100982	Ref. No. —
	gas injector thread M8x1 WS 12 bore ø 0.85mm		
	GEV No.	102953	Ref. No. —
	gas injector thread M8x1 WS 12 bore ø 1.1mm		

gas nozzles

main nozzles

gas nozzles 3/8"

			
1			
GEV No.	106532	Ref. No.	G206508
description	gas injector thread 3/8" WS 17 bore ø 1.1mm		
For models:	W381035		

			
1			
GEV No.	106534	Ref. No.	G206512
description	gas injector thread 3/8" WS 17 bore ø 1.2mm		
For models:	W380111, W380112, W380121, W380122, W380131, W380132, W380141, W380142, W380151, W380152, W380161, W380162, W380211, W380221, W380231, W380241, W380251, W380261, W380511, W380521, W380531, W380541, W382511, W382551, W382552, W382561, W382562, W382611, W382651, W382652, W382661, W382662		

			
1			
GEV No.	106535	Ref. No.	G206516
description	gas injector thread 3/8" WS 17 bore ø 1.3mm		

			
1			
GEV No.	106536	Ref. No.	G206520
description	gas injector thread 3/8" WS 17 bore ø 1.4mm		
For models:	W380111, W380112, W380121, W380122, W380131, W380132, W380141, W380142, W380151, W380152, W380161, W380162, W380411, W380413, W380421, W380423, W380431, W380433, W380441, W380443, W380451, W380461, W382511, W382551, W382552, W382561, W382562		

			
1			
GEV No.	106537	Ref. No.	G206524
description	gas injector thread 3/8" WS 17 bore ø 1.5mm		

			
1			
GEV No.	106538	Ref. No.	G206526
description	gas injector thread 3/8" WS 17 bore ø 1.6mm		

			
1			
GEV No.	106540	Ref. No.	G206532
description	gas injector thread 3/8" WS 17 bore ø 1.8mm		
For models:	W380111, W380112, W380121, W380122, W380131, W380132, W380141, W380142, W380151, W380152, W380161, W380162, W380211, W380221, W380231, W380241, W380251, W380261, W380511, W380521, W380531, W380541, W382511, W382551, W382552, W382561, W382562, W382611, W382651, W382652, W382661, W382662		

			
1			
GEV No.	106541	Ref. No.	G206534
description	gas injector thread 3/8" WS 17 bore ø 1.9mm		





			
1			
GEV No.	106531	Ref. No.	G206504
description	gas injector thread 3/8" WS 17 bore ø 1mm		

			
1			
GEV No.	106542	Ref. No.	G206536
description	gas injector thread 3/8" WS 17 bore ø 2mm		

			
1			
GEV No.	106543	Ref. No.	G206538
description	gas injector thread 3/8" WS 17 bore ø 2.1mm		
For models:	W380111, W380112, W380121, W380122, W380131, W380132, W380141, W380142, W380151, W380152, W380161, W380162, W380411, W380413, W380421, W380423, W380431, W380433, W380441, W380443, W380451, W380461, W382511, W382551, W382552, W382561, W382562		

			
1			
GEV No.	106556	Ref. No.	G206558
description	gas injector thread 3/8" WS 17 bore ø 3.3mm		

			
1			
GEV No.	106544	Ref. No.	G206540
description	gas injector thread 3/8" WS 17 bore ø 2.2mm		

			
1			
GEV No.	106553	Ref. No.	G206554
description	gas injector thread 3/8" WS 17 bore ø 3mm		

gas nozzles M10x1.5

			
1			
GEV No.	106545	Ref. No.	G206542
description	gas injector thread 3/8" WS 17 bore ø 2.3mm		

			
1			
GEV No.	196000	Ref. No.	G207212
description	gas injector thread M10x1.5 WS 14 bore ø 1.1mm		

			
1			
GEV No.	106547	Ref. No.	G206546
description	gas injector thread 3/8" WS 17 bore ø 2.5mm		

			
1			
GEV No.	106935	Ref. No.	G207240
description	gas injector thread M10x1.5 WS 14 bore ø 1.6mm		

			
1			
GEV No.	106551	Ref. No.	G206552
description	gas injector thread 3/8" WS 17 bore ø 2.8mm		

			
1			
GEV No.	106936	Ref. No.	G207248
description	gas injector thread M10x1.5 WS 14 bore ø 1.7mm		

			
1			
GEV No.	106937	Ref. No.	G207256
description	gas injector thread M10x1.5 WS 14 bore ø 1.8mm		

pilot burner nozzles

pilot burner nozzles AEM



GEV No.	106428	Ref. No.	G206944
description	pilot burner nozzle LPG bore ø 0.25mm code 25 thread 7/32" (28G) WS 6		



GEV No.	107767	Ref. No.	N/A
description	pilot burner nozzle LPG bore ø 0.2mm code 20 thread 7/32" (28G) WS 6		



GEV No.	106429	Ref. No.	G206946
description	pilot burner nozzle natural gas bore ø 0.35mm thread M5x0.75 WS 6		
For models:	W380111, W380112, W380121, W380122, W380131, W380132, W380141, W380142, W380151, W380152, W380161, W380162, W380211, W380221, W380231, W380241, W380251, W380261, W380461, W380511, W380521, W380531, W380541, W380666, W381035, W382511, W382551, W382552, W382561, W382562, W382611, W382651, W382652, W382661, W382662, W383061, W385023, W385024, W385025		



GEV No.	106427	Ref. No.	G206942
description	pilot burner nozzle natural/liquid gas bore ø 0.3mm code 30 thread 7/32" (28G) WS 6		

pilot burner nozzles HONEYWELL

for series Q349



GEV No.	102889	Ref. No.	G206925
description	pilot burner nozzle HONEYWELL LPG bore ø 0.25mm model Q349		
For models:	W380111, W380112, W380121, W380122, W380131, W380132, W380141, W380142, W380151, W380152, W380161, W380162, W380261, W380411, W380413, W380421, W380423, W380431, W380433, W380441, W380443, W380451, W380461, W380666, W380912, W380915, W380917, W380919, W380922, W380925, W380927, W380929, W380932, W380935, W380937, W380939, W380942, W380945, W380947, W380949, W381035, W381815, W381825, W381835, W382511, W382551, W382552, W382561, W382562, W382661...(Other models you can see in the webshop)		



GEV No.	106938	Ref. No.	G206932
description	pilot burner nozzle HONEYWELL natural gas code 0.51 model Q349		
For models:	W380111, W380112, W380121, W380122, W380131, W380132, W380141, W380142, W380151, W380152, W380161, W380162, W380261, W380411, W380413, W380421, W380423, W380431, W380433, W380441, W380443, W380451, W380461, W380666, W380912, W380915, W380917, W380919, W380922, W380925, W380927, W380929, W380932, W380935, W380937, W380939, W380942, W380945, W380947, W380949, W381035, W381815, W381825, W381835, W382511, W382551, W382552, W382561, W382562, W382661...(Other models you can see in the webshop)		

pilot burner nozzles (other)

SOLYMAC/CAPIC



GEV No.	107244	Ref. No.	G206947
description	pilot burner nozzle LPG code 20 bore ø 0.2mm thread M5x0.75 Qty 1 pcs brass		



GEV No.	106429	Ref. No.	G206946
description	pilot burner nozzle natural gas bore ø 0.35mm thread M5x0.75 WS 6		
For models:	W380111, W380112, W380121, W380122, W380131, W380132, W380141, W380142, W380151, W380152, W380161, W380162, W380211, W380221, W380231, W380241, W380251, W380261, W380461, W380511, W380521, W380531, W380541, W380666, W381035, W382511, W382551, W382552, W382561, W382562, W382611, W382651, W382652, W382661, W382662, W383061, W385023, W385024, W385025		

burner nozzles



GEV No.	102897	Ref. No.	G202010
description	burner nozzle LPG		



GEV No.	102896	Ref. No.	G202030
description	burner nozzle natural gas		



auxiliary gas parts

screw connections

olives



GEV No.	101248	Ref. No.	G701026
----------------	--------	-----------------	---------

description olive for pipe ø 12mm Qty 1 pcs suitable for PEL

accessories for 101248



GEV No.	101251	Ref. No.	—
----------------	--------	-----------------	---

union nut thread M20x1.5 for pipe ø 12mm



GEV No.	101286	Ref. No.	G701011
----------------	--------	-----------------	---------

description olive ID ø 6mm Qty 1 pcs

accessories for 101286



GEV No.	100909	Ref. No.	G701010
----------------	--------	-----------------	---------

union screw thread M10x1 for pipe ø 6mm Qty 1 pcs



GEV No.	101464	Ref. No.	—
----------------	--------	-----------------	---

union nut thread M12x1 for pipe ø 6mm

union screws



GEV No.	100909	Ref. No.	G701010
----------------	--------	-----------------	---------

description union screw thread M10x1 for pipe ø 6mm Qty 1 pcs

accessories for 100909



GEV No.	100898	Ref. No.	—
----------------	--------	-----------------	---

olive for pipe ø 6mm Qty 1 pcs for pilot burner



GEV No.	101286	Ref. No.	G701011
----------------	--------	-----------------	---------

olive ID ø 6mm Qty 1 pcs



GEV No.	101287	Ref. No.	—
----------------	--------	-----------------	---

olive for pipe ø 6mm Qty 1 pcs



GEV No.	101288	Ref. No.	—
----------------	--------	-----------------	---

olive for pipe ø 6mm L 6mm aluminium Qty 1 pcs ED ø 8.5mm

angle pieces



GEV No.	107323	Ref. No.	G700511
----------------	--------	-----------------	---------

description elbow screw joint T1: 1/8" ET T2: 1/8" ET tube ø 6mm WS 13 brass

For models: W380111, W380112, W380121, W380122, W380131, W380132, W380141, W380142, W380151, W380152, W380161, W380162, W380211, W380221, W380231, W380241, W380251, W380261, W380461, W380511, W380521, W380531, W380541, W380666, W380912, W380915, W380917, W380919, W380922, W380925, W380927, W380929, W380932, W380935, W380937, W380939, W380942, W380945, W380947, W380949, W381511, W381515, W381521, W381525, W381531, W381535, W381541, W381545, W382511, W382551...(Other models you can see in the webshop)



GEV No.	106940	Ref. No.	K781816
----------------	--------	-----------------	---------

description elbow screw joint T1: 3/8" T2: 1/2" tube ø 11/12/14mm

For models: W384121, W384122

accessories



GEV No.	107779	Ref. No.	SE120180
----------------	--------	-----------------	----------

description torch L 500mm ø 10mm

gas lines

pilot tubes

universal



GEV No.	102111	Ref. No.	B400106
----------------	--------	-----------------	---------

description pilot tube copper pipe ø 6mm thickness 1mm L 3000mm

equipment-specific units

for espresso machines

brewing units

filter holder gaskets

O-rings



GEV No.	510409	Ref. No.	L554120
----------------	--------	-----------------	---------

description O-ring EPDM thickness 5.34mm ID ø 56.52mm Qty 1 pcs

for deep fryers

miscellaneous



1	GEV No.	694775	Ref. No.	Q451006
	description	ball valve for oil drain steel L 102mm W 36.5mm H 83mm thread M24 mounting pos. lower WS 33		



1	GEV No.	694776	Ref. No.	T106488
	description	indicator SS L 35mm W 16mm H 3mm mounting pos. valve WS 7		

for dishwashers

boilers

boilers for dishwashers



1	GEV No.	513243	Ref. No.	L100570
	description	boiler		

air traps

air traps



1	GEV No.	510757	Ref. No.	L054517
	description	air trap		



1	GEV No.	510343	Ref. No.	L054520
	description	air trap L 140mm ø 33mm plastic		

knobs

universal knobs



1	GEV No.	110253	Ref. No.	E401205
	description	knob switch zero mark t.max. °C ø 50mm shaft ø 6x4.6mm shaft flat upper black		
	For models:	W380151, W380152, W380251, W380351, W380451, W380656, W382551, W382552, W382651, W382652, W383051		



1	GEV No.	110119	Ref. No.	E401220
	description	knob thermostat t.max. 110°C ø 50mm shaft ø 6x4.6mm shaft flat upper black temperature range 30-110°C rotation 270°		
	accessories for	110119		

	GEV No.	110135	Ref. No.	—
	rosette knob up to ø 52mm			



1	GEV No.	110121	Ref. No.	E401265
	description	knob thermostat t.max. 200°C ø 50mm shaft ø 6x4.6mm shaft flat upper black temperature range 60-200°C rotation 270°		
	accessories for	110121		

	GEV No.	110135	Ref. No.	—
	rosette knob up to ø 52mm			



1	GEV No.	110123	Ref. No.	E401280
	description	knob thermostat t.max. 300°C ø 50mm shaft ø 6x4.6mm shaft flat upper black temperature range 50-300°C rotation 270°		
	accessories for	110123		

	GEV No.	110135	Ref. No.	—
	rosette knob up to ø 52mm			



producer-specific knobs

CAPIC



GEV No.	110253	Ref. No.	E401205
description	knob switch zero mark t.max.°C°C ø 50mm shaft ø 6x4.6mm shaft flat upper black		
For models:	W380151, W380152, W380251, W380351, W380451, W380656, W382551, W382552, W382651, W382652, W383051		



GEV No.	111488	Ref. No.	Q104202
description	knob switch zero mark t.max.°C°C ø 53mm shaft ø 10x8mm shaft flat upper black		
For models:	W380111, W380112, W380121, W380122, W380131, W380132, W380141, W380142, W380151, W380152, W380161, W380162, W380211, W380221, W380231, W380241, W380251, W380261, W380411, W380413, W380421, W380423, W380431, W380433, W380441, W380443, W380451, W380461, W380511, W380521, W380531, W380541, W380912, W380915, W380917, W380919, W380922, W380925, W380927, W380929, W380932, W380935, W380937, W380939, W380942, W380945, W380947, W380949, W381515, W381525...(Other models you can see in the webshop)		
accessories for	111488		
	GEV No.	111489	Ref. No. Q104224
	knob dial plate gas tap with ignition flame t.max.°C°C ø 70mm shaft ømm shaft flat silver		
	GEV No.	111490	Ref. No. I101007
	gasket for knob ED ø 51mm Qty 1 pcs plastic		



GEV No.	111244	Ref. No.	Q104071
description	knob switch zero mark t.max.°C°C ø 53mm shaft ø 10x8mm shaft flat upper blue gas		
accessories for	111244		
	GEV No.	550798	Ref. No. K102060
	pin ø 4mm L 45mm SS		



GEV No.	111451	Ref. No.	Q104072 Q104072+K100503
description	knob switch zero mark t.max.°C°C ø 53mm shaft ø 6x4.6mm shaft flat upper with spring blue electric		
spare parts for	111451		
	GEV No.	550965	Ref. No. —
	knob spring ø 6x4.6mm Qty 1 pcs		







GEV No.	110119	Ref. No.	E401220
description	knob thermostat t.max. 110°C ø 50mm shaft ø 6x4.6mm shaft flat upper black temperature range 30-110°C rotation 270°		
accessories for	110119		
	GEV No.	110135	Ref. No. —
	rosette knob up to ø 52mm		





GEV No.	110121	Ref. No.	E401265
description	knob thermostat t.max. 200°C ø 50mm shaft ø 6x4.6mm shaft flat upper black temperature range 60-200°C rotation 270°		
accessories for	110121		
	GEV No.	110135	Ref. No. —
	rosette knob up to ø 52mm		





GEV No.	110123	Ref. No.	E401280
description	knob thermostat t.max. 300°C ø 50mm shaft ø 6x4.6mm shaft flat upper black temperature range 50-300°C rotation 270°		
accessories for	110123		
	GEV No.	110135	Ref. No. —
	rosette knob up to ø 52mm		

			
1			
GEV No.	111489	Ref. No.	Q104224
description	knob dial plate gas tap with ignition flame t.max.°C°C ø 70mm shaft ømm shaft flat silver		
For models:	W380111, W380112, W380121, W380122, W380131, W380132, W380141, W380142, W380151, W380152, W380161, W380162, W380211, W380221, W380231, W380241, W380251, W380261, W380411, W380413, W380421, W380423, W380431, W380433, W380441, W380443, W380451, W380461, W380511, W380521, W380531, W380541, W380912, W380915, W380917, W380919, W380922, W380925, W380927, W380929, W380932, W380935, W380937, W380939, W380942, W380945, W380947, W380949, W381515, W381525...(Other models you can see in the webshop)		
accessories for	111489		
	GEV No.	111488	Ref. No. Q104202
	knob switch zero mark t.max.°C°C ø 53mm shaft ø 10x8mm shaft flat upper black		
	GEV No.	111490	Ref. No. I101007
	gasket for knob ED ø 51mm Qty 1 pcs plastic		

accessories			
gaskets			
			
1			
GEV No.	111490	Ref. No.	I101007
description	gasket for knob ED ø 51mm Qty 1 pcs plastic		
For models:	W380111, W380112, W380121, W380122, W380131, W380132, W380141, W380142, W380151, W380152, W380161, W380162, W380211, W380221, W380231, W380241, W380251, W380261, W380411, W380413, W380421, W380423, W380431, W380433, W380441, W380443, W380451, W380461, W380511, W380521, W380531, W380541, W380912, W380915, W380917, W380919, W380922, W380925, W380927, W380929, W380932, W380935, W380937, W380939, W380942, W380945, W380947, W380949, W381515, W381525...(Other models you can see in the webshop)		

handles and hand wheels			
hand wheels			
spare parts and accessories			
			
1			
GEV No.	580019	Ref. No.	Q104096
description	handle ø 28mm total length 110mm seat ø 11/11.5mm shaft ømm thread M6 L 110mm bore ø 28mm for hand crank		
accessories for	580019		
	GEV No.	580018	Ref. No. Q104095
	lever for hand crank		

levers			
without handle			
			
1			
GEV No.	580018	Ref. No.	Q104095
description	lever for hand crank		
accessories for	580018		
	GEV No.	580019	Ref. No. Q104096
	handle ø 28mm total length 110mm seat ø 11/11.5mm shaft ømm thread M6 L 110mm bore ø 28mm for hand crank		

hand cranks			
			
1			
GEV No.	580018	Ref. No.	Q104095
description	lever for hand crank		
accessories for	580018		
	GEV No.	580019	Ref. No. Q104096
	handle ø 28mm total length 110mm seat ø 11/11.5mm shaft ømm thread M6 L 110mm bore ø 28mm for hand crank		









locks			
edgemount latches			
handle latches			
CAFF/FERMOD			
			
1			
GEV No.	690456	Ref. No.	Q105508
description	handle latch L 150mm mounting distance 110mm matt chrome-plated lockable refrigeration units 571 R-L CT 26mm complete with door catch		
spare parts for	690456		
	GEV No.	690429	Ref. No. —
	door catch CT 25.5mm		

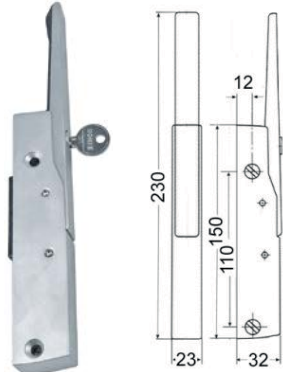

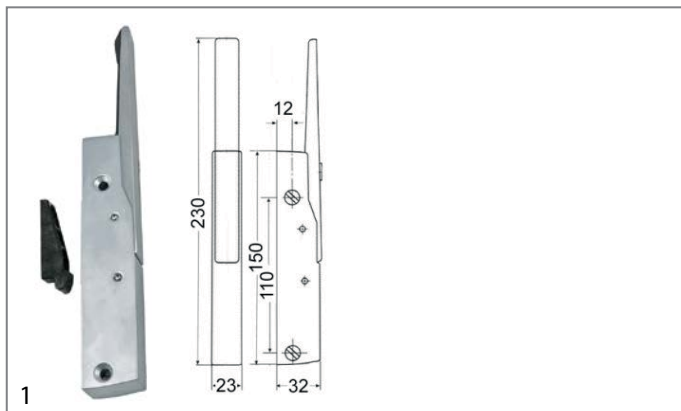

Table continues overleaf

accessories for	690456		
	GEV No.	690428	Ref. No. —
	door catch H 51mm W 13.9mm mounting distance 30mm plastic CT 16.5mm		
	GEV No.	690445	Ref. No. —
	base plate H 2mm		
	GEV No.	690446	Ref. No. —
	base plate H 5mm L 56mm W 18mm		

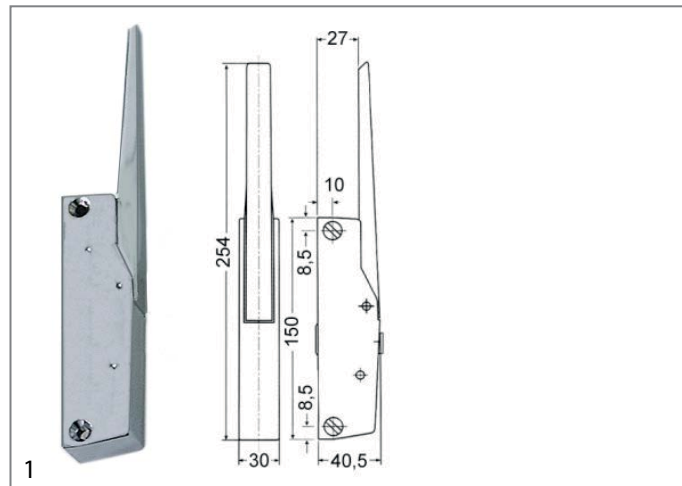



GEV No.	690455	Ref. No.	Q105505
description	handle latch L 150mm mounting distance 110mm matt chrome-plated non lockable refrigeration units 570 R-L complete with door catch		
spare parts for	690455		
	GEV No.	690429	Ref. No. —
	door catch CT 25.5mm		
accessories for	690455		
	GEV No.	690428	Ref. No. —
	door catch H 51mm W 13.9mm mounting distance 30mm plastic CT 16.5mm		
	GEV No.	690445	Ref. No. —
	base plate H 2mm		
	GEV No.	690446	Ref. No. —
	base plate H 5mm L 56mm W 18mm		

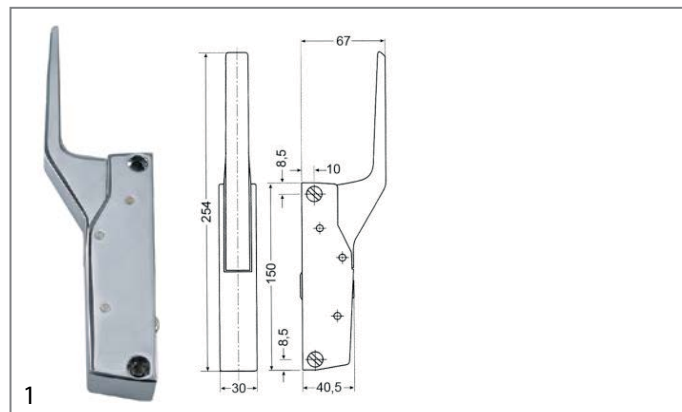

GEV No.	690412	Ref. No.	Q105510
description	handle latch L 150mm mounting distance 133mm non lockable G 790 total length 254mm handle length 105mm		
accessories for	690412		
	GEV No.	690418	Ref. No. —
	door catch L 36mm W 19mm H 29mm mounting distance 12mm zinc-coated steel for refrigeration units		
	GEV No.	690419	Ref. No. —
	door catch L 52mm W 20mm H 30mm mounting distance 26-37mm zamak for refrigeration units		
	GEV No.	700061	Ref. No. —
	door catch L 58mm W 20mm H 35mm mounting distance 42mm chrome-plated brass for headed units		
	GEV No.	700435	Ref. No. —
	door catch L 58mm W 20mm H 35mm mounting distance 42mm zamak for refrigeration units		



GEV No.	700060	Ref. No.	Q105512
description	handle latch L 150mm mounting distance 133mm non lockable heated units G 791		
accessories for	700060		
	GEV No.	700061	Ref. No. —
	door catch L 58mm W 20mm H 35mm mounting distance 42mm chrome-plated brass for headed units		
	GEV No.	700062	Ref. No. —
	handle protection heated units		

espagnolette locks

universal



1

GEV No.	690041	Ref. No.	Q101009
description	cam L 148mm mounting distance 32mm		

hinges

edgmount hinges

CAFF/FERMOD

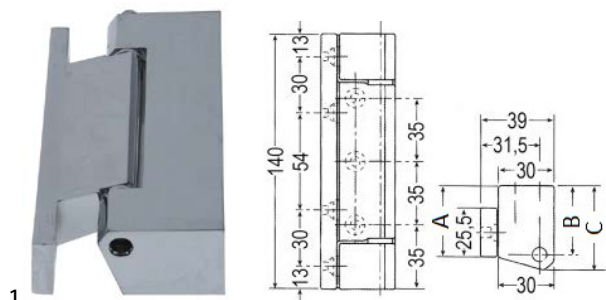

1

GEV No.	700562	Ref. No.	Q104505
description	edgmount hinge L 140mm W 31/24mm mounting distance 30/35mm hinging left/right without lift L1 37mm L2 36mm L3 45.5mm series G 361		



1

GEV No.	692669	Ref. No.	Q104510
description	edgmount hinge L 96mm W 15/17mm mounting distance 64/32mm hinging left/right without lift centre of rotation 14/23mm		

fittings for catering equipment

outlet taps

universal

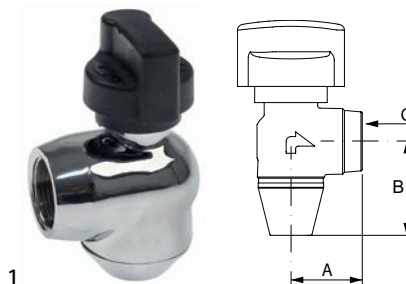

1

GEV No.	540699	Ref. No.	Q451110
description	outlet tap W 35mm H 35mm thread 3/4" IT		

producer-specific

CAPIC



1

GEV No.	514423	Ref. No.	Q402505
description	ball valve L 59.5mm 3-way W 29mm H 71mm with lever handle thread 3/8" IT - 3/8" IT handle length 78mm		



1

GEV No.	698953	Ref. No.	Q402506
description	outlet tap L 80mm W 32mm H 100mm thread 1/2" IT - 1/2" IT		





drain taps

brass

drain taps



GEV No.	540276	Ref. No.	Q451015
description	drain tap connection with union nut thread 1½"		
spare parts for	540276		
	GEV No.	532374	Ref. No. —
	O-ring silicone thickness 5.34mm ID ø 43.82mm Qty 10 pcs		
accessories for	540276		
	GEV No.	514251	Ref. No. —
	gasket fibre ED ø 46mm ID ø 38mm thickness 2mm Qty 1 pcs		

test taps

test taps

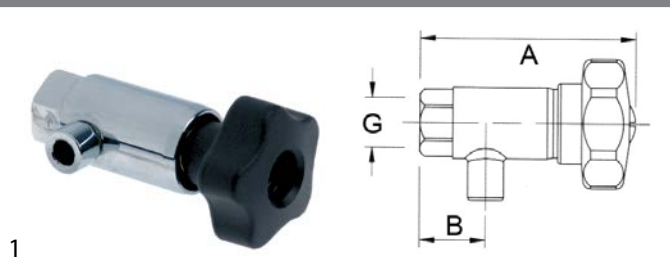

GEV No.	540206	Ref. No.	Q450506
description	test tap thread 3/8" IT W 78mm W1 20mm head ø 37mm head thickness 15mm		
For models:	W384111, W384112, W384122		

equipment feet and end caps

equipment feet

with fixing plate

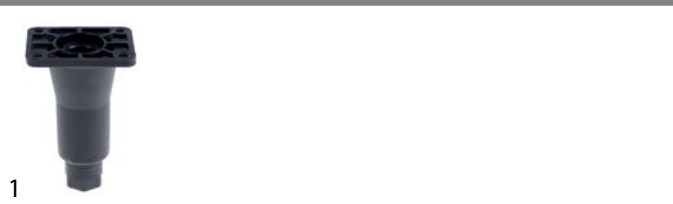

GEV No.	700848	Ref. No.	Q053062
description	equipment foot plate size 80x103mm hole distance 60x80mm H 150-180mm plastic size Qty 1 pcs		
For models:	W380121, W380122, W380131, W380132, W380141, W380142, W380151, W380152, W380161, W380162, W380221, W380231, W380241, W380251, W380261, W380321, W380331, W380341, W380351, W380421, W380423, W380431, W380433, W380441, W380443, W380451, W380461, W380521, W380531, W380541, W380624, W380626, W380628, W380633, W380634, W380636, W380638, W380644, W380646, W380648, W380656, W380666, W380721, W380731, W380741, W380821, W380825, W380831, W380835, W380921...(Other models you can see in the webshop)		

bullet feet

plastic

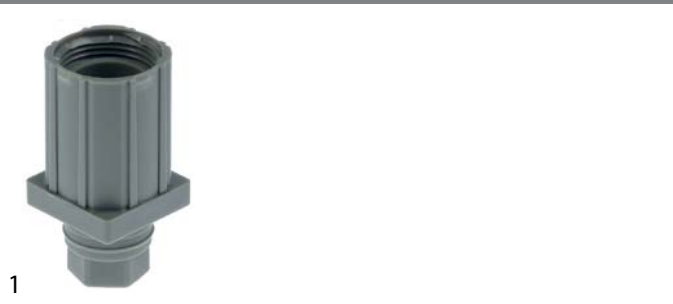



GEV No.	700118	Ref. No.	Q053036
description	equipment foot pipe type 35x35 thickness 1.2-1.5mm H 23-53mm plastic Qty 1 pcs load capacity 90kg		

baskets

fryer baskets

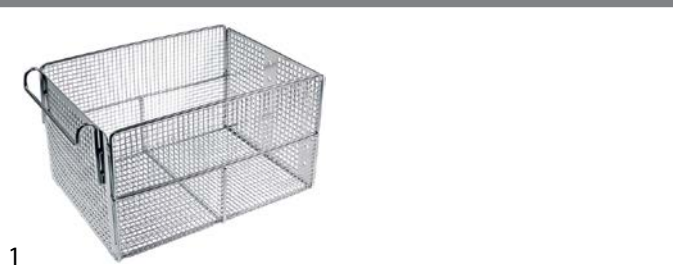
CAPIC



GEV No.	970664	Ref. No.	A401019
description	fryer basket L1 315mm W1 245mm H1 190mm		
accessories for	970664		
	GEV No.	970665	Ref. No. A402050
	handle for fryer basket		



1

GEV No.	970918	Ref. No.	A401023
description	fryer basket W1 160mm L1 320mm H1 130mm		
accessories for	970918		
	GEV No.	970665	Ref. No. A402050
handle for fryer basket			



1

GEV No.	970917	Ref. No.	A401030
description	fryer basket W1 370mm L1 555mm H1 200mm		
accessories for	970917		
	GEV No.	970665	Ref. No. A402050
handle for fryer basket			



1

GEV No.	970665	Ref. No.	A402050
description	handle for fryer basket		
For models:	W381031, W381035, W381131, W381132, W382031, W382032		

shelves and shelf rails

chargrill grids



1

GEV No.	210038	Ref. No.	A251512
description	chargrill grid L 333mm W 317mm H 50mm cast iron		



grates

universal

without upstand





1



GEV No.	970122	Ref. No.	A303005
description	grate W 325mm D 530mm GN 1/1 H 8mm stainless steel wire gauge frame 7mm lengthwise wires gauge 4mm crossing wires 1		
accessories for	970122		
	GEV No.	690330	Ref. No. —
rack L 1000mm W 22mm H 4mm aperture 3x8mm hole distance 12.5mm stainless steel			
	GEV No.	694700	Ref. No. —
shelf support L 31/28mm W 22mm H 18mm SS Qty 12 pcs			
	GEV No.	694701	Ref. No. —
shelf support L 31/28mm W 22mm H 17mm SS with hook Qty 12 pcs			

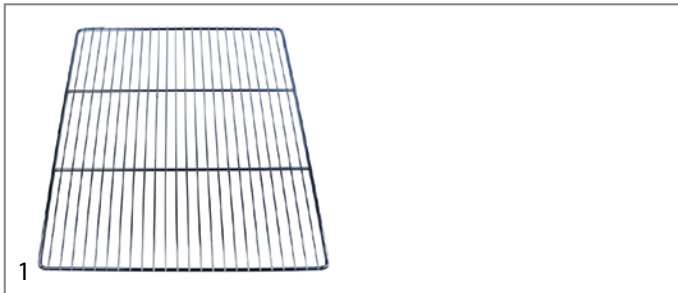

1

GEV No.	970077	Ref. No.	A303015
description	grate W 400mm D 600mm SS crossing wires 1		
accessories for	970077		
	GEV No.	690330	Ref. No. —
rack L 1000mm W 22mm H 4mm aperture 3x8mm hole distance 12.5mm stainless steel			
	GEV No.	694700	Ref. No. —
shelf support L 31/28mm W 22mm H 18mm SS Qty 12 pcs			
	GEV No.	694701	Ref. No. —
shelf support L 31/28mm W 22mm H 17mm SS with hook Qty 12 pcs			



GEV No.	970123	Ref. No.	A303020
description	grate W 650mm D 530mm GN 2/1 stainless steel wire gauge frame 7.8mm lengthwise wires gauge 3.8mm crossing wires 2 suitable for refrigerator		
accessories for	970123		
	GEV No.	690330	Ref. No. —
	rack L 1000mm W 22mm H 4mm aperture 3x8mm hole distance 12.5mm stainless steel		
	GEV No.	694700	Ref. No. —
	shelf support L 31/28mm W 22mm H 18mm SS Qty 12 pcs		
	GEV No.	694701	Ref. No. —
	shelf support L 31/28mm W 22mm H 17mm SS with hook Qty 12 pcs		

gaskets

refrigeration gaskets

screw-in gaskets

profile 9207

We offer custom-made gaskets for this profile

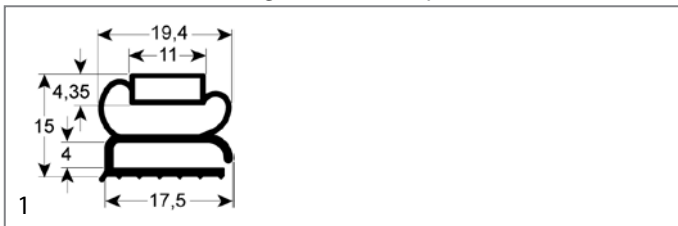

GEV No.	900728	Ref. No.	I302006
description	refrigeration gasket profile 9207 W 387mm L 495mm external size		

gaskets for heated units

window seals

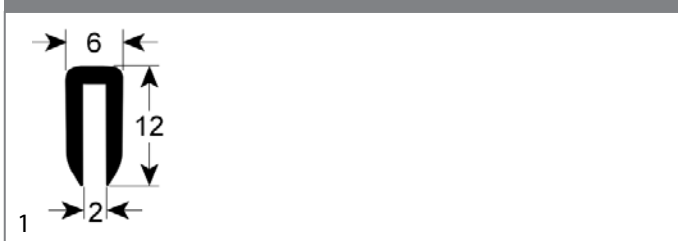

GEV No.	901575	Ref. No.	I304004
description	window gasket profile 1503 suitable for CAPIC Qty supplied by meter		



GEV No.	900937	Ref. No.	I304026
description	window gasket profile 1893 Qty supplied by meter		

door seals

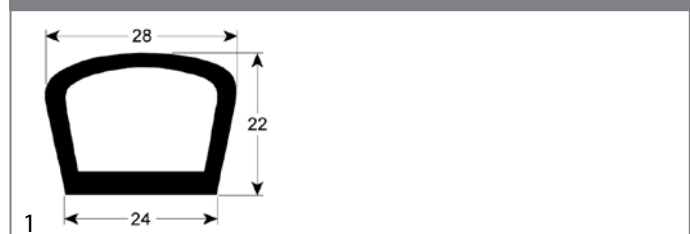

GEV No.	901576	Ref. No.	I304016
description	door seal profile 2202 Qty supplied by meter suitable for CAPIC		



GEV No.	900938	Ref. No.	I304002
description	door seal profile 2257 Qty supplied by meter dark blue silicone Shore 55° temp.-resist. -100 à +220°C		

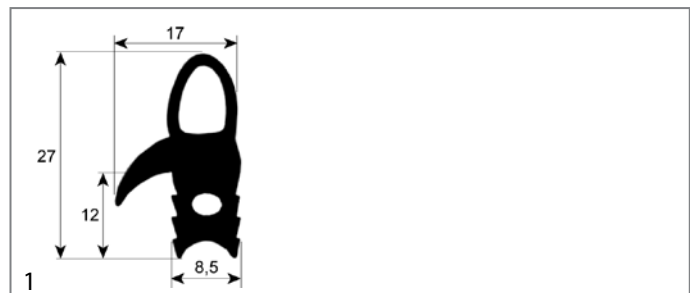

GEV No.	900939	Ref. No.	I304024
description	door seal profile 2700 Qty supplied by meter light blue silicone Shore 55° temp.-resist. -100 à +220°C		

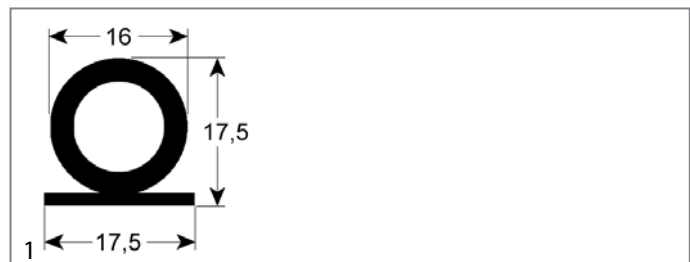

GEV No.	901577	Ref. No.	I304006
description	door seal profile 2952 Qty supplied by meter suitable for CAPIC		



GEV No.	901578	Ref. No.	I304008
description	door seal profile 2957 Qty supplied by meter suitable for CAPIC		

O-rings

EPDM



GEV No.	509002	Ref. No.	L351410
description	O-ring EPDM thickness 2.62mm ID ø 82.22mm Qty 1 pcs		



GEV No.	510408	Ref. No.	E153011
description	O-ring EPDM thickness 5.34mm ID ø 47mm Qty 1 pcs		
For models:	W384111, W384112		



GEV No.	510409	Ref. No.	L554120
description	O-ring EPDM thickness 5.34mm ID ø 56.52mm Qty 1 pcs		

sealing washers

rubber gaskets



GEV No.	519521	Ref. No.	I101015
description	flat gasket rubber ED ø 41mm ID ø 17.5mm thickness 1mm Qty 1 pcs suitable for CAPIC		

special gaskets

miscellaneous



GEV No.	520942	Ref. No.	I101012
description	gasket L 75mm W 58mm silicone thickness 1mm		

thermostat gaskets



GEV No.	513018	Ref. No.	L455026
description	gasket for thermostat ED ø 41mm ID ø 18mm equiv. no. CGG16 suitable for COLGED		

transmission technology and ball bearings

ball bearings

flange bearings



GEV No.	694484	Ref. No.	Q201023
description	flange bearing type UCFE205 shaft ø 25mm 4 hole flange hole distance 70mm H 39mm flange length 95mm flange width 95mm hole ø 11.5mm flange FE205 ball bearing UC205G2 FH 30mm		



GEV No.	694483	Ref. No.	Q201010 Q201016
description	flange bearing type RNFTL2806A.5S shaft ø 25mm hole distance 32.5mm flange ø 79mm L 85mm		





springs

compression springs

			
1			
GEV No.	530475	Ref. No.	Q106015
description	spring ø 35mm L 105mm wire gauge ø 4.5mm windings 9 metal		

gas tension springs

<h4>gas tension springs</h4>			
			
1			
GEV No.	701055	Ref. No.	Q201530
description	gas tension spring 500N hub 200mm D1 ø 18mm D2 ø 8mm hole distance 485mm hole ø 8.1mm L 498mm		

			
1			
GEV No.	701056	Ref. No.	Q201515
description	gas tension spring 800N hub 60mm D1 ø 19mm D2 ø 8mm hole distance 205.5mm hole ø 8.1mm L 218mm		

tension springs

			
1			
GEV No.	698957	Ref. No.	Q106020
description	spring ø 22.5mm total length 116mm wire gauge ø 3mm L1 20mm L2 76mm L3 20mm		

dosing pumps

piston pumps

spare parts



			
1			
GEV No.	361113	Ref. No.	L053022
description	solenoid coil 230VAC for type DB2		

membrane dosing pumps

self-priming

LANG

accessories

			
1			
GEV No.	101286	Ref. No.	G701011
description	olive ID ø 6mm Qty 1 pcs		
accessories for	101286		
			
GEV No.	100909	Ref. No.	G701010
description	union screw thread M10x1 for pipe ø 6mm Qty 1 pcs		
			
GEV No.	101464	Ref. No.	—
description	union nut thread M12x1 for pipe ø 6mm		

hoses

supply hoses

PVC supply hoses

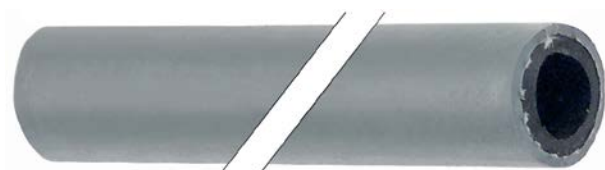
			
1			
GEV No.	520017	Ref. No.	L155025
description	supply hose ID ø 13mm ED ø 20mm L 5m operating p. 20bar burst p. 60bar t.max. 95°C grey Qty 5m		

fittings, hose and pipe connectors

hose connectors

stainless steel

			
1			
GEV No.	542325	Ref. No.	E4403535
description	hose connector thread 1/8" hose ø 6mm stainless steel Qty 1 pcs		

valves and tank inlets

ball valves

universal

ball valves with lever handle



GEV No.	520281	Ref. No.	Q401005
description	ball valve connection 3/4" IT - 3/4" IT DN20 total length 56mm with lever handle handle length 87mm		

mixing valves



GEV No.	514422	Ref. No.	Q452025
description	shut-off valve connection 1/2" 1/2" total length 160mm mounting pos. red/blue rosette thread G2 3/4" shaft ø 7.6mm		

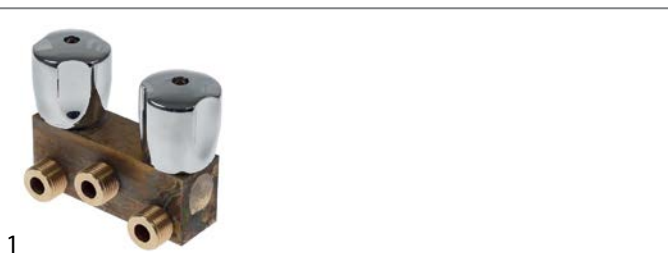

GEV No.	514516	Ref. No.	Q452030
description	shut-off valve thread 1/2"		
For models:	W384012, W384021, W384022, W384111, W384112, W384121, W384122, W385011, W385012, W385013, W385014, W385015, W385021, W385022, W385023, W385024, W385025		

measuring equipment

thermometers

built-in thermometers



GEV No.	541095	Ref. No.	L057015
description	thermometer mounting measurements 58x25.5mm 0 up to +120°C capillary pipe 3000mm probe ø 6.5mm probe L 20mm		

fastening material

nuts

hexagonal nuts

hexagonal nuts with PG thread



GEV No.	550578	Ref. No.	E303045
description	nut thread PG21 H 4.6mm WS 32 nickel-plated brass Qty 1 pcs mounting ømm cable ømm		
For models:	W384012, W385011, W385012, W385013, W385014, W385015		

fasteners

pins



GEV No.	550798	Ref. No.	K102060
description	pin ø 4mm L 45mm SS		
For models:	W380111, W380112, W380121, W380122, W380131, W380132, W380141, W380142, W380151, W380152, W380161, W380162, W380211, W380221, W380231, W380241, W380251, W380261, W380411, W380413, W380421, W380423, W380431, W380433, W380441, W380443, W380451, W380461, W380511, W380521, W380531, W380541, W380912, W380915, W380917, W380919, W380922, W380925, W380927, W380929, W380932, W380935, W380937, W380939, W380942, W380945, W380947, W380949, W381515, W381525...(Other models you can see in the webshop)		

A			
alarm devices	19	heater battery	6
axial fans	25	heating elements	3
B		heating elements for bain maries	4
ball valves	60	heating elements for chip scuttles	4
bar burners	45	heating elements for convection	7
booster pumps II	29	heating elements for fryers	4
C		heating elements for frying pans	4
cable glands	29	heating elements for griddles	5
cables	29	heating elements for heated cabinets	5
cam switches	13	heating elements for ovens	3
ceramic burners	46	heating elements for tilting bratt pan	5
condensators & interference suppression filters	29	hexagonal nuts	60
contact heaters	6	hob burners	41
contactors	19	hose connectors	59
control equipment	14	hoses	59
control thermostats	9, 11	hot air fans	26
cross flow fans	25	hot air motors	25
D		hot plates	8
door seals	57	I	
dosing pumps	59	ignition cables	40
E		ignition units	41
edgemount hinges	54	immersion heating elements	6
edgemount latches	52	indicator lights	15
electric accessories	29	indicator lights (complete)	15
electrodes	25	L	
electronic controllers	21	lamps	15
energy regulators	8	light bulbs	17
espagnolette locks	54	M	
F		magnetic switches	14
fans	25	measuring equipment	60
fasteners	60	microswitches	12
fastening material	60	mixing valves	60
G		motors	26
gas burners	41	N	
gas control valves	34	neon light bulbs	15, 16
gas lines	49	nickel wire	29
gas nozzles	46	nuts	60
gas solenoid valves	37	O	
gas taps	30	operating capacitors	29
gas thermostats	32	O-rings	58
gaskets for heated units	57	oven lamps	17
grates	56	P	
H		piezoelectric igniters	41
handle latches	52	pilot burners	37
		pins	60
		pressure switches	24
		probes	21

programme timers	18
protection hoses	29
pumps	26
push/momentary push switches	12
PVC supply hoses	59

Q

quartz heating elements	6
-------------------------	---

R

refrigeration gaskets	57
relays	20
ribbon cables	29
rocker/momentary rocker switches	12

S

safety thermostats	10
safety valves	37
screw-in gaskets	57
sealing washers	58
shelves and shelf rails	56
solenoid valves	22
supply hoses	59
switches and momentary switches	12
system switches (ROLD)	13

T

temperature probes	21
terminals	29
thermocouples	41
thermostat gaskets	58
thermostats	9
threaded cable glands	29
time relays	20
timers	18

U

universal probes	21
------------------	----

V

valves and tank inlets	60
------------------------	----

W

wash and rinse pumps	26
window seals	57