



GAS COMPONENTS



ELECTRIC COMPONENTS



WATER TECHNOLOGY



MECHANICAL COMPONENTS



TOOLS

Spare parts suitable for

CAMURRI

Find the complete and up-to-date range of products in our GEV Webshop



Manufacturer catalogue

The most important spare parts and accessories arranged clearly for every manufacturer

- ✓ Complete product range and all appliance data always up to date in the GEV Webshop
- ✓ Alphabetical Index at the end of the catalogue

GEV Webshop

www.gev-online.co.uk

www.gev-online.com



- 🔍 Add to Favourites
- 🔍 Sign In with email address and usual password
- 🔍 Easy-order – place several items in your basket at the same time
- 🔍 Quick Item search – no login needed



heating elements

heating elements for coffee machine



1

GEV No.	417510	Ref. No.	050N0020 050N0020+050D0050+050C0430
description	heating element 1500W 230V heating circuits 1 thread 1" ø 168mm thermostat sleeves ø 7mm length thermostat sleeves 110mm connection male faston 6.3mm WS 30 tube ø 6.3mm		



1

GEV No.	417513	Ref. No.	050N0061 050N0061+050D0185
description	heating element 2400W 230V heating circuits 3 mounting ø 42mm hole distance 48mm L 188mm W 27mm H 30mm hole ø 7mm thermostat sleeves ø 7mm length thermostat sleeves 160mm number of thermostat sleeves 1 tube ø 6.3mm connection male faston 6.3mm 3 hole flange suitable for CAMURRI		



1

GEV No.	417512	Ref. No.	050N0040 050N0040+050D0051+050C0435
description	heating element 2400W 230V heating circuits 3 thread 1 1/4" L 220mm W 85mm H 60mm tube ø 6.3mm connection male faston 6.3mm WS 37		



1

GEV No.	417509	Ref. No.	050N0070
description	heating element 900W 230V heating circuits 1 L 130mm H 42mm flange 26X61mm W 44mm connection male faston 6.3mm tube ø 8mm suitable for CAMURRI		



1

GEV No.	417511	Ref. No.	050N0012
description	heating element 900W 230V heating circuits 1 thread 1" ø 150mm connection male faston 6.3mm WS 30		

flow heaters



1

GEV No.	417506	Ref. No.	050N0110
description	flow heater 1500W 230V ø 75mm H 142mm connection male faston 6.3mm		



1

GEV No.	417508	Ref. No.	050N0120
description	flow heater 1600W 230V ø 112mm H 87mm connection M3		



1

GEV No.	417507	Ref. No.	050N0140
description	flow heater 4000W 230V ø 75mm H 165mm connection M3		



accessories

flange gaskets

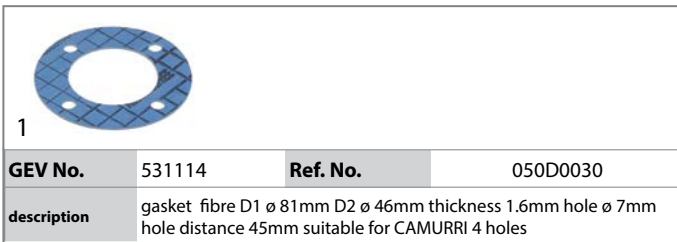
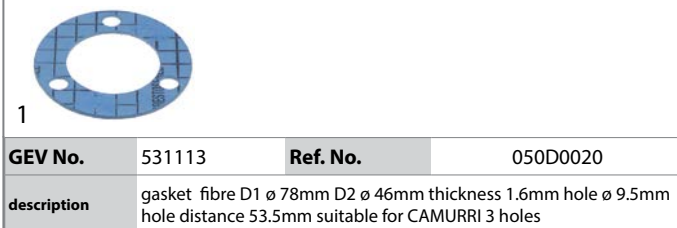

hot plates

round

with radiused edge

for domestic and commercial kitchens

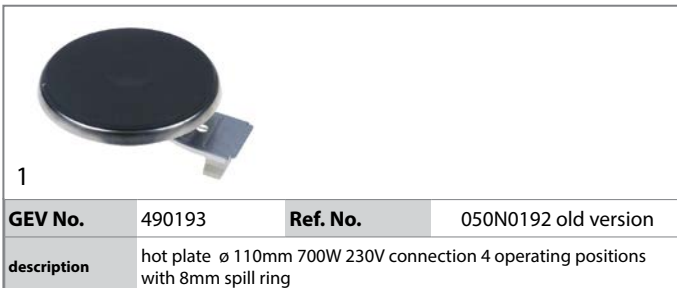

thermostats

bi-metal thermostats

miscellaneous

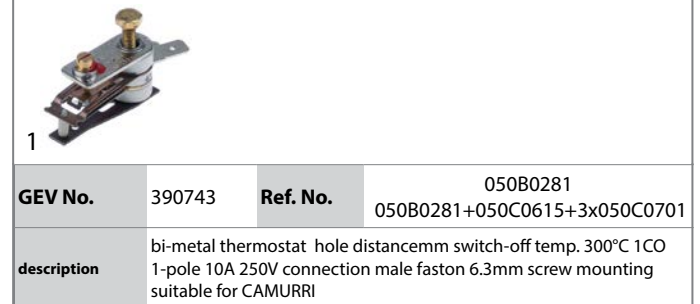

control and safety thermostats

IMIT / TEMPOMATIC / ARTHERMO

control thermostats

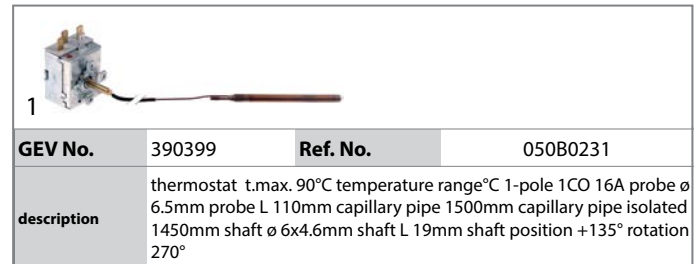
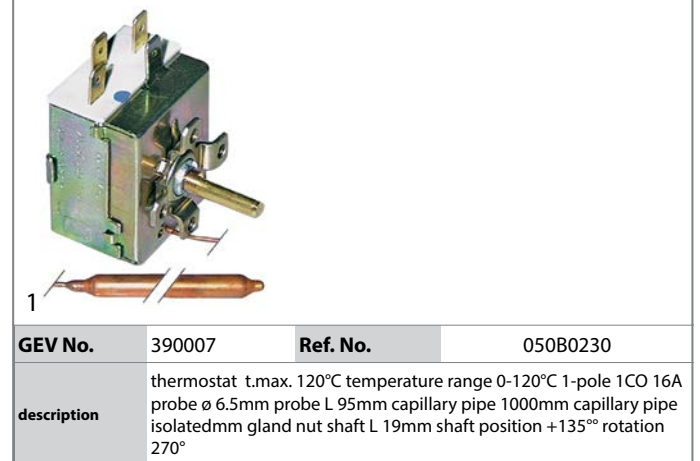

switches and momentary switches

rocker/momentary rocker switches

30x22mm

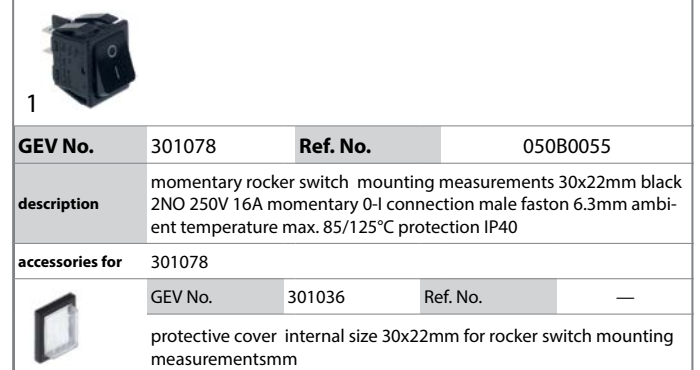





			
1			
GEV No.	347473	Ref. No.	050B0005
description	rocker switch mounting measurements 30x22mm green 2NO/indicator light 230V 16A illuminated 0 connection male faston 6.3mm ambient temperature max. 125/55°C protection IP40		

float switches

			
1			
GEV No.	347474	Ref. No.	050E0100 sehe Bemerkung 04.12.2017 sehe Bemerkung 24,02,2015
description	float switch kit thread 1/8" 1NC ø 26mm L 26mm mounting ø 10mm 230V 0.5A cable cable length 600mm		

timers

mechanical timers

				
1				
GEV No.	360499	Ref. No.	050B0180	
description	timer MT59 2-pole operation time 60min impulse mechanical 2NO at 250V 16A permanent position no shaft ø 6x4.6mm shaft L 21mm mounting distance 28mm connection lateral shaft flat upper			
accessories for	360499			
	GEV No.	112029	Ref. No.	—
	knob zero mark ø 40mm shaft ø 6x4.6mm shaft flat lower black			
	GEV No.	112589	Ref. No.	—
	dial plate graduation 60min permanent position 0-290 rotation no° ø 60mm			

spare parts and accessories

dial fascias

			
1			
GEV No.	112647	Ref. No.	050B0190
description	dial plate graduation 60min rotation 300° suitable for CAMURRI		

contactors

LOVATO

power contactors

			
1			
GEV No.	380964	Ref. No.	050B0380
description	power contactor resistive load 20A 230VAC (AC3/400V) 9A/4kW main contacts 4NO auxiliary contacts connection screw connection type 11BG09T4A230		

solenoid valves

solenoid valves (water)











TP				
				
1				
GEV No.	370015	Ref. No.	050E0040	
description	solenoid valve single angled 230VAC inlet 3/4" outlet 11.5mm DN10 TP			
accessories for	370015			
	GEV No.	371220	Ref. No.	—
	reducer TP flow rate 3l/min red tolerance ±15%			
	GEV No.	371221	Ref. No.	—
	reducer TP flow rate 5.5l/min yellow tolerance ±15%			
	GEV No.	371222	Ref. No.	—
	reducer TP flow rate 6l/min grey tolerance ±15%			
	GEV No.	371223	Ref. No.	—
	reducer TP flow rate 10l/min white tolerance ±15%			
	GEV No.	371224	Ref. No.	—
	reducer TP flow rate 12l/min bronze tolerance ±15%			
	GEV No.	371225	Ref. No.	—
	reducer TP flow rate 16l/min light brown tolerance ±15%			
	GEV No.	371226	Ref. No.	—
	reducer TP flow rate 20l/min red tolerance ±15%			
	GEV No.	371230	Ref. No.	—
	reducer TP flow rate 0.25l/min red tolerance ±25%			
	GEV No.	371231	Ref. No.	—
	reducer TP flow rate 0.35l/min violet tolerance ±25%			

Table continues overleaf



accessories for		370015	
	GEV No.	371232	Ref. No. —
reducer TP flow rate 0.5l/min orange tolerance ±25%			
	GEV No.	371233	Ref. No. —
reducer TP flow rate 0.8l/min white tolerance ±25%			
	GEV No.	371234	Ref. No. —
reducer TP flow rate 1l/min light blue tolerance ±25%			
	GEV No.	371235	Ref. No. —
reducer TP flow rate 1.2l/min brown tolerance ±25%			
	GEV No.	371236	Ref. No. —
reducer TP flow rate 1.5l/min light brown tolerance ±25%			
	GEV No.	371237	Ref. No. —
reducer TP flow rate 2.5l/min yellow tolerance ±25%			
	GEV No.	371238	Ref. No. —
reducer TP flow rate 3.4l/min dark green tolerance ±25%			
	GEV No.	371239	Ref. No. —
reducer TP flow rate 5l/min black tolerance ±25%			
	GEV No.	371240	Ref. No. —
reducer TP flow rate 8l/min blue tolerance ±20%			

motors

gear motors

miscellaneous



1	GEV No.	361833	Ref. No.	050E0060
description gear motor CROUZET type 82524413 5W 230V voltage AC 50Hz 30rpm shaft ø 6mm L 66mm W 54mm H 65mm				



1	GEV No.	361860	Ref. No.	050E0060+050E0061+050C0706
description gear motor MECHTEX type 11 K 221E 220V 50Hz 30rpm shaft ø 6mm L 100mm W 75mm H 67mm				



1	GEV No.	361834	Ref. No.	050E0071 050E0071+050E0072+050C0706
description gear motor type X0211705 11.5W 230V 50Hz 30rpm shaft ø 6mm L 68mm W 68mm H 70mm				

fuses

fine fuses

1			
GEV No.	358031	Ref. No.	050B0343
description fine fuse size ø10x38mm 10A rated 500V type Gg fast-acting Qty 1 pcs			

1			
GEV No.	358027	Ref. No.	050B0342
description fine fuse size ø10x38mm 16A rated 500V type Gg fast-acting Qty 1 pcs			

1			
GEV No.	358032	Ref. No.	050B0341
description fine fuse size ø10x38mm 25A rated 500V type Gg fast-acting Qty 1 pcs			

1			
GEV No.	358022	Ref. No.	050B0344
description fine fuse size ø10x38mm 4A rated 500V type Gg fast-acting Qty 1 pcs			

fine fuse holders

1			
GEV No.	358075	Ref. No.	050B0340
description fuse holder for for fuse ø10x38mm suitable fuse ø10x38mm 1-pole 32A rated 690V for DIN rail 35mm cross section 10mm ² suitable for for fuse ø10x38mm			



electric accessories

cables

accessories

cable glands

threaded cable glands

screw connections



GEV No.	551069	Ref. No.	050B0610
description	cable gland thread PG11 cable ø 10mm mounting ø 19mm Qty 1 chrome-plated brass WS 20		

terminals

connection terminals with screw/faston connections



GEV No.	551067	Ref. No.	050B0401
description	connection terminal 3-pole max. 16A max 400V connection ø2.5mm ² / F6.3 temp.-resist. 150°C cross section 2.5mm ²		

rail-mounted terminals

WIELAND

rail-mounted terminals type 9700A



GEV No.	550372	Ref. No.	050B0402
description	rail-mounted terminal WIELAND type 9700A/6 SL2 S35 0.5-4mm ² top-hat rail 35mm yellow/green W 6mm L 48.5mm		

miscellaneous



GEV No.	551068	Ref. No.	050B0408
description	rail-mounted terminal 6mm ² green/yellow for DIN rail 35mm 1-pole		

equipment-specific units

for pour machines

drain taps

drain taps



GEV No.	531102	Ref. No.	050F0010
description	outlet tap pipe length 45mm thread 3/4" black suitable for CAMURRI		



GEV No.	531103	Ref. No.	050F0030
description	outlet tap pipe length 45mm thread 3/4" black/chrome suitable for CAMURRI		

components



GEV No.	525433	Ref. No.	050D0060
description	gasket for tap H 29mm ø 31mm		

water taps

water taps



GEV No.	531104	Ref. No.	050F0110
description	outlet tap inlet 3/4" outlet 1/2"		

liquid level pipes

liquid level pipes





GEV No.	531110	Ref. No.	050I0030 050I0030 + 050D0165
description	water level tube ED ø 9mm ID ø 6mm H 180mm for CAMURRI		

spare parts for	531110			
	GEV No.	531108	Ref. No.	050D0165
	O-ring EPDM thickness 2.5mm ID ø 7.8mm Qty 1 pcs			

1			
GEV No.	531112	Ref. No.	050I0040
description	water level tube ED ø 9mm ID ø 6mm H 195mm for CAMURRI		

1			
GEV No.	531109	Ref. No.	050I0050 050I0050 + 050D0165
description	water level tube ED ø 9mm ID ø 6mm H 250mm for CAMURRI		

1			
GEV No.	531107	Ref. No.	050I0060 050I0060+050D0165
description	water level tube ED ø 9mm ID ø 6mm H 280mm for CAMURRI		

1			
GEV No.	531111	Ref. No.	050I0070
description	water level tube ED ø 9mm ID ø 6mm H 350mm for CAMURRI		

housing and bezels

housings

1			
GEV No.	531106	Ref. No.	050P8210
description	side panel L 305mm W 47mm H 205mm		

knobs

accessories

rosettes

1			
GEV No.	110105	Ref. No.	050B0240
description	rosette knob ø 42mm ø 56mm zero mark		

gaskets

O-rings

EPDM

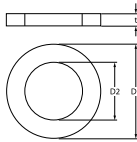
1			
GEV No.	531108	Ref. No.	050D0165
description	O-ring EPDM thickness 2.5mm ID ø 7.8mm Qty 1 pcs		

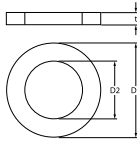
1			
GEV No.	531105	Ref. No.	050D0169
description	O-ring EPDM thickness 3mm ID ø 16.2mm Qty 1 pcs		

fittings, hose and pipe connectors

fittings

reducers

1			
GEV No.	520209	Ref. No.	050C0200
description	reducer thread 3/4" ET - 3/8" IT nickel-plated brass total length 17.5mm WS 30		

fastening material

screws

countersunk screws

1			
GEV No.	560267	Ref. No.	050C0595
description	countersunk screw thread M5 L 25mm SS DIN 965/ISO 7046 Qty 1 pcs intake Phillips		



hexagonal screws



1

GEV No.	560274	Ref. No.	050C0615
description	hexagonal screw thread M5 thread L 25mm SS WS 8 without pole Qty 20 pcs DIN 933 / ISO 4017		

consumables

fuses

fine fuses

ø10x38mm 500V



1

GEV No.	358031	Ref. No.	050B0343
description	fine fuse size ø10x38mm 10A rated 500V type Gg fast-acting Qty 1 pcs		



1

GEV No.	358027	Ref. No.	050B0342
description	fine fuse size ø10x38mm 16A rated 500V type Gg fast-acting Qty 1 pcs		



1

GEV No.	358032	Ref. No.	050B0341
description	fine fuse size ø10x38mm 25A rated 500V type Gg fast-acting Qty 1 pcs		



1

GEV No.	358022	Ref. No.	050B0344
description	fine fuse size ø10x38mm 4A rated 500V type Gg fast-acting Qty 1 pcs		

B

bi-metal thermostats 4

C

cable glands 7

cables 7

consumables 9

contactors 5

control thermostats 4

countersunk screws 8

E

electric accessories 7

F

fastening material 8

fine fuses 9

fittings 8

float switches 5

flow heaters 3

fuses 6, 9

H

heating elements 3

heating elements for coffee machine 3

hexagonal screws 9

hot plates 4

M

mechanical timers 5

motors 6

O

O-rings 8

R

reducers 8

rocker/momentary rocker switches 4

S

screws 8

solenoid valves 5

switches and momentary switches 4

T

terminals 7

thermostats 4

threaded cable glands 7

timers 5