



GAS COMPONENTS



ELECTRIC COMPONENTS



WATER TECHNOLOGY



MECHANICAL COMPONENTS



TOOLS

Spare parts suitable for

CF-CENEDESE

Find the complete and up-to-date range of products in our GEV Webshop



Manufacturer catalogue

The most important spare parts and accessories arranged clearly for every manufacturer

- ✓ Complete product range and all appliance data always up to date in the GEV Webshop
- ✓ Alphabetical Index at the end of the catalogue

GEV Webshop

www.gev-online.co.uk

www.gev-online.com





- 🔍 Add to Favourites
- 🔍 Sign In with email address and usual password
- 🔍 Easy-order – place several items in your basket at the same time
- 🔍 Quick Item search – no login needed







heating elements

heating elements for bain maries

			
GEV No.	416194	Ref. No.	63.7.1052
description	heating element 1189W 230V heating circuits 1 L 278mm W 150mm connection male faston 6.3mm tube ø 6.3mm 2 hole fixing thread 1/8" immersion heater/dry heating element L1 135mm L2 143mm H 22mm mounting distance 144mm		
For models:	BM23		







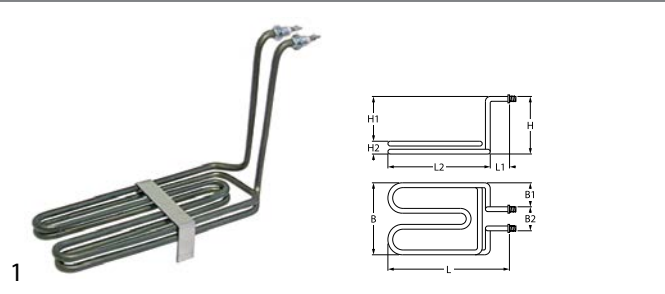

			
GEV No.	416195	Ref. No.	63.7.1023
description	heating element 1500W 230V heating circuits 1 L 368mm L1 23mm W 268mm connection male faston 6.3mm connection distance 263mm tube ø 6.3mm dry heating element bain marie L2 345mm H 19mm		

			
GEV No.	416193	Ref. No.	63.7.1051
description	heating element 823W 230V heating circuits 1 L 280mm W 106mm connection male faston 6.3mm tube ø 6.3mm 2 hole fixing thread M10x1 dry heating element bain marie L1 135mm L2 145mm W1 27mm W2 105mm H 18mm mounting distance 100mm		
For models:	BM11, BM12, BM13		
accessories for	416193		
	GEV No.	510416	Ref. No. —
	flat gasket fibre ED ø 19mm ID ø 10.5mm thickness 1.5mm for thread M10 Qty 1 pcs		
	GEV No.	510893	Ref. No. —
	O-ring EPDM thickness 2.62mm ID ø 9.92mm Qty 1 pcs		
	GEV No.	520231	Ref. No. —
	nut thread M10x1 H 6mm WS 14 zinc-coated steel Qty 1 pcs		
	GEV No.	521129	Ref. No. —
	nut thread M10 H 6mm SS WS 17 Qty 1 pcs DIN/ISO DIN 439		

heating elements for fryers

2 hole fixing



			
GEV No.	415721	Ref. No.	63.7.1064
description	heating element 2100W 230V heating circuits 1 L 292mm W 107mm H 200mm 2 hole fixing connection M4 fryer heaters L1 25mm L2 267mm W1 21mm W2 65mm H1 162mm H2 38mm tube ø 8.5mm thread 1/4" mounting distance 99mm connection length 23mm		
For models:	FE04, FE44		
accessories for	415721		
	GEV No.	361182	Ref. No. —
	nut thread 1/4" H 5mm nickel-plated brass WS 17 Qty 1 pcs		
	GEV No.	510417	Ref. No. —
	flat gasket fibre ED ø 20mm ID ø 14mm thickness 2mm Qty 1 pcs		
	GEV No.	520228	Ref. No. —
	tooth lock washer ID ø 15.3mm ED ø 24mm steel Qty 1 pcs for thread M14		
	GEV No.	521103	Ref. No. —
	nut thread M4 H 3mm WS 7 brass Qty 20 pcs		
	GEV No.	521104	Ref. No. —
	washer ID ø 4.3mm ED ø 8mm thickness 0.5mm brass Qty 20 pcs for thread M4		
	GEV No.	550262	Ref. No. —
	flat gasket copper ED ø 20mm ID ø 14mm thickness 2mm		
	GEV No.	560111	Ref. No. —
	plain washer ID ø 4.3mm ED ø 9mm thickness 0.8mm SS Qty 20 pcs DIN 125A for thread M4		
	GEV No.	560131	Ref. No. —
	hexagonal nut thread M4 H 3.2mm WS 7 SS DIN/ISO DIN 934 / ISO 4032/8673 Qty 20 pcs		

1 electric components

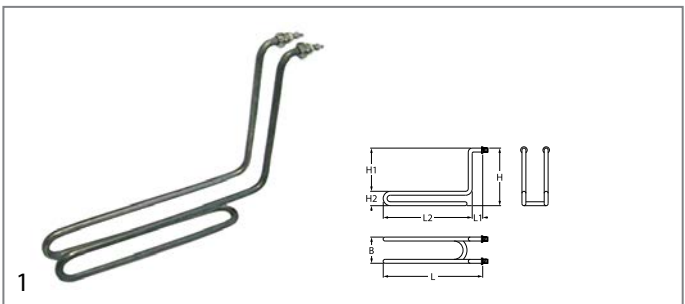

GEV No.	415720	Ref. No.	63.7.1068
description	heating element 1400W 230V heating circuits 1 L 275mm W 40mm H 210mm L1 15mm L2 260mm H1 165mm H2 45mm thread 1/4" mounting distance 32mm tube ø 8.5mm 2 hole fixing connection M4 fryer heaters windings 2		
For models:	FE07T, FE77T		
accessories for	415720		
	GEV No.	361182	Ref. No. —
	nut thread 1/4" H 5mm nickel-plated brass WS 17 Qty 1 pcs		
	GEV No.	510417	Ref. No. —
	flat gasket fibre ED ø 20mm ID ø 14mm thickness 2mm Qty 1 pcs		
	GEV No.	520228	Ref. No. —
	tooth lock washer ID ø 15.3mm ED ø 24mm steel Qty 1 pcs for thread M14		
	GEV No.	521103	Ref. No. —
	nut thread M4 H 3mm WS 7 brass Qty 20 pcs		
	GEV No.	521104	Ref. No. —
	washer ID ø 4.3mm ED ø 8mm thickness 0.5mm brass Qty 20 pcs for thread M4		
	GEV No.	550262	Ref. No. —
	flat gasket copper ED ø 20mm ID ø 14mm thickness 2mm		
	GEV No.	560111	Ref. No. —
	plain washer ID ø 4.3mm ED ø 9mm thickness 0.8mm SS Qty 20 pcs DIN 125A for thread M4		
	GEV No.	560131	Ref. No. —
	hexagonal nut thread M4 H 3.2mm WS 7 SS DIN/ISO DIN 934 / ISO 4032/8673 Qty 20 pcs		

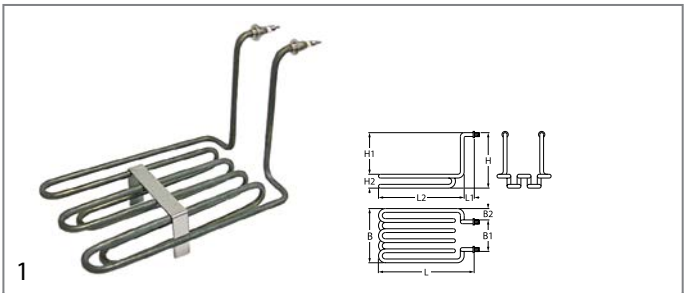

GEV No.	415722	Ref. No.	63.7.1067
description	heating element 3000W 230V heating circuits 1 L 280mm W 180mm H 200mm L1 25mm L2 255mm H1 160mm H2 40mm thread 1/4" mounting distance 76mm tube ø 8.5mm 2 hole fixing connection M4 connection length 28mm fryer heaters windings 6 W1 45mm W2 85mm		
For models:	FE07, FE77		
spare parts for	415722		
	GEV No.	510417	Ref. No. —
	flat gasket fibre ED ø 20mm ID ø 14mm thickness 2mm Qty 1 pcs		

accessories for	415722		
	GEV No.	521103	Ref. No. —
	nut thread M4 H 3mm WS 7 brass Qty 20 pcs		
	GEV No.	521104	Ref. No. —
	washer ID ø 4.3mm ED ø 8mm thickness 0.5mm brass Qty 20 pcs for thread M4		
	GEV No.	560111	Ref. No. —
	plain washer ID ø 4.3mm ED ø 9mm thickness 0.8mm SS Qty 20 pcs DIN 125A for thread M4		
	GEV No.	560131	Ref. No. —
	hexagonal nut thread M4 H 3.2mm WS 7 SS DIN/ISO DIN 934 / ISO 4032/8673 Qty 20 pcs		

heating elements for hot counters

	GEV No.	415699	Ref. No.	63.7.1090
description	heating element 400W 230V heating circuits 1 L 298mm W 138mm tube ø 6.3mm connection male faston 6.3mm dry heating element for vitrine 2 hole fixing thread M12x1.25 mounting distance 132mm			
For models:	VEC 10, VEC 20, VEC 510, VEC 520			

	GEV No.	417667	Ref. No.	63.7.1026
description	heating element 450W 230V heating circuits 1 L 188mm W 280mm tube ø 6.5mm			



heating elements for refrigeration

condensing trays heated



	GEV No.	750003	Ref. No.	750003
description	condensing tray heated L 240mm W 240mm H 75mm 230V 650W connect with power contactor			
spare parts for	750003			
	GEV No.	348139	Ref. No.	—
	float switch 250V 1A 1NO or 1NC thread M16x1.5 ø 17.4mm L 100.5mm mounting ø 28mm cable length 1500mm temp.-resist. -20 up to +90°C			

Table continues overleaf



spare parts for 750003	
	GEV No. 418732 Ref. No. — heating element 650W 230V L 280mm W 95mm H 87mm L1 65mm L2 215mm cable length 1500mm connection distance 86mm tube ø 8.5mm heating circuits 1 immersion heater
accessories for 750003	
	GEV No. 380185 Ref. No. — power relays Italiana Relè 230VAC 30A 1NO connection F6.3 bracket mounting dimensions 36.5x32.2x51.8mm manuf. no. A10-230AC-FA



1	
GEV No. 750004	Ref. No. 750004
description	condensing tray heated L 380mm W 240mm H 75mm 230V 750W with float switch
spare parts for 750004	
	GEV No. 348139 Ref. No. — float switch 250V 1A 1NO or 1NC thread M16x1.5 ø 17.4mm L 100.5mm mounting ø 28mm cable cable length 1500mm temp.-resist. -20 up to +90°C
	GEV No. 418733 Ref. No. — heating element 750W 230V L 430mm W 95mm H 98mm L1 85mm L2 345mm cable length 1500mm connection cable connection distance 86mm tube ø 8.5mm heating circuits 1 immersion heater
accessories for 750004	
	GEV No. 380185 Ref. No. — power relays Italiana Relè 230VAC 30A 1NO connection F6.3 bracket mounting dimensions 36.5x32.2x51.8mm manuf. no. A10-230AC-FA

1	
GEV No. 415726	Ref. No. 63.7.1012
description	heating element 750W 230V L 180mm W 170mm H 18mm W1 45mm W2 80mm connection length 26mm tube ø 6.3mm windings 3 connection M4 dry heating element
For models:	PD 1020 L, PD 1020 M, PD 1020 R, PD 2020 L, PD 2020 M, PD 2020 R, PS 1010 L, PS 1010 R, PS 2010 L, PS 2010 LB, PS 2010 R, PS 2010 RB

1	
GEV No. 415727	Ref. No. 63.7.1011
description	heating element 900W 230V L 180mm W 175mm H 15mm W1 42mm W2 91mm connection length 24mm tube ø 6.3mm windings 3 connection M4 dry heating element
For models:	PD 1020 L, PD 1020 LB, PD 1020 M, PD 1020 MB, PD 1020 R, PD 1020 RB, PD 2020 L, PD 2020 LB, PD 2020 M, PD 2020 MB, PD 2020 R, PD 2020 RB, PS 1010 L, PS 1010 LB, PS 1010 R, PS 1010 RB, PS 2010 L, PS 2010 LB, PS 2010 R, PS 2010 RB

heating elements for contact grills

1	
GEV No. 415724	Ref. No. 63.7.1015
description	heating element 1200W 230V L 192mm W 305mm H 10mm W1 102mm W2 100mm tube ø 6mm windings 5 connection M4 dry heating element
For models:	B800E, PM 1015 L, PM 1015 LB, PM 1015 R, PM 1015 RB, PM 2015 L, PM 2015 LB, PM 2015 R, PM 2015 RB

1	
GEV No. 415725	Ref. No. 63.7.1016
description	heating element 900W 230V L 194mm W 300mm H 17mm W1 100mm W2 100mm connection length 25mm tube ø 6.3mm windings 5 connection M4 dry heating element
For models:	PM 1015 L, PM 1015 R, PM 2015 L, PM 2015 R



heating elements for pizza ovens

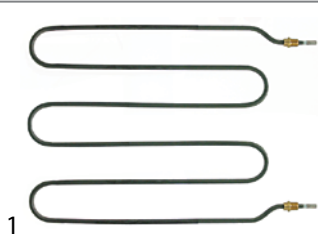

GEV No.	416188	Ref. No.	63.7.1088
description	heating element 800W 230V L 365mm W 290mm L1 30mm L2 40mm L3 295mm W1 18mm W2 254mm thread 1/4" mounting distance 246mm connection length 33mm connection male faston 6.3mm windings 3 tube ø 6.3mm heating circuits 1 dry heating element 2 hole fixing		
For models:	FP36, FP36R, FP66R		
spare parts for	416188		
	GEV No.	361182	Ref. No. —
	nut thread 1/4" H 5mm nickel-plated brass WS 17 Qty 1 pcs		

heating elements for rolling grills



GEV No.	416189	Ref. No.	63.7.1081 63.7.1098
description	heating element 220W 240V heating circuits 1 L 359mm connection distance 359mm tube ø 8.5mm dry heating element roller grill		
For models:	CW6, CW8		

heating elements for salamanders/toast-

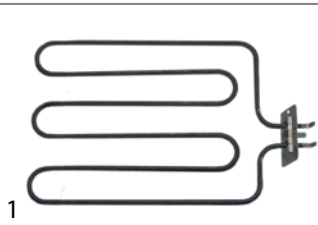

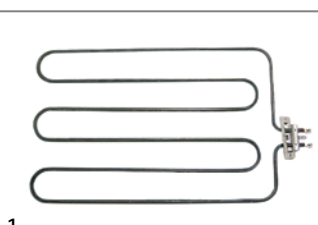

GEV No.	415723	Ref. No.	63.7.1022
description	heating element 1900W 230V L 305mm W 260mm L1 25mm L2 280mm W1 90mm W2 30mm hole distance 60mm connection male faston 6.3mm tube ø 6.3mm flange length 70mm flange width 36mm heating circuits 1 hole ø 4.9mm tilt flange dry heating element H 6.3mm		
For models:	SE2, SE2M		



GEV No.	415757	Ref. No.	63.7.1021
description	heating element 2400W 230V L 425mm W 260mm L1 25mm L2 400mm W1 90mm W2 30mm hole distance 60mm connection male faston 6.3mm tube ø 6.3mm flange length 70mm flange width 36mm heating circuits 1 hole ø 5mm tilt flange dry heating element		
For models:	SE1, SE1M		



GEV No.	415698	Ref. No.	63.7.1093
description	heating element 1000W 230V L 330mm W 140mm 2 hole fixing thread M12x1.25 mounting distance 133mm connection male faston 6.3mm dry heating element tube ø 6.3mm heating circuits 1 connection length 33mm H 6.3mm		
For models:	SEPC, T930, T960		
spare parts for	415698		
	GEV No.	521110	Ref. No. —
	flat gasket fibre ED ø 20mm ID ø 13mm thickness 2mm Qty 1 pcs		
accessories for	415698		
	GEV No.	550681	Ref. No. —
	nut thread M12x1.25 H 5mm WS 17 brass Qty 1 pcs		

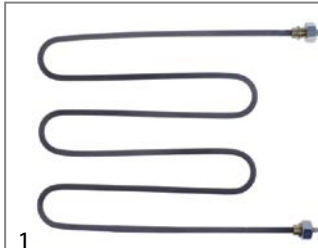

GEV No.	416199	Ref. No.	63.7.1083
description	heating element 1600W 230V L 270mm W 210mm 2 hole fixing thread M12x1.5 mounting distance 204mm connection male faston 6.3mm dry heating element tube ø 6.3mm heating circuits 1		
For models:	B830, B840, B860, B870		

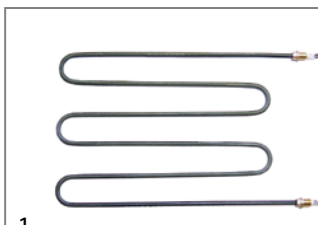

GEV No.	415694	Ref. No.	63.7.1084
description	heating element 2000W 230V L 350mm W 205mm 2 hole fixing thread M12x1.25 mounting distance 198mm connection male faston dry heating element tube ø 6.3mm heating circuits 1 connection length 33mm H 6.3mm		
For models:	B800E, B840, SEP, SEPC		

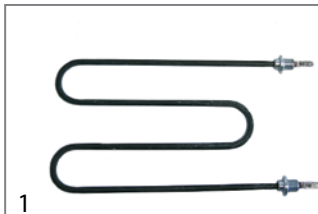

GEV No.	415697	Ref. No.	63.7.1092
description	heating element 800W 230V L 225mm W 135mm 2 hole fixing thread M12x1 mounting distance 128mm connection male faston 6.3mm dry heating element tube ø 6.3mm heating circuits 1 H 6.3mm		
For models:	T920, T940		





heating cartridges

			
1			
GEV No.	416190	Ref. No.	63.7.1040
description	heating cartridge 80W 230V ø 24mm L 102mm cable length 345mm dry heating element		
For models:	HD20, HD40, PT40, PT60		

quartz heating elements

			
1			
GEV No.	693058	Ref. No.	63.7.0002
description	insulator female L 7mm hole ø 5.5mm ø 13mm		

			
1			
GEV No.	419205	Ref. No.	63.7.1097
description	quartz heating element 300W 115V L 360mm ø 11.5mm connection male faston 6.3mm		

			
1			
GEV No.	416187	Ref. No.	63.7.1094
description	quartz heating element 400W 115V L 260mm ø 12mm connection male faston 6.3mm mounting distance 24.8mm		
For models:	SEPC, T920, T940		

			
1			
GEV No.	419204	Ref. No.	63.7.1095
description	quartz heating element 500W 115V L 360mm ø 11.5mm connection male faston 6.3mm		
For models:	T930, T960		

			
1			
GEV No.	415312	Ref. No.	63.7.1094 old version
description	quartz heating element L 285mm ø 11.5mm 800W 230V W 130mm connection eye double		

radiation heaters

square

			
1			
GEV No.	416192	Ref. No.	63.7.1100
description	radiation heater L 225mm W 225mm 750W 230V heating circuits 1 connections 2 square		
For models:	PDV 3020 L, PDV 3020 R, PDV-3020-McDonalds, PSV 3010 L, PSV 3010 R		

accessories

			
1			
GEV No.	693058	Ref. No.	63.7.0002
description	insulator female L 7mm hole ø 5.5mm ø 13mm		

			
1			
GEV No.	693057	Ref. No.	63.7.0001
description	insulator male L 10mm hole ø 8.4mm ø 13mm		

hot plates

round

with radiused edge

for domestic and commercial kitchens

			
1			
GEV No.	416191	Ref. No.	63.7.1030
description	hot plate ø 90mm 450W 230V connection 3 screw clamps with 8mm spill ring		
For models:	HD20, HD40		



energy regulators

EGO

1-circuit



GEV No.	380015	Ref. No.	63.7.0601
description	energy regulator 230V 13A single-circuit turn direction right shaft ø 6x4.6mm shaft L 23mm mounting thread M4 power release 6-100% no. 50.57021.010		
For models:	CW6, CW8, HD20, HD40, SE1, SE1M, SEP, SEPC, TN30 PLUS		

accessories

knobs



GEV No.	110075	Ref. No.	63.7.0280
description	knob energy regulator 1-3 t.max.°C ø 50mm shaft ø 6x4.6mm shaft flat upper black		
For models:	SE1, SE1M		

accessories for 110075



GEV No.	110135	Ref. No.	—
description	rosette knob up to ø 52mm		

thermostats

bi-metal thermostats

safety bi-metal thermostats



GEV No.	390026	Ref. No.	63.7.0670
description	bi-metal safety thermostat hole distancemm switch-off temp. 70°C 1NC 1-pole 16A connection F6.3 M4		

bi-metal thermostats



GEV No.	390850	Ref. No.	63.7.0680
description	bi-metal thermostat hole distancemm switch-off temp. 250°C 1NC 1-pole 10A 250V connection F6.3 1 hole fixing for contact grill		
For models:	PDV-3020-McDonalds		

control and safety thermostats

EGO

control thermostats

55.10/19_ series



GEV No.	375232	Ref. No.	63.7.0635
description	thermostat t.max. 320°C temperature range 55-320°C 1-pole capillary pipe isolatedmm gland nut		
For models:	FP36, FP36R, FP66R		

safety thermostats

56._ series





GEV No.	390610	Ref. No.	63.7.0632
description	safety thermostat switch-off temp. 235°C 1-pole 16A probe ø 3mm probe L 190mm capillary pipe 1000mm capillary pipe isolated 640mm gland nut probe SS		
For models:	FE04, FE07, FE07T, FE77, FE77T		



IMIT / TEMPOMATIC / ARATHERMO

control thermostats



GEV No.	390006	Ref. No.	63.7.0658
description	thermostat t.max. 86°C temperature range 0-86°C 1-pole 1CO 16A probe ø 6.5mm probe L 95mm capillary pipe 1500mm capillary pipe isolatedmm gland nut shaft ø 6x4.6mm shaft L 19mm rotation 270°		
For models:	VEC 510, VEC 520		
accessories for	390006		
	GEV No.	110100	Ref. No. —
	knob thermostat t.max. 90°C 0-90°C ø 42mm shaft ø 6x4.6mm shaft flat -135° black		
	GEV No.	110105	Ref. No. —
	rosette knob ø 42mm ø 56mm zero mark		

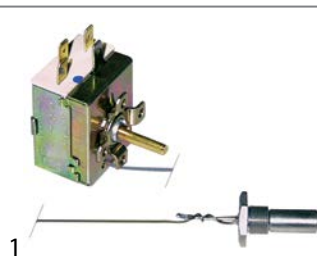

GEV No.	375318	Ref. No.	63.7.0655
description	thermostat t.max. 90°C temperature range 0-90°C 1-pole 1CO 15A probe ø 11mm probe L 36mm capillary pipe 600mm capillary pipe isolated 550mm gland nut shaft ø 6x4.6mm shaft L 19mm shaft position upper rotation 270° screw-in probe probe thread M14x1		
For models:	B830, B850, BM11, BM12, BM13, BM23, VEC 10, VEC 20		

TECASA

control thermostats



GEV No.	390027	Ref. No.	63.7.0640
description	thermostat t.max. 190°C temperature range 50-190°C 1-pole 1NO 16A probe ø 3mm probe L 145mm capillary pipe 880mm capillary pipe isolated 680mm gland nut shaft ø 6x4.6mm rotation 270° probe material SS		
For models:	F620, F640, FE04, FE07, FE07T, FE44, FE77, FE77T		

safety thermostats



GEV No.	390028	Ref. No.	63.7.0630
description	safety thermostat switch-off temp. 230°C 1-pole 16A probe ø 3mm probe L 155mm capillary pipe 890mm capillary pipe isolated 600mm gland nut probe SS		
For models:	F620, F640, TN30 PLUS		

PRODIGY / FIRT

control thermostats with operation switch

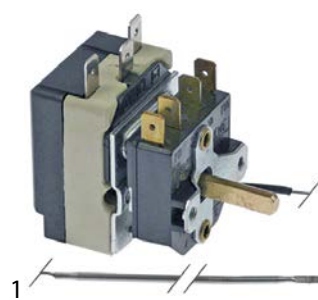

GEV No.	390791	Ref. No.	63.7.0651
description	thermostat t.max. 270°C temperature range 63-270°C 1-pole 1CO 16A probe ø 3mm probe L 185mm capillary pipe 950mm capillary pipe isolated 55mm gland nut shaft ø 6x4.6mm shaft L 16.5mm shaft position upper rotation 270° outer switch 2NO		
For models:	PD 1020 L, PD 1020 LB, PD 1020 M, PD 1020 MB, PD 1020 R, PD 1020 RB, PD 2020 L, PD 2020 LB, PD 2020 M, PD 2020 MB, PD 2020 R, PD 2020 RB, PDV 3020 L, PDV 3020 R, PDV-3020-McDonalds, PM 1015 L, PM 1015 LB, PM 1015 R, PM 1015 RB, PM 2015 L, PM 2015 LB, PM 2015 R, PM 2015 RB, PS 2010 L, PS 2010 LB, PS 2010 R, PS 2010 RB, PS 2010 L, PS 2010 LB, PS 2010 R, PS 2010 RB, PSV 3010 L, PSV 3010 R		

switches and momentary switches

rocker/momentary rocker switches

30x22mm



GEV No.	301061	Ref. No.	63.7.0861
description	rocker switch mounting measurements 30x22mm orange 2NO 250V 16A illuminated connection male faston 6.3mm ambient temperature max. 125/55°C protection IP40		
For models:	B800E, B830, B840, PT40, PT60, SEPC		



GEV No.	345599	Ref. No.	63.7.0862
description	rocker switch mounting measurements 30x22mm orange/orange 1NO/1NO/indicator light 250V 16A illuminated connection male faston 6.3mm ambient temperature max. 85/125°C protection IP40		
For models:	B860, HD20, HD40, T920, T930		



			
1			
GEV No.	301077	Ref. No.	63.7.0863
description	rocker switch mounting measurements 30x22mm orange/orange 1NO/indicator light 250V 16A illuminated connection male faston 6.3mm ambient temperature max. 100/55°C protection IP40		
For models:	VEC 510, VEC 520		

push/momentary push switches

30x22mm

			
1			
GEV No.	301086	Ref. No.	63.7.0860
description	push switch mounting measurements 30x22mm black 2NO 250V 12A 0-1 connection male faston 6.3mm ambient temperature max. 85/55°C protection IP54 with protective collar		
For models:	BM11, BM12, BM13, BM23, CW6, CW8, FE04, FE07, FE07T, FE77, FE77T		

microswitches

pin-plunger actuated

M10

			
1			
GEV No.	347216	Ref. No.	63.7.0880
description	microswitch with plunger thread M10x0.75 thread L 14mm 250V 10A 1CO connection male faston 6.3mm stroke 7.5mm mounting distance 22mm L 28mm ambient temperature max. 125°C type NR6K5 actuating force: 260g		
For models:	F620, F640, FE04, FE07, FE07T, FE77, FE77T		

rotary switches

BRETER

rotary switches

			
1			
GEV No.	347618	Ref. No.	63.7.0852
description	rotary switch 2 0-1 sets of contacts 2 type LE2-20-1752 600V 20A shaft ø 8x9mm shaft L 20mm shaft star-shaped connection screw		
For models:	B850, T920, T930		

			
1			
GEV No.	345572	Ref. No.	63.7.0850
description	rotary switch 2 0-1 sets of contacts 2 type LE2-20-1752 690V 16A shaft ø 7x8mm shaft L 20mm shaft star-shaped connection screw clamp		
For models:	TN30, TN30 PLUS		

accessories

			
1			
GEV No.	347619	Ref. No.	63.6.0281
description	knob with bezel 0-1		

encoders and potentiometers

			
1			
GEV No.	300138	Ref. No.	63.7.0628
description	potentiometer		

lamps

indicator lights

indicator lights 2-piece (lens and indicator lamp)

indicator light lenses

ø10mm (type SRZ-3)

			
1			
GEV No.	359125	Ref. No.	57.2.9.9.0.01
description	indicator light housings mounting measurements ø10mm red round Qty 1 pcs		

ø12mm (type SDK-3)

			
1			
GEV No.	359275	Ref. No.	51.2.9.99.00.0T
description	indicator light housings mounting measurements ø12mm clear Qty 1 pcs		





			
1			
GEV No.	359277	Ref. No.	51.2.9.99.03.0T
description	indicator light housings mounting measurements ø12mm green Qty 1 pcs		

			
1			
GEV No.	359276	Ref. No.	51.2.9.99.01.0T
description	indicator light housings mounting measurements ø12mm red Qty 1 pcs		

			
1			
GEV No.	359278	Ref. No.	51.2.9.99.04.0T
description	indicator light housings mounting measurements ø12mm yellow Qty 1 pcs		

<p>ø12mm (type SDY-3)</p>			
			
1			
GEV No.	359280	Ref. No.	41.2.0.0.00.0.0
description	indicator light housings mounting measurements ø12mm clear round Qty 1 pcs		

			
1			
GEV No.	359262	Ref. No.	41.2.0.00.03.00
description	indicator light housings mounting measurements ø12mm green round Qty 1 pcs		

			
1			
GEV No.	359261	Ref. No.	41.2.0.00.01.00
description	indicator light housings mounting measurements ø12mm red round Qty 1 pcs		

			
1			
GEV No.	359260	Ref. No.	41.2.9.00.04.00
description	indicator light housings mounting measurements ø12mm yellow round Qty 1 pcs		

<p>indicator lamps for socket type SRZ / SDK / SDY / SFK</p>			
			
1			
GEV No.	359130	Ref. No.	21.3.2.40.00.0T
description	indicator lamp 230V clear connection male faston 6.3mm ø 8mm		

<p>indicator lights (complete)</p>			
<p>ø10mm</p>			
<p>with plug-in socket</p>			
			
1			
GEV No.	359139	Ref. No.	63.7.0811
description	indicator light ø 10mm green 230V connection male faston 6.3mm Qty 1 pcs		
For models:	F620, F640, TN30 PLUS		

			
1			
GEV No.	359140	Ref. No.	63.7.0810
description	indicator light ø 10mm yellow 230V connection male faston 6.3mm Qty 1 pcs		
For models:	F620, F640		

<p>ø12mm</p>			
<p>with screw socket</p>			
			
1			
GEV No.	359994	Ref. No.	51.F.2.H.0.00
description	indicator light ø 12mm 400V clear connection male faston 6.3mm		

			
1			
GEV No.	359291	Ref. No.	51.F.2.H.7.03
description	indicator light ø 12mm 400V green connection male faston 6.3mm		

			
1			
GEV No.	359292	Ref. No.	51.F.2.H.0.01
description	indicator light ø 12mm 400V red connection male faston 6.3mm		

			
1			
GEV No.	359290	Ref. No.	51.F.2.H.0.04
description	indicator light ø 12mm 400V yellow connection male faston 6.3mm		





ø13mm

with plug-in socket



			
1			
GEV No.	359530	Ref. No.	53.2.0.0.0.00.0.0
description	indicator light housings mounting measurements ø13mm clear round		

			
1			
GEV No.	359282	Ref. No.	53.2.0.0.0.03.0.0
description	indicator light housings mounting measurements ø13mm green round		

			
1			
GEV No.	359281	Ref. No.	53.2.0.0.0.04.0.0
description	indicator light housings mounting measurements ø13mm orange round		

			
1			
GEV No.	359283	Ref. No.	53.2.0.0.0.01.0.0
description	indicator light housings mounting measurements ø13mm red round		

30x22mm

			
1			
GEV No.	359157	Ref. No.	63.7.0820
description	indicator light mounting measurements 30x22mm 230V green connection male faston 6.3mm temp.-resist. 125/55°C type RL2		
For models:	HD20, HD40, SE1, SE1M, SE2, SE2M, SEP, SEPC, SUV 66, T940, T960, TN30		
accessories for	359157		
			
	GEV No.	301036	Ref. No. —
	protective cover internal size 30x22mm for rocker switch mounting measurementsmm		

			
1			
GEV No.	359156	Ref. No.	63.7.0805
description	indicator light mounting measurements 30x22mm 230V yellow connection male faston 6.3mm temp.-resist. 125/55°C type RL2		
For models:	SE1, SE1M, SE2, SE2M, SEP, SEPC, T940, T960		

			
1			
GEV No.	359164	Ref. No.	63.7.0821
description	indicator light mounting measurements 30x22mm 230V green/white connection male faston 6.3mm temp.-resist. 125°C		
For models:	BM11, BM12, BM13, BM23, CW6, CW8, FE04, FE07, FE07T, FE77, FE77T, PD 1020 L, PD 1020 LB, PD 1020 M, PD 1020 MB, PD 1020 R, PD 1020 RB, PD 2020 L, PD 2020 LB, PD 2020 M, PD 2020 MB, PD 2020 R, PD 2020 RB, PDV 3020 L, PDV 3020 R, PDV-3020-McDonalds, PM 1015 L, PM 1015 LB, PM 1015 R, PM 1015 RB, PM 2015 L, PM 2015 LB, PM 2015 R, PM 2015 RB, PS 1010 L, PS 1010 LB, PS 1010 R, PS 1010 RB, PS 2010 L, PS 2010 LB, PS 2010 R, PS 2010 RB, PSV 3010 L, PSV 3010 R		

timers

mechanical timers

			
1			
GEV No.	350044	Ref. No.	63.7.0665 63.7.0666
description	timer C20 2-pole operation time 15min impulse mechanical 2NO at 250V 16A permanent position no shaft ø 6x4.6mm shaft 6x4.6mm shaft L 20mm mounting distance 28mm connection lateral for toaster		
For models:	FP36, FP36R, FP66R, T920, T930, T940, T960		
accessories for	350044		
			
	GEV No.	110285	Ref. No. —
	knob switch zero mark t.max.°C ø 40mm shaft ø 6x4.6mm shaft flat upper black		

contactors

ISKRA (FANAL)

power contactors

			
1			
GEV No.	380213	Ref. No.	63.7.0890
description	power contactor resistive load 20A 230VAC (AC3/400V) 8.5A/5.5kW main contacts 3NO auxiliary contacts 1NO connection screw connection type Fanal DSL7 10 type ISKRA K07M 10		
For models:	FE07T, FE77T		



transformers

encapsulated transformers

PMA



1

GEV No.	400583	Ref. No.	63.7.0701
description	transformer primary 230VAC secondary 24VAC 10VA secondary 0.4A connection screw 50Hz		
For models:	BM11, BM12, BM13, BM23, FE04, FE07, FE07T, FE44, FE77, FE77T, TN30 PLUS		

electronics

PCBs



1

GEV No.	400579	Ref. No.	63.7.0627
description	PCB		
For models:	TN30 PLUS		



evaporation and condensing trays

condensing trays heated

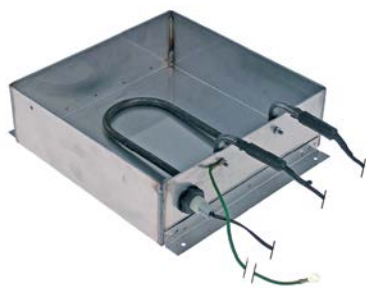
producer-specific





1

GEV No.	750003	Ref. No.	750003	
description	condensing tray heated L 240mm W 240mm H 75mm 230V 650W connect with power contactor			
spare parts for	750003			
	GEV No.	348139	Ref. No.	—
	float switch 250V 1A 1NO or 1NC thread M16x1.5 ø 17.4mm L 100.5mm mounting ø 28mm cable cable length 1500mm temp.-resist. -20 up to +90°C			
	GEV No.	418732	Ref. No.	—
	heating element 650W 230V L 280mm W 95mm H 87mm L1 65mm L2 215mm cable length 1500mm connection distance 86mm tube ø 8.5mm heating circuits 1 immersion heater			

accessories for	750003			
	GEV No.	380185	Ref. No.	—
	power relays Italiana Relè 230VAC 30A 1NO connection F6.3 bracket mounting dimensions 36.5x32.2x51.8mm manuf. no. A10-230AC-FA			



1

GEV No.	750004	Ref. No.	750004	
description	condensing tray heated L 380mm W 240mm H 75mm 230V 750W with float switch			
spare parts for	750004			
	GEV No.	348139	Ref. No.	—
	float switch 250V 1A 1NO or 1NC thread M16x1.5 ø 17.4mm L 100.5mm mounting ø 28mm cable cable length 1500mm temp.-resist. -20 up to +90°C			
	GEV No.	418733	Ref. No.	—
	heating element 750W 230V L 430mm W 95mm H 98mm L1 85mm L2 345mm cable length 1500mm connection cable connection distance 86mm tube ø 8.5mm heating circuits 1 immersion heater			
accessories for	750004			
	GEV No.	380185	Ref. No.	—
	power relays Italiana Relè 230VAC 30A 1NO connection F6.3 bracket mounting dimensions 36.5x32.2x51.8mm manuf. no. A10-230AC-FA			

motors

gear motors

for conveyor toaster



1

GEV No.	499246	Ref. No.	63.7.0752
description	gear motor 24V H 85mm L 137mm W 65mm type K9119052 KENTA voltage DC shaft ø 6x8mm		
For models:	TN30 PLUS		



for grills



1

GEV No.	499209	Ref. No.	63.7.0751 old
description	gear motor KENTA type K9113069 23W 230V 50Hz 2.5rpm shaft ø 6x8mm L 108mm W 58mm H 66mm		

miscellaneous



1

GEV No.	500496	Ref. No.	63.7.0752 old
description	gear motor TRIAL type R5/G4.5 24V voltage DC shaft ø 5x8mm L 100mm W 70mm H 120mm for toaster		

electric accessories

terminals

connection terminals with strain relief



1

GEV No.	550356	Ref. No.	63.7.0543
description	power terminal block 2-pole max 450V max. 16A cable ø 15mm cross section 1.5mm ²		
For models:	CW6, CW8, HD20, HD40, PT40, PT60, VEC 510, VEC 520		

equipment-specific units

for convection ovens/combi-steamers

door mechanics

accessories



1

GEV No.	694840	Ref. No.	694840
description	guide bar SS L 725mm		

for hot dog machines

lids



1

GEV No.	693066	Ref. No.	63.4.0401
description	lid for hot dog machine		
For models:	HD20, HD40		

glass cylinders



1

GEV No.	693067	Ref. No.	63.6.7010
description	glass cylinder ø 200mm H 204mm		
For models:	HD20, HD40		

miscellaneous





1

GEV No.	691359	Ref. No.	63.0.0113
description	mounting angle		



			
1			
GEV No.	691358	Ref. No.	63.0.0112
description	mounting angle L 207mm		

water containers			
			
1			
GEV No.	693068	Ref. No.	63.4.0441
description	water container for hot dog machine		
For models:	HD20, HD40		

gear wheels			
			
1			
GEV No.	693062	Ref. No.	63.3.1003
description	gear wheel teeth 11 shaft intake ø 8mm ø 31mm hub ø 18mm stainless steel		
For models:	CW6, CW8		

for pizza ovens			
firebricks			
			
1			
GEV No.	850014	Ref. No.	63.6.7401
description	firebrick L 410mm W 362mm H 15mm grooved delivery freight forwarding company only		

for rolling grills			
pipes			
bushes			
			
1			
GEV No.	693060	Ref. No.	63.3.0801
description	bushing PTFE		
For models:	CW6, CW8		

pipes			
			
1			
GEV No.	693059	Ref. No.	63.3.2101
description	pipe with gear wheel for roller grill		
For models:	CW6, CW8		

gear wheels			
			
1			
GEV No.	693062	Ref. No.	63.3.1003
description	gear wheel teeth 11 shaft intake ø 8mm ø 31mm hub ø 18mm stainless steel		
For models:	CW6, CW8		

for toasters			
pliers			
			
1			
GEV No.	690010	Ref. No.	63.3.3095
description	plier for toaster H 180mm total length 100mm		
For models:	T920, T930, T940, T960		

knobs							
universal knobs							
							
1							
GEV No.	110075	Ref. No.	63.7.0280				
description	knob energy regulator 1-3 t.max.°C ø 50mm shaft ø 6x4.6mm shaft flat upper black						
For models:	SE1, SE1M						
accessories for	110075						
		<table border="1"> <tr> <td>GEV No.</td> <td>110135</td> <td>Ref. No.</td> <td>—</td> </tr> </table>	GEV No.	110135	Ref. No.	—	
GEV No.	110135	Ref. No.	—				
	rosette knob up to ø 52mm						

handles and hand wheels

cylindrical handles

fixed



1			
GEV No.	540237	Ref. No.	63.6.0102
description	cylindrical handle thread M8 ø 23mm L 65mm		
For models:	SE1, SE1M, SE2, SE2M		

hinges

oven hinges



1			
GEV No.	690029	Ref. No.	35.249.70
description	torsion spring ø 25.8mm L2 71mm wire gauge ø 3.7mm L1 79mm L3 13mm		

equipment feet and end caps

screw-in feet



1			
GEV No.	691344	Ref. No.	63.6.0021
description	equipment foot thread M8 thread L 20mm ø 23mm H 12mm Qty 1 pcs		
For models:	BM11, BM12, BM13, BM23, CW6, CW8, HD20, HD40, PD 1020 L, PD 1020 LB, PD 1020 M, PD 1020 MB, PD 1020 R, PD 1020 RB, PD 2020 L, PD 2020 LB, PD 2020 M, PD 2020 MB, PD 2020 R, PD 2020 RB, PDV 3020 L, PDV 3020 R, PDV-3020-McDonalds, PM 1015 L, PM 1015 LB, PM 1015 R, PM 1015 RB, PM 2015 L, PM 2015 LB, PM 2015 R, PM 2015 RB, PS 1010 L, PS 1010 LB, PS 1010 R, PS 1010 RB, PS 2010 L, PS 2010 LB, PS 2010 R, PS 2010 RB, PSV 3010 L, PSV 3010 R, PT40, PT60, TN30, TN30 PLUS, VEC 510, VEC 520		

shelves and shelf rails

grates

producer-specific



1			
GEV No.	970301	Ref. No.	63.3.3002
description	grate		
For models:	SE2		

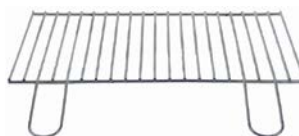

1			
GEV No.	970305	Ref. No.	63.3.0003
description	grate W 370mm D 230mm chrome-plated steel		

transmission technology and ball bearings

chains

roller chains 05B-1 single



1			
GEV No.	693063	Ref. No.	63.3.1100
description	chain DIN/ISO 05 B-1 splitting 8mm links 35 internal width 3mm roller ø 5mm single closed		
For models:	CW6		



1			
GEV No.	693064	Ref. No.	63.3.1101
description	chain DIN/ISO 05 B-1 splitting 8mm links 52 internal width 3mm roller ø 5mm single		
For models:	CW8		



springs

torsion springs





GEV No.	690081	Ref. No.	63.3.0853
description	torsion spring \varnothing 19.4mm L2 36mm wire gauge \varnothing 3.3mm mounting pos. left L1 42mm L3 36mm Qty 1 pcs		
For models:	PD 1020 L, PD 1020 M, PD 1020 R, PM 1015 L, PM 1015 R, PS 1010 L, PS 1010 R		
accessories for	690081		
	GEV No.	690080	Ref. No. 63.3.0852
	torsion spring \varnothing 19.4mm L2 37mm wire gauge \varnothing 3.4mm mounting pos. right L1 42mm L3 37mm Qty 1 pcs		



GEV No.	690080	Ref. No.	63.3.0852
description	torsion spring \varnothing 19.4mm L2 37mm wire gauge \varnothing 3.4mm mounting pos. right L1 42mm L3 37mm Qty 1 pcs		
For models:	PD 1020 L, PD 1020 M, PD 1020 R, PM 1015 L, PM 1015 R, PS 1010 L, PS 1010 R		
accessories for	690080		
	GEV No.	690081	Ref. No. 63.3.0853
	torsion spring \varnothing 19.4mm L2 36mm wire gauge \varnothing 3.3mm mounting pos. left L1 42mm L3 36mm Qty 1 pcs		

	GEV No.	700731	Ref. No.	63.3.0862
	description	torsion spring \varnothing 21mm L1 120mm L2 63mm L3 63mm wire gauge \varnothing 3mm folding grill		
	For models:	PDV-3020-McDonalds		

	GEV No.	700084	Ref. No.	63.3.0861
	description	torsion spring \varnothing 22mm L1 119mm L2 64mm L3 64mm wire gauge \varnothing 3.5mm		
	For models:	PD 2020 L, PD 2020 M, PD 2020 R, PDV 3020 L, PDV 3020 R, PM 2015 L, PM 2015 R, PS 2010 L, PS 2010 R, PSV 3010 L, PSV 3010 R		

	GEV No.	690029	Ref. No.	35.249.70
	description	torsion spring \varnothing 25.8mm L2 71mm wire gauge \varnothing 3.7mm L1 79mm L3 13mm		

compression springs

	GEV No.	700176	Ref. No.	63.3.0870
	description	compression spring \varnothing 19.5mm L 45mm wire gauge \varnothing 1.5mm		
	For models:	HD20, HD40, PT40, PT60		

fastening material

fasteners

retaining rings

DIN 471

	GEV No.	693061	Ref. No.	63.3.0505
	description	retaining ring shaft \varnothing 25mm thickness 1.2mm steel DIN 471		
	For models:	CW6, CW8		

B		
bi-metal thermostats	8, 8	
C		
condensing trays heated	13	
contactors	12	
control thermostats	8, 9	
E		
electric accessories	14	
energy regulators	8	
F		
fasteners	17	
fastening material	17	
G		
grates	16	
H		
heating cartridges	7	
heating elements	3	
heating elements for bain maries	3	
heating elements for contact grills	5	
heating elements for fryers	3	
heating elements for pizza ovens	6	
heating elements for refrigeration	4	
heating elements for salamanders/toasters	6	
hot plates	7	
I		
indicator lights	10	
indicator lights (complete)	11	
L		
lamps	10	
M		
mechanical timers	12	
microswitches	10	
motors	13	
O		
oven hinges	16	
P		
push/momentary push switches	10	
Q		
quartz heating elements	7	
R		
radiation heaters	7	
retaining rings	17	
rocker/momentary rocker switches	9	
rotary switches	10	
S		
safety bi-metal thermostats	8	
safety thermostats	8	
shelves and shelf rails	16	
switches and momentary switches	9	
T		
terminals	14	
thermostats	8	
timers	12	
transformers	13	