



GAS COMPONENTS



ELECTRIC COMPONENTS



WATER TECHNOLOGY



MECHANICAL COMPONENTS



TOOLS

Spare parts suitable for

BRASILIA

Find the complete and up-to-date range of products in our GEV Webshop



Manufacturer catalogue

The most important spare parts and accessories arranged clearly for every manufacturer

- ✓ Complete product range and all appliance data always up to date in the GEV Webshop
- ✓ Alphabetical Index at the end of the catalogue

GEV Webshop

www.gev-online.co.uk

www.gev-online.com









- 🔍 Add to Favourites
- 🔍 Sign In with email address and usual password
- 🔍 Easy-order – place several items in your basket at the same time
- 🔍 Quick Item search – no login needed

heating elements







heating elements for coffee machine

			
1			
GEV No.	417280	Ref. No.	10432.2.00.08
description	heating element 1000W 220V heating circuits 1 ϕ 50mm H 60mm W1 45mm H1 20mm H2 40mm mounting distance 35mm thread M10x1 windings 4 tube ϕ 6.3mm immersion heater 2 hole fixing connection male faston 6.3mm		
For models:	205-Exclusive, Bolero, Excelsior-OR, Excelsior-Standard, Gradisca-Res-tyling, Opus, Opus-B03-OR, Opus-OR		

			
1			
GEV No.	417035	Ref. No.	00625.2.00.08
description	heating element 1200W 230V heating circuits 1 ϕ 55mm H 66mm W1 55mm H1 30mm H2 36mm mounting distance 42mm thread 1/4" copper windings 3 tube ϕ 8.5mm immersion heater 2 hole fixing connection male faston 6.3mm		
For models:	BELLE EPOQUE JUNIOR, CLUB, LADY, MBM GOLF, OFFICE RB2		
accessories for	417035		
	GEV No.	Ref. No.	00839.0.00.02
	528231		
	O-ring Viton thickness 2.62mm ID ϕ 12.37mm Qty 1 pcs		
	GEV No.	Ref. No.	—
	550932		
	nut thread 1/2" H 6mm WS 27 SS Qty 1 pcs		

			
1			
GEV No.	417081	Ref. No.	01911.2.00.08
description	heating element 1350W 230V heating circuits 1 thread 1" L 140mm W 22mm H 23mm tube ϕ 8.5mm connection 6.3 immersion heater flange with thread		
For models:	Roma-Cappuccino		
accessories for	417081		
	GEV No.	Ref. No.	—
	510404		
	flat gasket fibre ED ϕ 44mm ID ϕ 34mm thickness 2mm Qty 1 pcs		
	GEV No.	Ref. No.	18661.0.00.02 18661.2.00.02
	528018		
	flat gasket PTFE ED ϕ 41mm ID ϕ 33mm thickness 3mm size 1" Qty 1 pcs		

			
1			
GEV No.	417034	Ref. No.	05430.0.00.04 05430.2.00.08
description	heating element 1400W 230V heating circuits 1 L 228mm W 45mm hole distance 68mm hole ϕ 6.5mm tube ϕ 8.5mm connection M3x0.6 immersion heater 2 hole flange		
For models:	CAPPUCCINO		

			
1			
GEV No.	417173	Ref. No.	02286.2.00.08
description	heating element 1700W 230V heating circuits 3 thread 1/4" L 135mm W 26mm H 29mm tube ϕ 8.5mm connection M3 immersion heater flange with thread		
For models:	Belle-Epoque		
accessories for	417173		
	GEV No.	Ref. No.	—
	510405		
	flat gasket fibre ED ϕ 56mm ID ϕ 42mm thickness 2mm for thread 1/4" Qty 1 pcs		
	GEV No.	Ref. No.	01263.0.00.03
	527169		
	hexagonal nut thread M3 H 2.8mm WS 5.5 brass Qty 1 pcs		
	GEV No.	Ref. No.	00826.0.00.02 02286
	528021		
	flat gasket PTFE ED ϕ 53mm ID ϕ 42.5mm thickness 3mm Qty 1 pcs equiv. no. 12001/02286 suitable for Astoria/Aurora/Brasilia/Wega		
	GEV No.	Ref. No.	—
	560110		
	plain washer ID ϕ 3.2mm ED ϕ 7mm thickness 0.5mm SS Qty 20 pcs DIN 125A for thread M3		
	GEV No.	Ref. No.	—
	560130		
	hexagonal nut thread M3 H 2.4mm WS 5.5 SS DIN/ISO DIN 934 / ISO 4032/8673 Qty 20 pcs		

			
1			
GEV No.	417030	Ref. No.	00614.2.00.02 00614.2.00.08
description	heating element 1800W 230V heating circuits 2 mounting ϕ 40mm hole distance 57mm L 177mm W 26mm H 53mm L1 35mm L2 60mm L3 74mm H1 24mm H2 29mm hole ϕ 10mm tube ϕ 8.5mm connection M6 immersion heater 3 hole flange suitable for BRASILIA, VIBIEMME		
For models:	100, 105, 105SL, 205, Century, Firenze, Firenze-SL, Firenze-SL-Raised, PORTOFINO		











			
1			
GEV No.	415006	Ref. No.	00613.2.00.08
description	heating element 1880W 230V heating circuits 1 thread 1/4" L 147mm W 35mm H 26mm connection M4 immersion heater flange with thread copper		
spare parts for	415006		
	GEV No.	Ref. No.	—
	510405		
	flat gasket fibre ED ϕ 56mm ID ϕ 42mm thickness 2mm for thread 1/4" Qty 1 pcs		



Table continues overleaf

accessories for 415006			
	GEV No.	520232	Ref. No. —
nut thread 1¼" H 5mm nickel-plated brass WS 47 Qty 1 pcs			
	GEV No.	521103	Ref. No. —
nut thread M4 H 3mm WS 7 brass Qty 20 pcs			
	GEV No.	521104	Ref. No. —
washer ID ø 4.3mm ED ø 8mm thickness 0.5mm brass Qty 20 pcs for thread M4			
	GEV No.	528021	Ref. No. 00826.0.00.02 02286
flat gasket PTFE ED ø 53mm ID ø 42.5mm thickness 3mm Qty 1 pcs equiv. no. 12001/02286 suitable for Astoria/Aurora/Brasilia/Wega			
	GEV No.	560111	Ref. No. —
plain washer ID ø 4.3mm ED ø 9mm thickness 0.8mm SS Qty 20 pcs DIN 125A for thread M4			
	GEV No.	560131	Ref. No. —
hexagonal nut thread M4 H 3.2mm WS 7 SS DIN/ISO DIN 934 / ISO 4032/8673 Qty 20 pcs			



			
1			
GEV No.	417032	Ref. No.	00613.2.00.08
description	heating element 2000W 230V heating circuits 1 thread 1¼" L 170mm W 35mm H 33mm tube ø 8.5mm connection M6x1 immersion heater flange with thread		
For models:	MILLENNIO, PORTOFINO AMERICA		
accessories for 417032			
	GEV No.	510405	Ref. No. —
flat gasket fibre ED ø 56mm ID ø 42mm thickness 2mm for thread 1¼" Qty 1 pcs			
	GEV No.	528021	Ref. No. 00826.0.00.02 02286
flat gasket PTFE ED ø 53mm ID ø 42.5mm thickness 3mm Qty 1 pcs equiv. no. 12001/02286 suitable for Astoria/Aurora/Brasilia/Wega			

			
1			
GEV No.	417196	Ref. No.	00627.2.00.08
description	heating element 2400W 220V heating circuits 2 thread 1¼" L 230mm W 33mm H 23mm connection M4 immersion heater flange with thread		
For models:	Belle-Epoque		
accessories for 417196			
	GEV No.	510405	Ref. No. —
flat gasket fibre ED ø 56mm ID ø 42mm thickness 2mm for thread 1¼" Qty 1 pcs			
	GEV No.	528021	Ref. No. 00826.0.00.02 02286
flat gasket PTFE ED ø 53mm ID ø 42.5mm thickness 3mm Qty 1 pcs equiv. no. 12001/02286 suitable for Astoria/Aurora/Brasilia/Wega			



			
1			
GEV No.	417080	Ref. No.	01378
description	heating element 2400W 230V heating circuits 2 thread 1¼" L 225mm W 24mm H 38mm tube ø 8mm connection male faston 6.3mm immersion heater connection length 18mm flange with thread		
accessories for 417080			
	GEV No.	510405	Ref. No. —
flat gasket fibre ED ø 56mm ID ø 42mm thickness 2mm for thread 1¼" Qty 1 pcs			
	GEV No.	528021	Ref. No. 00826.0.00.02 02286
flat gasket PTFE ED ø 53mm ID ø 42.5mm thickness 3mm Qty 1 pcs equiv. no. 12001/02286 suitable for Astoria/Aurora/Brasilia/Wega			

			
1			
GEV No.	417031	Ref. No.	00615.2.00.08
description	heating element 3000W 230V heating circuits 2 mounting ø 40mm hole distance 59mm L 327mm W 28mm H 52mm L1 31mm L2 59mm L3 240mm H1 24mm H2 28mm windings 2 hole ø 10mm tube ø 8.5mm connection M6x1 immersion heater 3 hole flange suitable for BRASILIA		
For models:	100, 105, 105SL, 205, 205-Exclusive, Century, Century-Restyling, DeCurtis-CAMME, DeCurtis-DIG, DeCurtis-LEVA, Firenze, Firenze-SL, Firenze-SL-Raised, PORTOFINO, Portofino-Restyling		
accessories for 417031			
	GEV No.	528013	Ref. No. —
gasket ID ø 40mm fibre thickness 4mm hole ø 11mm hole distance 57mm for heating element coffee machine parts			

			
1			
GEV No.	417033	Ref. No.	04995.2.00.08
description	heating element 3200W 230V heating circuits 2 L 415mm W 44mm H 25mm hole distance 68mm hole ø 6.5mm tube ø 8.5mm L1 35mm L2 50mm L3 330mm connection M3x0.6 2 hole fixing immersion heater		

			
1			
GEV No.	417095	Ref. No.	01834.2.00.08
description	heating element 3500W 230V heating circuits 2 mounting ø 39mm hole distance 57mm L 330mm W 34mm H 53mm L1 30mm L2 70mm L3 225mm H1 24mm H2 29mm windings 2 hole ø 11mm tube ø 8.3mm connection M6 immersion heater 3 hole flange		
accessories for 417095			
	GEV No.	528013	Ref. No. —
gasket ID ø 40mm fibre thickness 4mm hole ø 11mm hole distance 57mm for heating element coffee machine parts			
	GEV No.	528740	Ref. No. 00819.0.00.02
gasket ID ø 44mm PTFE thickness 3.5mm hole ø 9.5mm hole distance 58mm suitable for ITALCREM, VISACREM for heating element coffee machine parts			







			
GEV No.	417446	Ref. No.	00616.2.00.08
description	heating element 4000W 230V heating circuits 2 mounting \varnothing 38.5mm hole distance 57mm L 342mm W 26mm H 51mm L1 35mm L2 50mm L3 257mm H1 25mm H2 26mm windings 2 hole \varnothing 10mm tube \varnothing 8mm connection M6 immersion heater 3 hole flange		
For models:	100, 105, 105SL, 205, 205-Exclusive, Century, Century-Restyling, DeCurtis-CAMME, DeCurtis-DIG, DeCurtis-LEVA, Firenze, Firenze-SL, Firenze-SL-Raised, PORTOFINO, Portofino-Restyling		
accessories for	417446		
	GEV No.	Ref. No.	Qty
	528740	00819.0.00.02	—
	gasket ID \varnothing 44mm PTFE thickness 3.5mm hole \varnothing 9.5mm hole distance 58mm suitable for ITALCREM, VISACREM for heating element coffee machine parts		

			
GEV No.	417213	Ref. No.	00617.2.00.08
description	heating element 4000W 230V heating circuits 2 mounting \varnothing 40mm hole distance 57mm L 485mm W 25mm H 53mm L1 30mm L2 60mm L3 385mm H1 24mm H2 29mm windings 2 hole \varnothing 10mm tube \varnothing 8mm connection M6 immersion heater 3 hole flange suitable for BRASILIA, VIBIEMME		
For models:	105, 105SL, 205, Century, Firenze		

			
GEV No.	417086	Ref. No.	04996.2.00.08
description	heating element 4200W 230V heating circuits 2 L 535mm W 44mm H 23mm hole distance 69mm hole \varnothing 6.5mm tube \varnothing 8.5mm L1 30mm L2 40mm L3 465mm connection 1/8" 2 hole fixing immersion heater H1 13mm H2 10mm		

			
GEV No.	417282	Ref. No.	01835.2.00.08
description	heating element 5000W 230V heating circuits 2 mounting \varnothing 40mm hole distance 58mm L 460mm W 25mm H 54mm L1 40mm L2 70mm L3 350mm H1 24mm H2 30mm windings 2 hole \varnothing 1mm tube \varnothing 8.3mm connection M6 immersion heater 3 hole flange		
For models:	205, 205-Exclusive, Agile, Cadetta, Century, Century-Restyling, DeCurtis-CAMME, DeCurtis-DIG, DeCurtis-LEVA, Excelsior-OR, Excelsior-Standard, Executive, Gradisca, Gradisca-Restyling, Gradisca-Take-Away, Maior, Maior-OR, Maior-Plus, Opus, Opus-B03-OR, Opus-OR, Opus-Sublima, Portofino-Restyling, Roma, Roma-OR, Roma-OR-170		

			
GEV No.	417172	Ref. No.	05391.2.00.08
description	heating element 5500W 230/400V heating circuits 3 mounting \varnothing 40mm hole distance 57mm L 460mm W 39mm H 58mm L1 35mm L2 65mm L3 360mm H1 28mm H2 30mm windings 3 hole \varnothing 10mm tube \varnothing 8.5mm connection M3 immersion heater 3 hole flange suitable for BRASILIA		
For models:	205, Century-Restyling, Executive, Gradisca, Gradisca-Restyling, Gradisca-Take-Away, Maior, Maior-OR, Maior-Plus, Portofino-Restyling, Roma, Roma-OR, Roma-OR-170		
accessories for	417172		
	GEV No.	Ref. No.	Qty
	527169	01263.0.00.03	—
	hexagonal nut thread M3 H 2.8mm WS 5.5 brass Qty 1 pcs		
	GEV No.	Ref. No.	Qty
	560110	—	—
	plain washer ID \varnothing 3.2mm ED \varnothing 7mm thickness 0.5mm SS Qty 20 pcs DIN 125A for thread M3		

accessories for	417172		
	GEV No.	Ref. No.	Qty
	560130	—	—
	hexagonal nut thread M3 H 2.4mm WS 5.5 SS DIN/ISO DIN 934 / ISO 4032/8673 Qty 20 pcs		

thermostats

bi-metal thermostats

safety bi-metal thermostats

			
GEV No.	390370	Ref. No.	12571.2.00.08
description	bi-metal safety thermostat hole distancemm switch-off temp. 145°C 1NC 1-pole 16A connection F6.3 M4		
For models:	205-Exclusive, Bolero, Excelsior-OR, Excelsior-Standard, Gradisca-Restyling, Opus, Opus-B03-OR, Opus-OR		

			
GEV No.	390372	Ref. No.	08703.2.00.08
description	bi-metal safety thermostat hole distancemm switch-off temp. 165°C 1NC 1-pole 16A connection F6.3 M4		
For models:	CAPPUCCINO, CLUB, CP1, CP2, LADY, MBM GOLF, MINIPODS, OFFICE RB2, Opus-Sublima, RB1, RB2, SECS, TOP CLASS		

bi-metal thermostats

			
GEV No.	390322	Ref. No.	09415.2.00.08
description	bi-metal thermostat hole distancemm switch-off temp. 100°C 1NC 1-pole 16A connection F6.3 M4		
For models:	CLUB, LADY, MBM GOLF		

			
GEV No.	390152	Ref. No.	08701.2.00.08
description	bi-metal thermostat hole distancemm switch-off temp. 107°C 1NC 1-pole 16A connection F6.3 M4		
For models:	CLUB, LADY, MBM GOLF, SECS, TOP CLASS		

			
GEV No.	375160	Ref. No.	10157.2.00.08
description	bi-metal thermostat hole distancemm switch-off temp. 110°C 1NC 1-pole 16A connection F6.3 M4		
For models:	Bolero, CLUB, LADY, MBM GOLF		



			
1			
GEV No.	390129	Ref. No.	06525.2.00.08
description	bi-metal thermostat hole distancemm switch-off temp. 125°C 1NC 1-pole 16A connection F6.3 M4		
For models:	MINIPODS		

			
1			
GEV No.	390323	Ref. No.	08702.2.00.08
description	bi-metal thermostat hole distancemm switch-off temp. 145°C 1NC 1-pole 16A connection F6.3 M4		
For models:	CLUB, LADY, MBM GOLF		

			
1			
GEV No.	390128	Ref. No.	06524.2.00.08
description	bi-metal thermostat hole distancemm switch-off temp. 95°C 1NC 1-pole 16A connection F6.3 M4		
For models:	MINIPODS, TOP CLASS		

control and safety thermostats

various



control thermostats

			
1			
GEV No.	390114	Ref. No.	00651.4.00.08
description	thermostat t.max. 110°C temperature range fixed 110°C 1-pole		
For models:	CLUB, LADY, TOP CLASS		

switches and momentary switches

rocker/momentary rocker switches

19x13mm

			
1			
GEV No.	301068 ¹	Ref. No.	20050.2.00.08
description	rocker switch mounting measurements 19x13mm yellow 2NO 250V 13A illuminated 0-I connection male faston 4.8mm protection IP40		
For models:	Excelsior-OR, Excelsior-Standard		
accessories for	301068		
	GEV No.	301064	Ref. No. —
	protective cover for pressure switch external size 23.4x17.4mm internal size 19x13mm H 7.5mm clear mounting measurementsmm		

¹illuminated

28x13.5mm			
			
1			
GEV No.	346143	Ref. No.	01919.0.00.08
description	rocker switch mounting measurements 27.4x12.4mm white 1NO 250V 10A 0-I connection male faston 6.3mm ambient temperature max. 85°C protection IP40		
For models:	BFD		

30x22mm			
			
1			
GEV No.	301060	Ref. No.	08474.2.00.08
description	rocker switch mounting measurements 30x22mm red 2NO 250V 16A illuminated connection male faston 6.3mm ambient temperature max. 125/55°C protection IP40		
For models:	Bolero, Maior, Maior-OR, Maior-Plus, Roma, Roma-OR, Roma-OR-170		



			
1			
GEV No.	301076	Ref. No.	07545
description	momentary rocker switch mounting measurements 30x22mm red 2NO 250V 16A illuminated START connection male faston 6.3mm ambient temperature max. 125/55°C protection IP40 mounting ømm male faston 6.3mm		

			
1			
GEV No.	346049	Ref. No.	06534.2.00.08
description	rocker switch mounting measurements 30x22mm red 2NO 250V 16A illuminated cup connection male faston 6.3mm ambient temperature max. 125/55°C protection IP40		
For models:	MINIPODS		

			
1			
GEV No.	346047	Ref. No.	07545.2.00.08
description	rocker switch mounting measurements 30x22mm red 2NO 250V 16A illuminated flash connection male faston 6.3mm ambient temperature max. 125/55°C protection IP40		
For models:	MINIPODS		

			
1			
GEV No.	346046	Ref. No.	07547.2.00.08
description	rocker switch mounting measurements 30x22mm red 2NO 250V 16A illuminated steam connection male faston 6.3mm ambient temperature max. 85°C protection IP40		
For models:	MINIPODS		





labelled			
			
1			
GEV No.	346142	Ref. No.	03632.2.00.08
description	rocker switch mounting measurements 30x22mm orange 2NO 250V 16A illuminated 0-I connection male faston 6.3mm ambient temperature max. 85°C protection IP65 with cover cap		
For models:	MAC64, MAC64-On-Demand, MC, RR45-A, RR45-DEL, RR45-On-Demand, RR45-PST, RR45-S, RR45-SILENT, RR55-AE, RR55-On-Demand, RR65-AE, RR65-SE		
accessories for	346142		
			
GEV No.	301036	Ref. No.	—
description	protective cover internal size 30x22mm for rocker switch mounting measurementsmm		

			
1			
GEV No.	345151 ¹	Ref. No.	01975.2.00.08
description	push switch mounting ø 25mm orange 2NO 250V 16A illuminated connection male faston 6.3mm ambient temperature max. 85°C protection IP40		
For models:	100, 105, 105SL, 205, 205-Exclusive, Cadetta, CAPPUCCINO, Century, Century-Restyling, Executive, Firenze, Firenze-SL, Firenze-SL-Raised, Gradisca, Gradisca-Restyling, Gradisca-Take-Away, Maior, Maior-OR, Maior-Plus, MILLENNIO, PORTOFINO, PORTOFINO AMERICA, Portofino-Restyling, Roma, Roma-Cappuccino, Roma-OR, Roma-OR-170, SECS, TOP CLASS		

¹illuminated

push/momentary push switches

ø25mm			
			
1			
GEV No.	346002	Ref. No.	00661.2.00.08
description	momentary push switch mounting ø 25mm red 2NO 250V 16A connection male faston 6.3mm ambient temperature max. 85°C protection IP40		
For models:	BELLE EPOQUE JUNIOR, Belle-Epoque, CLUB, MBM GOLF		

			
1			
GEV No.	345155	Ref. No.	00745.2.00.08
description	push switch mounting ø 25mm red 2NO 250V 16A illuminated connection male faston 6.3mm ambient temperature max. 85°C protection IP40		
For models:	LADY		

			
1			
GEV No.	345152 ¹	Ref. No.	01976.2.00.08
description	momentary push switch mounting ø 25mm orange 2NO 250V 16A illuminated connection male faston 6.3mm ambient temperature max. 85°C protection IP40		
For models:	Belle-Epoque, CAPPUCCINO		

			
1			
GEV No.	345160 ¹	Ref. No.	00663.2.00.08
description	push switch mounting ø 25mm red 2NO 250V 16A illuminated connection male faston 6.3mm ambient temperature max. 85°C protection IP40		
For models:	BELLE EPOQUE JUNIOR, CLUB, MBM GOLF		

¹illuminated

			
1			
GEV No.	346003	Ref. No.	00660.2.00.08
description	momentary push switch mounting ø 25mm red 1NO/indicator light 250V 16A illuminated connection male faston 6.3mm ambient temperature max. 85°C protection IP65		
For models:	BELLE EPOQUE JUNIOR, CLUB, MBM GOLF		

			
1			
GEV No.	345153	Ref. No.	00664.2.00.08
description	push switch mounting ø 25mm red 2NO/indicator light 250V 16A connection male faston 6.3mm ambient temperature max. 85°C protection IP40		
For models:	LADY		

microswitches

roller-lever actuated

microswitches

			
1			
GEV No.	346137	Ref. No.	10275.2.00.08
description	microswitch with handle with a switch 250V 5A 1CO connection soldering connection L 14mm L1 16.5mm ambient temperature max. 125°C mounting distance 9mm type SS-5GL2 actuating force: 20g black lever length 18mm		
For models:	CP1, CP2, OFFICE RB2		



pin-plunger actuated



1

GEV No.	345105	Ref. No.	00751.2.00.08
description	microswitch with plunger 250V 16A 1CO connection male faston 6.3mm L 28mm ambient temperature max. 125°C mounting distance 22mm type SM-51 actuating force: 280g black		
For models:	MC, RR45-A, RR45-DEL, RR45-S, RR45-SILENT, RR55-AE, RR65-AE		

with push button

switches with snap-fit



1

GEV No.	346139	Ref. No.	10151.2.00.08
description	microswitch with plunger connection male faston		

system switches (ROLD)



1

GEV No.	347192	Ref. No.	18535.2.00.08	
description	switch 2NO 250V 16A connection male faston 6.3mm			
For models:	Agile, Cadetta, Opus, Opus-B03-OR, Opus-OR, Opus-Sublima			
accessories for	347192			
	GEV No.	347183	Ref. No.	—
	push button mounting ø 14.3mm chrome-plated			

rotary switches

BREMAS

A1700 series



1

GEV No.	346397	Ref. No.	17213.2.00.08	
description	rotary switch 3 0-1-2 sets of contacts 6 type CA020V200 400V 20A shaft ø 5x5mm shaft L 23mm shaft square connection screw			
For models:	Roma, Roma-OR, Roma-OR-170			
accessories for	346397			
	GEV No.	110619	Ref. No.	—
	knob switch zero mark t.max.°C ø 48mm shaft ø 5x5mm shaft flat black			

accessories



1

GEV No.	346399	Ref. No.	17234.2.00.08
description	rubber protection ø 50mm shaft ømm transparent Hmm Lmm		
For models:	Executive, Maior, Maior-OR, Maior-Plus, Roma, Roma-OR, Roma-OR-170		

BRETER

rotary switches



1

GEV No.	345112	Ref. No.	04991.2.00.08
description	rotary switch 20A shaft L 38mm shaft 5x5mm		
For models:	100, 105, 105SL, 205, 205-Exclusive, CAPPUCCINO, Century-Restyling, DeCurtis-CAMME, DeCurtis-DIG, DeCurtis-LEVA, Firenze, Gradisca, Gradisca-Restyling, Gradisca-Take-Away, MILLENNIO, Opus, Opus-B03-OR, Opus-OR, Opus-Sublima, PORTOFINO, PORTOFINO AMERICA, Portofino-Restyling		

accessories



1

GEV No.	111294	Ref. No.	18053.0.00.02
description	knob shaft 5x5 black		
For models:	Opus, Opus-B03-OR, Opus-OR, Opus-Sublima		

VM



1

GEV No.	346090	Ref. No.	00675.2.00.08
description	rotary switch		
For models:	Belle-Epoque, Firenze-SL, Firenze-SL-Raised, Roma, Roma-OR, Roma-OR-170		



1

GEV No.	345111	Ref. No.	00674.2.00.08
description	rotary switch 16A connection screw clamp 6-pole shaft 5x5mm		
For models:	Belle-Epoque, Firenze-SL, Firenze-SL-Raised, Roma, Roma-OR, Roma-OR-170		



miscellaneous



1			
GEV No.	400034	Ref. No.	01814.2.00.08
description	rotary switch 6 operating positions connection male faston		
For models:	Belle-Epoque		

lamps

indicator lights

indicator lights 2-piece (lens and indicator lamp)

indicator light lenses

ø10mm (type SR-3)



1			
GEV No.	359414	Ref. No.	02627.0.00.02
description	indicator light housings mounting measurements ø10mm yellow Qty 1 pcs		
For models:	105, 105SL, 205-Exclusive, Agile, Belle-Epoque, Bolero, Cadetta, CAPPUCCINO, Century-Restyling, DeCurtis-CAMME, DeCurtis-DIG, DeCurtis-LEVA, Excelsior-OR, Excelsior-Standard, Executive, Firenze-SL, Firenze-SL-Raised, Gradisca-Restyling, Gradisca-Take-Away, LADY, Maior, Maior-OR, Maior-Plus, Opus, Opus-B03-OR, Opus-OR, Opus-Sublima, PORTOFINO, PORTOFINO AM. SUPER, PORTOFINO AMERICA, Portofino-Restyling, Roma, Roma-Cappuccino, Roma-OR, Roma-OR-170, TOP CLASS		



1			
GEV No.	359412	Ref. No.	02628.0.00.02
description	indicator light lens yellow		
For models:	105, 105SL, Belle-Epoque, Cadetta, CAPPUCCINO, Century-Restyling, DeCurtis-CAMME, DeCurtis-DIG, DeCurtis-LEVA, Excelsior-OR, Excelsior-Standard, Executive, Firenze-SL, Firenze-SL-Raised, Gradisca-Restyling, Gradisca-Take-Away, Maior, Maior-OR, Maior-Plus, Portofino-Restyling, Roma, Roma-Cappuccino, Roma-OR, Roma-OR-170		

indicator lamps for socket type SA / SC / SD / SF / SR



1			
GEV No.	359814	Ref. No.	00668.2.00.08
description	indicator lamp 230V clear connection cable 400mm cable material silicone Qty 1 pcs		
For models:	105, 105SL, 205-Exclusive, Agile, Belle-Epoque, Bolero, Cadetta, CAPPUCCINO, Century-Restyling, DeCurtis-CAMME, DeCurtis-DIG, DeCurtis-LEVA, Excelsior-OR, Excelsior-Standard, Executive, Firenze-SL, Firenze-SL-Raised, Gradisca-Restyling, Maior, Maior-OR, Maior-Plus, MILLENNIO, Opus, Opus-B03-OR, Opus-OR, Opus-Sublima, PORTOFINO, Portofino-Restyling, Roma, Roma-Cappuccino, Roma-OR, Roma-OR-170		

solid state relays

CROUZET



1			
GEV No.	402294	Ref. No.	19258.2.00.08
description	solid state relay CROUZET 1 phase 25A 48-660V 90-280 L 58mm W 45mm screw type 84137111		
For models:	Excelsior-OR, Excelsior-Standard, Opus, Opus-B03-OR, Opus-OR		

relays

power relays

with male contacts

female contact 2.0mm

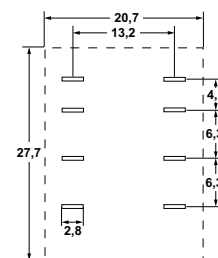

1			
GEV No.	380377	Ref. No.	01955.2.00.08
description	power relays FINDER 220-240VAC 10A 2CO connection F2 plug-in connection manuf. no. 55.32.8.230.0000 94.92.3 250V		
For models:	MAC64, MC		
accessories for	380377		
	GEV No.	Ref. No.	—
	380341		
	relay socket 4-pole contacts 12 300V voltage AC 6A Italiana Relè manuf. no. ZMD4		
	GEV No.	Ref. No.	—
	380378		
	relay socket 2-pole 55/85 dimensions 70.5x30x27mm 250V voltage AC 10A FINDER manuf. no. 94.72		
	GEV No.	Ref. No.	—
	380384		
	relay socket 2-pole contacts male faston 2.8mm 250V voltage AC 10A W 23mm for		
	GEV No.	Ref. No.	—
	380399		
	relay socket 4-pole dimensions 76.2x27x86.1mm 250V voltage AC 1A FINDER manuf. no. 94.94.3		

relay sockets



1

GEV No.	380136	Ref. No.	01920
description	relay socket 11-pole connection plug-in connection round 11-pole dimensions 65x28x40mm 250V voltage AC 10A Italiana Relè manuf. no. ZVE11		
accessories for	380136		
	GEV No.	380805	Ref. No. —
	support bracket		



1

GEV No.	380137	Ref. No.	01810.2.00.08
description	relay socket 8-pole connection plug-in connection round 8-pole dimensions 65x28x40mm 380V voltage AC 10A Italiana Relè manuf. no. ZVE8		
For models:	100, CAPPUCCINO, Century, Firenze, Gradisca, Gradisca-Take-Away, MILLENNIO, PORTOFINO, PORTOFINO AMERICA		
accessories for	380137		
	GEV No.	380805	Ref. No. —
	support bracket		

level relays

GICAR



1

GEV No.	400029	Ref. No.	02259 05441.2.00.08
description	level relay 230V voltage AC 11-pole connection plug-in connection round 11-pole		



1

GEV No.	400028	Ref. No.	01871.2.00.08
description	level relay 230V voltage AC 2NO 8-pole connection plug-in connection round 8-pole type NRL30/1E-2C/8		
For models:	100, CAPPUCCINO, Century, Firenze, Gradisca, Gradisca-Take-Away, MILLENNIO, PORTOFINO, PORTOFINO AMERICA		

miscellaneous



1

GEV No.	400264	Ref. No.	09522.2.00.08
description	level relay 230V		
For models:	100, 105, 105SL, 205, 205-Exclusive, Cadetta, CAPPUCCINO, Century, Century-Restyling, DeCurtis-CAMME, DeCurtis-DIG, DeCurtis-LEVA, Executive, Firenze, Firenze-SL, Firenze-SL-Raised, Gradisca, Gradisca-Take-Away, Maior, Maior-OR, Maior-Plus, MILLENNIO, PORTOFINO, Portofino-Restyling, Roma, Roma-OR, Roma-OR-170		



1

GEV No.	400265	Ref. No.	09948.2.00.08
description	level relay 230V voltage AC 3A type FE-MBC1G		
For models:	Century, Gradisca, Gradisca-Restyling, Gradisca-Take-Away, PORTOFINO		



1

GEV No.	400310	Ref. No.	01878.2.00.08
description	level relay 230V voltage AC connection male faston 6.3mm type SMA		
For models:	BELLE EPOQUE JUNIOR, CLUB, LADY, Opus-Sublima		

probes

producer-specific probes

probes

1



GEV No.	379452	Ref. No.	20553.2.00.08
description	temperature probe NTC cable glass fibre probe -40 up to +125°C cable -50 up to +350°C connection plug thread 1/4" probe ø3.5x20mm cable length 0.24m		
For models:	Opus-Sublima		

electronics

PCBs

1



GEV No.	400561	Ref. No.	10168.2.00.08
description	keypad PCB		
For models:	CP1, CP2, OFFICE RB2, RB1, RB2		

1



GEV No.	402977	Ref. No.	13420.2.00.08
description	PCB for coffee machine L 113mm W 97mm 230V 2-group H 38mm		
For models:	105, 105SL, 205, 205-Exclusive, Century, Century-Restyling, DeCurtis-CAMME, DeCurtis-DIG, DeCurtis-LEVA, Firenze, Firenze-SL, Firenze-SL-Raised, Gradisca, Gradisca-Restyling, Gradisca-Take-Away, Portofino-Restyling		

1



GEV No.	400566	Ref. No.	11242.2.00.08 17034.2.00.08
description	power PCB for dosing pump 230V		
For models:	RR45-A, RR45-DEL		

1



GEV No.	400268	Ref. No.	10438.2.00.08
description	relay PCB		
For models:	Century, Gradisca, Gradisca-Take-Away, PORTOFINO		

1



GEV No.	400269	Ref. No.	11738.2.00.08
description	relay PCB		
For models:	Century, Gradisca, Gradisca-Take-Away, PORTOFINO		

central units

1



GEV No.	400037	Ref. No.	01805.2.00.08
description	control box 1-group for coffee machine 230V type Cubik		
For models:	Belle-Epoque, Century, PORTOFINO		

1



GEV No.	400266	Ref. No.	09950.2.00.08
description	control box 2-group for coffee machine		
For models:	100, 105, 105SL, 205, Century, Gradisca, Gradisca-Take-Away, MILLENNIO, PORTOFINO		



1

GEV No.	400036	Ref. No.	01806.2.00.08
description	control box 2-group for coffee machine 230V		
For models:	Belle-Epoque		



1

GEV No.	400283	Ref. No.	01807
description	control box 3-group for coffee machine		



1

GEV No.	402275	Ref. No.	13420.2.00.08 + Stückliste
description	control box 2-group for coffee machine 230V		



1

GEV No.	400267	Ref. No.	09952.2.00.08
description	control box 3-group for coffee machine 230V type FE-MBC		
For models:	100, 105, 105SL, 205, Century, Gradisca, Gradisca-Take-Away, MILLENNIO, PORTOFINO		



1

GEV No.	402843	Ref. No.	13376.6.00.09
description	control box 2-group for coffee machine 230V		
For models:	205-Exclusive		



1

GEV No.	400284	Ref. No.	04965.2.00.08
description	control box 3-group for coffee machine 230V type MBAR 3SFF		
For models:	100, Century, Firenze, Firenze-SL, Firenze-SL-Raised, PORTOFINO		



1

GEV No.	402844	Ref. No.	13377.6.00.09
description	control box 3-4 group for coffee machine 230V		
For models:	205-Exclusive		



1

GEV No.	402996	Ref. No.	12743.0.00.02
description	control box empty L 125mm W 50mm H 106mm		
For models:	Opus, Opus-B03-OR, Opus-OR		





1

GEV No.	402995	Ref. No.	12744.0.00.02
description	lid L 138mm W 54mm		
For models:	205-Exclusive, Gradisca-Restyling, Opus, Opus-B03-OR, Opus-OR		



1

GEV No.	402276	Ref. No.	13421.2.00.08
description	PCB 3-group for coffee machine 230V		
For models:	105, 105SL, 205, 205-Exclusive, Century, Century-Restyling, De-Curtis-CAMME, DeCurtis-DIG, DeCurtis-LEVA, Firenze, Firenze-SL, Firenze-SL-Raised, Gradisca, Gradisca-Restyling, Gradisca-Take-Away, Portofino-Restyling		



1

GEV No.	402269	Ref. No.	21217.2.00.08
description	control box 2-group 230V 50/60Hz type 3d5 2GRCT XLC		
For models:	Cadetta		



1

GEV No.	402270	Ref. No.	21218.2.00.08
description	control box 3-group 230/240V 50/60Hz type 3d5 3GRCT XLC (SC)		
For models:	Cadetta		

dosing electronics

GICAR



1

GEV No.	402266	Ref. No.	16035.2.00.08
description	control box 2-group 230V 50/60Hz type 3d5 2GRCT XLC		
For models:	Executive, Maior, Maior-OR, Maior-Plus, Roma, Roma-OR, Roma-OR-170		



1

GEV No.	402267	Ref. No.	16036.2.00.08
description	control box 3-group 230V 50/60Hz type 3d5 3GRCT XLC		
For models:	Executive, Maior, Maior-OR, Maior-Plus, Roma, Roma-OR, Roma-OR-170		

keypads

front foils



1

GEV No.	400562	Ref. No.	10501.0.00.02
description	keypad foil		
For models:	CP1, CP2, OFFICE RB2, RB1, RB2		



1

GEV No.	403066	Ref. No.	N/A
description	keypad foil suitable for BRASILIA L 82.5mm W 55mm buttons 6		

keypad units



1

GEV No.	400039	Ref. No.	04962.2.00.08
description	keypad unit		
For models:	Century		



1

GEV No.	400271	Ref. No.	10138.2.00.08
description	keypad unit		
For models:	105, 105SL, 205		



1

GEV No.	400286	Ref. No.	05475.2.00.08
description	keypad unit		



1

GEV No.	400287	Ref. No.	06556.2.00.08
description	keypad unit		
For models:	PORTOFINO, PORTOFINO AMERICA		



1

GEV No.	400288	Ref. No.	10135.2.00.08
description	keypad unit		



1

GEV No.	400289	Ref. No.	09954.2.00.08
description	keypad unit		
For models:	PORTOFINO		





1

GEV No.	400291	Ref. No.	10136.2.00.08	
description	keypad unit			
For models:	Gradisca, Gradisca-Take-Away			
spare parts for	400291			
	GEV No.	403066	Ref. No.	N/A
	keypad foil suitable for BRASILIA L 82.5mm W 55mm buttons 6			



1

GEV No.	400346	Ref. No.	08494.2.00.08
description	keypad unit		
For models:	PORTOFINO		

			
1			
GEV No.	400347	Ref. No.	01812.2.00.08
description	keypad unit		
accessories for	400347		
	GEV No.	400348	Ref. No. 01494
	bezel for keypad		

			
1			
GEV No.	402295	Ref. No.	19424.2.00.08
description	keypad unit buttons 1 chrome-plated L 35mm W 25mm		
For models:	Agile		

			
1			
GEV No.	402287	Ref. No.	19427.2.00.08
description	keypad unit buttons 5 chrome-plated L 117mm W 45mm		
For models:	Agile, Cadetta		

			
1			
GEV No.	402292	Ref. No.	21493.2.00.08
description	keypad unit buttons 5 L 88mm W 60mm		
For models:	Maior, Maior-OR, Maior-Plus		

			
1			
GEV No.	402280	Ref. No.	13123.4.00.08 13123.4.00.09
description	keypad unit buttons 6 L 100mm W 90mm		
For models:	205-Exclusive, DeCurtis-CAMME, DeCurtis-DIG, DeCurtis-LEVA, Gradisca-Restyling, Portofino-Restyling		

			
1			
GEV No.	400038	Ref. No.	04961.2.00.08
description	keypad unit buttons 6 L 85mm W 57mm		
For models:	Century		

			
1			
GEV No.	402288	Ref. No.	21494.2.00.08
description	keypad unit coffee machine Executive buttons 5 chrome-plated L 117mm W 45mm		
For models:	Executive		

			
1			
GEV No.	402286	Ref. No.	17578.2.00.08
description	keypad unit coffee machine ROMA buttons 5 L 87mm W 59mm		
For models:	Roma, Roma-OR, Roma-OR-170		

			
1			
GEV No.	400227	Ref. No.	12583.2.00.08
description	keypad unit coffee machine ROMA buttons 6 L 88mm W 60mm		
For models:	Roma, Roma-OR, Roma-OR-170		

accessories

			
1			
GEV No.	400348	Ref. No.	01494
description	bezel for keypad		



solenoid valves

solenoid valves (water)

metal

ASCO

spare parts and accessories

O-rings



1

GEV No.	371095	Ref. No.	00833.0.00.02
description	O-ring Viton thickness 1.78mm ID ø 6.07mm Qty 1 pcs		
For models:	100, 105, 105SL, 205, 205-Exclusive, BELLE EPOQUE JUNIOR, Belle-Epoque, Cadetta, CAPPUCCINO, Century, Century-Restyling, CLUB, DeCurtis-CAMME, DeCurtis-DIG, DeCurtis-LEVA, Excelsior-OR, Excelsior-Standard, Executive, Firenze, Firenze-SL, Firenze-SL-Raised, Gradisca, Gradisca-Restyling, Gradisca-Take-Away, LADY, Maior, Maior-OR, Maior-Plus, MBM GOLF, MILLENNIO, MINIPODS, Opus, Opus-B03-OR, Opus-OR, Opus-Sublima, PORTOFINO, PORTOFINO AM. SUPER, PORTOFINO AMERICA, Portofino-Restyling, Roma-Cappuccino, SECS, TOP CLASS		

LUCIFER

spare parts and accessories

valve bodies



1

GEV No.	370061	Ref. No.	BF0201
description	solenoid valve body LUCIFER-PARKER 3-ways outer cone		



M&M

2-way

B-297 series



1

GEV No.	370096	Ref. No.	02269.4.00.08	
description	solenoid valve 2-ways 230VAC connection 1/8" L 30mm DN 2.5mm slide-on receptacle compact -10 up to 130°C M&M type series B-297 coil type 2700 membranes FKM (water) p max 5bar p min 0bar			
For models:	Agile, CAPPUCCINO			
spare parts for	370096			
	GEV No.	371022	Ref. No.	—
	solenoid coil M&M 230VAC 10VA 50Hz coil type 2700 seat ø 10mm			
accessories for	370096			
	GEV No.	371091	Ref. No.	—
	power socket plug type DIN 43650B cable lengthmm small			



1

GEV No.	370167	Ref. No.	10446.4.00.08	
description	solenoid valve 2-ways 24VDC connection 1/8" L 30mm DN 1.5mm slide-on receptacle compact -10 up to 130°C M&M type series B-297 coil type 2250 membranes FKM (water) p max 22bar p min 0bar			
For models:	CP2, OFFICE RB2, RB2			
accessories for	370167			
	GEV No.	371091	Ref. No.	—
	power socket plug type DIN 43650B cable lengthmm small			

OLAB

solenoid valves

2-way



1

GEV No.	370095	Ref. No.	09436.4.00.08
description	solenoid valve brass 2-ways 230VAC L 230mm Olab flange 20x27mm		
For models:	100, 105, 105SL, 205, 205-Exclusive, Belle-Epoque, Cadetta, CAPPUCCINO, Century, Century-Restyling, DeCurtis-CAMME, DeCurtis-DIG, DeCurtis-LEVA, Excelsior-OR, Excelsior-Standard, Executive, Firenze, Firenze-SL, Firenze-SL-Raised, Gradisca, Gradisca-Restyling, Gradisca-Take-Away, Maior, Maior-OR, Maior-Plus, MILLENNIO, Opus, Opus-B03-OR, Opus-OR, Opus-Sublima, PORTOFINO, PORTOFINO AM. SUPER, PORTOFINO AMERICA, Portofino-Restyling, Roma-Cappuccino		

PARKER

3-way

VE-128 series



1





GEV No.	370057	Ref. No.	01947.2.00.08 01947.4.00.08	
description	solenoid valve 3-ways 230VAC body outer cone DN 1.2mm slide-on receptacle DIN -20° up to 140°C PARKER type series VE-128 coil type ZB09 membranes ruby p max 10bar brass flange 32x32mm			
For models:	105, 105SL, 205, 205-Exclusive, Agile, Belle-Epoque, CAPPUCCINO, Century, Century-Restyling, Excelsior-OR, Excelsior-Standard, Executive, Firenze, Firenze-SL, Firenze-SL-Raised, Maior, Maior-OR, Maior-Plus, MILLENNIO, Opus, Opus-B03-OR, Opus-OR, PORTOFINO, PORTOFINO AM. SUPER, PORTOFINO AMERICA, Portofino-Restyling, Roma, Roma-Cappuccino, Roma-OR, Roma-OR-170, SECS, TOP CLASS			
spare parts for	370057			
	GEV No.	370062	Ref. No.	BF0201 BF0401 BF0501
	solenoid valve body PARKER 3-ways outer cone			

Table continues overleaf



spare parts for 370057	
	GEV No. 371029 Ref. No. — solenoid coil PARKER 230VAC 9VA coil type ZB09 seat ø 14mm H 33mm W 34mm D 43mm
accessories for 370057	
	GEV No. 371090 Ref. No. — power socket plug type DIN 43650A screw
	GEV No. 371095 Ref. No. 00833.0.00.02 O-ring Viton thickness 1.78mm ID ø 6.07mm Qty 1 pcs
	GEV No. 371100 Ref. No. — O-ring silicone thickness 1.78mm ID ø 6.07mm Qty 1 pcs

spare parts and accessories

valve bodies

	1		
GEV No. 370062	Ref. No.	BF0201 BF0401 BF0501	
description	solenoid valve body PARKER 3-ways outer cone		
accessories for 370062			
	GEV No. 371029	Ref. No.	—
solenoid coil PARKER 230VAC 9VA coil type ZB09 seat ø 14mm H 33mm W 34mm D 43mm			
	GEV No. 371030	Ref. No.	—
solenoid coil 24VDC 12VA coil type ZB12 seat ø 14mm			
	GEV No. 371033	Ref. No.	—
solenoid coil PARKER 230VAC 9VA coil type YB09 with cable seat ø 14mm			
	GEV No. 371036	Ref. No.	—
solenoid coil 24VAC 9VA coil type ZB09 seat ø 14mm			
	GEV No. 371095	Ref. No.	00833.0.00.02
O-ring Viton thickness 1.78mm ID ø 6.07mm Qty 1 pcs			
	GEV No. 371100	Ref. No.	—
O-ring silicone thickness 1.78mm ID ø 6.07mm Qty 1 pcs			

SIRAI

2-way

L256N series

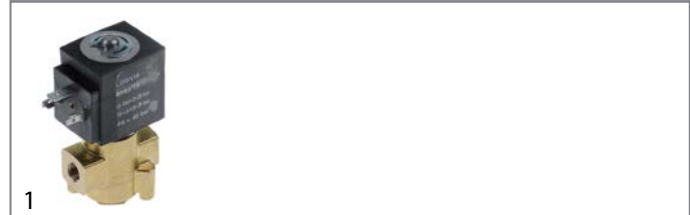

GEV No. 370565	Ref. No.	19895.4.00.08 22988.4.00.08
-----------------------	-----------------	--------------------------------

description solenoid valve brass 2-ways 230VAC inlet 1/8" outlet 1/8" connection 1/8" L 42mm DN 1.6mm -10 up to +90°C SIRAI coil type ZA30A membranes NBR p max 25bar p min 0bar

For models: Opus-Sublima

spare parts for 370565

	GEV No. 371047	Ref. No.	—
solenoid coil 230VAC 14VA SIRAI coil type ZA30A seat ø 14mm			

3-way

L334-R series

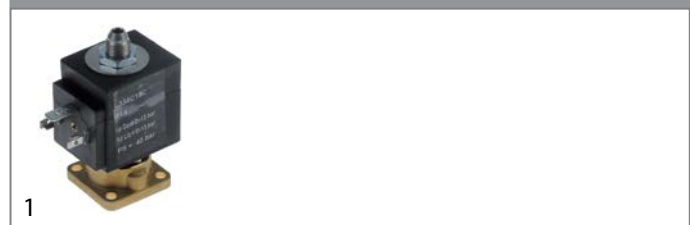

GEV No. 370563	Ref. No.	16194.4.00.08
-----------------------	-----------------	---------------

description solenoid valve 3-ways DN 1.6mm -10° up to +170°C p max 13bar 230V voltage AC flange 32x32mm

For models: 105, 105SL, Cadetta, Firenze-SL, Firenze-SL-Raised, Opus-Sublima

Solenoid valve - accessories



GEV No. 371095	Ref. No.	00833.0.00.02
-----------------------	-----------------	---------------

description O-ring Viton thickness 1.78mm ID ø 6.07mm Qty 1 pcs

For models: 100, 105, 105SL, 205, 205-Exclusive, BELLE EPOQUE JUNIOR, Belle-Epoque, Cadetta, CAPPUCCINO, Century, Century-Restyling, CLUB, DeCurtis-CAMME, DeCurtis-DIG, DeCurtis-LEVA, Excelsior-OR, Excelsior-Standard, Executive, Firenze, Firenze-SL, Firenze-SL-Raised, Gradisca, Gradisca-Restyling, Gradisca-Take-Away, LADY, Maior, Maior-OR, Maior-Plus, MBM GOLF, MILLENNIO, MINIPODS, Opus, Opus-B03-OR, Opus-OR, Opus-Sublima, PORTOFINO, PORTOFINO AM. SUPER, PORTOFINO AMERICA, Portofino-Restyling, Roma-Cappuccino, SECS, TOP CLASS

pressure switches

for coffee machines

ø 38mm



GEV No.	541155	Ref. No.	09935.2.00.08
description	pressure control ø 38mm pressure range 1-2.5bar pressure connection vertical 16A 250V coffee machine parts connection 1/8" pressure connection 1/8"		
For models:	CAPPUCCINO		



GEV No.	541154	Ref. No.	10598.2.00.08
description	pressure control ø 38mm pressure range 2-4bar pressure connection vertical preset at 2bar 16A 250V coffee machine parts connection 1/8" pressure connection 1/8"		
For models:	CP1, CP2, OFFICE RB2, RB1, RB2		

miscellaneous



GEV No.	541021	Ref. No.	00630.4.00.08
description	pressure control pressure range adjustable 0.5-1.4bar connection 1/4" 30A 3-pole type P302 coffee machine parts SIRAI		
For models:	100, 105, 105SL, 205, 205-Exclusive, Agile, Belle-Epoque, CAPPUCINO, Century, Century-Restyling, DeCurtis-CAMME, DeCurtis-DIG, DeCurtis-LEVA, Executive, Firenze, Firenze-SL, Firenze-SL-Raised, Gradisca, Gradisca-Restyling, Gradisca-Take-Away, Maior, Maior-OR, Maior-Plus, MILLENNIO, Opus, Opus-B03-OR, Opus-OR, Opus-Sublima, PORTOFINO, PORTOFINO AMERICA, Portofino-Restyling, Roma, Roma-Cappuccino, Roma-OR, Roma-OR-170		

accessories for 541021

GEV No.	550262	Ref. No.	—
----------------	--------	-----------------	---

 flat gasket copper ED ø 20mm ID ø 14mm thickness 2mm

GEV No.	890100	Ref. No.	—
----------------	--------	-----------------	---

 PTFE tape reel L 12m W 12mm -200 up to +260°C approval DIN-DVGW, KTW temperature-resistant, elastic for fine thread thickness 0.1mm

electrodes



GEV No.	401254	Ref. No.	18749.4.00.08 18749.8.00.08
description	level electrode 1/4" total length 74mm probe L 47mm insulated probe length 41mm PTFE insulated connection angled, male faston 6.3mm stainless steel ø 2.5mm marking S		
For models:	Roma-Cappuccino		

flow meters and flow sensors

flow meters

GICAR



GEV No.	400255	Ref. No.	08729.2.00.08
description	flow meter thread 1/8" stainless steel with LED plug-in connection approval NSF		
For models:	100, 105, 105SL, 205, 205-Exclusive, CAPPUCCINO, Century, Century-Restyling, Firenze, Firenze-SL, Firenze-SL-Raised, Gradisca, Gradisca-Restyling, Gradisca-Take-Away, MILLENNIO, Opus, Opus-B03-OR, Opus-OR, Opus-Sublima, PORTOFINO, PORTOFINO AMERICA, Roma-Cappuccino, TOP CLASS		

accessories for 400255

GEV No.	400256	Ref. No.	09013.0.00.08
----------------	--------	-----------------	---------------

 plug GICAR for flow meter

accessories



GEV No.	400256	Ref. No.	09013.0.00.08
description	plug GICAR for flow meter		
For models:	100, 105, 105SL, 205, CAPPUCCINO, MILLENNIO, PORTOFINO, PORTOFINO AMERICA		



VENDING



1

GEV No.	400565	Ref. No.	10264.2.00.08
description	flow meter hose ø 6mm plastic plug-in connection approval NSF DIGMESA		
For models:	CP1, CP2, OFFICE RB2, RB1, RB2		



1

GEV No.	500064	Ref. No.	04321.4.00.08 04321.4.00.09 15382.4.00.08
description	pump head PO204 FLUID-O-TECH L 82mm 200l/h connection 3/8" GAS with bypass brass clip connection for coffee machine shaft ø 4.8x11mm		
For models:	105, 105SL, 205, 205-Exclusive, Agile, Belle-Epoque, Century, Century-Restyling, Firenze, Firenze-SL, Firenze-SL-Raised, Gradisca, Gradisca-Restyling, Gradisca-Take-Away, Opus, Opus-B03-OR, Opus-OR, Portofino-Restyling, Roma, Roma-OR, Roma-OR-170		
accessories for	500064		
	GEV No.	520126	Ref. No. —
	clamp for pump/motor		

pumps

booster pumps II

pump motors

clip connection



1

GEV No.	500442	Ref. No.	00600.4.00.08
description	motor RPM type 11002708 165W 230V 50/60Hz connection clip capacitor 10µF shaft ø 13mm		
For models:	105, 105SL, 205, 205-Exclusive, Agile, Cadetta, Century, Century-Restyling, DeCurtis-CAMME, DeCurtis-DIG, DeCurtis-LEVA, Excelsior-OR, Excelsior-Standard, Executive, Firenze, Gradisca, Gradisca-Restyling, Gradisca-Take-Away, Maior, Maior-OR, Maior-Plus, Opus, Opus-B03-OR, Opus-OR, Opus-Sublima, Portofino-Restyling, Roma, Roma-OR, Roma-OR-170		

ROSSI



1

GEV No.	504238	Ref. No.	00604.4.00.08 21212.4.00.08
description	pump RF140SO9E ROSSI L 82mm 100l/h connection 3/8" NPT with bypass brass clip connection for coffee machine shaft ø 4.8x11mm		
For models:	100, 105, 105SL, 205, 205-Exclusive, Belle-Epoque, Century, Century-Restyling, DeCurtis-CAMME, DeCurtis-DIG, DeCurtis-LEVA, Excelsior-OR, Excelsior-Standard, Executive, Firenze, Firenze-SL, Firenze-SL-Raised, Gradisca, Gradisca-Restyling, Gradisca-Take-Away, Maior, Maior-OR, Maior-Plus, MILLENNIO, Opus, Opus-B03-OR, Opus-OR, PORTOFINO, Portofino-Restyling		

pump heads

FLUID-O-TECH



1

GEV No.	499088	Ref. No.	05399.4.00.08
description	pump head PA074 FLUID-O-TECH L 82mm 70l/h connection 3/8" GAS with bypass brass clip connection shaft ø 10.8x4.8mm approval NSF		
For models:	105, 105SL, 205, 205-Exclusive, Belle-Epoque, Century, Century-Restyling, Firenze, Firenze-SL, Firenze-SL-Raised, Gradisca, Gradisca-Restyling, Gradisca-Take-Away, Opus, Opus-B03-OR, Opus-OR, Portofino-Restyling		

vibration pumps



1

GEV No.	501515	Ref. No.	11723.4.00.08
description	vibration pump type EP8 230/240V 26W 50Hz inlet ø 6 outlet ø 1/8" ULKA		



condensators & interference suppression filters

operating capacitors

plastic



1

GEV No.	365014	Ref. No.	01897.2.00.08
description	operating capacitor capacity 12.5µF 450V tolerance 5%Hz ambient temperature max. -25 to +85°C ø 35mm L 70mm M8 plastic connection male faston 6.3mm 45S.C3DS.12.5 protection		
For models:	105, 105SL, 205, 205-Exclusive, Agile, Cadetta, Century, Century-Restyling, DeCurtis-CAMME, DeCurtis-DIG, DeCurtis-LEVA, Excelsior-OR, Excelsior-Standard, Executive, Firenze, Firenze-SL, Firenze-SL-Raised, Gradisca, Gradisca-Restyling, Gradisca-Take-Away, Maior, Maior-OR, Maior-Plus, MC, Opus, Opus-B03-OR, Opus-OR, Opus-Sublima, Portofino-Restyling, Roma, Roma-OR, Roma-OR-170, RR45-A, RR45-DEL, RR45-PST, RR45-S, RR45-SILENT, RR55-AE, RR55-On-Demand, RR65-AE, RR65-SE		



1

GEV No.	365021	Ref. No.	05444.2.00.08 09406.2.00.08
description	operating capacitor capacity 16µF 425V tolerance 5% 50/60Hz ambient temperature max. -25 to +85°C ø 35mm L 73mm single M8 plastic connection male faston 6.3mm 416.10.99 protection		
For models:	MAC64, MAC64-On-Demand, RR45-A, RR45-DEL, RR45-On-Demand, RR45-SILENT, RR55-On-Demand		



1

GEV No.	365022	Ref. No.	01962.2.00.08
description	operating capacitor capacity 40µF 400V tolerance 5%Hz ambient temperature max. -25 to +85°C ø 45mm L 95mm M8 plastic connection male faston 6.3mm protection		
For models:	105, 105SL, 205, 205-Exclusive, Agile, Cadetta, Century, Century-Restyling, DeCurtis-CAMME, DeCurtis-DIG, DeCurtis-LEVA, Excelsior-OR, Excelsior-Standard, Executive, Firenze, Firenze-SL, Firenze-SL-Raised, Gradisca, Gradisca-Restyling, Gradisca-Take-Away, Maior, Maior-OR, Maior-Plus, MC, Opus, Opus-B03-OR, Opus-OR, Opus-Sublima, Portofino-Restyling, Roma, Roma-OR, Roma-OR-170, RR55-On-Demand		

electronic magnets



1

GEV No.	370170	Ref. No.	11065.2.00.08
description	electronic magnet 24V voltage AC 50Hz		
For models:	CP1, CP2, OFFICE RB2, RB1, RB2		

ignition parts

ignition switches



1

GEV No.	301076	Ref. No.	07545
description	momentary rocker switch mounting measurements 30x22mm red 2NO 250V 16A illuminated START connection male faston 6.3mm ambient temperature max. 125/55°C protection IP40 mounting ømm male faston 6.3mm		

equipment-specific units

for espresso machines

filter holders

filter holders standard

filter holder without spout



1

GEV No.	525984	Ref. No.	N/A
description	filter holder suitable for AURORA/BRASILIA/FAEMA without outlet mounting ø 82.5mm outlet 3/8" ID ø 62mm wedge height 10.5mm wedge position horizontal number of wedges 2 lever straight		



1

GEV No.	525985	Ref. No.	N/A
description	filter holder suitable for BRASILIA without outlet mounting ø 80mm outlet 3/8" ID ø 62mm wedge height 8.8mm wedge position diagonal number of wedges 2 lever straight		



filter holders short

 <p>1</p>			
GEV No.	529935	Ref. No.	N/A
description	filter holder mounting ø 80mm outlet 3/8" ID ø 62mm handle M12x1.75 wedge height 8.8mm wedge position diagonal number of wedges 2 lever straight chrome-plated brass		

 <p>1</p>			
GEV No.	529041	Ref. No.	02151.0.00.04 04106.0.00.04
description	filter holder mounting ø 82.5mm outlet 3/8" ID ø 62mm handle M12x1.75 wedge height 10.5mm wedge position horizontal number of wedges 2 lever straight chrome-plated brass		
For models:	100, 105, 105SL, 205, Cadetta, Century-Restyling, DeCurtis-CAMME, DeCurtis-DIG, DeCurtis-LEVA, Excelsior-OR, Excelsior-Standard, Firenze, Gradisca, Gradisca-Restyling, Gradisca-Take-Away, MILLENNIO, Portofino-Restyling		

handles

with external thread

 <p>1</p>			
GEV No.	529044	Ref. No.	06355.0.00.02
description	handle ø 35mm thread M12x1.75 thread L 15mm L 120mm black		
For models:	105, 105SL, Century-Restyling, Firenze		
accessories for	529044		
	GEV No.	531161	Ref. No.
			—
	 <p>end cap ø 24.6mm mounting ø 22.1mm H 14mm chrome-plated</p>		

end caps

 <p>1</p>			
GEV No.	112022	Ref. No.	06364.0.00.02
description	end cap		
For models:	105, 105SL, 205, Agile, Firenze, Firenze-SL, Firenze-SL-Raised, Gradisca-Restyling, Roma, Roma-Cappuccino, Roma-OR, Roma-OR-170		

screws

 <p>1</p>			
GEV No.	112021	Ref. No.	02680.0.00.03
description	cylinder head bolt thread M8 L 45mm thread L 30mm WS 6 zinc-coated steel Qty 1 pcs DIN 912/ISO 4762		
For models:	205-Exclusive, Agile, Cadetta, DeCurtis-CAMME, DeCurtis-DIG, DeCurtis-LEVA, Gradisca, Gradisca-Restyling, Opus, Opus-B03-OR, Opus-OR, Opus-Sublima, Portofino-Restyling, Roma, Roma-Cappuccino, Roma-OR, Roma-OR-170		

spouts

with thread 3/8"

 <p>1</p>			
GEV No.	529003	Ref. No.	00056.0.10.04
description	filter holder spout thread 3/8" 1-way curved/long outlet distance mm thread L 5mm		
For models:	205-Exclusive, CLUB, Gradisca-Restyling, Gradisca-Take-Away, LADY		

 <p>1</p>			
GEV No.	529005	Ref. No.	08275.0.00.04
description	filter holder spout thread 3/8" 1-way curved/short outlet distance mm		

 <p>1</p>			
GEV No.	529002	Ref. No.	00032.0.10.04
description	filter holder spout thread 3/8" 1-way straight/short outlet distance mm		
For models:	100, 105, 105SL, 205, Belle-Epoque, Century, Century-Restyling, Firenze, Gradisca, MILLENNIO, PORTOFINO, PORTOFINO AM. SUPER, PORTOFINO AMERICA		

 <p>1</p>			
GEV No.	529008	Ref. No.	00036.4.00.04
description	filter holder spout thread 3/8" 2-way curved outlet distance 33mm		
For models:	105, 105SL, Agile, BELLE EPOQUE JUNIOR, CAPPUCCINO, CLUB, Firenze-SL, Firenze-SL-Raised, LADY, MBM GOLF, Roma, Roma-OR, Roma-OR-170		

 <p>1</p>			
GEV No.	529007	Ref. No.	00031.4.00.04
description	filter holder spout thread 3/8" 2-way curved/short outlet distance 45mm		
For models:	100, 105, 105SL, 205, 205-Exclusive, Belle-Epoque, Century, Century-Restyling, Firenze, Gradisca, Gradisca-Restyling, Gradisca-Take-Away, MILLENNIO, PORTOFINO, PORTOFINO AM. SUPER, PORTOFINO AMERICA		

filters

for 1 cup



1

GEV No.	527631	Ref. No.	N/A
description	coffee filter ø 70mm mounting ø 60.7mm H 17mm cups 1 amount of coffee 8g		



1

GEV No.	529012	Ref. No.	01702.0.40.01
description	coffee filter ø 70mm mounting ø 60.8mm H 19.5mm cups 1 amount of coffee 6g		
For models:	100, 105, 105SL, 205, 205-Exclusive, Agile, Belle-Epoque, Cadetta, CAPPUCCINO, Century, Century-Restyling, Excelsior-OR, Excelsior-Standard, Executive, Firenze, Firenze-SL, Firenze-SL-Raised, Gradisca, Gradisca-Restyling, Gradisca-Take-Away, Maior, Maior-OR, Maior-Plus, MILLENNIO, Opus, Opus-B03-OR, Opus-OR, PORTOFINO, PORTOFINO AM. SUPER, PORTOFINO AMERICA, Portofino-Restyling, Roma, Roma-Cappuccino, Roma-OR, Roma-OR-170		



1

GEV No.	529011	Ref. No.	00560.0.40.01
description	coffee filter ø 70mm mounting ø 60mm H 24.5mm cups 1 amount of coffee 7g perforation ø 0.4mm		
For models:	105, 105SL, 205-Exclusive, Agile, Belle-Epoque, Cadetta, Century, Excelsior-OR, Excelsior-Standard, Gradisca, Gradisca-Restyling, Maior, Maior-OR, Maior-Plus, Opus, Opus-B03-OR, Opus-OR, PORTOFINO, PORTOFINO AM. SUPER, PORTOFINO AMERICA, Portofino-Restyling, Roma, Roma-Cappuccino, Roma-OR, Roma-OR-170		

for 2 cups



1

GEV No.	529013	Ref. No.	00561.0.40.01
description	coffee filter ø 70mm mounting ø 60.5mm H 25.5mm cups 2 amount of coffee 14g perforation ø 0.3x0.3mm square		
For models:	105, 105SL, 205-Exclusive, Agile, BELLE EPOQUE JUNIOR, Belle-Epoque, Cadetta, Century, CLUB, Excelsior-OR, Excelsior-Standard, Gradisca, Gradisca-Restyling, LADY, Maior, Maior-OR, Maior-Plus, MBM GOLF, Opus, Opus-B03-OR, Opus-OR, Opus-Sublima, PORTOFINO, PORTOFINO AM. SUPER, PORTOFINO AMERICA, Roma, Roma-Cappuccino, Roma-OR, Roma-OR-170		



1

GEV No.	529014	Ref. No.	01703.0.40.01
description	coffee filter ø 70mm mounting ø 60mm H 21mm cups 2 amount of coffee 12g perforation ø 0.3mm round		
For models:	100, 105, 105SL, 205, 205-Exclusive, Agile, Belle-Epoque, Cadetta, CAPPUCCINO, Century, Century-Restyling, Excelsior-OR, Excelsior-Standard, Executive, Firenze, Firenze-SL, Firenze-SL-Raised, Gradisca, Gradisca-Restyling, Gradisca-Take-Away, Maior, Maior-OR, Maior-Plus, MILLENNIO, Opus, Opus-B03-OR, Opus-OR, Opus-Sublima, PORTOFINO, PORTOFINO AM. SUPER, PORTOFINO AMERICA, Portofino-Restyling, Roma, Roma-Cappuccino, Roma-OR, Roma-OR-170		

blind filters



1

GEV No.	529023	Ref. No.	00564.0.40.01
description	blind filter ø 70mm mounting ø 60mm H 18mm		
For models:	105, 105SL, 205, 205-Exclusive, Agile, Belle-Epoque, Cadetta, Century, Century-Restyling, Excelsior-OR, Excelsior-Standard, Executive, Firenze, Firenze-SL, Firenze-SL-Raised, Gradisca, Gradisca-Restyling, Gradisca-Take-Away, Maior, Maior-OR, Maior-Plus, MILLENNIO, Opus, Opus-B03-OR, Opus-OR, Opus-Sublima, PORTOFINO, PORTOFINO AM. SUPER, PORTOFINO AMERICA, Portofino-Restyling, Roma, Roma-Cappuccino, Roma-OR, Roma-OR-170		

filter holder springs



1

GEV No.	531240	Ref. No.	0086200003 0223300003
description	filter holder spring L 62mm W 56.5mm wire gauge ø 1mm for espresso filter holder Qty 20 pcs		



1

GEV No.	531243	Ref. No.	N/A
description	filter holder spring L 70mm W 60mm wire gauge ø 1.3mm for espresso filter holder Qty 20 pcs		

brewing units

shower screens

with upstand



1

GEV No.	528417	Ref. No.	04214.0.40.01
description	shower screen ø 58mm H 19mm		
For models:	100, 105, 105SL, 205, 205-Exclusive, Cadetta, Century-Restyling, DeCurtis-CAMME, DeCurtis-DIG, DeCurtis-LEVA, Excelsior-OR, Excelsior-Standard, Executive, Firenze, Gradisca, Gradisca-Restyling, Gradisca-Take-Away, Maior, Maior-OR, Maior-Plus, MILLENNIO, Opus, Opus-B03-OR, Opus-OR, Opus-Sublima, Portofino-Restyling		

filter holder gaskets

flat

with external notch



1

GEV No.	528040	Ref. No.	01393.0.00.02 04408.0.00.02
description	filter holder gasket D1 ø 71mm D2 ø 56.5mm H 8mm with outside notch Qty 1 pcs		
For models:	105, 105SL, Agile, Belle-Epoque, CAPPUCCINO, Century, Firenze-SL, Firenze-SL-Raised, PORTOFINO, PORTOFINO AM. SUPER, PORTOFINO AMERICA, Roma, Roma-Cappuccino, Roma-OR, Roma-OR-170		

standard



1

GEV No.	526551	Ref. No.	04367.0.00.02
description	filter holder gasket D1 ø 72.5mm D2 ø 57mm H 8mm Qty 1 pcs		
For models:	105, 105SL, 205, 205-Exclusive, Cadetta, Century-Restyling, DeCurtis-CAMME, DeCurtis-DIG, DeCurtis-LEVA, Excelsior-OR, Excelsior-Standard, Executive, Firenze, Gradisca, Gradisca-Restyling, Gradisca-Take-Away, Maior, Maior-OR, Maior-Plus, Opus, Opus-B03-OR, Opus-OR, Opus-Sublima, Portofino-Restyling		



1

GEV No.	526255	Ref. No.	05820.0.00.02
description	filter holder gasket D1 ø 73.6mm D2 ø 58mm H 8.5mm Qty 1 pcs		
For models:	Belle-Epoque, Century, Firenze-SL, Firenze-SL-Raised		

with cone



1

GEV No.	528067	Ref. No.	N/A
description	filter holder gasket with cone D1 ø 67mm D2 ø 56.5mm H1 6.4mm H2 4mm Qty 1 pcs		

shim gaskets



1

GEV No.	531251	Ref. No.	—
description	shim gasket D1 ø 66mm D2 ø 58mm thickness 0.8mm paper Qty 20 pcs		



1

GEV No.	528033	Ref. No.	04371.0.00.02
description	shim gasket D1 ø 71mm D2 ø 58mm thickness 0.8mm paper Qty 1 pcs		
For models:	Belle-Epoque, Century, Firenze-SL, Firenze-SL-Raised, PORTOFINO, PORTOFINO AM. SUPER, PORTOFINO AMERICA		



1

GEV No.	528050	Ref. No.	04368.0.00.02
description	shim gasket D1 ø 73mm D2 ø 59mm thickness 0.5mm paper Qty 1 pcs		
For models:	Belle-Epoque, Century, Firenze-SL, Firenze-SL-Raised, PORTOFINO, PORTOFINO AM. SUPER, PORTOFINO AMERICA		

			
1			
GEV No.	531250	Ref. No.	—
description	shim gasket D1 ø 73mm D2 ø 59mm thickness 0.5mm paper Qty 20 pcs		

brewing units with solenoid valve

nozzles

			
1			
GEV No.	528410	Ref. No.	00046.0.00.04
description	nozzle hole ø 0.7mm L 8.5mm thread M5x0.75 thread L 4.5mm head thickness 4mm brass		
For models:	100, 105, 105SL, 205, Belle-Epoque, Cadetta, CAPPUCINO, Century, Firenze, Firenze-SL, Firenze-SL-Raised, Gradisca, Gradisca-Restyling, Gradisca-Take-Away, Maior, Maior-OR, Maior-Plus, MILLENNIO, PORTOFINO, PORTOFINO AM. SUPER, PORTOFINO AMERICA, Roma, Roma-Cappuccino, Roma-OR, Roma-OR-170		

			
1			
GEV No.	526595	Ref. No.	19702.0.00.04
description	nozzle hole ø 1mm L 8.5mm thread M5x0.8 thread L 4.5mm head thickness 4mm brass		
For models:	Agile		

components

			
1			
GEV No.	526566	Ref. No.	12860.4.10.09
description	drain pipe 1/8" L 35mm WS 22		
For models:	Excelsior-OR, Excelsior-Standard, Portofino-Restyling		

pipes

			
1			
GEV No.	526569	Ref. No.	09562.2.10.04
description	drain pipe ø 6mm ID ø 4mm T1: 1/8" chrome-plated		
For models:	DeCurtis-CAMME, DeCurtis-DIG, DeCurtis-LEVA, Gradisca, Gradisca-Restyling, Gradisca-Take-Away		

screw connections

			
1			
GEV No.	526708	Ref. No.	03460.0.10.04
description	plug thread 1/8" L 8.5mm chrome-plated brass		
For models:	105, 105SL, Agile, Cadetta, Century, Firenze-SL, Firenze-SL-Raised, Maior, Maior-OR, Maior-Plus, Roma, Roma-OR, Roma-OR-170		

brewing units manual

components

drain units

drain valves

			
1			
GEV No.	526002	Ref. No.	09451.4.00.09
description	valve support ø 16mm L 27mm brass shaft triangular D1 ø 10mm D2 ø 7mm		
For models:	DeCurtis-CAMME, DeCurtis-DIG, DeCurtis-LEVA, Gradisca		



nozzle holders

			
1			
GEV No.	526783	Ref. No.	12790.0.10.04
description	nozzle holder thread M30x1.5 IT M16x1.5 IT 1 M8 ø 26mm int. ø 1 15mm int. ø 2 17.5mm L 66.5mm total length 82mm WS 36 chrome-plated brass		
For models:	205-Exclusive, Century-Restyling, DeCurtis-CAMME, DeCurtis-DIG, DeCurtis-LEVA, Excelsior-OR, Excelsior-Standard, Executive, Gradisca, Maior, Maior-OR, Maior-Plus, Opus, Opus-B03-OR, Opus-OR, Portofino-Restyling		

camshafts

			
1			
GEV No.	527940	Ref. No.	09320.0.00.04
description	camshaft shaft ø 8mm shaft intake ø 6.2mm L 86.5mm W 20mm H 17mm thread M6 brass		
For models:	DeCurtis-CAMME, DeCurtis-DIG, DeCurtis-LEVA, Gradisca		





valves			
			
1			
GEV No.	526008	Ref. No.	09453.4.00.09
description	valve group outflow L 54.3mm ED ø 16mm shaft ø 4.5mm brass		
For models:	DeCurtis-CAMME, DeCurtis-DIG, DeCurtis-LEVA, Gradisca		
accessories for	526008		
	GEV No.	526003	Ref. No. —
	 compression spring ø 13.8mm L 54.5mm wire gauge ø 1.5mm windings 10 drain valve		
	GEV No.	532550	Ref. No. —
	 O-ring NBR 787/70 thickness 2.62mm ID ø 9.13mm Qty 10 pcs		

			
1			
GEV No.	526007	Ref. No.	09452.4.00.09
description	valve group supply L 52.8mm ED ø 16mm shaft triangular		
For models:	DeCurtis-CAMME, DeCurtis-DIG, DeCurtis-LEVA, Gradisca		

components			
nozzles			
with thread			
			
1			
GEV No.	528486	Ref. No.	12792.0.00.04
description	nozzle bore ø 0.7mm thread M6x0.75 L 9mm WS 7		
For models:	205-Exclusive, Century-Restyling, DeCurtis-CAMME, DeCurtis-DIG, DeCurtis-LEVA, Excelsior-OR, Excelsior-Standard, Executive, Gradisca, Maior, Maior-OR, Maior-Plus, Opus, Opus-B03-OR, Opus-OR, Portofino-Restyling		

springs			
			
1			
GEV No.	526561	Ref. No.	12941.0.00.03
description	compression spring ø 14.3mm L 21mm wire gauge ø 1.8mm		
For models:	DeCurtis-CAMME, DeCurtis-DIG, DeCurtis-LEVA, Gradisca		

screw connections			
			
1			
GEV No.	528407	Ref. No.	02106.0.00.04 02106.0.11.04
description	screw cap		
For models:	100, 105, 105SL, 205, 205-Exclusive, Agile, Cadetta, CAPPUCCINO, Century, Excelsior-OR, Excelsior-Standard, Firenze, Firenze-SL, Firenze-SL-Raised, Gradisca, Gradisca-Restyling, Gradisca-Take-Away, Maior, Maior-OR, Maior-Plus, MILLENNIO, Opus, Opus-B03-OR, Opus-OR, Opus-Sublima, PORTOFINO, PORTOFINO AM. SUPER, PORTOFINO AMERICA, Roma, Roma-Cappuccino, Roma-OR, Roma-OR-170		

water dispersions			
water dispersions			
group 2			
			
1			
GEV No.	529081	Ref. No.	04089.0.00.04
description	water distributor ø 30mm hole ø 1.5mm H 15mm ET M10x1 grooves 6 2.5mm brass		
For models:	100, 105, 105SL, 205, 205-Exclusive, Cadetta, Century-Restyling, DeCurtis-CAMME, DeCurtis-DIG, DeCurtis-LEVA, Excelsior-OR, Excelsior-Standard, Executive, Firenze, Gradisca, Gradisca-Restyling, Gradisca-Take-Away, Maior, Maior-OR, Maior-Plus, MILLENNIO, Opus, Opus-B03-OR, Opus-OR, Opus-Sublima, Portofino-Restyling		

group 3			
			
1			
GEV No.	528411	Ref. No.	04087.0.00.04
description	water distributor ø 55mm H 7mm 6 holes hole ø 1.2mm mounting ø 5.1mm brass		
For models:	105, 105SL, Belle-Epoque, CAPPUCCINO, Century, Firenze-SL, Firenze-SL-Raised, PORTOFINO, PORTOFINO AM. SUPER, PORTOFINO AMERICA, Roma, Roma-Cappuccino, Roma-OR, Roma-OR-170		

			
1			
GEV No.	528414	Ref. No.	00021.0.00.04
description	water distributor ø 58mm H 7mm 6 holes hole ø 1.15mm mounting ø 5mm brass		
For models:	BELLE EPOQUE JUNIOR, CLUB, LADY, MBM GOLF		

safety valves			
safety valves			
3/8"			
			
1			
GEV No.	529879	Ref. No.	12611.4.00.09
description	safety valve connection 3/8" triggering pressure 1.6bar approval CE 0036 sealed		
For models:	105, 105SL, 205, 205-Exclusive, Agile, Belle-Epoque, Cadetta, Century, Century-Restyling, DeCurtis-CAMME, DeCurtis-DIG, DeCurtis-LEVA, Excelsior-OR, Excelsior-Standard, Executive, Firenze, Firenze-SL, Firenze-SL-Raised, Gradisca, Gradisca-Restyling, Gradisca-Take-Away, Maior, Maior-OR, Maior-Plus, Opus, Opus-B03-OR, Opus-OR, Portofino-Restyling, Roma, Roma-Cappuccino, Roma-OR, Roma-OR-170		

			
1			
GEV No.	529312	Ref. No.	01120.4.00.09
description	safety valve connection 3/8" triggering pressure 1.8bar		
For models:	100, 105, 105SL, 205, Belle-Epoque, CAPPUCCINO, Century, Firenze, Gradisca, Gradisca-Take-Away, PORTOFINO, PORTOFINO AM. SUPER, PORTOFINO AMERICA, SECS		

			
1			
GEV No.	529338	Ref. No.	01181.4.00.09
description	safety valve connection 3/8" triggering pressure 1.8bar approval TÜV suitable for BRASILIA		
For models:	MILLENNIO, PORTOFINO, PORTOFINO AM. SUPER, PORTOFINO AMERICA, TOP CLASS		

expansion valves

			
1			
GEV No.	529337	Ref. No.	12845.4.00.09
description	expansion valve T1: 3/8" ET T2: 1/4" ET L 48mm		
For models:	DeCurtis-CAMME, DeCurtis-DIG, DeCurtis-LEVA, Firenze-SL, Firenze-SL-Raised, Opus-B03-OR, Opus-Sublima, Roma, Roma-OR, Roma-OR-170		

with hose connection

			
1			
GEV No.	529593	Ref. No.	01182.4.00.09
description	expansion valve T1: 1/4" ET hose ø 8mm L 51mm		
For models:	Belle-Epoque, SECS, TOP CLASS		

			
1			
GEV No.	526587	Ref. No.	13533.4.00.09
description	expansion valve T1: 1/4" ET hose ø 9.5mm L 42mm		
For models:	Agile, Firenze-SL, Firenze-SL-Raised, Roma, Roma-OR, Roma-OR-170		

gasket supports

			
1			
GEV No.	528245	Ref. No.	00153.0.00.04 18406.0.00.04
description	gasket support D1 ø 7.5mm ID ø 10.5mm L 14mm brass		
For models:	100, 105, 105SL, 205, 205-Exclusive, Agile, Belle-Epoque, Cadetta, CAPPUCCINO, Century, Century-Restyling, DeCurtis-CAMME, DeCurtis-DIG, DeCurtis-LEVA, Excelsior-OR, Excelsior-Standard, Executive, Firenze, Firenze-SL, Firenze-SL-Raised, Gradisca, Gradisca-Restyling, Gradisca-Take-Away, Maior, Maior-OR, Maior-Plus, MILLENNIO, Opus, Opus-B03-OR, Opus-OR, Opus-Sublima, PORTOFINO, PORTOFINO AMERICA, Portofino-Restyling		



drain pans

drain pans

			
1			
GEV No.	526563	Ref. No.	05933.2.06.01
description	drain pan ø 60mm H 30mm hose ø 10mm		
For models:	Roma-Cappuccino		

			
1			
GEV No.	526564	Ref. No.	08229.0.00.02
description	drain pan ø 60mm H 46mm hole ø 20mm hose ø 10mm		
For models:	105, 105SL, 205, 205-Exclusive, Agile, Belle-Epoque, Cadetta, Century, Century-Restyling, DeCurtis-CAMME, DeCurtis-DIG, DeCurtis-LEVA, Excelsior-OR, Excelsior-Standard, Firenze, Firenze-SL, Firenze-SL-Raised, Gradisca, Gradisca-Restyling, Gradisca-Take-Away, Opus, Opus-B03-OR, Opus-OR, Opus-Sublima, Portofino-Restyling, Roma, Roma-OR, Roma-OR-170		

aerators and air bleeders

			
1			
GEV No.	529303	Ref. No.	05062.4.00.09
description	aerator and air bleeder connection 1/4" only steam		
For models:	100		
spare parts for	529303		
	GEV No.	528687	Ref. No. —
O-ring Viton thickness 1.78mm ID ø 3.69mm Qty 1 pcs			

			
1			
GEV No.	529304	Ref. No.	01571.2.00.04
description	aerator and air bleeder screw connection 1/4"		
For models:	PORTOFINO AM. SUPER		

boilers			
gaskets			
unperforated			
			
1			
GEV No.	528139	Ref. No.	00821.0.00.02
description	boiler gasket D1 ø 143mm D2 ø 128mm thickness 3mm graphite suitable for BRASILIA equiv. no. 00821		
For models:	Century		

accessories			
			
1			
GEV No.	526707	Ref. No.	01246.0.00.03
description	thread bolt for heating element thread M8 L 31mm		
For models:	105, 105SL, 205, 205-Exclusive, Cadetta, Century, Century-Restyling, DeCurtis-CAMME, DeCurtis-DIG, DeCurtis-LEVA, Excelsior-OR, Excelsior-Standard, Executive, Firenze, Firenze-SL, Firenze-SL-Raised, Gradisca, Gradisca-Restyling, Gradisca-Take-Away, Maior, Maior-OR, Maior-Plus, Opus, Opus-B03-OR, Opus-OR, Portofino-Restyling		

steam/water taps			
steam/water taps			
steam/water taps			
			
1			
GEV No.	529594	Ref. No.	01169.4.00.09
description	steam/water tap		
For models:	PORTOFINO		

			
1			
GEV No.	529595	Ref. No.	01153.4.00.09
description	steam/water tap inlet 1/4" outlet 1/8" suitable for AMERICA series		
For models:	105, 105SL, CAPPUCINO, Firenze-SL, Firenze-SL-Raised		

			
1			
GEV No.	529616	Ref. No.	11927.4.00.09
description	steam/water tap rubber inlet 1/4" outlet 1/8"		
For models:	105, 105SL, 205, 205-Exclusive, Century, Century-Restyling, Executive, Firenze, Gradisca, Gradisca-Restyling, Gradisca-Take-Away, PORTOFINO, PORTOFINO AM. SUPER, PORTOFINO AMERICA, Portofino-Restyling		

components			
shafts			
			
1			
GEV No.	526568	Ref. No.	05384.0.00.04
description	shaft for ceramic washer ø 9mm D2 ø 16mm L 91mm brass		
For models:	105, 105SL, 205, Century, Firenze, Gradisca, Gradisca-Take-Away		

			
1			
GEV No.	526570	Ref. No.	12046.4.00.09
description	shaft ø 7.8mm D2 ø 17.5mm L 98mm		
For models:	105, 105SL, 205, 205-Exclusive, Century, Century-Restyling, Executive, Firenze, Firenze-SL, Firenze-SL-Raised, Gradisca, Gradisca-Restyling, Gradisca-Take-Away, Portofino-Restyling		

bushes			
			
1			
GEV No.	529804	Ref. No.	06508.0.00.04
description	bush		
For models:	205, 205-Exclusive, Agile, Bolero, Cadetta, Excelsior-OR, Excelsior-Standard, Executive, Firenze-SL, Firenze-SL-Raised, Maior, Maior-OR, Maior-Plus, MILLENNIO, OFFICE RB2, Opus, Opus-B03-OR, Opus-OR, Opus-Sublima, PORTOFINO AMERICA, Portofino-Restyling, Roma, Roma-Cappuccino, Roma-OR, Roma-OR-170		

gaskets			
			
1			
GEV No.	528244	Ref. No.	00818.0.00.02 18513.0.00.02
description	gasket D1 ø 11mm ID ø 4mm thickness 4mm		
For models:	100, 105, 105SL, 205, 205-Exclusive, Agile, Belle-Epoque, Cadetta, CAPPUCINO, Century, Century-Restyling, DeCurtis-CAMME, DeCurtis-DIG, DeCurtis-LEVA, Excelsior-OR, Excelsior-Standard, Executive, Firenze, Firenze-SL, Firenze-SL-Raised, Gradisca, Gradisca-Restyling, Gradisca-Take-Away, Maior, Maior-OR, Maior-Plus, MILLENNIO, Opus, Opus-B03-OR, Opus-OR, Opus-Sublima, PORTOFINO, PORTOFINO AMERICA, Portofino-Restyling		

			
1			
GEV No.	528280	Ref. No.	01365.0.00.02 16886.0.00.02
description	gasket D1 ø 11mm thickness 4mm Viton		
For models:	100, 105, 105SL, 205, Belle-Epoque, CAPPUCINO, Century, Century-Restyling, DeCurtis-CAMME, DeCurtis-DIG, DeCurtis-LEVA, Firenze, Firenze-SL, Firenze-SL-Raised, Gradisca, Gradisca-Take-Away, MILLENNIO, PORTOFINO, PORTOFINO AM. SUPER, PORTOFINO AMERICA, Portofino-Restyling, Roma-Cappuccino		



1

GEV No.	528283	Ref. No.	12005.0.00.02
description	gasket D1 ø 13mm ID ø 4mm thickness 4mm rubber		
For models:	105, 105SL, 205, 205-Exclusive, Century, Century-Restyling, Executive, Firenze, Firenze-SL, Firenze-SL-Raised, Gradisca, Gradisca-Restyling, Gradisca-Take-Away, PORTOFINO, PORTOFINO AM. SUPER, PORTOFINO AMERICA, Portofino-Restyling		



1

GEV No.	526555	Ref. No.	08570.0.00.02
description	gasket D1 ø 16mm ID ø 8mm thickness 4mm		
For models:	DeCurtis-CAMME, DeCurtis-DIG, DeCurtis-LEVA, Gradisca		



1

GEV No.	528281	Ref. No.	00825.0.00.02
description	gasket D1 ø 6mm thickness 3mm PTFE		
For models:	BELLE EPOQUE JUNIOR, CLUB, LADY, MBM GOLF		

springs



1

GEV No.	529946	Ref. No.	08953.0.00.03
description	compression spring ø 14.7mm L 34mm wire gauge ø 2mm		
For models:	DeCurtis-CAMME, DeCurtis-DIG, DeCurtis-LEVA, Gradisca		

tap bodies



1

GEV No.	526585	Ref. No.	12010.0.00.04
description	tap body T1: 1/8" T2: 1/4" T3: M20x1.5 L 72mm		
For models:	105, 105SL, 205, 205-Exclusive, Century, Century-Restyling, Executive, Firenze, Firenze-SL, Firenze-SL-Raised, Gradisca, Gradisca-Restyling, Gradisca-Take-Away, Portofino-Restyling		

ceramic washers



1

GEV No.	528274	Ref. No.	05810.0.00.02
description	ceramic washer		
For models:	100, 105, 105SL, 205, Century, Firenze, Gradisca, Gradisca-Take-Away, MILLENNIO, PORTOFINO, PORTOFINO AM. SUPER, PORTOFINO AMERICA		

union nuts



1

GEV No.	528279	Ref. No.	00131.0.12.04
description	union nut		
For models:	100, 105, 105SL, 205, 205-Exclusive, Century, Century-Restyling, Excelsior-OR, Excelsior-Standard, Executive, Firenze, Firenze-SL, Firenze-SL-Raised, Gradisca, Gradisca-Restyling, Gradisca-Take-Away, MILLENNIO, Opus, Opus-B03-OR, Opus-OR, PORTOFINO, PORTOFINO AM. SUPER, PORTOFINO AMERICA, Portofino-Restyling		



1

GEV No.	528263	Ref. No.	00145.0.00.04 00145.0.14.04
description	union nut thread 3/8" ID ø 12.5mm L 21mm WS 22 anthracite		
For models:	105, 105SL, Belle-Epoque, CAPPUCINO		

1

GEV No.	528264	Ref. No.	05363.0.14.04
description	union nut thread 3/8" L 22.5mm WS 29 anthracite		
For models:	Firenze-SL, Firenze-SL-Raised		



1

GEV No.	526584	Ref. No.	05383.0.00.04
description	screw connection T1: 1/2" T2: M25 L 65mm		
For models:	105, 105SL, 205, Century, Firenze, Gradisca, Gradisca-Take-Away		

washers



1

GEV No.	528185	Ref. No.	12153.0.00.03
description	disc D1 ø 12mm D2 ø 8.2mm thickness 2mm brass		
For models:	105, 105SL, 205, 205-Exclusive, Century, Executive, Firenze, Firenze-SL, Firenze-SL-Raised, Gradisca, Gradisca-Restyling, Gradisca-Take-Away, PORTOFINO, PORTOFINO AM. SUPER, PORTOFINO AMERICA, Portofino-Restyling		

miscellaneous



1

GEV No.	528271	Ref. No.	05808.0.00.02
description	bush		
For models:	100, 105, 105SL, 205, Century, Firenze, Gradisca, Gradisca-Take-Away, MILLENNIO, PORTOFINO, PORTOFINO AM. SUPER, PORTOFINO AMERICA		

screw connections



1

GEV No.	528295	Ref. No.	07202.0.00.04
description	screw connection		
For models:	205, 205-Exclusive, Agile, Bolero, Executive, Firenze-SL, Firenze-SL-Raised, MILLENNIO, OFFICE RB2, Opus-Sublima, PORTOFINO AMERICA, Portofino-Restyling, SECS, TOP CLASS		



1

GEV No.	528275	Ref. No.	05807.0.00.02
description	bush		
For models:	100, 105, 105SL, 205, Century, Firenze, Gradisca, Gradisca-Take-Away, MILLENNIO, PORTOFINO, PORTOFINO AM. SUPER, PORTOFINO AMERICA		



1

GEV No.	526572	Ref. No.	12013.0.00.04
description	screw connection for steam-/water-tap L 46mm ø 18mm ID ø 8.5mm WS 24 thread 1/2"		
For models:	105, 105SL, 205, 205-Exclusive, Century, Century-Restyling, Executive, Firenze, Firenze-SL, Firenze-SL-Raised, Gradisca, Gradisca-Restyling, Gradisca-Take-Away, Portofino-Restyling		



1

GEV No.	528272	Ref. No.	05811.0.00.02
description	disc		
For models:	100, 105, 105SL, 205, Century, Firenze, Gradisca, Gradisca-Take-Away, MILLENNIO, PORTOFINO, PORTOFINO AM. SUPER, PORTOFINO AMERICA		

steam/water pipes

steam pipes



1

GEV No.	529754	Ref. No.	01599.2.10.04
description	steam pipe		
For models:	Belle-Epoque		



1

GEV No.	529873	Ref. No.	06512.2.10.04
description	steam pipe		
For models:	PORTOFINO AMERICA		

			
1			
GEV No.	529888	Ref. No.	04676.2.10.04
description	steam pipe H 170mm tube ø 10mm chrome-plated brass AMERICA		
For models:	105, 105SL		

			
1			
GEV No.	529740	Ref. No.	04676
description	steam pipe H 180mm tube ø 10mm chrome-plated brass		

			
1			
GEV No.	529752	Ref. No.	12062.4.00.09
description	steam pipe H 200mm		
For models:	105, 105SL, Century-Restyling		

			
1			
GEV No.	529741	Ref. No.	12058.4.00.09
description	steam pipe H 23.5mm tube ø 10mm chrome-plated brass CENTURY		
For models:	Century		

			
1			
GEV No.	529749	Ref. No.	12060.4.00.09
description	steam pipe thread 3/8" L 220mm tube ø 10mm GRADISCA		
For models:	Gradisca, Gradisca-Restyling, Gradisca-Take-Away		

			
1			
GEV No.	529758	Ref. No.	11767.2.10.04
description	steam pipe with ball joint/ without nozzle		
For models:	205, Firenze-SL, Firenze-SL-Raised, MILLENNIO		

			
1			
GEV No.	529867	Ref. No.	10767.2.10.04
description	steam pipe without nozzle		
For models:	Gradisca, Gradisca-Take-Away		

			
1			
GEV No.	529881	Ref. No.	04657.2.10.04
description	steam pipe without nozzle		
For models:	Century		

nozzles for water pipes

nozzles for water pipes

			
1			
GEV No.	525095	Ref. No.	04661.0.10.04
description	nozzle D1 ø 24mm H 30mm thread M10x1 int. ø 1 9mm		
For models:	100, 105, 105SL, 205, Cadetta, CAPPUCCINO, Century, Century-Restyling, Firenze, Firenze-SL, Firenze-SL-Raised, Gradisca, Gradisca-Restyling, Gradisca-Take-Away, Maior, Maior-OR, Maior-Plus, MILLENNIO, OFFICE RB2, Opus, Opus-B03-OR, Opus-OR, Opus-Sublima, PORTOFINO, PORTOFINO AM. SUPER, PORTOFINO AMERICA, SECS, TOP CLASS		

components

			
1			
GEV No.	529604	Ref. No.	00054.0.00.04
description	end piece for flow regulator		

tap aerators

			
1			
GEV No.	529608	Ref. No.	05004.4.00.09
description	tap aerator D1 ø 23mm H 15mm thread M22x1		
For models:	100, 105, 105SL, 205, Cadetta, CAPPUCCINO, Century, Century-Restyling, Firenze, Firenze-SL, Firenze-SL-Raised, Gradisca, Gradisca-Restyling, Gradisca-Take-Away, Maior, Maior-OR, Maior-Plus, MILLENNIO, OFFICE RB2, Opus, Opus-B03-OR, Opus-OR, Opus-Sublima, PORTOFINO, PORTOFINO AM. SUPER, PORTOFINO AMERICA, Roma, Roma-Cappuccino, Roma-OR, Roma-OR-170, SECS, TOP CLASS		



water pipes			
			
1			
GEV No.	529597	Ref. No.	00259.2.10.04
description	water pipe		
For models:	CAPPUCCINO, Firenze, PORTOFINO, PORTOFINO AM. SUPER		

			
1			
GEV No.	529600	Ref. No.	01630.2.10.04
description	water pipe		

			
1			
GEV No.	529755	Ref. No.	02533.2.10.04 12061.4.00.09
description	water pipe		
For models:	100, 105, 105SL, PORTOFINO		

			
1			
GEV No.	529874	Ref. No.	02509.2.10.04
description	water pipe		

			
1			
GEV No.	529599	Ref. No.	00251 02550 12055.4.00.09
description	water pipe L 120mm chrome-plated brass		
For models:	CAPPUCCINO, Century-Restyling, Firenze, PORTOFINO, PORTOFINO AM. SUPER		

			
1			
GEV No.	529757	Ref. No.	12059.4.00.09
description	water pipe ø 10mm L 185mm suitable for GRADISCA		
For models:	Gradisca, Gradisca-Restyling, Gradisca-Take-Away		

			
1			
GEV No.	529817	Ref. No.	06511.2.10.04
description	water pipe ø 10mm L 50mm		
For models:	205, Firenze-SL, Firenze-SL-Raised, MILLENNIO, PORTOFINO AMERICA		

			
1			
GEV No.	529748	Ref. No.	12057.4.00.09
description	water pipe ø 23.5mm L 135mm chrome-plated brass CENTURY		
For models:	Century		

			
1			
GEV No.	526614	Ref. No.	13519.4.00.09
description	water pipe thread 3/8" L 75mm WS 22		
For models:	205-Exclusive, Agile, Executive, Portofino-Restyling		

			
1			
GEV No.	529759	Ref. No.	06511.2.10.04
description	water pipe with ball joint		

accessories

bushes

			
1			
GEV No.	528297	Ref. No.	11029.0.00.04
description	bush		
For models:	Gradisca, Gradisca-Restyling, Gradisca-Take-Away, SECS, TOP CLASS		

gaskets



GEV No.	528259	Ref. No.	01286.0.00.03
description	flat gasket ID ø 10mm thickness 1mm		
For models:	100, 105, 105SL, 205, Agile, Belle-Epoque, CAPPUCCINO, Century, Century-Restyling, Excelsior-OR, Excelsior-Standard, Firenze, Firenze-SL, Firenze-SL-Raised, Gradisca, Gradisca-Restyling, Gradisca-Take-Away, MILLENNIO, PORTOFINO, PORTOFINO AM. SUPER, Roma, Roma-Cappuccino, Roma-OR, Roma-OR-170		



GEV No.	528258	Ref. No.	00810.0.00.02
description	gasket ID ø 10 no to be sold in Francemm thickness 1/2.4mm outer cone		
For models:	100, 105, 105SL, 205, Belle-Epoque, CAPPUCCINO, Century-Restyling, Excelsior-OR, Excelsior-Standard, Firenze, Firenze-SL, Firenze-SL-Raised, Gradisca, Gradisca-Restyling, Gradisca-Take-Away, MILLENNIO, PORTOFINO, PORTOFINO AM. SUPER, Roma-Cappuccino		



GEV No.	528231	Ref. No.	00839.0.00.02
description	O-ring Viton thickness 2.62mm ID ø 12.37mm Qty 1 pcs		
For models:	100, 105, 105SL, 205, 205-Exclusive, BELLE EPOQUE JUNIOR, CLUB, DeCurtis-CAMME, DeCurtis-DIG, DeCurtis-LEVA, Excelsior-OR, Excelsior-Standard, Gradisca, Gradisca-Restyling, Gradisca-Take-Away, LADY, MBM GOLF, MILLENNIO, Opus, Opus-B03-OR, Opus-OR, Portofino-Restyling		

springs



GEV No.	529704	Ref. No.	07060.0.00.03
description	compression spring ø 11.8mm L 16mm wire gauge ø 1.6mm steel		
For models:	205, 205-Exclusive, Agile, Bolero, Cadetta, Excelsior-OR, Excelsior-Standard, Executive, Firenze-SL, Firenze-SL-Raised, Gradisca, Gradisca-Restyling, Gradisca-Take-Away, Maior, Maior-OR, Maior-Plus, MILLENNIO, OFFICE RB2, Opus, Opus-OR, Opus-Sublima, PORTOFINO AMERICA, Portofino-Restyling, Roma, Roma-Cappuccino, Roma-OR, Roma-OR-170, SECS, TOP CLASS		

tube handles



GEV No.	529626	Ref. No.	11972.0.00.02 11972.0.00.04
description	tube handle		
For models:	205-Exclusive, Cadetta, Gradisca-Restyling, Portofino-Restyling		



GEV No.	528625	Ref. No.	15692.0.00.02
description	tube handle L 35mm rubber ID ø 8mm		
For models:	205-Exclusive, Agile, Cadetta, DeCurtis-CAMME, DeCurtis-DIG, DeCurtis-LEVA, Excelsior-OR, Excelsior-Standard, Executive, Maior, Maior-OR, Maior-Plus, Opus, Opus-B03-OR, Opus-OR, Opus-Sublima, Portofino-Restyling		

washers



GEV No.	528268	Ref. No.	00166.0.00.04
description	disc ID ø 5.4mm ED ø 10mm thickness 2mm		
For models:	100, 105, 105SL, 205, 205-Exclusive, Agile, Cadetta, CAPPUCCINO, Century, Century-Restyling, DeCurtis-CAMME, DeCurtis-DIG, DeCurtis-LEVA, Excelsior-OR, Excelsior-Standard, Executive, Firenze, Firenze-SL, Firenze-SL-Raised, Gradisca, Gradisca-Restyling, Gradisca-Take-Away, Maior, Maior-OR, Maior-Plus, MILLENNIO, Opus, Opus-B03-OR, Opus-OR, Opus-Sublima, PORTOFINO, PORTOFINO AMERICA, Portofino-Restyling		

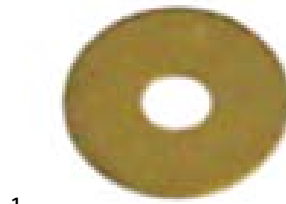

GEV No.	529603	Ref. No.	01301.0.00.03
description	plain washer ID ø 17mm ED ø 29.8mm thickness 3mm		
For models:	100, Belle-Epoque		

union nuts



GEV No.	528300	Ref. No.	06509.0.00.04
description	union nut		
For models:	205, 205-Exclusive, Agile, Bolero, Executive, Firenze-SL, Firenze-SL-Raised, Gradisca, Gradisca-Restyling, Gradisca-Take-Away, Maior, Maior-OR, Maior-Plus, MILLENNIO, OFFICE RB2, Opus-Sublima, PORTOFINO AMERICA, Portofino-Restyling		

fine filters

fine filters



1

GEV No.	528409	Ref. No.	00086.0.00.04
description	fine filter fabric pipe \varnothing 14mm H 11.5mm		
For models:	100, 105, 105SL, 205, 205-Exclusive, Agile, Belle-Epoque, Cadetta, CAPPUCCINO, Century, Excelsior-OR, Excelsior-Standard, Firenze, Firenze-SL, Firenze-SL-Raised, Gradisca, Gradisca-Restyling, Gradisca-Take-Away, Maior, Maior-OR, Maior-Plus, MILLENNIO, Opus, Opus-B03-OR, Opus-OR, Opus-Sublima, PORTOFINO, PORTOFINO AM. SUPER, PORTOFINO AMERICA, Roma, Roma-Cappuccino, Roma-OR, Roma-OR-170		



1

GEV No.	528562	Ref. No.	09756.0.00.04
description	fine filter flat \varnothing 9mm		
For models:	205-Exclusive, Cadetta, Century, Excelsior-OR, Excelsior-Standard, Executive, Gradisca-Restyling, Maior, Maior-OR, Maior-Plus, Opus, Opus-B03-OR, Opus-OR, Opus-Sublima		



1

GEV No.	529979	Ref. No.	12897.0.40.01
description	fine filter \varnothing 8.8mm H 22mm		
For models:	205-Exclusive, Century-Restyling, DeCurtis-CAMME, DeCurtis-DIG, DeCurtis-LEVA, Excelsior-OR, Excelsior-Standard, Executive, Gradisca, Maior, Maior-OR, Maior-Plus, Opus, Opus-B03-OR, Opus-OR, Portofino-Restyling		

intake valves

intake valves



1

GEV No.	529590	Ref. No.	02954.6.00.09
description	intake valve water equiv. no. 02954 with solenoid valve		
For models:	100, 105, 105SL, 205, Century, Century-Restyling, DeCurtis-CAMME, DeCurtis-DIG, DeCurtis-LEVA, Firenze, Firenze-SL, Firenze-SL-Raised, Gradisca, Gradisca-Take-Away, MILLENNIO, PORTOFINO, PORTOFINO AMERICA, Portofino-Restyling		



1

GEV No.	529615	Ref. No.	06267.6.00.09
description	intake valve water equiv. no. 06267 complete voltage AC		
For models:	105, 105SL, Belle-Epoque, CAPPUCCINO, MILLENNIO, PORTOFINO AM. SUPER, PORTOFINO AMERICA		

accessories

gaskets



1

GEV No.	527995	Ref. No.	18508.0.00.08 18508.2.00.08
description	gasket ED \varnothing 15mm seat \varnothing 6mm H 5mm overall height 10mm		

springs



1

GEV No.	526560	Ref. No.	08952.0.00.03
description	compression spring \varnothing 14.3mm L 46mm wire gauge \varnothing 1.5mm		
For models:	DeCurtis-CAMME, DeCurtis-DIG, DeCurtis-LEVA, Gradisca		

miscellaneous



1

GEV No.	528422	Ref. No.	02227.0.00.03
description	ball \varnothing 8mm SS		

valves



1

GEV No.	528247	Ref. No.	00078.0.00.04
description	valve L 16mm W 6mm H 6mm ED \varnothing 12mm brass		
For models:	100, 105, 105SL, 205, Belle-Epoque, CAPPUCCINO, Century, Century-Restyling, DeCurtis-CAMME, DeCurtis-DIG, DeCurtis-LEVA, Firenze, Firenze-SL, Firenze-SL-Raised, Gradisca, Gradisca-Take-Away, MILLENNIO, PORTOFINO, PORTOFINO AM. SUPER, PORTOFINO AMERICA, Portofino-Restyling, Roma-Cappuccino		



1

GEV No.	528252	Ref. No.	05595.0.00.04
description	valve L 20mm W 6x6mm ED \varnothing 12mm brass		
For models:	100, 105, 105SL, 205, Belle-Epoque, CAPPUCCINO, Century, Century-Restyling, DeCurtis-CAMME, DeCurtis-DIG, DeCurtis-LEVA, Firenze, Firenze-SL, Firenze-SL-Raised, Gradisca, Gradisca-Take-Away, MILLENNIO, PORTOFINO, PORTOFINO AM. SUPER, PORTOFINO AMERICA, Portofino-Restyling, Roma-Cappuccino		

level glasses

level glasses

pressure rings



GEV No.	529396	Ref. No.	00088.0.00.04
description	press ring D1 ø 11.3mm D2 ø 14.6mm thickness 3mm		
For models:	100, 105, 105SL, 205, 205-Exclusive, Agile, Belle-Epoque, Century, Century-Restyling, DeCurtis-CAMME, DeCurtis-DIG, DeCurtis-LEVA, Excelsior-OR, Excelsior-Standard, Firenze, Firenze-SL, Firenze-SL-Raised, Gradisca, Gradisca-Restyling, Gradisca-Take-Away, MILLENNIO, Opus, Opus-B03-OR, Opus-OR, PORTOFINO, PORTOFINO AM. SUPER, PORTOFINO AMERICA, Portofino-Restyling, Roma, Roma-OR, Roma-OR-170		

level glasses (complete)



GEV No.	526603	Ref. No.	21161.6.00.09 21161.8.00.09
description	water level tube with breathers H 200mm		
For models:	205, 205-Exclusive, Agile, Century, Century-Restyling, Excelsior-OR, Excelsior-Standard, Executive, Firenze, Firenze-SL, Firenze-SL-Raised, Gradisca, Gradisca-Restyling, Gradisca-Take-Away, Maior, Maior-OR, Maior-Plus, Opus, Opus-B03-OR, Opus-OR, Opus-Sublima, Portofino-Restyling, Roma, Roma-OR, Roma-OR-170		

level glass pipes



GEV No.	529398	Ref. No.	00787.0.00.02
description	water level tube ø 11mm H 135mm		
For models:	100, 105, 105SL, 205, 205-Exclusive, Agile, Belle-Epoque, Century, Century-Restyling, DeCurtis-CAMME, DeCurtis-DIG, DeCurtis-LEVA, Excelsior-OR, Excelsior-Standard, Executive, Firenze, Firenze-SL, Firenze-SL-Raised, Gradisca, Gradisca-Restyling, Gradisca-Take-Away, Maior, Maior-OR, Maior-Plus, MILLENNIO, Opus, Opus-B03-OR, Opus-OR, Opus-Sublima, PORTOFINO, PORTOFINO AM. SUPER, PORTOFINO AMERICA, Portofino-Restyling, Roma, Roma-OR, Roma-OR-170		

screw connections

double nipples



GEV No.	528294	Ref. No.	10766.0.00.04
description	double nipple T1: 1/8" T2: 3/8" int. ø 1 5mm int. ø 2 12mm L 27mm brass for steam pipe		
For models:	Gradisca, Gradisca-Take-Away		

for coffee grinders

grinding burrs

grinding burrs straight

standard



GEV No.	527213	Ref. No.	00059.3.00.04
description	grinding burrs pair turn direction left D1 ø 50mm ID ø 30mm H 8mm tooth spacing 2.5mm hole ø 4.5mm bore ø 7.5mm mounting ø 40 straight suitable for BRASILIA		
For models:	BFD		



GEV No.	526518	Ref. No.	19164.3.00.04
description	grinding burrs pair turn direction left D1 ø 63.3mm ID ø 38mm H 9mm tooth spacing 2.5mm hole ø 5mm bore ø 8.5mm mounting ø 50 suitable for BRASILIA, ROSSI teeth 12/60		
For models:	MAC64, MAC64-On-Demand, RR55-On-Demand		



GEV No.	531206	Ref. No.	N/A
description	grinding burrs pair turn direction left D1 ø 63.3mm ID ø 38mm H 9mm tooth spacing 2.5mm hole ø 5mm bore ø 8.5mm mounting ø 50 suitable for BRASILIA, ROSSI teeth 16/60		



GEV No.	527202	Ref. No.	00058.2.00.04 00058.3.00.04
description	grinding burrs pair turn direction left D1 ø 63.3mm ID ø 38mm H 9mm tooth spacing 3mm hole ø 5.5mm bore ø 8.5mm mounting ø 50 straight suitable for BRASILIA, ROSSI equiv. no. 00058/BRASILIA, 4433/ROSSI		
For models:	RR45-A, RR45-DEL, RR45-PST, RR45-S, RR45-SILENT, RR55-AE, RR65-AE, RR65-SE		



1

GEV No.	527215	Ref. No.	N/A
description	grinding burrs pair turn direction left D1 ø 83mm ID ø 45mm H 10mm tooth spacing 3.5mm hole ø 6.5mm bore ø 10.5mm mounting ø 65 straight suitable for BRASILIA, ROSSI		

grinding burrs conical



1

GEV No.	527200	Ref. No.	11779.3.00.04 11799.3.00.04 17084.3.40.04
description	grinding burrs pair turn direction right D1 ø 47mm D2 ø 31.5mm H 20mm shaft ø 10mm equiv. no. 11799		
For models:	CP1, CP2, RB1, RB2		



1

GEV No.	527237	Ref. No.	03603.3.00.04
description	grinding burrs pair turn direction right D1 ø 68mm D2 ø 49mm H 25mm shaft ø 13mm with flute suitable for ROSSI		
For models:	MC		

grinding burrs holders



1

GEV No.	527268	Ref. No.	02077.0.00.04
description	grinding burr holder type RR45, CC45 suitable for ROSSI equiv. no. 4984		
For models:	MAC64, RR45-A, RR45-DEL, RR45-On-Demand, RR45-PST, RR45-S, RR45-SILENT, RR55-AE, RR55-On-Demand, RR65-AE, RR65-SE		

screws



1

GEV No.	560365	Ref. No.	07079.0.00.03 20096.0.00.03
description	flat-headed bolt thread M4 thread L 8mm SS DIN 7985/ISO 7045 Qty 1 pcs intake Phillips head ø 8mm head thickness 3mm		
For models:	MAC64, MAC64-On-Demand, RR45-A, RR45-DEL, RR45-On-Demand, RR45-PST, RR45-S, RR45-SILENT, RR55-AE, RR55-On-Demand, RR65-AE, RR65-SE		

dosing containers

dosing container lids



1

GEV No.	527301	Ref. No.	03191.0.00.02
description	lid		
For models:	BFD		



1

GEV No.	527306	Ref. No.	01430.0.00.02
description	lid for dosing container ø 118mm		
For models:	MC, RR45-A, RR45-DEL, RR45-S, RR45-SILENT, RR55-AE, RR65-AE, RR65-SE		

adjusting screws



1

GEV No.	527551	Ref. No.	09610.0.00.02
description	adjusting screw for dosing container thread M8 L 40mm plastic		
For models:	MC, RR45-A, RR45-DEL, RR45-S, RR45-SILENT, RR55-AE, RR65-AE, RR65-SE		

springs

group 1



1

GEV No.	526509	Ref. No.	00897.0.00.03
description	compression spring ø 8.5mm L 95mm wire gauge ø 0.8mm right		
For models:	MAC64, MC, RR45-A, RR45-S, RR45-SILENT, RR55-AE, RR65-AE, RR65-SE		



1

GEV No.	526513	Ref. No.	17684.0.00.03
description	tension spring ø 11mm total length 44mm wire gauge ø 0.9mm L1 35mm for lever		
For models:	MAC64, MC, RR45-A, RR45-S, RR45-SILENT		

glass cylinders



1

GEV No.	527305	Ref. No.	01429.0.00.02
description	glass cylinder for dosing container ø 125mm H 60mm plexiglas		
For models:	MC, RR45-A, RR45-DEL, RR45-S, RR45-SILENT, RR55-AE, RR65-AE, RR65-SE		

coffee presses

coffee presses



1

GEV No.	527549	Ref. No.	00797.0.00.02
description	coffee press ø 57mm H 98mm plastic		
For models:	MAC64, MAC64-On-Demand, RR45-On-Demand, RR55-On-Demand		

sector plates



1

GEV No.	527553	Ref. No.	01772.0.00.01 01772.0.40.01
description	sector plates SS		
For models:	MC, RR45-A, RR45-DEL, RR45-S, RR45-SILENT, RR55-AE, RR65-AE, RR65-SE		

miscellaneous



1

GEV No.	526541	Ref. No.	12472.0.00.01
description	frame for lid L 73.5mm W 44mm H 8mm mounting pos. lower plastic		
For models:	RR45-A, RR45-DEL		

stars

upper



1

GEV No.	527552	Ref. No.	01485.0.00.02
description	star mounting pos. upper ø 112mm H 19mm		
For models:	MC, RR45-A, RR45-DEL, RR45-S, RR45-SILENT, RR55-AE, RR65-AE, RR65-SE		

adjustment mechanism

lockable adjustment



1

GEV No.	526536	Ref. No.	01470.0.00.02
description	pressure pin for setting ring L 20mm W 17mm shaft ø 5mm shaft length 26mm		
For models:	RR45-PST, RR45-S, RR55-AE, RR65-AE, RR65-SE		

setting rings



1

GEV No.	527400	Ref. No.	10200.0.00.02 20722.0.00.02
description	setting ring mounting ø 76mm ø 99mm ID ø 51mm H 34mm suitable for ROSSI for RR45A equiv. no. 28371		
For models:	RR45-A, RR45-DEL, RR45-On-Demand, RR45-S, RR45-SILENT, RR55-On-Demand		



1

GEV No.	527402	Ref. No.	11593.0.00.02
description	setting ring suitable for BRASILIA for Office equiv. no. 11593		
For models:	CP1, CP2, OFFICE RB2, RB1, RB2		

coffee beans containers

container lids



1

GEV No.	527327	Ref. No.	N/A
description	lid for coffee beans container ø 210mm		

coffee beans containers



1

GEV No.	527309	Ref. No.	10513.0.00.02
description	coffee beans container		
For models:	CP1, CP2, OFFICE RB2, RB1, RB2		



1

GEV No.	531179	Ref. No.	N/A	
description	coffee beans container without lid ø 207mm H 245mm universal			
accessories for	531179			
	GEV No.	527327	Ref. No.	N/A
	lid for coffee beans container ø 210mm			



1

GEV No.	527355	Ref. No.	13808.4.00.09
description	container complete ø 210mm H 290mm seat ø 51mm		
For models:	MC, RR65-SE		

support for filter holder



1

GEV No.	527891	Ref. No.	00798.0.00.02
description	filter holder support for dosing unit L 71mm W 98mm H 25mm plastic		
For models:	RR45-A, RR45-DEL, RR45-On-Demand, RR45-PST, RR45-S, RR45-SILENT		

for cup coffee machines

water containers



1

GEV No.	527308	Ref. No.	10192.0.00.02
description	lid for water container		
For models:	CP1, CP2, OFFICE RB2, RB1, RB2		



1

GEV No.	527307	Ref. No.	10193.0.00.02
description	water container suitable for BRASILIA		
For models:	CP1, CP2, OFFICE RB2, RB1, RB2		

knobs

producer-specific knobs

BRASILIA



1			
GEV No.	111294	Ref. No.	18053.0.00.02
description	knob shaft 5x5 black		
For models:	Opus, Opus-B03-OR, Opus-OR, Opus-Sublima		



1			
GEV No.	111100	Ref. No.	00772.0.00.02
description	knob switch zero mark ø 28mm shaft ø 7mm black		
For models:	100, 105, 105SL, 205, Belle-Epoque, CLUB, Firenze, MILLENNIO		



1			
GEV No.	111774	Ref. No.	17196.0.00.02
description	knob zero mark ø 40mm shaft ø 5x5mm black		

steam/water taps

knob dial plates



1			
GEV No.	111300	Ref. No.	19104.0.00.02
description	symbol ø 32mm L 28mm		
For models:	Roma, Roma-OR, Roma-OR-170		



1			
GEV No.	111275	Ref. No.	16884.0.00.02
description	symbol steam ø 32mm L 28mm		
For models:	Cadetta, Maior, Maior-OR, Maior-Plus, Roma, Roma-Cappuccino, Roma-OR, Roma-OR-170		



1			
GEV No.	111276	Ref. No.	16885.0.00.02
description	symbol water ø 32mm L 28mm		
For models:	Cadetta, Maior, Maior-OR, Maior-Plus, Roma, Roma-Cappuccino, Roma-OR, Roma-OR-170		

accessories



1			
GEV No.	528762	Ref. No.	12185.0.00.03
description	cotter pin ø 1.8mm L 17mm		
For models:	Maior, Maior-OR, Maior-Plus, MC, Roma, Roma-Cappuccino, Roma-OR, Roma-OR-170, RR45-A, RR45-S, RR45-SILENT, RR55-AE, RR65-AE, RR65-SE		

accessories

knob adaptors



1			
GEV No.	528261	Ref. No.	02088.0.00.04 02088.0.10.04
description	knob adaptor		
For models:	105, 105SL, Belle-Epoque, CAPPUCCINO		

handles and hand wheels

mushroom cap handles



1			
GEV No.	111782	Ref. No.	00781.0.00.02
description	mushroom cap handle thread M6 handle ø 25mm L 17mm plastic black		

equipment feet and end caps

equipment feet with stem



1			
GEV No.	526537	Ref. No.	18673.0.00.02
description	equipment foot ø 29mm H 24mm bore ø 5.5mm		
For models:	RR45-A, RR45-DEL, RR45-On-Demand, RR45-S, RR45-SILENT, RR55-On-Demand		



gaskets

O-rings

EPDM

GEV No.	504512	Ref. No.	01389.0.00.02 18511.0.00.02
description	O-ring EPDM thickness 1.78mm ID ø 14mm Qty 1 pcs		
For models:	100, 105, 105SL, 205, 205-Exclusive, Cadetta, Century, Century-Restyling, DeCurtis-CAMME, DeCurtis-DIG, DeCurtis-LEVA, Excelsior-OR, Excelsior-Standard, Executive, Firenze, Firenze-SL, Firenze-SL-Raised, Gradisca, Gradisca-Restyling, Gradisca-Take-Away, Maior, Maior-OR, Maior-Plus, MILLENNIO, Opus, Opus-B03-OR, Opus-OR, Opus-Sublima, PORTOFINO, PORTOFINO AMERICA, Portofino-Restyling		

GEV No.	528243	Ref. No.	01390.0.00.02 02107.0.00.04 18512.0.00.02
description	O-ring EPDM thickness 1.78mm ID ø 15.6mm Qty 1 pcs		
For models:	100, 105, 105SL, 205, 205-Exclusive, Cadetta, Century, Century-Restyling, DeCurtis-CAMME, DeCurtis-DIG, DeCurtis-LEVA, Excelsior-OR, Excelsior-Standard, Executive, Firenze, Firenze-SL, Firenze-SL-Raised, Gradisca, Gradisca-Restyling, Gradisca-Take-Away, Maior, Maior-OR, Maior-Plus, MILLENNIO, Opus, Opus-B03-OR, Opus-OR, Opus-Sublima, PORTOFINO, PORTOFINO AMERICA, Portofino-Restyling		

GEV No.	504574	Ref. No.	00851.0.00.02
description	O-ring EPDM thickness 1.78mm ID ø 9.25mm Qty 1 pcs		
For models:	105, 105SL, Agile, Century, Roma, Roma-Cappuccino, Roma-OR, Roma-OR-170		

GEV No.	529412	Ref. No.	00838.0.00.02
description	O-ring EPDM thickness 2.62mm ID ø 10.78mm Qty 1 pcs		
For models:	100, 105, 105SL, 205, 205-Exclusive, Agile, Belle-Epoque, Century, Century-Restyling, DeCurtis-CAMME, DeCurtis-DIG, DeCurtis-LEVA, Excelsior-OR, Excelsior-Standard, Executive, Firenze, Firenze-SL, Firenze-SL-Raised, Gradisca, Gradisca-Restyling, Gradisca-Take-Away, Maior, Maior-OR, Maior-Plus, MILLENNIO, Opus, Opus-B03-OR, Opus-OR, Opus-Sublima, PORTOFINO, PORTOFINO AM. SUPER, PORTOFINO AMERICA, Portofino-Restyling, Roma, Roma-OR, Roma-OR-170		

GEV No.	511512	Ref. No.	00800.0.00.02
description	O-ring EPDM thickness 2.62mm ID ø 18.72mm Qty 10 pcs		
For models:	105, 105SL, 205, 205-Exclusive, Century-Restyling, Excelsior-OR, Excelsior-Standard, Executive, Firenze, Gradisca, Gradisca-Restyling, Gradisca-Take-Away, Maior, Maior-OR, Maior-Plus, Opus, Opus-B03-OR, Opus-OR		

GEV No.	511395	Ref. No.	00843.0.00.02
description	O-ring EPDM thickness 2.62mm ID ø 71.12mm Qty 1 pcs		
For models:	BELLE EPOQUE JUNIOR, Bolero, CLUB, LADY, MBM GOLF, OFFICE RB2, Opus-Sublima		

GEV No.	528487	Ref. No.	00837.0.00.02
description	O-ring EPDM thickness 2.62mm ID ø 9.19mm Qty 1 pcs		
For models:	105, 105SL, 205, 205-Exclusive, Belle-Epoque, Century, Century-Restyling, DeCurtis-CAMME, DeCurtis-DIG, DeCurtis-LEVA, Firenze, Gradisca, Gradisca-Take-Away, Portofino-Restyling		

GEV No.	506015	Ref. No.	01368.0.00.02
description	O-ring EPDM thickness 3.53mm ID ø 39.69mm Qty 1 pcs		
For models:	CAPPUCCINO		

GEV No.	511711	Ref. No.	10179.0.00.02 14117.0.00.02 18330.0.00.02
description	O-ring EPDM thickness 3.53mm ID ø 78.97mm Qty 1 pcs		
For models:	205-Exclusive		

mechanical components, equipment accessories

silicone

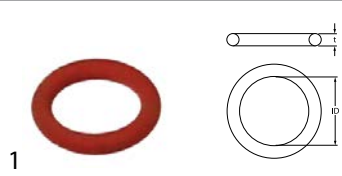

GEV No.	532190	Ref. No.	11970.0.00.02
description	O-ring silicone thickness 1.78mm ID ø 4.48mm Qty 10 pcs		
For models:	Gradisca-Take-Away		

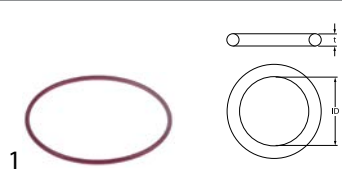

GEV No.	532561	Ref. No.	11428.0.00.02
description	O-ring silicone thickness 2.62mm ID ø 71.12mm Qty 1 pcs		
For models:	205-Exclusive, Excelsior-OR, Excelsior-Standard, Gradisca-Restyling, Opus, Opus-B03-OR, Opus-OR		

Viton



GEV No.	528489	Ref. No.	01370.0.00.02
description	O-ring Viton thickness 1.78mm ID ø 12.42mm Qty 1 pcs		
For models:	100, 105, 105SL, 205, 205-Exclusive, Agile, Belle-Epoque, Cadetta, Century-Restyling, DeCurtis-CAMME, DeCurtis-DIG, DeCurtis-LEVA, Excelsior-OR, Excelsior-Standard, Executive, Firenze, Firenze-SL, Firenze-SL-Raised, Gradisca, Gradisca-Restyling, Gradisca-Take-Away, Maior, Maior-OR, Maior-Plus, MILLENNIO, OFFICE RB2, Opus-B03-OR, Opus-Sublima, PORTOFINO, PORTOFINO AM. SUPER, PORTOFINO AMERICA, Roma, Roma-OR, Roma-OR-170		

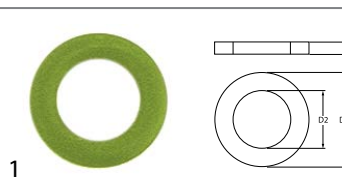

GEV No.	101526	Ref. No.	18509.0.00.02
description	O-ring Viton thickness 1.78mm ID ø 4.48mm Qty 1 pcs		
For models:	205-Exclusive, Cadetta, Century, Excelsior-OR, Excelsior-Standard, Executive, Gradisca-Restyling, Maior, Maior-OR, Maior-Plus, Opus, Opus-B03-OR, Opus-OR, Opus-Sublima		

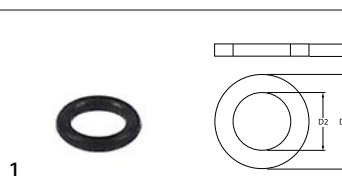

GEV No.	371095	Ref. No.	00833.0.00.02
description	O-ring Viton thickness 1.78mm ID ø 6.07mm Qty 1 pcs		
For models:	100, 105, 105SL, 205, 205-Exclusive, BELLE EPOQUE JUNIOR, Belle-Epoque, Cadetta, CAPPUCINO, Century, Century-Restyling, CLUB, DeCurtis-CAMME, DeCurtis-DIG, DeCurtis-LEVA, Excelsior-OR, Excelsior-Standard, Executive, Firenze, Firenze-SL, Firenze-SL-Raised, Gradisca, Gradisca-Restyling, Gradisca-Take-Away, LADY, Maior, Maior-OR, Maior-Plus, MBM GOLF, MILLENNIO, MINIPODS, Opus, Opus-B03-OR, Opus-OR, Opus-Sublima, PORTOFINO, PORTOFINO AM. SUPER, PORTOFINO AMERICA, Portofino-Restyling, Roma-Cappuccino, SECS, TOP CLASS		

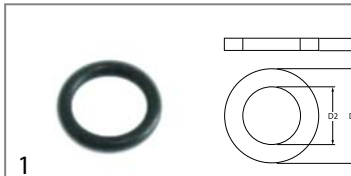

GEV No.	528282	Ref. No.	00835.0.00.02
description	O-ring Viton thickness 1.78mm ID ø 7.66mm Qty 1 pcs		
For models:	100, 105, 105SL, 205, BELLE EPOQUE JUNIOR, Century, Century-Restyling, CLUB, DeCurtis-CAMME, DeCurtis-DIG, DeCurtis-LEVA, Firenze-SL, Firenze-SL-Raised, LADY, MBM GOLF, Opus-Sublima, PORTOFINO, Portofino-Restyling		

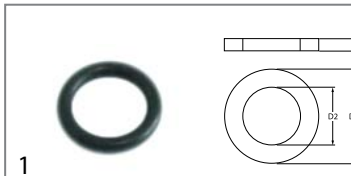

GEV No.	528246	Ref. No.	00836.0.00.02 18510.0.00.02
description	O-ring Viton thickness 1.78mm ID ø 8.73mm Qty 1 pcs		
For models:	100, 105, 105SL, 205, 205-Exclusive, Cadetta, Century, Century-Restyling, DeCurtis-CAMME, DeCurtis-DIG, DeCurtis-LEVA, Excelsior-OR, Excelsior-Standard, Executive, Firenze, Firenze-SL, Firenze-SL-Raised, Gradisca, Gradisca-Restyling, Gradisca-Take-Away, Maior, Maior-OR, Maior-Plus, MILLENNIO, Opus, Opus-B03-OR, Opus-OR, Opus-Sublima, PORTOFINO, PORTOFINO AMERICA, Portofino-Restyling		

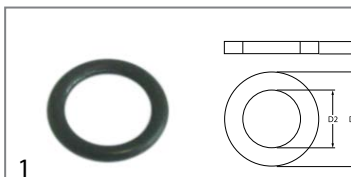

GEV No.	528291	Ref. No.	07001.0.00.02
description	O-ring Viton thickness 2.62mm ID ø 11.91mm Qty 1 pcs		
For models:	205, 205-Exclusive, Agile, Bolero, Cadetta, Excelsior-OR, Excelsior-Standard, Executive, Firenze-SL, Firenze-SL-Raised, Gradisca, Gradisca-Restyling, Gradisca-Take-Away, Maior, Maior-OR, Maior-Plus, MILLENNIO, OFFICE RB2, Opus, Opus-B03-OR, Opus-OR, Opus-Sublima, PORTOFINO AMERICA, Portofino-Restyling, Roma, Roma-Cappuccino, Roma-OR, Roma-OR-170, SECS, TOP CLASS		

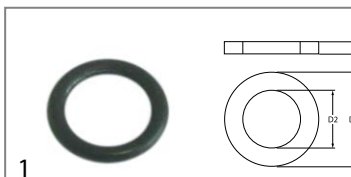

GEV No.	528231	Ref. No.	00839.0.00.02
description	O-ring Viton thickness 2.62mm ID ø 12.37mm Qty 1 pcs		
For models:	100, 105, 105SL, 205, 205-Exclusive, BELLE EPOQUE JUNIOR, CLUB, DeCurtis-CAMME, DeCurtis-DIG, DeCurtis-LEVA, Excelsior-OR, Excelsior-Standard, Gradisca, Gradisca-Restyling, Gradisca-Take-Away, LADY, MBM GOLF, MILLENNIO, Opus, Opus-B03-OR, Opus-OR, Portofino-Restyling		



GEV No.	528647	Ref. No.	00840.0.00.02
description	O-ring Viton thickness 2.62mm ID \varnothing 15.08mm Qty 1 pcs		
For models:	105, 105SL, Belle-Epoque, CAPPUCCINO, MILLENNIO, PORTOFINO AM. SUPER, PORTOFINO AMERICA, Roma-Cappuccino		

GEV No.	528240	Ref. No.	01428.0.00.02
description	O-ring Viton thickness 2mm ID \varnothing 4mm Qty 1 pcs		
For models:	100, 105, 105SL, 205, Century, Century-Restyling, DeCurtis-CAMME, DeCurtis-DIG, DeCurtis-LEVA, Firenze, Firenze-SL, Firenze-SL-Raised, Gradisca, Gradisca-Take-Away, MILLENNIO, PORTOFINO, PORTOFINO AMERICA, Portofino-Restyling		

GEV No.	528293	Ref. No.	06370.0.00.02
description	O-ring Viton thickness 2.62mm ID \varnothing 15.88mm Qty 1 pcs		
For models:	205, 205-Exclusive, Gradisca, Gradisca-Take-Away, Maior, Maior-OR, Maior-Plus, MILLENNIO, PORTOFINO AMERICA, Roma, Roma-Cappuccino, Roma-OR, Roma-OR-170, SECS, TOP CLASS		

GEV No.	528250	Ref. No.	00847.0.00.02
description	O-ring Viton thickness 2mm ID \varnothing 8mm Qty 1 pcs		
For models:	105, 105SL, Belle-Epoque, CAPPUCCINO, MILLENNIO, PORTOFINO AM. SUPER, PORTOFINO AMERICA, Roma-Cappuccino		

GEV No.	532560	Ref. No.	12953.0.00.02
description	O-ring Viton thickness 2.62mm ID \varnothing 20.63mm Qty 1 pcs		
For models:	DeCurtis-CAMME, DeCurtis-DIG, DeCurtis-LEVA, Gradisca		

GEV No.	528155	Ref. No.	00842.0.00.02
description	O-ring Viton thickness 3.53mm ID \varnothing 32.93mm Qty 1 pcs		
For models:	Belle-Epoque		

GEV No.	528413	Ref. No.	03182.0.00.02
description	O-ring Viton thickness 2.62mm ID \varnothing 47.3mm Qty 1 pcs		
For models:	105, 105SL, Agile, BELLE EPOQUE JUNIOR, Belle-Epoque, Bolero, CAPPUCCINO, Century, CLUB, LADY, MBM GOLF, PORTOFINO, PORTOFINO AM. SUPER, PORTOFINO AMERICA, Roma, Roma-Cappuccino, Roma-OR, Roma-OR-170		

GEV No.	532456	Ref. No.	18682.0.00.02 18682.0.00.03
description	O-ring Viton thickness 2mm ID \varnothing 16mm Qty 1 pcs		
For models:	Agile, Cadetta, Opus-B03-OR		

sealing washers

rubber gaskets

GEV No.	528254	Ref. No.	00109.0.00.04
description	flat gasket ED \varnothing 26mm ID \varnothing 21mm thickness 3mm Qty 1 pcs		
For models:	PORTOFINO		

copper gaskets

DIN-7603-A

GEV No.	528233	Ref. No.	01404.0.00.02 21559.0.00.03
description	flat gasket copper ED \varnothing 12mm ID \varnothing 8.3mm thickness 1.5mm		
For models:	Agile		

			
1			
GEV No.	528698	Ref. No.	12152.0.00.03
description	flat gasket copper ED ø 24mm ID ø 20mm thickness 1mm		
For models:	105, 105SL, 205, 205-Exclusive, Century, Century-Restyling, Executive, Firenze, Firenze-SL, Firenze-SL-Raised, Gradisca, Gradisca-Restyling, Gradisca-Take-Away, PORTOFINO, PORTOFINO AM. SUPER, PORTOFINO AMERICA, Portofino-Restyling, TOP CLASS		

DIN-7603-C			
			
1			
GEV No.	527164	Ref. No.	01386.0.00.02
description	gasket copper ED ø 23mm ID ø 17mm thickness 3mm for thread 3/8"		
For models:	100, 105, 105SL, 205, 205-Exclusive, Agile, Belle-Epoque, Cadetta, Century, Century-Restyling, DeCurtis-CAMME, DeCurtis-DIG, DeCurtis-LEVA, Excelsior-OR, Excelsior-Standard, Executive, Firenze, Firenze-SL, Firenze-SL-Raised, Gradisca, Gradisca-Restyling, Gradisca-Take-Away, MILLENNIO, OFFICE RB2, Opus, Opus-B03-OR, Opus-OR, Opus-Sublima, PORTOFINO, PORTOFINO AMERICA, Portofino-Restyling, Roma, Roma-Cappuccino, Roma-OR, Roma-OR-170, SECS, TOP CLASS		

PTFE gaskets			
			
1			
GEV No.	526554	Ref. No.	08576.0.00.02
description	flat gasket PTFE ED ø 10mm ID ø 6mm thickness 1mm Qty 1 pcs		
For models:	DeCurtis-CAMME, DeCurtis-DIG, DeCurtis-LEVA, Gradisca		

			
1			
GEV No.	526661	Ref. No.	00813.0.00.02
description	flat gasket PTFE ED ø 17mm ID ø 13mm thickness 2mm Qty 1 pcs		
For models:	100, 105, 105SL, 205, 205-Exclusive, Agile, Belle-Epoque, Century, Century-Restyling, DeCurtis-CAMME, DeCurtis-DIG, DeCurtis-LEVA, Excelsior-OR, Excelsior-Standard, Executive, Firenze, Firenze-SL, Firenze-SL-Raised, Gradisca, Gradisca-Restyling, Gradisca-Take-Away, Maior, Maior-OR, Maior-Plus, MILLENNIO, Opus-B03-OR, Opus-Sublima, PORTOFINO, PORTOFINO AM. SUPER, PORTOFINO AMERICA, Portofino-Restyling, Roma, Roma-OR, Roma-OR-170		

			
1			
GEV No.	526679	Ref. No.	N/A
description	flat gasket PTFE ED ø 18mm ID ø 13mm thickness 2mm Qty 1 pcs		

			
1			
GEV No.	527993	Ref. No.	N/A
description	flat gasket PTFE ED ø 18mm ID ø 13mm thickness 2mm Qty 1 pcs		

			
1			
GEV No.	528314	Ref. No.	00820.0.00.02
description	flat gasket PTFE ED ø 20mm ID ø 17mm thickness 2mm Qty 1 pcs suitable for Astoria/Azkoyen/Espresa/Wega		
For models:	205-Exclusive, Cadetta, Century, Excelsior-OR, Excelsior-Standard, Executive, Gradisca-Restyling, Maior, Maior-OR, Maior-Plus, Opus, Opus-B03-OR, Opus-OR, Opus-Sublima, Roma-Cappuccino		

			
1			
GEV No.	527154	Ref. No.	08575.0.00.02
description	flat gasket PTFE ED ø 22mm ID ø 16.8mm thickness 2mm Qty 1 pcs		
For models:	205-Exclusive, Century-Restyling, DeCurtis-CAMME, DeCurtis-DIG, DeCurtis-LEVA, Excelsior-OR, Excelsior-Standard, Executive, Gradisca, Gradisca-Restyling, Maior, Maior-OR, Maior-Plus, Opus, Opus-B03-OR, Opus-OR, Portofino-Restyling		

			
1			
GEV No.	528683	Ref. No.	00812.0.00.02
description	flat gasket PTFE ED ø 26mm ID ø 21mm thickness 2mm Qty 1 pcs suitable for GAGGIA, SPAZIALE		
For models:	DeCurtis-CAMME, DeCurtis-DIG, DeCurtis-LEVA, Gradisca		

			
1			
GEV No.	526014	Ref. No.	04360.0.00.02
description	flat gasket PTFE ED ø 35mm ID ø 30mm thickness 2mm Qty 1 pcs		
For models:	105, 105SL, 205, 205-Exclusive, Century-Restyling, DeCurtis-CAMME, DeCurtis-DIG, DeCurtis-LEVA, Excelsior-OR, Excelsior-Standard, Executive, Firenze, Gradisca, Gradisca-Restyling, Gradisca-Take-Away, Maior, Maior-OR, Maior-Plus, Opus, Opus-B03-OR, Opus-OR, Portofino-Restyling		

			
1			
GEV No.	528018	Ref. No.	18661.0.00.02 18661.2.00.02
description	flat gasket PTFE ED ø 41mm ID ø 33mm thickness 3mm size 1" Qty 1 pcs		
For models:	Roma-Cappuccino		

			
1			
GEV No.	528021	Ref. No.	00826.0.00.02 02286
description	flat gasket PTFE ED ø 53mm ID ø 42.5mm thickness 3mm Qty 1 pcs equiv. no. 12001/02286 suitable for Astoria/Aurora/Brasilia/Wega		
For models:	Belle-Epoque, DeCurtis-CAMME, DeCurtis-DIG, DeCurtis-LEVA, MILLENNIO, PORTOFINO AM. SUPER, PORTOFINO AMERICA, SECS, TOP CLASS		

			
1			
GEV No.	528277	Ref. No.	05809.0.00.02
description	gasket PTFE ED ø 15mm ID ø 12.4mm thickness 0.6mm Qty 1 pcs		
For models:	100, 105, 105SL, 205, Century, Firenze, Gradisca, Gradisca-Take-Away, MILLENNIO, PORTOFINO, PORTOFINO AM. SUPER, PORTOFINO AMERICA		

special gaskets

group gaskets

			
1			
GEV No.	528406	Ref. No.	04394.0.00.02
description	group gasket L 79mm W 73mm thickness 2mm hole distance 55mm suitable for BRASILIA equiv. no. 04394 fibre		
For models:	100, 105, 105SL, 205, 205-Exclusive, Cadetta, Century-Restyling, DeCurtis-CAMME, DeCurtis-DIG, DeCurtis-LEVA, Excelsior-OR, Excelsior-Standard, Executive, Firenze, Gradisca, Gradisca-Restyling, Gradisca-Take-Away, Maior, Maior-OR, Maior-Plus, MILLENNIO, Opus, Opus-B03-OR, Opus-OR, Portofino-Restyling		

			
1			
GEV No.	528142	Ref. No.	00814.0.00.02
description	group gasket L 76mm W 50mm thickness 3mm hole distance 60mm suitable for BEZZERA		
For models:	105, 105SL, Agile, Belle-Epoque, Century, Firenze-SL, Firenze-SL-Raised, PORTOFINO, PORTOFINO AM. SUPER, PORTOFINO AMERICA, Roma, Roma-Cappuccino, Roma-OR, Roma-OR-170		

			
1			
GEV No.	528355	Ref. No.	N/A
description	group gasket L 74mm W 74mm thickness 3.5mm suitable for AZKOYEN		

springs

compression springs

			
1			
GEV No.	528237	Ref. No.	00884.0.00.03
description	compression spring ø 10.8mm L 29mm wire gauge ø 1.6mm		
For models:	100, 105, 105SL, 205, Belle-Epoque, CAPPUCCINO, Century, Century-Restyling, DeCurtis-CAMME, DeCurtis-DIG, DeCurtis-LEVA, Firenze, Firenze-SL, Firenze-SL-Raised, Gradisca, Gradisca-Take-Away, MILLENNIO, PORTOFINO, PORTOFINO AM. SUPER, PORTOFINO AMERICA, Portofino-Restyling, Roma-Cappuccino		

			
1			
GEV No.	529704	Ref. No.	07060.0.00.03
description	compression spring ø 11.8mm L 16mm wire gauge ø 1.6mm steel		
For models:	205, 205-Exclusive, Agile, Bolero, Cadetta, Excelsior-OR, Excelsior-Standard, Executive, Firenze-SL, Firenze-SL-Raised, Gradisca, Gradisca-Restyling, Gradisca-Take-Away, Maior, Maior-OR, Maior-Plus, MILLENNIO, OFFICE RB2, Opus, Opus-OR, Opus-Sublima, PORTOFINO AMERICA, Portofino-Restyling, Roma, Roma-Cappuccino, Roma-OR, Roma-OR-170, SECS, TOP CLASS		

			
1			
GEV No.	528284	Ref. No.	10962.0.00.03
description	compression spring ø 11mm L 26mm wire gauge ø 1.3mm		
For models:	105, 105SL, 205, 205-Exclusive, Century, Century-Restyling, Executive, Firenze, Firenze-SL, Firenze-SL-Raised, Gradisca, Gradisca-Restyling, Gradisca-Take-Away, PORTOFINO, PORTOFINO AM. SUPER, PORTOFINO AMERICA, Portofino-Restyling		

			
1			
GEV No.	528253	Ref. No.	00866.0.00.03
description	compression spring ø 12.5mm L 28mm wire gauge ø 1.6mm		
For models:	PORTOFINO		

			
1			
GEV No.	528493	Ref. No.	17695.0.00.03
description	compression spring ø 12.6mm L 30mm wire gauge ø 1.9mm		
For models:	205-Exclusive, Cadetta, Century, Excelsior-OR, Excelsior-Standard, Executive, Gradisca-Restyling, Maior, Maior-OR, Maior-Plus, Opus, Opus-B03-OR, Opus-OR, Opus-Sublima		



GEV No.	526561	Ref. No.	12941.0.00.03
description	compression spring ø 14.3mm L 21mm wire gauge ø 1.8mm		
For models:	DeCurtis-CAMME, DeCurtis-DIG, DeCurtis-LEVA, Gradisca		



GEV No.	526560	Ref. No.	08952.0.00.03
description	compression spring ø 14.3mm L 46mm wire gauge ø 1.5mm		
For models:	DeCurtis-CAMME, DeCurtis-DIG, DeCurtis-LEVA, Gradisca		



GEV No.	529946	Ref. No.	08953.0.00.03
description	compression spring ø 14.7mm L 34mm wire gauge ø 2mm		
For models:	DeCurtis-CAMME, DeCurtis-DIG, DeCurtis-LEVA, Gradisca		



GEV No.	528235	Ref. No.	00863.0.00.03
description	compression spring ø 5.5mm L 15mm wire gauge ø 0.05mm		



GEV No.	528269	Ref. No.	00871.0.00.03
description	compression spring ø 7.5mm L 18mm wire gauge ø 1.1mm		
For models:	105, 105SL, Agile, Belle-Epoque, CAPPUCCINO, DeCurtis-CAMME, DeCurtis-DIG, DeCurtis-LEVA, Firenze-SL, Firenze-SL-Raised, Opus-Sublima, SECS, TOP CLASS		



GEV No.	528248	Ref. No.	00870.0.00.03
description	compression spring ø 7.8mm L 40mm wire gauge ø 0.5mm		
For models:	100, 105, 105SL, 205, 205-Exclusive, Belle-Epoque, Cadetta, CAPPUCCINO, Century, Century-Restyling, DeCurtis-CAMME, DeCurtis-DIG, DeCurtis-LEVA, Excelsior-OR, Excelsior-Standard, Executive, Firenze, Firenze-SL, Firenze-SL-Raised, Gradisca, Gradisca-Restyling, Gradisca-Take-Away, Maior, Maior-OR, Maior-Plus, MILLENNIO, Opus, Opus-B03-OR, Opus-OR, Opus-Sublima, PORTOFINO, PORTOFINO AM. SUPER, PORTOFINO AMERICA, Portofino-Restyling, Roma-Cappuccino		



GEV No.	528249	Ref. No.	05538.0.00.03
description	compression spring ø 7.8mm L 40mm wire gauge ø 0.5mm		
For models:	105, 105SL, Belle-Epoque, CAPPUCCINO, MILLENNIO, PORTOFINO AM. SUPER, PORTOFINO AMERICA, Roma-Cappuccino		



GEV No.	526509	Ref. No.	00897.0.00.03
description	compression spring ø 8.5mm L 95mm wire gauge ø 0.8mm right		
For models:	MAC64, MC, RR45-A, RR45-S, RR45-SILENT, RR55-AE, RR65-AE, RR65-SE		



GEV No.	527555	Ref. No.	00898.0.00.03
description	compression spring ø 9.9mm L 80mm wire gauge ø 0.8mm		
For models:	MC, RR45-A, RR45-DEL, RR45-PST, RR45-S, RR45-SILENT, RR55-AE, RR65-AE, RR65-SE		

tension springs





GEV No.	526513	Ref. No.	17684.0.00.03
description	tension spring ø 11mm total length 44mm wire gauge ø 0.9mm L1 35mm for lever		
For models:	MAC64, MC, RR45-A, RR45-S, RR45-SILENT		

coffee accessories

milk foamers

milk foamers



GEV No.	525933	Ref. No.	10075.4.00.09
description	milk foamer connection 6mm angle 90° plastic		
For models:	Agile, Firenze-SL, Firenze-SL-Raised, Gradisca, Roma, Roma-OR, Roma-OR-170		
accessories for	525933		
	GEV No.	Ref. No.	—
	531255		
	adapter thread 3/8" L 40mm		



manometers

			
1			
GEV No.	541257	Ref. No.	06555.2.00.08
description	manometer double scale ø 58mm pressure range 0-2.5 / 0-15bar connection on the backside coffee machine thread 1/8"		
For models:	Agile, PORTOFINO, PORTOFINO AMERICA		

			
1			
GEV No.	541256	Ref. No.	00737.2.00.08 04971.2.00.08 05465.2.00.08 05466.2.00.08
description	manometer double scale ø 58mm pressure range 0-3 / 0-15bar connection on the backside coffee machine thread 1/8"		
For models:	100, 105, 105SL, 205, 205-Exclusive, Century, Century-Restyling, Gradisca, Gradisca-Restyling, Gradisca-Take-Away, MILLENNIO, Portofino-Restyling		

dosing pumps

accessories

hose couplings

metal

			
1			
GEV No.	361182	Ref. No.	00177.0.00.04
description	nut thread 1/4" H 5mm nickel-plated brass WS 17 Qty 1 pcs		
For models:	Agile, Cadetta, Century-Restyling, DeCurtis-CAMME, DeCurtis-DIG, DeCurtis-LEVA, Excelsior-OR, Excelsior-Standard, Executive, Firenze-SL, Firenze-SL-Raised, Gradisca-Restyling, Maior, Maior-OR, Maior-Plus, Opus, Opus-B03-OR, Opus-OR, Opus-Sublima, Roma, Roma-OR, Roma-OR-170		

fittings, hose and pipe connectors

fittings

double nipples

			
1			
GEV No.	520160	Ref. No.	00236.0.00.04
description	double nipple nickel-plated brass thread 1/8" - 1/8" Qty 1 pcs		
For models:	105, 105SL, 205, 205-Exclusive, Agile, Belle-Epoque, Bolero, Cadetta, Century, Century-Restyling, DeCurtis-CAMME, DeCurtis-DIG, DeCurtis-LEVA, Excelsior-OR, Excelsior-Standard, Executive, Firenze, Firenze-SL, Firenze-SL-Raised, Gradisca, Gradisca-Restyling, Gradisca-Take-Away, Maior, Maior-OR, Maior-Plus, Opus, Opus-B03-OR, Opus-OR, Opus-Sublima, Portofino-Restyling, Roma, Roma-Cappuccino, Roma-OR, Roma-OR-170		

angle pieces

			
1			
GEV No.	520816	Ref. No.	00217.0.00.04
description	angle piece thread 1/8" ET - 1/8" ET nickel-plated brass		
For models:	105, 105SL, 205-Exclusive, Belle-Epoque, Century, Century-Restyling, DeCurtis-CAMME, DeCurtis-DIG, DeCurtis-LEVA, Excelsior-OR, Excelsior-Standard, Firenze, Firenze-SL, Firenze-SL-Raised, Gradisca-Restyling, Gradisca-Take-Away, Opus, Opus-B03-OR, Opus-OR, Opus-Sublima, Roma-Cappuccino		

fastening material

screws

sheet metal screws

			
1			
GEV No.	560105	Ref. No.	01254.0.00.03
description	sheet metal screws ø 3.9mm L 25mm SS Qty 20 pcs DIN 7981/ISO 7049 head ø 7.5mm oval head		

countersunk screws



1

GEV No.	560215	Ref. No.	01242.0.00.03
description	countersunk screw thread M5 L 14mm SS DIN 963/ISO 2009 Qty 20 pcs intake slotted head ø 9.2mm		
For models:	105, 105SL, Agile, Belle-Epoque, Century, Firenze-SL, Firenze-SL-Raised, Roma, Roma-Cappuccino, Roma-OR, Roma-OR-170		

flat-headed bolts



1

GEV No.	560365	Ref. No.	07079.0.00.03 20096.0.00.03
description	flat-headed bolt thread M4 thread L 8mm SS DIN 7985/ISO 7045 Qty 1 pcs intake Phillips head ø 8mm head thickness 3mm		
For models:	MAC64, MAC64-On-Demand, RR45-A, RR45-DEL, RR45-On-Demand, RR45-PST, RR45-S, RR45-SILENT, RR55-AE, RR55-On-Demand, RR65-AE, RR65-SE		

hexagonal screws



1

GEV No.	560204	Ref. No.	01231.0.00.03
description	hexagonal screw thread M8 thread L 25mm SS WS 13 Qty 1 pcs DIN 933 / ISO 4017		
For models:	105, 105SL, Agile, Belle-Epoque, Century, Firenze-SL, Firenze-SL-Raised, Roma, Roma-Cappuccino, Roma-OR, Roma-OR-170		

cylinder head bolts

DIN 912/ISO 4762



1

GEV No.	560025	Ref. No.	02688.0.00.03
description	cylinder head bolt thread M4 thread L 10mm WS 3 SS Qty 20 pcs DIN 912/ISO 4762		
For models:	105, 105SL, 205, 205-Exclusive, Belle-Epoque, Cadetta, Century, Century-Restyling, DeCurtis-CAMME, DeCurtis-DIG, DeCurtis-LEVA, Excelsior-OR, Excelsior-Standard, Executive, Firenze, Firenze-SL, Firenze-SL-Raised, Gradisca, Gradisca-Restyling, Gradisca-Take-Away, Maior, Maior-OR, Maior-Plus, Opus, Opus-B03-OR, Opus-OR, Opus-Sublima, Portofino-Restyling		



1

GEV No.	560402	Ref. No.	01247.0.00.03
description	cylinder head bolt thread M5 thread L 10mm L 15.5mm WS 4 SS Qty 1 pcs intake hexagonal DIN 912/ISO 4762		
For models:	Belle-Epoque, MC, RR45-A, RR45-S, RR45-SILENT, RR55-AE, RR65-AE, RR65-SE		



1

GEV No.	560031	Ref. No.	05545.0.00.03
description	cylinder head bolt thread M6 thread L 10mm WS 5 SS Qty 20 pcs DIN 912/ISO 4762		
For models:	105, 105SL, 205, 205-Exclusive, Cadetta, Century-Restyling, DeCurtis-CAMME, DeCurtis-DIG, DeCurtis-LEVA, Excelsior-OR, Excelsior-Standard, Executive, Firenze, Gradisca, Gradisca-Restyling, Gradisca-Take-Away, Maior, Maior-OR, Maior-Plus, Opus, Opus-B03-OR, Opus-OR, Portofino-Restyling		



1

GEV No.	112021	Ref. No.	02680.0.00.03
description	cylinder head bolt thread M8 L 45mm thread L 30mm WS 6 zinc-coated steel Qty 1 pcs DIN 912/ISO 4762		
For models:	205-Exclusive, Agile, Cadetta, DeCurtis-CAMME, DeCurtis-DIG, DeCurtis-LEVA, Gradisca, Gradisca-Restyling, Opus, Opus-B03-OR, Opus-OR, Opus-Sublima, Portofino-Restyling, Roma, Roma-Cappuccino, Roma-OR, Roma-OR-170		

grub screws

DIN 913/ISO 4026



1

GEV No.	560346	Ref. No.	16518.0.40.04
description	grub screw thread M5 L 6mm SS DIN 913/ISO 4026 intake internal hexagon WS 2.5 Qty 20 pcs		
For models:	Opus-Sublima		

nuts

hexagonal nuts

DIN 985



1

GEV No.	560142	Ref. No.	12188.0.00.03
description	hexagonal nut thread M6 H 6mm SS WS 10 Qty 20 pcs DIN/ISO DIN 985 self-locking		
For models:	MC, RR45-A, RR45-S, RR45-SILENT, RR55-AE, RR65-AE, RR65-SE		



hexagonal nuts metric (without norm)



1

GEV No.	527169	Ref. No.	01263.0.00.03
description	hexagonal nut thread M3 H 2.8mm WS 5.5 brass Qty 1 pcs		
For models:	105, 105SL, 205, 205-Exclusive, Century, Century-Restyling, Executive, Firenze, Firenze-SL, Firenze-SL-Raised, Gradisca, Gradisca-Restyling, Gradisca-Take-Away, Portofino-Restyling		

hexagonal nuts inch thread



1

GEV No.	361182	Ref. No.	00177.0.00.04
description	nut thread 1/4" H 5mm nickel-plated brass WS 17 Qty 1 pcs		
For models:	Agile, Cadetta, Century-Restyling, DeCurtis-CAMME, DeCurtis-DIG, DeCurtis-LEVA, Excelsior-OR, Excelsior-Standard, Executive, Firenze-SL, Firenze-SL-Raised, Gradisca-Restyling, Maior, Maior-OR, Maior-Plus, Opus, Opus-B03-OR, Opus-OR, Opus-Sublima, Roma, Roma-OR, Roma-OR-170		

washers

washers

DIN 9021



1

GEV No.	560117	Ref. No.	12187.0.00.03
description	plain washer ID ø 6.4mm ED ø 18mm thickness 1.5mm SS Qty 20 pcs DIN 9021 for thread M6		
For models:	MAC64, MC, RR45-A, RR45-S, RR45-SILENT, RR55-AE, RR65-AE, RR65-SE		

miscellaneous



1

GEV No.	528268	Ref. No.	00166.0.00.04
description	disc ID ø 5.4mm ED ø 10mm thickness 2mm		
For models:	100, 105, 105SL, 205, 205-Exclusive, Agile, Cadetta, CAPPUCCINO, Century, Century-Restyling, DeCurtis-CAMME, DeCurtis-DIG, DeCurtis-LEVA, Excelsior-OR, Excelsior-Standard, Executive, Firenze, Firenze-SL, Firenze-SL-Raised, Gradisca, Gradisca-Restyling, Gradisca-Take-Away, Maior, Maior-OR, Maior-Plus, MILLENNIO, Opus, Opus-B03-OR, Opus-OR, Opus-Sublima, PORTOFINO, PORTOFINO AMERICA, Portofino-Restyling		

tooth lock washers

miscellaneous



1

GEV No.	112020	Ref. No.	01291.0.00.03
description	tooth lock washer ID ø 8.5mm		
For models:	105, 105SL, 205, 205-Exclusive, Agile, Belle-Epoque, Cadetta, DeCurtis-CAMME, DeCurtis-DIG, DeCurtis-LEVA, Firenze, Firenze-SL, Firenze-SL-Raised, Gradisca, Gradisca-Restyling, Opus, Opus-B03-OR, Opus-OR, Opus-Sublima, Portofino-Restyling, Roma, Roma-Cappuccino, Roma-OR, Roma-OR-170		

fasteners

cable ties

1

GEV No.	550253	Ref. No.	01468.0.00.02
description	cable tie W 3.6mm L 290mm white Qty 100 pcs nylon		
For models:	BFD		

retaining rings

DIN 6799



1

GEV No.	516198	Ref. No.	08949.0.00.03
description	retaining ring E D1 ø 6mm D2 ø 12mm SS DIN 6799 thickness 0.7mm for shaft ø 7-9mm		
For models:	MC, RR45-A, RR45-DEL, RR45-S, RR45-SILENT, RR55-AE, RR65-AE, RR65-SE		

cotter pins



1

GEV No.	528762	Ref. No.	12185.0.00.03
description	cotter pin ø 1.8mm L 17mm		
For models:	Maior, Maior-OR, Maior-Plus, MC, Roma, Roma-Cappuccino, Roma-OR, Roma-OR-170, RR45-A, RR45-S, RR45-SILENT, RR55-AE, RR65-AE, RR65-SE		

B			
bi-metal thermostats	5, 5		
booster pumps II	19		
C			
cable ties	47		
condensators & interference suppression filters	20		
cotter pins	47		
countersunk screws	46		
cylinder head bolts	46		
D			
dosing pumps	45		
double nipples	45		
E			
electrodes	18		
electronic magnets	20		
F			
fasteners	47		
fastening material	45		
fittings	45		
flat-headed bolts	46		
flow meters	18		
G			
grub screws	46		
H			
heating elements	3		
heating elements for coffee machine	3		
hexagonal nuts	46		
hexagonal screws	46		
hose couplings	45		
I			
ignition switches	20		
indicator lights	9		
L			
lamps	9		
M			
microswitches	7		
milk foamers	44		
N			
nuts	46		
O			
operating capacitors	20		
		O-rings	39
P			
		pressure switches	18
		probes	11
		pumps	19
		push/momentary push switches	7
R			
		relays	9
		retaining rings	47
		rocker/momentary rocker switches	6
		rotary switches	8
S			
		safety bi-metal thermostats	5
		screws	45
		sealing washers	41
		sheet metal screws	45
		solenoid valves	16
		solid state relays	9
		switches and momentary switches	6
		system switches (ROLD)	8
T			
		thermostats	5
		tooth lock washers	47
V			
		vibration pumps	19
W			
		washers	47