



GAS COMPONENTS



ELECTRIC COMPONENTS



WATER TECHNOLOGY



MECHANICAL COMPONENTS



TOOLS

Spare parts suitable for

BOURGEOIS

Find the complete and up-to-date range of products in our GEV Webshop



Manufacturer catalogue

The most important spare parts and accessories arranged clearly for every manufacturer

- ✓ Complete product range and all appliance data always up to date in the GEV Webshop
- ✓ Alphabetical Index at the end of the catalogue

GEV Webshop

www.gev-online.co.uk

www.gev-online.com









- 🔍 Add to Favourites
- 🔍 Sign In with email address and usual password
- 🔍 Easy-order – place several items in your basket at the same time
- 🔍 Quick Item search – no login needed



heating elements

heating elements for bain maries

			
GEV No.	418448	Ref. No.	RC3006
description	heating element 900W 230V heating circuits 1 L 367mm W 122mm connection M4 tube ø 8.5mm 2 hole fixing thread M14x1 dry heating element bain marie mounting distance 113mm		
spare parts for	418448		
	GEV No.	510417	Ref. No. —
	flat gasket fibre ED ø 20mm ID ø 14mm thickness 2mm Qty 1 pcs		
	GEV No.	550261	Ref. No. —
	nut thread M14x1 H 4mm WS 19 SS Qty 1 pcs		
accessories for	418448		
	GEV No.	520228	Ref. No. —
	tooth lock washer ID ø 15.3mm ED ø 24mm steel Qty 1 pcs for thread M14		
	GEV No.	550262	Ref. No. —
	flat gasket copper ED ø 20mm ID ø 14mm thickness 2mm		

			
GEV No.	420186	Ref. No.	RC3017
description	heating element 7000W 230V heating circuits 3 L 393mm W 245mm H 210mm L1 78mm L2 315mm W1 78mm W2 84mm special fixing tube ø 8mm fryer heaters		

heating elements for griddles

			
GEV No.	418451	Ref. No.	RC3015
description	heating element 1666W 230V heating circuits 1 L 435mm W 60mm H 74mm tube ø 8.5mm 2 hole fixing connection M4 thread M14x1.5 mounting distance 52mm connection length 72mm for griddle dry heating element		

heating elements for fryers







2 hole fixing

			
GEV No.	420184	Ref. No.	RC3000
description	heating element 3500W 230V heating circuits 1 L 294mm W 170mm H 208mm 2 hole fixing connection male faston 6.3mm fryer heaters L1 27mm L2 267mm W1 67mm W2 36mm tube ø 8mm thread M14x1.5 mounting distance 28mm windings 3 suitable for SOLYMAC		

heating elements for pasta cookers

			
GEV No.	420187	Ref. No.	RC3009
description	heating element 2000W 230V heating circuits 1 L 405mm W 46mm H mm 2 hole fixing connection M4 thread M12x1.25 tube ø 8.3mm		

heating elements for pizza ovens

			
GEV No.	418450	Ref. No.	RC3011
description	heating element 1200W 230V L 656mm W 110mm thread M14x1.5 mounting distance 102mm connection length 90mm connection M4 tube ø 8.5mm heating circuits 1 dry heating element 2 hole fixing		
accessories for	418450		
	GEV No.	510417	Ref. No. —
	flat gasket fibre ED ø 20mm ID ø 14mm thickness 2mm Qty 1 pcs		
	GEV No.	520228	Ref. No. —
	tooth lock washer ID ø 15.3mm ED ø 24mm steel Qty 1 pcs for thread M14		
	GEV No.	520230	Ref. No. —
	nut thread M14x1.5 H 5mm WS 19 zinc-coated steel Qty 1 pcs		
	GEV No.	521101	Ref. No. —
	nut thread M14x1.5 H 5mm WS 19 SS Qty 1 pcs		
	GEV No.	550262	Ref. No. —
	flat gasket copper ED ø 20mm ID ø 14mm thickness 2mm		

group 11

			
GEV No.	420185	Ref. No.	RC3018
description	heating element 12000W 230V heating circuits 3 L 415mm W 237mm H 213mm L1 85mm L2 330mm W1 80mm W2 77mm special fixing tube ø 8mm fryer heaters		









GEV No.	420183	Ref. No.	RC3007
description	heating element 1200W 230V L 785mm W 120mm thread M14x1.5 mounting distance 111.5mm connection M4 tube ø 8.5mm heating circuits 1 dry heating element 2 hole fixing for pizza oven		



GEV No.	418449	Ref. No.	RC3010
description	heating element 800W 230V L 682mm W 102mm thread M14x1.5 mounting distance 94mm connection length 82mm connection M4 tube ø 8.5mm heating circuits 1 dry heating element 2 hole fixing		

accessories for 418449

	GEV No.	510417	Ref. No.	—
flat gasket fibre ED ø 20mm ID ø 14mm thickness 2mm Qty 1 pcs				
	GEV No.	520228	Ref. No.	—
tooth lock washer ID ø 15.3mm ED ø 24mm steel Qty 1 pcs for thread M14				
	GEV No.	520230	Ref. No.	—
nut thread M14x1.5 H 5mm WS 19 zinc-coated steel Qty 1 pcs				
	GEV No.	521101	Ref. No.	—
nut thread M14x1.5 H 5mm WS 19 SS Qty 1 pcs				
	GEV No.	550262	Ref. No.	—
flat gasket copper ED ø 20mm ID ø 14mm thickness 2mm				



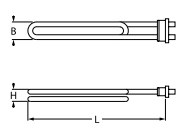

GEV No.	418447	Ref. No.	RC3005
description	heating element 900W 230V L 538mm W 88mm thread M14x1.5 mounting distance 80mm connection length 40mm connection M4 heating circuits 1 dry heating element 2 hole fixing		

immersion heating elements
with compression flange 50 x 26mm

GEV No.	418932	Ref. No.	RC553
description	heating element 2000W 240V heating circuits 1 flange 50x26mm L 350mm W 30mm Hmm compression flange connection male faston 6.3mm tube ø 6.3mm immersion heater		

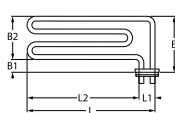



GEV No.	416503	Ref. No.	RC602	
description	heating element 1500W 230V heating circuits 1 flange 50x26mm L 295mm W 108mm L1 32mm L2 263mm W1 23mm W2 85mm mounting distance 24mm compression flange connection male faston 6.3mm tube ø 8mm immersion heater			
accessories for	416503			
	GEV No.	510387	Ref. No.	—
gasket L 46mm W 22mm ømm EPDM for heating element for flange 50x26mm				

miscellaneous



GEV No.	420200	Ref. No.	RC2035
description	heating element 12000W 240V heating circuits 6 L 155mm W 78mm H 83mm tube ø 8.4mm hole distance 61mm hole ø 7mm connection male faston 6.3mm immersion heater flange connection		





GEV No.	420203	Ref. No.	RC2029
description	heating element 12000W 240V heating circuits 6 L 165mm W 74mm H 83.5mm tube ø 8.4mm hole distance 61mm hole ø 7mm number of thermostat sleeves 1 thermostat sleeves ø 7.4mm length thermostat sleeves 73mm thermostat sleeve eccentric, clinging connection male faston 6.3mm immersion heater flange connection		





GEV No.	420202	Ref. No.	RC2034
description	heating element 18000W 240V heating circuits 6 L 229mm W 78mm H 83mm tube ø 8.4mm hole distance 61mm hole ø 7mm connection male faston 6.3mm immersion heater flange connection		





			
1			
GEV No.	420199	Ref. No.	RC2032
description	heating element 18000W 240V heating circuits 6 L 235mm W 78mm H 83mm tube ø 8.4mm hole distance 61mm hole ø 7mm connection male faston 6.3mm immersion heater flange connection		

			
1			
GEV No.	420201	Ref. No.	RC2033
description	heating element 9000W 240V heating circuits 6 L 135mm W 78mm H 83.5mm tube ø 8.4mm hole distance 61mm hole ø 7mm connection male faston 6.3mm immersion heater flange connection		

			
1			
GEV No.	418924	Ref. No.	RC231
description	heating element 8000W 230V heating circuits 3 L 305mm W 37mm H 36mm thermostat sleeve eccentric, non clinging tube ø 8mm hole distance 45mm hole ø 10mm connection length 30mm connection M4 immersion heater flange width 64mm flange length 64mm		





			
1			
GEV No.	420188	Ref. No.	RC3027
description	heating element 3000W 230V heating circuits 1 L 350mm W 300mm connection M4 tube ø 10mm immersion heater for bain marie H 100mm connection distance 25mm		

			
1			
GEV No.	416502	Ref. No.	RC231 RC802
description	heating element 8000W 240V heating circuits 3 L 305mm W 40mm Hmm number of thermostat sleeves thermostat sleeves ømm length thermostat sleevesmm tube ø 6.3mm hole distance 44.9mm hole ø 10mm connection length 23mm connection male faston 6.3mm 4 hole flange immersion heater flange width 63.5mm flange length 63.5mm ø 40mm		
accessories for	416502		
	GEV No.	505180	Ref. No. JOIN261
	O-ring EPDM thickness 3.53mm ID ø 47.22mm Qty 1 pcs		

			
1			
GEV No.	418446	Ref. No.	RC3008
description	heating element 900W 230V heating circuits 1 L 420mm W 45mm thread M12x1 mounting distance 36mm tube ø 8.5mm 2 hole fixing immersion heater		





			
1			
GEV No.	420268	Ref. No.	RC2028
description	heating element 9000W 240V heating circuits 6 L 135mm W 75mm H 83.5mm tube ø 8.5mm hole distance 61mm hole ø 7mm connection male faston 6.3mm immersion heater flange connection		
accessories for	420268		
	GEV No.	511952	Ref. No. JOIN124
	gasket silicone L 109mm W 124mm thickness 3mm		



heating elements for convection

			
1			
GEV No.	418916	Ref. No.	RC018 RC048 RC17
description	heating element 12000W 240V heating circuits 3 ID ø 390mm ED ø 410mm L 410mm H 100mm H1 25mm H2 75mm thread M12x1 6 hole fixing connection male faston 6.3mm tube ø 8.5mm convection heating element		
accessories for	418916		
	GEV No.	101566	Ref. No. —
	nut thread M12x1 H 10mm WS 19 SS Qty 1 pcs		
	GEV No.	506046	Ref. No. —
	flat gasket FIBER ED ø 19.5mm ID ø 13mm thickness 2mm Qty 1 pcs		
	GEV No.	528622	Ref. No. —
	spring ø 15.3mm L 25mm wire gauge ø 1.25mm for water filling		







			
1			
GEV No.	418927	Ref. No.	RC081
description	heating element 12000W 240V heating circuits 3 ID ø 440mm ED ø 458mm L 472mm H 80mm L1 15mm H1 8mm H2 72mm thread M12x1 6 hole fixing connection male faston 6.3mm tube ø 6.3mm convection oven convection heating element		



			
1			
GEV No.	418929	Ref. No.	RC023
description	heating element 6000W 240V heating circuits 3 ID ø 395mm ED ø 415mm L 415mm H 100mm H1 15mm H2 85mm thread M12x1 6 hole fixing connection male faston 6.3mm tube ø 8.5mm convection oven convection heating element		
accessories for	418929		
	GEV No.	101566	Ref. No. —
	nut thread M12x1 H 10mm WS 19 SS Qty 1 pcs		
	GEV No.	506046	Ref. No. —
	flat gasket FIBER ED ø 19.5mm ID ø 13mm thickness 2mm Qty 1 pcs		
	GEV No.	528662	Ref. No. —
	flat gasket copper ED ø 16mm ID ø 12mm thickness 1.5mm		

			
1			
GEV No.	418930	Ref. No.	RC022
description	heating element 6000W 240V heating circuits 3 ID ø 430mm ED ø 450mm L 470mm H 115mm H1 43mm H2 72mm thread M12x1 6 hole fixing connection male faston 6.3mm tube ø 8.5mm convection oven convection heating element		
accessories for	418930		
	GEV No.	101566	Ref. No. —
	nut thread M12x1 H 10mm WS 19 SS Qty 1 pcs		
	GEV No.	506046	Ref. No. —
	flat gasket FIBER ED ø 19.5mm ID ø 13mm thickness 2mm Qty 1 pcs		

accessories for	418930		
	GEV No.	528662	Ref. No. —
	flat gasket copper ED ø 16mm ID ø 12mm thickness 1.5mm		

			
1			
GEV No.	418926	Ref. No.	RC019
description	heating element 8000W 240V heating circuits 3 ID ø 301mm ED ø 317mm L 328mm H 95mm L1 11mm H1 12mm H2 83mm thread M12x1 6 hole fixing connection male faston 6.3mm tube ø 8.5mm convection oven convection heating element		

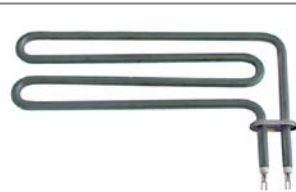
			
1			
GEV No.	418928	Ref. No.	RC017 RC18
description	heating element 9000W 240V heating circuits 3 ID ø 458mm ED ø 475mm L 475mm H 114mm H1 31mm H2 73mm thread M12x1 6 hole fixing connection male faston 6.3mm tube ø 8.5mm convection oven convection heating element		
accessories for	418928		
	GEV No.	101566	Ref. No. —
	nut thread M12x1 H 10mm WS 19 SS Qty 1 pcs		
	GEV No.	506046	Ref. No. —
	flat gasket FIBER ED ø 19.5mm ID ø 13mm thickness 2mm Qty 1 pcs		
	GEV No.	528662	Ref. No. —
	flat gasket copper ED ø 16mm ID ø 12mm thickness 1.5mm		

			
1			
GEV No.	418925	Ref. No.	RC611
description	heating element 1500W 230V heating circuits 1 L 293mm W 106mm L1 32mm L2 261mm W2 83mm flange length 50mm flange width 26mm connection length 63mm connection male faston 6.3mm tube ø 8.5mm hole ø 6.2mm W1 23mm convection heating element convection oven INCOLOY windings 2		
accessories for	418925		
	GEV No.	520588	Ref. No. JOIN071
	gasket L 46mm W 22mm hole distance 24.5mm silicone for heating element		

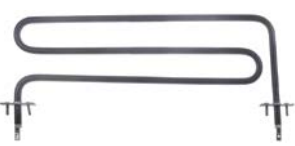

			
1			
GEV No.	416500	Ref. No.	IR00612Y RC601
description	heating element 2000W 230V heating circuits 1 L 295mm W 110mm L1 35mm L2 260mm W2 88mm flange length 50mm flange width 26mm connection length 60mm connection male faston 6.3mm tube ø 8.5mm hole ø 6.2mm W1 15mm compression flange dry heating element		

			
1			
GEV No.	418933	Ref. No.	RC114 RC154
description	heating element 2000W 240V heating circuits 1 L 390mm W 134mm W2 100mm flange length 50mm flange width 20mm connection length 50mm connection M4 tube ø 10mm thread M4 W1 34mm rectangular flange convection heating element convection oven		

			
1			
GEV No.	418917	Ref. No.	RC111 RC151
description	heating element 3000W 240V heating circuits 3 L 570mm W 140mm W2 110mm flange length 110mm flange width 20mm hole distance 40mm connection length 55mm connection M4 tube ø 10mm thread M4 W1 30mm rectangular flange convection heating element convection oven		

			
1			
GEV No.	418931	Ref. No.	RC126
description	heating element 4000W 230V heating circuits 1 L 1130mm W 80mm connection M4 tube ø 10mm thread M14x1.25 2 hole fixing convection heating element convection oven mounting distance 70mm		

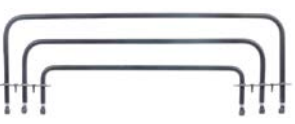
			
1			
GEV No.	418918	Ref. No.	RC110 RC511
description	heating element 4000W 240V heating circuits 3 L 570mm W 140mm W2 110mm flange length 110mm flange width 20mm hole distance 40mm connection length 55mm connection M4 tube ø 10mm thread M4 W1 30mm rectangular flange convection heating element convection oven		

accessories

sealing washers

O-rings

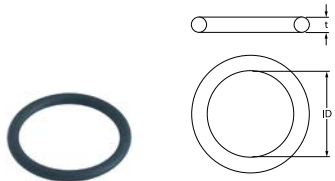
			
1			
GEV No.	505092	Ref. No.	JOIN057
description	O-ring EPDM thickness 5.34mm ID ø 43.82mm Qty 1 pcs		

flange gaskets

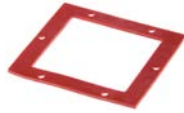
			
1			
GEV No.	511952	Ref. No.	JOIN124
description	gasket silicone L 109mm W 124mm thickness 3mm		

			
1			
GEV No.	511688	Ref. No.	JOIN2033
description	gasket silicone L 115mm W 114mm thickness 4mm		

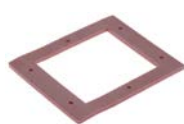
			
1			
GEV No.	511687	Ref. No.	JOIN2029
description	gasket silicone L 138mm W 107mm thickness 4mm		

			
1			
GEV No.	520588	Ref. No.	JOIN071
description	gasket L 46mm W 22mm hole distance 24.5mm silicone for heating element		

			
1			
GEV No.	514493	Ref. No.	PLAQ3019+PLAQ3020+PLAQ3021
description	buffer suitable for heating element hole ø 11mm ø 315mm		



thermostats

control and safety thermostats

EGO

control thermostats

55.10/19_series



GEV No.	375468	Ref. No.	THER3014
description	thermostat t.max. 180°C temperature range 80-180°C 1-pole 1NO 16A probe ø 6mm probe L 135mm capillary pipe 900mm capillary pipe isolatedmm gland nut M9x1 shaft ø 6x4.6mm shaft L 23mm shaft position upper rotation 270°		



GEV No.	375002	Ref. No.	THER001
description	thermostat t.max. 320°C temperature range 55-320°C 1-pole 1NO 16A probe ø 3.1mm probe L 226mm capillary pipe 870mm capillary pipe isolated 850mm gland nut shaft L 23mm shaft position upper rotation 270°		

55.13_series



GEV No.	375154	Ref. No.	THER019
description	thermostat t.max. 250°C temperature range 50-250°C 1-pole 1NO 16A probe ø 3.1mm probe L 201mm capillary pipe 2970mm capillary pipe isolatedmm gland nut shaft L 23mm shaft position upper rotation 270° probe material SS		

55.34_series

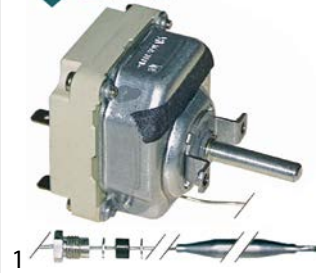

GEV No.	375143	Ref. No.	THER3012
description	thermostat t.max. 110°C temperature range 32-110°C 3-pole 3NO 16A probe ø 6mm probe L 138mm capillary pipe 1480mm capillary pipe isolated 1100mm gland nut M9x1 shaft ø 6x4.6mm shaft L 23mm shaft position upper rotation 270°		



GEV No.	375417	Ref. No.	THER3015
description	thermostat t.max. 200°C temperature range 65-200°C 3-pole 3NO 16A probe ø 6mm probe L 79mm capillary pipe 840mm capillary pipe isolatedmm gland nut M9x1 shaft ø 6x4.6mm shaft L 23mm rotation 270°		



GEV No.	376051	Ref. No.	THER102
description	thermostat t.max. 200°C temperature range 70-145-200°C 3-pole 3NC probe ø 3.1mm probe L 263mm capillary pipe 880mm capillary pipe isolated 400mm		



GEV No.	390800	Ref. No.	THER017
description	thermostat t.max. 270°C temperature range 0-270°C 3-pole 3NOA probe ø 6mm probe L 75mm capillary pipe 2400mm capillary pipe isolatedmm gland nut shaft ø 6x4.6mm shaft L 23mm shaft position upper rotation 270° probe material SS		

electric components



E-G-O



GEV No.	375038	Ref. No.	THER007
description	thermostat t.max. 300°C temperature range 50-300°C 3-pole 3NO 16A probe ø 6mm probe L 79mm capillary pipe 1740mm capillary pipe isolated 800mm gland nut shaft ø 6x4.6mm shaft L 23mm shaft position upper rotation 270°		
accessories for	375038		
	GEV No.	110123	Ref. No. —
	knob thermostat t.max. 300°C ø 50mm shaft ø 6x4.6mm shaft flat upper black temperature range 50-300°C rotation 270°		

safety thermostats
55.13_ series

E-G-O

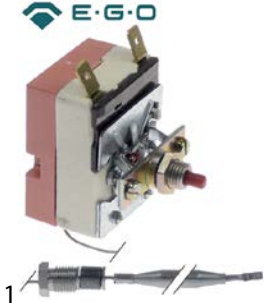

GEV No.	390801	Ref. No.	THER013
description	thermostat switch-off temp. 140°C 1-pole 16A probe ø 6mm probe L 78mm capillary pipe 1500mm capillary pipe isolatedmm gland nut probe connection male faston 6.3mm		

IMIT / TEMPOMATIC / ARTHERMO
control thermostats



GEV No.	390186	Ref. No.	REGU010
description	thermostat t.max. 52°C temperature range fixed 52°C 1-pole 1CO 16A probe ø 6.5mm probe L 95mm capillary pipe 1000mm capillary pipe isolated 1000mm gland nut shaft Lmm contacts 1CO		

CAEM
safety thermostats



GEV No.	375996	Ref. No.	THER3004
description	safety thermostat switch-off temp. 225°C 1-pole 1NC 16A probe ø 5mm probe L 80mm capillary pipe 900mm capillary pipe isolated 410mm gland nut M10 probe SS 250V		



GEV No.	390877	Ref. No.	THER3004
description	safety thermostat switch-off temp. 225°C 1-pole NC 16A probe ø 5mm probe L 80mm capillary pipe 900mm capillary pipe isolated 400mm gland nut M10x1 probe SS connection male faston 6.3mm		

COTHERM

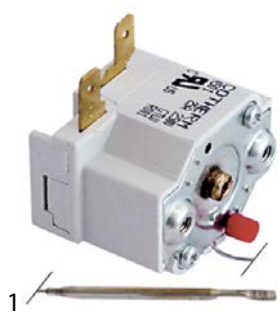

GEV No.	390440	Ref. No.	THER014
description	safety thermostat t.max. 220°C temperature range°C 1-pole 1NC 25A probe ø 3mm probe L 130mm capillary pipe 1720mm capillary pipe isolatedmm gland nut switch-off temp. 220°C probe SS		

switches and momentary switches
rocker/momentary rocker switches

30x22mm



GEV No.	301004	Ref. No.	INT006
description	rocker switch mounting measurements 30x22mm black 2CO 250V 16A connection male faston 6.3mm ambient temperature max. 125/55°C protection IP40		
accessories for	301004		
	GEV No.	301036	Ref. No. —
	protective cover internal size 30x22mm for rocker switch mounting measurementsmm		



blank



1

GEV No.	301165	Ref. No.	INT006
description	rocker switch mounting measurements 30x22mm black 2CO 250V 16A connection male faston 6.3mm ambient temperature max. 125/55°C protection IP65 with cover cap		
accessories for	301165		
	GEV No.	301036	Ref. No. —
	protective cover internal size 30x22mm for rocker switch mounting measurementsmm		

with symbol



1

GEV No.	301228	Ref. No.	INT006
description	rocker switch mounting measurements 30x22mm black 2CO 250V 16A I-II connection male faston 6.3mm ambient temperature max. 125/55°C protection IP65 with cover cap		
accessories for	301228		
	GEV No.	301036	Ref. No. —
	protective cover internal size 30x22mm for rocker switch mounting measurementsmm		

push/momentary push switches

ø12mm



1

GEV No.	347567	Ref. No.	INT003
description	momentary push switch mounting ø 12mm white 1NO 250V 4A connection male faston 6.3mm ambient temperature max. 85°C protection IP40		

microswitches

roller-lever actuated

non-standard



1

GEV No.	345902	Ref. No.	INT103
description	microswitch with handle with a switch 250V 16A connection male faston ambient temperature max. 85°C		

pin-plunger actuated

M12



1

GEV No.	345350	Ref. No.	INT008
description	microswitch with plunger mounting distance 22mm thread M12x0.75 thread L 16mm 250V 16A 1CO connection male faston 6.3mm stroke 4mm ambient temperature max. 125°C type EF83161.3 actuating force: 66g		
accessories for	345350		
	GEV No.	345351	Ref. No. —
	nut thread M12x0.75 H 1.6mm WS 14 chrome-plated brass Qty 1 pcs		

cam switches

4 operating positions



1

GEV No.	300077	Ref. No.	COMU004
description	cam switch 4 operating positions 5NO sequence 0-1-2-3 16A shaft ø 6x4.6mm shaft L 23mm connection male faston 6.3mm plastic		

magnetic switches

M12x1

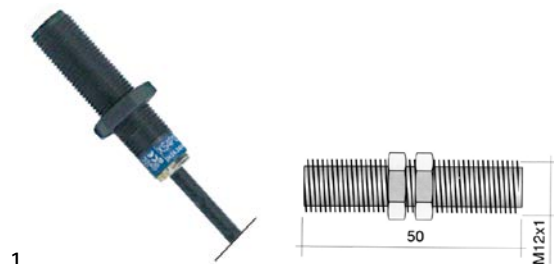

1

GEV No.	345900	Ref. No.	INT005
description	magnetic switch thread M12x1 1NO 24-240V AC/DCV 0.2A P max. 5-50W connection cable cable length 2000mm		



control equipment

SCHNEIDER ELECTRIC

rotary switches



1

GEV No.	347951	Ref. No.	INT037
description	rotary selector mounting measurements ø22mm green sequence 0-1 latching illuminated		

TELEMECANIQUE (EFA)

XB2 series



1

GEV No.	345905	Ref. No.	INT201
description	contact block 1NO		

signal element



1

GEV No.	345397	Ref. No.	VOY103
description	signal element mounting measurements ø22mm red		



1

GEV No.	359770	Ref. No.	VOY102
description	signal element mounting measurements ø22mm yellow		

rotary switches



1

GEV No.	345222	Ref. No.	INT202
description	rotary selector mounting measurements ø22mm black latching sequence 0-1		



1

GEV No.	345223	Ref. No.	INT205
description	rotary selector mounting measurements ø22mm black latching sequence 1-0-2		

ZB2 series

switch blocks



1

GEV No.	347566	Ref. No.	INT036
description	contact block 2NO illuminated		

ZB4 series

rotary switches



1

GEV No.	347951	Ref. No.	INT037
description	rotary selector mounting measurements ø22mm green sequence 0-1 latching illuminated		

miscellaneous



1

GEV No.	345904	Ref. No.	VOY101
description	indicator socket socket Ba9s		



1

GEV No.	345903	Ref. No.	INT204
description	push button black		



lamps

indicator lights

indicator lights 2-piece (lens and indicator lamp)

indicator light lenses

ø12mm (type SDY-3)



GEV No.	359261	Ref. No.	VOT060 VOY060
description	indicator light housings mounting measurements ø12mm red round Qty 1 pcs		

indicator lights 3-piece (housing, lens and bulb)

lamps

light bulbs



GEV No.	359772	Ref. No.	VOY202
description	light bulb		

indicator lights (complete)

ø13mm

with plug-in socket



GEV No.	359045	Ref. No.	VOY062
description	indicator light ø 13mm clear 230V connection male faston 6.3mm temp.-resist. 120°C Qty 1 pcs		



GEV No.	359141	Ref. No.	VOY060
description	indicator light ø 13mm red 230V connection male faston 6.3mm temp.-resist. 120°C Qty 1 pcs		

screw-on/push-on fit

light bulbs

for indicator lights



GEV No.	359772	Ref. No.	VOY202
description	light bulb		

halogen lamp

for socket G4 / G6.35 / G9



GEV No.	357193	Ref. No.	LAMP050
description	halogen lamp socket G4 12V 20W temp.-resist. 300°C OSRAM HALOSTAR OVEN		

fluorescent lamps

fluorescent lamps

G23



GEV No.	359933	Ref. No.	LAMP030
description	fluorescent lamp socket G23 L 237mm 11W 230V		

accessories

covers



GEV No.	551118	Ref. No.	JOIN012
description	protection cap for fluorescent lamps L 33mm W 18mm H 29mm		



oven lamps

producer-specific oven lamps

BOURGOIS



1			
GEV No.	511690	Ref. No.	JOIN075 JOIN109
description	gasket L 78mm W 42mm silicone hole distance 66.5mm thickness 3mm for lamp		



1			
GEV No.	360530	Ref. No.	HUBL009
description	lamp glass L 47.4mm W 32.8mm glas thickness 3.2mm		



1			
GEV No.	359580	Ref. No.	LAMP011 Lamp012
description	lamp socket for halogen lamp		

lamps

halogen lamps

for socket G4 / G6.35 / G9



1			
GEV No.	357193	Ref. No.	LAMP050
description	halogen lamp socket G4 12V 20W temp.-resist. 300°C OSRAM HALOSTAR OVEN		

sockets

G4 / G5,3 / G6,35



1			
GEV No.	360529	Ref. No.	LAMP012
description	lamp socket socket G4 mounting distance 12mm for halogen lamp cord length 120mm		

timers

programme timers

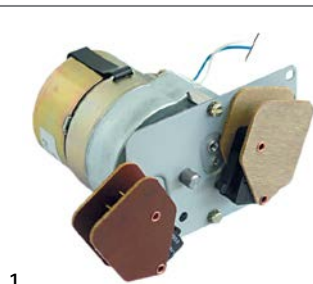

1			
GEV No.	360251	Ref. No.	05224C MOT010
description	gear motor CROUZET chambers 1 operation time 230V 50Hz shaft ømm shaft Lmm H 78mm L 116mm W 55mm type 88256462 shaft ø 5/6mm		

mechanical timers



1			
GEV No.	350168	Ref. No.	MIN300
description	timer C53 2-pole operation time 120min impulse mechanical 1NO/1NC at 250V 16A permanent position no shaft ø4.6mm shaft L 23mm mounting distance 28mm connection lateral		



1			
GEV No.	350214	Ref. No.	MIN014
description	timer M2 2-pole operation time 120min impulse mechanical 1NO/1NC at 250V 16A permanent position no shaft ø4.6mm shaft 6x4.6mm shaft L 23mm mounting distance 28mm connection lateral		

alarm devices

buzzers



1			
GEV No.	350050	Ref. No.	BRUI001
description	buzzer 230VAC connection male faston 6.3mm screw mounting thread M4 60dB		



contactors

ISKRA (FANAL)

power contactors



1			
GEV No.	380204	Ref. No.	REL610
description	power contactor resistive load 25A 230VAC (AC3/400V) 9A/4kW main contacts 3NO auxiliary contacts 1NO connection screw connection type Fanal DSL9 10 type ISKRA KNL9 10		

TELEMECANIQUE (Schneider Electric)

power contactors



1			
GEV No.	380479	Ref. No.	REL1607
description	power contactor resistive load 25A 230VAC (AC3/400V) 9A/4kW main contacts 3NO auxiliary contacts 1NO/1NC connection screw connection type LC1D09P7		



1			
GEV No.	380976	Ref. No.	REL1600
description	power contactor resistive load 32A 230VAC (AC3/400V) 18A/7.5kW main contacts 3NO auxiliary contacts 1NO/1NC connection screw connection		

1			
GEV No.	380603	Ref. No.	REL611
description	power contactor resistive load 40A 230VAC (AC3/400V) 25A/11kW main contacts 4NO auxiliary contacts connection screw connection type LC1D25004		

1			
GEV No.	380982	Ref. No.	REL1603
description	power contactor resistive load 80A 230VAC (AC3/400V) 50A/22kW main contacts 3NO auxiliary contacts 1NO/1NC connection screw connection type LC1D50P7		

auxiliary contactors			
1			
GEV No.	381139	Ref. No.	REL622
description	auxiliary contactor 230VAC AC1 10A type CA2KN407M7 connection male faston 2.8mm/6.3mm contacts 4NO		

auxiliary contacts			
1			
GEV No.	381140	Ref. No.	REL464
description	auxiliary contact contacts 1NO/1NC AC15 6A connection screw type GVAN11		



miscellaneous

installation contactors

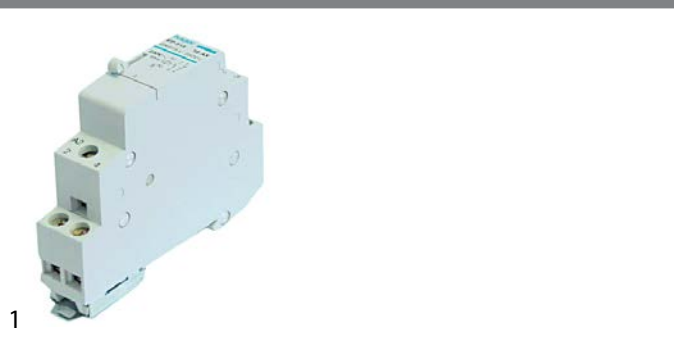

1

GEV No.	380601	Ref. No.	REL153
description	contactor		

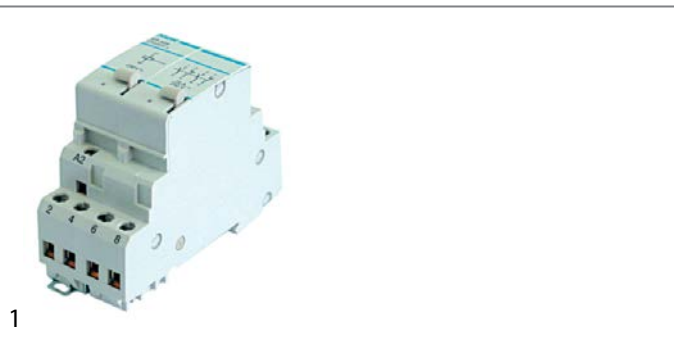

1

GEV No.	380604	Ref. No.	REL008
description	contactor		

accessories



1

GEV No.	380600	Ref. No.	REL454
description	auxiliary contact		

solid state relays

CROUZET

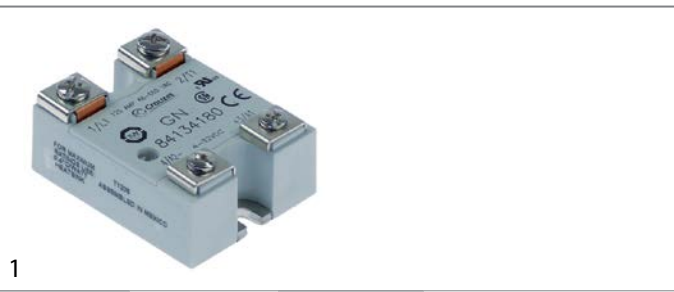

1

GEV No.	403090	Ref. No.	REL232
description	solid state relay CROUZET 1 phase 125A 48-660V 4-32VDC L 57mm W 44mm screw type 84134180		

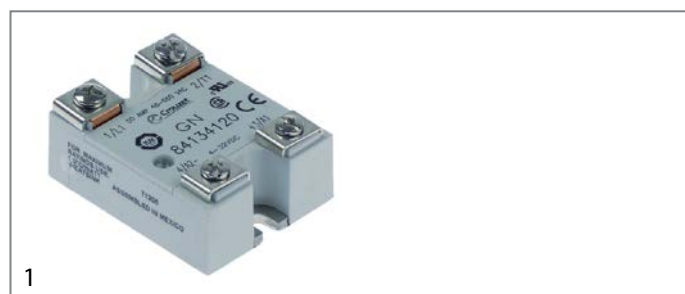

1

GEV No.	403089	Ref. No.	REL231
description	solid state relay CROUZET 1 phase 50A 48-660V 4-32VDC L 57mm W 44mm screw type 84134120		

relays

level relays



1

GEV No.	400809	Ref. No.	NIV002
description	level relay 12V voltage DC type NIV 002		

time relays

time relays



1

GEV No.	360250	Ref. No.	MIN006
description	time relay OMRON H3CR-F8 time range 1.2s-30h 100-240VAC 2x5A mounting measurements 45x45mm 2CO connection plug-in connection round 8-pole		
accessories for	360250		

	GEV No.	380638	Ref. No.	—
	relay socket 8-pole dimensions 51x41x23mm 250V 10A FINDER manuf. no. 90.26			

transformers

toroidal core transformers



GEV No.	401835	Ref. No.	TRAN005
description	transformer primary 0/200/230/380/400/420/440VAC secondary 18VDC 160VA 50/60Hz toroid		

encapsulated transformers

with screw connection



GEV No.	400800	Ref. No.	TRAN601
description	transformer		

electronic controllers

LOREME

analogue



GEV No.	379744	Ref. No.	REGU050
description	electronic controller LOREME type Dsl 94 mounting measurements 66x32mm 230V voltage AC TC/J 0-250°C display without display relay outputs 2 front measurements 70x34mm built-in depth 95mm		



GEV No.	379745	Ref. No.	KITREGU012 REGU008 REGU011
description	electronic controller kit LOREME type Dsl 94 mounting measurements 66x32mm 230V voltage AC TC/J 0-250°C display without display relay outputs 2 front measurements 70x34mm built-in depth 95mm cable length 2530mm probe L 20mm probe ø 4mm with probe and fastening material		

spare parts for 379745

GEV No.	379744	Ref. No.	REGU050
description	electronic controller LOREME type Dsl 94 mounting measurements 66x32mm 230V voltage AC TC/J 0-250°C display without display relay outputs 2 front measurements 70x34mm built-in depth 95mm		

probes

producer-specific probes

probes



GEV No.	400803	Ref. No.	REGU104
description	temperature probe thermocouple J (Fe-CuNi) cable glass fibre probe -50 up to +750°C cable -50 up to +350°C connection 3-wire thread M8 probe ø5x20mm cable length 2.4m		

core probes



GEV No.	379746	Ref. No.	SAC013
description	core temperature probe thermocouple J cable glass fibre probe -40 up to +250°C cable -50 up to +350°C probe ø4x90mm thread M10x1.5 cable length 1m handle ø 10mm handle length 50mm		

electronics

PCBs



GEV No.	402984	Ref. No.	280901 ELEC2003 ELEC2017
description	control PCB combi-steamer UC0611/1011/2011 L 140mm W 100mm		



GEV No.	402985	Ref. No.	ELEC044
description	control PCB combi-steamer UC0611/1011/2011 L 180mm W 85mm		

1

GEV No.	400802	Ref. No.	NIV010
description	level relay 240V type ATO 600722/A		



1

GEV No.	403088	Ref. No.	ELEC2023
description	net board combi-steamer L 122mm W 56mm for combi-steamer		



1

GEV No.	402983	Ref. No.	ELEC2002
description	PCB combi-steamer UC0611/1011/2011 L 210mm W 50mm		



1

GEV No.	403685	Ref. No.	ELEC2001 ELEC2015
description	PCB L 200mm W 95mm		



1

GEV No.	361851	Ref. No.	ELEC014
description	PCB L 70mm W 20mm		



1

GEV No.	402982	Ref. No.	ELEC2004
description	relay PCB combi-steamer UC0611/1011/2011 cable length 220mm push-in		

keypads

keypad units



1

GEV No.	403122	Ref. No.	20467
description	keypad unit combi-steamer UC0611/1011/2011 buttons 9 L 350mm W 153mm		

solenoid valves

solenoid valves (water)

ROBERTSHAW/INVENSYS

medium temperature: 90°C 90°C 60°C
ambient temperature: 60°C 25°C 60°C
duty cycle: 40% 100% 100%

solenoid valves with reducers

2-fold





1

GEV No.	372001	Ref. No.	06245
description	solenoid valve double straight 230VAC inlet 3/4" outlet 11.5mm duty cycle 100% EATON (INVENSYS) plastic output A 1.2l/min output B 0.25l/min flow regulating valve outlet A dark blue flow regulating valve outlet B transparent/white with non-return valve		



1

GEV No.	370696	Ref. No.	ROB2000	
description	solenoid valve double straight 230VAC inlet 3/4" outlet 11.5mm t.max. 90°C Invensys plastic output A 1.2l/min flow regulating valve outlet A blue with non-return valve			
spare parts for	370696			
	GEV No.	371131	Ref. No.	—
	solenoid coil 230VAC			
	GEV No.	371174	Ref. No.	—
	solenoid coil 230VAC connection coded plug 6W			



with coded terminal

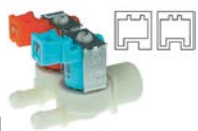

1

GEV No.	370269	Ref. No.	06245
description	solenoid valve double straight 230VAC inlet 3/4" outlet 11.5mm DN10 EATON (INVENSYS)		

various



1

GEV No.	370310	Ref. No.	ROB210
description	solenoid valve 2-fold, with reducer straight		

electrodes



1

GEV No.	402987	Ref. No.	TUY019
description	hose total length 325mm probe Lmm with level sensor connection F6.3 suitable for BOURGEOIS		



1

GEV No.	402986	Ref. No.	TUY018 TUY18
description	hose total length 460mm probe Lmm with level sensor connection F6.3 suitable for BOURGEOIS		



1

GEV No.	400807	Ref. No.	NIV007
description	level electrode 1/2" total length 112mm probe L 88mm insulated probe length uninsulatedmm connection bullet connector		



1

GEV No.	400805	Ref. No.	NIV601
description	level electrode 3/8" probe L 44mm insulated probe length 43mm conical		



1

GEV No.	400804	Ref. No.	NIV602
description	level electrode 3/8" total length 75mm probe L 48mm insulated probe length 47mm conical connection M4		



fans

axial fans

import



1

GEV No.	601080 ¹	Ref. No.	MOT030
description	axial fan L 119mm W 119mm H 38mm 230VAC 50/60Hz 23/20W bearing ball bearing connection male faston 2.8mm metal ADDA fan wheel ø 110mm temp.-resist. 70°C		
accessories for	601080		
	GEV No.	550898	Ref. No. —
	connecting cable cable length 2000mm connection F 2.8 connection distance 7.9mm for axial flow fan		
	GEV No.	692519	Ref. No. —
	guard L 120mm W 120mm plastic		

¹with ball bearings

hot air motors



1

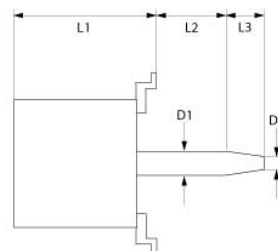

GEV No.	500812	Ref. No.	MOT108
description	fan motor 220-240/380-415V 3 phase 50Hz 0.26kW 1440rpm speeds 1 D1 ø 17mm D2 ø 13.5mm		

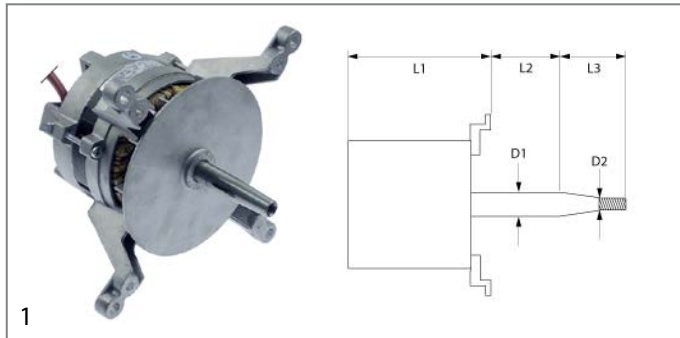

GEV No.	601805	Ref. No.	07426 07877 MOT050 MOT2012
description	fan motor 230V 1 phase 50/60Hz 0.185kW 1400/1680rpm speeds 2 L1 130mm L2 27mm L3 37mm D1 ø 17mm D2 ø 13.5mm 1A suitable capacitor 5µF/450V Cos(fi) 0.93 type 1079GA2350		
accessories for	601805		
	GEV No.	511605	Ref. No. JOIN222
	shaft seal		



GEV No.	601803	Ref. No.	MOT2020
description	fan wheel D1 ø 280mm H1 70mm blades 12 D2 ø 13mm D3 ø 16mm H2 16mm H3 21mm		



GEV No.	601744	Ref. No.	00906D
description	fan wheel D1 ø 350mm H1 108mm blades 12 D2 ø 16.5mm D3 ø 13mm H2 39mm H3 72mm		

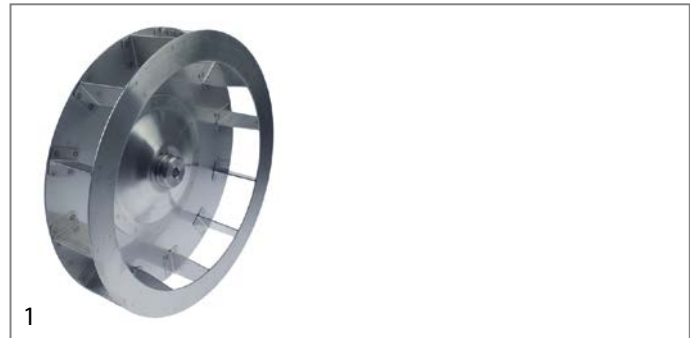

GEV No.	601804	Ref. No.	MOT2019
description	fan wheel D1 ø 350mm H1 70mm blades 12 D2 ø 13mm D3 ø 16mm H2 16mm H3 21mm		

hot air fans

ebm-papst



GEV No.	601808	Ref. No.	MOT2023
description	hot air fan 230/240V 50W L1 69mm L2mm L3mm L4 87mm fan wheel ø 150mm type RRL152/0020A92-3030LH-197 ebm-papst		



GEV No.	601807	Ref. No.	KITSAVMOT026
description	hot air fan kit 230V 50W L1 69mm L4 87mm fan wheel ø 151mm type RRL152/0020A92-3030LH-197 ebm-papst		

GEV No.	500573	Ref. No.	ROB013
description	drain pump 30W 4-piece 230V inlet ø 24/30mm outlet ø 24mm 50Hz HANNING type DPS25-032 1x pump, 3x pump cover		

service kits

GEV No.	500573	Ref. No.	ROB013
description	drain pump 30W 4-piece 230V inlet ø 24/30mm outlet ø 24mm 50Hz HANNING type DPS25-032 1x pump, 3x pump cover		

motors

gear motors

for ovens

GEV No.	500811	Ref. No.	MOT018
description	gear motor AUTOM type ASR/30/FR 230V 50Hz shaft ø 8mm L 150mm W 65mm H 90mm		

booster pumps II

accessories

GEV No.	365017	Ref. No.	MOT203
description	operating capacitor capacity 5µF 450V tolerance 5% 50/60Hz ambient temperature max. -25 to +85°C ø 28mm L 54mm M8 plastic connection male faston 6.3mm 16.10.08 protection		

pumps

drain pumps

HANNING

GEV No.	499127	Ref. No.	ROB008 ROB013
description	drain pump 30W 220-240V inlet ø 30mm outlet ø 24mm 50Hz type DPS25-097 HANNING		

vibration pumps

GEV No.	500219	Ref. No.	POMP001
description	vibration pump type CP.3A.958.1/ST 230V 65W 50Hz inlet ø 6 outlet ø 1/8" IT EATON (INVENSYS) L 123mm		



condensators & interference suppression filters

operating capacitors

plastic



1			
GEV No.	365150	Ref. No.	MOT2008
description	operating capacitor capacity 20µF 425V tolerance 5% 50Hz ambient temperature max. -25 to +85°C ø 40mm L 70mm M8 plastic connection male faston 6.3mm 416.10.25 protection		



1			
GEV No.	365017	Ref. No.	MOT2013
description	operating capacitor capacity 5µF 450V tolerance 5% 50/60Hz ambient temperature max. -25 to +85°C ø 28mm L 54mm M8 plastic connection male faston 6.3mm 16.10.08 protection		

filters

line filters

with housing



1			
GEV No.	365040	Ref. No.	ELEC050
description	line filter type FN610-3/06 110/250V 50/60Hz conductor 2 with E connection male faston 6.3mm L 65mm ømm H 19mm W 35mm flange with thread metal Qty 1 pcs		

fuses

fine fuses



1			
GEV No.	358532	Ref. No.	FUSI003
description	fine fuse size ø5x20mm 2A fast-acting rated 250V Qty 10 pcs		



1			
GEV No.	358607	Ref. No.	Fusi004
description	fine fuse size ø5x20mm 6.3A slow-acting rated 250V Qty 10 pcs		

fine fuse holders



1			
GEV No.	358010	Ref. No.	FUSI613
description	fuse holder suitable fuse ø6.3x32mm 10A rated 250V connection F4.8		

electric accessories

terminals

terminal blocks



1			
GEV No.	550232	Ref. No.	BAR001
description	lustre terminal 12-pole cross section 2.5mm ² max. 32A max 450V temp.-resist. 150°C		

rail-mounted terminals

WIELAND

rail-mounted terminals type 9700A





1			
GEV No.	550374	Ref. No.	BORN101
description	rail-mounted terminal WIELAND type 9700A/10 S35 1.5-16mm ² top-hat rail 35mm blue W 10mm L 49mm		



1			
GEV No.	550375	Ref. No.	BORN102A
description	rail-mounted terminal WIELAND type 9700A/10 SL2 S35 1.5-16mm ² top-hat rail 35mm yellow/green W 10mm L 53mm		



			
1			
GEV No.	550377	Ref. No.	BORN105
description	rail-mounted terminal WIELAND type 9700A/16 S35 2.5-35mm ² top-hat rail 35mm blue W 16mm L 59mm		

			
1			
GEV No.	550378	Ref. No.	BORN108
description	rail-mounted terminal WIELAND type 9700A/16 SL2 S35 2.5-35mm ² top-hat rail 35mm yellow/green W 16mm L 53mm		



accessories			
			
1			
GEV No.	550370	Ref. No.	BORN211
description	terminal block end bracket clampsmm ²		



electronic components

differential pressure transmitters

			
1			
GEV No.	402988	Ref. No.	06762 20924 20946
description	differential pressure transmitter for combi-steamer conversion kit		

miscellaneous



			
1			
GEV No.	400801	Ref. No.	MOT015
description	gear motor SM 230A for combi-steamer suitable for BOURGEOIS 220V 50Hz		
accessories for	400801		
	GEV No.	400808	Ref. No. MOT016
	switch S1, S2 for gear motor suitable for BOURGEOIS		

			
1			
GEV No.	400808	Ref. No.	MOT016
description	switch S1, S2 for gear motor suitable for BOURGEOIS		
accessories for	400808		
	GEV No.	400801	Ref. No. MOT015
	gear motor SM 230A for combi-steamer suitable for BOURGEOIS 220V 50Hz		

gas taps

PEL

22S/O series

			
1			
GEV No.	106384	Ref. No.	ROB3001
description	gas tap PEL type 22S/O gas inlet M20x1.5 (tube ø 12mm) bypass nozzle ø 0mm gas outlet M20x1.5 (tube ø 12/10mm) thermocouple connection M9x1 pilot connection M10x1 shaft ø 10x8mm shaft L 25/17mm shaft flat lower		
spare parts for	106384		
	GEV No.	101058	Ref. No. —
	magnet unit L 39mm D1 ø 15.4mm D2 ø 13.5mm suitable for PEL22/EGA24197 standard		
	GEV No.	101231	Ref. No. —
	thermocouple nut T1: M9x1 T2: M18x1		
	GEV No.	106191	Ref. No. —
	bypass nozzle type PEL22 bore ø 0mm thread M6x0.5		
accessories for	106384		
	GEV No.	101248	Ref. No. —
	olive for pipe ø 12mm Qty 1 pcs suitable for PEL		
	GEV No.	101249	Ref. No. —
	olive for pipe ø 10mm Qty 1 pcs		
	GEV No.	101250	Ref. No. —
	union nut thread M20x1.5 for pipe ø 10mm		
	GEV No.	101251	Ref. No. —
	union nut thread M20x1.5 for pipe ø 12mm		



ignition parts

pilot burners

SIT

100 series

accessories

pilot burner nozzles



GEV No.	100245	Ref. No.	INJ3007
description	pilot burner nozzle LPG code 20 bore \varnothing 0.2mm Qty 1 pcs thread M8x0.75		



GEV No.	100246	Ref. No.	INJ3006
description	pilot burner nozzle natural gas bore \varnothing 0.35mm Qty 1 pcs thread M8x0.75		

ignition electrodes



GEV No.	100707	Ref. No.	ALLU3000
description	ignition electrode D1 \varnothing 7mm D2 \varnothing 9mm connection \varnothing 2.4mm L1 14mm L2 6mm BL1 18mm BL2 3mm BL3 23mm to clip Qty 1 pcs		

Oxipilot 9000 series

pilot burners



GEV No.	106388	Ref. No.	BRUL3002
description	pilot burner type Oxipilot 9000 series 2 flames natural gas nozzle no. 33 nozzle \varnothing 0.33mm gas connection 6mm without ignition electrode bore \varnothing 0.33mm		

accessories for	106388			
	GEV No.	100904	Ref. No.	—
	locking screw M10x1 for pipe \varnothing 4mm Qty 1 pcs			
	GEV No.	100905	Ref. No.	—
	locking screw M10x1 for pipe \varnothing 6mm Qty 1 pcs			
	GEV No.	100907	Ref. No.	—
	screw connection thread M10x1 Qty 1 pcs type SEF 1 \varnothing mm for thermocouple			

accessories for	106388			
	GEV No.	101602	Ref. No.	—
	locking screw thread M10x1 for pipe \varnothing 1/4" Qty 1 pcs			

JUNKERS

CB 505 series

pilot burners



GEV No.	106390	Ref. No.	BRUL3039
description	pilot burner type CB 5051_ natural/liquid gas code 42/64 gas connection 6mm		

producer-specific pilot burners

BOURGOIS



GEV No.	106387	Ref. No.	BRUL3004
description	pilot burner 1 flame gas connection 6mm without nozzle		

accessories for	106387			
	GEV No.	106385	Ref. No.	INJ3008
	pilot burner nozzle LPG code 22 bore \varnothing 0.22mm thread M5x0.75 Qty 1 pcs brass			
	GEV No.	106386	Ref. No.	INJ3000
	pilot burner nozzle natural gas code 40 bore \varnothing 0.4mm thread M5x0.75 Qty 1 pcs brass			



GEV No.	106385	Ref. No.	INJ3008
description	pilot burner nozzle LPG code 22 bore \varnothing 0.22mm thread M5x0.75 Qty 1 pcs brass		



GEV No.	106386	Ref. No.	INJ3000
description	pilot burner nozzle natural gas code 40 bore \varnothing 0.4mm thread M5x0.75 Qty 1 pcs brass		

electrodes



GEV No.	100707	Ref. No.	ALLU3000
description	ignition electrode D1 \varnothing 7mm D2 \varnothing 9mm connection \varnothing 2.4mm L1 14mm L2 6mm BL1 18mm BL2 3mm BL3 23mm to clip Qty 1 pcs		

GEV No.	106928	Ref. No.	ALLU009
description	ignition electrode flange length 22mm flange width 1 16mm D1 \varnothing 7mm L1 4mm BL1 49mm BL2 20mm connection \varnothing 6mm		



GEV No.	100707	Ref. No.	ALLU3000
description	ignition electrode D1 \varnothing 7mm D2 \varnothing 9mm connection \varnothing 2.4mm L1 14mm L2 6mm BL1 18mm BL2 3mm BL3 23mm to clip Qty 1 pcs		

ignition units



GEV No.	106925	Ref. No.	ALLU030
description	ignition unit outputs 1 230VAC dimensions 85x63x38mm mounting distance 60mm inlet F2.8x0.8 outlet \varnothing 4mm type EB14 1P S service kit 90VA 50-60Hz		

thermocouples

plug-in thermocouples

plug-in thermocouples standard

with barrel socket \varnothing 6(6.5)mm

thermocouples SIT

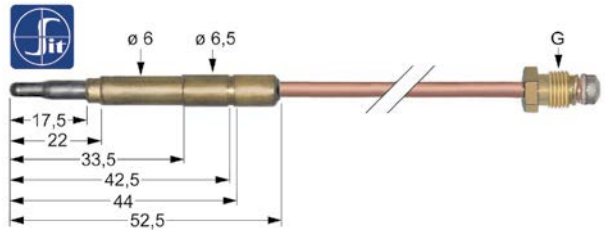

GEV No.	107614	Ref. No.	THER3006
description	thermocouple SIT M9x1 L 1500mm plug connection \varnothing 6.0(6.5)mm		

GEV No.	107606	Ref. No.	THER3008
description	thermocouple SIT M9x1 L 320mm plug connection \varnothing 6.0(6.5)mm		

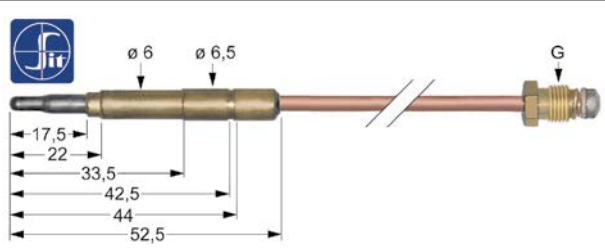

GEV No.	107608	Ref. No.	THER3005
description	thermocouple SIT M9x1 L 500mm plug connection \varnothing 6.0(6.5)mm		

GEV No.	107611	Ref. No.	THER3007
description	thermocouple SIT M9x1 L 850mm plug connection \varnothing 6.0(6.5)mm		

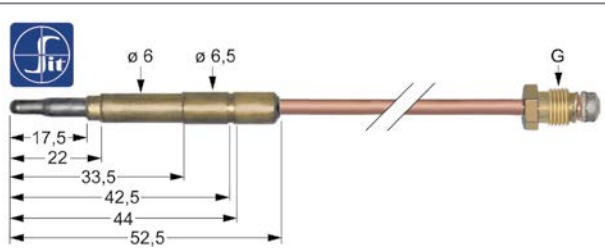

GEV No.	107614	Ref. No.	THER3006
description	thermocouple SIT M9x1 L 1500mm plug connection \varnothing 6.0(6.5)mm		

GEV No.	107606	Ref. No.	THER3008
description	thermocouple SIT M9x1 L 320mm plug connection \varnothing 6.0(6.5)mm		

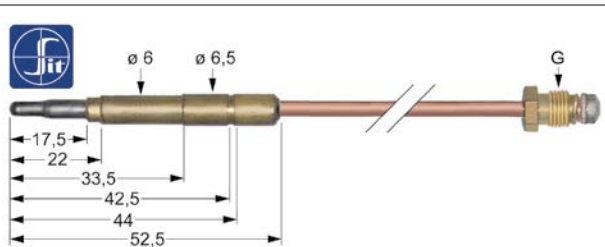

GEV No.	107608	Ref. No.	THER3005
description	thermocouple SIT M9x1 L 500mm plug connection \varnothing 6.0(6.5)mm		

GEV No.	107611	Ref. No.	THER3007
description	thermocouple SIT M9x1 L 850mm plug connection \varnothing 6.0(6.5)mm		



gas burners

hob burners

accessories

pan supports



1

GEV No.	210025	Ref. No.	GRIL3001
description	pan support W 320mm L 320mm		



1

GEV No.	210033	Ref. No.	GRIL3004
description	pan support W 320mm L 320mm		

bar burners

bar burners



1

GEV No.	104469	Ref. No.	BRUL3031
description	bar burner 3 row L 435mm W 250mm ømm H 64mm chargrill		



1

GEV No.	104473	Ref. No.	BRUL3026
description	bar burner 3 row L 485mm W 200mm ømm H 150mm gril		



1

GEV No.	104471	Ref. No.	BRUL3027
description	bar burner 3 row L 580mm W 250mm ømm H 63mm chargrill		



1

GEV No.	104474	Ref. No.	BRUL3024
description	bar burner 4 row L 430mm W 370mm ømm H 190mm gril		



1

GEV No.	104472	Ref. No.	BRUL3023
description	bar burner 4 row L 525mm W 280mm ømm H 124mm griddle		

gas nozzles

main nozzles

gas nozzles 3/8"



1

GEV No.	106535	Ref. No.	INJ3009
description	gas injector thread 3/8" WS 17 bore ø 1.3mm		



1

GEV No.	106537	Ref. No.	INJ3014
description	gas injector thread 3/8" WS 17 bore ø 1.5mm		

pilot burner nozzles

pilot burner nozzles AEM



1

GEV No.	106385	Ref. No.	INJ3008
description	pilot burner nozzle LPG code 22 bore ø 0.22mm thread M5x0.75 Qty 1 pcs brass		

pilot burner nozzles SIT

100 series



1

GEV No.	100245	Ref. No.	INJ3007
description	pilot burner nozzle LPG code 20 bore ø 0.2mm Qty 1 pcs thread M8x0.75		

			
1			
GEV No.	100246	Ref. No.	INJ3006
description	pilot burner nozzle natural gas bore ø 0.35mm Qty 1 pcs thread M8x0.75		

pilot burner nozzles (other)

SOLYMAC/CAPIC

			
1			
GEV No.	106385	Ref. No.	INJ3008
description	pilot burner nozzle LPG code 22 bore ø 0.22mm thread M5x0.75 Qty 1 pcs brass		

			
1			
GEV No.	106386	Ref. No.	INJ3000
description	pilot burner nozzle natural gas code 40 bore ø 0.4mm thread M5x0.75 Qty 1 pcs brass		

for convection ovens/combi-steamers

spare parts and accessories

			
1			
GEV No.	541859	Ref. No.	DECO3016
description	bush ID ø 14.5mm ext. ø 18/22 thickness 5.5mm		

glass panels

			
1			
GEV No.	696423	Ref. No.	03519 03519+EMBA412 HUBL037
description	glass panel L 1370mm W 620mm for combi-steamer with gasket		

			
1			
GEV No.	696425	Ref. No.	03515+EMBA411
description	glass panel L 693mm W 613mm for combi-steamer with gasket		

doors

			
1			
GEV No.	694536	Ref. No.	DECO214
description	door bolt for combi-steamer thread M5 ø 8mm L 46mm		

			
1			
GEV No.	696417	Ref. No.	DECO364
description	locking screw for door thread M5		

auxiliary gas parts

gas ball valves

miscellaneous

			
1			
GEV No.	520586	Ref. No.	ROB3006
description	ball valve IT 1/2" L 55mm with safety handle angled W 28mm H 73mm handle ø 23mm wing handle EN 331		

equipment-specific units

for ice-cube maker

hoses

formed hoses

straight

silicone hoses

			
1			
GEV No.	530063	Ref. No.	TUY1824
description	silicone hose ID ø 18mm ED ø 25mm L 1m t.max. 200°C transparent		



			
1			
GEV No.	696418	Ref. No.	DECO043
description	locking screw for door thread M5		

			
1			
GEV No.	696419	Ref. No.	JOIN655
description	rubber sleeve for door		

			
1			
GEV No.	696421	Ref. No.	DECO414
description	threaded bush for door thread M5 IT ø 9.5mm L 24mm		

			
1			
GEV No.	696422	Ref. No.	DECO384
description	threaded bush for door thread M5 L 48mm		

door mechanics

accessories

			
1			
GEV No.	694537	Ref. No.	CHAR203
description	base plate L 51mm W 22mm for catch plastic mounting distance 30mm thickness 2mm		

miscellaneous

			
1			
GEV No.	511616	Ref. No.	KITCREPI
description	filter kit for drain		

			
1			
GEV No.	696424	Ref. No.	20430
description	injection pipe for combi-steamer L 245mm SS W 215mm ø 8mm		

for dishwashers

washing and rinsing systems

			
1			
GEV No.	511606	Ref. No.	INJ601
description	rinse jet		

knobs

universal knobs

			
1			
GEV No.	110865	Ref. No.	MAN130
description	knob switch zero mark t.max.°C ø 50mm shaft ø 6x4.6mm shaft flat left black		

			
1			
GEV No.	110253	Ref. No.	MAN003
description	knob switch zero mark t.max.°C ø 50mm shaft ø 6x4.6mm shaft flat upper black		

producer-specific knobs

BOURGOIS

			
1			
GEV No.	110865	Ref. No.	MAN130
description	knob switch zero mark t.max.°C ø 50mm shaft ø 6x4.6mm shaft flat left black		

locks

handle latches

universal

inside fixing

locks











GEV No.	694054	Ref. No.	CHAR2006
description	door handle for headed units L 145mm W 40mm H 62mm spring length 33mm inner black		
spare parts for	694054		
	GEV No.	514390	Ref. No. —
	spring for door handle ø 6mm L 54mm W 27.5mm		
	GEV No.	694675	Ref. No. —
	door catch L 88mm W 40mm H 37mm spring length 33mm mounting distance 60mm		
	GEV No.	694734	Ref. No. —
	door handle L 165mm W 40mm H 25mm black		
	GEV No.	694735	Ref. No. —
	cap ø 32mm black		
accessories for	694054		
	GEV No.	691123	Ref. No. —
	duct for door opener		
	GEV No.	694055	Ref. No. —
	door catch L 25mm W 14mm total length 54mm thread M8 thread L 29mm		
	GEV No.	694066	Ref. No. —
	door catch with spigot 2-stage L 28mm W 14mm H 15mm H1 16mm total length 51mm thread M8 thread L 23mm stainless steel		
	GEV No.	694067	Ref. No. CHAR2007
	door catch with spigot 1-stage L 26mm total length 51mm thread M8		

producer-specific

BOURGEOIS



GEV No.	694054	Ref. No.	CHAR2006
description	door handle for headed units L 145mm W 40mm H 62mm spring length 33mm inner black		
spare parts for	694054		
	GEV No.	514390	Ref. No. —
	spring for door handle ø 6mm L 54mm W 27.5mm		
	GEV No.	694675	Ref. No. —
	door catch L 88mm W 40mm H 37mm spring length 33mm mounting distance 60mm		
	GEV No.	694734	Ref. No. —
	door handle L 165mm W 40mm H 25mm black		
	GEV No.	694735	Ref. No. —
	cap ø 32mm black		
accessories for	694054		
	GEV No.	691123	Ref. No. —
	duct for door opener		
	GEV No.	694055	Ref. No. —
	door catch L 25mm W 14mm total length 54mm thread M8 thread L 29mm		
	GEV No.	694066	Ref. No. —
	door catch with spigot 2-stage L 28mm W 14mm H 15mm H1 16mm total length 51mm thread M8 thread L 23mm stainless steel		
	GEV No.	694067	Ref. No. CHAR2007
	door catch with spigot 1-stage L 26mm total length 51mm thread M8		



edgmount latches

push button latches

RAHRBACH

6186 PRESTO series

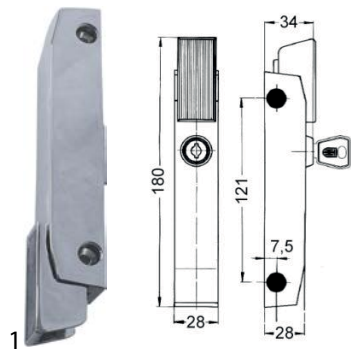



GEV No.	701042	Ref. No.	90000012 MB90000012
description	push button latch L 180mm mounting distance 121mm chrome-plated H 34mm W 28mm type PRESTO no. 6186		

handle latches

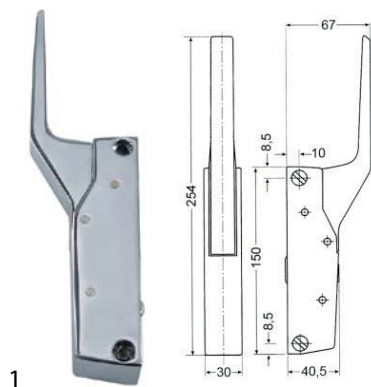
CAFF/FERMOD



GEV No.	700060	Ref. No.	241007313
description	handle latch L 150mm mounting distance 133mm non lockable heated units G 791		
accessories for	700060		
	GEV No.	700061	Ref. No. —
	door catch L 58mm W 20mm H 35mm mounting distance 42mm chrome-plated brass for headed units		
	GEV No.	700062	Ref. No. —
	handle protection heated units		

snap locks

universal



GEV No.	700800	Ref. No.	CHAR150
description	snap lock L 59mm W 11.5mm H 15mm mounting distance 50mm complete with door catch nickel-plated brass thickness 2.7mm		

miscellaneous



GEV No.	511612	Ref. No.	FERM001
description	closing plate Qty 2 pcs		



GEV No.	511613	Ref. No.	FERM003
description	door catch		





GEV No.	511617	Ref. No.	00261B
description	door catch		



GEV No.	511618	Ref. No.	00461A
description	door catch H 24.5mm L 31mm W 21mm mounting distance 21mm roller ø 14mm		



GEV No.	696420	Ref. No.	02744A 03811C
description	door catch with microswitch L 80mm W 46mm mounting distance 60mm		
spare parts for	696420		
	GEV No.	347567	Ref. No. INT003
	momentary push switch mounting ø 12mm white 1NO 250V 4A connection male faston 6.3mm ambient temperature max. 85°C protection IP40		

			
1			
GEV No.	511619	Ref. No.	02668B
description	door catch with roller H 23mm adjustable L 90mm W 21mm mounting distance 52/76mm rollerø 14mm		

hinges

edgmount hinges

CAFF/FERMOD

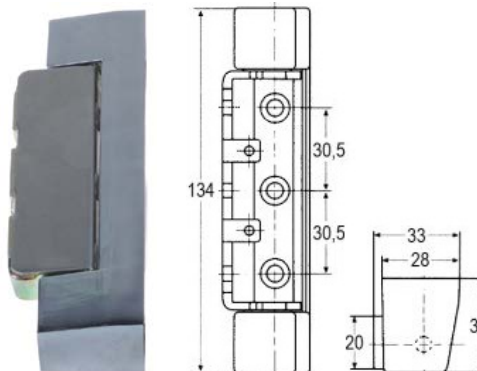
			
1			
GEV No.	690340	Ref. No.	MB90000009
description	edgmount hinge L 134mm W 33mm mounting distance 61mm hinging left/right without lift zamak chrome-plated refrigeration units series G 525		

oven hinges

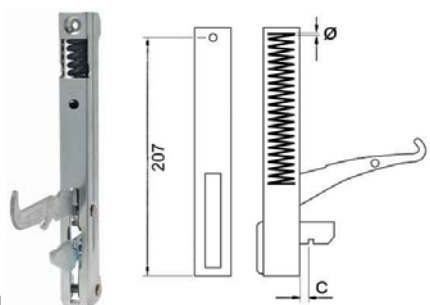
			
1			
GEV No.	690037	Ref. No.	CHAR3008
description	oven hinge mounting distance 205mm mounting distance 2mm lug mountingmm lever length 119mm groove distance 13mm spring thickness 4.3mm mounting ear position spring length 103mm L 214mm		

door bearing

			
1			
GEV No.	511603	Ref. No.	COUS002
description	bush H 7.5mm ID ø 8.2mm with layer		

			
1			
GEV No.	690835	Ref. No.	CHAR202
description	hinge bearing without bolt		

miscellaneous

			
1			
GEV No.	511602	Ref. No.	CHAR201
description	hinge		

accessories

bushes

			
1			
GEV No.	694336	Ref. No.	DECO 071
description	bush ID ø 8mm ED ø 12mm L 15mm		

shelves and shelf rails

chargrill grids

			
1			
GEV No.	210038	Ref. No.	PLAQ3001
description	chargrill grid L 333mm W 317mm H 50mm cast iron		



gaskets

gaskets for heated units

window seals

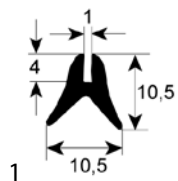

GEV No.	901512	Ref. No.	JOIN063
description	window gasket profile 1615 L 1350mm suitable for BOURGEOIS Qty 1		

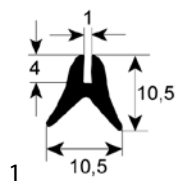

GEV No.	511665	Ref. No.	JOIN097
description	window gasket profile 1615 L 1630mm Qty 1		

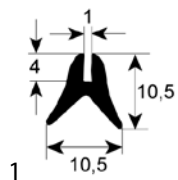

GEV No.	901423	Ref. No.	JOIN060
description	window gasket profile 1615 L 1830mm suitable for BOURGEOIS Qty 1		

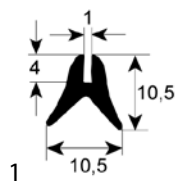

GEV No.	511610	Ref. No.	JOIN066
description	window gasket profile 1615 L 1950mm Qty 1		

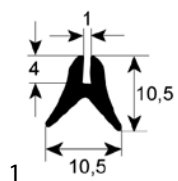

GEV No.	511666	Ref. No.	JOIN098
description	window gasket profile 1615 L 2110mm Qty 1		

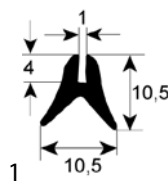

GEV No.	901513	Ref. No.	JOIN063 N/A
description	window gasket profile 1615 suitable for BOURGEOIS Qty supplied by meter		

door seals

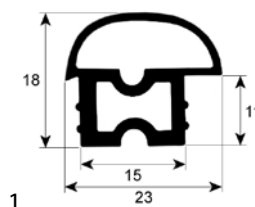

GEV No.	901411	Ref. No.	10683A MB10683A
description	door seal profile 2035 Qty supplied by meter		

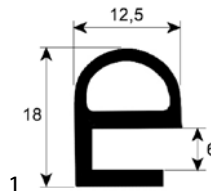

GEV No.	901516	Ref. No.	JOIN082 KITJOIN082
description	door seal profile 2225 perimeter 2030mm suitable for BOURGEOIS		

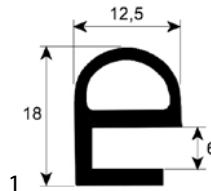

GEV No.	901409	Ref. No.	JOIN018
description	door seal profile 2225 perimeter 2530mm suitable for BOURGEOIS		

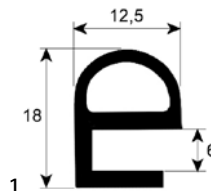

GEV No.	901427	Ref. No.	KITJOIN018
description	door seal profile 2225 perimeter 2530mm suitable for BOURGEOIS		

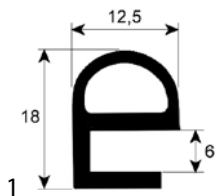

GEV No.	901410	Ref. No.	JOIN019 KITJOIN019
description	door seal profile 2225 perimeter 3900mm suitable for BOURGEOIS Qty 1		

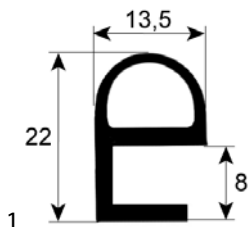

GEV No.	901425	Ref. No.	JOIN1003
description	door seal profile 2226 L 3500mm Qty 1 W 700mm		

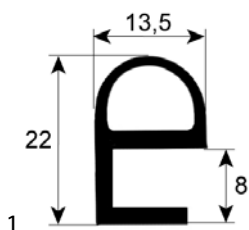

GEV No.	901426	Ref. No.	JOIN155 JOIN180
description	door seal profile 2226 perimeter 2250mm Qty 1		

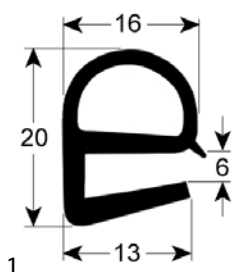

GEV No.	901514	Ref. No.	JOIN1015
description	door seal profile 2227 perimeter 2650mm suitable for BOURGEOIS kit		

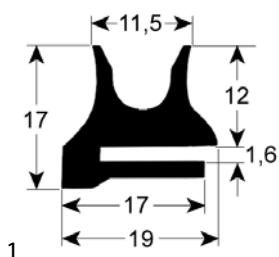

GEV No.	901507 ¹	Ref. No.	JOIN031 JOIN032
description	door seal profile 2290 W 641mm L 782mm external size Qty 1 suitable for BOURGEOIS 3-sided (short side open)		

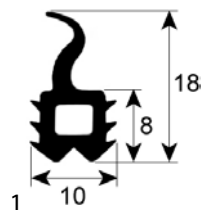

GEV No.	901424	Ref. No.	JOIN021 JOIN022 PROF777
description	door seal profile 2711 L 2600mm Qty 1		

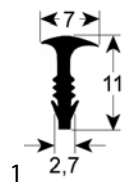

GEV No.	901655	Ref. No.	JOIN015
description	door seal profile 2980 L 2230mm		

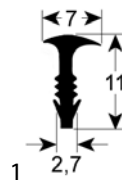

GEV No.	518126	Ref. No.	JOIN016 PROF1612
description	door seal profile 2980 L 2820mm		

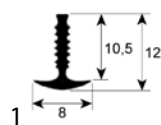

GEV No.	511620	Ref. No.	JOIN029
description	door seal profile 2985 L 4350mm Qty 1		

door seals with fixing hook



GEV No.	900741	Ref. No.	JOIN1010
description	door seal L 650mm W 575mm with 4 mounting clips plug size		

gaskets for control panels

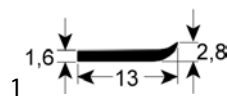

GEV No.	901510	Ref. No.	JOIN086
description	gasket for control panel W 13mm L 1500mm suitable for BOURGEOIS		

¹3-sided (short side open)



GEV No.	901508	Ref. No.	JOIN087
description	gasket for control panel W 13mm L 2050mm suitable for BOURGEOIS		

GEV No.	901509	Ref. No.	JOIN088
description	gasket for control panel W 13mm L 3500mm suitable for BOURGEOIS		

GEV No.	901511	Ref. No.	N/A
description	gasket for control panel W 13mm suitable for BOURGEOIS Qty supplied by meter		

GEV No.	691033	Ref. No.	JOIN057
description	O-ring EPDM thickness 5.34mm ID ø 62.87mm Qty 1 pcs		

sealing washers

silicone gaskets

GEV No.	511691	Ref. No.	JOIN047
description	gasket silicone ED ø 51mm ID ø 4mm thickness 2mm Qty 1 pcs for combi-steamer		

O-rings

EPDM

GEV No.	524421	Ref. No.	JOIN211
description	O-ring EPDM thickness 1.78mm ID ø 2.78mm Qty 1 pcs		

GEV No.	505180	Ref. No.	JOIN261
description	O-ring EPDM thickness 3.53mm ID ø 47.22mm Qty 1 pcs		

GEV No.	511331	Ref. No.	JOIN 261
description	O-ring EPDM thickness 3.53mm ID ø 53.57mm Qty 1 pcs		

GEV No.	505092	Ref. No.	JOIN057
description	O-ring EPDM thickness 5.34mm ID ø 43.82mm Qty 1 pcs		

sealing cords

round

GEV No.	693737	Ref. No.	JOIN3005
description	sealing cord round ø 25mm braided L 5m Qty 1		

shaft gaskets

miscellaneous

GEV No.	511605	Ref. No.	JOIN222
description	shaft seal		

special gaskets

miscellaneous

GEV No.	511615	Ref. No.	JOIN660
description	boiler gasket		

			
1			
GEV No.	511600	Ref. No.	00288A JOIN084
description	gasket ED ø 80mm		

			
1			
GEV No.	511689	Ref. No.	JOIN2026
description	gasket for lamp L 100mm W 24mm silicone thickness 2.8mm hole distance 22mm		

			
1			
GEV No.	900400	Ref. No.	JOIN641
description	gasket L 19mm W 1mm self-adhesive		

springs

torsion springs

			
1			
GEV No.	514505	Ref. No.	RES3001
description	torsion spring ø 30mm wire gauge ø 4.5mm L1 14mm L2 180mm L3 14mm mounting pos. left Qty 1 pcs		

			
1			
GEV No.	514504	Ref. No.	RES3000
description	torsion spring ø 30mm wire gauge ø 4.5mm L1 16mm L2 185mm L3 13mm mounting pos. right		

compression springs

			
1			
GEV No.	511604	Ref. No.	RES008
description	compression spring ø 12.4mm L 20mm wire gauge ø 0.9mm		

			
1			
GEV No.	692201	Ref. No.	RES015
description	compression spring ø 13.5mm L 20mm wire gauge ø 2mm windings 3		

			
1			
GEV No.	692202	Ref. No.	RES028
description	compression spring ø 4mm L 3mm wire gauge ø 0.5mm windings 2		

miscellaneous

			
1			
GEV No.	511601	Ref. No.	RES200
description	spring shaft diameter 4.5mm ømm L 45mm W 25mm H 1mm wire gauge ø 1mm		

hoses

industrial hoses

silicone hoses

without fabric

			
1			
GEV No.	530063	Ref. No.	TUY1824
description	silicone hose ID ø 18mm ED ø 25mm L 1m t.max. 200°C transparent		



fittings, hose and pipe connectors

hose connectors

producer-specific



1			
GEV No.	511946	Ref. No.	RAC2011 RAC2021
description	T-piece plastic/SS L 38mm ø 14mm W 27mm 1/8" connection 1: 8mm connection 2: 8mm		

water cycle components

pressure reduction valves

pressure reduction valves

producer-specific



1			
GEV No.	520589	Ref. No.	ROB028
description	pressure reduction valve Norgren series R91 connection 1/4" default settingbar setting range 0.1-3bar p max 10bar t.max. 50°C brass		



1			
GEV No.	520553	Ref. No.	ROB2004
description	pressure reduction valve Norgren series R91 connection 3/4" default settingbar setting range 0.1-3bar p max 10bar t.max. 50°C with manometer and non-return valve brass		

non-return valves



1			
GEV No.	511607	Ref. No.	ROB006
description	non-return valve		

fastening material

screws

grub screws

DIN 913/ISO 4026



1			
GEV No.	504733	Ref. No.	VIS317
description	grub screw thread M4 L 5mm stainless steel DIN 913 intake internal hexagon WS 2 Qty 1 pcs		

miscellaneous



1			
GEV No.	692200	Ref. No.	DECO366
description	grub screw thread M6 L 2.5mm SS intake slotted WS Qty 1 pcs		

washers

washers

miscellaneous



1			
GEV No.	692198	Ref. No.	VIS276
description	plain washer ID ø 8.5mm ED ø 18mm thickness 1.4mm SS Qty 1 pcs		



consumables

sealants and adhesives

high temperature silicone



1	GEV No.	890059	Ref. No.	JOIN555
	description	high temperature silicone FERMITOPP 300 neutral curing -40 up to +265°C black cartridge 310ml		
	description	<p>Fermitopp HN 300 - cartridge 310ml - black</p> <p>Is used for sealing expansion joints on heating flues, ovens, reactors, chimneys, stacks, etc. The sealant is neutrally cross-linking, reacts with the moisture in the air and is characterised by extremely good hot air-resistance. The adhesive surfaces must be dry, clean and free of loose parts and in the case of porous substrates they should, if necessary, be given a first coat of primer. Post-smoothing e.g. with soap solution must take place before skinning.</p> <p>Highly refractory, odourless, UV/water/colour/hot-air resistant</p> <p>Temperature range -50°C to +250°C</p>		

fuses

fine fuses



1	GEV No.	358532	Ref. No.	FUSI003
	description	fine fuse size ø5x20mm 2A fast-acting rated 250V Qty 10 pcs		



1	GEV No.	358607	Ref. No.	Fusi004
	description	fine fuse size ø5x20mm 6.3A slow-acting rated 250V Qty 10 pcs		

fine fuse holders



1	GEV No.	358010	Ref. No.	FUSI613
	description	fuse holder suitable fuse ø6.3x32mm 10A rated 250V connection F4.8		

A			
alarm devices	13	heating elements for griddles	3
axial fans	18	heating elements for pasta cookers	3
B		heating elements for pizza ovens	3
bar burners	25	high temperature silicone	36
booster pumps II	20	hob burners	25
C		hose connectors	35
cam switches	10	hoses	34
condensators & interference suppression filters	21	hot air fans	19
consumables	36	hot air motors	18
contactors	14	I	
control equipment	11	ignition units	24
control thermostats	8, 9	immersion heating elements	4
D		indicator lights	12
door seals	31	indicator lights (complete)	12
door seals with fixing hook	32	industrial hoses	34
drain pumps	20	L	
E		lamps	12
edgemount hinges	30	light bulbs	12
edgemount latches	29	M	
electric accessories	21	magnetic switches	10
electrodes	18	mechanical timers	13
electronic controllers	16	microswitches	10
F		motors	20
fans	18	N	
fastening material	35	non-return valves	35
filters	21	O	
fine fuses	36	operating capacitors	21
fluorescent lamps	12, 12	O-rings	33
fuses	21, 36	oven hinges	30
G		oven lamps	13
gas ball valves	26	P	
gas burners	25	pilot burners	23
gas nozzles	25	pressure reduction valves	35, 35
gas taps	22	probes	16
gaskets for control panels	32	programme timers	13
gaskets for heated units	31	pumps	20
grub screws	35	push button latches	29
H		push/momentary push switches	10
halogen lamp	12	R	
handle latches	29	relays	15
heating elements	3	rocker/momentary rocker switches	9
heating elements for bain maries	3	S	
heating elements for convection	5	safety thermostats	9
heating elements for fryers	3	screws	35
		sealants and adhesives	36

sealing cords	33
sealing washers	33
shaft gaskets	33
shelves and shelf rails	30
silicone	36
silicone hoses	34
snap locks	29
solenoid valves	17
solid state relays	15
switches and momentary switches	9

T

terminals	21
thermocouples	24
thermostats	8
time relays	15
timers	13
transformers	16

V

vibration pumps	20
-----------------	----

W

washers	35
water cycle components	35
window seals	31