



**GAS COMPONENTS**



**ELECTRIC COMPONENTS**



**WATER TECHNOLOGY**



**MECHANICAL COMPONENTS**



**TOOLS**

Spare parts suitable for

**BONNET**

Find the complete and up-to-date range of products in our GEV Webshop



# Manufacturer catalogue

The most important spare parts and accessories arranged clearly for every manufacturer

- ✓ Complete product range and all appliance data always up to date in the GEV Webshop
- ✓ Alphabetical Index at the end of the catalogue

## GEV Webshop

[www.gev-online.co.uk](http://www.gev-online.co.uk)

[www.gev-online.com](http://www.gev-online.com)



- 🔍 Add to Favourites
- 🔍 Sign In with email address and usual password
- 🔍 Easy-order – place several items in your basket at the same time
- 🔍 Quick Item search – no login needed



## heating elements

### heating elements for ovens

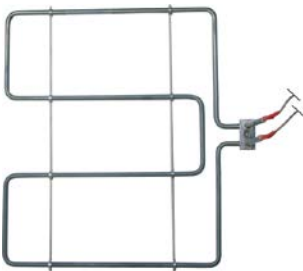

1

<b>GEV No.</b>	418524	<b>Ref. No.</b>	302189 BAAN169356 BAAN304579
<b>description</b>	heating element 1800W 400V heating circuits 1 L 416mm W 438mm L1 48mm L2 438mm W1 200mm W2 38mm flange length 50mm flange width 25mm hole ø 6.3mm tube ø 8.5mm connection length 115mm rectangular flange dry heating element oven H1 8mm cable length 880mm		

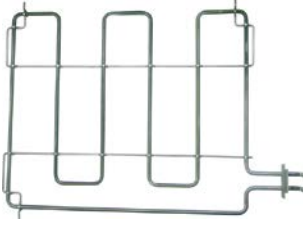

1

<b>GEV No.</b>	418525	<b>Ref. No.</b>	302191 BAAN169358 BAAN304581
<b>description</b>	heating element 3300W 400V L 610mm W 450mm L1 75mm L2 535mm W1 40mm W2 55mm flange length 72mm flange width 53mm hole distance 62mm hole ø 5mm tube ø 8.5mm connection M5 heating circuits 1 rectangular flange dry heating element oven		

### heating elements for bain maries



1

<b>GEV No.</b>	418913	<b>Ref. No.</b>	311739 BAAN1210213 BAAN305131
<b>description</b>	heating element 1800W 230V heating circuits 1 L 508mm L1 455mm W 70mm connection M4 connection distance 43mm tube ø 8.5mm dry heating element L2 50mm H 92mm		

### heating elements for frying pans



1

<b>GEV No.</b>	420432	<b>Ref. No.</b>	302197 302256 BAAN304588
<b>description</b>	heating element 1800W 230V heating circuits 1 L 90mm W 556mm hole distance 55mm tube ø 8mm H 134mm		

### heating elements for fryers

#### 2 hole fixing

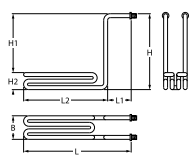
1

<b>GEV No.</b>	418914	<b>Ref. No.</b>	322523 BAAN305394
<b>description</b>	heating element 4000W 230V heating circuits 1 L 500mm W 64mm H 290mm L1 120mm L2 380mm W1 12mm W2 40mm H1 245mm H2 55mm connection M5 immersion heater thread 1/4" tube ø 8.5mm fryer		

### heating elements for griddles



1

<b>GEV No.</b>	418922	<b>Ref. No.</b>	310128 BAAN304890
<b>description</b>	heating element 1800W 220V heating circuits 1 L 523mm W 57mm H 81mm tube ø 10mm connection M4 grill connection distance 480mm dry heating element		

### heating elements for salamanders/toast-



1

<b>GEV No.</b>	420497	<b>Ref. No.</b>	D02149
<b>description</b>	heating element 2000W 230V L 230mm W 215mm L1 22mm L2 208mm W1 74mm W2 70mm thread M16 mounting distance 55mm tube ø 8mm connection M4		



1

<b>GEV No.</b>	418215	<b>Ref. No.</b>	402077 BAAN774888
<b>description</b>	heating element 700W 245V L 410mm thread M14x1.25 connection length 19mm tube ø 10mm connection M4 heating circuits 1 dry heating element salamander grill W 10mm H 10mm		



## immersion heating elements

## 3 hole flange ø38.5mm

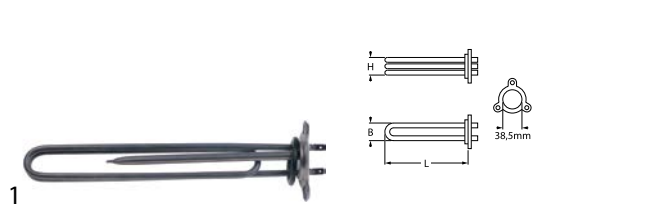

<b>GEV No.</b>	418642	<b>Ref. No.</b>	2001621H
----------------	--------	-----------------	----------

**description** heating element 2600W 230V mounting ø 38.5mm heating circuits 1 L 260mm W 33mm H 24mm number of thermostat sleeves 1 thermostat sleeves ø 7mm length thermostat sleeves 175mm thermostat sleeve eccentric, non clinging tube ø 6.5mm hole distance 57mm 3 hole flange connection male faston 6.3mm immersion heater

<b>accessories for</b>	418642		
------------------------	--------	--	--

<b>GEV No.</b>	532577	<b>Ref. No.</b>	—
----------------	--------	-----------------	---

**O-ring** EPDM thickness 5.34mm ID ø 40.65mm Qty 1 pcs

## 3 hole flange ø47.5mm

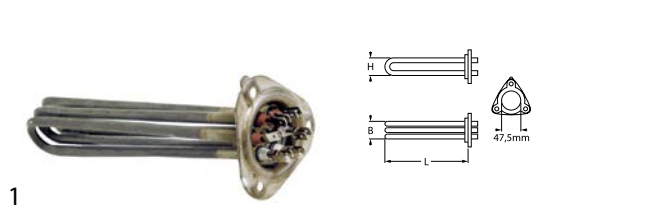

<b>GEV No.</b>	416128	<b>Ref. No.</b>	5079E
----------------	--------	-----------------	-------

**description** heating element 4500W 230V mounting ø 47.5mm heating circuits 3 L 265mm W 30mm H 35mm tube ø 8.5mm hole distance 60mm hole ø 10mm connection male faston 6.3mm 3 hole flange immersion heater

<b>accessories for</b>	416128		
------------------------	--------	--	--

<b>GEV No.</b>	510408	<b>Ref. No.</b>	2001827H
----------------	--------	-----------------	----------

**O-ring** EPDM thickness 5.34mm ID ø 47mm Qty 1 pcs

<b>GEV No.</b>	510562	<b>Ref. No.</b>	—
----------------	--------	-----------------	---

**O-ring** silicone thickness 5.34mm ID ø 47mm Qty 1 pcs

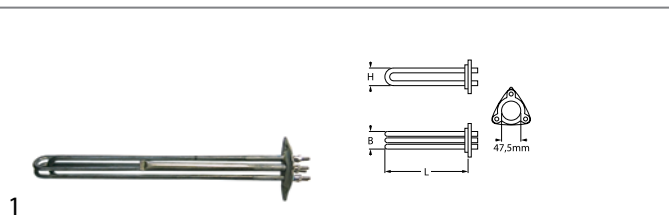

<b>GEV No.</b>	415001	<b>Ref. No.</b>	5845E
----------------	--------	-----------------	-------

**description** heating element 4500W 230V mounting ø 47.5mm heating circuits 3 L 316mm W 35mm H 34mm number of thermostat sleeves 1 thermostat sleeves ø 7mm length thermostat sleeves 180mm thermostat sleeve eccentric, non clinging tube ø 6.3mm hole distance 62mm hole ø 8mm connection M4 3 hole flange immersion heater

<b>spare parts for</b>	415001		
------------------------	--------	--	--

<b>GEV No.</b>	510408	<b>Ref. No.</b>	2001827H
----------------	--------	-----------------	----------

**O-ring** EPDM thickness 5.34mm ID ø 47mm Qty 1 pcs

<b>accessories for</b>	415001		
------------------------	--------	--	--

<b>GEV No.</b>	510562	<b>Ref. No.</b>	—
----------------	--------	-----------------	---

**O-ring** silicone thickness 5.34mm ID ø 47mm Qty 1 pcs

<b>accessories for</b>	415001		
------------------------	--------	--	--

<b>GEV No.</b>	521103	<b>Ref. No.</b>	—
----------------	--------	-----------------	---

**nut** thread M4 H 3mm WS 7 brass Qty 20 pcs

<b>GEV No.</b>	521104	<b>Ref. No.</b>	—
----------------	--------	-----------------	---

**washer** ID ø 4.3mm ED ø 8mm thickness 0.5mm brass Qty 20 pcs for thread M4

<b>GEV No.</b>	560111	<b>Ref. No.</b>	—
----------------	--------	-----------------	---

**plain washer** ID ø 4.3mm ED ø 9mm thickness 0.8mm SS Qty 20 pcs DIN 125A for thread M4

<b>GEV No.</b>	560131	<b>Ref. No.</b>	—
----------------	--------	-----------------	---

**hexagonal nut** thread M4 H 3.2mm WS 7 SS DIN/ISO DIN 934 / ISO 4032/8673 Qty 20 pcs

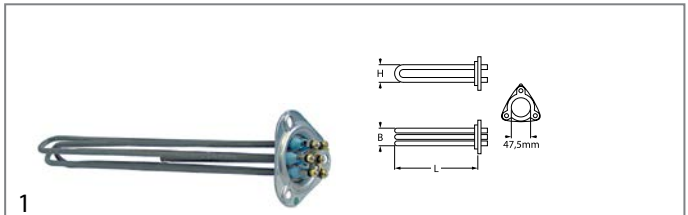

<b>GEV No.</b>	416240	<b>Ref. No.</b>	2001858H
----------------	--------	-----------------	----------

**description** heating element 6545W 230/400V mounting ø 48mm heating circuits 3 L 355mm W 31mm H 37mm number of thermostat sleeves 1 thermostat sleeves ø 7mm length thermostat sleeves 175mm thermostat sleeve upper centre not clinging tube ø 6.5mm hole distance 63mm hole ø 10mm connection M4 3 hole flange immersion heater

<b>accessories for</b>	416240		
------------------------	--------	--	--

<b>GEV No.</b>	510408	<b>Ref. No.</b>	2001827H
----------------	--------	-----------------	----------

**O-ring** EPDM thickness 5.34mm ID ø 47mm Qty 1 pcs

<b>GEV No.</b>	510562	<b>Ref. No.</b>	—
----------------	--------	-----------------	---

**O-ring** silicone thickness 5.34mm ID ø 47mm Qty 1 pcs

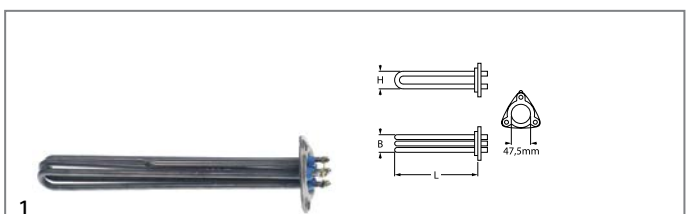

<b>GEV No.</b>	416242	<b>Ref. No.</b>	2001941H BAAN1049665 BAAN1321560
----------------	--------	-----------------	----------------------------------------



**description** heating element 9500W 230V mounting ø 47.5mm heating circuits 3 L 330mm W 35mm H 35mm number of thermostat sleeves 1 thermostat sleeves ø 7mm length thermostat sleeves 175mm thermostat sleeve eccentric, non clinging tube ø 8.5mm hole distance 72mm hole ø 8/10mm connection M4 3 hole flange immersion heater

<b>spare parts for</b>	416242		
------------------------	--------	--	--

<b>GEV No.</b>	510408	<b>Ref. No.</b>	2001827H
----------------	--------	-----------------	----------

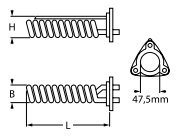
**O-ring** EPDM thickness 5.34mm ID ø 47mm Qty 1 pcs





<b>GEV No.</b>	418709	<b>Ref. No.</b>	5535E 5536E BAAN307533
<b>description</b>	heating element 2400W 230V mounting $\varnothing$ 47.5mm heating circuits 1 L 190mm W 32mm H 40mm number of thermostat sleeves 1 thermostat sleeves $\varnothing$ 7mm length thermostat sleeves 170mm thermostat sleeve eccentric, non clinging tube $\varnothing$ 6.5mm hole distance 72mm hole $\varnothing$ 8x10mm connection M4 3 hole flange immersion heater		
<b>spare parts for</b>	418709		
	<b>GEV No.</b>	510408	<b>Ref. No.</b> 2001827H
<b>accessories for</b>	418709		
	<b>GEV No.</b>	510562	<b>Ref. No.</b> —
	O-ring silicone thickness 5.34mm ID $\varnothing$ 47mm Qty 1 pcs		

with expansion flange 70 x 18mm





<b>GEV No.</b>	420171	<b>Ref. No.</b>	903121 BAAN1323213 BAAN311688
<b>description</b>	heating element 1500W 220V heating circuits 1 flange 70x18mm L 255mm W 65mm H 32mm connection male faston 6.3mm immersion heater tube $\varnothing$ 8.5mm		

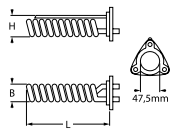

<b>GEV No.</b>	415016	<b>Ref. No.</b>	903101 BAAN1323208 BAAN782792
<b>description</b>	heating element 3000W 230V heating circuits 3 flange 70x18mm L 398mm W 60mm H 24mm connection male faston 6.3mm immersion heater expansion flange tube $\varnothing$ 6.3mm		





<b>GEV No.</b>	415668	<b>Ref. No.</b>	5535E 5536E BAAN307533
<b>description</b>	heating element 2625W 230V mounting $\varnothing$ 47.5mm heating circuits 1 L 190mm W 41mm H 54mm number of thermostat sleeves 1 thermostat sleeves $\varnothing$ 7mm length thermostat sleeves 170mm thermostat sleeve eccentric, non clinging tube $\varnothing$ 6.3mm hole distance 62mm hole $\varnothing$ 8mm connection M4 3 hole flange immersion heater		
<b>spare parts for</b>	415668		
	<b>GEV No.</b>	510408	<b>Ref. No.</b> 2001827H
<b>accessories for</b>	415668		
	<b>GEV No.</b>	510562	<b>Ref. No.</b> —
	O-ring silicone thickness 5.34mm ID $\varnothing$ 47mm Qty 1 pcs		



<b>GEV No.</b>	416243	<b>Ref. No.</b>	2001624H BAAN1121241 BAAN1321308
<b>description</b>	heating element 7600W 230V heating circuits 3 flange 70x18mm L 390mm W 60mm H 13mm connection male faston 6.3mm tube $\varnothing$ 6.3mm immersion heater expansion flange INCOLOY-800		

with round flange  $\varnothing$ 47.5mm



<b>GEV No.</b>	418923	<b>Ref. No.</b>	1030210 103210 BAAN1209264 BAAN301064
<b>description</b>	heating element 6000W 230V heating circuits 3 mounting $\varnothing$ 47.5mm L 493mm W 36mm H 31mm round flange connection male faston 6.3mm thermostat sleeves $\varnothing$ 7mm number of thermostat sleeves 1 length thermostat sleeves 145mm thermostat sleeve eccentric, clinging		

with compression flange 50 x 26mm

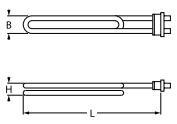
<b>GEV No.</b>	418932	<b>Ref. No.</b>	71244E
<b>description</b>	heating element 2000W 240V heating circuits 1 flange 50x26mm L 350mm W 30mm Hmm compression flange connection male faston 6.3mm tube $\varnothing$ 6.3mm immersion heater		

miscellaneous



<b>GEV No.</b>	418924	<b>Ref. No.</b>	71892E BAAN309670
<b>description</b>	heating element 8000W 230V heating circuits 3 L 305mm W 37mm H 36mm thermostat sleeve eccentric, non clinging tube $\varnothing$ 8mm hole distance 45mm hole $\varnothing$ 10mm connection length 30mm connection M4 immersion heater flange width 64mm flange length 64mm		



1 1/4"



1

<b>GEV No.</b>	415005	<b>Ref. No.</b>	3696E
<b>description</b>	heating element 2000W 230V heating circuits 1 thread 1 1/4" L 170mm W 32mm H 22mm tube ø 6.2mm connection M4		
<b>accessories for</b>	415005		
	GEV No.	510405	Ref. No. —
	GEV No.	520232	Ref. No. —
	GEV No.	521103	Ref. No. —
	GEV No.	521104	Ref. No. —
	GEV No.	528021	Ref. No. —
	GEV No.	560111	Ref. No. —
	GEV No.	560131	Ref. No. —



1

<b>GEV No.</b>	415010	<b>Ref. No.</b>	5514E BAAN1322910 BAAN307475
<b>description</b>	heating element 2000W 230V heating circuits 1 L 260mm W 125mm H 20mm L1 110mm L2 150mm W1 42mm W2 83mm thread M10x1 mounting distance 70mm tube ø 6.5mm connection M4 immersion heater 2 hole fixing		
<b>spare parts for</b>	415010		
	GEV No.	510416	Ref. No. —
<b>accessories for</b>	415010		
	GEV No.	504306	Ref. No. —
	GEV No.	510893	Ref. No. —
	GEV No.	520231	Ref. No. —
	GEV No.	521103	Ref. No. —
	GEV No.	521104	Ref. No. —

<b>accessories for</b>	415010		
	GEV No.	521129	Ref. No. —
	GEV No.	560111	Ref. No. —
	GEV No.	560131	Ref. No. —



1

<b>GEV No.</b>	415072	<b>Ref. No.</b>	5065E
<b>description</b>	heating element 2200W 230V heating circuits 1 L 325mm W 83mm H 25mm thread M14x1 mounting distance 75mm tube ø 8.5mm connection male faston 6.3mm 2 hole fixing immersion heater		
<b>accessories for</b>	415072		
	GEV No.	510417	Ref. No. —
	GEV No.	520228	Ref. No. —
	GEV No.	521133	Ref. No. —
	GEV No.	550261	Ref. No. —
	GEV No.	550262	Ref. No. —









1

<b>GEV No.</b>	415665	<b>Ref. No.</b>	5856E
<b>description</b>	heating element 2750/3250W 220/240V heating circuits 1 L 380mm W 110mm H 30mm thread M10x1 mounting distance 75mm tube ø 6.5mm connection M4 immersion heater 2 hole fixing		
<b>spare parts for</b>	415665		
	GEV No.	510893	Ref. No. —
<b>accessories for</b>	415665		
	GEV No.	510416	Ref. No. —
	GEV No.	520231	Ref. No. —
	GEV No.	521103	Ref. No. —



Table continues overleaf







<b>accessories for</b>	415665		
	GEV No.	521104	Ref. No. —
	washer ID ø 4.3mm ED ø 8mm thickness 0.5mm brass Qty 20 pcs for thread M4		
	GEV No.	521129	Ref. No. —
	nut thread M10 H 6mm SS WS 17 Qty 1 pcs DIN/ISO DIN 439		
	GEV No.	560111	Ref. No. —
	plain washer ID ø 4.3mm ED ø 9mm thickness 0.8mm SS Qty 20 pcs DIN 125A for thread M4		
	GEV No.	560131	Ref. No. —
	hexagonal nut thread M4 H 3.2mm WS 7 SS DIN/ISO DIN 934 / ISO 4032/8673 Qty 20 pcs		



<b>1</b>			
<b>GEV No.</b>	416235	<b>Ref. No.</b>	2001933H
<b>description</b>	heating element 3000W 230V heating circuits 1 L 320mm W 50mm H 40mm thread M10x1 mounting distance 44mm tube ø 6.3mm connection male faston 6.3mm 2 hole fixing L1 32mm L2 288mm		
<b>spare parts for</b>	416235		
	GEV No.	510893	Ref. No. —
	O-ring EPDM thickness 2.62mm ID ø 9.92mm Qty 1 pcs		
<b>accessories for</b>	416235		
	GEV No.	510416	Ref. No. —
	flat gasket fibre ED ø 19mm ID ø 10.5mm thickness 1.5mm for thread M10 Qty 1 pcs		
	GEV No.	510893	Ref. No. —
	O-ring EPDM thickness 2.62mm ID ø 9.92mm Qty 1 pcs		
	GEV No.	521129	Ref. No. —
	nut thread M10 H 6mm SS WS 17 Qty 1 pcs DIN/ISO DIN 439		
	GEV No.	560192	Ref. No. —
	tooth lock washer ID ø 10.4mm ED ø 18mm SS DIN/ISO DIN 6798A Qty 1 pcs for thread M10		

**heating elements for convection**

<b>1</b>			
<b>GEV No.</b>	418916	<b>Ref. No.</b>	72104E BAAN309867
<b>description</b>	heating element 12000W 240V heating circuits 3 ID ø 390mm ED ø 410mm L 410mm H 100mm H1 25mm H2 75mm thread M12x1 6 hole fixing connection male faston 6.3mm tube ø 8.5mm convection heating element		
<b>accessories for</b>	418916		
	GEV No.	101566	Ref. No. —
	nut thread M12x1 H 10mm WS 19 SS Qty 1 pcs		

<b>accessories for</b>	418916		
	GEV No.	506046	Ref. No. —
	flat gasket FIBER ED ø 19.5mm ID ø 13mm thickness 2mm Qty 1 pcs		
	GEV No.	528622	Ref. No. —
	spring ø 15.3mm L 25mm wire gauge ø 1.25mm for water filling		

<b>1</b>			
<b>GEV No.</b>	415134	<b>Ref. No.</b>	302241 BAAN1005875 BAAN1057721
<b>description</b>	heating element 2500W 230V heating circuits 1 ID ø 180mm ED ø 193mm L 245mm H 28mm L1 54mm W1 32mm H1 18mm H2 10mm flange length 70mm flange width 22mm hole distance 55mm connection male faston 6.3mm 2 hole fixing L1 32mm L2 288mm convection heating element hole ø 5mm rectangular flange		
<b>accessories for</b>	415134		
	GEV No.	510368	Ref. No. —
	gasket L 70mm W 23.5mm hole ø 5mm hole distance 56mm FIBER thickness 2mm for heating element		

<b>1</b>			
<b>GEV No.</b>	418925	<b>Ref. No.</b>	71844E BAAN309621
<b>description</b>	heating element 1500W 230V heating circuits 1 L 293mm W 106mm L1 32mm L2 261mm W2 83mm flange length 50mm flange width 26mm connection length 63mm connection male faston 6.3mm tube ø 8.5mm hole ø 6.2mm W1 23mm convection heating element convection oven INCOLOY windings 2		
<b>accessories for</b>	418925		
	GEV No.	520588	Ref. No. —
	gasket L 46mm W 22mm hole distance 24.5mm silicone for heating element		

<b>1</b>			
<b>GEV No.</b>	418933	<b>Ref. No.</b>	71240E
<b>description</b>	heating element 2000W 240V heating circuits 1 L 390mm W 134mm W2 100mm flange length 50mm flange width 20mm connection length 50mm connection M4 tube ø 10mm thread M4 W1 34mm rectangular flange convection heating element convection oven		

<b>GEV No.</b>	418917	<b>Ref. No.</b>	309252 71241E BAAN71241E
<b>description</b>	heating element 3000W 240V heating circuits 3 L 570mm W 140mm W2 110mm flange length 110mm flange width 20mm hole distance 40mm connection length 55mm connection M4 tube ø 10mm thread M4 W1 30mm rectangular flange convection heating element convection oven		

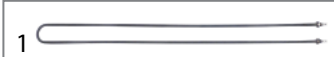

<b>GEV No.</b>	418931	<b>Ref. No.</b>	71243E
<b>description</b>	heating element 4000W 230V heating circuits 1 L 1130mm W 80mm connection M4 tube ø 10mm thread M14x1.25 2 hole fixing convection heating element convection oven mounting distance 70mm		

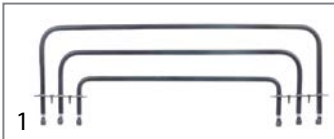

<b>GEV No.</b>	418918	<b>Ref. No.</b>	71242E BAAN309253
<b>description</b>	heating element 4000W 240V heating circuits 3 L 570mm W 140mm W2 110mm flange length 110mm flange width 20mm hole distance 40mm connection length 55mm connection M4 tube ø 10mm thread M4 W1 30mm rectangular flange convection heating element convection oven		

### radiation heaters



<b>GEV No.</b>	417638	<b>Ref. No.</b>	303055 BAAN836485 BAAN847614
<b>description</b>	radiation heater rectangular 8000W 400V L 300mm W 570mm H 40mm heating circuits 2 EGO		

### hot plates

#### square & rectangular

#### with radiused edge



<b>GEV No.</b>	490056 <sup>1</sup>	<b>Ref. No.</b>	904877
<b>description</b>	hot plate dimensions 300x300mm 3000W 230V with spill ring connection 4 screw clamps protector yes square		

<sup>1</sup>incl. protector



<b>GEV No.</b>	490073	<b>Ref. No.</b>	303561 BAAN304723
<b>description</b>	hot plate dimensions 300x300mm 3000W 400V with spill ring connection 4 screw clamps protector no square		



<b>GEV No.</b>	490057 <sup>1</sup>	<b>Ref. No.</b>	303561 BAAN304723
<b>description</b>	hot plate dimensions 300x300mm 3000W 400V with spill ring connection 4 screw clamps protector yes square		

<sup>1</sup>incl. protector



<b>GEV No.</b>	490071 <sup>1</sup>	<b>Ref. No.</b>	904879
<b>description</b>	hot plate dimensions 300x300mm 4000W 230V with spill ring connection 4 screw clamps protector yes square		

<sup>1</sup>incl. protector



<b>GEV No.</b>	490074 <sup>1</sup>	<b>Ref. No.</b>	303562 BAAN304725
<b>description</b>	hot plate dimensions 300x300mm 4000W 400V with spill ring connection 4 screw clamps protector yes square		

<sup>1</sup>incl. protector



round

with radiused edge

for domestic and commercial kitchens



<b>GEV No.</b>	490019	<b>Ref. No.</b>	905303 BAAN311946
<b>description</b>	hot plate ø 220mm 2000W 400V connection 4 screw clamps with 8mm spill ring		



<b>GEV No.</b>	490020	<b>Ref. No.</b>	7450384
<b>description</b>	hot plate ø 220mm 2600W 230V connection 4 screw clamps with 8mm spill ring		
<b>accessories for</b>	490020		
	<b>GEV No.</b>	550796	<b>Ref. No.</b> —
fixing plate for hot plate ø220mm			



<b>GEV No.</b>	490021	<b>Ref. No.</b>	7450385 BAAN310419
<b>description</b>	hot plate ø 220mm 2600W 400V connection 4 screw clamps with 8mm spill ring		

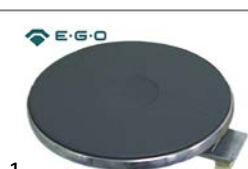

<b>GEV No.</b>	490063	<b>Ref. No.</b>	7450387
<b>description</b>	hot plate ø 300mm 2500W 400V connection 4 screw clamps with 8mm spill ring		



<b>GEV No.</b>	490064	<b>Ref. No.</b>	303008 BAAN167143 BAAN304666
<b>description</b>	hot plate ø 300mm 3500W 400V with 8mm spill ring		

energy regulators

EGO

1-circuit



<b>GEV No.</b>	380015	<b>Ref. No.</b>	1800602 301200 70486E 72113E BAAN167036 BAAN304497
<b>description</b>	energy regulator 230V 13A single-circuit turn direction right shaft ø 6x4.6mm shaft L 23mm mounting thread M4 power release 6-100% no. 50.57021.010		

DIAMOND



<b>GEV No.</b>	380037	<b>Ref. No.</b>	904982 BAAN1209964 BAAN311867
<b>description</b>	energy regulator 240V 13.5A turn direction right shaft ø 6x4.6mm shaft L 13mm mounting thread 3/8"-24UNF equiv. no. 35ERE101230V		









<b>GEV No.</b>	380039	<b>Ref. No.</b>	7492053 BAAN310695
<b>description</b>	energy regulator 400V 13.5A turn direction right shaft ø 6x4.6mm mounting thread 3/8"-24UNF equiv. no. 35ERE104400V		
<b>accessories for</b>	380039		
	<b>GEV No.</b>	361181	<b>Ref. No.</b> —
nut thread 1/8" H 4.5mm nickel-plated brass WS 14 Qty 1 pcs			

## thermostats

### bi-metal thermostats

#### safety bi-metal thermostats

			
1			
<b>GEV No.</b>	390233	<b>Ref. No.</b>	2001681H 2001855H BAAN1121247 BAAN1321364 BAAN1321486 BAAN307863
<b>description</b>	bi-metal safety thermostat hole distance 24mm switch-off temp. 110°C 1NC 1-pole 16A connection F6.3 2 hole fixing without holder		
<b>accessories for</b>	390233		
	<b>GEV No.</b>	504736	<b>Ref. No.</b> —
bracket for contact thermostat			
	<b>GEV No.</b>	550388	<b>Ref. No.</b> —
bracket for contact thermostat mounting distance 24.5mm mounting ø 3.8			

			
1			
<b>GEV No.</b>	390138	<b>Ref. No.</b>	2001685H BAAN1121246 BAAN1321368
<b>description</b>	bi-metal safety thermostat hole distance 24mm switch-off temp. 112°C 1NC 1-pole 16A connection F6.3		
<b>accessories for</b>	390138		
	<b>GEV No.</b>	504736	<b>Ref. No.</b> —
bracket for contact thermostat			
	<b>GEV No.</b>	550388	<b>Ref. No.</b> —
bracket for contact thermostat mounting distance 24.5mm mounting ø 3.8			

#### bi-metal thermostats

			
1			
<b>GEV No.</b>	375927	<b>Ref. No.</b>	301045
<b>description</b>	bi-metal thermostat hole distance 23.5mm switch-off temp. 50°C 1NO 10A connection F6.3		

			
1			
<b>GEV No.</b>	390301	<b>Ref. No.</b>	2001680H BAAN1121245 BAAN1321363
<b>description</b>	bi-metal thermostat hole distance 23.8mm switch-off temp. 60°C 1NC 1-pole 16A connection F6.3 2 hole fixing		

			
1			
<b>GEV No.</b>	390101	<b>Ref. No.</b>	5011E
<b>description</b>	bi-metal thermostat hole distance 38mm switch-off temp. 53°C 1CO 1-pole 16A connection F6.3 2 hole fixing		

### control and safety thermostats

#### EGO

#### control thermostats



#### 55.10/19\_ series

			
1			
<b>GEV No.</b>	375001	<b>Ref. No.</b>	24650 BAAN1322435 BAAN303907
<b>description</b>	thermostat t.max. 112°C temperature range 30-110°C 1-pole 1NO 16A probe ø 6mm probe L 130mm capillary pipe 900mm capillary pipe isolated gland nut M9x1 shaft L 23mm shaft position upper rotation 270°		

			
1			
<b>GEV No.</b>	375063	<b>Ref. No.</b>	70707E BAAN308981
<b>description</b>	thermostat t.max. 170°C temperature range 70-170°C 1-pole 1NO 16A probe ø 11mm probe L 28mm capillary pipe 900mm capillary pipe isolated 900mm gland nut shaft L 23mm shaft position upper rotation 270° screw-in probe probe thread M14x1		
<b>accessories for</b>	375063		
	<b>GEV No.</b>	510417	<b>Ref. No.</b> —
flat gasket fibre ED ø 20mm ID ø 14mm thickness 2mm Qty 1 pcs			

Table continues overleaf



<b>accessories for</b> 375063	
	GEV No. 510420 Ref. No. — gasket copper ED ø 19.9mm ID ø 14.3mm thickness 2mm Qty 1 pcs
	GEV No. 521133 Ref. No. — nut thread M14x1.5 H 6mm WS 19 zinc-coated steel Qty 1 pcs

	
	
<b>GEV No.</b> 375468	<b>Ref. No.</b> 7471024 BAAN1209938 BAAN310614
<b>description</b>	thermostat t.max. 180°C temperature range 80-180°C 1-pole 1NO 16A probe ø 6mm probe L 135mm capillary pipe 900mm capillary pipe isolatedmm gland nut M9x1 shaft ø 6x4.6mm shaft L 23mm shaft position upper rotation 270°

	
	
<b>GEV No.</b> 376054	<b>Ref. No.</b> 2020062
<b>description</b>	thermostat t.max. 200°C temperature range 65-200°C 1CO 6.3A probe ø 6mm probe L 78mm capillary pipe 900mm capillary pipe isolatedmm gland nut M12 shaft ø 6x4.6mm shaft L 23mm rotation 270° probe material SS screw connection M9x1 disc ø 7.7mm
<b>accessories for</b> 376054	
	GEV No. 110121 Ref. No. — knob thermostat t.max. 200°C ø 50mm shaft ø 6x4.6mm shaft flat upper black temperature range 60-200°C rotation 270°
	GEV No. 110135 Ref. No. — rosette knob up to ø 52mm

	
	
<b>GEV No.</b> 375664	<b>Ref. No.</b> 301031 BAAN167028 BAAN936229
<b>description</b>	thermostat t.max. 287°C temperature range 60-287°C 1-pole 1NO 16A probe ø 3.1mm probe L 226mm capillary pipe 1470mm capillary pipe isolated 350mm gland nut shaft ø 6x4.6mm shaft L 23mm shaft position upper rotation 270°

	
	
<b>GEV No.</b> 375314	<b>Ref. No.</b> 2050031 BAAN303428
<b>description</b>	thermostat t.max. 320°C temperature range 50-320°C 1-pole 1NO 16A probe ø 3mm probe L 120mm capillary pipe 1200mm capillary pipe isolatedmm gland nut shaft ø 6x4.6mm shaft L 23mm shaft position upper rotation 270° with 2 probes

	
	
<b>GEV No.</b> 375002	<b>Ref. No.</b> 7471032 BAAN1209939 BAAN310615
<b>description</b>	thermostat t.max. 320°C temperature range 55-320°C 1-pole 1NO 16A probe ø 3.1mm probe L 226mm capillary pipe 870mm capillary pipe isolated 850mm gland nut shaft L 23mm shaft position upper rotation 270°



<b>GEV No.</b>	390003	<b>Ref. No.</b>	3650E BAAN305570
<b>description</b>	thermostat t.max. 90°C temperature range 30-90°C 1-pole 1CO 16A probe ø 15mm probe L 22.5mm capillary pipe 1700mm capillary pipe isolatedmm gland nut shaft ø 6x4.6mm shaft L 16mm shaft position upper° shaft position rotation 270° with knob probe		
<b>accessories for</b>	390003		
	<b>GEV No.</b>	510165	<b>Ref. No.</b> —
gasket for thermostat ED ø 27mm ID ø 11mm thickness 8.5mm			



<b>GEV No.</b>	375482	<b>Ref. No.</b>	1244788 905838
<b>description</b>	thermostat t.max. 95°C temperature range 30-90°C 1-pole 1CO 16A probe ø 6mm probe L 138mm capillary pipe 860mm capillary pipe isolatedmm gland nut M9x1 shaft ø 6x4.6mm shaft L 23mm shaft position lower rotation 270°		
<b>accessories for</b>	375482		
	<b>GEV No.</b>	111934	<b>Ref. No.</b> —
knob thermostat t.max. 90°C ø 50mm shaft ø 6x4.6mm shaft flat upper black temperature range 30-90°C rotation 270°			

55.34\_series



<b>GEV No.</b>	375143	<b>Ref. No.</b>	301003 7492058 BAAN1300894
<b>description</b>	thermostat t.max. 110°C temperature range 32-110°C 3-pole 3NO 16A probe ø 6mm probe L 138mm capillary pipe 1480mm capillary pipe isolated 1100mm gland nut M9x1 shaft ø 6x4.6mm shaft L 23mm shaft position upper rotation 270°		



<b>GEV No.</b>	375020	<b>Ref. No.</b>	301003 BAAN167016 BAAN878818
<b>description</b>	thermostat t.max. 110°C temperature range 32-110°C 3-pole capillary pipe isolatedmm gland nut		



<b>GEV No.</b>	375022	<b>Ref. No.</b>	301062 BAAN171096 BAAN304481
<b>description</b>	thermostat t.max. 180°C temperature range 95-180°C 3-pole 3NO 16A probe ø 6mm probe L 133mm capillary pipe 1780mm capillary pipe isolated 1400mm gland nut M9x1 shaft ø 6x4.6mm shaft L 23mm rotation 270°		



<b>GEV No.</b>	375417	<b>Ref. No.</b>	301004
<b>description</b>	thermostat t.max. 200°C temperature range 65-200°C 3-pole 3NO 16A probe ø 6mm probe L 79mm capillary pipe 840mm capillary pipe isolatedmm gland nut M9x1 shaft ø 6x4.6mm shaft L 23mm rotation 270°		



<b>GEV No.</b>	375038	<b>Ref. No.</b>	301005 310824 BAAN1300997 BAAN167017 BAAN304466 BAAN304978
<b>description</b>	thermostat t.max. 300°C temperature range 50-300°C 3-pole 3NO 16A probe ø 6mm probe L 79mm capillary pipe 1740mm capillary pipe isolated 800mm gland nut shaft ø 6x4.6mm shaft L 23mm shaft position upper rotation 270°		
<b>accessories for</b>	375038		
	<b>GEV No.</b>	110123	<b>Ref. No.</b> —
	knob thermostat t.max. 300°C ø 50mm shaft ø 6x4.6mm shaft flat upper black temperature range 50-300°C rotation 270°		



<b>GEV No.</b>	375026	<b>Ref. No.</b>	301006 7471044 BAAN1209940 BAAN310624
<b>description</b>	thermostat t.max. 350°C temperature range 100-350°C 3-pole 3NO 16A probe ø 6mm probe L 77mm capillary pipe 2430mm capillary pipe isolated 1100mm gland nut shaft ø 6x4.6mm shaft L 23mm shaft position upper rotation 270°		



<b>GEV No.</b>	390038	<b>Ref. No.</b>	5004E
<b>description</b>	thermostat t.max. 90°C temperature range 30-90°C 3-pole 3CO 16A probe ø 6mm probe L 215mm capillary pipe 900mm capillary pipe isolatedmm gland nut shaft Lmm		

safety thermostats

55.10/19\_ series



<b>GEV No.</b>	375233	<b>Ref. No.</b>	5519542090
<b>description</b>	safety thermostat switch-off temp. 235°C 1-pole 16A probe ø 6mm probe L 133mm capillary pipe 870mm capillary pipe isolated 830mm gland nut probe SS		
<b>accessories for</b>	375233		
	<b>GEV No.</b>	102067	<b>Ref. No.</b> —
	nut thread M8x1 H 3mm brass Qty 1 pcs type SEF 1		
	<b>GEV No.</b>	551083	<b>Ref. No.</b> —
	cap for safety thermostat thread M8x1		

55.13\_ series



<b>GEV No.</b>	375830	<b>Ref. No.</b>	905866 905886
<b>description</b>	safety thermostat switch-off temp. 365°C 1-pole 1NC 16A probe ø 3mm probe L 160mm capillary pipe 1730mm capillary pipe isolated 1710mm gland nut probe		

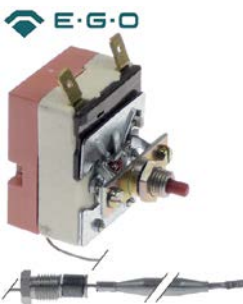

<b>GEV No.</b>	390801	<b>Ref. No.</b>	71280E
<b>description</b>	thermostat switch-off temp. 140°C 1-pole 16A probe ø 6mm probe L 78mm capillary pipe 1500mm capillary pipe isolatedmm gland nut probe connection male faston 6.3mm		

55.32\_ series

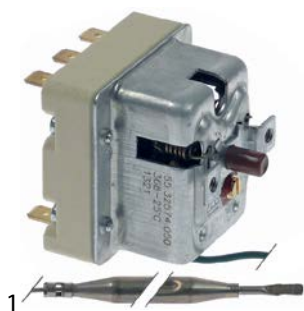

<b>GEV No.</b>	376062	<b>Ref. No.</b>	1040069
<b>description</b>	safety rod thermostat switch-off temp. 370°C 3-pole probe ø 6mm probe L 77mm capillary pipe 1500mm		



<b>GEV No.</b>	375984	<b>Ref. No.</b>	301061 BAAN171095 BAAN304480
<b>description</b>	safety thermostat switch-off temp. 225°C 3-pole 3NC 20A probe ø 6mm probe L 94mm capillary pipe 900mm capillary pipe isolated 670mm gland nut M10x1 probe SS		

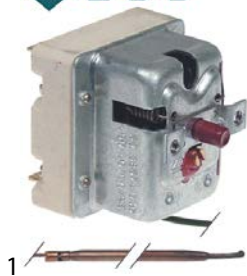

<b>GEV No.</b>	375706	<b>Ref. No.</b>	301049 BAAN169338 BAAN304476
<b>description</b>	safety thermostat switch-off temp. 400°C 3-pole 3NC 20A probe ø 3.9mm probe L 228mm capillary pipe 1190mm capillary pipe isolatedmm gland nut probe SS		

56\_ series



<b>GEV No.</b>	375442	<b>Ref. No.</b>	301039 301066 BAAN172196 BAAN304485
<b>description</b>	safety thermostat capillary pipe 1760mm probe ø 4mm 1-pole probe L 100mm 16A capillary pipe isolated 1600mm gland nut switch-off temp. 320°C probe		

control thermostats with operation switch

55.34\_ series

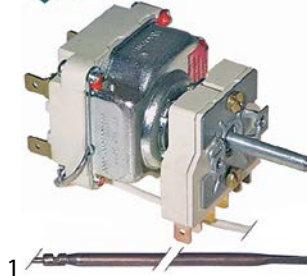

<b>GEV No.</b>	375246	<b>Ref. No.</b>	301034
<b>description</b>	thermostat t.max. 645°C temperature range 100-615/645°C 2-pole 2NO 16A probe ø 4mm probe L 230mm capillary pipe 1100mm capillary pipe isolated 600mm gland nut shaft ø 6x4.6mm shaft L 25mm shaft position lower rotation 270° outer switch 2NO probe material copper		

IMIT / TEMPOMATIC / AR THERMO

control thermostats





<b>GEV No.</b>	390314	<b>Ref. No.</b>	2001895H BAAN1321520 BAAN782894
<b>description</b>	thermostat t.max. 60°C temperature range fixed 60°C-pole 1CO 15A probe ø 6.5mm probe L 95mm capillary pipe 2000mm capillary pipe isolated 1950mm gland nut shaft ømm shaft Lmm shaft position rotation° probe material copper		

<b>GEV No.</b>	390421	<b>Ref. No.</b>	5508E
<b>description</b>	thermostat t.max. 85°C temperature range 0-90°C 1-pole 1CO 16A probe ø 6.5mm probe L 95mm capillary pipe 1500mm capillary pipe isolated 1450mm gland nut shaft ømm shaft Lmm shaft position rotation 270° probe material copper		



<b>GEV No.</b>	390425	<b>Ref. No.</b>	5868E BAAN1322991 BAAN307892
<b>description</b>	thermostat t.max. 85°C temperature range fixed 60°C 1-pole 1CO 16A probe ø 9.5mm probe L 37mm capillary pipe 600mm capillary pipe isolated 600mm gland nut shaft ømm shaft Lmm shaft position rotation° screw-in probe probe thread M14x1 probe material SS		
<b>accessories for</b>	390425		
	<b>GEV No.</b>	510417	<b>Ref. No.</b> —
	flat gasket fibre ED ø 20mm ID ø 14mm thickness 2mm Qty 1 pcs		
	<b>GEV No.</b>	511472	<b>Ref. No.</b> —
	nut thread 3/8" H 4mm brass WS 21 Qty 1 pcs		



<b>GEV No.</b>	375847	<b>Ref. No.</b>	901017
<b>description</b>	thermostat t.max. 90°C temperature range 0-90°C 1-pole 1CO 15A probe ø 6.5mm probe L 100mm capillary pipe 1500mm capillary pipe isolatedmm gland nut shaft ø 6x4.6mm shaft L 18mm shaft position +135° rotation 270° 250V		

safety thermostats



<b>GEV No.</b>	390770	<b>Ref. No.</b>	2002136H BAAN1137217 BAAN1321720
<b>description</b>	safety thermostat switch-off temp. 90-110°C 1-pole 1CO 16/0.5A probe ø 6.5mm probe L 90mm capillary pipe 2000mm capillary pipe isolated 1950mm gland nut probe		

PRODIGY / FIRT

safety thermostats



<b>GEV No.</b>	375478	<b>Ref. No.</b>	2001687H
<b>description</b>	safety thermostat switch-off temp. 200°C temperature range°C 1-pole 1CO 20A probe ø 3.3mm probe L 190mm capillary pipe 2150mm capillary pipe isolatedmm gland nut probe SS		

accessories

gland nut accessories

ducts



<b>GEV No.</b>	550148	<b>Ref. No.</b>	91373062 BAAN1323396 BAAN312763
<b>description</b>	gland duct ET M12x0.75 IT M9x1 probe ø max. 6.5mm WS 17 silicone		

connecting bows



<b>GEV No.</b>	550060	<b>Ref. No.</b>	300177
<b>description</b>	connecting bow long for thermostat Qty 1 pcs		



## switches and momentary switches

## rocker/momentary rocker switches

30x22mm



1

<b>GEV No.</b>	301202 <sup>1</sup>	<b>Ref. No.</b>	905913
<b>description</b>	rocker switch mounting measurements 30x22mm black 2NO 230V 20A 0-1 connection male faston 6.3mm ambient temperature max. 125/55°C protection IP65 with rubber collar		

<sup>1</sup>non-illuminated

1

<b>GEV No.</b>	346068	<b>Ref. No.</b>	905022 905913 BAAN1323284 BAAN1323317 BAAN312059 BAAN876393
<b>description</b>	momentary rocker switch mounting measurements 30x22mm black 2NO 250V 16A 0-1 connection male faston 6.3mm ambient temperature max. 85/125°C protection IP40		

**accessories for** 346068

<b>GEV No.</b>	301036	<b>Ref. No.</b>	—
protective cover internal size 30x22mm for rocker switch mounting measurementsmm			



1

<b>GEV No.</b>	346377	<b>Ref. No.</b>	905914 BAAN1323318 BAAN312060
<b>description</b>	rocker switch mounting measurements 30x22mm black 2CO 230V 16A 0-1 connection male faston 6.3mm ambient temperature max. 125/55°C protection IP40		

**accessories for** 346377

<b>GEV No.</b>	301036	<b>Ref. No.</b>	—
protective cover internal size 30x22mm for rocker switch mounting measurementsmm			

## push/momentary push switches

28.5x77.5mm



1

<b>GEV No.</b>	347611	<b>Ref. No.</b>	5865E BAAN1322989 BAAN307889
<b>description</b>	switch combination latching mounting measurements 28.5x77.5mm black 2CO/2NO/2NO 250V 16A with indicator connection male faston 6.3mm ambient temperature max. 85°C protection IP40		

ø12mm



1

<b>GEV No.</b>	347745	<b>Ref. No.</b>	300157 302556 BAAN166958 BAAN304361 BAAN304630
<b>description</b>	momentary switch with plunger thread M12x0.75 thread L 10mm 250V 2A 1NO connection male faston 6.3mm stroke 4mm ambient temperature max. 125°C type 1233A actuating force: 500g		

## microswitches

lever actuated



1

<b>GEV No.</b>	345257	<b>Ref. No.</b>	300688 3755E BAAN305693
<b>description</b>	microswitch with lever 250V 16A 1CO connection male faston 6.3mm L 29mm L1 33mm ambient temperature max. 120°C mounting distance 22mm actuating force: 130g lever length 31.5mm		



1

<b>GEV No.</b>	345049	<b>Ref. No.</b>	3755E BAAN305693
<b>description</b>	microswitch with lever CO connection male faston		

pin-plunger actuated

M10



1

<b>GEV No.</b>	347216	<b>Ref. No.</b>	303621 BAAN1210182 BAAN304729
<b>description</b>	microswitch with plunger thread M10x0.75 thread L 14mm 250V 10A 1CO connection male faston 6.3mm stroke 7.5mm mounting distance 22mm L 28mm ambient temperature max. 125°C type NR6K5 actuating force: 260g		





1

<b>GEV No.</b>	345032	<b>Ref. No.</b>	303621
<b>description</b>	microswitch with plunger thread M10x1 thread L 12mm 250V 16A 1CO connection male faston 6.3mm stroke 7mm mounting distance 22mm L 28mm ambient temperature max. 125°C type SP9603 actuating force: 180g		







M12			
 <p>1</p>			
<b>GEV No.</b>	345350	<b>Ref. No.</b>	1700340 BAAN1320656 BAAN302929
<b>description</b>	microswitch with plunger mounting distance 22mm thread M12x0.75 thread L 16mm 250V 16A 1CO connection male faston 6.3mm stroke 4mm ambient temperature max. 125°C type EF83161.3 actuating force: 66g		
<b>accessories for</b>	345350		
		<b>GEV No.</b>	345351 <b>Ref. No.</b> —
	nut thread M12x0.75 H 1.6mm WS 14 chrome-plated brass Qty 1 pcs		

with push button			
switches with snap-fit			
 <p>1</p>			
<b>GEV No.</b>	348008	<b>Ref. No.</b>	645128 825662 S128P15
<b>description</b>	microswitch with push button 250V 2.5A 1NO/1NC connection male faston 2.8mm/6.3mm L 27mm L1 22mm ambient temperature max. 104°C actuating force: 180g		

system switches (ROLD)

 <p>1</p>			
<b>GEV No.</b>	345537	<b>Ref. No.</b>	2001160H
<b>description</b>	element holder mounting measurements 20.6x16.4mm grey arched for push buttons 13x17mm		

 <p>1</p>			
<b>GEV No.</b>	346498	<b>Ref. No.</b>	900055 BAAN1323150 BAAN311605
<b>description</b>	element holder mounting measurements 28.5x28.5mm black single element holder		

 <p>1</p>			
<b>GEV No.</b>	345536	<b>Ref. No.</b>	900162
<b>description</b>	element holder mounting ø 16mm flat black		

 <p>1</p>			
<b>GEV No.</b>	345606	<b>Ref. No.</b>	2001544H
<b>description</b>	momentary switch unit 2CO 250V 16A connection male faston 6.3mm		

 <p>1</p>			
<b>GEV No.</b>	345538	<b>Ref. No.</b>	900163
<b>description</b>	push button ø 11.9mm black		

 <p>1</p>			
<b>GEV No.</b>	346816	<b>Ref. No.</b>	900056 BAAN1323151 BAAN311606
<b>description</b>	push button ø 23mm black		

 <p>1</p>			
<b>GEV No.</b>	346035	<b>Ref. No.</b>	2001695H
<b>description</b>	push button size 17x13mm silver		

 <p>1</p>			
<b>GEV No.</b>	345651	<b>Ref. No.</b>	900053 BAAN1323148 BAAN311603
<b>description</b>	switch 2CO 250V 16A connection male faston 6.3mm		



			
1			
<b>GEV No.</b>	346851	<b>Ref. No.</b>	2001327H
<b>description</b>	switch 2CO 250V 16A connection male faston 6.3mm		

## cam switches

## 7-position

			
1			
<b>GEV No.</b>	300106	<b>Ref. No.</b>	300010 BAAN166926 BAAN304345
<b>description</b>	cam switch 7 operating positions 1NO/2CO sequence 0-1-2-3-4-5-6 32A shaft $\varnothing$ 6x4.6mm shaft L 23mm connection screw 7-position shaft flat upper		

## 4 operating positions

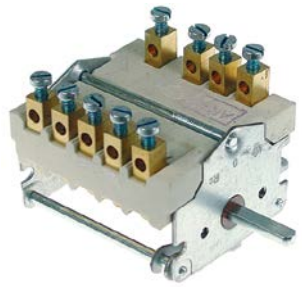
			
1			
<b>GEV No.</b>	300360	<b>Ref. No.</b>	300051 BAAN166932 BAAN304354
<b>description</b>	cam switch 4 operating positions 3NO/1CO sequence 0-1-2-3 32A shaft $\varnothing$ 6x4.6mm shaft L 23mm connection screw ceramic		

## operation switches

			
1			
<b>GEV No.</b>	300200	<b>Ref. No.</b>	905108 BAAN1218907 BAAN311907
<b>description</b>	operation switch 2 operating positions 2NO 16A sequence 0-1 shaft $\varnothing$ 6x4.6mm shaft L 23mm connection male faston 6.3mm operation switch ceramic		

			
1			
<b>GEV No.</b>	300091	<b>Ref. No.</b>	300175 BAAN169296 BAAN304364
<b>description</b>	operation switch EGO 2 operating positions 2NO 16A sequence 0-1 shaft $\varnothing$ 6x4.6mm shaft L 23mm connection screw ceramic		



## rotary switches

## ENTRELEC

			
1			
<b>GEV No.</b>	305001	<b>Ref. No.</b>	311243 BAAN305071
<b>description</b>	rotary switch 4 0-1-2-3 sets of contacts 10 type 400V 18A shaft $\varnothing$ 6x6mm shaft L 23mm shaft square connection screw		

## magnetic switches

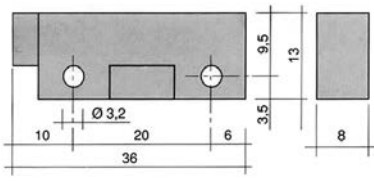
## 36x13mm

			
1			
			
<b>GEV No.</b>	345118 <sup>1</sup>	<b>Ref. No.</b>	2001136H 2001844H 2002431H
<b>description</b>	magnetic switch L 36mm W 13mm 1NO 250V 1A P max. 50W connection cable length 980mm		
<b>accessories for</b>	345118		
	<b>GEV No.</b>	345399	<b>Ref. No.</b>
			2001884H 2002082H 2002096H
	magnet $\varnothing$ 3.3mm L 40mm H 8mm W 13mm hole distance 30mm M3		

<sup>1</sup>with coded connector



accessories

magnets

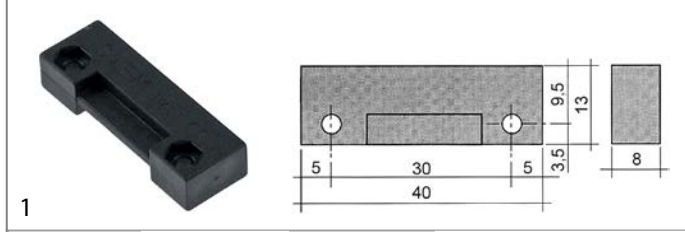

<b>GEV No.</b>	345399	<b>Ref. No.</b>	2001884H 2002082H 2002096H
<b>description</b>	magnet ø 3.3mm L 40mm H 8mm W 13mm hole distance 30mm M3		

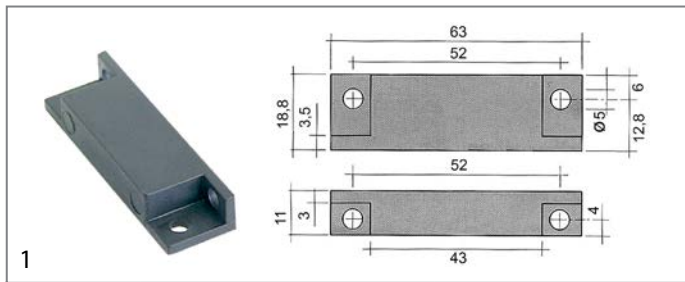

<b>GEV No.</b>	345336	<b>Ref. No.</b>	2001868H BAAN1321497 BAAN307903
<b>description</b>	magnet ø 4.8mm L 63mm H 11mm W 18.8mm hole distance 51mm M4		

encoders and potentiometers



<b>GEV No.</b>	300265	<b>Ref. No.</b>	309411 BAAN172230 BAAN701367
<b>description</b>	potentiometer		

lamps

indicator lights

indicator lights 2-piece (lens and indicator lamp)

indicator light lenses

ø12mm (type SDY-3)



<b>GEV No.</b>	359261	<b>Ref. No.</b>	904359
<b>description</b>	indicator light housings mounting measurements ø12mm red round Qty 1 pcs		

indicator lights 3-piece (housing, lens and bulb)

lamps

neon light bulbs



<b>GEV No.</b>	359585	<b>Ref. No.</b>	74540008
<b>description</b>	neon light bulb socket E10 230V green ø 10mm L 28mm		

<b>accessories for</b>	359585		
<b>GEV No.</b>	359060	<b>Ref. No.</b>	—

<b>GEV No.</b>	359685	<b>Ref. No.</b>	—
<b>description</b>	lamp socket mounting measurements ø16.2mm socket E10		

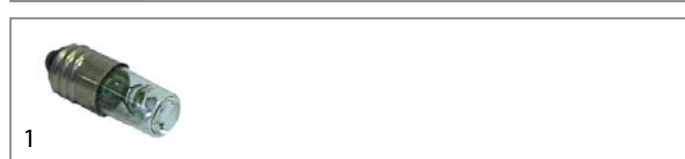

<b>GEV No.</b>	359601	<b>Ref. No.</b>	74540009
<b>description</b>	neon light bulb socket E10 380V clear ø 10mm L 28mm glas		

<b>accessories for</b>	359601		
<b>GEV No.</b>	359060	<b>Ref. No.</b>	—

<b>GEV No.</b>	359063	<b>Ref. No.</b>	—
<b>description</b>	lamp socket mounting measurements ø19.2mm socket E14 connection screw		

<b>GEV No.</b>	359064	<b>Ref. No.</b>	—
<b>description</b>	lamp socket mounting measurements ø22.3mm socket E14 connection screw 250/380V ambient temperature at 1W 100°C ambient temperature at 2W 85°C		

<b>GEV No.</b>	359685	<b>Ref. No.</b>	—
<b>description</b>	lamp socket mounting measurements ø16.2mm socket E10		

<b>GEV No.</b>	359832	<b>Ref. No.</b>	—
<b>description</b>	lamp socket mounting measurements ø16.2mm socket Ba9s connection male faston 6.3mm		

<b>GEV No.</b>	359853	<b>Ref. No.</b>	—
<b>description</b>	lamp socket mounting measurements ø18.2mm socket Ba9s connection male faston 6.3mm		

<b>GEV No.</b>	359988	<b>Ref. No.</b>	—
<b>description</b>	lamp socket mounting measurements ø30.5mm 250V connection F6.3 temp.-resist. 55°C E14		

indicator lights (complete)

ø 6mm



<b>GEV No.</b>	359005	<b>Ref. No.</b>	2002147H
<b>description</b>	indicator light ø 6mm 230V yellow cable length 400mm		

ø12mm

with screw socket



<b>GEV No.</b>	359892	<b>Ref. No.</b>	N/A
<b>description</b>	indicator light ø 12mm 24V yellow connection cable 200mm		



<b>GEV No.</b>	359893	<b>Ref. No.</b>	N/A
<b>description</b>	indicator light ø 12mm 400V green connection cable 200mm		



<b>GEV No.</b>	359895	<b>Ref. No.</b>	N/A
<b>description</b>	indicator light ø 12mm 400V yellow connection cable 200mm		



<b>GEV No.</b>	359894	<b>Ref. No.</b>	N/A
<b>description</b>	indicator light ø 12mm 400V red connection cable 200mm		

with plug-in socket



<b>GEV No.</b>	359925	<b>Ref. No.</b>	308334 BAAN167305 BAAN304818
<b>description</b>	indicator light ø 12mm 400V green connection 2-wire cable length 700mm temp.-resist. 150°C		

ø13mm

with plug-in socket



<b>GEV No.</b>	359141	<b>Ref. No.</b>	904359
<b>description</b>	indicator light ø 13mm red 230V connection male faston 6.3mm temp.-resist. 120°C Qty 1 pcs		



<b>GEV No.</b>	359143	<b>Ref. No.</b>	904300 904360 BAAN1323249 BAAN311747
<b>description</b>	indicator light ø 13mm yellow 230V connection male faston 6.3mm temp.-resist. 120°C Qty 1 pcs		

30x22mm



<b>GEV No.</b>	359156	<b>Ref. No.</b>	S175P15
<b>description</b>	indicator light mounting measurements 30x22mm 230V yellow connection male faston 6.3mm temp.-resist. 125/55°C type RL2		

LED

indicator lamps

mounting diameter 6mm



<b>GEV No.</b>	359404	<b>Ref. No.</b>	2001678H
<b>description</b>	indicator light LED mounting ø 6mm 5VDC green connection cable 200mm 2mA		



<b>GEV No.</b>	358098	<b>Ref. No.</b>	2001677H BAAN1121222 BAAN1321360
<b>description</b>	indicator light LED mounting ø 6mm 5VDC yellow connection cable 200mm 2mA		

screw-on/push-on fit

neon light bulbs



<b>GEV No.</b>	359585	<b>Ref. No.</b>	74540008
<b>description</b>	neon light bulb socket E10 230V green ø 10mm L 28mm		

accessories for 359585



<b>GEV No.</b>	359060	<b>Ref. No.</b>	—
<b>description</b>	lamp socket mounting measurements ø16.2mm socket E10 connection screw		



<b>GEV No.</b>	359685	<b>Ref. No.</b>	—
<b>description</b>	lamp socket mounting measurements ø16.2mm socket E10		









<b>GEV No.</b>	359601	<b>Ref. No.</b>	74540009
<b>description</b>	neon light bulb socket E10 380V clear ø 10mm L 28mm glas		

accessories for 359601



<b>GEV No.</b>	359060	<b>Ref. No.</b>	—
<b>description</b>	lamp socket mounting measurements ø16.2mm socket E10 connection screw		

Table continues overleaf

accessories for		359601	
	GEV No.	359063	Ref. No. —
	GEV No.	359064	Ref. No. —
	GEV No.	359685	Ref. No. —
	GEV No.	359832	Ref. No. —
	GEV No.	359853	Ref. No. —
	GEV No.	359988	Ref. No. —

**light bulbs**

for ovens

	<b>PHILIPS</b>		
1			
GEV No.	359610	Ref. No.	70597E
description	light bulb t.max. 300°C socket E14 15W 230V ø 22mm L 47mm lens L 20mm for oven lamp type Philips		

			
1			
GEV No.	357153	Ref. No.	70598E
description	light bulb t.max. 300°C socket E14 25W 230V ø 25mm L 55mm lens L 30mm for oven type		

			
1			
GEV No.	359614	Ref. No.	308463
description	light bulb t.max. 300°C socket E27 230V 40W ø 45mm L 71mm lens L 44mm Qty 1 pcs		

**halogen lamp**

for socket G4 / G6.35 / G9

	1 <b>500°C</b>		
GEV No.	359599	Ref. No.	308477 BAAN172222 BAAN304831
description	halogen lamp socket G4 12V 20W temp.-resist. 500°C		

**fluorescent lamps**

fluorescent lamps

G23

	1		
GEV No.	359933	Ref. No.	71819E
description	fluorescent lamp socket G23 L 237mm 11W 230V		

**oven lamps**

lamps

light bulbs

	<b>PHILIPS</b>		
1			
GEV No.	359610	Ref. No.	70597E
description	light bulb t.max. 300°C socket E14 15W 230V ø 22mm L 47mm lens L 20mm for oven lamp type Philips		

			
1			
GEV No.	357153	Ref. No.	70598E
description	light bulb t.max. 300°C socket E14 25W 230V ø 25mm L 55mm lens L 30mm for oven type		

			
1			
GEV No.	359614	Ref. No.	308463
description	light bulb t.max. 300°C socket E27 230V 40W ø 45mm L 71mm lens L 44mm Qty 1 pcs		



halogen lamps

for socket G4 / G6.35 / G9



<b>GEV No.</b>	359599	<b>Ref. No.</b>	308477 BAAN172222 BAAN304831
<b>description</b>	halogen lamp socket G4 12V 20W temp.-resist. 500°C		

sockets

G4 / G5,3 / G6,35



<b>GEV No.</b>	359646	<b>Ref. No.</b>	147328
<b>description</b>	lamp socket socket G4/G5.3/G6.35 24V ø 17mm H 15mm connection cable 130mm mounting distance 26mm for halogen lamp holder length 31mm cable length 130mm		

timers  
programme timers

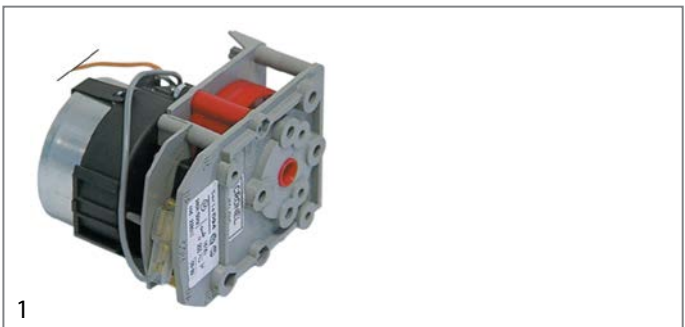

<b>GEV No.</b>	360005	<b>Ref. No.</b>	5507E
<b>description</b>	timer BIGATTI D94 engines 1 chambers 1 operation time 20min 230V shaft ømm shaft Lmm manuf. no. WE006 motor type 82354021L		



<b>GEV No.</b>	360349	<b>Ref. No.</b>	5506E
<b>description</b>	timer CDC 11803 engines 1 chambers 3 operation time 150s 230V shaft ømm shaft Lmm manuf. no. 11803F1BEE000.0010 motor type M48R ATS type 11803F1 / 238046		
<b>spare parts for</b>	360349		
	<b>GEV No.</b>	360673	<b>Ref. No.</b> —
	motor kit pinion ø 6.8mm teeth 15 230V voltage AC 50/60Hz turn direction clockwise motor ø 48mm H 18.5mm motor type UDS-40NE1RNZ165 cable length 150mm with holder		



<b>GEV No.</b>	360025	<b>Ref. No.</b>	905026 BAAN1323285 BAAN311882
<b>description</b>	timer CDC 7003F engines 1 chambers 3 operation time 360s 230V 50Hz shaft ø 6x7mm shaft L 26mm manuf. no. 7003F3 / 360025 motor type M37LN		
<b>spare parts for</b>	360025		
	<b>GEV No.</b>	360131	<b>Ref. No.</b> —
	motor CDC pinion ø 5.4mm teeth 12 230V turn direction left motor ø 37mm motor type M37LN for timer		
<b>accessories for</b>	360025		
	<b>GEV No.</b>	110085	<b>Ref. No.</b> —
	push button t.max.°C°C ø 36mm shaft ømm shaft flat grey for knob		
	<b>GEV No.</b>	110086	<b>Ref. No.</b> N/A
	knob switch zero mark t.max.°C°C ø 45mm shaft ømm shaft flat special black		
	<b>GEV No.</b>	110087	<b>Ref. No.</b> —
	retaining ring shaft ø 8mm DIN 471		

mechanical timers



<b>GEV No.</b>	360470	<b>Ref. No.</b>	645086
<b>description</b>	timer C53 2-pole operation time 120min impulse mechanical 1NO/1NC at 250V 16A permanent position yes shaft ø 6x4.6mm shaft 6x4.6mm shaft L 23mm mounting distance 28mm		

alarm devices  
buzzers

	<b>GEV No.</b>	350050	<b>Ref. No.</b>	305106
<b>description</b>	buzzer 230VAC connection male faston 6.3mm screw mounting thread M4 60dB			



contactors

LS Industrial Systems

power contactors



1			
<b>GEV No.</b>	381167	<b>Ref. No.</b>	2001137H
<b>description</b>	power contactor resistive load 20A 230VAC (AC3/400V) 9A/4kW main contacts 4NO auxiliary contacts connection screw connection type GMC-9M/4		

SIEMENS

power contactors



1			
<b>GEV No.</b>	380389	<b>Ref. No.</b>	2001923H
<b>description</b>	power contactor resistive load 22A 230VAC (AC3/400V) 9A/4kW main contacts 3NO auxiliary contacts 1NO connection screw connection type 3RT10-16-1AP01		



1			
<b>GEV No.</b>	380957	<b>Ref. No.</b>	2001138H
<b>description</b>	power contactor resistive load 22A 24VAC (AC3/400V) 12A/5.5kW main contacts 3NO auxiliary contacts 1NO connection screw connection type 3RT10-17-1AB01 50/60Hz		

TELEMECANIQUE (Schneider Electric)

power contactors



1			
<b>GEV No.</b>	380617	<b>Ref. No.</b>	1700468
<b>description</b>	power contactor resistive load 25A 24VAC (AC3/400V) 9A/4kW main contacts 3NO auxiliary contacts 1NO/1NC connection screw connection type LC1D09B7		



1			
<b>GEV No.</b>	380976	<b>Ref. No.</b>	1700732 300698
<b>description</b>	power contactor resistive load 32A 230VAC (AC3/400V) 18A/7.5kW main contacts 3NO auxiliary contacts 1NO/1NC connection screw connection		



1			
<b>GEV No.</b>	380979	<b>Ref. No.</b>	300697 300699 300760 5875E 900130 905239 905241 905686 906759 910566 BAAN1322995 BAAN169330 BAAN304436 BAANS084P20
<b>description</b>	power contactor resistive load 40A 230VAC (AC3/400V) 25A/11kW main contacts 3NO auxiliary contacts 1NO/1NC connection screw connection type LC1D25P7		



1			
<b>GEV No.</b>	380980	<b>Ref. No.</b>	300700
<b>description</b>	power contactor resistive load 50A 230VAC (AC3/400V) 32A/15kW main contacts 3NO auxiliary contacts 1NO/1NC connection screw connection type LC1D32P7		



1			
<b>GEV No.</b>	380702	<b>Ref. No.</b>	2002044H
<b>description</b>	power relays FINDER 230VAC 16A 3NO connection male faston 6.3mm flange dimensions 36x38x68mm manuf. no. 62.83.8.230.0300 230V		

## relays

### power relays

#### with bracket mounting



1			
<b>GEV No.</b>	380312	<b>Ref. No.</b>	2001867H 2001887H
<b>description</b>	power relays FINDER 230VAC 10A 3CO connection male faston 4.8mm bracket mounting dimensions 52x32.2x36.5mm manuf. no. 60.63.8.230.0000		



1			
<b>GEV No.</b>	380139	<b>Ref. No.</b>	2001873H
<b>description</b>	power relays FINDER 230VAC 16A 2CO connection F6.3 bracket mounting dimensions 68x38.2x35.8mm manuf. no. 62.82.8.230.0000		



1			
<b>GEV No.</b>	380403	<b>Ref. No.</b>	2001258H 2001873H 900073 BAAN1323154 BAAN311608
<b>description</b>	power relays FINDER 230VAC 16A 3CO connection F6.3 bracket mounting manuf. no. 62.83.8.230.0500		



1			
<b>GEV No.</b>	380185	<b>Ref. No.</b>	2001929h 300283 BAAN1027526 BAAN171090 BAAN304383
<b>description</b>	power relays Italiana Relè 230VAC 30A 1NO connection F6.3 bracket mounting dimensions 36.5x32.2x51.8mm manuf. no. A10-230AC-FA		

### relay sockets



1			
<b>GEV No.</b>	380137	<b>Ref. No.</b>	5937E
<b>description</b>	relay socket 8-pole connection plug-in connection round 8-pole dimensions 65x28x40mm 380V voltage AC 10A Italiana Relè manuf. no. ZVE8		
<b>accessories for</b>	380137		
	<b>GEV No.</b>	380805	<b>Ref. No.</b>
			—
	support bracket		





## transformers

### open transformers

#### with plug connection





			
1			
<b>GEV No.</b>	400956	<b>Ref. No.</b>	308479
<b>description</b>	transformer primary 230VAC secondary 12VAC 20VA connection male faston 6.3mm 50/60Hz type T602012/E temperature restriction 150°C ambient temperature max. 80°C		

## electronic controllers

### EVCO - EVERY CONTROL

#### universal controllers

##### built-in version

			
1			
<b>GEV No.</b>	378131	<b>Ref. No.</b>	651225 S225P20
<b>description</b>	electronic controller EVERY CONTROL EVK411M mounting measurements 71x29mm 12V voltage AC/DC NTC/PTC/Pt100/Pt1000 relay outputs 1 CO-16A(8) NTC/PTC/Pt100/Pt1000/TC(J,K)/mV/mA yes protection IP65 dependent on probe°C display 3½ digits		
<b>accessories for</b>	378131		
	<b>GEV No.</b>	<b>Ref. No.</b>	—
	temperature probe Pt100 cable Vetrotex probe -200 up to +600°C cable -50 up to +350°C probe ø6x100mm cable length 2.7m without screw connection 3-wire		
	<b>GEV No.</b>	<b>Ref. No.</b>	—
	temperature probe NTC 10kOhm cable thermoplastic probe -40 up to +110°C cable -40 up to +110°C probe ø6x14mm cable length 1.5m without screw connection 2-wire		
	<b>GEV No.</b>	<b>Ref. No.</b>	—
	temperature probe PTC 1kOhm cable thermoplastic probe -50 up to +150°C cable -40 up to +110°C probe ø6x14mm cable length 1.5m without screw connection 2-wire		
	<b>GEV No.</b>	<b>Ref. No.</b>	—
	temperature probe Pt1000 cable Vetrotex probe -70 up to +500°C cable -50 up to +350°C connection 2-wire thread probe ø6x180mm cable length 1.7m		

#### refrigeration controllers

##### built-in version











			
1			
<b>GEV No.</b>	378147	<b>Ref. No.</b>	651093
<b>description</b>	electronic controller EVERY CONTROL type EVK211N3VXBS mounting measurements 71x29mm 12/24V voltage AC/DC NTC/PTC relay outputs 1 CO-16A(5) PTC/NTC front measurementsmm built-in depth 59mm protection IP65 yes -50 up to +150°C display 3½ digits		
<b>accessories for</b>	378147		
	<b>GEV No.</b>	<b>Ref. No.</b>	—
	temperature probe PTC 1kOhm cable PVC probe -50 up to +150°C cable -10 up to 100°C probe ø6x30mm cable length 3m without screw connection 2-wire		
	<b>GEV No.</b>	<b>Ref. No.</b>	—
	temperature probe PTC 1kOhm cable silicone probe -50 up to +150°C cable -50 up to +180°C probe ø6x40mm cable length 3m without screw connection 2-wire		
	<b>GEV No.</b>	<b>Ref. No.</b>	—
	temperature probe NTC 10kOhm cable thermoplastic probe -40 up to +110°C cable -40 up to +110°C probe ø6x14mm cable length 3m without screw connection 2-wire		
	<b>GEV No.</b>	<b>Ref. No.</b>	—
	temperature probe PTC 1kOhm cable thermoplastic probe -50 up to +150°C cable -40 up to +110°C probe ø6x14mm cable length 3m 2-wire resistor 1kOhm		
			
1			
<b>GEV No.</b>	378153	<b>Ref. No.</b>	651094 BAAN171256 S094P20
<b>description</b>	electronic controller EVERY CONTROL type EVK213N3VXBS mounting measurements 71x29mm 12/24V voltage AC/DC NTC/PTC relay outputs 3 NO-16A(5) CO-8A(4) NO-8A(4) NTC/PTC NTC/PTC DI front measurementsmm built-in depth 59mm protection IP65 yes -50 up to +150°C display 3½ digits		
<b>accessories for</b>	378153		
	<b>GEV No.</b>	<b>Ref. No.</b>	—
	temperature probe PTC 1kOhm cable PVC probe -50 up to +150°C cable -10 up to 100°C probe ø6x30mm cable length 3m without screw connection 2-wire		
	<b>GEV No.</b>	<b>Ref. No.</b>	—
	temperature probe PTC 1kOhm cable silicone probe -50 up to +150°C cable -50 up to +180°C probe ø6x40mm cable length 3m without screw connection 2-wire		
	<b>GEV No.</b>	<b>Ref. No.</b>	—
	temperature probe NTC 10kOhm cable thermoplastic probe -40 up to +110°C cable -40 up to +110°C probe ø6x14mm cable length 3m without screw connection 2-wire		
	<b>GEV No.</b>	<b>Ref. No.</b>	—
	temperature probe PTC 1kOhm cable thermoplastic probe -50 up to +150°C cable -40 up to +110°C probe ø6x14mm cable length 3m 2-wire resistor 1kOhm		



Image not available

1

<b>GEV No.</b>	379503	<b>Ref. No.</b>	1051059 BAANS094PB70
<b>description</b>	electronic controller kit		

## LOREME

## analogue



1

<b>GEV No.</b>	379745	<b>Ref. No.</b>	72098E BAAN309861
<b>description</b>	electronic controller kit LOREME type Dsl 94 mounting measurements 66x32mm 230V voltage AC TC/J 0-250°C display without display relay outputs 2 front measurements 70x34mm built-in depth 95mm cable length 2530mm probe L 20mm probe ø 4mm with probe and fastening material		
<b>spare parts for</b>	379745		
	<b>GEV No.</b>	379744	<b>Ref. No.</b> —
	electronic controller LOREME type Dsl 94 mounting measurements 66x32mm 230V voltage AC TC/J 0-250°C display without display relay outputs 2 front measurements 70x34mm built-in depth 95mm		

## probes

## universal probes

## temperature probes



1

<b>GEV No.</b>	379142	<b>Ref. No.</b>	651184
<b>description</b>	temperature probe PTC 1kOhm cable PVC probe -50 up to +150°C cable -10 up to 100°C probe ø6x30mm cable length 1.5m without screw connection 2-wire		



1

<b>GEV No.</b>	378070	<b>Ref. No.</b>	751775 BAANS194P20
<b>description</b>	temperature probe PTC 1kOhm cable silicone probe -50 up to +150°C cable -50 up to +180°C probe ø6x40mm cable length 30m without screw connection 2-wire		

## producer-specific probes

## probes



1

<b>GEV No.</b>	400910	<b>Ref. No.</b>	2001913H 2002264H 6046E
<b>description</b>	temperature probe NTC 10kOhm cable silicone probe -40 up to +110°C cable -50 up to +180°C connection coded plug thread probe ø4.5x30mm cable length 0.35m		

## electronics

## PCBs



1

<b>GEV No.</b>	400898	<b>Ref. No.</b>	2002432H
<b>description</b>	keypad PCB dishwasher LP10/20/30 with display		
<b>accessories for</b>	400898		
	<b>GEV No.</b>	402970	<b>Ref. No.</b> 2001927H BAAN1027510 BAAN1321548
	ribbon cable 10-pole L 1200mm plug type 2 row coded Qty 1m		



1







<b>GEV No.</b>	403093	<b>Ref. No.</b>	2002140H BAAN1158403 BAAN1321724
<b>description</b>	PCB dishwasher L 135mm W 82mm		

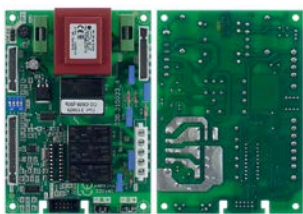

1

<b>GEV No.</b>	403572	<b>Ref. No.</b>	2002141H 2002541H
<b>description</b>	PCB dishwasher Protech 1113/611 TR10 L 178mm W 125mm		



			
1			
<b>GEV No.</b>	400899	<b>Ref. No.</b>	2001914H
<b>description</b>	power PCB dishwasher LP10/20/30 without EPROM		
<b>accessories for</b>	400899		
	<b>GEV No.</b>	400761	<b>Ref. No.</b> —
	plug connector 5-pole		
	<b>GEV No.</b>	400900	<b>Ref. No.</b> —
	EPROM CODE 225029-3		
	<b>GEV No.</b>	401558	<b>Ref. No.</b> —
	EPROM CODE 81000-1		
	<b>GEV No.</b>	403241	<b>Ref. No.</b> —
	EPROM type U61E for dishwasher CODE 81001-3		
	<b>GEV No.</b>	550048	<b>Ref. No.</b> —
	female bullet		

## solenoid valves

### solenoid valves (water)

			
1			
<b>GEV No.</b>	373020	<b>Ref. No.</b>	241447
<b>description</b>	solenoid valve double angled 230VAC inlet 3/4" outlet 14mm input 10l/min DN10 t.max. 90°C duty cycle 100% ELBI flow regulating valve inlet white		

			
1			
<b>GEV No.</b>	370357	<b>Ref. No.</b>	3697E
<b>description</b>	solenoid valve double straight 230VAC inlet 3/4" outlet 11.5mm plastic flow regulating valve outlet A 0.25		

## ROBERTSHAW/INVENSYS

medium temperature: 90°C 90°C 60°C  
 ambient temperature: 60°C 25°C 60°C  
 duty cycle: 40% 100% 100%

			
1			
<b>GEV No.</b>	372017	<b>Ref. No.</b>	144937 BAAN171061 BAAN302233
<b>description</b>	solenoid valve single straight 230VAC inlet 3/4" outlet 11.5mm DN10 EATON (INVENSYS)		



















			
1			
<b>GEV No.</b>	370021	<b>Ref. No.</b>	1700434 3697E BAAN1320666 BAAN302969
<b>description</b>	solenoid valve double straight 230VAC inlet 3/4" outlet 11.5mm DN10 TP flow regulating valve inlet white		
<b>spare parts for</b>	370021		
	<b>GEV No.</b>	371013	<b>Ref. No.</b> —
	solenoid coil TP 230VAC 50/60Hz		
<b>accessories for</b>	370021		
	<b>GEV No.</b>	371220	<b>Ref. No.</b> —
	reducer TP flow rate 3l/min red tolerance ±15%		
	<b>GEV No.</b>	371221	<b>Ref. No.</b> —
	reducer TP flow rate 5.5l/min yellow tolerance ±15%		
	<b>GEV No.</b>	371222	<b>Ref. No.</b> —
	reducer TP flow rate 6l/min grey tolerance ±15%		
	<b>GEV No.</b>	371223	<b>Ref. No.</b> —
	reducer TP flow rate 10l/min white tolerance ±15%		
	<b>GEV No.</b>	371224	<b>Ref. No.</b> —
	reducer TP flow rate 12l/min bronze tolerance ±15%		
	<b>GEV No.</b>	371225	<b>Ref. No.</b> —
	reducer TP flow rate 16l/min light brown tolerance ±15%		
	<b>GEV No.</b>	371226	<b>Ref. No.</b> —
	reducer TP flow rate 20l/min red tolerance ±15%		
	<b>GEV No.</b>	371230	<b>Ref. No.</b> —
	reducer TP flow rate 0.25l/min red tolerance ±25%		

Table continues overleaf

accessories for		370021		
	GEV No.	371231	Ref. No.	—
reducer TP flow rate 0.35l/min violet tolerance ±25%				
	GEV No.	371232	Ref. No.	—
reducer TP flow rate 0.5l/min orange tolerance ±25%				
	GEV No.	371233	Ref. No.	—
reducer TP flow rate 0.8l/min white tolerance ±25%				
	GEV No.	371234	Ref. No.	—
reducer TP flow rate 1l/min light blue tolerance ±25%				
	GEV No.	371235	Ref. No.	—
reducer TP flow rate 1.2l/min brown tolerance ±25%				
	GEV No.	371236	Ref. No.	—
reducer TP flow rate 1.5l/min light brown tolerance ±25%				
	GEV No.	371237	Ref. No.	—
reducer TP flow rate 2.5l/min yellow tolerance ±25%				
	GEV No.	371238	Ref. No.	—
reducer TP flow rate 3.4l/min dark green tolerance ±25%				
	GEV No.	371239	Ref. No.	—
reducer TP flow rate 5l/min black tolerance ±25%				
	GEV No.	371240	Ref. No.	—
reducer TP flow rate 8l/min blue tolerance ±20%				

 				
<b>GEV No.</b>	370017	<b>Ref. No.</b>	634084	
<b>description</b>	solenoid valve single straight 230VAC inlet 3/4" outlet 11.5mm DN10 TP p max 10bar			
<b>spare parts for</b>	370017			
	GEV No.	371013	Ref. No.	—
solenoid coil TP 230VAC 50/60Hz				
<b>accessories for</b>	370017			
	GEV No.	371220	Ref. No.	—
reducer TP flow rate 3l/min red tolerance ±15%				
	GEV No.	371221	Ref. No.	—
reducer TP flow rate 5.5l/min yellow tolerance ±15%				
	GEV No.	371222	Ref. No.	—
reducer TP flow rate 6l/min grey tolerance ±15%				
	GEV No.	371223	Ref. No.	—
reducer TP flow rate 10l/min white tolerance ±15%				
	GEV No.	371224	Ref. No.	—
reducer TP flow rate 12l/min bronze tolerance ±15%				

accessories for		370017		
	GEV No.	371225	Ref. No.	—
reducer TP flow rate 16l/min light brown tolerance ±15%				
	GEV No.	371226	Ref. No.	—
reducer TP flow rate 20l/min red tolerance ±15%				
	GEV No.	371230	Ref. No.	—
reducer TP flow rate 0.25l/min red tolerance ±25%				
	GEV No.	371231	Ref. No.	—
reducer TP flow rate 0.35l/min violet tolerance ±25%				
	GEV No.	371232	Ref. No.	—
reducer TP flow rate 0.5l/min orange tolerance ±25%				
	GEV No.	371233	Ref. No.	—
reducer TP flow rate 0.8l/min white tolerance ±25%				
	GEV No.	371234	Ref. No.	—
reducer TP flow rate 1l/min light blue tolerance ±25%				
	GEV No.	371235	Ref. No.	—
reducer TP flow rate 1.2l/min brown tolerance ±25%				
	GEV No.	371236	Ref. No.	—
reducer TP flow rate 1.5l/min light brown tolerance ±25%				
	GEV No.	371237	Ref. No.	—
reducer TP flow rate 2.5l/min yellow tolerance ±25%				
	GEV No.	371238	Ref. No.	—
reducer TP flow rate 3.4l/min dark green tolerance ±25%				
	GEV No.	371239	Ref. No.	—
reducer TP flow rate 5l/min black tolerance ±25%				
	GEV No.	371240	Ref. No.	—
reducer TP flow rate 8l/min blue tolerance ±20%				





















 				
<b>GEV No.</b>	370018	<b>Ref. No.</b>	904693	
<b>description</b>	solenoid valve single straight 230VAC inlet 3/4" outlet 14mm DN10 TP			
<b>spare parts for</b>	370018			
	GEV No.	371013	Ref. No.	—
solenoid coil TP 230VAC 50/60Hz				
<b>accessories for</b>	370018			
	GEV No.	371220	Ref. No.	—
reducer TP flow rate 3l/min red tolerance ±15%				





Table continues overleaf





accessories for		370018		
GEV No.		371221	Ref. No.	—
	reducer TP flow rate 5.5l/min yellow tolerance ±15%			
	reducer TP flow rate 6l/min grey tolerance ±15%			
	reducer TP flow rate 10l/min white tolerance ±15%			
	reducer TP flow rate 12l/min bronze tolerance ±15%			
	reducer TP flow rate 16l/min light brown tolerance ±15%			
	reducer TP flow rate 20l/min red tolerance ±15%			
	reducer TP flow rate 0.25l/min red tolerance ±25%			
	reducer TP flow rate 0.35l/min violet tolerance ±25%			
	reducer TP flow rate 0.5l/min orange tolerance ±25%			
	reducer TP flow rate 0.8l/min white tolerance ±25%			
	reducer TP flow rate 1l/min light blue tolerance ±25%			
	reducer TP flow rate 1.2l/min brown tolerance ±25%			
	reducer TP flow rate 1.5l/min light brown tolerance ±25%			
	reducer TP flow rate 2.5l/min yellow tolerance ±25%			
	reducer TP flow rate 3.4l/min dark green tolerance ±25%			
	reducer TP flow rate 5l/min black tolerance ±25%			
	reducer TP flow rate 8l/min blue tolerance ±20%			

  1			
GEV No.	370025	Ref. No.	314345 3664E BAAN305607
<b>description</b>	solenoid valve triple straight 230VAC inlet 3/4" outlet 11.5mm DN10 TP		
<b>spare parts for</b>	370025		
	GEV No.	371013	Ref. No. —
	solenoid coil TP 230VAC 50/60Hz		
<b>accessories for</b>	370025		
	GEV No.	371220	Ref. No. —
	reducer TP flow rate 3l/min red tolerance ±15%		
	GEV No.	371221	Ref. No. —
	reducer TP flow rate 5.5l/min yellow tolerance ±15%		
	GEV No.	371222	Ref. No. —
	reducer TP flow rate 6l/min grey tolerance ±15%		
	GEV No.	371223	Ref. No. —
	reducer TP flow rate 10l/min white tolerance ±15%		
	GEV No.	371224	Ref. No. —
	reducer TP flow rate 12l/min bronze tolerance ±15%		
	GEV No.	371225	Ref. No. —
	reducer TP flow rate 16l/min light brown tolerance ±15%		
	GEV No.	371226	Ref. No. —
	reducer TP flow rate 20l/min red tolerance ±15%		
	GEV No.	371230	Ref. No. —
	reducer TP flow rate 0.25l/min red tolerance ±25%		
	GEV No.	371231	Ref. No. —
	reducer TP flow rate 0.35l/min violet tolerance ±25%		
	GEV No.	371232	Ref. No. —
	reducer TP flow rate 0.5l/min orange tolerance ±25%		
	GEV No.	371233	Ref. No. —
	reducer TP flow rate 0.8l/min white tolerance ±25%		
	GEV No.	371234	Ref. No. —
	reducer TP flow rate 1l/min light blue tolerance ±25%		
	GEV No.	371235	Ref. No. —
	reducer TP flow rate 1.2l/min brown tolerance ±25%		
	GEV No.	371236	Ref. No. —
	reducer TP flow rate 1.5l/min light brown tolerance ±25%		

Table continues overleaf

accessories for 370025				
	GEV No.	371237	Ref. No.	—
reducer TP flow rate 2.5l/min yellow tolerance ±25%				
	GEV No.	371238	Ref. No.	—
reducer TP flow rate 3.4l/min dark green tolerance ±25%				
	GEV No.	371239	Ref. No.	—
reducer TP flow rate 5l/min black tolerance ±25%				
	GEV No.	371240	Ref. No.	—
reducer TP flow rate 8l/min blue tolerance ±20%				

  <p>1</p>				
GEV No.	370020	Ref. No.	914123	
description	solenoid valve double angled 230VAC inlet 3/4" outlet 14mm DN10 TP			
spare parts for	370020			
	GEV No.	371013	Ref. No.	—
solenoid coil TP 230VAC 50/60Hz				
accessories for 370020				
	GEV No.	371220	Ref. No.	—
reducer TP flow rate 3l/min red tolerance ±15%				
	GEV No.	371221	Ref. No.	—
reducer TP flow rate 5.5l/min yellow tolerance ±15%				
	GEV No.	371222	Ref. No.	—
reducer TP flow rate 6l/min grey tolerance ±15%				
	GEV No.	371223	Ref. No.	—
reducer TP flow rate 10l/min white tolerance ±15%				
	GEV No.	371224	Ref. No.	—
reducer TP flow rate 12l/min bronze tolerance ±15%				
	GEV No.	371225	Ref. No.	—
reducer TP flow rate 16l/min light brown tolerance ±15%				
	GEV No.	371226	Ref. No.	—
reducer TP flow rate 20l/min red tolerance ±15%				
	GEV No.	371230	Ref. No.	—
reducer TP flow rate 0.25l/min red tolerance ±25%				
	GEV No.	371231	Ref. No.	—
reducer TP flow rate 0.35l/min violet tolerance ±25%				
	GEV No.	371232	Ref. No.	—
reducer TP flow rate 0.5l/min orange tolerance ±25%				

accessories for 370020				
	GEV No.	371233	Ref. No.	—
reducer TP flow rate 0.8l/min white tolerance ±25%				
	GEV No.	371234	Ref. No.	—
reducer TP flow rate 1l/min light blue tolerance ±25%				
	GEV No.	371235	Ref. No.	—
reducer TP flow rate 1.2l/min brown tolerance ±25%				
	GEV No.	371236	Ref. No.	—
reducer TP flow rate 1.5l/min light brown tolerance ±25%				
	GEV No.	371237	Ref. No.	—
reducer TP flow rate 2.5l/min yellow tolerance ±25%				
	GEV No.	371238	Ref. No.	—
reducer TP flow rate 3.4l/min dark green tolerance ±25%				
	GEV No.	371239	Ref. No.	—
reducer TP flow rate 5l/min black tolerance ±25%				
	GEV No.	371240	Ref. No.	—
reducer TP flow rate 8l/min blue tolerance ±20%				











































  <p>1</p>				
GEV No.	370015	Ref. No.	634085	
description	solenoid valve single angled 230VAC inlet 3/4" outlet 11.5mm DN10 TP			
accessories for	370015			
	GEV No.	371220	Ref. No.	—
reducer TP flow rate 3l/min red tolerance ±15%				
	GEV No.	371221	Ref. No.	—
reducer TP flow rate 5.5l/min yellow tolerance ±15%				
	GEV No.	371222	Ref. No.	—
reducer TP flow rate 6l/min grey tolerance ±15%				
	GEV No.	371223	Ref. No.	—
reducer TP flow rate 10l/min white tolerance ±15%				
	GEV No.	371224	Ref. No.	—
reducer TP flow rate 12l/min bronze tolerance ±15%				
	GEV No.	371225	Ref. No.	—
reducer TP flow rate 16l/min light brown tolerance ±15%				
	GEV No.	371226	Ref. No.	—
reducer TP flow rate 20l/min red tolerance ±15%				
	GEV No.	371230	Ref. No.	—
reducer TP flow rate 0.25l/min red tolerance ±25%				

Table continues overleaf



accessories for		370015		
	GEV No.	371231	Ref. No.	—
reducer TP flow rate 0.35l/min violet tolerance ±25%				
	GEV No.	371232	Ref. No.	—
reducer TP flow rate 0.5l/min orange tolerance ±25%				
	GEV No.	371233	Ref. No.	—
reducer TP flow rate 0.8l/min white tolerance ±25%				
	GEV No.	371234	Ref. No.	—
reducer TP flow rate 1l/min light blue tolerance ±25%				
	GEV No.	371235	Ref. No.	—
reducer TP flow rate 1.2l/min brown tolerance ±25%				
	GEV No.	371236	Ref. No.	—
reducer TP flow rate 1.5l/min light brown tolerance ±25%				
	GEV No.	371237	Ref. No.	—
reducer TP flow rate 2.5l/min yellow tolerance ±25%				
	GEV No.	371238	Ref. No.	—
reducer TP flow rate 3.4l/min dark green tolerance ±25%				
	GEV No.	371239	Ref. No.	—
reducer TP flow rate 5l/min black tolerance ±25%				
	GEV No.	371240	Ref. No.	—
reducer TP flow rate 8l/min blue tolerance ±20%				

  <p>1</p>				
<b>GEV No.</b>	370016	<b>Ref. No.</b>	23458	
<b>description</b>	solenoid valve single angled 230VAC inlet 3/4" outlet 14mm DN10 TP			
<b>spare parts for</b>	370016			
	GEV No.	371013	Ref. No.	—
solenoid coil TP 230VAC 50/60Hz				
<b>accessories for</b>	370016			
	GEV No.	371220	Ref. No.	—
reducer TP flow rate 3l/min red tolerance ±15%				
	GEV No.	371221	Ref. No.	—
reducer TP flow rate 5.5l/min yellow tolerance ±15%				
	GEV No.	371222	Ref. No.	—
reducer TP flow rate 6l/min grey tolerance ±15%				
	GEV No.	371223	Ref. No.	—
reducer TP flow rate 10l/min white tolerance ±15%				
	GEV No.	371224	Ref. No.	—
reducer TP flow rate 12l/min bronze tolerance ±15%				

accessories for		370016		
	GEV No.	371225	Ref. No.	—
reducer TP flow rate 16l/min light brown tolerance ±15%				
	GEV No.	371226	Ref. No.	—
reducer TP flow rate 20l/min red tolerance ±15%				
	GEV No.	371230	Ref. No.	—
reducer TP flow rate 0.25l/min red tolerance ±25%				
	GEV No.	371231	Ref. No.	—
reducer TP flow rate 0.35l/min violet tolerance ±25%				
	GEV No.	371232	Ref. No.	—
reducer TP flow rate 0.5l/min orange tolerance ±25%				
	GEV No.	371233	Ref. No.	—
reducer TP flow rate 0.8l/min white tolerance ±25%				
	GEV No.	371234	Ref. No.	—
reducer TP flow rate 1l/min light blue tolerance ±25%				
	GEV No.	371235	Ref. No.	—
reducer TP flow rate 1.2l/min brown tolerance ±25%				
	GEV No.	371236	Ref. No.	—
reducer TP flow rate 1.5l/min light brown tolerance ±25%				
	GEV No.	371237	Ref. No.	—
reducer TP flow rate 2.5l/min yellow tolerance ±25%				
	GEV No.	371238	Ref. No.	—
reducer TP flow rate 3.4l/min dark green tolerance ±25%				
	GEV No.	371239	Ref. No.	—
reducer TP flow rate 5l/min black tolerance ±25%				
	GEV No.	371240	Ref. No.	—
reducer TP flow rate 8l/min blue tolerance ±20%				
	GEV No.	503139	Ref. No.	—
solenoid valve filter ø 19.5mm H 16mm				



  <p>1</p>				
<b>GEV No.</b>	370024	<b>Ref. No.</b>	634089	
<b>description</b>	solenoid valve triple angled 230VAC inlet 3/4" outlet 14mm DN10 TP			
<b>spare parts for</b>	370024			
	GEV No.	371013	Ref. No.	—
solenoid coil TP 230VAC 50/60Hz				

Table continues overleaf

accessories for		370024	
	GEV No.	371220	Ref. No. —
reducer TP flow rate 3l/min red tolerance ±15%			
	GEV No.	371221	Ref. No. —
reducer TP flow rate 5.5l/min yellow tolerance ±15%			
	GEV No.	371222	Ref. No. —
reducer TP flow rate 6l/min grey tolerance ±15%			
	GEV No.	371223	Ref. No. —
reducer TP flow rate 10l/min white tolerance ±15%			
	GEV No.	371224	Ref. No. —
reducer TP flow rate 12l/min bronze tolerance ±15%			
	GEV No.	371225	Ref. No. —
reducer TP flow rate 16l/min light brown tolerance ±15%			
	GEV No.	371226	Ref. No. —
reducer TP flow rate 20l/min red tolerance ±15%			
	GEV No.	371230	Ref. No. —
reducer TP flow rate 0.25l/min red tolerance ±25%			
	GEV No.	371231	Ref. No. —
reducer TP flow rate 0.35l/min violet tolerance ±25%			
	GEV No.	371232	Ref. No. —
reducer TP flow rate 0.5l/min orange tolerance ±25%			
	GEV No.	371233	Ref. No. —
reducer TP flow rate 0.8l/min white tolerance ±25%			
	GEV No.	371234	Ref. No. —
reducer TP flow rate 1l/min light blue tolerance ±25%			
	GEV No.	371235	Ref. No. —
reducer TP flow rate 1.2l/min brown tolerance ±25%			
	GEV No.	371236	Ref. No. —
reducer TP flow rate 1.5l/min light brown tolerance ±25%			
	GEV No.	371237	Ref. No. —
reducer TP flow rate 2.5l/min yellow tolerance ±25%			
	GEV No.	371238	Ref. No. —
reducer TP flow rate 3.4l/min dark green tolerance ±25%			
	GEV No.	371239	Ref. No. —
reducer TP flow rate 5l/min black tolerance ±25%			
	GEV No.	371240	Ref. No. —
reducer TP flow rate 8l/min blue tolerance ±20%			

solenoid valves with reducers



<b>GEV No.</b>	370255	<b>Ref. No.</b>	914135
<b>description</b>	solenoid valve triple angled 230VAC inlet 3/4" outlet 11.5mm plastic		



<b>GEV No.</b>	370250	<b>Ref. No.</b>	147723
<b>description</b>	solenoid valve triple straight 230VAC inlet 3/4" outlet 11.5mm t.max. 90°C TP plastic output B 0.25l/min flow regulating valve outlet B red		

various



<b>GEV No.</b>	370726	<b>Ref. No.</b>	2002183H BAAN1191877 BAAN1321764
<b>description</b>	solenoid valve double straight 220-240VAC inlet 11mm outlet 11mm MILANO plastic output B red		

metal

ASCO

spare parts and accessories

O-rings



<b>GEV No.</b>	371095	<b>Ref. No.</b>	2001374H BAAN1121434 BAAN1321069
<b>description</b>	O-ring Viton thickness 1.78mm ID ø 6.07mm Qty 1 pcs		





solenoid valves (various)



1

<b>GEV No.</b>	370665	<b>Ref. No.</b>	1049474 BAANSB10018
<b>description</b>	solenoid valve 2-ways 24VAC inlet 1/8" outlet 1/8" connection male faston 6.3mm L 31mm Olab type series 6000-9000 coil type 6000BH/B1-FN 50/60Hz brass		

drain valves



1

<b>GEV No.</b>	371107	<b>Ref. No.</b>	2000039
<b>description</b>	drain valve 24V 50/60Hz single inlet 50mm outlet 50mm		

Solenoid valve - accessories



1

<b>GEV No.</b>	371095	<b>Ref. No.</b>	2001374H BAAN1121434 BAAN1321069
<b>description</b>	O-ring Viton thickness 1.78mm ID ø 6.07mm Qty 1 pcs		

ball valves electric



1

<b>GEV No.</b>	401190	<b>Ref. No.</b>	314359
<b>description</b>	ball valve inlet 3/4" IT outlet 3/4" IT IP42 230V L 68mm 50/60Hz closed off-current mode of operation electric connection cable 300mm 3.5W duty cycle 50%		

pressure switches

for warewashing

ø 58mm with male faston 6.3mm

with connection horizontal



1

<b>GEV No.</b>	541002	<b>Ref. No.</b>	2001959H 3682E BAAN1321578 BAAN305626
<b>description</b>	pressure control pressure range 110/60mbar connection 6mm ø 58mm pressure connection horizontal warewashing pressure connection ø 6mm		



1

<b>GEV No.</b>	541105	<b>Ref. No.</b>	2001546H 5915E
<b>description</b>	pressure control pressure range 180/70mbar connection 6mm ø 58mm pressure connection horizontal warewashing		



1

<b>GEV No.</b>	541039	<b>Ref. No.</b>	2002189h
<b>description</b>	pressure control pressure range 45/25mbar connection 6mm ø 58mm pressure connection horizontal warewashing		





1

<b>GEV No.</b>	541013	<b>Ref. No.</b>	5849E BAAN1322979 BAAN307872
<b>description</b>	pressure control pressure range 55/25mbar connection 6mm ø 58mm pressure connection horizontal warewashing		



			
1			
<b>GEV No.</b>	541003	<b>Ref. No.</b>	5627E
<b>description</b>	pressure control pressure range 55/35mbar connection 6mm ø 58mm pressure connection horizontal warewashing pressure connection ø 6mm		

			
1			
<b>GEV No.</b>	541165	<b>Ref. No.</b>	901300
<b>description</b>	pressure control pressure range 60/30mbar connection 6mm ø 58mm pressure connection horizontal warewashing pressure connection ø 6mm		

			
1			
<b>GEV No.</b>	541017	<b>Ref. No.</b>	901300 BAAN1323202 BAAN311635
<b>description</b>	pressure control with mounting strap pressure range 40/20mbar connection 6mm ø 58mm pressure connection horizontal warewashing		

## compressors

### CUBIGEL

R404a/R507

HMBP monophase

High/Medium evaporation temperature above -20/-15 °C

			
1			
<b>GEV No.</b>	605029	<b>Ref. No.</b>	653185
<b>description</b>	compressor coolant R404a/R507 type MP12RB 220-240V 50Hz HMBP fully hermetic 13.5kg 1/2HP cylinder capacity 12cm <sup>3</sup> CSR H 203.6mmW 561W 734W 933W 1157W 1407W 1681W 1982WW test method ASHRAE ambient temperature max. 43°C		

## fans



### axial fans

#### ebm-papst

				
1				
<b>GEV No.</b>	601030 <sup>1</sup>	<b>Ref. No.</b>	780002656	
<b>description</b>	axial fan L 119mm W 119mm H 38mm 230VAC 50Hz 18W bearing ball bearing manuf. no. 4656Z metal connection male faston 2.8mm ebm-papst fan wheel ø 110mm temp.-resist. 75°C			
<b>accessories for</b>	601030			
	<b>GEV No.</b>	550898	<b>Ref. No.</b>	—
	connecting cable cable length 2000mm connection F 2.8 connection distance 7.9mm for axial flow fan			
	<b>GEV No.</b>	692497	<b>Ref. No.</b>	—
	guard ø 105mm mounting distance 150mm for axial fan ebm-papst-mm			

<sup>1</sup>with ball bearings

#### import

				
1				
<b>GEV No.</b>	601080 <sup>1</sup>	<b>Ref. No.</b>	304194 780002656 906107 BAAN167195 BAAN312100	
<b>description</b>	axial fan L 119mm W 119mm H 38mm 230VAC 50/60Hz 23/20W bearing ball bearing connection male faston 2.8mm metal ADDA fan wheel ø 110mm temp.-resist. 70°C			
<b>accessories for</b>	601080			
	<b>GEV No.</b>	550898	<b>Ref. No.</b>	—
	connecting cable cable length 2000mm connection F 2.8 connection distance 7.9mm for axial flow fan			
	<b>GEV No.</b>	692519	<b>Ref. No.</b>	—
	guard L 120mm W 120mm plastic			

<sup>1</sup>with ball bearings

refrigeration fans

refrigeration motors universal

ELCO

N series - multi fit



1

<b>GEV No.</b>	601430	<b>Ref. No.</b>	2010063 BAAN1054982 S158P15
<b>description</b>	fan motor ELCO 5W 230V 50/60Hz bearing slide bearing L1 48mm L2 52mm L3 79.5mm W 83mm connection cable 500mm 1300/1550rpm 5 mounting options VNT5-13/027		
<b>spare parts for</b>	601430		
	<b>GEV No.</b>	560140	<b>Ref. No.</b> —
	hexagonal nut thread M4 H 4.8mm SS WS 7 Qty 20 pcs DIN/ISO DIN 985 self-locking		
	<b>GEV No.</b>	560332	<b>Ref. No.</b> —
	plain washer ID ø 4.3mm ED ø 9mm thickness 0.8mm SS Qty 1 pcs		
	<b>GEV No.</b>	560340	<b>Ref. No.</b> —
	hexagonal nut thread M4 H 3.2mm WS 7 SS DIN/ISO DIN 934 / ISO 4032/8673 Qty 1 pcs		
	<b>GEV No.</b>	601413	<b>Ref. No.</b> —
	fixing plate suitable for fanwheel ED ø 32mm shaft ø 7 mounting distance 26mm		

cooling motors (complete)



1

<b>GEV No.</b>	601280	<b>Ref. No.</b>	N/A
<b>description</b>	fan 230V 5W 50/60Hz fan wheel ø 172mm		
<b>spare parts for</b>	601280		
	<b>GEV No.</b>	601020	<b>Ref. No.</b> —
	fan motor 5W 230V 50-60Hz L1 44mm L2 48mm L3 79mm W 84mm cable length 500mm 1300rpm YZF5-13-18/26 5 mounting options bearing slide bearing		
	<b>GEV No.</b>	601069	<b>Ref. No.</b> —
	fan wheel sucking ø 172mm turn direction left fan wheel mounting 25.4mm blade angle 25° W 32mm aluminium		

cross flow fans

COPREL

with standard coil



1

<b>GEV No.</b>	602060	<b>Ref. No.</b>	304229
<b>description</b>	cross flow fan COPREL FFR roller ø 60mm roller length 240mm laminated core thickness 20mm motor position right 230V/50-60Hz 33W universal bearing silicone connection male faston 6.3mm airflow 149m³/h -10 up to +60°C		

cross flow fan with heater battery

roller diameter ø60mm



1

<b>GEV No.</b>	601027	<b>Ref. No.</b>	135557 304237 BAAN171121 BAAN304749
<b>description</b>	cross flow fan roller length 180mm roller ø 60mm motor position right 230V 50Hz 17W heat output 2000W bearing silicone cable length 200mm with temperature limiter 125°C		
<b>spare parts for</b>	601027		
	<b>GEV No.</b>	375095	<b>Ref. No.</b> —
	bi-metal thermostat hole distance 18mm switch-off temp. 105°C 1NC 1-pole 16A connection F6.3 2 hole fixing		
	<b>GEV No.</b>	375911	<b>Ref. No.</b> —
	bi-metal thermostat switch-off temp. 125°C 1NC 1-pole for cross flow fan		

hot air motors

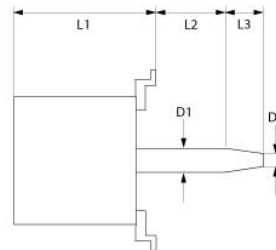

1

<b>GEV No.</b>	500812	<b>Ref. No.</b>	71251E
<b>description</b>	fan motor 220-240/380-415V 3 phase 50Hz 0.26kW 1440rpm speeds 1 D1 ø 17mm D2 ø 13.5mm		

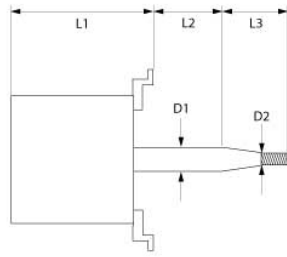

1

<b>GEV No.</b>	499206	<b>Ref. No.</b>	304267 BAAN1050261 BAAN1051644
<b>description</b>	fan motor 230/400V 3 phase 50/60Hz 0.12kW 1400/1700rpm speeds 2 L1 145mm L2 30mm L3 25mm D1 ø 17mm D2 ø 14mm M6 1.2/0.7A suitable capacitor 16µF/450V Cos(fi) 0.53 type 1079TH		

hot air fans

ebm-papst



1

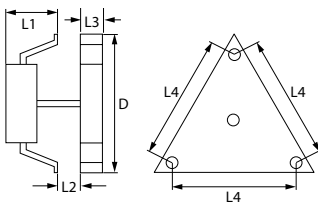

<b>GEV No.</b>	601267	<b>Ref. No.</b>	645457
<b>description</b>	hot air fan 230V 32W 0.27A L1 60mm L2 50mm L3 20mm L4 157mm fan wheel ø 150mm ebm-papst type R2K150-0020A9		

motors

gear motors

for dishwashers



1

<b>GEV No.</b>	601861	<b>Ref. No.</b>	2001419H BAAN1121764 BAAN1321110
<b>description</b>	gear motor FIR type 71-B5 180W 400V voltage AC 50/60Hz 3 phase 900/1100rpm shaft ø 14mm L 227mm for transport system without gearbox		

pumps

wash and rinse pumps

FIR

pumps



1







<b>GEV No.</b>	499079	<b>Ref. No.</b>	5519E	
<b>description</b>	pump inlet ø 28mm outlet ø 26mm type 2211.1610 220-240V 50Hz 1 phase 0.07kW 0.1HP rotation direction left capacitor 5µF FIR			
<b>spare parts for</b>	499079			
	<b>GEV No.</b>	365017	<b>Ref. No.</b>	2000001 304269
	operating capacitor capacity 5µF 450V tolerance 5% 50/60Hz ambient temperature max. -25 to +85°C ø 28mm L 54mm M8 plastic connection male faston 6.3mm 16.10.08 protection			
	<b>GEV No.</b>	510384	<b>Ref. No.</b>	—
	pump cover inlet ø 28mm outlet ø 26mm ø 100mm ID ø 76mm			
	<b>GEV No.</b>	510695	<b>Ref. No.</b>	—
	mechanical shaft seal height counter ring 5.5mm ID ø 11mm			
	<b>GEV No.</b>	521203	<b>Ref. No.</b>	—
	impellor ø 72mm H 18mm thread M7 shaft ø 11mm shaft length 32mm blades 3			



Table continues overleaf



<b>spare parts for</b> 499079				
	GEV No.	521703	Ref. No.	—
pump cover gasket EPDM thickness 2.5mm ID ø 75mm Qty 1 pcs				









1				
<b>GEV No.</b>	502287	<b>Ref. No.</b>	2001420H 904562	
<b>description</b>	pump inlet ø 30mm outlet ø 26mm type 5213.4050 230/400V 50Hz 3 phase 0.11kW 0.15HP L 200mm rotation direction left			
<b>spare parts for</b> 502287				
	GEV No.	699372	Ref. No.	—
flange for pump with cover type 5213 L 103mm W 103mm H 69mm				







1				
<b>GEV No.</b>	500598	<b>Ref. No.</b>	904135 904156 BAAN1020463 BAAN1323244	
<b>description</b>	pump inlet ø 30mm outlet ø 26mm type 5213E2450 230V 50Hz 1 phase 0.22kW 0.1HP L 190mm rotation direction left capacitor 5µF FIR			
<b>spare parts for</b> 500598				
	GEV No.	365017	Ref. No.	2000001 304269
operating capacitor capacity 5µF 450V tolerance 5% 50/60Hz ambient temperature max. -25 to +85°C ø 28mm L 54mm M8 plastic connection male faston 6.3mm 16.10.08 protection				
	GEV No.	502265	Ref. No.	—
pump cover inlet ø 30mm outlet ø 26mm ID ø 89mm inner height 35mm				
	GEV No.	510695	Ref. No.	—
mechanical shaft seal height counter ring 5.5mm ID ø 11mm				

<b>spare parts for</b> 500598				
	GEV No.	521203	Ref. No.	—
impellor ø 72mm H 18mm thread M7 shaft ø 11mm shaft length 32mm blades 3				
	GEV No.	532718	Ref. No.	—
O-ring EPDM thickness 4mm ID ø 80mm Qty 1 pcs				
	GEV No.	699372	Ref. No.	—
flange for pump with cover type 5213 L 103mm W 103mm H 69mm				







1				
<b>GEV No.</b>	500038	<b>Ref. No.</b>	54103	
<b>description</b>	pump inlet ø 45mm outlet ø 40mm type 3911.1425 230V 50Hz 1 phase 0.55kW 0.75HP L 205mm rotation direction right capacitor 10µF FIR			
<b>spare parts for</b> 500038				
	GEV No.	365015	Ref. No.	—
operating capacitor capacity 10µF 400V tolerance 5%Hz ambient temperature max. -25 to +85°C ø 35.5mm L 59mm M8 plastic connection male faston 6.3mm protection				
	GEV No.	510508	Ref. No.	—
pump cover FIR inlet ø 45mm outlet ø 40mm pump type PU 0.5/3911 turn direction right ø 160mm ID ø 125mm inner height 25mm				
	GEV No.	510610	Ref. No.	3203E
impellor ø 95.5mm H 23mm shaft intake ø 9/8mm rotation direction right seat ø 16mm blades 6				
	GEV No.	510692	Ref. No.	3291E
mechanical shaft seal for shaft ø 11mm slide ring ext. ø 24mm slide ring H 13mm counter ring mounting ø 26mm height counter ring 8mm counter ring int. ø 14mm				
	GEV No.	521702	Ref. No.	—
pump cover gasket thickness 3.5x4.5mm Qty 1 pcs				
<b>accessories for</b> 500038				
	GEV No.	551286	Ref. No.	—
adapter L 120mm 4-pole for Meiko pump suitable for 500038 plug type dependent on equipment				







<b>GEV No.</b>	499281	<b>Ref. No.</b>	2002416H
<b>description</b>	pump inlet $\varnothing$ 60mm outlet $\varnothing$ 50mm type 4298.1404 230V 50Hz 1 phase 1.1kW L 210mm rotation direction right capacitor 12.5 $\mu$ F FIR		
<b>spare parts for</b>	499281		
	<b>GEV No.</b>	365014	<b>Ref. No.</b> —
	operating capacitor capacity 12.5 $\mu$ F 450V tolerance 5%Hz ambient temperature max. -25 to +85°C $\varnothing$ 35mm L 70mm M8 plastic connection male faston 6.3mm 45S.C3DS.12.5 protection		
	<b>GEV No.</b>	510600	<b>Ref. No.</b> —
	impellor $\varnothing$ 102mm H 29mm shaft intake $\varnothing$ 9/8mm rotation direction right blades 6		
	<b>GEV No.</b>	510692	<b>Ref. No.</b> 3291E
	mechanical shaft seal for shaft $\varnothing$ 11mm slide ring ext. $\varnothing$ 24mm slide ring H 13mm counter ring mounting $\varnothing$ 26mm height counter ring 8mm counter ring int. $\varnothing$ 14mm		
	<b>GEV No.</b>	521702	<b>Ref. No.</b> —
	pump cover gasket thickness 3.5x4.5mm Qty 1 pcs		



<b>GEV No.</b>	499334	<b>Ref. No.</b>	2001896H BAAN1321521
<b>description</b>	pump inlet $\varnothing$ 62mm outlet $\varnothing$ 62mm type 2250.2731 230/400V 50Hz 1 phase 3kW FIR		
<b>spare parts for</b>	499334		
	<b>GEV No.</b>	510687	<b>Ref. No.</b> 1443E 2001952H
	mechanical shaft seal for shaft $\varnothing$ 18mm height counter ring 8mm ID $\varnothing$ 17mm ED $\varnothing$ 39mm H 15mm mounting $\varnothing$ 42mm int. $\varnothing$ 1 21mm		
	<b>GEV No.</b>	512455	<b>Ref. No.</b> —
	fan wheel $\varnothing$ 155mm H 18mm shaft intake $\varnothing$ 18mm plastic blades 12		
	<b>GEV No.</b>	521026	<b>Ref. No.</b> N/A
	pump cover gasket ID $\varnothing$ 182.5mm thickness 5x4.5mm		





<b>spare parts for</b>	499334		
	<b>GEV No.</b>	521028	<b>Ref. No.</b> —
	pump cover FIR inlet $\varnothing$ 62mm outlet $\varnothing$ 62mm turn direction right $\varnothing$ 215mm ID $\varnothing$ 175mm inner height 40mm		
	<b>GEV No.</b>	521277	<b>Ref. No.</b> —
	impellor $\varnothing$ 135mm H 39mm pump type Fir 2275 - 3.6HP thread M14L		

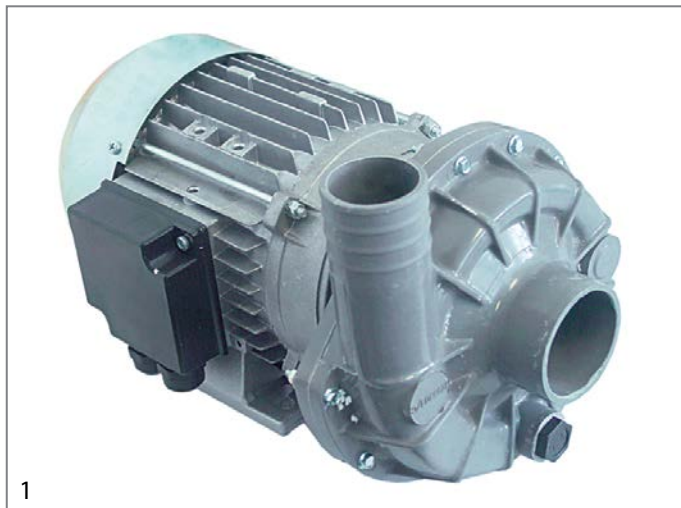

<b>GEV No.</b>	499139	<b>Ref. No.</b>	1244732 30827 BAAN1322558 BAAN304815
<b>description</b>	pump inlet $\varnothing$ 62mm outlet $\varnothing$ 62mm type 2275.2722 230/400V 50Hz 3 phase 2.6kW L 400mm rotation direction right FIR		
<b>spare parts for</b>	499139		
	<b>GEV No.</b>	510687	<b>Ref. No.</b> 1443E 2001952H
	mechanical shaft seal for shaft $\varnothing$ 18mm height counter ring 8mm ID $\varnothing$ 17mm ED $\varnothing$ 39mm H 15mm mounting $\varnothing$ 42mm int. $\varnothing$ 1 21mm		
	<b>GEV No.</b>	521026	<b>Ref. No.</b> N/A
	pump cover gasket ID $\varnothing$ 182.5mm thickness 5x4.5mm		
	<b>GEV No.</b>	521028	<b>Ref. No.</b> —
	pump cover FIR inlet $\varnothing$ 62mm outlet $\varnothing$ 62mm turn direction right $\varnothing$ 215mm ID $\varnothing$ 175mm inner height 40mm		
	<b>GEV No.</b>	521277	<b>Ref. No.</b> —
	impellor $\varnothing$ 135mm H 39mm pump type Fir 2275 - 3.6HP thread M14L		
	<b>GEV No.</b>	524676	<b>Ref. No.</b> —
	fan wheel $\varnothing$ 160mm shaft intake $\varnothing$ 24mm plastic blades 12 W 30mm		







1

<b>GEV No.</b>	500323	<b>Ref. No.</b>	904034 BAAN1029470 BAAN1323230
<b>description</b>	pump inlet ø 63mm outlet ø 47mm type 1227.2721 230/400V 50Hz 3 phase 2kW 2.7HP L 335mm rotation direction right FIR		
<b>spare parts for</b>	500323		
	GEV No.	510599	Ref. No. —
	impellor ø 123mm H 34mm M8L		
	GEV No.	510693	Ref. No. 1475E
	mechanical shaft seal for shaft ø 12mm slide ringext. ø 24mm slide ring H 15.5mm slide ring int. ø 11mm counter ring mounting ø 24mm height counter ring 8mm counter ring int. ø 13.5mm		
	GEV No.	521513	Ref. No. —
	pump cover FIR inlet ø 63mm outlet ø 47mm turn direction right ID ø 150mm inner high 32mm		
	GEV No.	524416	Ref. No. —
	pump cover gasket thickness 4x4mm Qty 1 pcs		







1

<b>GEV No.</b>	500117	<b>Ref. No.</b>	2001980H BAAN1321601 BAAN307942
<b>description</b>	pump inlet ø 63mm outlet ø 47mm type 4225.22725 230/400V 50Hz 3 phase 1.4kW 2HP L 280mm rotation direction right FIR		
<b>spare parts for</b>	500117		
	GEV No.	510602	Ref. No. —
	impellor ø 110mm H 34mm rotation direction right thread M8L shaft ø 28mm seat ø 12.2mm blades 6		

<b>spare parts for</b>	500117		
	GEV No.	510693	Ref. No. 1475E
	mechanical shaft seal for shaft ø 12mm slide ringext. ø 24mm slide ring H 15.5mm slide ring int. ø 11mm counter ring mounting ø 24mm height counter ring 8mm counter ring int. ø 13.5mm		
	GEV No.	521513	Ref. No. —
	pump cover FIR inlet ø 63mm outlet ø 47mm turn direction right ID ø 150mm inner high 32mm		
	GEV No.	524416	Ref. No. —
	pump cover gasket thickness 4x4mm Qty 1 pcs		







1

<b>GEV No.</b>	500570	<b>Ref. No.</b>	2001423H 5901E
<b>description</b>	pump inlet ø 63mm outlet ø 47mm type 422512725 230/400V 50Hz 3 phase 1.1kW 1.5HP L 285mm rotation direction right FIR		
<b>spare parts for</b>	500570		
	GEV No.	510693	Ref. No. 1475E
	mechanical shaft seal for shaft ø 12mm slide ringext. ø 24mm slide ring H 15.5mm slide ring int. ø 11mm counter ring mounting ø 24mm height counter ring 8mm counter ring int. ø 13.5mm		
	GEV No.	521082	Ref. No. —
	impellor ø 96mm H 32mm rotation direction right thread M8L		
	GEV No.	521513	Ref. No. —
	pump cover FIR inlet ø 63mm outlet ø 47mm turn direction right ID ø 150mm inner high 32mm		
	GEV No.	524416	Ref. No. —
	pump cover gasket thickness 4x4mm Qty 1 pcs		



1



<b>GEV No.</b>	500258	<b>Ref. No.</b>	91369308
<b>description</b>	pump inlet ø 63mm outlet ø 53mm type 1204.2725 230/400V 50Hz 3 phase 1.5kW 2.01HP L 320mm rotation direction left FIR		
<b>spare parts for</b>	500258		
	<b>GEV No.</b>	510531	<b>Ref. No.</b> 1474E BAAN1320522 BAAN302263
	pump cover FIR inlet ø 63mm outlet ø 53mm auxiliary pressure connection M16x1.5mm supporting pressure open turn direction left ø 185mm ID ø 150mm inner height 37mm		
	<b>GEV No.</b>	510604	<b>Ref. No.</b> —
	impeller ø 118mm H 34mm M8R rotation direction left		
	<b>GEV No.</b>	510693	<b>Ref. No.</b> 1475E
	mechanical shaft seal for shaft ø 12mm slide ring ext. ø 24mm slide ring H 15.5mm slide ring int. ø 11mm counter ring mounting ø 24mm height counter ring 8mm counter ring int. ø 13.5mm		
	<b>GEV No.</b>	511667	<b>Ref. No.</b> —
	fan wheel ø 123mm H 17mm shaft intake ø 15mm		
	<b>GEV No.</b>	524416	<b>Ref. No.</b> —
	pump cover gasket thickness 4x4mm Qty 1 pcs		

HANNING

pumps



1

<b>GEV No.</b>	499284	<b>Ref. No.</b>	314361
<b>description</b>	pump inlet ø 28mm outlet ø 26mm type UP60-321 Ru. 220-240V 50Hz 1 phase 0.27kW L 190mm rotation direction right capacitor 5µF HANNING		
<b>spare parts for</b>	499284		
	<b>GEV No.</b>	365017	<b>Ref. No.</b> 2000001 304269
	operating capacitor capacity 5µF 450V tolerance 5% 50/60Hz ambient temperature max. -25 to +85°C ø 28mm L 54mm M8 plastic connection male faston 6.3mm 16.10.08 protection		
	<b>GEV No.</b>	507558	<b>Ref. No.</b> —
	mechanical shaft seal for shaft ø 7mm height counter ring 5mm ID ø 6.75mm ED ø 20mm mounting ø counter ring 18.5/slide ring 20mm		
	<b>GEV No.</b>	532644	<b>Ref. No.</b> —
	O-ring EPDM thickness 3mm ID ø 78mm Qty 1 pcs		

LGB



1





<b>GEV No.</b>	499099	<b>Ref. No.</b>	2002220H
<b>description</b>	pump inlet ø 28mm outlet ø 26mm type CRC-R DX 230V 50Hz 1 phase 0.2kW L 175mm rotation direction left capacitor 4µF LGB		
<b>spare parts for</b>	499099		
	<b>GEV No.</b>	365031	<b>Ref. No.</b> —
	operating capacitor capacity 4µF 450V tolerance 5% 50/60Hz ambient temperature max. -25 to +85°C ø 31mm L 58mm M8 plastic connection male faston 6.3mm protection		
	<b>GEV No.</b>	509002	<b>Ref. No.</b> —
	O-ring EPDM thickness 2.62mm ID ø 82.22mm Qty 1 pcs		
	<b>GEV No.</b>	510703	<b>Ref. No.</b> —
	mechanical shaft seal for shaft ø 13mm slide ring H 13mm height counter ring 5.5mm ED ø 26mm		
	<b>GEV No.</b>	521091	<b>Ref. No.</b> —
	pump cover LGB inlet ø 28mm outlet ø 26mm pump type CRC-R DX		

Table continues overleaf



<b>spare parts for</b>	499099			
	GEV No.	521092	Ref. No.	—
	impellor ø 80mm H 25mm pump type CRC-R DX thread M6R shaft ø 13mm shaft length 20mm			







1

<b>GEV No.</b>	500156	<b>Ref. No.</b>	2001513H	
<b>description</b>	pump inlet ø 50mm outlet ø 50mm type ZF400SX 230V 50Hz 1 phase 0.6kW 0.8HP L 210mm rotation direction right capacitor 16µF LGB			
<b>spare parts for</b>	500156			
	GEV No.	509020	Ref. No.	—
	impellor ø 104mm H 25mm M8L			
	GEV No.	510703	Ref. No.	—
	mechanical shaft seal for shaft ø 13mm slide ring H 13mm height counter ring 5.5mm ED ø 26mm			
	GEV No.	521548	Ref. No.	—
	pump cover LGB inlet ø 50mm outlet ø 50mm			
	GEV No.	521734	Ref. No.	—
	pump cover bottom part			
	GEV No.	523509	Ref. No.	—
	deep-groove ball bearing type 6201-2RS shaft ø 12mm ED ø 32mm W 10mm with sealing discs deep-groove ball bearing DIN 625-1			
	GEV No.	532623	Ref. No.	—
	O-ring EPDM thickness 2.62mm ID ø 120.32mm Qty 1 pcs			
<b>accessories for</b>	500156			
	GEV No.	365021	Ref. No.	2001118H 304259
	operating capacitor capacity 16µF 425V tolerance 5% 50/60Hz ambient temperature max. -25 to +85°C ø 35mm L 73mm single M8 plastic connection male faston 6.3mm 416.10.99 protection			





1

<b>GEV No.</b>	500361	<b>Ref. No.</b>	2001517H	
<b>description</b>	pump inlet ø 60mm outlet ø 49mm type ZF400SX 230V 50Hz 1 phase 0.8kW 1HP L 210mm rotation direction right capacitor 16µF LGB			
<b>spare parts for</b>	500361			
	GEV No.	365021	Ref. No.	2001118H 304259
	operating capacitor capacity 16µF 425V tolerance 5% 50/60Hz ambient temperature max. -25 to +85°C ø 35mm L 73mm single M8 plastic connection male faston 6.3mm 416.10.99 protection			
	GEV No.	509020	Ref. No.	—
	impellor ø 104mm H 25mm M8L			
	GEV No.	510703	Ref. No.	—
	mechanical shaft seal for shaft ø 13mm slide ring H 13mm height counter ring 5.5mm ED ø 26mm			
	GEV No.	521547	Ref. No.	—
	pump cover LGB inlet ø 60mm outlet ø 50mm supporting pressure M8 turn direction right ø 160mm ID ø 127mm inner hight 36mm			
	GEV No.	532623	Ref. No.	—
	O-ring EPDM thickness 2.62mm ID ø 120.32mm Qty 1 pcs			



<b>GEV No.</b>	500733	<b>Ref. No.</b>	2001424H
<b>description</b>	pump inlet ø 63mm outlet ø 48mm type AM5225SX 230/400V 50Hz 3 phase 0.9kW 1.2HP L 300mm rotation direction right LGB		







<b>GEV No.</b>	499119	<b>Ref. No.</b>	2001302H
<b>description</b>	pump inlet ø outlet ø 38mm type RV54 230V 50Hz 1 phase 0.8kW L 380mm rotation direction right capacitor 16µF LGB with holder		
<b>spare parts for</b>	499119		
	<b>GEV No.</b>	365021	<b>Ref. No.</b> 2001118H 304259
	operating capacitor capacity 16µF 425V tolerance 5% 50/60Hz ambient temperature max. -25 to +85°C ø 35mm L 73mm single M8 plastic connection male faston 6.3mm 416.10.99 protection		
	<b>GEV No.</b>	502280	<b>Ref. No.</b> —
	pump sump LGB auxiliary pressure connection 7mm supporting pressure closed pump type RV54		
	<b>GEV No.</b>	510703	<b>Ref. No.</b> —
	mechanical shaft seal for shaft ø 13mm slide ring H 13mm height counter ring 5.5mm ED ø 26mm		
	<b>GEV No.</b>	521234	<b>Ref. No.</b> —
	impellor thread M8L ED ø 93mm W 16mm		
	<b>GEV No.</b>	523509	<b>Ref. No.</b> —
	deep-groove ball bearing type 6201-2RS shaft ø 12mm ED ø 32mm W 10mm with sealing discs deep-groove ball bearing DIN 625-1		

<b>spare parts for</b>	499119		
	<b>GEV No.</b>	532537	<b>Ref. No.</b> —
	O-ring EPDM thickness 3.53mm ID ø 113.9mm Qty 1 pcs		

**OLYMPIA**  
pumps



<b>GEV No.</b>	500003	<b>Ref. No.</b>	5591E BAAN307645
<b>description</b>	pump inlet ø 45mm outlet ø 32mm type T30 230V 50Hz 1 phase 0.29kW 0.39HP L 190mm rotation direction right capacitor 8µF OLYMPIA		
<b>spare parts for</b>	500003		
	<b>GEV No.</b>	365013	<b>Ref. No.</b> 3709E
	operating capacitor capacity 8µF 400V tolerance 5%Hz ambient temperature max. -25 to +85°C ø 31.5mm L 55mm M8 plastic connection male faston 6.3mm protection		
	<b>GEV No.</b>	510512	<b>Ref. No.</b> 5618E
	pump cover OLYMPIA inlet ø 45mm outlet ø 31mm outlet 2 ø 24 turn direction right ø 130mm ID ø 124mm inner height 20mm		
	<b>GEV No.</b>	510554	<b>Ref. No.</b> 1255E 3710E 5620E BAAN301931
	O-ring EPDM thickness 2mm ID ø 120mm Qty 1 pcs		
	<b>GEV No.</b>	510615	<b>Ref. No.</b> 5617E 5619E BAAN307734
	impellor ø 90mm H 22mm rotation direction right thread M10L blades 4		
	<b>GEV No.</b>	510693	<b>Ref. No.</b> 1475E
	mechanical shaft seal for shaft ø 12mm slide ring ext. ø 24mm slide ring H 15.5mm slide ring int. ø 11mm counter ring mounting ø 24mm height counter ring 8mm counter ring int. ø 13.5mm		



drain pumps

ASKOLL



1			
<b>GEV No.</b>	500210	<b>Ref. No.</b>	2001519H BAAN1121142 BAAN1321210
<b>description</b>	drain pump 230V 40W		



1			
<b>GEV No.</b>	500214	<b>Ref. No.</b>	2001518H
<b>description</b>	drain pump inlet ø 30mm outlet ø 22mm 230/240V 30W 50Hz ASKOLL type R113		



1			
<b>GEV No.</b>	500346	<b>Ref. No.</b>	2001518H
<b>description</b>	drain pump inlet ø 30mm outlet ø 22mm 230V 40W 50Hz ASKOLL type M231 XP with holder		

HANNING



1			
<b>GEV No.</b>	500573	<b>Ref. No.</b>	2001523H BAAN1121677 BAAN1321214
<b>description</b>	drain pump 30W 4-piece 230V inlet ø 24/30mm outlet ø 24mm 50Hz HANNING type DPS25-032 1x pump, 3x pump cover		

service kits



1			
<b>GEV No.</b>	500573	<b>Ref. No.</b>	2001523H BAAN1121677 BAAN1321214
<b>description</b>	drain pump 30W 4-piece 230V inlet ø 24/30mm outlet ø 24mm 50Hz HANNING type DPS25-032 1x pump, 3x pump cover		

booster pumps II

accessories



1			
<b>GEV No.</b>	365017	<b>Ref. No.</b>	2000001 304269
<b>description</b>	operating capacitor capacity 5µF 450V tolerance 5% 50/60Hz ambient temperature max. -25 to +85°C ø 28mm L 54mm M8 plastic connection male faston 6.3mm 16.10.08 protection		





1			
<b>GEV No.</b>	365012	<b>Ref. No.</b>	2000059
<b>description</b>	operating capacitor capacity 6.3µF 450V tolerance 5% 50Hz ambient temperature max. -25 to +85°C ø 30mm L 61mm M8 plastic connection male faston 6.3mm protection		

# condensators & interference suppression filters

## operating capacitors

### plastic

			
1			
<b>GEV No.</b>	365021	<b>Ref. No.</b>	2001118H 304259
<b>description</b>	operating capacitor capacity 16µF 425V tolerance 5% 50/60Hz ambient temperature max. -25 to +85°C ø 35mm L 73mm single M8 plastic connection male faston 6.3mm 416.10.99 protection		

			
1			
<b>GEV No.</b>	365019	<b>Ref. No.</b>	2001119H
<b>description</b>	operating capacitor capacity 20µF 400V tolerance 5% 50/60Hz ambient temperature max. -25 to +85°C ø 39.5mm L 70mm M8 plastic connection male faston 6.3mm 16.10.25. protection		

			
1			
<b>GEV No.</b>	365017	<b>Ref. No.</b>	2000001 304269
<b>description</b>	operating capacitor capacity 5µF 450V tolerance 5% 50/60Hz ambient temperature max. -25 to +85°C ø 28mm L 54mm M8 plastic connection male faston 6.3mm 16.10.08 protection		

			
1			
<b>GEV No.</b>	365012	<b>Ref. No.</b>	2000059
<b>description</b>	operating capacitor capacity 6.3µF 450V tolerance 5% 50Hz ambient temperature max. -25 to +85°C ø 30mm L 61mm M8 plastic connection male faston 6.3mm protection		

			
1			
<b>GEV No.</b>	365013	<b>Ref. No.</b>	3709E
<b>description</b>	operating capacitor capacity 8µF 400V tolerance 5%Hz ambient temperature max. -25 to +85°C ø 31.5mm L 55mm M8 plastic connection male faston 6.3mm protection		

<h3>metal</h3>			
			
1			
<b>GEV No.</b>	365139	<b>Ref. No.</b>	5843E
<b>description</b>	operating capacitor capacity 10µF 450V tolerance 5% 60Hz ambient temperature max. -25 up to +70°C ø 40mm L 83mm M8 aluminium connection male faston 6.3mm C.87.8BF2 MKP protection		

			
1			
<b>GEV No.</b>	365142	<b>Ref. No.</b>	304259
<b>description</b>	operating capacitor capacity 15µF 450V with metal case tolerance 5% 50/60Hz ø 40mm L 110mm M8x1.25		

## fuses

### fine fuses

			
1			
<b>GEV No.</b>	358666	<b>Ref. No.</b>	309316
<b>description</b>	fine fuse size ø5x20mm 0.315A fast-acting rated 250V Qty 10 pcs		

			
1			
<b>GEV No.</b>	358530	<b>Ref. No.</b>	2001921H
<b>description</b>	fine fuse size ø5x20mm 0.8A fast-acting rated 250V Qty 10 pcs		

			
1			
<b>GEV No.</b>	358677	<b>Ref. No.</b>	2001981H 2002146H
<b>description</b>	fine fuse size ø5x20mm 4A fast-acting rated 250V Qty 10 pcs		



			
1			
<b>GEV No.</b>	358752	<b>Ref. No.</b>	3090506
<b>description</b>	fine fuse size ø6.3x32mm 10A fast-acting rated 500V Qty 10 pcs		



## electric accessories

### cables

copper wire			
up to 280°C			
			
1			
<b>GEV No.</b>	550588	<b>Ref. No.</b>	306437
<b>description</b>	copper wire 6mm <sup>2</sup> permanent temperature -60 up to +280°C conductor nickel-plated copper wire insulation glass fibre braiding/silicone rubber Qty 10m brown t.max. 350°C rated 300/500V test voltage 2000V		

nickel wire			
up to 350°C			
			
1			
<b>GEV No.</b>	550089	<b>Ref. No.</b>	306435
<b>description</b>	nickel wire 4mm <sup>2</sup> brown Qty 10m permanent temperature -60 up to +350°C t.max. 400°C rated 300/500V test voltage 2000V conductor nickel wire insulation glass fibre braiding/silicone rubber		

			
1			
<b>GEV No.</b>	550590	<b>Ref. No.</b>	306437
<b>description</b>	nickel wire 6mm <sup>2</sup> brown Qty 10m permanent temperature -60 up to +350°C t.max. 400°C rated 300/500V test voltage 2000V conductor nickel wire insulation glass fibre braiding/silicone rubber		

ribbon cables			
group 1			
			
1			
<b>GEV No.</b>	402970	<b>Ref. No.</b>	2001927H BAAN1027510 BAAN1321548
<b>description</b>	ribbon cable 10-pole L 1200mm plug type 2 row coded Qty 1m		
			
1			
<b>GEV No.</b>	400902	<b>Ref. No.</b>	2001087H
<b>description</b>	ribbon cable 10-pole L 750mm plug type FC-10P raster size 2.54mm		

## terminals

### connection terminals with screw/faston connections

			
1			
<b>GEV No.</b>	550411	<b>Ref. No.</b>	2001039H 306090 306157 5876E 906154
<b>description</b>	power terminal block 6-pole max. 40A max 450V connection ø6mm <sup>2</sup> / F6.3 temp.-resist. 150°C cross section 6mm <sup>2</sup>		

## gas taps

### PEL









21S series			
			
1			
<b>GEV No.</b>	101397	<b>Ref. No.</b>	310139 BAAN169423 BAAN304894
<b>description</b>	gas tap PEL type 21S gas inlet M16x1.5 (tube ø 10mm) bypass nozzle ø 0.35mm gas outlet M16x1.5 (tube ø 10/8mm) thermocouple connection M9x1 pilot connection M10x1 shaft ø 8x6.5mm shaft L 22/15mm shaft flat lower		
<b>spare parts for</b>	101397		
	<b>GEV No.</b>	<b>Ref. No.</b>	—
	100408		
	bypass nozzle type PEL20/21 bore ø 0.35mm thread M5x0.5		
	<b>GEV No.</b>	<b>Ref. No.</b>	7473048 BAAN310651
	101060		
	magnet unit standard L 39mm D1 ø 15.4mm D2 ø 11mm suitable for PEL20-21/JUNKERS/EGA		
	<b>GEV No.</b>	<b>Ref. No.</b>	—
	101206		
	gas tap front part shaft ø 8x6.5mm shaft L 22/15mm shaft flat upper/lower suitable for PEL21		
	<b>GEV No.</b>	<b>Ref. No.</b>	—
	101231		
	thermocouple nut T1: M9x1 T2: M18x1		
<b>accessories for</b>	101397		
	<b>GEV No.</b>	<b>Ref. No.</b>	—
	100908		
	union screw thread M10x1 for pipe ø 4mm Qty 1 pcs		
	<b>GEV No.</b>	<b>Ref. No.</b>	—
	100909		
	union screw thread M10x1 for pipe ø 6mm Qty 1 pcs		
	<b>GEV No.</b>	<b>Ref. No.</b>	—
	101246		
	olive for pipe ø 4mm Qty 1 pcs		

Table continues overleaf



<b>accessories for</b> 101397				
	GEV No.	101278	Ref. No.	—
olive for pipe ø 10mm Qty 1 pcs				
	GEV No.	101286	Ref. No.	—
olive ID ø 6mm Qty 1 pcs				
	GEV No.	101300	Ref. No.	—
union nut thread M16x1.5 tube ø 10mm				
	GEV No.	101450	Ref. No.	—
olive for pipe ø 8mm L 12.7mm Qty 1 pcs ED ø 10mm				
	GEV No.	101451	Ref. No.	—
union nut thread M16x1.5 tube ø 8mm				
	GEV No.	110081	Ref. No.	171475
knob ø 70mm shaft ø 8x6.5mm shaft flat universal				
	GEV No.	112206	Ref. No.	—
knob dial plate silver gas tap PEL21/22/23 t.max.°C ED ø 63mm ID ø 45.5mm				

1				
<b>GEV No.</b>	106815	<b>Ref. No.</b>	N/A	
<b>description</b>	gas tap PEL type 21S gas inlet M16x1.5 (tube ø 10mm) bypass nozzle ø 0mm gas outlet 2x M10x1 thermocouple connection M9x1 pilot connection M10x1 shaft ø 8x6.5mm shaft L 22/15mm shaft flat upper			
<b>spare parts for</b>	106815			
	GEV No.	101060	Ref. No.	7473048 BAAN310651
magnet unit standard L 39mm D1 ø 15.4mm D2 ø 11mm suitable for PEL20-21/JUNKERS/EGA				
	GEV No.	101206	Ref. No.	—
gas tap front part shaft ø 8x6.5mm shaft L 22/15mm shaft flat upper/lower suitable for PEL21				
	GEV No.	101231	Ref. No.	—
thermocouple nut T1: M9x1 T2: M18x1				
	GEV No.	106202	Ref. No.	—
bypass nozzle type PEL20/21 bore ø 0mm thread M5x0.5				
	GEV No.	106823	Ref. No.	—
gas connection gas inlet M16x1.5 gas outlet 2x M10x1				

1				
<b>GEV No.</b>	106817	<b>Ref. No.</b>	165961 165961SEM BAAN1071350 BAAN1147970	
<b>description</b>	gas tap PEL type 21S gas inlet M16x1.5 (tube ø 10mm) bypass nozzle ø 0mm gas outlet 2x M10x1 thermocouple connection M9x1 pilot connection M10x1 shaft ø 8x6.5mm shaft L 22/15mm shaft flat upper			
<b>spare parts for</b>	106817			
	GEV No.	101060	Ref. No.	7473048 BAAN310651
magnet unit standard L 39mm D1 ø 15.4mm D2 ø 11mm suitable for PEL20-21/JUNKERS/EGA				
	GEV No.	101206	Ref. No.	—
gas tap front part shaft ø 8x6.5mm shaft L 22/15mm shaft flat upper/lower suitable for PEL21				
	GEV No.	101231	Ref. No.	—
thermocouple nut T1: M9x1 T2: M18x1				
	GEV No.	106202	Ref. No.	—
bypass nozzle type PEL20/21 bore ø 0mm thread M5x0.5				
	GEV No.	106819	Ref. No.	—
solenoid valve body				
	GEV No.	106820	Ref. No.	—
solenoid valve connection gas inlet M16x1.5 gas outlet 2x M10x1 thread size valve body M20x1				
	GEV No.	371157	Ref. No.	—
solenoid coil t.max. 125°C 230V seat ø 13mm 17VA				
<b>accessories for</b>	106817			
	GEV No.	100908	Ref. No.	—
union screw thread M10x1 for pipe ø 4mm Qty 1 pcs				
	GEV No.	100909	Ref. No.	—
union screw thread M10x1 for pipe ø 6mm Qty 1 pcs				
	GEV No.	101246	Ref. No.	—
olive for pipe ø 4mm Qty 1 pcs				
	GEV No.	101278	Ref. No.	—
olive for pipe ø 10mm Qty 1 pcs				
	GEV No.	101286	Ref. No.	—
olive ID ø 6mm Qty 1 pcs				
	GEV No.	101300	Ref. No.	—
union nut thread M16x1.5 tube ø 10mm				
	GEV No.	101450	Ref. No.	—
olive for pipe ø 8mm L 12.7mm Qty 1 pcs ED ø 10mm				

Table continues overleaf





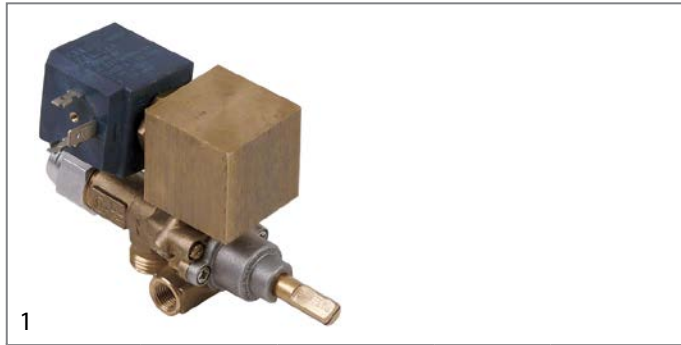







<b>accessories for</b> 106817				
	GEV No.	101451	Ref. No.	—
union nut thread M16x1.5 tube ø 8mm				
	GEV No.	110081	Ref. No.	171475
knob ø 70mm shaft ø 8x6.5mm shaft flat universal				
	GEV No.	112206	Ref. No.	—
knob dial plate silver gas tap PEL21/22/23 t.max.°C ED ø 63mm ID ø 45.5mm				



<b>GEV No.</b>	106816	<b>Ref. No.</b>	165962
<b>description</b>	gas tap PEL type 21S gas inlet M16x1.5 (tube ø 10mm) bypass nozzle ø 0mm gas outlet M10x1 thermocouple connection M9x1 pilot connection M10x1 shaft ø 8x6.5mm shaft L 22/15mm shaft flat upper with solenoid valve with ignition safety device		

<b>spare parts for</b> 106816				
	GEV No.	101060	Ref. No.	7473048 BAAN310651
magnet unit standard L 39mm D1 ø 15.4mm D2 ø 11mm suitable for PEL20-21/JUNKERS/EGA				
	GEV No.	101206	Ref. No.	—
gas tap front part shaft ø 8x6.5mm shaft L 22/15mm shaft flat upper/lower suitable for PEL21				
	GEV No.	101231	Ref. No.	—
thermocouple nut T1: M9x1 T2: M18x1				
	GEV No.	106202	Ref. No.	—
bypass nozzle type PEL20/21 bore ø 0mm thread M5x0.5				
	GEV No.	106819	Ref. No.	—
solenoid valve body				
	GEV No.	106821	Ref. No.	—
solenoid valve connection gas inlet M16x1.5 gas outlet 3/8" thread size valve body M20x1				
	GEV No.	371157	Ref. No.	—
solenoid coil t.max. 125°C 230V seat ø 13mm 17VA				





<b>accessories for</b> 106816				
	GEV No.	100908	Ref. No.	—
union screw thread M10x1 for pipe ø 4mm Qty 1 pcs				
	GEV No.	100909	Ref. No.	—
union screw thread M10x1 for pipe ø 6mm Qty 1 pcs				
	GEV No.	101246	Ref. No.	—
olive for pipe ø 4mm Qty 1 pcs				
	GEV No.	101278	Ref. No.	—
olive for pipe ø 10mm Qty 1 pcs				

<b>accessories for</b> 106816				
	GEV No.	101286	Ref. No.	—
olive ID ø 6mm Qty 1 pcs				
	GEV No.	101300	Ref. No.	—
union nut thread M16x1.5 tube ø 10mm				
	GEV No.	101450	Ref. No.	—
olive for pipe ø 8mm L 12.7mm Qty 1 pcs ED ø 10mm				
	GEV No.	101451	Ref. No.	—
union nut thread M16x1.5 tube ø 8mm				
	GEV No.	110081	Ref. No.	171475
knob ø 70mm shaft ø 8x6.5mm shaft flat universal				
	GEV No.	112206	Ref. No.	—
knob dial plate silver gas tap PEL21/22/23 t.max.°C ED ø 63mm ID ø 45.5mm				

**22N/O series**



<b>GEV No.</b>	101443	<b>Ref. No.</b>	904883
<b>description</b>	gas tap PEL type 22N/O gas inlet M20x1.5 (tube ø 12mm) bypass nozzle ø 0.35mm gas outlet M20x1.5 (tube ø 12/10mm) thermocouple connection pilot connection M10x1 shaft ø 10x8mm shaft L 25/17mm shaft flat lower		

<b>spare parts for</b> 101443				
	GEV No.	100259	Ref. No.	—
bypass nozzle type PEL22 bore ø 0.35mm thread M6x0.5				
	GEV No.	101201	Ref. No.	—
gas tap front part shaft ø 10x8mm shaft L 25/17mm shaft flat upper/lower suitable for PEL22				
	GEV No.	101240	Ref. No.	—
gas connection thread M20x1.5 tube ø 12/10mm for PEL gas taps with gasket and screws horizontal				
	GEV No.	101460	Ref. No.	—
O-ring ø 12.37mm D1 ø 2.62mm suitable for PEL22				
	GEV No.	101461	Ref. No.	—
screw kit suitable for PEL22 Qty 4 pcs				



<b>accessories for</b> 101443				
	GEV No.	100908	Ref. No.	—
union screw thread M10x1 for pipe ø 4mm Qty 1 pcs				
	GEV No.	100909	Ref. No.	—
union screw thread M10x1 for pipe ø 6mm Qty 1 pcs				
	GEV No.	101246	Ref. No.	—
olive for pipe ø 4mm Qty 1 pcs				

Table continues overleaf

accessories for		101443		
GEV No.	101248	Ref. No.	—	
	olive for pipe ø 12mm Qty 1 pcs suitable for PEL			
	olive for pipe ø 10mm Qty 1 pcs			
	union nut thread M20x1.5 for pipe ø 10mm			
	union nut thread M20x1.5 for pipe ø 12mm			
	olive ID ø 6mm Qty 1 pcs			

22S/O series

<p>1</p>				
GEV No.	101086	Ref. No.	310140 904882 BAAN1209962 BAAN169424 BAAN311840	
description	gas tap PEL type 22S/O gas inlet M20x1.5 (tube ø 12mm) bypass nozzle ø 0.35mm gas outlet M20x1.5 (tube ø 12/10mm) thermocouple connection M9x1 pilot connection M10x1 shaft ø 10x8mm shaft L 25/17mm shaft flat lower			
spare parts for	101086			
	GEV No.	100259	Ref. No.	—
	bypass nozzle type PEL22 bore ø 0.35mm thread M6x0.5			
	GEV No.	101058	Ref. No.	309132 BAAN71001E
	magnet unit L 39mm D1 ø 15.4mm D2 ø 13.5mm suitable for PEL22/ EGA24197 standard			
	GEV No.	101201	Ref. No.	—
	gas tap front part shaft ø 10x8mm shaft L 25/17mm shaft flat upper/ lower suitable for PEL22			
	GEV No.	101231	Ref. No.	—
	thermocouple nut T1: M9x1 T2: M18x1			
	GEV No.	101240	Ref. No.	—
	gas connection thread M20x1.5 tube ø 12/10mm for PEL gas taps with gasket and screws horizontal			
	GEV No.	101460	Ref. No.	—
	O-ring ø 12.37mm D1 ø 2.62mm suitable for PEL22			
	GEV No.	101461	Ref. No.	—
	screw kit suitable for PEL22 Qty 4 pcs			
accessories for		101086		
	GEV No.	100908	Ref. No.	—
	union screw thread M10x1 for pipe ø 4mm Qty 1 pcs			
	GEV No.	100909	Ref. No.	—
	union screw thread M10x1 for pipe ø 6mm Qty 1 pcs			

accessories for		101086		
GEV No.	101241	Ref. No.	—	
	gas connection thread M20x1.5 tube ø 12/10mm for PEL gas taps vertical			
	olive for pipe ø 4mm Qty 1 pcs			
	olive for pipe ø 12mm Qty 1 pcs suitable for PEL			
	olive for pipe ø 10mm Qty 1 pcs			
	union nut thread M20x1.5 for pipe ø 10mm			
	union nut thread M20x1.5 for pipe ø 12mm			
	olive ID ø 6mm Qty 1 pcs			
	GEV No.	110080	Ref. No.	—
	knob ø 70mm shaft ø 10x8mm shaft flat universal			
	GEV No.	112206	Ref. No.	—
	knob dial plate silver gas tap PEL21/22/23 t.max.°C ED ø 63mm ID ø 45.5mm			

<p>1</p>				
GEV No.	106818	Ref. No.	156033	
description	gas tap PEL type 22S/O gas inlet M20x1.5 (tube ø 12mm) bypass nozzle ø 0mm gas outlet 3/8" thermocouple connection M9x1 pilot connection M10x1 shaft ø 10x8mm shaft L 25/17mm shaft flat lower with solenoid valve			
spare parts for	106818			
	GEV No.	101058	Ref. No.	309132 BAAN71001E
	magnet unit L 39mm D1 ø 15.4mm D2 ø 13.5mm suitable for PEL22/ EGA24197 standard			
	GEV No.	101231	Ref. No.	—
	thermocouple nut T1: M9x1 T2: M18x1			
	GEV No.	101365	Ref. No.	—
	gas connection thread M20x1.5 tube ø 12mm for PEL gas taps horizontal			
	GEV No.	106191	Ref. No.	—
	bypass nozzle type PEL22 bore ø 0mm thread M6x0.5			
	GEV No.	106819	Ref. No.	—
	solenoid valve body			

Table continues overleaf





<b>spare parts for</b> 106818	
	GEV No. 106822 Ref. No. — solenoid valve connection gas inlet M20x1.5 gas outlet 3/8" thread size valve body M20x1
	GEV No. 371157 Ref. No. — solenoid coil t.max. 125°C 230V seat ø 13mm 17VA
<b>accessories for</b> 106818	
	GEV No. 101248 Ref. No. — olive for pipe ø 12mm Qty 1 pcs suitable for PEL
	GEV No. 101249 Ref. No. — olive for pipe ø 10mm Qty 1 pcs
	GEV No. 101250 Ref. No. — union nut thread M20x1.5 for pipe ø 10mm
	GEV No. 101251 Ref. No. — union nut thread M20x1.5 for pipe ø 12mm

			
1			
<b>GEV No.</b>	109510	<b>Ref. No.</b>	904882 BAAN1209962 BAAN311840
<b>description</b>	gas tap PEL type 22S/O gas inlet M20x1.5 (tube ø 12mm) bypass nozzle ø 1.3mm gas outlet M20x1.5 (tube ø 12/10mm) thermocouple connection M8x1 pilot connection M10x1 shaft ø 10x8mm shaft L 25/17mm shaft flat right		
<b>spare parts for</b> 109510			
	GEV No. 100438	Ref. No.	— bypass nozzle type PEL22 bore ø 1.2mm thread M6x0.5
	GEV No. 101058	Ref. No.	309132 BAAN71001E magnet unit L 39mm D1 ø 15.4mm D2 ø 13.5mm suitable for PEL22/ EGA24197 standard
	GEV No. 101202	Ref. No.	— gas tap front part shaft ø 8x10mm shaft L 25/17mm shaft flat right/ left suitable for PEL22
	GEV No. 101230	Ref. No.	— thermocouple nut T1: M8x1 T2: M18x1 aluminium
	GEV No. 101240	Ref. No.	— gas connection thread M20x1.5 tube ø 12/10mm for PEL gas taps with gasket and screws horizontal
	GEV No. 101460	Ref. No.	— O-ring ø 12.37mm D1 ø 2.62mm suitable for PEL22
	GEV No. 101461	Ref. No.	— screw kit suitable for PEL22 Qty 4 pcs
<b>accessories for</b> 109510			
	GEV No. 100908	Ref. No.	— union screw thread M10x1 for pipe ø 4mm Qty 1 pcs
	GEV No. 100909	Ref. No.	— union screw thread M10x1 for pipe ø 6mm Qty 1 pcs

<b>accessories for</b> 109510	
	GEV No. 101241 Ref. No. — gas connection thread M20x1.5 tube ø 12/10mm for PEL gas taps vertical
	GEV No. 101246 Ref. No. — olive for pipe ø 4mm Qty 1 pcs
	GEV No. 101248 Ref. No. — olive for pipe ø 12mm Qty 1 pcs suitable for PEL
	GEV No. 101249 Ref. No. — olive for pipe ø 10mm Qty 1 pcs
	GEV No. 101250 Ref. No. — union nut thread M20x1.5 for pipe ø 10mm
	GEV No. 101251 Ref. No. — union nut thread M20x1.5 for pipe ø 12mm
	GEV No. 101286 Ref. No. — olive ID ø 6mm Qty 1 pcs

**22S/V series**





			
1			
<b>GEV No.</b>	101457	<b>Ref. No.</b>	7462033
<b>description</b>	gas tap alternatives to JUNKERS type CH110 gas inlet M20x1.5 (tube ø 12mm) bypass nozzle ø 0.35mm gas outlet M20x1.5 (tube ø 12/10mm) thermocouple connection M8x1 pilot connection M10x1 shaft ø 10mm shaft L 25mm shaft flat with pipe outlet		
<b>spare parts for</b> 101457			
	GEV No. 100259	Ref. No.	— bypass nozzle type PEL22 bore ø 0.35mm thread M6x0.5
	GEV No. 100908	Ref. No.	— union screw thread M10x1 for pipe ø 4mm Qty 1 pcs
	GEV No. 101058	Ref. No.	309132 BAAN71001E magnet unit L 39mm D1 ø 15.4mm D2 ø 13.5mm suitable for PEL22/ EGA24197 standard
	GEV No. 101200	Ref. No.	— gas tap front part shaft ø 10mm shaft L 25mm shaft flat suitable for 22S/O
	GEV No. 101230	Ref. No.	— thermocouple nut T1: M8x1 T2: M18x1 aluminium
	GEV No. 101241	Ref. No.	— gas connection thread M20x1.5 tube ø 12/10mm for PEL gas taps vertical
	GEV No. 101246	Ref. No.	— olive for pipe ø 4mm Qty 1 pcs

Table continues overleaf





spare parts for		101457	
	GEV No.	101460	Ref. No. —
	O-ring ø 12.37mm D1 ø 2.62mm suitable for PEL22		
	GEV No.	101461	Ref. No. —
	screw kit suitable for PEL22 Qty 4 pcs		
accessories for		101457	
	GEV No.	100945	Ref. No. —
	roll pin ø 3.2mm L 10mm		
	GEV No.	101218	Ref. No. —
	shaft extension JUNKERS		
	GEV No.	101219	Ref. No. —
	shaft extension L 25mm JUNKERS		
	GEV No.	101231	Ref. No. —
	thermocouple nut T1: M9x1 T2: M18x1		
	GEV No.	101248	Ref. No. —
	olive for pipe ø 12mm Qty 1 pcs suitable for PEL		
	GEV No.	101249	Ref. No. —
	olive for pipe ø 10mm Qty 1 pcs		
	GEV No.	101250	Ref. No. —
	union nut thread M20x1.5 for pipe ø 10mm		
	GEV No.	101251	Ref. No. —
	union nut thread M20x1.5 for pipe ø 12mm		
	GEV No.	101290	Ref. No. —
	thermocouple nut T1: M10x1 T2: M18x1 suitable for PEL20/21		
	GEV No.	110064	Ref. No. —
	knob		
	GEV No.	110066	Ref. No. —
	knob screw		
	GEV No.	550396	Ref. No. —
	shaft extension L 25mm JUNKERS		

23S/V series			
1			
<b>GEV No.</b>	101093	<b>Ref. No.</b>	905992 BAAN312065
<b>description</b>	gas tap PEL type 23S/V gas inlet M28x1.5 (tube ø 20mm) bypass nozzle ø 0.35mm thermocouple connection M10x1 pilot connection M10x1 shaft ø 10x8mm shaft L 25/17mm shaft flat lower		
spare parts for		101093	
	GEV No.	100455	Ref. No. —
	bypass nozzle type PEL23/24 bore ø 0.35mm thread M8x0.5		
	GEV No.	101059	Ref. No. —
	magnet unit T1: M10x1 T2: M22x1 L 46mm ø 18mm suitable for PEL23S M10x1		
	GEV No.	101204	Ref. No. —
	gas tap front part shaft ø 10x8mm shaft L 25/17mm shaft flat upper/lower suitable for PEL23S		
	GEV No.	101245	Ref. No. —
	gas connection thread M24x1.5 tube ø 12/16mm vertical for PEL gas taps		
	GEV No.	101463	Ref. No. —
	screw suitable for PEL23S Qty 4 pcs		
	GEV No.	528455	Ref. No. —
	O-ring Viton thickness 2.62mm ID ø 18.72mm Qty 1 pcs		
accessories for		101093	
	GEV No.	100908	Ref. No. —
	union screw thread M10x1 for pipe ø 4mm Qty 1 pcs		
	GEV No.	100909	Ref. No. —
	union screw thread M10x1 for pipe ø 6mm Qty 1 pcs		
	GEV No.	101246	Ref. No. —
	olive for pipe ø 4mm Qty 1 pcs		
	GEV No.	101252	Ref. No. —
	union nut thread M24x1.5 for pipe ø 12mm		
	GEV No.	101253	Ref. No. —
	union nut thread M24x1.5 PEL for pipe ø 16mm		
	GEV No.	101254	Ref. No. —
	union nut thread M28x1.5 tube ø 20mm		
	GEV No.	101255	Ref. No. —
	olive for pipe ø 12mm Qty 1 pcs		
	GEV No.	101256	Ref. No. —
	olive for pipe ø 16mm Qty 1 pcs		
	GEV No.	101257	Ref. No. —
	olive for pipe ø 20mm Qty 1 pcs		

Table continues overleaf





accessories for		101093	
	GEV No.	101286	Ref. No. —
olive ID ø 6mm Qty 1 pcs			
	GEV No.	110080	Ref. No. —
knob ø 70mm shaft ø 10x8mm shaft flat universal			
	GEV No.	112206	Ref. No. —
knob dial plate silver gas tap PEL21/22/23 t.max.°C ED ø 63mm ID ø 45.5mm			

### alternatives to JUNKERS

			
1			
<b>GEV No.</b>	101457	<b>Ref. No.</b>	7462033
<b>description</b>	gas tap alternatives to JUNKERS type CH110 gas inlet M20x1.5 (tube ø 12mm) bypass nozzle ø 0.35mm gas outlet M20x1.5 (tube ø 12/10mm) thermocouple connection M8x1 pilot connection M10x1 shaft ø 10mm shaft L 25mm shaft flat with pipe outlet		
<b>spare parts for</b>		101457	
	GEV No.	100259	Ref. No. —
bypass nozzle type PEL22 bore ø 0.35mm thread M6x0.5			
	GEV No.	100908	Ref. No. —
union screw thread M10x1 for pipe ø 4mm Qty 1 pcs			
	GEV No.	101058	Ref. No. 309132 BAAN71001E
magnet unit L 39mm D1 ø 15.4mm D2 ø 13.5mm suitable for PEL22/EGA24197 standard			
	GEV No.	101200	Ref. No. —
gas tap front part shaft ø 10mm shaft L 25mm shaft flat suitable for 22S/O			
	GEV No.	101230	Ref. No. —
thermocouple nut T1: M8x1 T2: M18x1 aluminium			
	GEV No.	101241	Ref. No. —
gas connection thread M20x1.5 tube ø 12/10mm for PEL gas taps vertical			
	GEV No.	101246	Ref. No. —
olive for pipe ø 4mm Qty 1 pcs			
	GEV No.	101460	Ref. No. —
O-ring ø 12.37mm D1 ø 2.62mm suitable for PEL22			
	GEV No.	101461	Ref. No. —
screw kit suitable for PEL22 Qty 4 pcs			
<b>accessories for</b>		101457	
	GEV No.	100945	Ref. No. —
roll pin ø 3.2mm L 10mm			
	GEV No.	101218	Ref. No. —
shaft extension JUNKERS			

accessories for		101457	
	GEV No.	101219	Ref. No. —
shaft extension L 25mm JUNKERS			
	GEV No.	101231	Ref. No. —
thermocouple nut T1: M9x1 T2: M18x1			
	GEV No.	101248	Ref. No. —
olive for pipe ø 12mm Qty 1 pcs suitable for PEL			
	GEV No.	101249	Ref. No. —
olive for pipe ø 10mm Qty 1 pcs			
	GEV No.	101250	Ref. No. —
union nut thread M20x1.5 for pipe ø 10mm			
	GEV No.	101251	Ref. No. —
union nut thread M20x1.5 for pipe ø 12mm			
	GEV No.	101290	Ref. No. —
thermocouple nut T1: M10x1 T2: M18x1 suitable for PEL20/21			
	GEV No.	110064	Ref. No. —
knob			
	GEV No.	110066	Ref. No. —
knob screw			
	GEV No.	550396	Ref. No. —
shaft extension L 25mm JUNKERS			

### STN3R

			
1			
<b>GEV No.</b>	106186	<b>Ref. No.</b>	7462038 BAAN310577
<b>description</b>	gas tap STN3R gas inlet pipe flange ø27mm bypass nozzle ø 0mm gas outlet 1/2" thermocouple connection M9x1 pilot connection M10x1 shaft ø 7x7mm shaft L 21/12mm shaft flat diagonal suitable for CHARVET		
<b>spare parts for</b>		106186	
	GEV No.	101964	Ref. No. —
clamping bracket			

SIRAL



<b>1</b>			
<b>GEV No.</b>	107387	<b>Ref. No.</b>	303028 BAAN70879E
<b>description</b>	gas tap SIRAL type 06-1464 gas inlet pipe flange ø20mm bypass nozzle ø 0.42mm gas outlet 1/4" (tube ø 8mm) front fixing thermocouple connection M8x1 shaft ø 6x4.6mm shaft L 19/15mm shaft flat upper mounting thread M5x0.8		

<b>accessories for</b>	101689		
	<b>GEV No.</b>	101136	<b>Ref. No.</b> —
	piezoelectric igniter suitable for Minisit with cover cap ømm connection F6.3x0.8		
	<b>GEV No.</b>	101137	<b>Ref. No.</b> 7472037 BAAN310636
	cover cap without piezoelectric igniter		
	<b>GEV No.</b>	101267	<b>Ref. No.</b> —
	reducer IT 3/8" ET 1/2" L 21mm		
	<b>GEV No.</b>	101268	<b>Ref. No.</b> —
	gas connection thread 3/8" angled with O-ring MINISIT 710		
	<b>GEV No.</b>	101269	<b>Ref. No.</b> —
	gas connection thread 1/2" angled with O-ring MINISIT 710		
	<b>GEV No.</b>	101270	<b>Ref. No.</b> —
	screw connection IT 3/8" ET 3/8" L 28mm		
	<b>GEV No.</b>	101272	<b>Ref. No.</b> —
	screw connection IT 1/2" ET 3/8" L 57mm		
	<b>GEV No.</b>	101273	<b>Ref. No.</b> —
	olive for pipe ø 12mm L 9.5mm brass Qty 1 pcs suitable for universal		
	<b>GEV No.</b>	101274	<b>Ref. No.</b> —
	olive for pipe ø 16mm Qty 1 pcs		
	<b>GEV No.</b>	101275	<b>Ref. No.</b> —
	union screw thread 1/2" for pipe ø 16mm Qty 1 pcs		
	<b>GEV No.</b>	101276	<b>Ref. No.</b> —
	union screw thread 3/8" tube ø 12mm Qty 1 pcs		
	<b>GEV No.</b>	110068	<b>Ref. No.</b> 7479041
	knob suitable for Minisit ø 37mm		

gas thermostats

SIT

710 Minisit series



<b>1</b>			
<b>GEV No.</b>	101689	<b>Ref. No.</b>	7472022
<b>description</b>	gas thermostat SIT type MINISIT 710 t.max. 110°C 40-110°C gas inlet 1/2" gas outlet 3/8" thermocouple connection M9x1 pilot connection M10x1 probe ø 5mm probe L 125mm capillary pipe 1050mm probe type type A1 pressure controller no pressure regulator mbar gland nut		

**spare parts for** 101689

	<b>GEV No.</b>	101053	<b>Ref. No.</b>	7473051 BAAN310654
	magnet unit T1: M9x1 T2: M24x1 L 45mm ø 17mm suitable for Minisit			

	<b>GEV No.</b>	102100	<b>Ref. No.</b>	—
	probe 30-100°C probe ø 5mm probe L 122mm capillary pipe 1050mm t.max. 100°C bain marie probe type type A1 suitable for MINISIT 710			

**accessories for** 101689



	<b>GEV No.</b>	100809	<b>Ref. No.</b>	—
	O-ring EPDM thickness 2mm ID ø 21mm Qty 1 pcs			

	<b>GEV No.</b>	100820	<b>Ref. No.</b>	—
	gland duct ET M14x1.5 IT M10x0.75 probe ø max. 6.5mm WS 22			

	<b>GEV No.</b>	100904	<b>Ref. No.</b>	—
	locking screw M10x1 for pipe ø 4mm Qty 1 pcs			



	<b>GEV No.</b>	100905	<b>Ref. No.</b>	—
	locking screw M10x1 for pipe ø 6mm Qty 1 pcs			

	<b>GEV No.</b>	101054	<b>Ref. No.</b>	—
	magnet unit T1: M10x1 T2: M24x1 L 45mm ø 17mm suitable for Minisit			

<b>1</b>			
<b>GEV No.</b>	106931	<b>Ref. No.</b>	7472031
<b>description</b>	gas thermostat SIT type MINISIT 710 t.max. 310°C 70-310°C gas inlet 1/2" gas outlet 3/8" thermocouple connection M9x1 pilot connection M10x1 probe ø 4mm probe L 72mm capillary pipe 1300mm pressure controller no pressure regulator mbar gland nut 0710647 ignition gas 6mm probe material stainless steel		
<b>accessories for</b>	106931		
	<b>GEV No.</b>	101137	<b>Ref. No.</b> 7472037 BAAN310636
	cover cap without piezoelectric igniter		
	<b>GEV No.</b>	110068	<b>Ref. No.</b> 7479041
	knob suitable for Minisit ø 37mm		



			
<b>GEV No.</b>	101132	<b>Ref. No.</b>	7472031
<b>description</b>	gas thermostat SIT type MINISIT 710 t.max. 340°C 100-340°C gas inlet 1/2" gas outlet 3/8" thermocouple connection M9x1 pilot connection M10x1 probe ø 5mm probe L 68mm capillary pipe 1050mm probe type type B1 pressure controller no pressure regulator mbar gland nut ignition gas no		
<b>spare parts for</b>	101132		
	<b>GEV No.</b>	101053	<b>Ref. No.</b> 7473051 BAAN310654
	magnet unit T1: M9x1 T2: M24x1 L 45mm ø 17mm suitable for Minisit		
	<b>GEV No.</b>	102102	<b>Ref. No.</b> —
	probe 100-340°C probe ø 5mm probe L 68mm capillary pipe 1750mm t.max. 340°C oven/grill probe type type B1 suitable for MINISIT 710		
<b>accessories for</b>	101132		
	<b>GEV No.</b>	100809	<b>Ref. No.</b> —
	O-ring EPDM thickness 2mm ID ø 21mm Qty 1 pcs		
	<b>GEV No.</b>	100904	<b>Ref. No.</b> —
	locking screw M10x1 for pipe ø 4mm Qty 1 pcs		
	<b>GEV No.</b>	100905	<b>Ref. No.</b> —
	locking screw M10x1 for pipe ø 6mm Qty 1 pcs		
	<b>GEV No.</b>	101054	<b>Ref. No.</b> —
	magnet unit T1: M10x1 T2: M24x1 L 45mm ø 17mm suitable for Minisit		
	<b>GEV No.</b>	101136	<b>Ref. No.</b> —
	piezoelectric igniter suitable for Minisit with cover cap ømm connection F6.3x0.8		
	<b>GEV No.</b>	101137	<b>Ref. No.</b> 7472037 BAAN310636
	cover cap without piezoelectric igniter		
	<b>GEV No.</b>	101267	<b>Ref. No.</b> —
	reducer IT 3/8" ET 1/2" L 21mm		
	<b>GEV No.</b>	101268	<b>Ref. No.</b> —
	gas connection thread 3/8" angled with O-ring MINISIT 710		
	<b>GEV No.</b>	101269	<b>Ref. No.</b> —
	gas connection thread 1/2" angled with O-ring MINISIT 710		
	<b>GEV No.</b>	101270	<b>Ref. No.</b> —
	screw connection IT 3/8" ET 3/8" L 28mm		
	<b>GEV No.</b>	101272	<b>Ref. No.</b> —
	screw connection IT 1/2" ET 3/8" L 57mm		
	<b>GEV No.</b>	101273	<b>Ref. No.</b> —
	olive for pipe ø 12mm L 9.5mm brass Qty 1 pcs suitable for universal		
	<b>GEV No.</b>	101274	<b>Ref. No.</b> —
	olive for pipe ø 16mm Qty 1 pcs		

<b>accessories for</b>	101132		
	<b>GEV No.</b>	101275	<b>Ref. No.</b> —
	union screw thread 1/2" for pipe ø 16mm Qty 1 pcs		
	<b>GEV No.</b>	101276	<b>Ref. No.</b> —
	union screw thread 3/8" tube ø 12mm Qty 1 pcs		
	<b>GEV No.</b>	110068	<b>Ref. No.</b> 7479041
	knob suitable for Minisit ø 37mm		













			
<b>GEV No.</b>	101130	<b>Ref. No.</b>	7472022 BAAN310629
<b>description</b>	gas thermostat without cap, button and angle SIT type MINISIT 710 t.max. 100°C 30-100°C gas inlet 1/2" gas outlet 3/8" thermocouple connection M9x1 pilot connection M10x1 probe ø 5mm probe L 122mm capillary pipe 1050mm probe type type A1 pressure controller no pressure regulator mbar gland nut		
<b>spare parts for</b>	101130		
	<b>GEV No.</b>	101053	<b>Ref. No.</b> 7473051 BAAN310654
	magnet unit T1: M9x1 T2: M24x1 L 45mm ø 17mm suitable for Minisit		
	<b>GEV No.</b>	102100	<b>Ref. No.</b> —
	probe 30-100°C probe ø 5mm probe L 122mm capillary pipe 1050mm t.max. 100°C bain marie probe type type A1 suitable for MINISIT 710		
<b>accessories for</b>	101130		
	<b>GEV No.</b>	100809	<b>Ref. No.</b> —
	O-ring EPDM thickness 2mm ID ø 21mm Qty 1 pcs		
	<b>GEV No.</b>	100820	<b>Ref. No.</b> —
	gland duct ET M14x1.5 IT M10x0.75 probe ø max. 6.5mm WS 22		
	<b>GEV No.</b>	100904	<b>Ref. No.</b> —
	locking screw M10x1 for pipe ø 4mm Qty 1 pcs		
	<b>GEV No.</b>	100905	<b>Ref. No.</b> —
	locking screw M10x1 for pipe ø 6mm Qty 1 pcs		
	<b>GEV No.</b>	101054	<b>Ref. No.</b> —
	magnet unit T1: M10x1 T2: M24x1 L 45mm ø 17mm suitable for Minisit		
	<b>GEV No.</b>	101136	<b>Ref. No.</b> —
	piezoelectric igniter suitable for Minisit with cover cap ømm connection F6.3x0.8		
	<b>GEV No.</b>	101137	<b>Ref. No.</b> 7472037 BAAN310636
	cover cap without piezoelectric igniter		
	<b>GEV No.</b>	101267	<b>Ref. No.</b> —
	reducer IT 3/8" ET 1/2" L 21mm		



Table continues overleaf



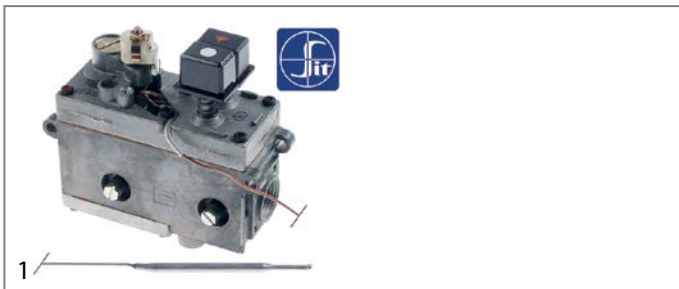











accessories for		101130	
	GEV No.	101268	Ref. No. —
gas connection thread 3/8" angled with O-ring MINISIT 710			
	GEV No.	101269	Ref. No. —
gas connection thread 1/2" angled with O-ring MINISIT 710			
	GEV No.	101270	Ref. No. —
screw connection IT 3/8" ET 3/8" L 28mm			
	GEV No.	101272	Ref. No. —
screw connection IT 1/2" ET 3/8" L 57mm			
	GEV No.	101273	Ref. No. —
olive for pipe ø 12mm L 9.5mm brass Qty 1 pcs suitable for universal			
	GEV No.	101274	Ref. No. —
olive for pipe ø 16mm Qty 1 pcs			
	GEV No.	101275	Ref. No. —
union screw thread 1/2" for pipe ø 16mm Qty 1 pcs			
	GEV No.	101276	Ref. No. —
union screw thread 3/8" tube ø 12mm Qty 1 pcs			
	GEV No.	110068	Ref. No. 7479041
knob suitable for Minisit ø 37mm			







<b>GEV No.</b>	101131	<b>Ref. No.</b>	7472030 BAAN1209943 BAAN310633
<b>description</b>	gas thermostat without cap, button and angle SIT type MINISIT 710 t.max. 190°C 50-190°C gas inlet 1/2" gas outlet 3/8" thermocouple connection M9x1 pilot connection M10x1 probe ø 5mm probe L 98mm capillary pipe 1200mm probe type type A2 pressure controller no pressure regulator mbar gland nut		

spare parts for		101131	
	GEV No.	101053	Ref. No. 7473051 BAAN310654
magnet unit T1: M9x1 T2: M24x1 L 45mm ø 17mm suitable for Minisit			
	GEV No.	102103	Ref. No. —
probe 60-200°C probe ø 5mm probe L 98mm capillary pipe 1050mm t.max. 200°C fryer probe type type A2 suitable for MINISIT 710			

accessories for		101131	
	GEV No.	100809	Ref. No. —
O-ring EPDM thickness 2mm ID ø 21mm Qty 1 pcs			
	GEV No.	100820	Ref. No. —
gland duct ET M14x1.5 IT M10x0.75 probe ø max. 6.5mm WS 22			
	GEV No.	100904	Ref. No. —
locking screw M10x1 for pipe ø 4mm Qty 1 pcs			

accessories for		101131	
	GEV No.	100905	Ref. No. —
locking screw M10x1 for pipe ø 6mm Qty 1 pcs			
	GEV No.	101054	Ref. No. —
magnet unit T1: M10x1 T2: M24x1 L 45mm ø 17mm suitable for Minisit			
	GEV No.	101136	Ref. No. —
piezoelectric igniter suitable for Minisit with cover cap ømm connection F6.3x0.8			
	GEV No.	101137	Ref. No. 7472037 BAAN310636
cover cap without piezoelectric igniter			
	GEV No.	101267	Ref. No. —
reducer IT 3/8" ET 1/2" L 21mm			
	GEV No.	101268	Ref. No. —
gas connection thread 3/8" angled with O-ring MINISIT 710			
	GEV No.	101269	Ref. No. —
gas connection thread 1/2" angled with O-ring MINISIT 710			
	GEV No.	101270	Ref. No. —
screw connection IT 3/8" ET 3/8" L 28mm			
	GEV No.	101272	Ref. No. —
screw connection IT 1/2" ET 3/8" L 57mm			
	GEV No.	101273	Ref. No. —
olive for pipe ø 12mm L 9.5mm brass Qty 1 pcs suitable for universal			
	GEV No.	101274	Ref. No. —
olive for pipe ø 16mm Qty 1 pcs			
	GEV No.	101275	Ref. No. —
union screw thread 1/2" for pipe ø 16mm Qty 1 pcs			
	GEV No.	101276	Ref. No. —
union screw thread 3/8" tube ø 12mm Qty 1 pcs			
	GEV No.	110068	Ref. No. 7479041
knob suitable for Minisit ø 37mm			



			
1			
<b>GEV No.</b>	107237	<b>Ref. No.</b>	7472030 BAAN1209943 BAAN310633
<b>description</b>	gas thermostat without cap, button and angle SIT type MINISIT 710 t.max. 210°C 70-210°C gas inlet 1/2" gas outlet 3/8" thermocouple connection M9x1 pilot connection M10x1 probe ø 4mm probe L 122mm capillary pipe 1300mm probe type pressure controller no pressure regulator bar gland nut		
<b>accessories for</b>	107237		
	<b>GEV No.</b>	101137	<b>Ref. No.</b> 7472037 BAAN310636
	cover cap without piezoelectric igniter		
	<b>GEV No.</b>	101267	<b>Ref. No.</b> —
	reducer IT 3/8" ET 1/2" L 21mm		
	<b>GEV No.</b>	101268	<b>Ref. No.</b> —
	gas connection thread 3/8" angled with O-ring MINISIT 710		
	<b>GEV No.</b>	110068	<b>Ref. No.</b> 7479041
	knob suitable for Minisit ø 37mm		

<b>accessories for</b>	101172		
	<b>GEV No.</b>	101246	<b>Ref. No.</b> —
	olive for pipe ø 4mm Qty 1 pcs		
	<b>GEV No.</b>	101278	<b>Ref. No.</b> —
	olive for pipe ø 10mm Qty 1 pcs		
	<b>GEV No.</b>	101286	<b>Ref. No.</b> —
	olive ID ø 6mm Qty 1 pcs		
	<b>GEV No.</b>	101300	<b>Ref. No.</b> —
	union nut thread M16x1.5 tube ø 10mm		
	<b>GEV No.</b>	101450	<b>Ref. No.</b> —
	olive for pipe ø 8mm L 12.7mm Qty 1 pcs ED ø 10mm		
	<b>GEV No.</b>	101451	<b>Ref. No.</b> —
	union nut thread M16x1.5 tube ø 8mm		
	<b>GEV No.</b>	110079	<b>Ref. No.</b> —
	knob dial plate gas thermostat 1-8 silver		
	<b>GEV No.</b>	110081	<b>Ref. No.</b> 171475
	knob ø 70mm shaft ø 8x6.5mm shaft flat universal		

## gas valves and ignition boxes

### gas control valves

#### ROBERTSHAW

#### electric controlled valves

### PEL

#### 25ST series

			
1			
<b>GEV No.</b>	101172	<b>Ref. No.</b>	310137
<b>description</b>	gas thermostat PEL type 25ST 100-300°C gas inlet M16x1.5 (tube ø 10mm) bypass nozzle ø 0.35mm gas outlet M16x1.5 (tube ø 10/8mm) thermocouple connection M9x1 pilot connection M10x1 capillary pipe 1200mm probe ø 6mm probe L 100mm shaft ø 8x6.5mm shaft L 21/15mm shaft flat upper		
<b>spare parts for</b>	101172		
	<b>GEV No.</b>	100259	<b>Ref. No.</b> —
	bypass nozzle type PEL22 bore ø 0.35mm thread M6x0.5		
	<b>GEV No.</b>	101060	<b>Ref. No.</b> 7473048 BAAN310651
	magnet unit standard L 39mm D1 ø 15.4mm D2 ø 11mm suitable for PEL20-21/JUNKERS/EGA		
	<b>GEV No.</b>	106200	<b>Ref. No.</b> —
	nut thread M9x1 suitable for PEL 24/25S		
<b>accessories for</b>	101172		
	<b>GEV No.</b>	100908	<b>Ref. No.</b> —
	union screw thread M10x1 for pipe ø 4mm Qty 1 pcs		
	<b>GEV No.</b>	100909	<b>Ref. No.</b> —
	union screw thread M10x1 for pipe ø 6mm Qty 1 pcs		





			
1			
<b>GEV No.</b>	101388	<b>Ref. No.</b>	7473017
<b>description</b>	gas valve supply 220-240VAC supply VDC 50/60Hz gas inlet 3/4" NPT gas outlet 3/4" NPT thermocouple connection 11/32" pilot connection 1/4" CCT type U7000ER-240--S7CL/s pressure controller natural gas 6.7" W.C. suitable for ROBERTSHAW		
<b>spare parts for</b>	101388		
	<b>GEV No.</b>	101047	<b>Ref. No.</b> —
	magnet unit T1: ASA 11/32 T2: M24x1 L 59mm ø 4mm suitable for ROBERTSHAW		
	<b>GEV No.</b>	580033	<b>Ref. No.</b> —
	knob suitable for ROBERTSHAW		
<b>accessories for</b>	101388		
	<b>GEV No.</b>	102122	<b>Ref. No.</b> —
	thermocouple ROBERTSHAW ASA 11/32 L 18" - 455mm 7/16"		

Table continues overleaf



<b>accessories for</b>	101388		
<b>GEV No.</b>	102277	<b>Ref. No.</b>	—
	thermocouple ROBERTSHAW ASA 11/32 L 36" - 915mm 7/16"		









**SIT**  
**ELETTROSIT**



<b>GEV No.</b>	101127	<b>Ref. No.</b>	7472025 BAAN1209942 BAAN310630
<b>description</b>	gas valve SIT type ELETTROSIT 230V gas inlet 3/4" gas outlet 3/4" thermocouple connection M9x1 pilot connection M10x1 lateral equiv. no. 0.810.175		
<b>spare parts for</b>	101127		
	<b>GEV No.</b>	101312	<b>Ref. No.</b> —
	microswitch		
	<b>GEV No.</b>	101352	<b>Ref. No.</b> —
	solenoid coil 230V 50Hz suitable for ELETTROSIT		
<b>accessories for</b>	101127		
	<b>GEV No.</b>	100006	<b>Ref. No.</b> —
	piezoelectric igniter suitable for ELETTROSIT body plastic blowing connection ø2.4mm ø 14mm		
	<b>GEV No.</b>	100904	<b>Ref. No.</b> —
	locking screw M10x1 for pipe ø 4mm Qty 1 pcs		
	<b>GEV No.</b>	100905	<b>Ref. No.</b> —
	locking screw M10x1 for pipe ø 6mm Qty 1 pcs		
	<b>GEV No.</b>	101301	<b>Ref. No.</b> —
	gas connection thread 1/2" straight ELETTROSIT screw with O-ring		
	<b>GEV No.</b>	101303	<b>Ref. No.</b> —
	gas connection straight thread 3/4" ELETTROSIT		
	<b>GEV No.</b>	101309	<b>Ref. No.</b> —
	extension		

**TANDEM**



<b>GEV No.</b>	101189	<b>Ref. No.</b>	310305 BAAN829205 BAAN847641
<b>description</b>	gas valve 230V 50Hz gas inlet 1/2" gas outlet 1/2" pilot connection M10x1 level slow ignition ignition times pressure range 3-50mbar power supply for modulator equiv. no. 0.830.040 suitable for Tandem		
<b>spare parts for</b>	101189		
	<b>GEV No.</b>	101379	<b>Ref. No.</b> —
	solenoid coil 230V 50Hz suitable for Tandem		
<b>accessories for</b>	101189		
	<b>GEV No.</b>	100904	<b>Ref. No.</b> —
	locking screw M10x1 for pipe ø 4mm Qty 1 pcs		
	<b>GEV No.</b>	100905	<b>Ref. No.</b> —
	locking screw M10x1 for pipe ø 6mm Qty 1 pcs		
	<b>GEV No.</b>	101274	<b>Ref. No.</b> —
	olive for pipe ø 16mm Qty 1 pcs		
	<b>GEV No.</b>	101275	<b>Ref. No.</b> —
	union screw thread 1/2" for pipe ø 16mm Qty 1 pcs		
	<b>GEV No.</b>	101925	<b>Ref. No.</b> —
	plug with O-ring thread M10x1 for pilot burner suitable for NOVASIT		
	<b>GEV No.</b>	102845	<b>Ref. No.</b> —
	gas connection angled 1/2" flange 32x32mm hole distance 24x24mm Tandem		
	<b>GEV No.</b>	102846	<b>Ref. No.</b> —
	gas connection straight 1/2" flange 32x32mm hole distance 24x24mm suitable for Tandem		
	<b>GEV No.</b>	102847	<b>Ref. No.</b> —
	O-ring		





1

<b>GEV No.</b>	107831	<b>Ref. No.</b>	310196
<b>description</b>	gas valve 230V 50Hz gas inlet 1/2" gas outlet 1/2" pilot connection M10x1 pressure range 3-50mbar type Tandem 830 SIT equiv. no. 0.830.030		
<b>spare parts for</b>	107831		
	<b>GEV No.</b>	101379	<b>Ref. No.</b> —
	solenoid coil 230V 50Hz suitable for Tandem		
<b>accessories for</b>	107831		
	<b>GEV No.</b>	100904	<b>Ref. No.</b> —
	locking screw M10x1 for pipe ø 4mm Qty 1 pcs		
	<b>GEV No.</b>	100905	<b>Ref. No.</b> —
	locking screw M10x1 for pipe ø 6mm Qty 1 pcs		
	<b>GEV No.</b>	101274	<b>Ref. No.</b> —
	olive for pipe ø 16mm Qty 1 pcs		
	<b>GEV No.</b>	101275	<b>Ref. No.</b> —
	union screw thread 1/2" for pipe ø 16mm Qty 1 pcs		
	<b>GEV No.</b>	101925	<b>Ref. No.</b> —
	plug with O-ring thread M10x1 for pilot burner suitable for NOVASIT		
	<b>GEV No.</b>	102845	<b>Ref. No.</b> —
	gas connection angled 1/2" flange 32x32mm hole distance 24x24mm Tandem		
	<b>GEV No.</b>	102846	<b>Ref. No.</b> —
	gas connection straight 1/2" flange 32x32mm hole distance 24x24mm suitable for Tandem		
	<b>GEV No.</b>	102847	<b>Ref. No.</b> —
	O-ring		

ignition boxes

SIT



1

<b>GEV No.</b>	102387	<b>Ref. No.</b>	310197 BAAN172267 BAAN304937
<b>description</b>	ignition box SIT type 503EFD electrodes 1 waiting time 1.5s safety time 60s 220/240V 12VA 50-60Hz protection IP20		



1

<b>GEV No.</b>	107519	<b>Ref. No.</b>	310324 BAAN1064197 BAAN1067290
<b>description</b>	ignition box SIT type 579DBC electrodes 2 waiting time 3s safety time 5s 220/240V 12VA 50/60Hz		



safety valves

SIT

440 series



1

<b>GEV No.</b>	101101	<b>Ref. No.</b>	7473027
<b>description</b>	gas valve pressure range 50mbar gas inlet 3/4" gas outlet 3/4" pilot connection M10x1 (tube ø 6mm) thermocouple connection M9x1 type SIT D3		
<b>accessories for</b>	101101		
	<b>GEV No.</b>	100904	<b>Ref. No.</b> —
	locking screw M10x1 for pipe ø 4mm Qty 1 pcs		
	<b>GEV No.</b>	100905	<b>Ref. No.</b> —
	locking screw M10x1 for pipe ø 6mm Qty 1 pcs		



## ignition parts

## pilot burners

SIT

100 series













1

<b>GEV No.</b>	107337	<b>Ref. No.</b>	2020122 905107 BAAN1074407 BAAN1210152 V2020122
<b>description</b>	pilot burner SIT type 100 series 1 flame nozzle $\phi$ 0.2/0.4mm gas connection 4/6mm set		



1

<b>GEV No.</b>	106906	<b>Ref. No.</b>	2020124 7434003
<b>description</b>	pilot burner SIT type 100 series 3 flames nozzle $\phi$ 0.2mm gas connection 6mm		
<b>spare parts for</b>	106906		
	<b>GEV No.</b>	100245	<b>Ref. No.</b> —
	pilot burner nozzle LPG code 20 bore $\phi$ 0.2mm Qty 1 pcs thread M8x0.75		
	<b>GEV No.</b>	100855	<b>Ref. No.</b> —
	pilot burner bracket triple		
	<b>GEV No.</b>	100885	<b>Ref. No.</b> —
	air mixing sleeve for pilot burner Qty 1 pcs		
	<b>GEV No.</b>	100916	<b>Ref. No.</b> —
	compression spring for pilot burner Qty 1 pcs		
	<b>GEV No.</b>	100917	<b>Ref. No.</b> —
	gasket for pilot burner Qty 1 pcs aluminium		
	<b>GEV No.</b>	100918	<b>Ref. No.</b> —
	screw for pilot burner		
	<b>GEV No.</b>	107162	<b>Ref. No.</b> —
	pilot burner cap SIT 3 flames Hmm Lmm Qty 1 pcs		
	<b>GEV No.</b>	107701	<b>Ref. No.</b> —
	pilot burner bottom part SIT 100 series nozzle $\phi$ 0.2mm		
<b>accessories for</b>	106906		
	<b>GEV No.</b>	100245	<b>Ref. No.</b> —
	pilot burner nozzle LPG code 20 bore $\phi$ 0.2mm Qty 1 pcs thread M8x0.75		

<b>accessories for</b>	106906		
	<b>GEV No.</b>	100246	<b>Ref. No.</b> —
	pilot burner nozzle natural gas bore $\phi$ 0.35mm Qty 1 pcs thread M8x0.75		
	<b>GEV No.</b>	100904	<b>Ref. No.</b> —
	locking screw M10x1 for pipe $\phi$ 4mm Qty 1 pcs		
	<b>GEV No.</b>	100905	<b>Ref. No.</b> —
	locking screw M10x1 for pipe $\phi$ 6mm Qty 1 pcs		
	<b>GEV No.</b>	102110	<b>Ref. No.</b> —
	pilot tube copper pipe $\phi$ 4mm thickness 1mm L 3000mm		
	<b>GEV No.</b>	102111	<b>Ref. No.</b> —
	pilot tube copper pipe $\phi$ 6mm thickness 1mm L 3000mm		
	<b>GEV No.</b>	107171	<b>Ref. No.</b> —
	pilot burner nozzle SIT natural/liquid gas bore $\phi$ 0.25mm Qty 1 pcs		
	<b>GEV No.</b>	107700	<b>Ref. No.</b> —
	pilot burner bottom part SIT 100 series nozzle $\phi$ 0.25mm		
	<b>GEV No.</b>	107702	<b>Ref. No.</b> —
	pilot burner bottom part SIT 100 series nozzle $\phi$ 0.35mm		

## accessories

## ignition electrodes



<b>GEV No.</b>	100707	<b>Ref. No.</b>	7455048
<b>description</b>	ignition electrode D1 $\phi$ 7mm D2 $\phi$ 9mm connection $\phi$ 2.4mm L1 14mm L2 6mm BL1 18mm BL2 3mm BL3 23mm to clip Qty 1 pcs		

## 160 series



1













<b>GEV No.</b>	102946	<b>Ref. No.</b>	310272 BAAN827901 BAAN838024
<b>description</b>	pilot burner SIT type 160 series 3 flames nozzle $\phi$ mm gas connectionmm		
<b>spare parts for</b>	102946		
	<b>GEV No.</b>	100202	<b>Ref. No.</b> —
	pilot burner nozzle natural gas code 41 Qty 1 pcs nozzle $\phi$ 0.41mm		



Table continues overleaf









<b>spare parts for</b> 102946			
	GEV No.	100701	Ref. No. 308480 BAAN824045 BAAN838031
ignition electrode connection M4 Qty 1 pcs			
	GEV No.	100906	Ref. No. 317980 BAAN829766 BAAN838033
screw connection thread M10x1 for ignition electrode brass Qty 1 pcs WS 10			
	GEV No.	100907	Ref. No. 317979 BAAN829767 BAAN838027
screw connection thread M10x1 Qty 1 pcs type SEF 1 ømm for thermocouple			
	GEV No.	100909	Ref. No. —
union screw thread M10x1 for pipe ø 6mm Qty 1 pcs			
	GEV No.	101287	Ref. No. 310275 BAAN825615 BAAN838028
olive for pipe ø 6mm Qty 1 pcs			
<b>accessories for</b> 102946			
	GEV No.	100203	Ref. No. —
pilot burner nozzle LPG code 25 Qty 1 pcs nozzle ø 0.25mm			
	GEV No.	100869	Ref. No. —
pilot burner nozzle natural gas code 51 Qty 1 pcs suitable for 160 series nozzle ø 0.51mm			
	GEV No.	100908	Ref. No. —
union screw thread M10x1 for pipe ø 4mm Qty 1 pcs			
	GEV No.	101282	Ref. No. —
olive for pipe ø 4mm L 7.4mm Qty 1 pcs			
	GEV No.	107650	Ref. No. 311171
pilot burner nozzle SIT LPG code 30 Qty 1 pcs			

HONEYWELL			
pilot burners			
			
1			
<b>GEV No.</b>	102886	<b>Ref. No.</b>	310148 BAAN169431 BAAN304903
<b>description</b>	pilot burner 1 flame		
<b>accessories for</b> 102886			
	GEV No.	102888	Ref. No. —
pilot burner nozzle HONEYWELL natural gas bore ø 0.51mm model Q349			
	GEV No.	102889	Ref. No. 310150 BAAN169433 BAAN304905
pilot burner nozzle HONEYWELL LPG bore ø 0.25mm model Q349			

<b>accessories for</b> 102886			
	GEV No.	102892	Ref. No. 308468 310215 BAAN169391 BAAN304828
ignition electrode D1 ø 6mm L1 22mm BL1 25mm BL2 19mm connection F 2.8x0.8mm M8x10			

			
1			
<b>GEV No.</b>	102887	<b>Ref. No.</b>	310092 BAAN167363 BAAN304882
<b>description</b>	pilot burner HONEYWELL type Q327 3 flames		
<b>accessories for</b> 102887			
	GEV No.	102891	Ref. No. 310091 BAAN167362 BAAN304881
pilot burner nozzle HONEYWELL LPG code KR14 model Q3480, Q3481, Q348, Q179, Q327			
	GEV No.	107496	Ref. No. —
pilot burner nozzle HONEYWELL natural gas code NE22 model Q3480, Q3481, Q348, Q179, Q327			

			
1			
<b>GEV No.</b>	107495	<b>Ref. No.</b>	132885 BAAN172129 BAAN860936
<b>description</b>	pilot burner HONEYWELL type Q327 3 flames natural gas nozzle NE22 with ignition electrode		
<b>spare parts for</b> 107495			
	GEV No.	102887	Ref. No. 310092 BAAN167363 BAAN304882
pilot burner HONEYWELL type Q327 3 flames			
	GEV No.	102892	Ref. No. 308468 310215 BAAN169391 BAAN304828
ignition electrode D1 ø 6mm L1 22mm BL1 25mm BL2 19mm connection F 2.8x0.8mm M8x10			
	GEV No.	102905	Ref. No. —
locking screw thread M11x1 ø 6mm			
	GEV No.	102981	Ref. No. 308469 BAAN169392 BAAN304829
ignition electrode D1 ø 7mm L1 30mm BL1 24mm BL2 21.5mm connection F2.8x0.8 cable length 1300mm 1/8"			
	GEV No.	107496	Ref. No. —
pilot burner nozzle HONEYWELL natural gas code NE22 model Q3480, Q3481, Q348, Q179, Q327			



producer-specific pilot burners

BONNET



1

<b>GEV No.</b>	101293	<b>Ref. No.</b>	014073M BAAN1027483 BAAN825612
<b>description</b>	flat gasket aluminium ED ø 14mm ID ø 10.3mm for pilot burner Qty 1 pcs		



1

<b>GEV No.</b>	102949	<b>Ref. No.</b>	368146 BAAN820515 BAAN834387
<b>description</b>	pilot burner gas connection M10x1mm		



1

<b>GEV No.</b>	102948	<b>Ref. No.</b>	140309 BAAN943443 BAAN963043
<b>description</b>	pilot burner bottom part		



1

<b>GEV No.</b>	102947	<b>Ref. No.</b>	368147 BAAN834245 BAAN834385
<b>description</b>	pilot burner head thread M10x1		



1

<b>GEV No.</b>	101293	<b>Ref. No.</b>	014073M BAAN1027483 BAAN825612
<b>description</b>	flat gasket aluminium ED ø 14mm ID ø 10.3mm for pilot burner Qty 1 pcs		



1

<b>GEV No.</b>	102949	<b>Ref. No.</b>	368146 BAAN820515 BAAN834387
<b>description</b>	pilot burner gas connection M10x1mm		



1

<b>GEV No.</b>	104632	<b>Ref. No.</b>	165527 BAAN1071743 BAAN1120945
<b>description</b>	pilot burner bottom part thread 1/8"		



1

<b>GEV No.</b>	104634	<b>Ref. No.</b>	140869 BAAN1027486 BAAN829845
<b>description</b>	pilot burner bracket		



1

<b>GEV No.</b>	104631	<b>Ref. No.</b>	368234 BAAN1027487 BAAN820513
<b>description</b>	pilot burner head 2 thread M10x1		
<b>accessories for</b>	104631		



<b>GEV No.</b>	107172	<b>Ref. No.</b>	310274 BAAN834138 BAAN838035
<b>description</b>	pilot burner nozzle SIT LPG code 25 Qty 1 pcs		



<b>GEV No.</b>	107173	<b>Ref. No.</b>	—
<b>description</b>	pilot burner nozzle SIT natural gas code 35 Qty 1 pcs suitable for 160 series nozzle ø 0.35mm		



<b>GEV No.</b>	107174	<b>Ref. No.</b>	310273 BAAN829765 BAAN838038
<b>description</b>	pilot burner nozzle SIT natural gas code 41 Qty 1 pcs		





<b>GEV No.</b>	107649	<b>Ref. No.</b>	311170 BAAN71621E BAAN825618 BAAN860092
<b>description</b>	pilot burner nozzle SIT LPG code 20 Qty 1 pcs		



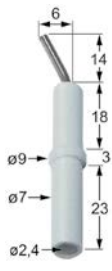

			
<b>GEV No.</b>	107337	<b>Ref. No.</b>	2020122 905107 BAAN1074407 BAAN1210152 V2020122
<b>description</b>	pilot burner SIT type 100 series 1 flame nozzle $\phi$ 0.2/0.4mm gas connection 4/6mm set		

			
<b>GEV No.</b>	100707	<b>Ref. No.</b>	7455048
<b>description</b>	ignition electrode D1 $\phi$ 7mm D2 $\phi$ 9mm connection $\phi$ 2.4mm L1 14mm L2 6mm BL1 18mm BL2 3mm BL3 23mm to clip Qty 1 pcs		

**electrodes**

			
<b>GEV No.</b>	100701	<b>Ref. No.</b>	308480 BAAN824045 BAAN838031
<b>description</b>	ignition electrode connection M4 Qty 1 pcs		
<b>accessories for</b>	100701		
			
<b>GEV No.</b>	100906	<b>Ref. No.</b>	317980 BAAN829766 BAAN838033
<b>description</b>	screw connection thread M10x1 for ignition electrode brass Qty 1 pcs WS 10		

			
<b>GEV No.</b>	102981	<b>Ref. No.</b>	308469 BAAN169392 BAAN304829
<b>description</b>	ignition electrode D1 $\phi$ 7mm L1 30mm BL1 24mm BL2 21.5mm connection F2.8x0.8 cable length 1300mm 1/8"		

			
<b>GEV No.</b>	100906	<b>Ref. No.</b>	317980 BAAN829766 BAAN838033
<b>description</b>	screw connection thread M10x1 for ignition electrode brass Qty 1 pcs WS 10		

			
<b>GEV No.</b>	102892	<b>Ref. No.</b>	308468 310215 BAAN169391 BAAN304828
<b>description</b>	ignition electrode D1 $\phi$ 6mm L1 22mm BL1 25mm BL2 19mm connection F 2.8x0.8mm M8x10		

**ignition cables**

<p>pre-assembled cables</p> 			
<b>GEV No.</b>	100176	<b>Ref. No.</b>	307997
<b>description</b>	ignition cable cable length 1000mm connection $\phi$ 2.4mm / $\phi$ 4mm permanent temperature 200°C		

			
<b>GEV No.</b>	102155	<b>Ref. No.</b>	140379 307997 BAAN1005882 BAAN1207836 BAAN829847 BAAN975565
<b>description</b>	ignition cable cable length 900mm connection $\phi$ 4mm / F2.8mm		

ignition units



1

<b>GEV No.</b>	102485	<b>Ref. No.</b>	308465
<b>description</b>	ignition unit outputs 2 220-240VAC 0.6VA 50-60Hz		



1

<b>GEV No.</b>	101002	<b>Ref. No.</b>	308465
<b>description</b>	ignition unit outputs 2 230VAC dimensions 88x23x34mm mounting distance 73mm inlet F6.3x0.8 outlet F2.8x0.8 0.6VA 50/60Hz		



1

<b>GEV No.</b>	102388	<b>Ref. No.</b>	308466 680782 BAAN308466
<b>description</b>	ignition unit outputs 4 230VAC dimensions 111x23x34mm mounting distance 100mm inlet F6.3x0.8 outlet F2.8x0.8 type WAC-T4 0.6VA 50/60Hz		

thermocouples

thermocouple sets universal



1

<b>GEV No.</b>	107648	<b>Ref. No.</b>	7473055
<b>description</b>	thermocouple set SIT 11-piece L 1200mm		

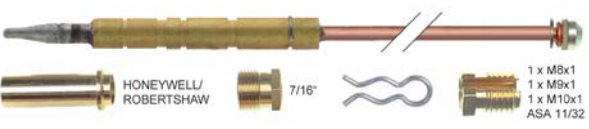

1

<b>GEV No.</b>	102284	<b>Ref. No.</b>	310144 BAAN169427
<b>description</b>	thermocouple set 8-piece L 900mm		



1

<b>GEV No.</b>	102286	<b>Ref. No.</b>	634321
<b>description</b>	thermocouple set 8-piece L 900mm flexible		

plug-in thermocouples

plug-in thermocouples standard

with barrel socket ø6(6.5)mm

thermocouples SIT

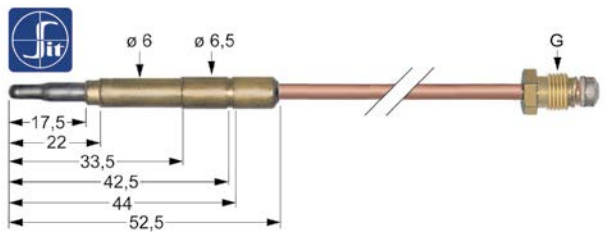

1

<b>GEV No.</b>	102682	<b>Ref. No.</b>	310276 7473056 BAAN310657 BAAN840079
<b>description</b>	thermocouple SIT aluminized tip M9x1 L 850mm plug connection ø6.0(6.5)mm		

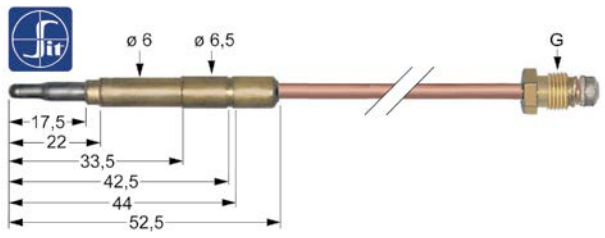

1

<b>GEV No.</b>	107613	<b>Ref. No.</b>	310277 7473029 BAAN310646
<b>description</b>	thermocouple SIT M9x1 L 1200mm plug connection ø6.0(6.5)mm		

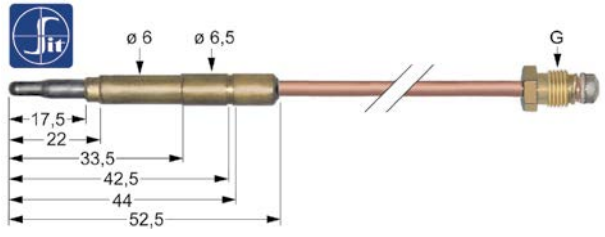

1

<b>GEV No.</b>	107614	<b>Ref. No.</b>	7473034
<b>description</b>	thermocouple SIT M9x1 L 1500mm plug connection ø6.0(6.5)mm		



<b>GEV No.</b>	107611	<b>Ref. No.</b>	7473056
<b>description</b>	thermocouple SIT M9x1 L 850mm plug connection ø6.0(6.5)mm		

thermocouples with aluminised tip

<b>GEV No.</b>	102077	<b>Ref. No.</b>	172265 310193 7473055
<b>description</b>	thermocouple M10x1 L 1500mm plug connection ø6.0(6.5)mm		

threaded thermocouples  
threaded thermocouples standard  
with socket with thread M8x1

SIT

<b>GEV No.</b>	107634	<b>Ref. No.</b>	310193
<b>description</b>	thermocouple SIT M8x1 L 1500mm M8x1		
<b>accessories for</b>	107634		
	<b>GEV No.</b>	<b>Ref. No.</b>	—
	nut thread M8x1 H 3mm brass Qty 1 pcs type SEF 1		

extensions

<b>GEV No.</b>	102811	<b>Ref. No.</b>	7492000
<b>description</b>	thermocouple extension thread M9x1 - M9x1 L 600mm		

accessories

interrupters

<b>GEV No.</b>	580046	<b>Ref. No.</b>	N/A
<b>description</b>	extension for interruptor L 18'' - 455mm		

<b>GEV No.</b>	101265	<b>Ref. No.</b>	605680 905680
<b>description</b>	interrupter thread M9x1		

gas burners  
hob burners

producer-specific hob burners

BONNET

universal

<b>GEV No.</b>	108140	<b>Ref. No.</b>	1256950 BAAN1320490 BAAN301946
<b>description</b>	air mixing sleeve		

<b>GEV No.</b>	107030	<b>Ref. No.</b>	N/A
<b>description</b>	burner ø 130mm complete		



<b>GEV No.</b>	108026	<b>Ref. No.</b>	7505097 BAAN311057
<b>description</b>	burner cap ø 100mm mounting ø 84mm		





1 gas components

 1			
<b>GEV No.</b>	108027	<b>Ref. No.</b>	7505098 BAAN311058
<b>description</b>	burner cap ø 130mm		



 1			
<b>GEV No.</b>	108119	<b>Ref. No.</b>	322389 BAAN305375
<b>description</b>	burner head for burner cap ø 100mm		
<b>accessories for</b>	108119		
	<b>GEV No.</b>	108026	<b>Ref. No.</b>
			7505097 BAAN311057
	burner cap ø 100mm mounting ø 84mm		



 1			
<b>GEV No.</b>	108120	<b>Ref. No.</b>	322390 BAAN305376
<b>description</b>	burner head for burner cap ø 130mm		
<b>accessories for</b>	108120		
	<b>GEV No.</b>	108027	<b>Ref. No.</b>
			7505098 BAAN311058
	burner cap ø 130mm		



 1			
<b>GEV No.</b>	108136	<b>Ref. No.</b>	368150 BAAN847689 BAAN970844
<b>description</b>	venturi L 110mm ø 21.5mm		

<b>miscellaneous</b>			
 1			
<b>GEV No.</b>	108007	<b>Ref. No.</b>	130625 141952 381211 BAAN1207695 BAAN172134 BAAN302027
<b>description</b>	burner cap ø 110mm mounting ø 106mm		
<b>accessories for</b>	108007		
	<b>GEV No.</b>	104636	<b>Ref. No.</b>
			381221 BAAN169576 BAAN305780
	burner holder for burner cap ø 110mm with nozzle holder		

<b>accessories for</b>	108007		
	<b>GEV No.</b>	108094	<b>Ref. No.</b>
			381212 BAAN169570
	burner head for burner cap ø 110mm brass		

 1			
<b>GEV No.</b>	108134	<b>Ref. No.</b>	165013 BAAN1208099 BAAN835234
<b>description</b>	burner cap ø 110mm with central hole		
<b>accessories for</b>	108134		
	<b>GEV No.</b>	104636	<b>Ref. No.</b>
			381221 BAAN169576 BAAN305780
	burner holder for burner cap ø 110mm with nozzle holder		
	<b>GEV No.</b>	108095	<b>Ref. No.</b>
			130627 BAAN1207697 BAAN302029
	burner head for burner cap ø 110mm black		



 1			
<b>GEV No.</b>	108009	<b>Ref. No.</b>	130624 BAAN1207694 BAAN302026
<b>description</b>	burner cap ø 85mm mounting ø 81mm		
<b>accessories for</b>	108009		
	<b>GEV No.</b>	104635	<b>Ref. No.</b>
			381220 BAAN169575 BAAN305779
	burner holder for burner cap ø 85mm with nozzle holder		
	<b>GEV No.</b>	108093	<b>Ref. No.</b>
			130626 BAAN1207696 BAAN302028
	burner head for burner cap ø 85mm black		

 1			
<b>GEV No.</b>	108148	<b>Ref. No.</b>	141951 980462724 BAAN1178944 BAAN172133
<b>description</b>	burner cap ø 85mm mounting ø 81mm		
<b>accessories for</b>	108148		
	<b>GEV No.</b>	104635	<b>Ref. No.</b>
			381220 BAAN169575 BAAN305779
	burner holder for burner cap ø 85mm with nozzle holder		
	<b>GEV No.</b>	108132	<b>Ref. No.</b>
			381210 BAAN169568
	burner head for burner cap ø 85mm brass		











			
1			
<b>GEV No.</b>	108095	<b>Ref. No.</b>	130627 BAAN1207697 BAAN302029
<b>description</b>	burner head for burner cap ø 110mm black		
<b>accessories for</b>	108095		
	<b>GEV No.</b>	104636	<b>Ref. No.</b> 381221 BAAN169576 BAAN305780
burner holder for burner cap ø 110mm with nozzle holder			
	<b>GEV No.</b>	108134	<b>Ref. No.</b> 165013 BAAN1208099 BAAN835234
burner cap ø 110mm with central hole			

			
1			
<b>GEV No.</b>	108132	<b>Ref. No.</b>	381210 BAAN169568
<b>description</b>	burner head for burner cap ø 85mm brass		
<b>accessories for</b>	108132		
	<b>GEV No.</b>	104635	<b>Ref. No.</b> 381220 BAAN169575 BAAN305779
burner holder for burner cap ø 85mm with nozzle holder			
	<b>GEV No.</b>	108148	<b>Ref. No.</b> 141951 980462724 BAAN1178944 BAAN172133
burner cap ø 85mm mounting ø 81mm			

			
1			
<b>GEV No.</b>	108094	<b>Ref. No.</b>	381212 BAAN169570
<b>description</b>	burner head for burner cap ø 110mm brass		
<b>accessories for</b>	108094		
	<b>GEV No.</b>	104636	<b>Ref. No.</b> 381221 BAAN169576 BAAN305780
burner holder for burner cap ø 110mm with nozzle holder			
	<b>GEV No.</b>	108007	<b>Ref. No.</b> 130625 141952 381211 BAAN1207695 BAAN172134 BAAN302027
burner cap ø 110mm mounting ø 106mm			

			
1			
<b>GEV No.</b>	104636	<b>Ref. No.</b>	381221 BAAN169576 BAAN305780
<b>description</b>	burner holder for burner cap ø 110mm with nozzle holder		
<b>accessories for</b>	104636		
	<b>GEV No.</b>	108007	<b>Ref. No.</b> 130625 141952 381211 BAAN1207695 BAAN172134 BAAN302027
burner cap ø 110mm mounting ø 106mm			
	<b>GEV No.</b>	108094	<b>Ref. No.</b> 381212 BAAN169570
burner head for burner cap ø 110mm brass			
	<b>GEV No.</b>	108095	<b>Ref. No.</b> 130627 BAAN1207697 BAAN302029
burner head for burner cap ø 110mm black			
	<b>GEV No.</b>	108134	<b>Ref. No.</b> 165013 BAAN1208099 BAAN835234
burner cap ø 110mm with central hole			

			
1			
<b>GEV No.</b>	108093	<b>Ref. No.</b>	130626 BAAN1207696 BAAN302028
<b>description</b>	burner head for burner cap ø 85mm black		
<b>accessories for</b>	108093		
	<b>GEV No.</b>	104635	<b>Ref. No.</b> 381220 BAAN169575 BAAN305779
burner holder for burner cap ø 85mm with nozzle holder			
	<b>GEV No.</b>	108009	<b>Ref. No.</b> 130624 BAAN1207694 BAAN302026
burner cap ø 85mm mounting ø 81mm			







			
1			
<b>GEV No.</b>	104635	<b>Ref. No.</b>	381220 BAAN169575 BAAN305779
<b>description</b>	burner holder for burner cap ø 85mm with nozzle holder		
<b>accessories for</b>	104635		
	<b>GEV No.</b>	108009	<b>Ref. No.</b> 130624 BAAN1207694 BAAN302026
burner cap ø 85mm mounting ø 81mm			
	<b>GEV No.</b>	108093	<b>Ref. No.</b> 130626 BAAN1207696 BAAN302028
burner head for burner cap ø 85mm black			

Table continues overleaf



1 gas components

<b>accessories for</b> 104635			
	<b>GEV No.</b>	108132	<b>Ref. No.</b> 381210 BAAN169568
burner head for burner cap ø 85mm brass			
	<b>GEV No.</b>	108148	<b>Ref. No.</b> 141951 980462724 BAAN1178944 BAAN172133
burner cap ø 85mm mounting ø 81mm			

	<b>GEV No.</b>	108135	<b>Ref. No.</b> 140823 BAAN971176
<b>description</b> burner pipe			

## bar burners

### bar burners

	<b>GEV No.</b>	104732	<b>Ref. No.</b> 141610 BAAN169184 BAAN302137
<b>description</b> bar burner ø 50mm Wmm Hmm L 350mm			

	<b>GEV No.</b>	104733	<b>Ref. No.</b> 141613 BAAN169187 BAAN302140
<b>description</b> bar burner ø 50mm Wmm Hmm L 490mm			

## accessories

### nozzle holders

	<b>GEV No.</b>	108137	<b>Ref. No.</b> 381301 BAAN835208 BAAN847699
<b>description</b> nozzle holder			

## gas nozzles

### main nozzles



#### gas nozzles M10x1

	<b>GEV No.</b>	106440	<b>Ref. No.</b> 7433039 BAAN1209916 V7433039
<b>description</b> gas injector thread M10x1 WS 11 bore ø 1.85mm			

### pilot burner nozzles

#### pilot burner nozzles HONEYWELL

##### for series Q3480, Q3481, Q348, Q179, Q327

	<b>GEV No.</b>	102891	<b>Ref. No.</b> 310091 BAAN167362 BAAN304881
<b>description</b> pilot burner nozzle HONEYWELL LPG code KR14 model Q3480, Q3481, Q348, Q179, Q327			
<b>accessories for</b> 102891			
	<b>GEV No.</b>	102905	<b>Ref. No.</b> —
locking screw thread M11x1 ø 6mm			

##### for series Q349

	<b>GEV No.</b>	102889	<b>Ref. No.</b> 310150 BAAN169433 BAAN304905
<b>description</b> pilot burner nozzle HONEYWELL LPG bore ø 0.25mm model Q349			

	<b>GEV No.</b>	106938	<b>Ref. No.</b> 310152 BAAN169434 BAAN304906
<b>description</b> pilot burner nozzle HONEYWELL natural gas code 0.51 model Q349			

### pilot burner nozzles SIT

#### 100 series

	<b>GEV No.</b>	102973	<b>Ref. No.</b> 7433158
<b>description</b> pilot burner nozzle natural gas bore ø 0.45mm Qty 1 pcs			





160 series

			
1			
<b>GEV No.</b>	102686	<b>Ref. No.</b>	311172 BAAN305063 BAAN825617 BAAN831373
<b>description</b>	pilot burner nozzle natural gas code 45 Qty 1 pcs nozzle ø 8.6mm		

			
1			
<b>GEV No.</b>	107649	<b>Ref. No.</b>	311170 BAAN71621E BAAN825618 BAAN860092
<b>description</b>	pilot burner nozzle SIT LPG code 20 Qty 1 pcs		

			
1			
<b>GEV No.</b>	107172	<b>Ref. No.</b>	310274 BAAN834138 BAAN838035
<b>description</b>	pilot burner nozzle SIT LPG code 25 Qty 1 pcs		

			
1			
<b>GEV No.</b>	107650	<b>Ref. No.</b>	311171
<b>description</b>	pilot burner nozzle SIT LPG code 30 Qty 1 pcs		

			
1			
<b>GEV No.</b>	107174	<b>Ref. No.</b>	310273 BAAN829765 BAAN838038
<b>description</b>	pilot burner nozzle SIT natural gas code 41 Qty 1 pcs		

bypass nozzles

bypass nozzles PEL20/21

			
1			
<b>GEV No.</b>	100551	<b>Ref. No.</b>	310173
<b>description</b>	bypass nozzle type PEL20/21 bore ø 0.6mm thread M5x0.5		

bypass nozzles PEL22

			
1			
<b>GEV No.</b>	100428	<b>Ref. No.</b>	310165
<b>description</b>	bypass nozzle type PEL22 bore ø 0.65mm thread M6x0.5		

			
1			
<b>GEV No.</b>	100407	<b>Ref. No.</b>	310166
<b>description</b>	bypass nozzle type PEL22 bore ø 1mm thread M6x0.5		

auxiliary gas parts

screw connections

olives

			
1			
<b>GEV No.</b>	101857	<b>Ref. No.</b>	310275
<b>description</b>	olive for pipe ø 6mm Qty 1 pcs suitable for 160 series for pilot burner		

union screws

			
1			
<b>GEV No.</b>	100906	<b>Ref. No.</b>	317980 BAAN829766 BAAN838033
<b>description</b>	screw connection thread M10x1 for ignition electrode brass Qty 1 pcs WS 10		

			
1			
<b>GEV No.</b>	100907	<b>Ref. No.</b>	317979 BAAN829767 BAAN838027
<b>description</b>	screw connection thread M10x1 Qty 1 pcs type SEF 1 ømm for thermocouple		

## equipment-specific units

## for ice-cube maker

## hoses

## formed hoses

## straight

## silicone hoses



<b>GEV No.</b>	530063	<b>Ref. No.</b>	71289E
<b>description</b>	silicone hose ID ø 18mm ED ø 25mm L 1m t.max. 200°C transparent		

## for espresso machines

## brewing units

## filter holder gaskets

## O-rings





<b>GEV No.</b>	510409	<b>Ref. No.</b>	318044 905588 966001 BAAN1323306 BAAN311999
<b>description</b>	O-ring EPDM thickness 5.34mm ID ø 56.52mm Qty 1 pcs		





## for dishwashers

## containers

## salt tanks



<b>GEV No.</b>	510929	<b>Ref. No.</b>	315728 915405
<b>description</b>	salt tank ø 120mm H 117mm hose ø 10mm mounting ø 70mm overall height 157mm		
<b>spare parts for</b>	510929		
	<b>GEV No.</b>	506015	<b>Ref. No.</b> —
	O-ring EPDM thickness 3.53mm ID ø 39.69mm Qty 1 pcs		
	<b>GEV No.</b>	510018	<b>Ref. No.</b> —
	nut ø 92mm H 10.5mm for salt tank ID ø 64mm		

<b>spare parts for</b>	510929		
	<b>GEV No.</b>	524177	<b>Ref. No.</b> —
	lid ø 69mm H 20mm for salt tank ID ø 50mm		
<b>accessories for</b>	510929		
	<b>GEV No.</b>	510071	<b>Ref. No.</b> —
	flat gasket rubber ED ø 81mm ID ø 68mm thickness 3mm for salt tank Qty 1 pcs		
	<b>GEV No.</b>	510654	<b>Ref. No.</b> —
	gasket H 6mm D1 ø 82mm D2 ø 68mm		
	<b>GEV No.</b>	510883	<b>Ref. No.</b> —
	gasket rubber ED ø 86mm ID ø 66mm thickness 2mm for salt tank Qty 1 pcs		

## boilers

## boilers for dishwashers



<b>GEV No.</b>	513243	<b>Ref. No.</b>	2001602H
<b>description</b>	boiler		





<b>GEV No.</b>	518235	<b>Ref. No.</b>	2002149H
<b>description</b>	boiler ø 145mm L 405mm flange 3 hole flange		





## air traps





## air traps



<b>GEV No.</b>	519499	<b>Ref. No.</b>	2001106H
<b>description</b>	air trap L 46mm W 35mm H 72mm thread 3/4" hose ø 5.5mm plastic		
<b>accessories for</b>	519499		
	<b>GEV No.</b>	516261	<b>Ref. No.</b> 2001359H
	flat gasket rubber ED ø 33mm ID ø 25mm thickness 2.5mm for air trap Qty 1 pcs		
	<b>GEV No.</b>	519498	<b>Ref. No.</b> 2001201H
	nut thread 3/4" H 10mm WS 30 plastic Qty 1 pcs		



 <p>1</p>			
<b>GEV No.</b>	510103	<b>Ref. No.</b>	5567E BAAN1322919 BAAN307590
<b>description</b>	air trap L 85mm W 20mm H 80mm hose ø 6mm plastic		
<b>spare parts for</b>	510103		
	<b>GEV No.</b>	505045	<b>Ref. No.</b> —
	O-ring EPDM thickness 1.78mm ID ø 5.28mm Qty 1 pcs		
	<b>GEV No.</b>	505094	<b>Ref. No.</b> —
	air trap		
	<b>GEV No.</b>	510016	<b>Ref. No.</b> —
	eye bolt for rinse aid container connection		
	<b>GEV No.</b>	510105	<b>Ref. No.</b> —
	hose connector for air trap		

 <p>1</p>			
<b>GEV No.</b>	518200	<b>Ref. No.</b>	2001861H 5848E BAAN1321491 BAAN307871
<b>description</b>	air trap ø 34mm H 78mm hose ø 6mm plastic		
<b>spare parts for</b>	518200		
	<b>GEV No.</b>	504618	<b>Ref. No.</b> —
	O-ring EPDM thickness 2.62mm ID ø 15.54mm Qty 1 pcs		
	<b>GEV No.</b>	510075	<b>Ref. No.</b> —
	flat gasket rubber ED ø 22mm ID ø 13mm thickness 1.5mm Qty 1 pcs		
	<b>GEV No.</b>	510106	<b>Ref. No.</b> —
	hose connector for air trap		

<b>backflow preventers</b>			
<b>backflow preventers</b>			
 <p>1</p>			
<b>GEV No.</b>	514502	<b>Ref. No.</b>	2002476H
<b>description</b>	backflow preventer plastic hose ø 11mm		

<b>door mechanics</b>			
<b>hinges</b>			
 <p>1</p>			
<b>GEV No.</b>	518547	<b>Ref. No.</b>	5565E
<b>description</b>	door hinge hinge mounting pos. left		

<b>hinge camps</b>			
 <p>1</p>			
<b>GEV No.</b>	518257	<b>Ref. No.</b>	5566E
<b>description</b>	hinge camp mounting pos. left		

<b>screw connections</b>			
 <p>1</p>			
<b>GEV No.</b>	519498	<b>Ref. No.</b>	2001201H
<b>description</b>	nut thread 3/4" H 10mm WS 30 plastic Qty 1 pcs		

<b>washing and rinsing systems</b>			
 <p>1</p>			
<b>GEV No.</b>	504550	<b>Ref. No.</b>	5042E
<b>description</b>	bush		







 <p>1</p>			
<b>GEV No.</b>	517568	<b>Ref. No.</b>	2001143H BAAN1121321 BAAN1320857
<b>description</b>	counterflange for wash arm support ø 69mm ID ø 63mm H 35mm mounting distance 64mm hole ø 7mm		
<b>accessories for</b>	517568		
	<b>GEV No.</b>	531605	<b>Ref. No.</b>
	2001907H BAAN1321530 BAAN924677		
	extension for rinsing shaft ø 16mm H 122mm thread L 12mm WS 19		

Table continues overleaf

<b>accessories for</b>	517568		
	<b>GEV No.</b>	532603	<b>Ref. No.</b> —
	O-ring EPDM thickness 3.53mm ID ø 69.85mm Qty 1 pcs		
	<b>GEV No.</b>	698750	<b>Ref. No.</b> —
	throttle disc ø 71.5mm hole ø 17/22mm		

	<b>GEV No.</b>	507541	<b>Ref. No.</b>	2002510H
<b>description</b>	flat gasket rubber ED ø 74mm ID ø 57mm thickness 2mm Qty 1 pcs			

	<b>GEV No.</b>	518071	<b>Ref. No.</b>	2001332H BAAN1121689 BAAN1321032
<b>description</b>	gasket for wash arm support L 109mm W 68mm			

	<b>GEV No.</b>	504516	<b>Ref. No.</b>	5109E
<b>description</b>	knurled nut thread M8x1 ø 25mm H 6mm SS			

	<b>GEV No.</b>	504547	<b>Ref. No.</b>	5013E
<b>description</b>	knurled nut thread M8x1 ø 25mm H 6mm SS			

	<b>GEV No.</b>	518637	<b>Ref. No.</b>	2002506H
<b>description</b>	nut for wash arm support thread M56x2			

	<b>GEV No.</b>	518086	<b>Ref. No.</b>	2001580H
<b>description</b>	opposite support			

	<b>GEV No.</b>	518471	<b>Ref. No.</b>	5820E BAAN1322963 BAAN307842
<b>description</b>	rinse pipe			

	<b>GEV No.</b>	518003	<b>Ref. No.</b>	5523E
<b>description</b>	screw cap			

	<b>GEV No.</b>	513286	<b>Ref. No.</b>	2001024H
<b>description</b>	screw connection			

	<b>GEV No.</b>	510058	<b>Ref. No.</b>	199018
<b>description</b>	throttle disc			

	<b>GEV No.</b>	513270	<b>Ref. No.</b>	2001604H
<b>description</b>	throttle disc			

	<b>GEV No.</b>	510112	<b>Ref. No.</b>	5517E
<b>description</b>	Thumb screw thread M10 thread L 10mm ø 22mm H 4.5mm SS			

	<b>GEV No.</b>	504560	<b>Ref. No.</b>	5062E
<b>description</b>	wash pipe			



			
1			
<b>GEV No.</b>	518633	<b>Ref. No.</b>	2001127H
<b>description</b>	wash pipe		

washing and rinsing systems (sorted by producer)

BONNET

rinse arms

rotary

complete

				
1				
<b>GEV No.</b>	510118	<b>Ref. No.</b>	5556E	
<b>description</b>	wash arm L 245mm nozzles 4 mounting ø 12mm mounting pos. upper			
<b>spare parts for</b>	510118			
	<b>GEV No.</b>	510011	<b>Ref. No.</b>	—
	screw connection plastic			
	<b>GEV No.</b>	510012	<b>Ref. No.</b>	—
	flat gasket PTFE ED ø 16.5mm ID ø 12.5mm thickness 1.5mm Qty 1 pcs equiv. no. 437008			
	<b>GEV No.</b>	510013	<b>Ref. No.</b>	—
	rinse arm shaft			
	<b>GEV No.</b>	510130	<b>Ref. No.</b>	5531K
	union nut for rinse jet			
	<b>GEV No.</b>	510139	<b>Ref. No.</b>	5532K
	rinse jet			
	<b>GEV No.</b>	518326	<b>Ref. No.</b>	—
	rinse arm boss			
	<b>GEV No.</b>	518328	<b>Ref. No.</b>	5559K
	rinse arm mounting pos. right L 110mm mounting ø 13mm nozzles 2			
	<b>GEV No.</b>	518329	<b>Ref. No.</b>	5559K
	rinse arm mounting pos. left L 110mm mounting ø 13mm nozzles 2			

knobs

producer-specific knobs

BONNET

			
1			
<b>GEV No.</b>	112123	<b>Ref. No.</b>	138341 BAAN1207825
<b>description</b>	knob ø 50mm shaft ø 8x6.5mm shaft flat upper special		
			
1			
<b>GEV No.</b>	110197	<b>Ref. No.</b>	908117 BAAN1323372 BAAN313287
<b>description</b>	knob switch zero mark ø 42mm shaft ø 6x4.6mm shaft flat adjustable black		
			
1			
<b>GEV No.</b>	112168	<b>Ref. No.</b>	310997 BAAN1210197 BAAN304989
<b>description</b>	knob switch zero mark ø 50mm shaft ø 10x8mm shaft flat upper black		
			
1			
<b>GEV No.</b>	112122	<b>Ref. No.</b>	138340 BAAN1207824 BAAN835242
<b>description</b>	knob t.max.°C ø 50mm shaft ø 6x4.6mm shaft flat upper special		
			
1			
<b>GEV No.</b>	112125	<b>Ref. No.</b>	381286 BAAN856673 BAAN890769
<b>description</b>	knob adapter shaft ø 8x6.5mm shaft flat universal		

			
1			
<b>GEV No.</b>	112124	<b>Ref. No.</b>	381285 BAAN856672 BAAN870196
<b>description</b>	knob adapter t.max.°C shaft ø 6x4.6mm shaft flat universal		

accessories

gaskets

			
1			
<b>GEV No.</b>	112128	<b>Ref. No.</b>	366369 BAAN169545 BAAN305593
<b>description</b>	gasket knob D1 ø 40mm D2 ø 13.5mm		

			
1			
<b>GEV No.</b>	112126	<b>Ref. No.</b>	366370 BAAN169546 BAAN305594
<b>description</b>	gasket knob D1 ø 42mm D2 ø 23.5mm equiv. no. 56500 suitable for ZANUSSI		

knob adaptors

			
1			
<b>GEV No.</b>	112125	<b>Ref. No.</b>	381286 BAAN856673 BAAN890769
<b>description</b>	knob adaptor shaft ø 8x6.5mm shaft flat universal		

			
1			
<b>GEV No.</b>	112124	<b>Ref. No.</b>	381285 BAAN856672 BAAN870196
<b>description</b>	knob adapter t.max.°C shaft ø 6x4.6mm shaft flat universal		

locks

edgmount latches

handle latches

CAFF/FERMOD

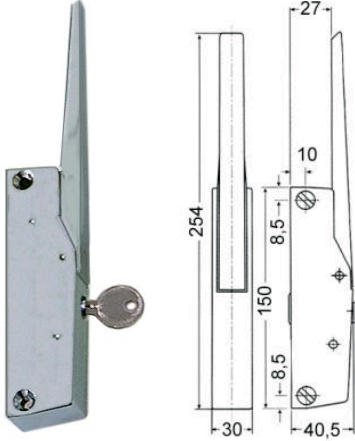
			
1			
<b>GEV No.</b>	690413	<b>Ref. No.</b>	74441 BAAN1323109 BAAN310371
<b>description</b>	handle latch L 150mm mounting distance 133mm lockable refrigeration units G 795		
<b>accessories for</b>	690413		

<b>GEV No.</b>	690418	<b>Ref. No.</b>	—
<b>description</b>	door catch L 36mm W 19mm H 29mm mounting distance 12mm zinc-coated steel for refrigeration units		

<b>GEV No.</b>	690419	<b>Ref. No.</b>	—
<b>description</b>	door catch L 52mm W 20mm H 30mm mounting distance 26-37mm zamak for refrigeration units		

<b>GEV No.</b>	700435	<b>Ref. No.</b>	—
<b>description</b>	door catch L 58mm W 20mm H 35mm mounting distance 42mm zamak for refrigeration units		

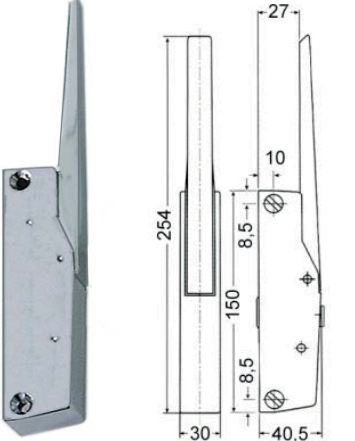

			
1			
<b>GEV No.</b>	690412	<b>Ref. No.</b>	21433E 384634 BAAN1322230 BAAN303576
<b>description</b>	handle latch L 150mm mounting distance 133mm non lockable G 790 total length 254mm handle length 105mm		
<b>accessories for</b>	690412		

<b>GEV No.</b>	690418	<b>Ref. No.</b>	—
<b>description</b>	door catch L 36mm W 19mm H 29mm mounting distance 12mm zinc-coated steel for refrigeration units		



Table continues overleaf



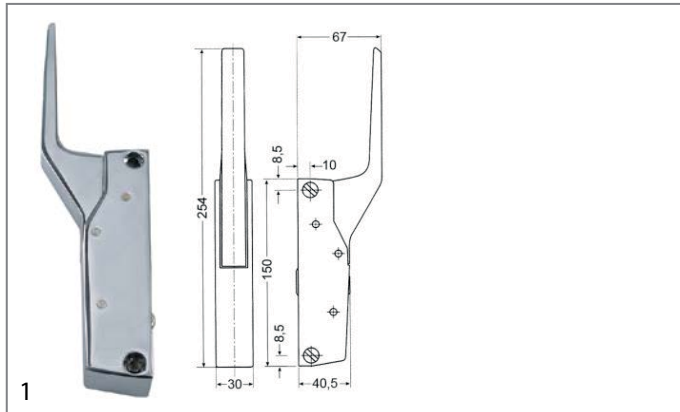

<b>accessories for</b> 690412	
	GEV No. 690419 Ref. No. — door catch L 52mm W 20mm H 30mm mounting distance 26-37mm zamak for refrigeration units
	GEV No. 700061 Ref. No. — door catch L 58mm W 20mm H 35mm mounting distance 42mm chrome-plated brass for headed units
	GEV No. 700435 Ref. No. — door catch L 58mm W 20mm H 35mm mounting distance 42mm zamak for refrigeration units



<b>GEV No.</b> 700060	<b>Ref. No.</b> 384634 71261E BAAN309273 BAAN953821 BAAN974840
<b>description</b>	handle latch L 150mm mounting distance 133mm non lockable heated units G 791
<b>accessories for</b> 700060	
	GEV No. 700061 Ref. No. — door catch L 58mm W 20mm H 35mm mounting distance 42mm chrome-plated brass for headed units
	GEV No. 700062 Ref. No. — handle protection heated units

## door catches

	<b>GEV No.</b> 700082	<b>Ref. No.</b> 679486 S486P51
<b>description</b>	door catch L 38mm W 18mm mounting distance 26mm	

## walk-in fridge catches

### CAFF/FERMOD

### 620/621 series



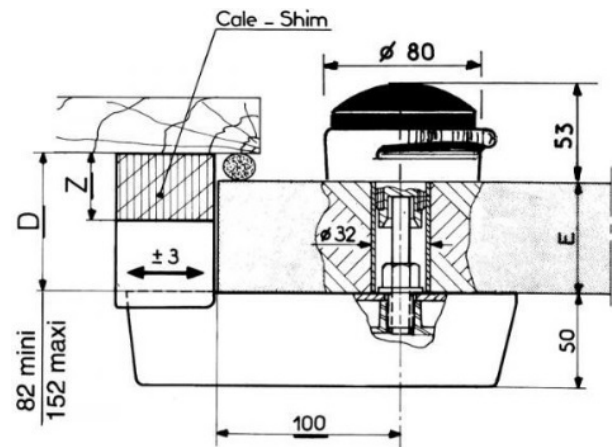

1



<b>GEV No.</b> 700575	<b>Ref. No.</b> 21273E
<b>description</b>	walk-in fridge catch door thickness 30-120mm lockable type 621 L 213mm W 104mm H 50mm
<b>spare parts for</b> 700575	
	GEV No. 692532 Ref. No. — key cylinder rotation 90°
	GEV No. 700618 Ref. No. — door opener type 520/521/620/621/920/921 for door thickness 30-120mm
	GEV No. 700619 Ref. No. — door catch for off-set 27-42mm W 54mm L 117mm H 47mm type 620/621
<b>accessories for</b> 700575	
	GEV No. 700795 Ref. No. — base plate door thickness 42-57mm H 15mm type 620/621
	GEV No. 700796 Ref. No. — base plate H 30mm type 620/621 for door thickness 57/72mm
	GEV No. 700797 Ref. No. — base plate H 50mm type 620/621





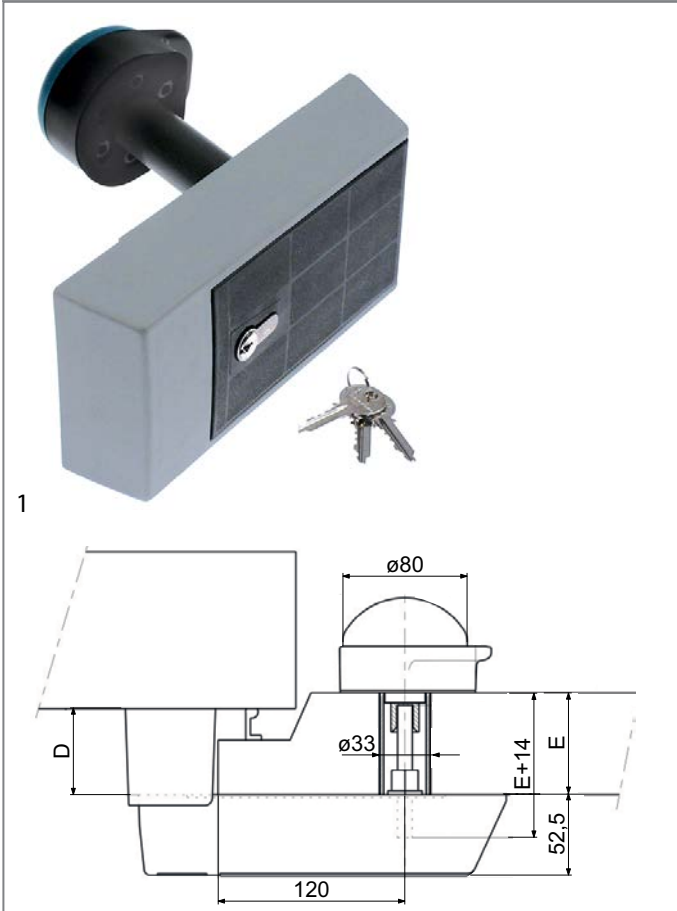

Table continues overleaf

<b>accessories for</b> 700575			
	<b>GEV No.</b>	700798	<b>Ref. No.</b> —
base plate H 80mm type 620/621			



<b>accessories for</b> 700574			
	<b>GEV No.</b>	700794	<b>Ref. No.</b> —
door catch for off-set 137-157mm W 54mm H 167mm L 135mm type 920/921/920HP/921HP			

920/921 series



<b>GEV No.</b>	700574	<b>Ref. No.</b>	621092
<b>description</b>	walk-in fridge catch door thickness 100mm type 921HP L 245mm W 108mm H 52.5mm lockable H1 220mm		
<b>accessories for</b> 700574			
	<b>GEV No.</b>	700577	<b>Ref. No.</b> —
door catch for off-set 27-42mm W 54mm H 47mm L 135mm type 920/921/920HP/921HP			
	<b>GEV No.</b>	700578	<b>Ref. No.</b> —
door catch for off-set 42-57mm W 54mm H 62mm L 135mm type 920/921/920HP/921HP			
	<b>GEV No.</b>	700579	<b>Ref. No.</b> —
door catch for off-set 52-72mm W 54mm H 82mm L 135mm type 920/921/920HP/921HP			
	<b>GEV No.</b>	700580	<b>Ref. No.</b> —
door catch for off-set 65-85mm W 54mm H 99mm L 135mm type 920/921/920HP/921HP			
	<b>GEV No.</b>	700791	<b>Ref. No.</b> —
door catch for off-set 86-106mm W 54mm H 82mm L 135mm type 920/921/920HP/921HP			
	<b>GEV No.</b>	700792	<b>Ref. No.</b> —
door catch for off-set 103-123mm W 54mm H 133mm L 135mm type 920/921/920HP/921HP			
	<b>GEV No.</b>	700793	<b>Ref. No.</b> —
door catch for off-set 120-140mm W 54mm H 82mm L 135mm type 920/921/920HP/921HP			

miscellaneous

	1		
<b>GEV No.</b>	696420	<b>Ref. No.</b>	72308E
<b>description</b>	door catch with microswitch L 80mm W 46mm mounting distance 60mm		
<b>spare parts for</b> 696420			
	<b>GEV No.</b>	347567	<b>Ref. No.</b> —
momentary push switch mounting $\varnothing$ 12mm white 1NO 250V 4A connection male faston 6.3mm ambient temperature max. 85°C protection IP40			

hinges edgmount hinges

CAFF/FERMOD

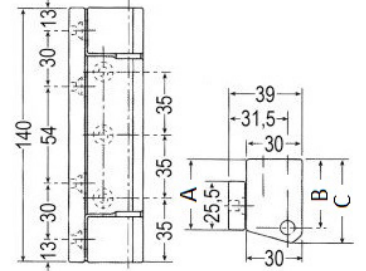
	1		
			
<b>GEV No.</b>	700562	<b>Ref. No.</b>	71258E BAAN309271
<b>description</b>	edgmount hinge L 140mm W 31/24mm mounting distance 30/35mm hinging left/right without lift L1 37mm L2 36mm L3 45.5mm series G 361		

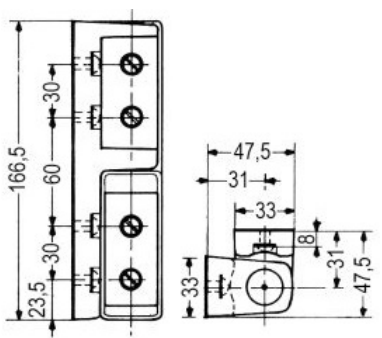
	1		
			
<b>GEV No.</b>	700566	<b>Ref. No.</b>	621090 BAAN159291 BAAN300702 S090P01
<b>description</b>	edgmount hinge L 166.5mm W 33mm mounting distance 30/60mm hinging left/right with gradient series G 481		



**CHG**

<b>GEV No.</b>	690298	<b>Ref. No.</b>	621096 BAAN172066 S096P01	
<b>description</b>	edgmount hinge L 146mm W 31mm mounting distance 27/27mm hinging left/right with gradient L1 38mm series R50			
<b>accessories for</b>	690298			
	<b>GEV No.</b>	345323	<b>Ref. No.</b>	—
	microswitch with lever 250V 10A 1CO connection male faston ambient temperature max. 105°C			

<b>GEV No.</b>	690574	<b>Ref. No.</b>	621083 85873 BAAN311508 S083P01
<b>description</b>	spring assisted hinge series 176 mounting pos. left/right L 75mm W 25.6mm A 11mm B 15mm mounting measurements 22x22mm intake 7.5x7.5		

spring assisted hinges

universal

CAFF/FERMOD

group 2

<b>GEV No.</b>	690494	<b>Ref. No.</b>	621083
<b>description</b>	spring assisted hinge series 175 mounting pos. left/right torx L 75mm W 25.6mm H 100mm A 4mm B 11mm mounting measurements 22x22mm intake torx refrigeration units mounting distance 25mm		

fittings for catering equipment

drain taps

brass

drain taps

<b>GEV No.</b>	541941	<b>Ref. No.</b>	313048 BAAN169473 BAAN305156	
<b>description</b>	drain tap 1 1/2" IT L 124mm conical seal thread 1 1/2"			
<b>accessories for</b>	541941			
	<b>GEV No.</b>	510404	<b>Ref. No.</b>	—
	flat gasket fibre ED ø 44mm ID ø 34mm thickness 2mm Qty 1 pcs			

equipment feet and end caps

equipment feet

with screw mounting

<b>GEV No.</b>	513287	<b>Ref. No.</b>	2001489H
<b>description</b>	equipment foot tube ø 60mm thread M12 thread L 33mm H 155-235mm SS size 2" Qty 1 pcs		







## shelves and shelf rails

### grates

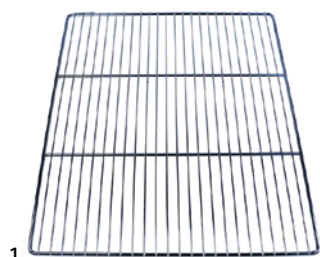
#### universal

#### without upstand



<b>GEV No.</b>	970123	<b>Ref. No.</b>	635022
<b>description</b>	grate W 650mm D 530mm GN 2/1 stainless steel wire gauge frame 7.8mm lengthwise wires gauge 3.8mm crossing wires 2 suitable for refrigerator		
<b>accessories for</b>	970123		
	<b>GEV No.</b>	<b>Ref. No.</b>	—
	690330		
	rack L 1000mm W 22mm H 4mm aperture 3x8mm hole distance 12.5mm stainless steel		
	<b>GEV No.</b>	<b>Ref. No.</b>	—
	694700		
	shelf support L 31/28mm W 22mm H 18mm SS Qty 12 pcs		
	<b>GEV No.</b>	<b>Ref. No.</b>	—
	694701		
	shelf support L 31/28mm W 22mm H 17mm SS with hook Qty 12 pcs		

## gaskets

### refrigeration gaskets

#### plug-in gaskets

#### profile 9153

We offer custom-made gaskets for this profile

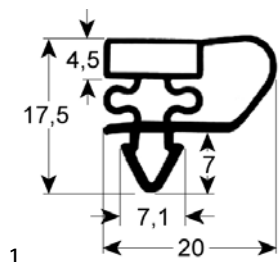

<b>GEV No.</b>	900723	<b>Ref. No.</b>	922155 BAANS359P11
<b>description</b>	refrigeration gasket profile 9153 W 670mm L 1280mm plug size		

#### profile 9794

We offer custom-made gaskets for this profile

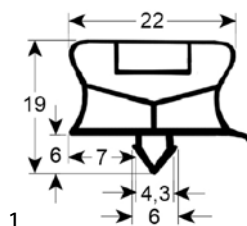

<b>GEV No.</b>	901941	<b>Ref. No.</b>	638268 S268P11
<b>description</b>	refrigeration gasket profile 9794 W 371mm L 592mm plug size		

#### profile 9195

We offer custom-made gaskets for this profile

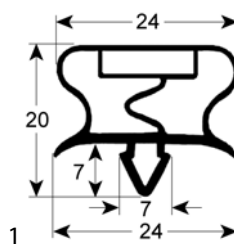

<b>GEV No.</b>	901916	<b>Ref. No.</b>	638256 S256P11
<b>description</b>	refrigeration gasket profile 9195 W 158mm L 387mm plug size		

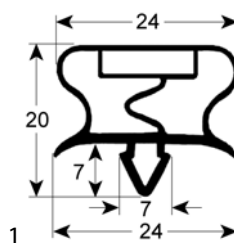

<b>GEV No.</b>	901913	<b>Ref. No.</b>	638247 S247P11
<b>description</b>	refrigeration gasket profile 9195 W 174mm L 387mm plug size		

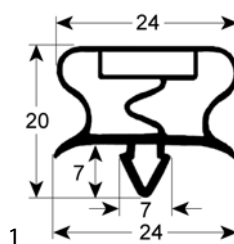

<b>GEV No.</b>	901921	<b>Ref. No.</b>	638217 BAAN849162 S217P11
<b>description</b>	refrigeration gasket profile 9195 W 364mm L 689mm plug size		



<b>GEV No.</b>	901914	<b>Ref. No.</b>	638249 S249P11
<b>description</b>	refrigeration gasket profile 9195 W 373mm L 387mm plug size		

<b>GEV No.</b>	901911	<b>Ref. No.</b>	638209 S209P11 S210P11
<b>description</b>	refrigeration gasket profile 9195 W 624mm L 1842mm plug size		

<b>GEV No.</b>	901906	<b>Ref. No.</b>	638201 S201P11
<b>description</b>	refrigeration gasket profile 9195 W 374mm L 689mm plug size		

<b>GEV No.</b>	901905	<b>Ref. No.</b>	15398881 638138 906002019 BAAN159207 S138P11
<b>description</b>	refrigeration gasket profile 9195 W 627mm L 1500mm plug size		

<b>GEV No.</b>	901915	<b>Ref. No.</b>	638255
<b>description</b>	refrigeration gasket profile 9195 W 387mm L 572mm plug size		

<b>GEV No.</b>	901945	<b>Ref. No.</b>	S443P11
<b>description</b>	refrigeration gasket profile 9195 W 654mm L 1524mm plug size		

<b>GEV No.</b>	901942	<b>Ref. No.</b>	638396 BAAN987475 S396P11
<b>description</b>	refrigeration gasket profile 9195 W 420mm L 585mm plug size		

<b>GEV No.</b>	901943	<b>Ref. No.</b>	1325364 638400
<b>description</b>	refrigeration gasket profile 9195 W 667mm L 1545mm plug size		

<b>GEV No.</b>	901920	<b>Ref. No.</b>	S259P11
<b>description</b>	refrigeration gasket profile 9195 W 462mm L 572mm plug size		

<b>GEV No.</b>	901904	<b>Ref. No.</b>	638136 BAAN168741 S136P11
<b>description</b>	refrigeration gasket profile 9195 W 668mm L 1523mm plug size		

<b>GEV No.</b>	901907	<b>Ref. No.</b>	300799 BAAN300799 BAANS202P11
<b>description</b>	refrigeration gasket profile 9195 W 689mm L 774mm plug size		

<b>GEV No.</b>	901944	<b>Ref. No.</b>	S402P11
<b>description</b>	refrigeration gasket profile 9195 W 675mm L 760mm plug size		

<b>GEV No.</b>	901910	<b>Ref. No.</b>	300802 638208 824542 BAAN300802 BAANS208P11
<b>description</b>	refrigeration gasket profile 9195 W 702mm L 1843mm plug size		

<b>GEV No.</b>	901939	<b>Ref. No.</b>	638219 BAAN849165 S219P11
<b>description</b>	refrigeration gasket profile 9195 W 689mm L 1109mm plug size		

<b>GEV No.</b>	901912	<b>Ref. No.</b>	638211 S211P11
<b>description</b>	refrigeration gasket profile 9195 W 702mm L 1863mm plug size		

<b>GEV No.</b>	901908	<b>Ref. No.</b>	S203P11
<b>description</b>	refrigeration gasket profile 9195 W 689mm L 1119mm plug size		

<b>GEV No.</b>	901940	<b>Ref. No.</b>	S220P11
<b>description</b>	refrigeration gasket profile 9195 W 820mm L 1860mm plug size		

<b>GEV No.</b>	901938	<b>Ref. No.</b>	638218 888695 BAAN888695 BAANS218P11
<b>description</b>	refrigeration gasket profile 9195 W 689mm L 764mm plug size		



profile 9793

We offer custom-made gaskets for this profile

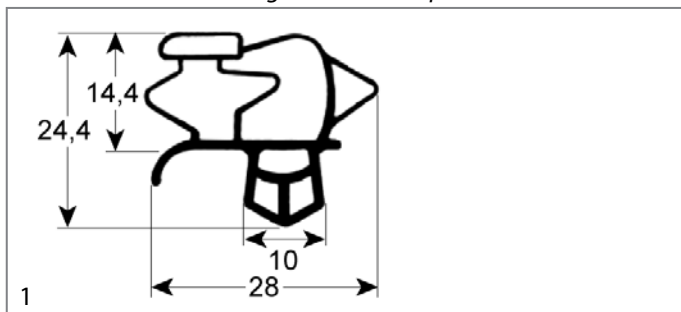

<b>GEV No.</b>	900936	<b>Ref. No.</b>	74306 BAAN1323106 BAAN310202
<b>description</b>	refrigeration gasket profile 9793 W 637mm L 1512mm plug size		

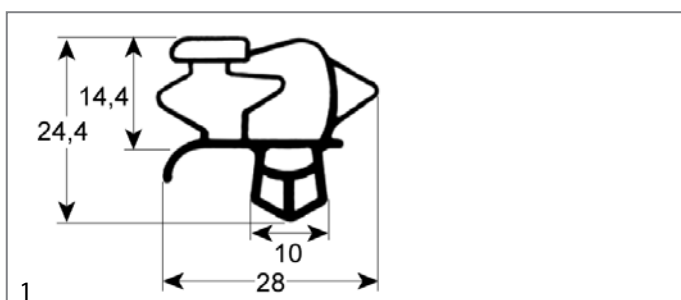

<b>GEV No.</b>	902307	<b>Ref. No.</b>	N/A
<b>description</b>	refrigeration gasket profile 9793 Wmm L 2500mm		

gaskets for heated units

window seals

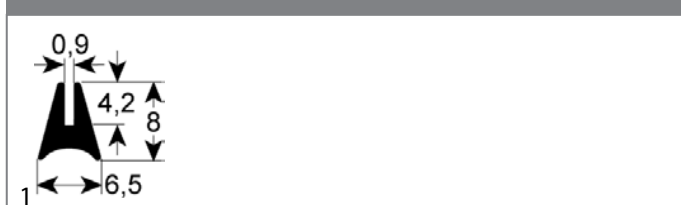

<b>GEV No.</b>	901306	<b>Ref. No.</b>	366122
<b>description</b>	window gasket profile 1515 Qty supplied by meter		

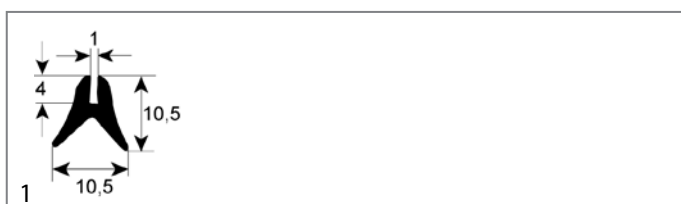

<b>GEV No.</b>	901513	<b>Ref. No.</b>	71209E
<b>description</b>	window gasket profile 1615 suitable for BOURGEOIS Qty supplied by meter		

door seals

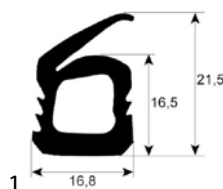

<b>GEV No.</b>	900610	<b>Ref. No.</b>	366371 BAAN169547 BAAN305595
<b>description</b>	door seal profile 2275 W 290mm L 690mm external size Qty 1 3-sided		

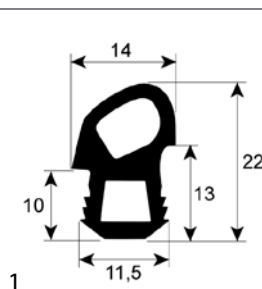

<b>GEV No.</b>	901362	<b>Ref. No.</b>	366386 BAAN171176 BAAN305603
<b>description</b>	door seal profile 2707 Qty supplied by meter		

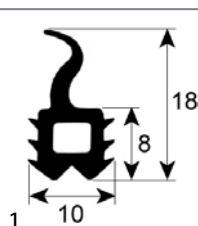

<b>GEV No.</b>	901424	<b>Ref. No.</b>	71204E 71206E BAAN309220 BAAN309222
<b>description</b>	door seal profile 2711 L 2600mm Qty 1		

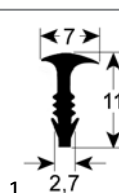

<b>GEV No.</b>	518126	<b>Ref. No.</b>	71876E
<b>description</b>	door seal profile 2980 L 2820mm		

O-rings

EPDM

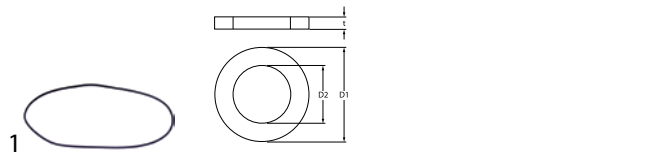

<b>GEV No.</b>	521717	<b>Ref. No.</b>	1255E 3710E 5620E BAAN301931
<b>description</b>	O-ring EPDM thickness 1.78mm ID ø 120.37mm Qty 1 pcs		

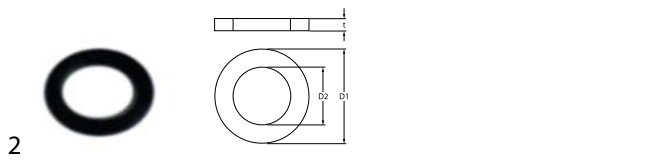

<b>GEV No.</b>	528485	<b>Ref. No.</b>	5091E
<b>description</b>	O-ring EPDM thickness 1.78mm ID ø 6.07mm Qty 1 pcs		

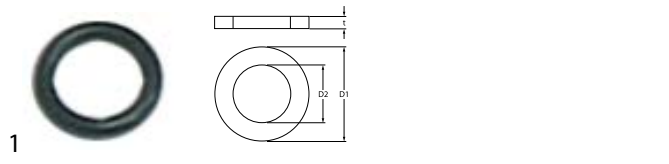

<b>GEV No.</b>	510303	<b>Ref. No.</b>	5814E
<b>description</b>	O-ring EPDM thickness 1.78mm ID ø 6.75mm Qty 1 pcs		

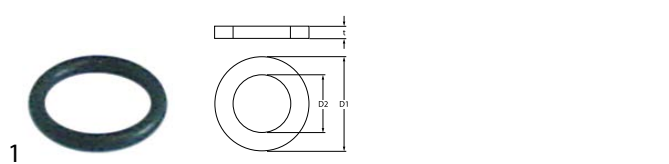

<b>GEV No.</b>	504574	<b>Ref. No.</b>	2001375H 5090E
<b>description</b>	O-ring EPDM thickness 1.78mm ID ø 9.25mm Qty 1 pcs		

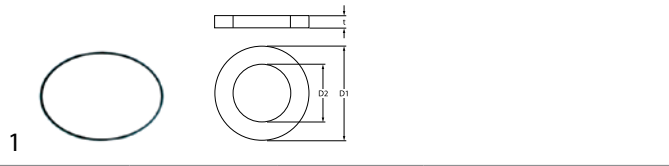

<b>GEV No.</b>	510554	<b>Ref. No.</b>	1255E 3710E 5620E BAAN301931
<b>description</b>	O-ring EPDM thickness 2mm ID ø 120mm Qty 1 pcs		

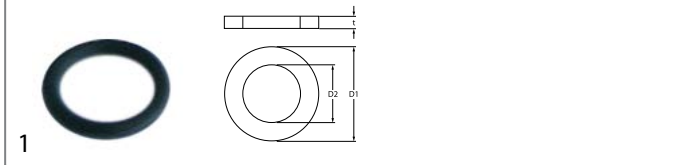

<b>GEV No.</b>	510902	<b>Ref. No.</b>	5090E BAAN307058
<b>description</b>	O-ring EPDM thickness 2mm ID ø 9.5mm Qty 1 pcs		

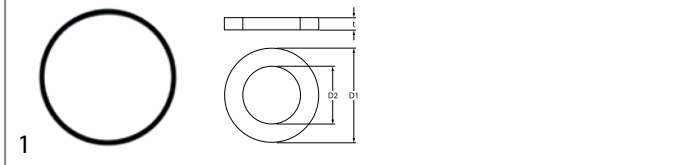

<b>GEV No.</b>	510009	<b>Ref. No.</b>	5584E BAAN1322923 BAAN307631
<b>description</b>	O-ring EPDM thickness 3.53mm ID ø 101.2mm Qty 1 pcs		

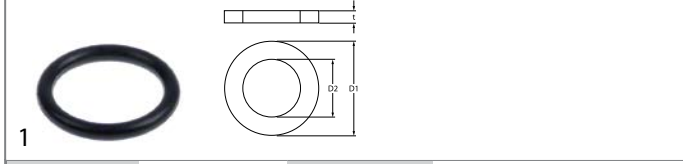

<b>GEV No.</b>	511322	<b>Ref. No.</b>	15173K 966085
<b>description</b>	O-ring EPDM thickness 3.53mm ID ø 20.22mm Qty 1 pcs		

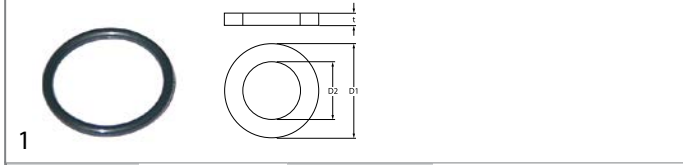

<b>GEV No.</b>	510072	<b>Ref. No.</b>	2001917H BAAN1321539 BAAN953969
<b>description</b>	O-ring EPDM thickness 3.53mm ID ø 32.93mm Qty 1 pcs		

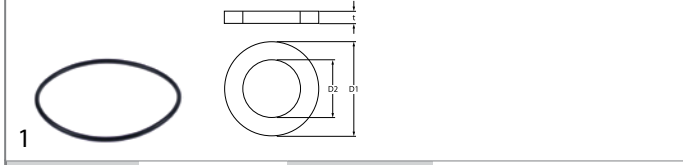

<b>GEV No.</b>	532543	<b>Ref. No.</b>	2002516H
<b>description</b>	O-ring EPDM thickness 5.34mm ID ø 136.5mm Qty 1 pcs		

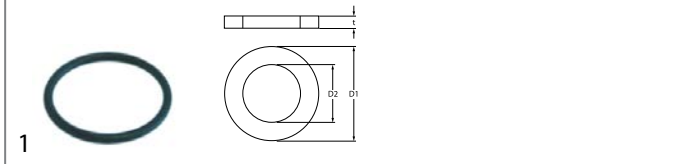



<b>GEV No.</b>	521120	<b>Ref. No.</b>	2001370H
<b>description</b>	O-ring EPDM thickness 5.34mm ID ø 37.47mm Qty 1 pcs		



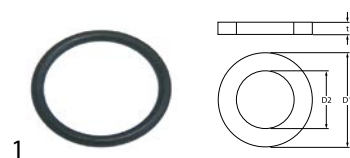

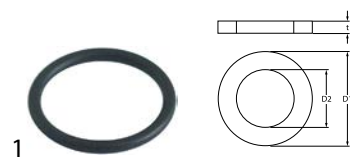
			
1			
<b>GEV No.</b>	510408	<b>Ref. No.</b>	2001827H
<b>description</b>	O-ring EPDM thickness 5.34mm ID ø 47mm Qty 1 pcs		

			
1			
<b>GEV No.</b>	505175	<b>Ref. No.</b>	966084
<b>description</b>	O-ring EPDM thickness 5.34mm ID ø 50.16mm Qty 1 pcs		

			
1			
<b>GEV No.</b>	510409	<b>Ref. No.</b>	318044 905588 966001 BAAN1323306 BAAN311999
<b>description</b>	O-ring EPDM thickness 5.34mm ID ø 56.52mm Qty 1 pcs		

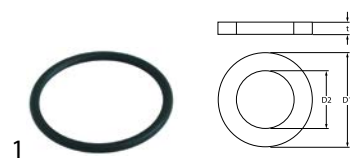
			
1			
<b>GEV No.</b>	691033	<b>Ref. No.</b>	15118K BAAN1320551 BAAN302432
<b>description</b>	O-ring EPDM thickness 5.34mm ID ø 62.87mm Qty 1 pcs		

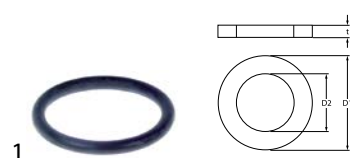
			
1			
<b>GEV No.</b>	532000	<b>Ref. No.</b>	366185
<b>description</b>	O-ring EPDM thickness 7mm ID ø 57mm Qty 1 pcs		

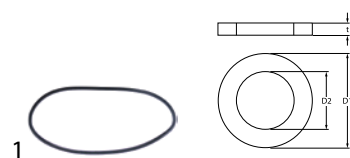
			
1			
<b>GEV No.</b>	510551	<b>Ref. No.</b>	91369308
<b>description</b>	pump cover gasket ID ø 158.3mm pump type 1214/1293/1225/2243/1226/1204/3473/1241 thickness 3.53mm EPDM Qty 1 pcs		

silicone			
			
1			
<b>GEV No.</b>	532316	<b>Ref. No.</b>	15138K BAAN302448
<b>description</b>	O-ring silicone thickness 3.53mm ID ø 32.93mm Qty 10 pcs		

Viton			
			
1			
<b>GEV No.</b>	371095	<b>Ref. No.</b>	2001374H BAAN1121434 BAAN1321069
<b>description</b>	O-ring Viton thickness 1.78mm ID ø 6.07mm Qty 1 pcs		

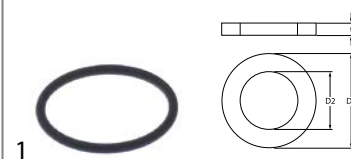
			
1			
<b>GEV No.</b>	532625	<b>Ref. No.</b>	2002519H
<b>description</b>	O-ring Viton thickness 2.62mm ID ø 28.25mm Qty 1 pcs		

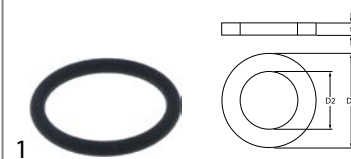
			
1			
<b>GEV No.</b>	524478	<b>Ref. No.</b>	15118K 966003 966017 BAAN1320551 BAAN302432 BAAN942897
<b>description</b>	O-ring Viton thickness 5.7mm ID ø 44.2mm Qty 1 pcs		

## sealing washers

### aluminium gaskets

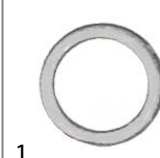
			
1			
<b>GEV No.</b>	101293	<b>Ref. No.</b>	014073M BAAN1027483 BAAN825612
<b>description</b>	flat gasket aluminium ED ø 14mm ID ø 10.3mm for pilot burner Qty 1 pcs		

## rubber gaskets



1

<b>GEV No.</b>	519547	<b>Ref. No.</b>	2001335H
<b>description</b>	flat gasket rubber ED $\phi$ 14.4mm ID $\phi$ 15.5mm thickness 2mm Qty 1 pcs size 3/4"		



1

<b>GEV No.</b>	505397	<b>Ref. No.</b>	2001340H
<b>description</b>	flat gasket rubber ED $\phi$ 32mm ID $\phi$ 19.5mm thickness 1.5mm Qty 1 pcs		



1

<b>GEV No.</b>	516261	<b>Ref. No.</b>	2001359H
<b>description</b>	flat gasket rubber ED $\phi$ 33mm ID $\phi$ 25mm thickness 2.5mm for air trap Qty 1 pcs		



1

<b>GEV No.</b>	513059	<b>Ref. No.</b>	5914E
<b>description</b>	flat gasket rubber ED $\phi$ 52mm ID $\phi$ 40mm thickness 3mm Qty 1 pcs		



1

<b>GEV No.</b>	518205	<b>Ref. No.</b>	2001343H 2001368H
<b>description</b>	flat gasket rubber ED $\phi$ 61mm ID $\phi$ 47mm thickness 2mm Qty 1 pcs		



1

<b>GEV No.</b>	507541	<b>Ref. No.</b>	2002510H
<b>description</b>	flat gasket rubber ED $\phi$ 74mm ID $\phi$ 57mm thickness 2mm Qty 1 pcs		



1

<b>GEV No.</b>	518060	<b>Ref. No.</b>	2001851H 5830E BAAN1321482 BAAN307852
<b>description</b>	gasket rubber ED $\phi$ 132mm ID $\phi$ 122mm thickness 5mm		

## special gaskets

## miscellaneous



1

<b>GEV No.</b>	511600	<b>Ref. No.</b>	71860E
<b>description</b>	gasket ED $\phi$ 80mm		

## gaskets for wash arm support



1

<b>GEV No.</b>	510054	<b>Ref. No.</b>	437046
<b>description</b>	gasket D1 $\phi$ 65mm D2 $\phi$ 35.5mm thickness 2.5mm with 5 holes wash arm support		



1

<b>GEV No.</b>	518402	<b>Ref. No.</b>	2001344H BAAN1321043
<b>description</b>	gasket with 3 screw holes wash arm support hole distance 61mm D2 $\phi$ 34mm thickness 2.5mm hole $\phi$ 34mm		

## springs

## roller springs

## roller springs



1

<b>GEV No.</b>	517450	<b>Ref. No.</b>	2001228H
<b>description</b>	roller spring W 51mm ID $\phi$ 31mm lug length 90mm		



## tension springs

			
1			
<b>GEV No.</b>	693881	<b>Ref. No.</b>	385053 BAAN169610 BAAN305842
<b>description</b>	tension spring ø 23mm total length 90mm wire gauge ø 3mm thread M8		

			
1			
<b>GEV No.</b>	513206	<b>Ref. No.</b>	2001879H
<b>description</b>	tension spring ø 29.8mm total length 513mm wire gauge ø 5.8mm		







## dosing pumps

### peristaltic dosing pumps



#### SEKO

#### built-in version

#### with frequency control

			
1			
<b>GEV No.</b>	361215	<b>Ref. No.</b>	2001180H
<b>description</b>	dosing pump SEKO frequency control 0.3-3.0l/h 230VAC detergent hose ø 4x6mm hose type K hose Santoprene suction level 1.5m type PBR protection IP55 dimensions 100x67x68mm power input 3.5W		
<b>spare parts for</b>	361215		
	<b>GEV No.</b>	361136	<b>Ref. No.</b>
			—
	roller assembly for dosing pump hole ø 4.8x4mm		
	<b>GEV No.</b>	361226	<b>Ref. No.</b>
			—
	PCB L 59mm W 26mm electronic control		
	<b>GEV No.</b>	361815	<b>Ref. No.</b>
			—
	pump hose detergent hose ø 6x10mm hose ø 4x6mm hose type K hose Santoprene type SEKO		
<b>accessories for</b>	361215		
	<b>GEV No.</b>	361142	<b>Ref. No.</b>
			—
	mounting set detergent hose type 4x6mm hose length 2m PVC 2x hose/container filter/tank intake transparent		
	<b>GEV No.</b>	520090	<b>Ref. No.</b>
			—
	PVC hose ID ø 4mm ED ø 6mm L 2m thickness 1mm t.max. 60°C transparent		
	<b>GEV No.</b>	520091	<b>Ref. No.</b>
			—
	nylon hose ID ø 4mm ED ø 6mm L 2m thickness 1mm operating p. 10bar burst p. 50bar t.max. 100°C transparent		

### without control

			
1			
<b>GEV No.</b>	361929 <sup>1</sup>	<b>Ref. No.</b>	2002480H
<b>description</b>	dosing pump SEKO without control 0.4l/h 230VAC rinse aid hose ø 4x6mm hose type E hose Sekobril suction level 1.5m type NPG 0.4 8W cable length 45mm built-in version with backflow preventer		
<b>spare parts for</b>	361929		
	<b>GEV No.</b>	361925	<b>Ref. No.</b>
			2002474H
	pump hose SEKO rinse aid hose ø 3x8mm with backflow preventer hose ø 6mm hose type E hose Sekobril		

<sup>1</sup>with accessories



### spare parts

			
1			
<b>GEV No.</b>	361925 <sup>1</sup>	<b>Ref. No.</b>	2002474H
<b>description</b>	pump hose SEKO rinse aid hose ø 3x8mm with backflow preventer hose ø 6mm hose type E hose Sekobril		

<sup>1</sup>with backflow preventer

## piston pumps

### dosing pumps

			
1			
<b>GEV No.</b>	361895	<b>Ref. No.</b>	378630
<b>description</b>	dosing pump type TTE service kit 200-240V detergent inlet 5.5mm outlet 5.5mm		
<b>spare parts for</b>	361895		
	<b>GEV No.</b>	361838	<b>Ref. No.</b>
			—
	dosing pump type TTE 200-240V detergent inlet 5.5mm outlet 5.5mm HOBART		













membrane dosing pumps

self-priming

SEKO



1

<b>GEV No.</b>	361364 <sup>1</sup>	<b>Ref. No.</b>	2001520H
<b>description</b>	dosing pump type DIB5E self-sucking rinse aid pump rate 0-5cm <sup>3</sup> per stroke pressure connection ø 4x6mm suction connection ø 4x6mm SEKO supporting pressure closed		
<b>spare parts for</b>	361364		
	<b>GEV No.</b>	361301	<b>Ref. No.</b> —
	hose connector for type DIB3E/DIB5E		
	<b>GEV No.</b>	361302	<b>Ref. No.</b> —
	valve bush for type DIB3E/DIB5E		
	<b>GEV No.</b>	361304	<b>Ref. No.</b> —
	O-ring EPDM ID ø 11.11mm thickness 1.78mm Qty 1 pcs for type DIB3E/DIB5E		
	<b>GEV No.</b>	361305	<b>Ref. No.</b> —
	valve disc for type DIB3E/DIB5E DIB3P/DIB5P		
	<b>GEV No.</b>	361306	<b>Ref. No.</b> —
	membrane for type DIB3E/DIB5E ø 49mm hole ø 5mm		
	<b>GEV No.</b>	361307	<b>Ref. No.</b> —
	membrane dosing pump ø 68mm hole ø 6mm for type DIB3P/DIB5P		
	<b>GEV No.</b>	361459	<b>Ref. No.</b> —
	hose connector ø 6mm for dosing pump		
	<b>GEV No.</b>	361481	<b>Ref. No.</b> —
	lip valve for type DIB3P/DIB5P DIB3E/DIB5E		
<b>accessories for</b>	361364		
	<b>GEV No.</b>	361240	<b>Ref. No.</b> —
	hose connector 1-way hose ø 6mm plastic connection M10x1		
	<b>GEV No.</b>	361241	<b>Ref. No.</b> —
	hose connector 1-way hose ø 9mm plastic connection M10x1		

<sup>1</sup>auxiliary pressure connection closed

various



<b>GEV No.</b>	361741	<b>Ref. No.</b>	914207 BAAN1323415 BAAN312790
<b>description</b>	dosing pump type model 2 rinse aid inlet 4x6mm outlet 4x6mm pressure connection ø 4x6mm suction connection ø 4x6mm		
<b>spare parts for</b>	361741		
	<b>GEV No.</b>	361307	<b>Ref. No.</b> —
	membrane dosing pump ø 68mm hole ø 6mm for type DIB3P/DIB5P		
	<b>GEV No.</b>	361459	<b>Ref. No.</b> —
	hose connector ø 6mm for dosing pump		
	<b>GEV No.</b>	361462	<b>Ref. No.</b> —
	container filter with weight SS hose ø 4x6mm		
	<b>GEV No.</b>	508116	<b>Ref. No.</b> —
	union nut thread M10x1 H 16mm WS 16 plastic Qty 1 pcs		
	<b>GEV No.</b>	508123	<b>Ref. No.</b> —
	T-piece 3-way hose ø 13-5-13mm plastic		
	<b>GEV No.</b>	520090	<b>Ref. No.</b> —
	PVC hose ID ø 4mm ED ø 6mm L 2m thickness 1mm t.max. 60°C transparent		

accessories

container filters with non-return valve



1

<b>GEV No.</b>	361058	<b>Ref. No.</b>	2000034
<b>description</b>	container filter with non-return valve SS hose ø 4x6mm ø 20mm L 56mm		





## hoses

### supply hoses

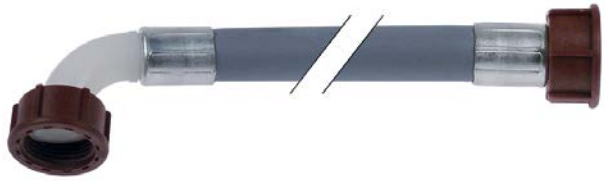
#### PVC supply hoses



1

<b>GEV No.</b>	520010	<b>Ref. No.</b>	2001753H 42551
<b>description</b>	supply hose PVC straight-curved DN13 connections 3/4" L 1500mm operating p. 10bar burst p. 32bar t.max. 90°C blue approval VDE flat seal		
<b>accessories for</b>	520010		
	<b>GEV No.</b>	520053	<b>Ref. No.</b> —
	screen connection 3/4" D1 ø 26mm D2 ø 15mm Qty 10 pcs rubber thickness 8mm		
	<b>GEV No.</b>	520054	<b>Ref. No.</b> —
	flat gasket rubber ED ø 23.5mm ID ø 14mm thickness 2.3mm Qty 10 pcs		



1

<b>GEV No.</b>	520011	<b>Ref. No.</b>	2001738H
<b>description</b>	supply hose PVC straight-curved DN13 connections 3/4" L 2000mm operating p. 10bar burst p. 32bar t.max. 90°C approval VDE flat seal		

### drain hoses



1

<b>GEV No.</b>	518068	<b>Ref. No.</b>	2001854H 5834E
<b>description</b>	drain hose DN34 L 2000mm elbow ø inside 50mm elbow ext. ø 59mm inner hose ø 35mm outer hose ø 42mm PVC		

## industrial hoses

### Niplaflex hoses



1

<b>GEV No.</b>	530561	<b>Ref. No.</b>	2001726H
<b>description</b>	pressure hose ID ø 10mm ED ø 17mm L 5m thickness 3.5mm operating p. 10bar burst p. 30bar t.max. 110°C		

### pressure control hoses



1







<b>GEV No.</b>	530560	<b>Ref. No.</b>	2001744H 2002194H
<b>description</b>	pressure control hose ID ø 5mm ED ø 9mm L 5m operating p. 30bar burst p. 90bar temp.-resist. 60°C		

## PVC hoses

### PVC hoses without fabric



1

<b>GEV No.</b>	520383	<b>Ref. No.</b>	2001722H
<b>description</b>	PVC hose ID ø 4mm ED ø 6mm L 2m thickness 1mm t.max. 60°C blue		
<b>accessories for</b>	520383		
	<b>GEV No.</b>	361058	<b>Ref. No.</b> 2000034
	container filter with non-return valve SS hose ø 4x6mm ø 20mm L 56mm		
	<b>GEV No.</b>	361066	<b>Ref. No.</b> —
	container filter straight SS hose ø 4x6mm L 37mm non return valve ball valve		
	<b>GEV No.</b>	361106	<b>Ref. No.</b> —
	container filter with weight and non-return valve SS hose ø 4x6mm ø 21mm L 51mm non return valve lip valve		
	<b>GEV No.</b>	361141	<b>Ref. No.</b> —
	container filter with weight ceramic hose ø 4mm		
	<b>GEV No.</b>	361230	<b>Ref. No.</b> —
	container filter with weight stainless steel hose ø 4x6mm		
	<b>GEV No.</b>	361462	<b>Ref. No.</b> —
	container filter with weight SS hose ø 4x6mm		
	<b>GEV No.</b>	361728	<b>Ref. No.</b> —
	container filter with 4m 4x6 hose SS hose ø 4x6mm hose length 4000mm		

1

<b>GEV No.</b>	520029	<b>Ref. No.</b>	2001747H
<b>description</b>	PVC hose ID ø 6mm ED ø 9mm L 10m thickness 1.5mm t.max. 60°C transparent		

extraction and pressure hoses



1

<b>GEV No.</b>	530444	<b>Ref. No.</b>	N/A
<b>description</b>	universal hose ID ø 38mm ED ø 50mm L 1m operating p. 10bar burst p. 30bar temp.-resist. -30 up to +80°C		

silicone hoses

without fabric



1

<b>GEV No.</b>	530063	<b>Ref. No.</b>	71289E
<b>description</b>	silicone hose ID ø 18mm ED ø 25mm L 1m t.max. 200°C transparent		

with fabric

with monofilament braid



1

<b>GEV No.</b>	530542	<b>Ref. No.</b>	71265E
<b>description</b>	silicone hose with monofilament braid ID ø 10mm ED ø 17mm L 5m thickness 3.5mm operating p. 4bar burst pressure at 95°C non definedbar burst pressure 130°C non definedbar t.max. 200°C Qty 5m		

formed hoses

form U



1

<b>GEV No.</b>	518517	<b>Ref. No.</b>	2001408H BAAN1121125 BAAN1321100
<b>description</b>	formed hose for drain pump D1 ø 28mm D2 ø 21mm warewashing U-shape		

miscellaneous



1

<b>GEV No.</b>	513306	<b>Ref. No.</b>	2002452H
<b>description</b>	formed hose ext. ø 43 ID ø 34mm ED ø 23mm D1 ø 32mm L 140mm		



1

<b>GEV No.</b>	513307	<b>Ref. No.</b>	2002450H
<b>description</b>	formed hose ext. ø 47 ID ø 39mm ED ø 47mm D1 ø 39mm L 82mm		

fittings, hose and pipe connectors

hose connectors

without screw connection



1

<b>GEV No.</b>	504302	<b>Ref. No.</b>	904364 917001 BAAN1323251 BAAN311749
<b>description</b>	T-piece plastic hose ø 10-6-10mm ID ø 5/7.5mm L 62mm W 34mm		



## hose connectors

### brass



1

<b>GEV No.</b>	513253	<b>Ref. No.</b>	2001857H BAAN1321487 BAAN307867
<b>description</b>	hose connector brass angled thread 1/4" hose ø 12mm Qty 1 pcs		

## valves and tank inlets

### ball valves

#### ball valves electric



1

<b>GEV No.</b>	401190	<b>Ref. No.</b>	314359
<b>description</b>	ball valve inlet 3/4" IT outlet 3/4" IT IP42 230V L 68mm 50/60Hz closed off-current mode of operation electric connection cable 300mm 3.5W duty cycle 50%		

## water cycle components

### supply filters



1

<b>GEV No.</b>	520261	<b>Ref. No.</b>	91297387
<b>description</b>	supply filter thread 1/2" IT - 1/2" IT total length 58mm red brass mesh opening 0.4mm		

## ancillary products

### clamps

#### hose clamps

##### DIN 3017 - W2



1

<b>GEV No.</b>	520114	<b>Ref. No.</b>	917110
<b>description</b>	hose clamp ø 20-32mm width 9mm Qty 10 pcs DIN 3017		

##### DIN 3017 - W4



1

<b>GEV No.</b>	520120	<b>Ref. No.</b>	15181K 917109
<b>description</b>	hose clamp SS W4 ø 12-20mm width 9mm Qty 1 pcs DIN 3017		

## measuring equipment

### thermometers

#### built-in thermometers



1

<b>GEV No.</b>	541086	<b>Ref. No.</b>	901018 BAAN1323190 BAAN869118
<b>description</b>	thermometer mounting measurements 58x25.5mm 0 up to +120°C capillary pipe 2000mm probe ø 6mm probe L 23mm		

## fastening material

### screws

#### hexagonal screws



1

<b>GEV No.</b>	560083	<b>Ref. No.</b>	388105 BAAN1080078
<b>description</b>	hexagonal screw thread M5 thread L 10mm SS WS 8 Qty 20 pcs DIN 933 / ISO 4017		

cylinder head bolts

DIN 912/ISO 4762



1

<b>GEV No.</b>	560335	<b>Ref. No.</b>	388107 BAAN781719
<b>description</b>	cylinder head bolt thread M5 thread L 20mm WS 4 SS Qty 1 pcs DIN 912/ISO 4762		

knurled screws



1

<b>GEV No.</b>	510112	<b>Ref. No.</b>	5517E
<b>description</b>	Thumb screw thread M10 thread L 10mm ø 22mm H 4.5mm SS		

nuts

knurled nuts



1

<b>GEV No.</b>	504516	<b>Ref. No.</b>	5109E
<b>description</b>	knurled nut thread M8x1 ø 25mm H 6mm SS		



1

<b>GEV No.</b>	504547	<b>Ref. No.</b>	5013E
<b>description</b>	knurled nut thread M8x1 ø 25mm H 6mm SS		

hexagonal nuts

DIN 934 / ISO 4032/8673



1

<b>GEV No.</b>	560129	<b>Ref. No.</b>	989100
<b>description</b>	hexagonal nut thread M5 H 4mm WS 8 SS DIN/ISO DIN 934 / ISO 4032/8673 Qty 1 pcs		



1

<b>GEV No.</b>	560197	<b>Ref. No.</b>	388146
<b>description</b>	nut thread M10 H 8mm WS 17 SS DIN/ISO DIN 934 / ISO 4032/8673 Qty 1 pcs		

DIN 985



1

<b>GEV No.</b>	560141	<b>Ref. No.</b>	389540 BAAN1050326
<b>description</b>	hexagonal nut thread M5 H 5.4mm SS WS 8 Qty 20 pcs DIN/ISO DIN 985 self-locking		

fasteners

clamps

hose clamps

DIN 3017 - W2



1

<b>GEV No.</b>	520114	<b>Ref. No.</b>	917110
<b>description</b>	hose clamp ø 20-32mm width 9mm Qty 10 pcs DIN 3017		

DIN 3017 - W4



1

<b>GEV No.</b>	520120	<b>Ref. No.</b>	15181K 917109
<b>description</b>	hose clamp SS W4 ø 12-20mm width 9mm Qty 1 pcs DIN 3017		

consumables

fuses

fine fuses



1

<b>GEV No.</b>	358666	<b>Ref. No.</b>	309316
<b>description</b>	fine fuse size ø5x20mm 0.315A fast-acting rated 250V Qty 10 pcs		





1

<b>GEV No.</b>	358530	<b>Ref. No.</b>	2001921H
<b>description</b>	fine fuse size ø5x20mm 0.8A fast-acting rated 250V Qty 10 pcs		





			
1			
<b>GEV No.</b>	358677	<b>Ref. No.</b>	2001981H 2002146H
<b>description</b>	fine fuse size ø5x20mm 4A fast-acting rated 250V Qty 10 pcs		

ø6.3x32mm 500V			
			
1			
<b>GEV No.</b>	358752	<b>Ref. No.</b>	3090506
<b>description</b>	fine fuse size ø6.3x32mm 10A fast-acting rated 500V Qty 10 pcs		



<b>A</b>			
alarm devices	22		
axial fans	34		
<b>B</b>			
ball valves	87		
ball valves electric	33, 87		
bar burners	66		
bi-metal thermostats	10, 10		
booster pumps II	43		
<b>C</b>			
cables	45		
cam switches	18		
clamps	87, 88		
compressors	34		
condensators & interference suppression filters	44		
consumables	88		
contactors	23		
container filters	84		
control thermostats	10, 14		
copper wire	45		
cross flow fans	35		
cylinder head bolts	88		
<b>D</b>			
door catches	73		
door seals	79		
dosing pumps	83		
drain hoses	85		
drain pumps	43		
<b>E</b>			
edgemount hinges	74		
edgemount latches	72		
electric accessories	45		
electronic controllers	25		
energy regulators	9		
extraction and pressure hoses	86		
<b>F</b>			
fans	34		
fasteners	88		
fastening material	87		
fine fuses	88		
fluorescent lamps	21, 21		
formed hoses	86		
fuses	44, 88		
<b>G</b>			
gas burners	63		
gas control valves	55		
		gas nozzles	66
		gas taps	45
		gas thermostats	52
		gaskets for heated units	79
		gaskets for wash arm support	82
		grates	76
<b>H</b>			
		halogen lamp	21
		handle latches	72
		heating elements	3
		heating elements for bain maries	3
		heating elements for convection	7
		heating elements for fryers	3
		heating elements for frying pans	3
		heating elements for griddles	3
		heating elements for ovens	3
		heating elements for salamanders/toasters	3
		hexagonal nuts	88
		hexagonal screws	87
		hob burners	63
		hose clamps	87, 88
		hose connectors	86, 87
		hoses	85
		hot air fans	36
		hot air motors	35
		hot plates	8
<b>I</b>			
		ignition boxes	57
		ignition cables	61
		ignition units	62
		immersion heating elements	4
		indicator lights	19
		indicator lights (complete)	19
		industrial hoses	85
<b>K</b>			
		knurled nuts	88
		knurled screws	88
<b>L</b>			
		lamps	19
		LED	20
		light bulbs	21
<b>M</b>			
		magnetic switches	18
		measuring equipment	87
		mechanical timers	22
		microswitches	16
		motors	36

**N**

neon light bulbs	19, 20
nickel wire	45
Niplaflex hoses	85
nuts	88

**O**

operating capacitors	44
O-rings	80
oven lamps	21

**P**

pilot burners	58
plug-in gaskets	76
pressure control hoses	85
pressure switches	33
probes	26
programme timers	22
pumps	36
push/momentary push switches	16
PVC hoses	85
PVC supply hoses	85

**R**

radiation heaters	8
refrigeration fans	35
refrigeration gaskets	76
refrigeration motors universal	35
relays	24
ribbon cables	45
rocker/momentary rocker switches	16
rotary switches	18

**S**

safety bi-metal thermostats	10
safety thermostats	13, 15
safety valves	57
screws	87
sealing washers	81
shelves and shelf rails	76
silicone hoses	86
solenoid valves	27
spring assisted hinges	75
supply filters	87, 87
supply hoses	85
switches and momentary switches	16
system switches (ROLD)	17

**T**

temperature probes	26
terminals	45
thermocouples	62

thermostats	10
timers	22
transformers	25

**U**

universal probes	26
------------------	----

**V**

valves and tank inlets	87
------------------------	----

**W**

walk-in fridge catches	73
wash and rinse pumps	36
water cycle components	87
window seals	79