



**GAS COMPONENTS**



**ELECTRIC COMPONENTS**



**WATER TECHNOLOGY**



**MECHANICAL COMPONENTS**



**TOOLS**

Spare parts suitable for

**BARTSCHER**

Find the complete and up-to-date range of products in our GEV Webshop



# Manufacturer catalogue

The most important spare parts and accessories arranged clearly for every manufacturer

- ✓ Complete product range and all appliance data always up to date in the GEV Webshop
- ✓ Alphabetical Index at the end of the catalogue

## GEV Webshop

[www.gev-online.co.uk](http://www.gev-online.co.uk)

[www.gev-online.com](http://www.gev-online.com)



- 🔍 Add to Favourites
- 🔍 Sign In with email address and usual password
- 🔍 Easy-order – place several items in your basket at the same time
- 🔍 Quick Item search – no login needed



## induction

### induction coils



1

<b>GEV No.</b>	404000	<b>Ref. No.</b>	01058352
<b>description</b>	induction coils 3500W 230V 50Hz L 220mm W 217mm H 12mm suitable for BARTSCHER for induction device		

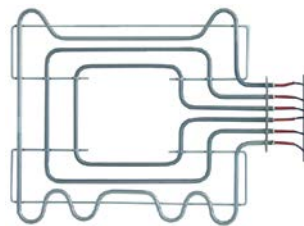

1

<b>GEV No.</b>	416785	<b>Ref. No.</b>	016727
<b>description</b>	heating element 1800W 230/400V heating circuits 3 L 515mm W 452mm L1 57mm L2 458mm W1 162mm W2 128mm flange length 160mm flange width 22mm hole distance 144mm hole ø M5mm tube ø 8.5mm rectangular flange dry heating element oven cable length 570mm		

## heating elements

### heating elements for ovens



1

<b>GEV No.</b>	418478	<b>Ref. No.</b>	065211001 065211007
<b>description</b>	heating element 1000W 230V heating circuits 1 L 420mm W 200mm connection male faston 6.3mm connection distance 194mm connection length 15mm tube ø 6.3mm dry heating element oven/bain marie H 47mm		

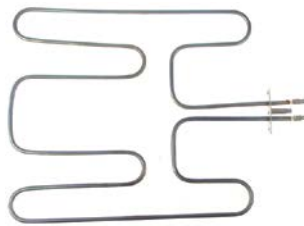

1

<b>GEV No.</b>	418546	<b>Ref. No.</b>	021061
<b>description</b>	heating element 1800W 230V heating circuits 1 L 405mm W 324mm L1 30mm L2 375mm W2 30mm flange length 72mm flange width 22mm hole distance 57mm hole ø 5mm tube ø 6.3mm connection male faston 6.3mm connection length 55mm mounting pos. lower rectangular flange dry heating element oven		

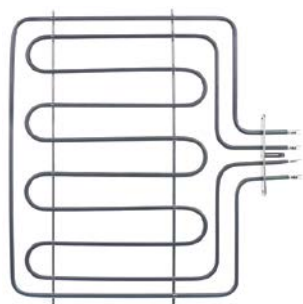

1

<b>GEV No.</b>	418961	<b>Ref. No.</b>	023319
<b>description</b>	heating element 1200/2850W 230V heating circuits 2 L 400mm W 467mm L1 40mm L2 360mm W1 70mm W2 78mm flange length 127mm flange width 22mm hole distance 114mm bridge length 35mm hole ø 6mm tube ø 6.3mm connection male faston 6.3mm vertical connection length 17mm windings 4		

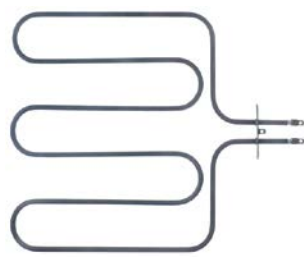

1

<b>GEV No.</b>	420040	<b>Ref. No.</b>	A0YXD4A40
<b>description</b>	heating element 2000W 230V heating circuits 1 L 330mm W 315mm L1 55mm L2 275mm W1 142mm W2 31mm flange length 70mm flange width 22mm hole distance 56mm hole ø 6mm tube ø 6.6mm connection male faston 6.3mm		
<b>For models:</b>	A120788		

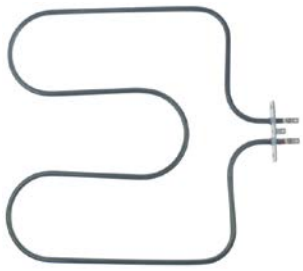

1

<b>GEV No.</b>	420276	<b>Ref. No.</b>	ORES009
<b>description</b>	heating element 1500W 230V heating circuits 1 L 313mm W 300mm L1 48mm L2 305mm W1 135mm W2 30mm flange length 70mm flange width 22mm hole distance 56mm hole ø 5mm tube ø 6.5mm connection male faston 6.3mm windings 2 oven heating element		

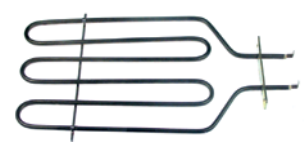

1

<b>GEV No.</b>	416855	<b>Ref. No.</b>	030008373
<b>description</b>	heating element 2300W 230V heating circuits 1 L 345mm W 213mm L1 33mm L2 42mm W1 70mm W2 68mm flange length 130mm flange width 16mm hole distance 104mm hole ø 3mm tube ø 6.3mm connection male faston 6.3mm connection length 48mm rectangular flange dry heating element L3 270mm		

heating elements for bain maries

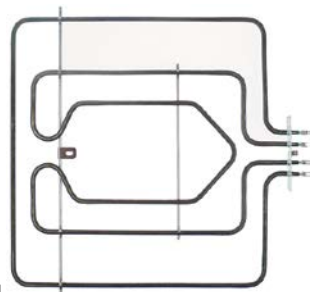

1

<b>GEV No.</b>	420275	<b>Ref. No.</b>	ORES039
<b>description</b>	heating element 2400W 230V heating circuits 2 L 335mm W 350mm L1 30mm L2 305mm W1 145mm W2 60mm flange length 100mm flange width 22mm hole distance 86mm hole ø 5mm tube ø 6.5mm connection male faston 6.3mm oven heating element		

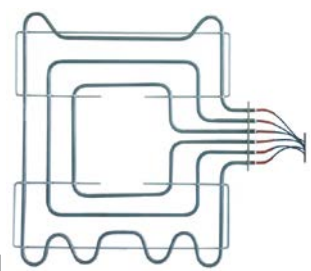

1

<b>GEV No.</b>	416786	<b>Ref. No.</b>	010848
<b>description</b>	heating element 2750W 230/400V heating circuits 3 L 515mm W 580mm L1 55mm L2 460mm W1 130mm W2 225mm flange length 160mm flange width 22mm hole distance 139mm hole ø 4mm tube ø 8.5mm connection cable rectangular flange dry heating element oven cable length 590mm		

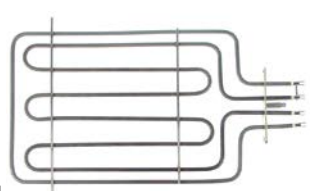

1

<b>GEV No.</b>	418545	<b>Ref. No.</b>	021060
<b>description</b>	heating element 3100W 230V heating circuits 2 L 415mm W 258mm L1 38mm L2 377mm W1 89mm W2 80mm flange length 128mm flange width 22mm hole distance 114mm bridge length 300mm hole ø 4.5mm tube ø 6.5mm connection male faston 6.3mm connection length 65mm mounting pos. upper rectangular flange dry heating element oven		



1

<b>GEV No.</b>	418479	<b>Ref. No.</b>	06530624
<b>description</b>	heating element 950W 230V heating circuits 1 L 405mm W 96mm L1 75mm L2 330mm W1 15mm W2 66mm flange length 110mm flange width 22mm hole distance 95mm connection male faston 6.3mm connection length 18mm tube ø 6.3mm rectangular flange hole ø 5mm dry heating element heated cabinet		



1

<b>GEV No.</b>	418478	<b>Ref. No.</b>	065211001 065211007
<b>description</b>	heating element 1000W 230V heating circuits 1 L 420mm W 200mm connection male faston 6.3mm connection distance 194mm connection length 15mm tube ø 6.3mm dry heating element oven/bain marie H 47mm		



1

<b>GEV No.</b>	417748	<b>Ref. No.</b>	00SL0006
<b>description</b>	heating element 1200W 230V heating circuits 1 L 365mm W 190mm connection cable 500mm tube ø 6.3mm		



1

<b>GEV No.</b>	420542	<b>Ref. No.</b>	OKG1652
<b>description</b>	heating element 1200W 230V heating circuits 1 L 370mm W 185mm connection M4 connection distance 180mm tube ø 6.5mm mounting pos. lower bain marie		



1

<b>GEV No.</b>	417707	<b>Ref. No.</b>	02002301
<b>description</b>	heating element 1300W 230V heating circuits 1 L 405mm W 150mm tube ø 6.8mm		





1

<b>GEV No.</b>	416067	<b>Ref. No.</b>	06001024	
<b>description</b>	heating element 1380W 230V heating circuits 1 L 346mm W 190mm connection M5 tube ø 8.5mm 2 hole fixing thread 1/4" immersion heater W1 70mm W2 105mm H 27mm mounting distance 67mm			
<b>spare parts for</b>	416067			
	<b>GEV No.</b>	510417	<b>Ref. No.</b>	—
	flat gasket fibre ED ø 20mm ID ø 14mm thickness 2mm Qty 1 pcs			
<b>accessories for</b>	416067			
	<b>GEV No.</b>	361182	<b>Ref. No.</b>	—
	nut thread 1/4" H 5mm nickel-plated brass WS 17 Qty 1 pcs			
	<b>GEV No.</b>	520228	<b>Ref. No.</b>	—
	tooth lock washer ID ø 15.3mm ED ø 24mm steel Qty 1 pcs for thread M14			
	<b>GEV No.</b>	550262	<b>Ref. No.</b>	—
	flat gasket copper ED ø 20mm ID ø 14mm thickness 2mm			





Table continues overleaf



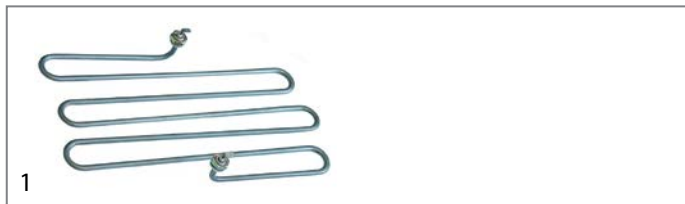







<b>accessories for</b>	416067			
	GEV No.	560112	Ref. No.	—
	plain washer ID ø 5.3mm ED ø 10mm thickness 1mm SS Qty 20 pcs DIN 125A for thread M5			
	GEV No.	560132	Ref. No.	—
	hexagonal nut thread M5 H 4mm WS 8 SS DIN/ISO DIN 934 / ISO 4032/8673 Qty 20 pcs			



<b>GEV No.</b>	416796	<b>Ref. No.</b>	018160	
<b>description</b>	heating element 1500W 240V heating circuits 1 L 325mm W 180mm connection male faston 6.3mm tube ø 6.3mm 2 hole fixing thread 1/4" dry heating element bain marie L1 155mm L2 170mm H 34mm mounting distance 174mm			
<b>accessories for</b>	416796			
	GEV No.	361182	Ref. No.	—
	nut thread 1/4" H 5mm nickel-plated brass WS 17 Qty 1 pcs			
	GEV No.	510417	Ref. No.	—
	flat gasket fibre ED ø 20mm ID ø 14mm thickness 2mm Qty 1 pcs			
	GEV No.	520228	Ref. No.	—
	tooth lock washer ID ø 15.3mm ED ø 24mm steel Qty 1 pcs for thread M14			
	GEV No.	550262	Ref. No.	—
	flat gasket copper ED ø 20mm ID ø 14mm thickness 2mm			

**heating elements for chip scuttles**



<b>GEV No.</b>	416067	<b>Ref. No.</b>	06001024	
<b>description</b>	heating element 1380W 230V heating circuits 1 L 346mm W 190mm connection M5 tube ø 8.5mm 2 hole fixing thread 1/4" immersion heater W1 70mm W2 105mm H 27mm mounting distance 67mm			
<b>spare parts for</b>	416067			
	GEV No.	510417	Ref. No.	—
	flat gasket fibre ED ø 20mm ID ø 14mm thickness 2mm Qty 1 pcs			
<b>accessories for</b>	416067			
	GEV No.	361182	Ref. No.	—
	nut thread 1/4" H 5mm nickel-plated brass WS 17 Qty 1 pcs			
	GEV No.	520228	Ref. No.	—
	tooth lock washer ID ø 15.3mm ED ø 24mm steel Qty 1 pcs for thread M14			
	GEV No.	550262	Ref. No.	—
	flat gasket copper ED ø 20mm ID ø 14mm thickness 2mm			
	GEV No.	560112	Ref. No.	—
	plain washer ID ø 5.3mm ED ø 10mm thickness 1mm SS Qty 20 pcs DIN 125A for thread M5			
	GEV No.	560132	Ref. No.	—
	hexagonal nut thread M5 H 4mm WS 8 SS DIN/ISO DIN 934 / ISO 4032/8673 Qty 20 pcs			

**heating elements for crepes makers**



<b>GEV No.</b>	419011	<b>Ref. No.</b>	010444611	
<b>description</b>	heating element 3000W 230V L 307mm W 272mm H 50mm connec- tion distance 260mm dry heating element heating circuits 1 for crepes maker			
<b>For models:</b>	104447			

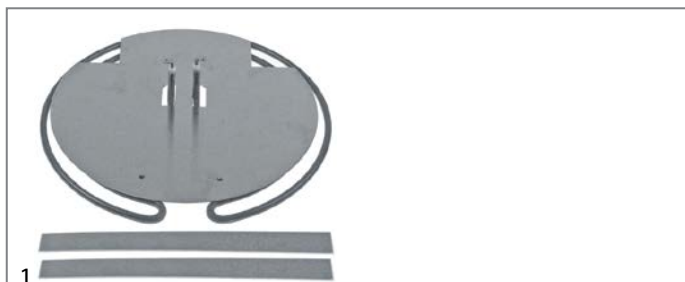



<b>GEV No.</b>	419203	<b>Ref. No.</b>	0301040775	
<b>description</b>	heating element kit 3000W 230V H 50mm tube ø 8.5mm connec- tion screw connection distance 30mm dry heating element heating circuits 1 ø 325mm for crepes maker			

**heating elements for fryers**

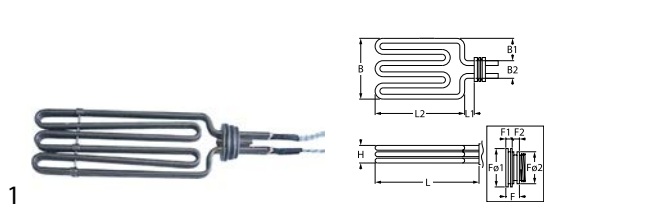
**center connection**



<b>GEV No.</b>	415297	<b>Ref. No.</b>	0211441	
<b>description</b>	heating element 6800W 230/400V heating circuits 3 L 299mm W 107mm H 35mm flange length 19.5mm flange length 1 9.5mm flange length 2 9.8mm flange ø1 62mm flange ø2 57mm thermostat sleeves ø 8.5mm sensor screw connection 2x M10x1 thermostat sleeve up- per/lower L1 16mm L2 283mm W1 30mm W2 77mm thread M54x1.5 tube ø 8.5mm cable length 450mm rotation flange immersion heater			
<b>accessories for</b>	415297			
	GEV No.	510243	Ref. No.	—
	O-ring Viton thickness 3.53mm ID ø 55.56mm Qty 1 pcs			
	GEV No.	510245	Ref. No.	—
	O-ring Viton thickness 3.53mm ID ø 50.8mm Qty 1 pcs			
	GEV No.	550447	Ref. No.	—
	ring nut thread M54x1.5			



2 hole fixing

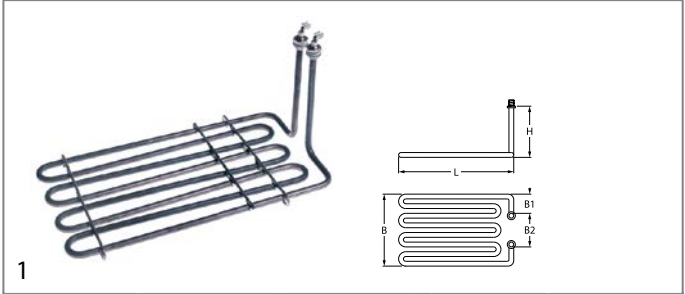

<b>GEV No.</b>	418488	<b>Ref. No.</b>	06537366
<b>description</b>	heating element 2800W 230V heating circuits 1 L 343mm W 180mm H 152mm 2 hole fixing connection male faston 6.3mm W1 66mm W2 44mm thread M12x1 tube ø 8.5mm windings 4 fryer		
<b>accessories for</b>	418488		
	<b>GEV No.</b>	520229	<b>Ref. No.</b> —
	nut thread M12x1 H 4mm WS 16 zinc-coated steel Qty 1 pcs		
	<b>GEV No.</b>	521110	<b>Ref. No.</b> —
	flat gasket fibre ED ø 20mm ID ø 13mm thickness 2mm Qty 1 pcs		
	<b>GEV No.</b>	521131	<b>Ref. No.</b> —
	nut thread M12x1 H 3.5mm WS 17 SS Qty 1 pcs		
	<b>GEV No.</b>	528110	<b>Ref. No.</b> —
	O-ring EPDM thickness 2.62mm ID ø 12.37mm Qty 1 pcs		

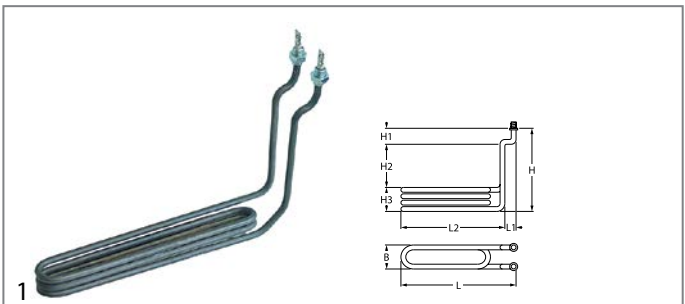

<b>GEV No.</b>	416800	<b>Ref. No.</b>	08208200
<b>description</b>	heating element 2300W 230V heating circuits 1 L 340mm W 42mm H 210mm L1 24mm L2 316mm H1 46mm H2 130mm H3 34mm mounting distance 32mm thread M14x1.5 tube ø 8.5mm connection length 20mm connection M5 2 hole fixing fryer		
<b>spare parts for</b>	416800		
	<b>GEV No.</b>	521101	<b>Ref. No.</b> —
	nut thread M14x1.5 H 5mm WS 19 SS Qty 1 pcs		
<b>accessories for</b>	416800		
	<b>GEV No.</b>	560112	<b>Ref. No.</b> —
	plain washer ID ø 5.3mm ED ø 10mm thickness 1mm SS Qty 20 pcs DIN 125A for thread M5		
	<b>GEV No.</b>	560132	<b>Ref. No.</b> —
	hexagonal nut thread M5 H 4mm WS 8 SS DIN/ISO DIN 934 / ISO 4032/8673 Qty 20 pcs		

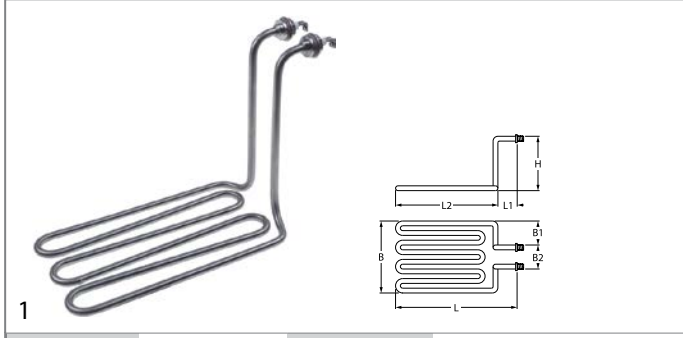

<b>GEV No.</b>	420145	<b>Ref. No.</b>	016240419 A039885
<b>description</b>	heating element 2500W 230V heating circuits 1 L 267mm W 127mm H 187mm 2 hole fixing connection M4 immersion heater L1 32mm L2 235mm W1 38mm W2 50mm tube ø 8mm thread M12x1.25 mounting distance 42mm connection length 15mm windings 3		

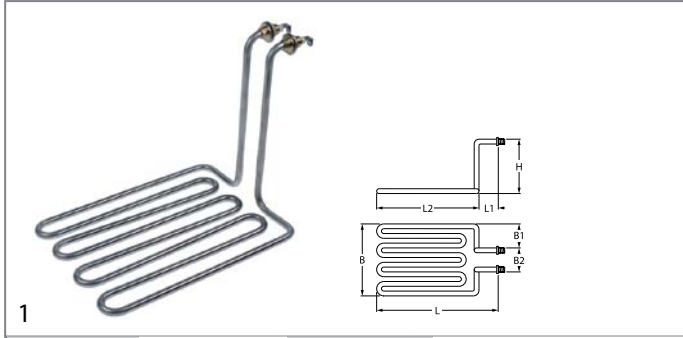

<b>GEV No.</b>	420018	<b>Ref. No.</b>	016210818 A040579
<b>description</b>	heating element 3250W 230V heating circuits 1 L 265mm W 185mm H 200mm 2 hole fixing connection M4 immersion heater L1 25mm L2 240mm W1 71mm W2 42mm tube ø 8.1mm thread M12x1 mounting distance 34mm windings 4		
<b>For models:</b>	A150107, A150207		
<b>spare parts for</b>	420018		
	<b>GEV No.</b>	521131	<b>Ref. No.</b> —
	nut thread M12x1 H 3.5mm WS 17 SS Qty 1 pcs		

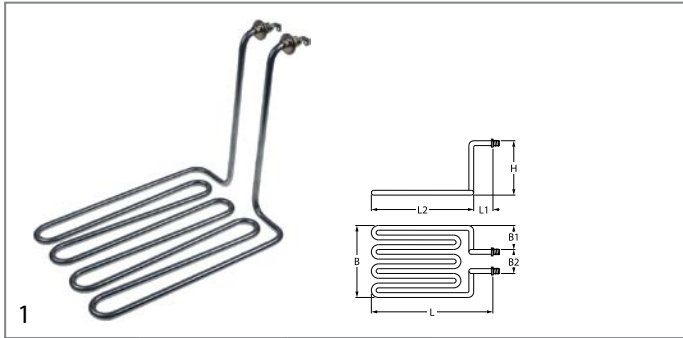





<b>GEV No.</b>	420066	<b>Ref. No.</b>	A039886
<b>description</b>	heating element 3250W 230V heating circuits 1 L 280mm W 180mm H 210mm 2 hole fixing connection M4 immersion heater L1 35mm L2 245mm W1 61mm W2 58mm tube ø 8.1mm thread M12x1.25 mounting distance 50mm windings 4		

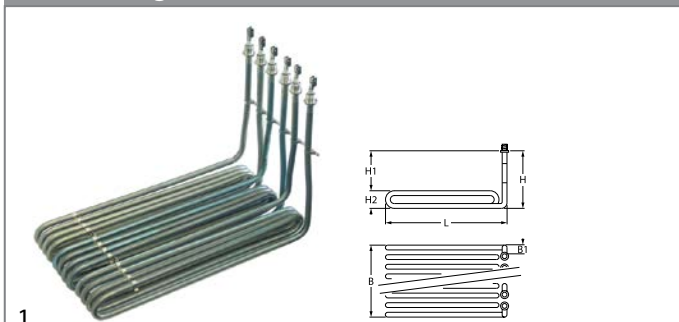

6 hole fixing



<b>GEV No.</b>	416811	<b>Ref. No.</b>	01037317200
<b>description</b>	heating element 9000W 230V heating circuits 3 L 320mm W 175mm H 205mm W1 5mm H1 165mm H2 40mm thread M12x1 tube ø 8.5mm connection male faston 6.3mm immersion heater 6 hole fixing		
<b>spare parts for</b>	416811		
	<b>GEV No.</b>	521110	<b>Ref. No.</b> —
	flat gasket fibre ED ø 20mm ID ø 13mm thickness 2mm Qty 1 pcs		
<b>accessories for</b>	416811		
	<b>GEV No.</b>	520229	<b>Ref. No.</b> —
	nut thread M12x1 H 4mm WS 16 zinc-coated steel Qty 1 pcs		
	<b>GEV No.</b>	521131	<b>Ref. No.</b> —
	nut thread M12x1 H 3.5mm WS 17 SS Qty 1 pcs		
	<b>GEV No.</b>	528110	<b>Ref. No.</b> —
	O-ring EPDM thickness 2.62mm ID ø 12.37mm Qty 1 pcs		

heating elements for hot counters

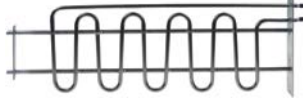
	<b>GEV No.</b>	420065	<b>Ref. No.</b>	03060533
<b>description</b>	heating element 1840W 230V heating circuits 1 L 550mm W 180mm W2 38mm tube ø 8mm connection M4 for hot counter L1 65mm L2 410mm hole distance 187mm flange length 200mm flange width 50mm hole ø 5mm			

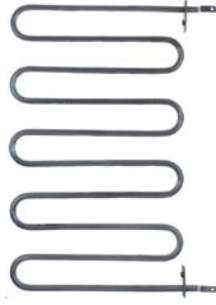
	<b>GEV No.</b>	420039	<b>Ref. No.</b>	A02030937
<b>description</b>	heating element 260W 230V heating circuits 1 L 221mm W 363mm tube ø 8mm connection male faston 6.3mm screw lug length 40mm lug width 15mm			
<b>For models:</b>	A203093, A203094			

heating elements for griddles

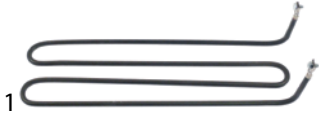
	<b>GEV No.</b>	418934	<b>Ref. No.</b>	021786
<b>description</b>	heating element 1100W 230V heating circuits 1 L 327mm W 96.5mm H 52mm tube ø 6.3mm connection male faston 6.3mm griddle connection distance 76mm dry heating element			

	<b>GEV No.</b>	418489	<b>Ref. No.</b>	065211011
<b>description</b>	heating element 1100W 230V heating circuits 1 L 467mm W 95mm H 52mm tube ø 6.3mm connection M4 griddle dry heating element			

heating elements for chicken rotisseries

	<b>GEV No.</b>	418869	<b>Ref. No.</b>	007032324
<b>description</b>	heating element 1900W 230V thread M14x1.5 L 690mm W 40mm dry heating element tube ø 8.5mm mounting distance 61mm chicken rotisserie			

heating elements for hot dog machines

	<b>GEV No.</b>	418661	<b>Ref. No.</b>	A0401022500
<b>description</b>	heating element 1000W 230V L 180mm W 187mm H 18mm tube ø 6.2mm L1 30mm L2 150mm connection 6.3 connection distance 181mm heating circuits 1 hot dog machine			

heating elements for coffee machine

	<b>GEV No.</b>	420147	<b>Ref. No.</b>	A0ND010
<b>description</b>	heating element 1200W 230V heating circuits 1 D1 ø 65mm H 42mm D2 ø 54mm windings 3 connection male faston 6.3mm immersion heater tube ø 6.5mm for coffee machine			
<b>For models:</b>	A190141, A190161			
<b>accessories for</b>	420147			
	<b>GEV No.</b>	511646	<b>Ref. No.</b>	A0ND011
	gasket silicone ED ø 63mm ID ø 55mm thickness 2.3mm Qty 1 pcs for heating element			



heating elements for contact grills



1

<b>GEV No.</b>	420146	<b>Ref. No.</b>	A0ND012
<b>description</b>	heating element 130W 230V ø 130mm L 130mm H 54mm connection male faston 6.3mm W 130mm heating circuits 1		
<b>For models:</b>	A190141, A190161		



1

<b>GEV No.</b>	417218	<b>Ref. No.</b>	A040640
<b>description</b>	heating element D1 ø 65mm H 42mm tube ø 6.5mm coffee machine		







1

<b>GEV No.</b>	420143	<b>Ref. No.</b>	A0ND037
<b>description</b>	heating element heating circuits 1 D1 ø 65mm H 42mm D2 ø 54mm windings 4 connection male faston 6.3mm immersion heater tube ø 6.5mm for coffee machine		
<b>accessories for</b>	420143		
	<b>GEV No.</b>	511646	<b>Ref. No.</b> A0ND011
	gasket silicone ED ø 63mm ID ø 55mm thickness 2.3mm Qty 1 pcs for heating element		

heating elements for tilting bratt pan



1

<b>GEV No.</b>	416693	<b>Ref. No.</b>	040400084
<b>description</b>	heating element 1650W 230V L 490mm W 45mm H 45mm 2 hole fixing connection M4 thread 1/4" tube ø 8.5mm mounting distance 32mm dry heating element		
<b>accessories for</b>	416693		
	<b>GEV No.</b>	361182	<b>Ref. No.</b> —
	nut thread 1/4" H 5mm nickel-plated brass WS 17 Qty 1 pcs		
	<b>GEV No.</b>	510417	<b>Ref. No.</b> —
	flat gasket fibre ED ø 20mm ID ø 14mm thickness 2mm Qty 1 pcs		
	<b>GEV No.</b>	520228	<b>Ref. No.</b> —
	tooth lock washer ID ø 15.3mm ED ø 24mm steel Qty 1 pcs for thread M14		
	<b>GEV No.</b>	550262	<b>Ref. No.</b> —
	flat gasket copper ED ø 20mm ID ø 14mm thickness 2mm		

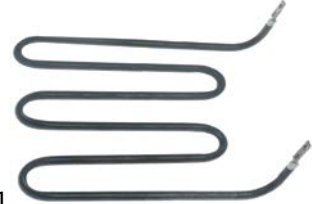

1

<b>GEV No.</b>	419013	<b>Ref. No.</b>	A039855
<b>description</b>	heating element 1000W 230V L 178mm W 180mm H 40mm tube ø 6.25mm connection M4 connection length 22mm dry heating element windings 3 for contact grill		
<b>For models:</b>	A150671		



1

<b>GEV No.</b>	416845	<b>Ref. No.</b>	A017607
<b>description</b>	heating element 1100W 230V L 208mm W 220mm H 25mm tube ø 6.5mm connection distance 65mm cable length 500mm dry heating element heating circuits 1		



1

<b>GEV No.</b>	416853	<b>Ref. No.</b>	A010416
<b>description</b>	heating element 1100W 230V L 210mm W 250mm W1 70mm W2 110mm tube ø 6.3mm cable length 200mm dry heating element windings 3 H 6.3mm		



1

<b>GEV No.</b>	419002	<b>Ref. No.</b>	A041537
<b>description</b>	heating element 1400W 230V heating circuits 1 L 175mm W 305mm H 20mm W1 40mm W2 325mm tube ø 6.3mm windings 5		
<b>For models:</b>	A150674		

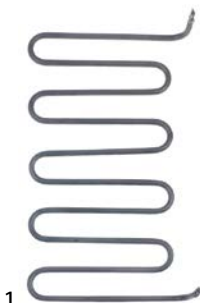
1

<b>GEV No.</b>	419003	<b>Ref. No.</b>	A041538
<b>description</b>	heating element 1550W 240V L 175mm W 305mm H 40mm tube ø 6.3mm connection M4 windings 5		
<b>For models:</b>	A150674		



1

<b>GEV No.</b>	416844	<b>Ref. No.</b>	A010415
<b>description</b>	heating element 900W 230V L 185mm W 247mm W1 80mm W2 100mm tube ø 6.3mm connection cable connection length 18mm cable length 600mm windings 3 H 6.3mm		



1

<b>GEV No.</b>	416843	<b>Ref. No.</b>	A010414
<b>description</b>	heating element 650W 230V L 172mm W 162mm W1 70mm W2 40mm tube ø 6.5mm connection cable cable length 550mm dry heating element windings 3		



1

<b>GEV No.</b>	416854	<b>Ref. No.</b>	030008014
<b>description</b>	heating element 900W 230V L 210mm W 170mm H 20mm W1 55mm W2 60mm tube ø 6.3mm windings 3 cable length 250mm dry heating element		



1

<b>GEV No.</b>	419012	<b>Ref. No.</b>	A039854
<b>description</b>	heating element 800W 230V heating circuits 1 L 175mm W 183mm H 15mm W1 40mm W2 102mm tube ø 6.6mm windings 3 connection M4 mounting pos. upper dry heating element for contact grill		
<b>For models:</b>	A150671		

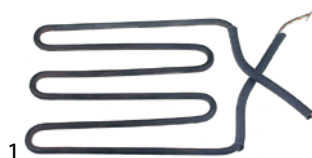

1

<b>GEV No.</b>	416859	<b>Ref. No.</b>	A010418
<b>description</b>	heating element 900W 230V L 210mm W 180mm W1 33mm W2 100mm tube ø 6.3mm connection cable connection length 20mm cable length 240mm windings 3 H 6.3mm		

heating elements for pizza ovens



1

<b>GEV No.</b>	416849	<b>Ref. No.</b>	030008013
<b>description</b>	heating element 800W 230V L 170mm W 167mm H 33mm W1 26mm W2 115mm connection length 30mm tube ø 6.3mm windings 3 cable length 260mm dry heating element		

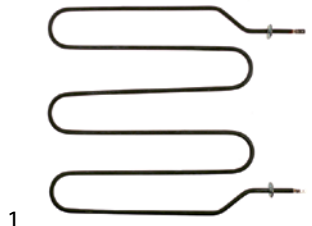

1

<b>GEV No.</b>	418672	<b>Ref. No.</b>	0401031000
<b>description</b>	heating element 1000W 230V heating circuits 1 L 330mm W 300mm L1 30mm L2 60mm L3 240mm W1 35mm W2 230mm lug length 27mm lug width 22mm connection length 55mm connection male faston 6.3mm tube ø 6.3mm 2 hole fixing hole ø 3mm dry heating element pizza oven		



1

<b>GEV No.</b>	416847	<b>Ref. No.</b>	030008049
<b>description</b>	heating element 1000W 230V dry heating element 2 hole fixing pizza oven		





heating elements for salamanders/toast-



<b>GEV No.</b>	416848	<b>Ref. No.</b>	030008062
----------------	--------	-----------------	-----------

**description** heating element 800W 230V L 445mm W 195mm thread 1/4" mounting distance 186mm connection length 15mm connection M4 tube ø 8.5mm heating circuits 1 dry heating element 2 hole fixing

**For models:** ROMA/II

**accessories for** 416848

	<b>GEV No.</b>	361182	<b>Ref. No.</b>	—
--	----------------	--------	-----------------	---

nut thread 1/4" H 5mm nickel-plated brass WS 17 Qty 1 pcs

	<b>GEV No.</b>	510417	<b>Ref. No.</b>	—
--	----------------	--------	-----------------	---

flat gasket fibre ED ø 20mm ID ø 14mm thickness 2mm Qty 1 pcs

	<b>GEV No.</b>	520228	<b>Ref. No.</b>	—
--	----------------	--------	-----------------	---

tooth lock washer ID ø 15.3mm ED ø 24mm steel Qty 1 pcs for thread M14

	<b>GEV No.</b>	550262	<b>Ref. No.</b>	—
--	----------------	--------	-----------------	---

flat gasket copper ED ø 20mm ID ø 14mm thickness 2mm

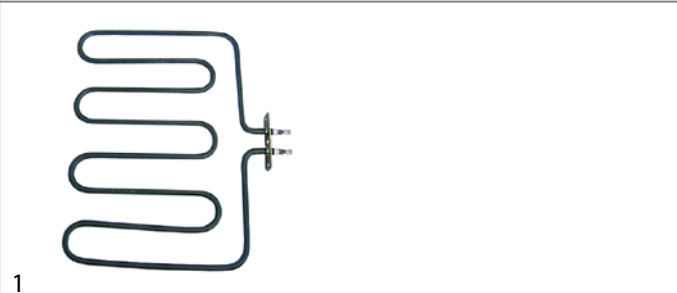

<b>GEV No.</b>	415659	<b>Ref. No.</b>	011029
----------------	--------	-----------------	--------

**description** heating element 2000W 230V heating circuits 1 L 230mm W 303mm L1 35mm L2 195mm W1 135mm W2 33mm flange length 70mm flange width 22mm hole distance 56mm tube ø 8.5mm dry heating element connection M5 rectangular flange hole ø 5mm H 8.5mm

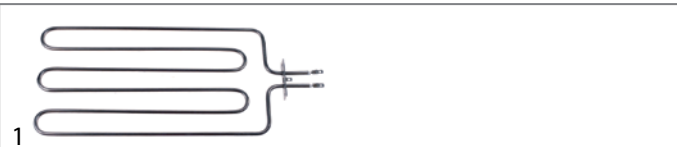

<b>GEV No.</b>	418740	<b>Ref. No.</b>	OAT93607 A0AT93607
----------------	--------	-----------------	-----------------------

**description** heating element 2000W 230V heating circuits 1 L 400mm W 200mm L1 27mm L2 373mm W1 85mm W2 30mm flange length 70mm flange width 22mm hole distance 56mm tube ø 6.5mm rectangular flange hole ø 5mm H 6.5mm

**For models:** A1515001

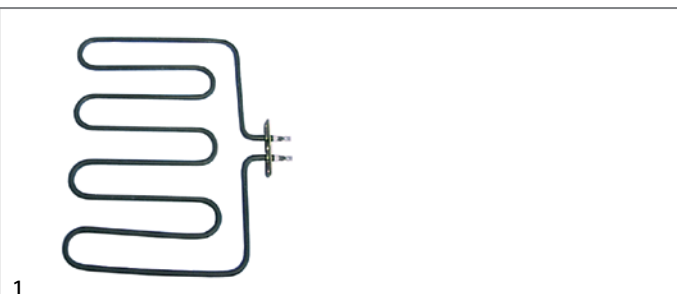

<b>GEV No.</b>	415660	<b>Ref. No.</b>	011003
----------------	--------	-----------------	--------

**description** heating element 2800W 230V heating circuits 1 L 230mm W 298mm L1 20mm L2 210mm W1 133mm W2 32mm flange length 70mm flange width 22mm hole distance 56mm tube ø 8.5mm dry heating element connection M5 rectangular flange hole ø 5mm H 8.5mm

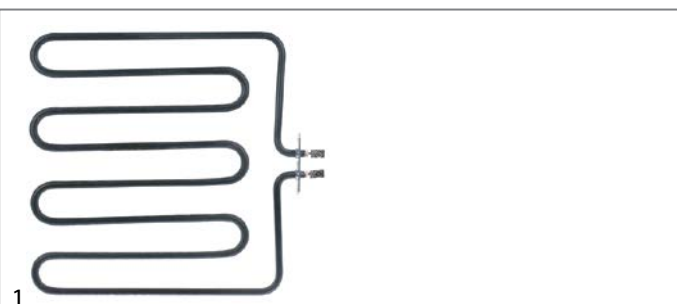

<b>GEV No.</b>	418790	<b>Ref. No.</b>	011008
----------------	--------	-----------------	--------

**description** heating element 2800W 400V heating circuits 1 L 305mm W 300mm L1 18mm L2 287mm W1 130mm W2 25mm flange length 70mm flange width 22mm hole distance 65mm tube ø 8.5mm connection M5 rectangular flange hole ø 5mm salamander grill H 8.5mm

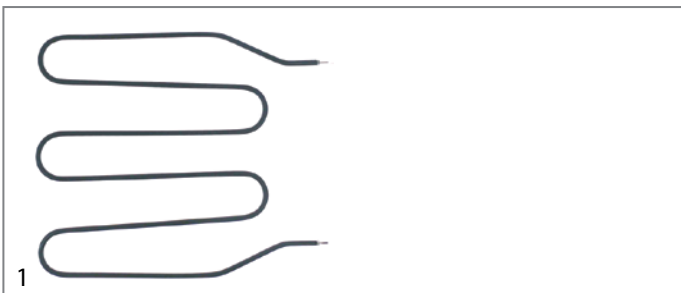

<b>GEV No.</b>	418781	<b>Ref. No.</b>	A02011008
----------------	--------	-----------------	-----------

**description** heating element 900W 230V L 350mm W 300mm connection distance 220mm L1 40mm L2 90mm L3 220mm W1 40mm W2 220mm tube ø 6.3mm heating circuits 1 pizza oven

heating elements for chargrills



<b>GEV No.</b>	415965	<b>Ref. No.</b>	01037311315
----------------	--------	-----------------	-------------

**description** heating element 1800W 230V L 486mm W 83mm H 30mm 2 hole fixing mounting distance 72mm connection M4 L1 38mm L2 448mm heating circuits 1 tube ø 6.3mm dry heating element thread M12x1 for sausage warmer

**accessories for** 415965

	<b>GEV No.</b>	520229	<b>Ref. No.</b>	—
--	----------------	--------	-----------------	---

nut thread M12x1 H 4mm WS 16 zinc-coated steel Qty 1 pcs

	<b>GEV No.</b>	521110	<b>Ref. No.</b>	—
--	----------------	--------	-----------------	---

flat gasket fibre ED ø 20mm ID ø 13mm thickness 2mm Qty 1 pcs

	<b>GEV No.</b>	521131	<b>Ref. No.</b>	—
--	----------------	--------	-----------------	---

nut thread M12x1 H 3.5mm WS 17 SS Qty 1 pcs



	<b>GEV No.</b>	528110	<b>Ref. No.</b>	—
--	----------------	--------	-----------------	---

O-ring EPDM thickness 2.62mm ID ø 12.37mm Qty 1 pcs

<b>GEV No.</b>	418862	<b>Ref. No.</b>	0V036700 A039857 EB-600-15
<b>description</b>	heating element 2000W 230V heating circuits 1 L 235mm W 215mm H 35mm thread M12x1 mounting distance 209mm connection length 48mm tube ø 6.3mm salamander grill		
<b>For models:</b>	EB600		

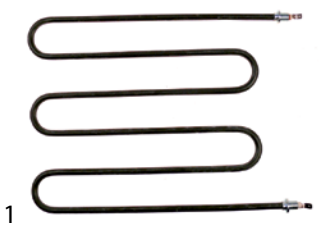

<b>GEV No.</b>	418653	<b>Ref. No.</b>	0401024000
<b>description</b>	heating element 2200W 230V L 350mm W 260mm thread M12 mounting distance 245mm connection 6.3 air tube ø 8.5mm heating circuits 1 H 8.5mm		
<b>spare parts for</b>	418653		
	<b>GEV No.</b>	521110	<b>Ref. No.</b> —
	flat gasket fibre ED ø 20mm ID ø 13mm thickness 2mm Qty 1 pcs		
<b>accessories for</b>	418653		
	<b>GEV No.</b>	520229	<b>Ref. No.</b> —
	nut thread M12x1 H 4mm WS 16 zinc-coated steel Qty 1 pcs		
	<b>GEV No.</b>	521131	<b>Ref. No.</b> —
	nut thread M12x1 H 3.5mm WS 17 SS Qty 1 pcs		
	<b>GEV No.</b>	528110	<b>Ref. No.</b> —
	O-ring EPDM thickness 2.62mm ID ø 12.37mm Qty 1 pcs		





<b>GEV No.</b>	420046	<b>Ref. No.</b>	A039856
<b>description</b>	heating element 2800W 230V heating circuits 1 L 240mm W 350mm H 25mm thread M12x1 mounting distance 342mm tube ø 8.5mm connection M4		
<b>For models:</b>	151510		



<b>GEV No.</b>	416820	<b>Ref. No.</b>	6001071
<b>description</b>	heating element 930W 230V L 260mm W 55mm thread M15x1 mounting distance 45mm connection length 26mm connection M4 tube ø 10mm heating circuits 1 dry heating element 2 hole fixing H 10mm		



<b>GEV No.</b>	416001	<b>Ref. No.</b>	027676
<b>description</b>	radiation heater rectangular 1500W 230/240V L 265mm W 165mm H 32mm heating circuits 1 connections 2 connection type cable cable length 700mm EGO salamander grill		
<b>accessories for</b>	416001		
	<b>GEV No.</b>	390880	<b>Ref. No.</b> 027677
	safety rod thermostat switch-off temp. 780°C temperature range°C 2-pole 1NC/1NOA probe ø 4mm probe L 170mm capillary pipemm capillary pipe isolatedmm gland nut shaft ømm		
	<b>GEV No.</b>	403523	<b>Ref. No.</b> —
	solid state relay ANLY 1 phase 40A 24-280V 4-32VDC L 47.5mm W 43mm screw type ASR-40DA		

**heating elements for heating bridges**



<b>GEV No.</b>	420019	<b>Ref. No.</b>	A01140015
<b>description</b>	heating element 900W 230V heating circuits 1 L 335mm W 110mm connection M4 tube ø 9.7mm connection distance 100mm		
<b>For models:</b>	A114001		

**heating elements for heated cabinets**

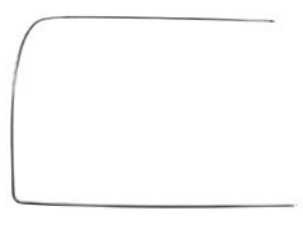

<b>GEV No.</b>	418743	<b>Ref. No.</b>	040576
<b>description</b>	heating element 1200W 230V L 220mm W 680mm H 700mm heated cabinet		
<b>For models:</b>	103.122		



1			
<b>GEV No.</b>	418741	<b>Ref. No.</b>	040827
<b>description</b>	heating element 400W 230V L 220mm W 350mm H 440mm heated cabinet		

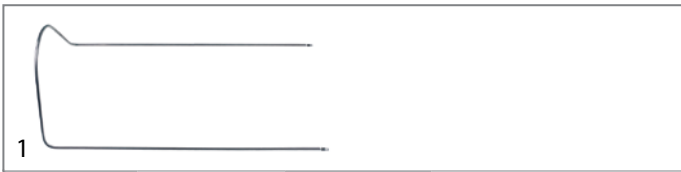

1			
<b>GEV No.</b>	418742	<b>Ref. No.</b>	040577
<b>description</b>	heating element 750W 230V L 220mm W 360mm H 690mm heated cabinet		
<b>For models:</b>	103063		

heating plates



1			
<b>GEV No.</b>	419094	<b>Ref. No.</b>	A01204068
<b>description</b>	hot plate 1000W 230V ø 150mm with mounting thread for hot dog machine connection male faston 6.3mm		



1			
<b>GEV No.</b>	419093	<b>Ref. No.</b>	020051028 020051028+0LY20051028+A01204066 A012040618
<b>description</b>	hot plate 800W 230V ø 125mm with thermostat t.max. 95°C for hot dog machine connection male faston 6.3mm		

quartz heating elements



1			
<b>GEV No.</b>	420048	<b>Ref. No.</b>	A015160016
<b>description</b>	quartz heating element 340W 76V L 385mm ø 11mm connection eye for model A151.600		
<b>For models:</b>	A151600		



1			
<b>GEV No.</b>	416858	<b>Ref. No.</b>	A030008462
<b>description</b>	quartz heating element 420W 115V L 380mm ø 10mm connection male faston 6.3mm		







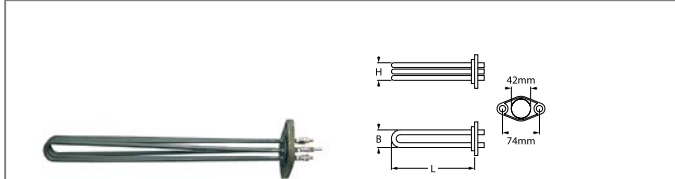

1			
<b>GEV No.</b>	420047	<b>Ref. No.</b>	A041032
<b>description</b>	quartz heating element 425W 120V L 385mm ø 11mm connection eye for model A151.300		
<b>For models:</b>	A151300		

immersion heating elements

2 hole flange 74mm



1			
<b>GEV No.</b>	415190	<b>Ref. No.</b>	0481925928596
<b>description</b>	heating element 6000W 230V mounting ø 42mm heating circuits 3 L 340mm W 34mm H 30mm hole distance 75mm hole ø 9mm connection M4 immersion heater 2 hole flange flange length 93mm flange width 57mm		
<b>accessories for</b>	415190		
	<b>GEV No.</b>	<b>Ref. No.</b>	—
	521103		nut thread M4 H 3mm WS 7 brass Qty 20 pcs
	<b>GEV No.</b>	<b>Ref. No.</b>	—
	521104		washer ID ø 4.3mm ED ø 8mm thickness 0.5mm brass Qty 20 pcs for thread M4
	<b>GEV No.</b>	<b>Ref. No.</b>	0481946669609
	521124		flat gasket rubber ED ø 52mm ID ø 42mm thickness 6mm Qty 1 pcs
	<b>GEV No.</b>	<b>Ref. No.</b>	—
	550444		protection cap ø 47mm H 40mm
	<b>GEV No.</b>	<b>Ref. No.</b>	—
	560111		plain washer ID ø 4.3mm ED ø 9mm thickness 0.8mm SS Qty 20 pcs DIN 125A for thread M4
	<b>GEV No.</b>	<b>Ref. No.</b>	—
	560131		hexagonal nut thread M4 H 3.2mm WS 7 SS DIN/ISO DIN 934 / ISO 4032/8673 Qty 20 pcs

**3 hole flange ø47.5mm**

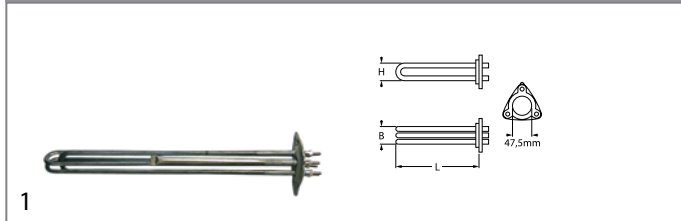

<b>GEV No.</b>	415001	<b>Ref. No.</b>	0230081
<b>description</b>	heating element 4500W 230V mounting ø 47.5mm heating circuits 3 L 316mm W 35mm H 34mm number of thermostat sleeves 1 thermostat sleeves ø 7mm length thermostat sleeves 180mm thermostat sleeve eccentric, non clinging tube ø 6.3mm hole distance 62mm hole ø 8mm connection M4 3 hole flange immersion heater		
<b>spare parts for</b>	415001		
	<b>GEV No.</b>	510408	<b>Ref. No.</b> 011510 011620
	O-ring EPDM thickness 5.34mm ID ø 47mm Qty 1 pcs		
<b>accessories for</b>	415001		
	<b>GEV No.</b>	510562	<b>Ref. No.</b> —
	O-ring silicone thickness 5.34mm ID ø 47mm Qty 1 pcs		
	<b>GEV No.</b>	521103	<b>Ref. No.</b> —
	nut thread M4 H 3mm WS 7 brass Qty 20 pcs		
	<b>GEV No.</b>	521104	<b>Ref. No.</b> —
	washer ID ø 4.3mm ED ø 8mm thickness 0.5mm brass Qty 20 pcs for thread M4		
	<b>GEV No.</b>	560111	<b>Ref. No.</b> —
	plain washer ID ø 4.3mm ED ø 9mm thickness 0.8mm SS Qty 20 pcs DIN 125A for thread M4		
	<b>GEV No.</b>	560131	<b>Ref. No.</b> —
	hexagonal nut thread M4 H 3.2mm WS 7 SS DIN/ISO DIN 934 / ISO 4032/8673 Qty 20 pcs		

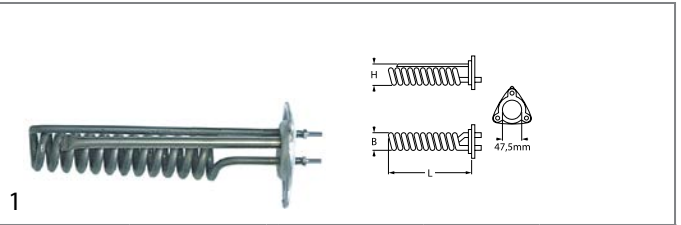

<b>GEV No.</b>	415668	<b>Ref. No.</b>	0230090
<b>description</b>	heating element 2625W 230V mounting ø 47.5mm heating circuits 1 L 190mm W 41mm H 54mm number of thermostat sleeves 1 thermostat sleeves ø 7mm length thermostat sleeves 170mm thermostat sleeve eccentric, non clinging tube ø 6.3mm hole distance 62mm hole ø 8mm connection M4 3 hole flange immersion heater		
<b>spare parts for</b>	415668		
	<b>GEV No.</b>	510408	<b>Ref. No.</b> 011510 011620
	O-ring EPDM thickness 5.34mm ID ø 47mm Qty 1 pcs		
<b>accessories for</b>	415668		
	<b>GEV No.</b>	510562	<b>Ref. No.</b> —
	O-ring silicone thickness 5.34mm ID ø 47mm Qty 1 pcs		

**with compression flange 50 x 26mm**

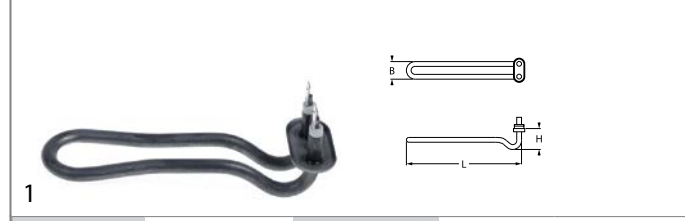

<b>GEV No.</b>	416234	<b>Ref. No.</b>	0230098
<b>description</b>	heating element 600W 230V heating circuits 1 flange 50x26mm L 160mm W 45mm H 27mm tube ø 8.8mm connection male faston 6.3mm connection length 40mm immersion heater compression flange		
<b>accessories for</b>	416234		
	<b>GEV No.</b>	510387	<b>Ref. No.</b> —
	gasket L 46mm W 22mm ømm EPDM for heating element for flange 50x26mm		
	<b>GEV No.</b>	510388	<b>Ref. No.</b> —
	counterflange ømm hole distance mm perforation ømm L 43mm W 21mm SS for heating element for flange 50x26mm		

**1 1/4"**



<b>GEV No.</b>	415005	<b>Ref. No.</b>	012290
<b>description</b>	heating element 2000W 230V heating circuits 1 thread 1 1/4" L 170mm W 32mm H 22mm tube ø 6.2mm connection M4		
<b>accessories for</b>	415005		
	<b>GEV No.</b>	510405	<b>Ref. No.</b> 012291
	flat gasket fibre ED ø 56mm ID ø 42mm thickness 2mm for thread 1 1/4" Qty 1 pcs		
	<b>GEV No.</b>	520232	<b>Ref. No.</b> —
	nut thread 1 1/4" H 5mm nickel-plated brass WS 47 Qty 1 pcs		
	<b>GEV No.</b>	521103	<b>Ref. No.</b> —
	nut thread M4 H 3mm WS 7 brass Qty 20 pcs		
	<b>GEV No.</b>	521104	<b>Ref. No.</b> —
	washer ID ø 4.3mm ED ø 8mm thickness 0.5mm brass Qty 20 pcs for thread M4		
	<b>GEV No.</b>	528021	<b>Ref. No.</b> —
	flat gasket PTFE ED ø 53mm ID ø 42.5mm thickness 3mm Qty 1 pcs equiv. no. 12001/02286 suitable for Astoria/Aurora/Brasilia/Wega		
	<b>GEV No.</b>	560111	<b>Ref. No.</b> —
	plain washer ID ø 4.3mm ED ø 9mm thickness 0.8mm SS Qty 20 pcs DIN 125A for thread M4		
	<b>GEV No.</b>	560131	<b>Ref. No.</b> —
	hexagonal nut thread M4 H 3.2mm WS 7 SS DIN/ISO DIN 934 / ISO 4032/8673 Qty 20 pcs		



<b>GEV No.</b>	415664	<b>Ref. No.</b>	011598
<b>description</b>	heating element 2250W 230V heating circuits 1 L 300mm W 90mm H 25mm thread 1/8" mounting distance 64mm tube ø 6.3mm connection M4 immersion heater 2 hole fixing		
<b>accessories for</b>	415664		
	GEV No.	510893	Ref. No.
	O-ring EPDM thickness 2.62mm ID ø 9.92mm Qty 1 pcs		
	GEV No.	521103	Ref. No.
	nut thread M4 H 3mm WS 7 brass Qty 20 pcs		
	GEV No.	521104	Ref. No.
	washer ID ø 4.3mm ED ø 8mm thickness 0.5mm brass Qty 20 pcs for thread M4		
	GEV No.	521129	Ref. No.
	nut thread M10 H 6mm SS WS 17 Qty 1 pcs DIN/ISO DIN 439		
	GEV No.	560111	Ref. No.
	plain washer ID ø 4.3mm ED ø 9mm thickness 0.8mm SS Qty 20 pcs DIN 125A for thread M4		
	GEV No.	560131	Ref. No.
	hexagonal nut thread M4 H 3.2mm WS 7 SS DIN/ISO DIN 934 / ISO 4032/8673 Qty 20 pcs		

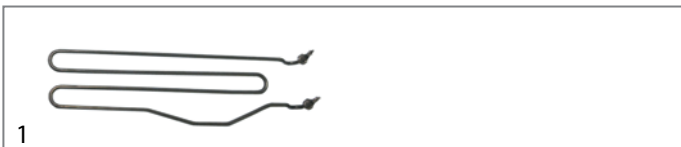

<b>GEV No.</b>	415665	<b>Ref. No.</b>	017677 0230060
<b>description</b>	heating element 2750/3250W 220/240V heating circuits 1 L 380mm W 110mm H 30mm thread M10x1 mounting distance 75mm tube ø 6.5mm connection M4 immersion heater 2 hole fixing		
<b>spare parts for</b>	415665		
	GEV No.	510893	Ref. No.
	O-ring EPDM thickness 2.62mm ID ø 9.92mm Qty 1 pcs		
<b>accessories for</b>	415665		
	GEV No.	510416	Ref. No.
	flat gasket fibre ED ø 19mm ID ø 10.5mm thickness 1.5mm for thread M10 Qty 1 pcs		
	GEV No.	520231	Ref. No.
	nut thread M10x1 H 6mm WS 14 zinc-coated steel Qty 1 pcs		
	GEV No.	521103	Ref. No.
	nut thread M4 H 3mm WS 7 brass Qty 20 pcs		
	GEV No.	521104	Ref. No.
	washer ID ø 4.3mm ED ø 8mm thickness 0.5mm brass Qty 20 pcs for thread M4		
	GEV No.	521129	Ref. No.
	nut thread M10 H 6mm SS WS 17 Qty 1 pcs DIN/ISO DIN 439		
	GEV No.	560111	Ref. No.
	plain washer ID ø 4.3mm ED ø 9mm thickness 0.8mm SS Qty 20 pcs DIN 125A for thread M4		

<b>accessories for</b>	415665		
	GEV No.	560131	Ref. No.
	hexagonal nut thread M4 H 3.2mm WS 7 SS DIN/ISO DIN 934 / ISO 4032/8673 Qty 20 pcs		



<b>GEV No.</b>	416235	<b>Ref. No.</b>	080360
<b>description</b>	heating element 3000W 230V heating circuits 1 L 320mm W 50mm H 40mm thread M10x1 mounting distance 44mm tube ø 6.3mm connection male faston 6.3mm 2 hole fixing L1 32mm L2 288mm		
<b>spare parts for</b>	416235		
	GEV No.	510893	Ref. No.
	O-ring EPDM thickness 2.62mm ID ø 9.92mm Qty 1 pcs		
<b>accessories for</b>	416235		
	GEV No.	510416	Ref. No.
	flat gasket fibre ED ø 19mm ID ø 10.5mm thickness 1.5mm for thread M10 Qty 1 pcs		
	GEV No.	510893	Ref. No.
	O-ring EPDM thickness 2.62mm ID ø 9.92mm Qty 1 pcs		
	GEV No.	521129	Ref. No.
	nut thread M10 H 6mm SS WS 17 Qty 1 pcs DIN/ISO DIN 439		
	GEV No.	560192	Ref. No.
	tooth lock washer ID ø 10.4mm ED ø 18mm SS DIN/ISO DIN 6798A Qty 1 pcs for thread M10		

heating elements for convection

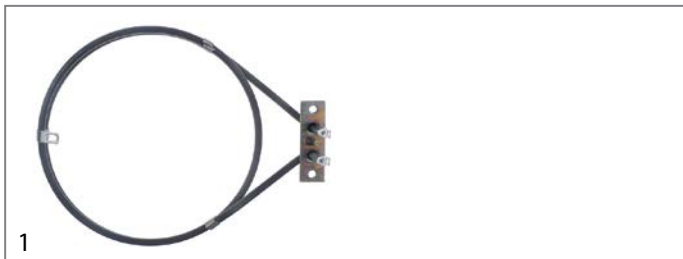



<b>GEV No.</b>	420038	<b>Ref. No.</b>	A0YXD1A4A16
<b>description</b>	heating element 1260W 230V heating circuits 1 ID ø 181mm ED ø 193mm L 240mm H 29mm L1 39mm W1 30mm H1 12mm H2 17mm flange length 70mm flange width 22mm hole distance 56mm connection male faston 6.3mm tube ø 6.6mm hole ø 6mm		
<b>For models:</b>	A120788		





1



<b>GEV No.</b>	416850	<b>Ref. No.</b>	030008381
<b>description</b>	heating element 1260W 230V heating circuits 1 ID ø 182mm ED ø 194mm L 252mm H 30mm L1 48mm W1 30mm H1 10mm H2 20mm flange length 70mm flange width 22mm hole distance 56mm connection male faston 6.3mm tube ø 6.3mm convection heating element hole ø 5mm rectangular flange		
<b>accessories for</b>	416850		
	<b>GEV No.</b>	510368	<b>Ref. No.</b> 02005174
	gasket L 70mm W 23.5mm hole ø 5mm hole distance 56mm FIBER thickness 2mm for heating element		

1



<b>GEV No.</b>	416852	<b>Ref. No.</b>	030008461
<b>description</b>	heating element 2500W 220V heating circuits 1 ID ø 183mm ED ø 195mm L 240mm H 26mm L1 45mm W1 31mm H1 6mm H2 20mm flange length 70mm flange width 22mm hole distance 56mm connection male faston 6.3mm tube ø 6.5mm convection heating element hole ø 5mm rectangular flange		
<b>spare parts for</b>	416852		
	<b>GEV No.</b>	510368	<b>Ref. No.</b> 02005174
	gasket L 70mm W 23.5mm hole ø 5mm hole distance 56mm FIBER thickness 2mm for heating element		



1



<b>GEV No.</b>	416851	<b>Ref. No.</b>	A030008458
<b>description</b>	heating element 1600W 230V heating circuits 1 ID ø 183mm ED ø 195mm L 250mm H 51mm L1 47mm W1 32mm H1 15mm H2 36mm flange length 70mm flange width 22mm hole distance 56mm connection male faston 6.3mm tube ø 6.3mm convection heating element hole ø 5mm rectangular flange		
<b>accessories for</b>	416851		
	<b>GEV No.</b>	510368	<b>Ref. No.</b> 02005174
	gasket L 70mm W 23.5mm hole ø 5mm hole distance 56mm FIBER thickness 2mm for heating element		

1



<b>GEV No.</b>	415966	<b>Ref. No.</b>	ORES006
<b>description</b>	heating element 2500W 230V heating circuits 1 ID ø 176mm ED ø 188mm L 210mm H 28mm L1 22mm W1 30mm H1 3mm H2 25mm flange length 70mm flange width 22mm hole distance 56mm connection male faston 6.3mm tube ø 6.3mm convection heating element hole ø 5mm rectangular flange		
<b>spare parts for</b>	415966		
	<b>GEV No.</b>	510368	<b>Ref. No.</b> 02005174
	gasket L 70mm W 23.5mm hole ø 5mm hole distance 56mm FIBER thickness 2mm for heating element		
<b>accessories for</b>	415966		
	<b>GEV No.</b>	510368	<b>Ref. No.</b> 02005174
	gasket L 70mm W 23.5mm hole ø 5mm hole distance 56mm FIBER thickness 2mm for heating element		

1



<b>GEV No.</b>	418936	<b>Ref. No.</b>	06539168
<b>description</b>	heating element 1700W 240V heating circuits 1 ID ø 176mm ED ø 190mm L 248mm H 34mm L1 58mm W1 31mm H1 12mm H2 22mm flange length 70mm flange width 22mm hole distance 56mm connection male faston 6.3mm connection length 55mm tube ø 6.3mm convection heating element hole ø 5mm rectangular flange		

1



<b>GEV No.</b>	418935	<b>Ref. No.</b>	06527752
<b>description</b>	heating element 2650W 240V heating circuits 1 ID ø 201mm ED ø 218mm L 252mm H 36mm L1 28mm W1 31mm H1 9mm H2 27mm flange length 70mm flange width 23mm hole distance 56mm connection male faston 6.3mm connection length 38mm tube ø 6.3mm convection heating element hole ø 5mm rectangular flange		

1



<b>GEV No.</b>	420534	<b>Ref. No.</b>	ORES015
<b>description</b>	heating element 2000W 240V heating circuits 2 ID ø 220mm ED ø 233mm L 270mm H 44mm L1 16mm W1 58mm H1 14mm H2 30mm flange length 100mm flange width 22mm connection F6.3 tube ø 6.5mm threaded		



1

<b>GEV No.</b>	417607	<b>Ref. No.</b>	ORES000
<b>description</b>	heating element 2x2000W 230V heating circuits 2 ID ø 185mm ED ø 200mm L 240mm H 50mm L1 40mm W1 63mm H1 15mm H2 35mm flange length 100mm flange width 22mm hole distance 85mm connection male faston 6.3mm tube ø 6.4mm hot air hole ø 4.9mm		
<b>accessories for</b>	417607		
	<b>GEV No.</b>	550986	<b>Ref. No.</b> —
	gasket L 100mm W 22mm 7 holes graphite thickness 1mm for heating element		

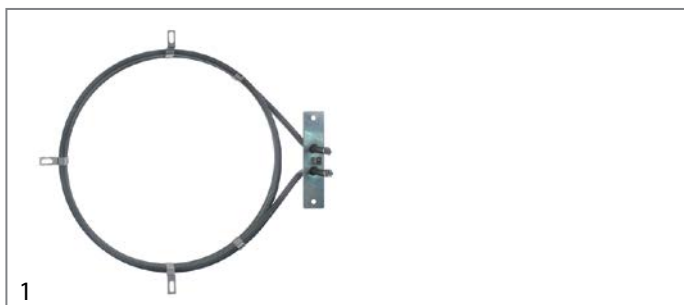

1

<b>GEV No.</b>	419004	<b>Ref. No.</b>	010578052
<b>description</b>	heating element 3100W 230V heating circuits 1 ID ø 223mm ED ø 239mm L 260mm H 60mm L1 20mm W1 23mm H1 20mm H2 40mm flange length 100mm flange width 22mm hole distance 86mm connection M4 tube ø 6.3mm hole ø 5.2mm		
<b>For models:</b>	105780		





1

<b>GEV No.</b>	417606	<b>Ref. No.</b>	ORES026
<b>description</b>	heating element 4500W 230V heating circuits 3 ID ø 220mm ED ø 240mm L 280mm H 50mm L1mm W1 96mm H1 15mm H2 35mm flange length 140mm flange width 25mm hole distance 63mm connection male faston 6.3mm connection length 41.5mm tube ø 8.4mm hot air hole ø 7mm		

### radiation heaters



1

<b>GEV No.</b>	416001	<b>Ref. No.</b>	027676
<b>description</b>	radiation heater rectangular 1500W 230/240V L 265mm W 165mm H 32mm heating circuits 1 connections 2 connection type cable cable length 700mm EGO salamander grill		
<b>accessories for</b>	416001		
	<b>GEV No.</b>	390880	<b>Ref. No.</b> 027677
	safety rod thermostat switch-off temp. 780°C temperature range°C 2-pole 1NC/1NOA probe ø 4mm probe L 170mm capillary pipemm capillary pipe isolatedmm gland nut shaft ømm		
	<b>GEV No.</b>	403523	<b>Ref. No.</b> —
	solid state relay ANLY 1 phase 40A 24-280V 4-32VDC L 47.5mm W 43mm screw type ASR-40DA		

### hot plates

#### square & rectangular

#### with radiused edge



1

<b>GEV No.</b>	490068 <sup>1</sup>	<b>Ref. No.</b>	01122454238
<b>description</b>	hot plate dimensions 220x220mm 2600W 400V with spill ring connection 4 screw clamps protector yes square		

<sup>1</sup>incl. protector



1

<b>GEV No.</b>	490057 <sup>1</sup>	<b>Ref. No.</b>	016726
<b>description</b>	hot plate dimensions 300x300mm 3000W 400V with spill ring connection 4 screw clamps protector yes square		

<sup>1</sup>incl. protector



round

with radiused edge

for domestic and commercial kitchens



1

<b>GEV No.</b>	490014	<b>Ref. No.</b>	017797
<b>description</b>	hot plate ø 180mm 1500W 230V connection 4 screw clamps with 8mm spill ring		



1

<b>GEV No.</b>	490020	<b>Ref. No.</b>	028010
<b>description</b>	hot plate ø 220mm 2600W 230V connection 4 screw clamps with 8mm spill ring		
<b>accessories for</b>	490020		
	<b>GEV No.</b>	550796	<b>Ref. No.</b>
			—
	fixing plate for hot plate ø220mm		

energy regulators

EGO

1-circuit



1

<b>GEV No.</b>	380009	<b>Ref. No.</b>	A0106041
<b>description</b>	energy regulator 230V 13A single-circuit turn direction left shaft ø 6x4.6mm mounting thread M4 no. 50.57020.010		



1

<b>GEV No.</b>	380015	<b>Ref. No.</b>	05057021010
<b>description</b>	energy regulator 230V 13A single-circuit turn direction right shaft ø 6x4.6mm shaft L 23mm mounting thread M4 power release 6-100% no. 50.57021.010		
<b>For models:</b>	151510		

DIAMOND



1

<b>GEV No.</b>	380032	<b>Ref. No.</b>	EB-600-08
<b>description</b>	energy regulator 230V 13.5A turn direction right shaft ø 6x4.6mm shaft L 23mm mounting thread M4 equiv. no. 45ER104C1		

thermostats

bi-metal thermostats

safety bi-metal thermostats



1

<b>GEV No.</b>	390100	<b>Ref. No.</b>	A017405
<b>description</b>	bi-metal safety thermostat hole distance 23.5mm switch-off temp. 110°C 1NC 1-pole 16A connection F6.3 mounting ø 16mm		



1

<b>GEV No.</b>	390708	<b>Ref. No.</b>	A039889
<b>description</b>	bi-metal safety thermostat hole distance 23.5mm switch-off temp. 180°C 1NC 1-pole 16A connection M3 mounting ø 15mm		
<b>For models:</b>	A150671, A150674		



1

<b>GEV No.</b>	390379	<b>Ref. No.</b>	A040625
<b>description</b>	bi-metal safety thermostat hole distance 23.5mm switch-off temp. 150°C 1NC 1-pole 16A connection F6.3		
<b>For models:</b>	A190141, A190161, REGINA90 A190192		
<b>accessories for</b>	390379		
	<b>GEV No.</b>	550389	<b>Ref. No.</b>
			—
	bracket for contact thermostat		

bi-metal thermostats



<b>GEV No.</b>	390319	<b>Ref. No.</b>	236048
<b>description</b>	bi-metal thermostat hole distance 23.8mm switch-off temp. 80°C 1NC 1-pole 16A connection F6.3 2 hole fixing		



<b>GEV No.</b>	390753	<b>Ref. No.</b>	A0ND013
<b>description</b>	bi-metal thermostat hole distance 24mm switch-off temp. 83°C 1NC 1-pole 16A 250V connection F6.3 2 hole fixing for coffee machine		
<b>For models:</b>	A190141, A190161		



<b>GEV No.</b>	390955	<b>Ref. No.</b>	A037165
<b>description</b>	thermostat hole distance 23.5mm switch-off temp. 73°C 1NC 1-pole 10A connection F6.3		
<b>For models:</b>	REGINA90 A190192		

control and safety thermostats

EGO

control thermostats

51.\_ series



<b>GEV No.</b>	375261	<b>Ref. No.</b>	0104231
<b>description</b>	thermostat t.max. 190°C temperature range 94-190°C 1-pole 1NO 15A probe ø 6mm probe L 133mm capillary pipe 890mm capillary pipe isolated 700mm gland nut M10x1 shaft L 23mm shaft position upper rotation 318°		



<b>GEV No.</b>	390306	<b>Ref. No.</b>	0236027
<b>description</b>	thermostat t.max. 85°C temperature range fixed 85°C 1-pole gland nut		

55.10/19\_ series



<b>GEV No.</b>	375002	<b>Ref. No.</b>	A010401
<b>description</b>	thermostat t.max. 320°C temperature range 55-320°C 1-pole 1NO 16A probe ø 3.1mm probe L 226mm capillary pipe 870mm capillary pipe isolated 850mm gland nut shaft L 23mm shaft position upper rotation 270°		



<b>GEV No.</b>	390416	<b>Ref. No.</b>	0481927128594
<b>description</b>	thermostat t.max. 85°C temperature range fixed 85°C 1-pole 1CO 16A probe ø 6mm probe L 129mm capillary pipe 1470mm capillary pipe isolated 1430mm gland nut shaft Lmm shaft position		



55.13\_series



<b>GEV No.</b>	390719	<b>Ref. No.</b>	A02030935
<b>description</b>	thermostat t.max. 110°C temperature range 30-110°C 1-pole 1NO 16A probe ø 6mm probe L 115mm capillary pipe 830mm capillary pipe isolatedmm gland nut shaft ø 6x4.6mm shaft L 23mm shaft position left rotation 270°		
<b>For models:</b>	A203093		



<b>GEV No.</b>	375705	<b>Ref. No.</b>	06528193
<b>description</b>	thermostat t.max. 110°C temperature range 30-110°C 1-pole 1NO 16A probe ø 6mm probe L 115mm capillary pipe 1430mm capillary pipe isolatedmm gland nut M9x1 shaft ø 6x4.6mm shaft L 23mm shaft position upper rotation 270°		



<b>GEV No.</b>	375788	<b>Ref. No.</b>	021899
<b>description</b>	thermostat t.max. 175°C temperature range 101-175°C 1-pole 1NO 16A probe ø 6mm probe L 98mm capillary pipe 870mm capillary pipe isolated 800mm gland nut shaft ø 6x4.6mm shaft L 23mm shaft position upper rotation 270°		



<b>GEV No.</b>	375517	<b>Ref. No.</b>	A039882
<b>description</b>	thermostat t.max. 190°C temperature range 60-190°C 1-pole 1NO 16A probe ø 6mm probe L 77mm capillary pipe 870mm capillary pipe isolatedmm gland nut shaft ø 6/4.6mm shaft L 23mm shaft position left° rotation 270°		
<b>For models:</b>	A150107, A150207		
<b>accessories for</b>	375517		
	<b>GEV No.</b>	<b>Ref. No.</b>	016240433
	 gasket for temperature probe ED ø 15mm plastic Qty 1 pcs		



<b>GEV No.</b>	375492	<b>Ref. No.</b>	014231
<b>description</b>	thermostat t.max. 190°C temperature range 94-190°C 1-pole 1NO 16A probe ø 6mm probe L 94mm capillary pipe 1090mm capillary pipe isolated 960mm gland nut M10x1 shaft ø 6x4.6mm shaft L 23mm shaft position upper rotation 310° probe material SS		

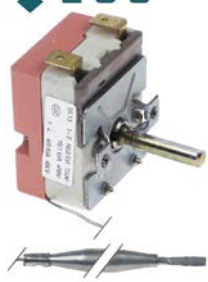

<b>GEV No.</b>	375615	<b>Ref. No.</b>	0KG20509
<b>description</b>	thermostat t.max. 200°C temperature range 68-200°C 1-pole 1NO 16A probe ø 6mm probe L 78mm capillary pipe 870mm capillary pipe isolatedmm gland nut shaft ø 6x4.6mm shaft L 25mm shaft position left° rotation 270° probe material SS		
<b>For models:</b>	A203094		





<b>GEV No.</b>	375087	<b>Ref. No.</b>	06553670
<b>description</b>	thermostat t.max. 300°C temperature range 50-300°C 1-pole 1CO 16A probe ø 3.03mm probe L 160mm capillary pipe 1130mm capillary pipe isolated 1103mm gland nut shaft L 23mm shaft position upper rotation 270°		



<b>GEV No.</b>	375505	<b>Ref. No.</b>	01044465 030008099 A039884
<b>description</b>	thermostat t.max. 320°C temperature range 50-320°C 1-pole 1NO 16A probe ø 3mm probe L 160mm capillary pipe 870mm capillary pipe isolatedmm gland nut shaft ø 6x4.6mm shaft L 23mm shaft position upper rotation 270°		
<b>For models:</b>	104447, A150671, A150674		



<b>GEV No.</b>	375530	<b>Ref. No.</b>	029154
<b>description</b>	thermostat t.max. 400°C temperature range 100-400°C 1-pole 1NO 16A probe ø 3.9mm probe L 163mm capillary pipe 830mm capillary pipe isolatedmm gland nut shaft ø 6x4.6mm shaft L 23mm shaft position upper rotation 270°		

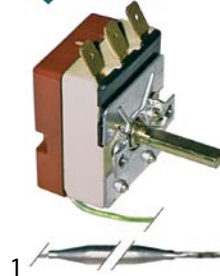



<b>GEV No.</b>	375006	<b>Ref. No.</b>	040575
<b>description</b>	thermostat t.max. 85°C temperature range 30-85°C 1-pole 1CO 16A probe ø 6mm probe L 92mm capillary pipe 3150mm capillary pipe isolated 300mm gland nut shaft L 23mm shaft position upper rotation 270° probe material SS		
<b>For models:</b>	103.122, 103063		

55.14\_ series



<b>GEV No.</b>	390001	<b>Ref. No.</b>	022823 0236023
<b>description</b>	thermostat t.max. 58°C temperature range fixed 58°C 1-pole 1NC 16A probe ø 11mm probe L 35mm capillary pipe 580mm capillary pipe isolated 580mm gland nut shaft Lmm shaft position° shaft position screw-in probe probe thread M14x1		

<b>accessories for</b>	390001		
	<b>GEV No.</b>	510417	<b>Ref. No.</b> —
	flat gasket fibre ED ø 20mm ID ø 14mm thickness 2mm Qty 1 pcs		
	<b>GEV No.</b>	550261	<b>Ref. No.</b> —
	nut thread M14x1 H 4mm WS 19 SS Qty 1 pcs		

55.18\_ series



<b>GEV No.</b>	375110	<b>Ref. No.</b>	A010502
<b>description</b>	thermostat t.max. 190°C temperature range 121-190°C 1-pole 1NC 16A probe ø 6mm probe L 117mm capillary pipe 390mm capillary pipe isolatedmm gland nut shaft ø 6x4.6mm shaft L 15mm shaft position left rotation 270° probe material SS		



55.34\_series



<b>GEV No.</b>	375385	<b>Ref. No.</b>	023964
<b>description</b>	thermostat t.max. 180°C temperature range 100-180°C 3-pole 3NO 16A probe ø 6mm probe L 131mm capillary pipe 2000mm capillary pipe isolated 1800mm gland nut shaft ø 6x4.6mm shaft L 23mm shaft position upper rotation 270°		

55.13\_series



<b>GEV No.</b>	375830	<b>Ref. No.</b>	020411
<b>description</b>	safety thermostat switch-off temp. 365°C 1-pole 1NC 16A probe ø 3mm probe L 160mm capillary pipe 1730mm capillary pipe isolated 1710mm gland nut probe		



<b>GEV No.</b>	375412	<b>Ref. No.</b>	016728
<b>description</b>	thermostat t.max. 320°C temperature range 50-320°C 3-pole 3NO 16A probe ø 3.1mm probe L 226mm capillary pipe 1480mm capillary pipe isolated 1400mm gland nut shaft ø 6x4.6mm shaft L 23mm shaft position upper rotation 318°		

55.32\_series



<b>GEV No.</b>	390813	<b>Ref. No.</b>	049050
<b>description</b>	safety thermostat switch-off temp. 245°C 3-pole 20A probe ø 6mm probe L 78mm capillary pipe 1500mm capillary pipe isolated 1050mm gland nut M9x1 probe		

safety thermostats

55.11\_series



<b>GEV No.</b>	375109	<b>Ref. No.</b>	A010501
<b>description</b>	safety thermostat switch-off temp. 240°C 1-pole 16A probe ø 4mm probe L 91mm capillary pipe 530mm capillary pipe isolated 350mm gland nut probe SS		



<b>GEV No.</b>	375312	<b>Ref. No.</b>	023965
<b>description</b>	safety thermostat switch-off temp. 245°C 3-pole 3NC 20A probe ø 4mm probe L 120mm capillary pipe 1800mm capillary pipe isolated 1800mm gland nut probe SS		
<b>accessories for</b>	375312		
	<b>GEV No.</b>	550981	<b>Ref. No.</b> —
	probe clip for pipe ø 8.5mm for probe ø 6mm for heating elements spacing 0.4mm Qty 1 pcs		

55.33\_ series



<b>GEV No.</b>	375796	<b>Ref. No.</b>	06537879
<b>description</b>	safety thermostat switch-off temp. 220°C 3-pole 3NC 20A probe ø 6mm probe L 107mm capillary pipe 870mm capillary pipe isolated 800mm gland nut probe		

control thermostats with operation switch

55.10/19\_ series



<b>GEV No.</b>	390052	<b>Ref. No.</b>	049672
<b>description</b>	thermostat t.max. 185°C temperature range 90-185°C 1-pole 1NO 15A probe ø 4mm probe L 229mm capillary pipe 2500mm capillary pipe isolated 1200/200mm gland nut shaft ø 6x4.6mm shaft L 23mm shaft position upper° rotation 270° outer switch 2NO		

IMIT / TEMPOMATIC / ARTHERMO

control thermostats



<b>GEV No.</b>	390421	<b>Ref. No.</b>	0236043
<b>description</b>	thermostat t.max. 85°C temperature range 0-90°C 1-pole 1CO 16A probe ø 6.5mm probe L 95mm capillary pipe 1500mm capillary pipe isolated 1450mm gland nut shaft ømm shaft Lmm shaft position rotation 270° probe material copper		

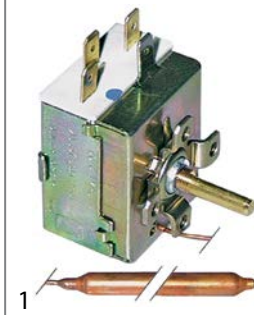

<b>GEV No.</b>	390006	<b>Ref. No.</b>	0929044	
<b>description</b>	thermostat t.max. 86°C temperature range 0-86°C 1-pole 1CO 16A probe ø 6.5mm probe L 95mm capillary pipe 1500mm capillary pipe isolatedmm gland nut shaft ø 6x4.6mm shaft L 19mm rotation 270°			
<b>accessories for</b>	390006			
	<b>GEV No.</b>	110100	<b>Ref. No.</b>	—
	knob thermostat t.max. 90°C 0-90°C ø 42mm shaft ø 6x4.6mm shaft flat -135° black			
	<b>GEV No.</b>	110105	<b>Ref. No.</b>	—
	rosette knob ø 42mm ø 56mm zero mark			

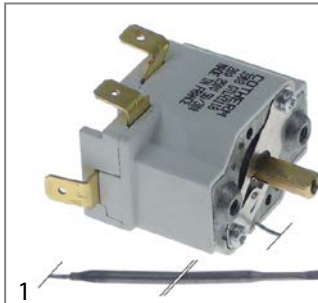

<b>GEV No.</b>	390718	<b>Ref. No.</b>	A0YXD1A4A11
<b>description</b>	thermostat temperature range 50-300°C 1-pole 1NO 20A probe ø 3mm probe L 190mm capillary pipe 900mm shaft ø 6x4.6mm shaft L 12.5mm shaft position upper rotation 270° 250V		
<b>For models:</b>	105780, A120788		

CAEM control thermostats





<b>GEV No.</b>	390602	<b>Ref. No.</b>	A0402503000
<b>description</b>	thermostat t.max. 300°C temperature range 50-300°C 1-pole 1NO 16A probe ø 5mm probe L 70mm capillary pipe 900mm capillary pipe isolated 700mm gland nut shaft L 18mm rotation 270°		



 <p>1</p>			
<b>GEV No.</b>	375419	<b>Ref. No.</b>	A030008288
<b>description</b>	thermostat t.max. 300°C temperature range 50-300°C 1-pole 1NO 16A probe ø 5mm probe L 90mm capillary pipe 890mm rotation 270°		

**safety thermostats**

 <p>1</p>			
<b>GEV No.</b>	376029	<b>Ref. No.</b>	TER008
<b>description</b>	safety thermostat switch-off temp. 320°C temperature range °C 1-pole 1NC 20A probe ø 3mm probe L 165mm capillary pipe 1280mm capillary pipe isolated 1080mm gland nut shaft ømm probe SS 250V		

 <p>1</p>			
<b>GEV No.</b>	375990	<b>Ref. No.</b>	OTER035 OTER325 TER002 TER008 old
<b>description</b>	safety thermostat switch-off temp. 335°C 1-pole 16A probe ø 3mm probe L 180mm capillary pipe 1400mm capillary pipe isolatedmm gland nut M10x1 probe SS		

**PRODIGY / FIRT**

**safety thermostats**

 <p>1</p>			
<b>GEV No.</b>	375478	<b>Ref. No.</b>	0927106
<b>description</b>	safety thermostat switch-off temp. 200°C temperature range °C 1-pole 1CO 20A probe ø 3.3mm probe L 190mm capillary pipe 2150mm capillary pipe isolatedmm gland nut probe SS		

**various**

**control thermostats**

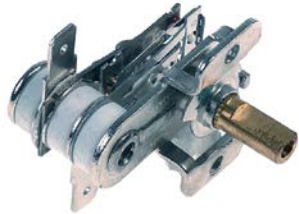
 <p>1</p>			
<b>GEV No.</b>	390623	<b>Ref. No.</b>	A02011002
<b>description</b>	thermostat for pizza oven		

 <p>1</p>			
<b>GEV No.</b>	376082	<b>Ref. No.</b>	020006332
<b>description</b>	thermostat t.max. 100°C 16A probe ø 6mm probe L 88mm capillary pipe 510mm capillary pipe isolated 160mm shaft ø 6x4.6mm shaft L 20mm rotation 270°		

 <p>1</p>			
<b>GEV No.</b>	390622	<b>Ref. No.</b>	01143566
<b>description</b>	thermostat t.max. °C temperature range °C 1-pole 1NC 10A probe ømm probe Lmm capillary pipemm capillary pipe isolatedmm gland nut shaft ø 6x4.6mm shaft L 30mm shaft position upper rotation 315° for heated cabinet		

**safety thermostats**

 <p>1</p>			
<b>GEV No.</b>	375523	<b>Ref. No.</b>	016240438 A039891
<b>description</b>	safety thermostat switch-off temp. 230°C 1-pole 1NC 16A probe ø 4mm probe L 100mm capillary pipe 900mm capillary pipe isolated 410mm gland nut probe		
<b>For models:</b>	A150107, A150207		



1

<b>GEV No.</b>	390720	<b>Ref. No.</b>	A0YXD4A26
<b>description</b>	thermostat switch-off temp. 320°C 1-pole 1NC 16A probe ø 5mm probe L 57mm capillary pipe 870mm capillary pipe isolated 45mm screw connection M10x1		
<b>For models:</b>	105780, A120788		

rod thermostats

safety rod thermostats



1

<b>GEV No.</b>	390880	<b>Ref. No.</b>	027677
<b>description</b>	safety rod thermostat switch-off temp. 780°C temperature range°C 2-pole 1NC/1NOA probe ø 4mm probe L 170mm capillary pipemm capillary pipe isolatedmm gland nut shaft ømm		

refrigeration thermostats

miscellaneous producers



1

<b>GEV No.</b>	390481	<b>Ref. No.</b>	030008404
<b>description</b>	thermostat		

accessories

probe clips

clamps

for thermostat



1

<b>GEV No.</b>	692185	<b>Ref. No.</b>	016210821
<b>description</b>	probe clip for probe ø 6mm SS Qty 1 pcs L 40mm W 14mm		



1

<b>GEV No.</b>	692184	<b>Ref. No.</b>	016240410
<b>description</b>	probe clip for probe ø 6mm SS Qty 1 pcs L 57mm W 20mm		

switches and momentary switches  
rocker/momentary rocker switches

30x11 mm



1

<b>GEV No.</b>	301010	<b>Ref. No.</b>	A0ND021	
<b>description</b>	rocker switch mounting measurements 30x11mm red 1NO/indicator light 250V 16A 0-I connection male faston 6.3mm ambient temperature max. 85/125°C protection IP40			
<b>For models:</b>	A190141, A190161			
<b>accessories for</b>	301010			
	<b>GEV No.</b>	301035	<b>Ref. No.</b>	—
	protective cover mounting measurements 30x11mm			



1

<b>GEV No.</b>	301038	<b>Ref. No.</b>	01143568
<b>description</b>	rocker switch mounting measurements 30x11mm green 1NO/indicator light 250V 16A connection male faston 6.3mm		



1

<b>GEV No.</b>	346890	<b>Ref. No.</b>	SL0758	
<b>description</b>	rocker switch mounting measurements 30x11mm black 1CO 250V 16A I-II connection male faston 6.3mm ambient temperature max. 85°C/145°C protection IP65 with cover cap			
<b>accessories for</b>	346890			
	<b>GEV No.</b>	301035	<b>Ref. No.</b>	—
	protective cover mounting measurements 30x11mm			

30x22mm





1

<b>GEV No.</b>	347791	<b>Ref. No.</b>	A040573
<b>description</b>	rocker switch mounting measurements 30x22mm green 2NO 230V 20A illuminated 0-I connection male faston 6.3mm ambient temperature max. 125/55°C protection IP65 with rubber collar		







			
1			
<b>GEV No.</b>	347531	<b>Ref. No.</b>	016210836
<b>description</b>	rocker switch mounting measurements 30x22mm green 2NO 250V 20A illuminated 0-I connection male faston 6.3mm ambient temperature max. 125/55°C protection IP65 with rubber collar		

			
1			
<b>GEV No.</b>	301062	<b>Ref. No.</b>	06540129
<b>description</b>	rocker switch mounting measurements 30x22mm green 2NO 250V 16A illuminated connection male faston 6.3mm ambient temperature max. 100/55°C protection IP40		
<b>accessories for</b>	301062		
	<b>GEV No.</b>	301036	<b>Ref. No.</b>
			—
	 protective cover internal size 30x22mm for rocker switch mounting measurementsmm		

			
1			
<b>GEV No.</b>	301101	<b>Ref. No.</b>	030008385
<b>description</b>	rocker switch mounting measurements 30x22mm white 2CO 250V 16A connection male faston 6.3mm ambient temperature max. 100/55°C protection IP40		

blank			
			
1			
<b>GEV No.</b>	301005	<b>Ref. No.</b>	A017615
<b>description</b>	rocker switch mounting measurements 30x22mm red 2NO 250V 16A illuminated connection male faston 6.3mm ambient temperature max. 125/55°C protection IP65 with protecting cover		
<b>accessories for</b>	301005		
	<b>GEV No.</b>	301036	<b>Ref. No.</b>
			—
	 protective cover internal size 30x22mm for rocker switch mounting measurementsmm		

**push/momentary push switches**

ø16mm			
			
1			
<b>GEV No.</b>	347363	<b>Ref. No.</b>	A038978
<b>description</b>	momentary push switch mounting ø 16mm black 1NO 250V 3A connection male faston 4.8mm ambient temperature max. 85°C protection IP40		
<b>For models:</b>	105780, A120788		

ø25mm			
			
1			
<b>GEV No.</b>	348211	<b>Ref. No.</b>	016148
<b>description</b>	push switch mounting ø 25mm red 1NO/indicator light 250V 16A illuminated connection male faston 6.3mm ambient temperature max. 85°C protection IP65 with cover		

overload switches			
			
1			
<b>GEV No.</b>	348137	<b>Ref. No.</b>	017319526
<b>description</b>	push switch KLD-28A mounting measurements 45x22mm green/red 2NO/A1 250V 16A I O connection male faston 2.8mm/6.3mm ambient temperature max. 85°C protection IP55 with cover cap		

toggle switches			
M12x1			
			
1			
<b>GEV No.</b>	347340	<b>Ref. No.</b>	A01140013
<b>description</b>	toggle switch thread M12x1 1NO 250V 15A ON-OFF screw		
<b>For models:</b>	A114001		

microswitches			
lever actuated			
			
1			
<b>GEV No.</b>	345049	<b>Ref. No.</b>	011505 011644 012273
<b>description</b>	microswitch with lever CO connection male faston		

pin-plunger actuated			
			
1			
<b>GEV No.</b>	345060	<b>Ref. No.</b>	A0800045
<b>description</b>	microswitch with plunger 250V 16A 1NO connection male faston 6.3mm ambient temperature max. 85°C mounting distance 22mm type BS1010 actuating force: 350g red stroke 9mm		



## M10



1

<b>GEV No.</b>	347341	<b>Ref. No.</b>	016240435 A040031
<b>description</b>	microswitch with plunger thread M10x1 thread L 16mm 250V 10A 1NO connection male faston 6.3mm stroke 5mm mounting distance L 41mm ambient temperature max. 85°C type X3L502K6DD actuating force: 130g		
<b>For models:</b>	A150107, A150207		

## M12



1

<b>GEV No.</b>	345138	<b>Ref. No.</b>	010578032
<b>description</b>	microswitch with plunger mounting distance 25mm thread M12x1 thread L 12mm 250V 20A 1CO connection screw stroke 7mm L1 13mm ambient temperature max. 85°C type Z15G1307 actuating force: 250g		
<b>For models:</b>	105780		

## system switches (ROLD)



1

<b>GEV No.</b>	345606	<b>Ref. No.</b>	0226071
<b>description</b>	momentary switch unit 2CO 250V 16A connection male faston 6.3mm		



1

<b>GEV No.</b>	345538	<b>Ref. No.</b>	0227050
<b>description</b>	push button ø 11.9mm black		

## cam switches

## 4-position

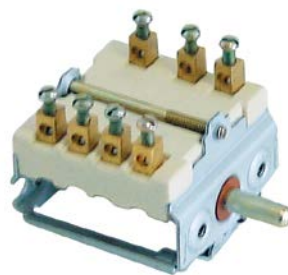

1

<b>GEV No.</b>	300094	<b>Ref. No.</b>	A010708
<b>description</b>	cam switch 4 operating positions 1NO/2CO sequence 0-1-2-3 16A shaft ø 6x4.6mm shaft L 15mm connection screw 4-position ceramic		

## 7-position



1

<b>GEV No.</b>	300031	<b>Ref. No.</b>	06553435 A030008088
<b>description</b>	cam switch 7 operating positions 1NO/2CO sequence 0-1-2-3-4-5-6 16A shaft ø 6x4.6mm shaft L 23mm connection male faston 6.3mm 7-position plastic		

## 4 operating positions



1

<b>GEV No.</b>	347366	<b>Ref. No.</b>	A040081
<b>description</b>	rotary switch 4 operating positions 2NO sequence 0-1-2-3 16A shaft ø 6x4.6mm shaft L 23mm connection male faston 6.3mm 250V A040081 sets of contacts 2 plastic for oven		
<b>For models:</b>	A151600		



**operation switches**

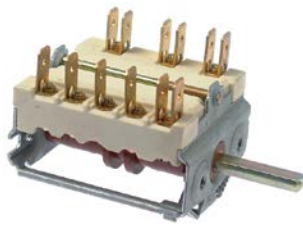

<b>GEV No.</b>	300209	<b>Ref. No.</b>	06552194
<b>description</b>	cam switch 5 operating positions operation switch 16A sequence 0-1-2-3-4 shaft $\varnothing$ 6x4.6mm shaft L 23mm connection male faston ceramic 3-pole ambient temperature max. 330°C		

**rotary switches**

**miscellaneous**



<b>GEV No.</b>	347367	<b>Ref. No.</b>	A040080
<b>description</b>	rotary switch sets of contacts 2 4 0-1-2-3 type A040080 250V 16A shaft $\varnothing$ 6x4.6mm shaft L 22.5mm with knob connection male faston 6.3mm for oven		
<b>For models:</b>	A151300		
<b>accessories for</b>	347367		
	<b>GEV No.</b>	112626	<b>Ref. No.</b> A040082
	knob oven t.max.°C $\varnothing$ 41mm shaft $\varnothing$ 6x4.6mm shaft flat lower black		

**magnetic switches**

**accessories**

**magnets**

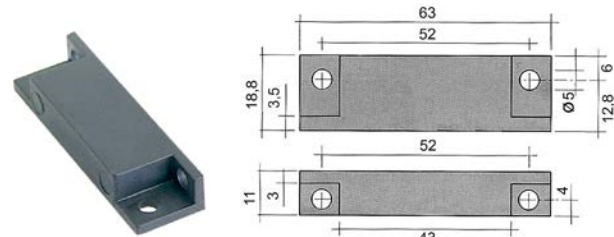

<b>GEV No.</b>	345336	<b>Ref. No.</b>	0926014
<b>description</b>	magnet $\varnothing$ 4.8mm L 63mm H 11mm W 18.8mm hole distance 51mm M4		

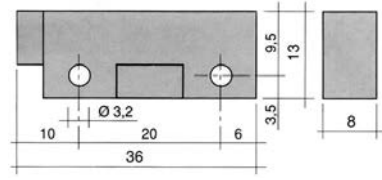

<b>GEV No.</b>	345398	<b>Ref. No.</b>	0217003
<b>description</b>	magnet $\varnothing$ mm L 36mm H 8mm W 13mm hole distance 20mm M3 hole $\varnothing$ 3mm		

**lamps**

**indicator lights**

**indicator lights 2-piece (lens and indicator lamp)**

indicator lamps for socket type SRZ / SDK / SDY / SFK



<b>GEV No.</b>	359130	<b>Ref. No.</b>	010426 0216006
<b>description</b>	indicator lamp 230V clear connection male faston 6.3mm $\varnothing$ 8mm		

**indicator lights (complete)**

$\varnothing$  6mm



<b>GEV No.</b>	359031	<b>Ref. No.</b>	0216022
<b>description</b>	indicator light $\varnothing$ 6mm 230V green		

$\varnothing$  9mm



<b>GEV No.</b>	359137	<b>Ref. No.</b>	021784
<b>description</b>	indicator light $\varnothing$ 9mm 230V yellow connection male faston 6.3mm temp.-resist. 120°C with lens		

$\varnothing$  10mm

with screw socket



<b>GEV No.</b>	359870	<b>Ref. No.</b>	A0ND022
<b>description</b>	indicator light $\varnothing$ 10mm 230V green connection male faston 4.8mm socket screw base		
<b>For models:</b>	A190141, A190161		





<b>GEV No.</b>	359872	<b>Ref. No.</b>	01143569
<b>description</b>	indicator light $\varnothing$ 10mm 230V red connection male faston 4.8mm socket screw base		

			
1			
<b>GEV No.</b>	359871	<b>Ref. No.</b>	A040380
<b>description</b>	indicator light ø 10mm 230V yellow connection male faston 4.8mm socket screw base		

with plug-in socket

			
1			
<b>GEV No.</b>	359139	<b>Ref. No.</b>	0216019
<b>description</b>	indicator light ø 10mm green 230V connection male faston 6.3mm Qty 1 pcs		

			
1			
<b>GEV No.</b>	359140	<b>Ref. No.</b>	0216018
<b>description</b>	indicator light ø 10mm yellow 230V connection male faston 6.3mm Qty 1 pcs		

			
1			
<b>GEV No.</b>	359315	<b>Ref. No.</b>	A010403
<b>description</b>	indicator light ø 10mm 230V green cable length 250mm		

ø12mm

with plug-in socket

			
1			
<b>GEV No.</b>	359846	<b>Ref. No.</b>	01044466 A039883 EB-600-09
<b>description</b>	indicator light ø 12mm green 230V connection male faston 6.3mm Sinus		
<b>For models:</b>	104447, 151510, A120788, A150107, A150207, A150671, A150674, A203094, EB600		

			
1			
<b>GEV No.</b>	360509	<b>Ref. No.</b>	016240441 A039887 EB-600-06
<b>description</b>	indicator light ø 12mm yellow 230V connection male faston 6.3mm thermometer		
<b>For models:</b>	151510, A150107, A150207, A150671, A150674, EB600		



			
1			
<b>GEV No.</b>	359571	<b>Ref. No.</b>	010578014
<b>description</b>	indicator light ø 13mm green 230V connection male faston 6.3mm steaming		
<b>For models:</b>	105780		

			
1			
<b>GEV No.</b>	359570	<b>Ref. No.</b>	010578012
<b>description</b>	indicator light ø 13mm green 230V connection male faston 6.3mm temperature		
<b>For models:</b>	105780		

			
1			
<b>GEV No.</b>	359572	<b>Ref. No.</b>	010578015
<b>description</b>	indicator light ø 13mm green 230V connection male faston 6.3mm timer		
<b>For models:</b>	105780		

ø13mm

with screw socket

			
1			
<b>GEV No.</b>	359146	<b>Ref. No.</b>	06540106
<b>description</b>	indicator light ø 13mm 230V yellow		
<b>accessories for</b>	359146		
	<b>GEV No.</b>	510302	<b>Ref. No.</b> —
	O-ring EPDM ID ø 12.42mm thickness 1.78mm Qty 1 pcs		
	<b>GEV No.</b>	511505	<b>Ref. No.</b> —
	O-ring EPDM thickness 1.78mm ID ø 12.42mm Qty 10 pcs		

with plug-in socket

			
1			
<b>GEV No.</b>	357010	<b>Ref. No.</b>	OAT93615 A0AT93615
<b>description</b>	indicator light ø 13mm green clock		
<b>For models:</b>	A1515001		



screw-on/push-on fit

light bulbs

for ovens



1

<b>GEV No.</b>	359610	<b>Ref. No.</b>	014034 A0YXD1A4A10
<b>description</b>	light bulb t.max. 300°C socket E14 15W 230V ø 22mm L 47mm lens L 20mm for oven lamp type Philips		
<b>For models:</b>	105780, A120788		

halogen lamp

for socket G4 / G6.35 / G9



1

<b>GEV No.</b>	359946	<b>Ref. No.</b>	A01140014
<b>description</b>	halogen lamp socket G9 230V 40W temp.-resist. 300°C		
<b>For models:</b>	A114001		

fluorescent lamps

accessories

sockets



1

<b>GEV No.</b>	359662	<b>Ref. No.</b>	030008413
<b>description</b>	lamp socket for fluorescent lamps		

oven lamps

universal oven lamps

mounting diameter 35.5mm



1

<b>GEV No.</b>	359718	<b>Ref. No.</b>	030003005+030008380 A0YXD1A4A12
<b>description</b>	oven lamp mounting ø 35.5mm 230V 15W socket E14 temp.-resist. 300°C connection male faston 6.3mm hard glas		
<b>For models:</b>	105780, A120788		
<b>spare parts for</b>	359718		
	<b>GEV No.</b>	359701	<b>Ref. No.</b> —
	lamp socket socket E14 220-230V mounting ø 35.5mm connection male faston 6.3mm 15W		

<b>spare parts for</b>	359718		
	<b>GEV No.</b>	359740	<b>Ref. No.</b> —
	light bulb t.max. 300°C socket E14 15W 230V ø 22mm L 48mm lens L 20mm for oven lamp IMPORT		

lamps

light bulbs



1

<b>GEV No.</b>	359610	<b>Ref. No.</b>	014034 A0YXD1A4A10
<b>description</b>	light bulb t.max. 300°C socket E14 15W 230V ø 22mm L 47mm lens L 20mm for oven lamp type Philips		
<b>For models:</b>	105780, A120788		

halogen lamps

for socket G4 / G6.35 / G9



1

<b>GEV No.</b>	359946	<b>Ref. No.</b>	A01140014
<b>description</b>	halogen lamp socket G9 230V 40W temp.-resist. 300°C		
<b>For models:</b>	A114001		

sockets

G9



1

<b>GEV No.</b>	359742	<b>Ref. No.</b>	0200201013
<b>description</b>	lamp socket L 36mm mounting distance 28mm		
<b>For models:</b>	A114001		





## timers

## programme timers

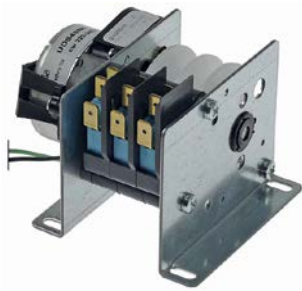

1

<b>GEV No.</b>	360726	<b>Ref. No.</b>	OINV013 OINVER230
<b>description</b>	programme timer Guaitani R3/3 engines 1 chambers 3 operation time 6min 220/240V 50/60Hz shaft $\varnothing$ 6x6mm shaft L 44mm manuf. no. R3/3 motor type UDS40NE1RNZ165		
<b>spare parts for</b>	360726		
	<b>GEV No.</b>	360673	<b>Ref. No.</b> —
	motor kit pinion $\varnothing$ 6.8mm teeth 15 230V voltage AC 50/60Hz turn direction clockwise motor $\varnothing$ 48mm H 18.5mm motor type UDS-40NE1RNZ165 cable length 150mm with holder		



1

<b>GEV No.</b>	400740	<b>Ref. No.</b>	A017610
<b>description</b>	timer		



1

<b>GEV No.</b>	360005	<b>Ref. No.</b>	012268 0238052
<b>description</b>	timer BIGATTI D94 engines 1 chambers 1 operation time 20min 230V shaft $\varnothing$ mm shaft Lmm manuf. no. WE006 motor type 82354021L		



1

<b>GEV No.</b>	360349	<b>Ref. No.</b>	018202 0238053
<b>description</b>	timer CDC 11803 engines 1 chambers 3 operation time 150s 230V shaft $\varnothing$ mm shaft Lmm manuf. no. 11803F1BEE000.0010 motor type M48R ATS type 11803F1 / 238046		
<b>spare parts for</b>	360349		
	<b>GEV No.</b>	360673	<b>Ref. No.</b> —
	motor kit pinion $\varnothing$ 6.8mm teeth 15 230V voltage AC 50/60Hz turn direction clockwise motor $\varnothing$ 48mm H 18.5mm motor type UDS-40NE1RNZ165 cable length 150mm with holder		



1

<b>GEV No.</b>	360413	<b>Ref. No.</b>	010578024
<b>description</b>	timer FIBER P19 engines 1 chambers 2 operation time 4min 230V 50Hz shaft $\varnothing$ mm shaft Lmm		
<b>For models:</b>	105780		



1

<b>GEV No.</b>	360152	<b>Ref. No.</b>	A010701
<b>description</b>	timer with permanent position 2-pole NO for B1 operation time 120min		

## electric timers



1

<b>GEV No.</b>	350194	<b>Ref. No.</b>	OTIM000 OTIM060
<b>description</b>	timer MS65 with bell operation time 60min time spreadmin 2NO at 250V 16A permanent position yes impulse electric shaft $\varnothing$ 6x4.6mm shaft L 23mm mounting distance 29mm mounting thread M4 connection male faston 6.3mm Invensys 230V voltage AC 2-pole		



mechanical timers

			
1			
<b>GEV No.</b>	360470	<b>Ref. No.</b>	010578022
<b>description</b>	timer C53 2-pole operation time 120min impulse mechanical 1NO/1NC at 250V 16A permanent position yes shaft ø 6x4.6mm shaft 6x4.6mm shaft L 23mm mounting distance 28mm		
<b>For models:</b>	105780		

			
1			
<b>GEV No.</b>	360475	<b>Ref. No.</b>	A0YXD1A4A06
<b>description</b>	timer M11 with bell 1-pole operation time 120min impulse mechanical 1NO at 250V 16A permanent position no shaft ø 6x4.6mm shaft 6x4.6mm shaft L 21mm mounting distance 28mm		
<b>For models:</b>	A120788		

			
1			
<b>GEV No.</b>	360545 <sup>1</sup>	<b>Ref. No.</b>	A040900
<b>description</b>	timer M11 with bell 1-pole operation time 15min 1NO at 250V 16A permanent position no shaft ø 6mm shaft 6mm shaft L 15mm mounting distance 28mm connection male faston 6.3mm with knob		
<b>accessories for</b>	360545		
	<b>GEV No.</b>	112624	<b>Ref. No.</b> A040898
	knob time 15min t.max.°C ø 41mm shaft ø 6mm shaft flat black rosette ø 58mm		

<sup>1</sup>incl. knob

			
1			
<b>GEV No.</b>	360544	<b>Ref. No.</b>	A040897
<b>description</b>	timer M11 with bell 1-pole operation time 15min impulse mechanical 1NO at 250V 16A permanent position no shaft ø 6mm shaft 6x4.6mm shaft L 15mm mounting distance 24mm mounting thread M3 connection male faston 6.3mm		
<b>For models:</b>	A151300, A151600		

			
1			
<b>GEV No.</b>	350182	<b>Ref. No.</b>	0AT93623 A0AT93623
<b>description</b>	timer M11 with bell 1-pole operation time 15min impulse mechanical 1NO at 250V 16A permanent position no shaft ø 6x4.6mm shaft 6x4.6mm shaft L 15mm mounting distance 28mm		
<b>For models:</b>	A151300, A1515001, A151600		

			
1			
<b>GEV No.</b>	360476	<b>Ref. No.</b>	01207908 A040897 (old version)
<b>description</b>	timer M11 with bell 2-pole operation time 15min 2NO at 250V 16A shaft ø 6mm shaft L 15mm connection male faston 6.3mm		

			
1			
<b>GEV No.</b>	360510 <sup>1</sup>	<b>Ref. No.</b>	A040895
<b>description</b>	timer M11 with bell 2-pole operation time 15min 2NO at 250V 16A shaft ø 6mm shaft L 15mm connection male faston 6.3mm with knob		
<b>spare parts for</b>	360510		
	<b>GEV No.</b>	112624	<b>Ref. No.</b> A040898
	knob time 15min t.max.°C ø 41mm shaft ø 6mm shaft flat black rosette ø 58mm		
	<b>GEV No.</b>	360476	<b>Ref. No.</b> 01207908 A040897 (old version)
	timer M11 with bell 2-pole operation time 15min 2NO at 250V 16A shaft ø 6mm shaft L 15mm connection male faston 6.3mm		

<sup>1</sup>incl. knob



### contactors

#### GENERAL ELECTRIC (AEG)

##### power contactors



1

<b>GEV No.</b>	380244	<b>Ref. No.</b>	040100023
<b>description</b>	power contactor resistive load 25A 230VAC (AC3/400V) 9A/4kW main contacts 3NO auxiliary contacts 1NO connection screw connection type AEG LS4K 10A type GE CL00A 310		



1

<b>GEV No.</b>	380264	<b>Ref. No.</b>	017594
<b>description</b>	power contactor resistive load 45A 230VAC (AC3/400V) 25A/11kW main contacts 3NO auxiliary contacts connection screw connection type AEG LS11K 00A type GE CL25A 300		

#### SIEMENS

##### power contactors



1

<b>GEV No.</b>	380389	<b>Ref. No.</b>	0229037
<b>description</b>	power contactor resistive load 22A 230VAC (AC3/400V) 9A/4kW main contacts 3NO auxiliary contacts 1NO connection screw connection type 3RT10-16-1AP01		



1

<b>GEV No.</b>	380957	<b>Ref. No.</b>	0927051
<b>description</b>	power contactor resistive load 22A 24VAC (AC3/400V) 12A/5.5kW main contacts 3NO auxiliary contacts 1NO connection screw connection type 3RT10-17-1AB01 50/60Hz		

#### miscellaneous

##### power contactors



1

<b>GEV No.</b>	380915	<b>Ref. No.</b>	010578021
<b>description</b>	power contactor 230V resistive load 32A main contacts 3NO auxiliary contacts 1NO connection screw type CJX2-1810 SHAPU		
<b>For models:</b>	105780		

### relays

#### power relays

##### with bracket mounting



1

<b>GEV No.</b>	380312	<b>Ref. No.</b>	0229023 0229024
<b>description</b>	power relays FINDER 230VAC 10A 3CO connection male faston 4.8mm bracket mounting dimensions 52x32.2x36.5mm manuf. no. 60.63.8.230.0000		

1

<b>GEV No.</b>	380139	<b>Ref. No.</b>	0926021
<b>description</b>	power relays FINDER 230VAC 16A 2CO connection F6.3 bracket mounting dimensions 68x38.2x35.8mm manuf. no. 62.82.8.230.0000		



1

<b>GEV No.</b>	380403	<b>Ref. No.</b>	0229036
<b>description</b>	power relays FINDER 230VAC 16A 3CO connection F6.3 bracket mounting manuf. no. 62.83.8.230.0500		



1

<b>GEV No.</b>	380185	<b>Ref. No.</b>	020473
<b>description</b>	power relays Italiana Relè 230VAC 30A 1NO connection F6.3 bracket mounting dimensions 36.5x32.2x51.8mm manuf. no. A10-230AC-FA		

**magnetrons**



1

<b>GEV No.</b>	403173	<b>Ref. No.</b>	0610181C08
<b>description</b>	Magnetron type 2M248(JT)		

**probes**

producer-specific probes

probes



1

<b>GEV No.</b>	379887	<b>Ref. No.</b>	0SON006
<b>description</b>	temperature probe Pt100 cable high temperature film probe -50 up to +200°C cable -50 up to +200°C connection 2-wire thread M10x1.5 probe ø5x42mm cable length 1.9m		

core probes



1

<b>GEV No.</b>	379886	<b>Ref. No.</b>	0SON000
<b>description</b>	core temperature probe Pt100 cable PTFE probe -40 up to +250°C cable -40 up to +250°C connection 2-wire probe ø4x100mm thread M10x1.5 cable length 3m handle ø 15mm handle length 90mm		

**electronics**

PCBs



1

<b>GEV No.</b>	402961	<b>Ref. No.</b>	01059331M
<b>description</b>	control PCB for induction device GIC2030 L 242mm W 69mm with digital display buttons 6		



1

<b>GEV No.</b>	403324	<b>Ref. No.</b>	01059353M
<b>description</b>	control PCB for induction device GIC2035 L 257mm W 75mm edition until 06/2010 buttons 6		



1

<b>GEV No.</b>	402962	<b>Ref. No.</b>	01059353M2
<b>description</b>	control PCB induction device GIC2035 L 257mm W 75mm edition since 06/2010 buttons 6		

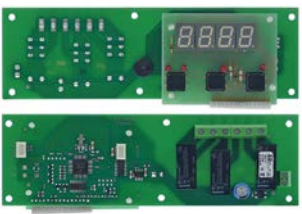

1

<b>GEV No.</b>	400736	<b>Ref. No.</b>	06010083
<b>description</b>	control PCB salamander grill SH50SR		

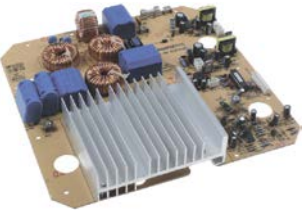

1

<b>GEV No.</b>	402960	<b>Ref. No.</b>	01059332M
<b>description</b>	main PCB for induction device GIC2030 L 237mm W 231mm		



1

<b>GEV No.</b>	403325	<b>Ref. No.</b>	010583510M
<b>description</b>	main PCB for induction device GIC2035 L 236mm W 230mm until 06/2010		

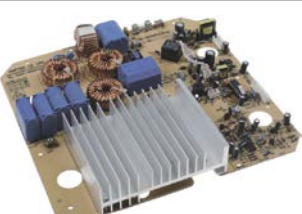

1

<b>GEV No.</b>	402959	<b>Ref. No.</b>	010583510M2
<b>description</b>	main PCB induction device GIC2035 L 236mm W 230mm since 06/2010		





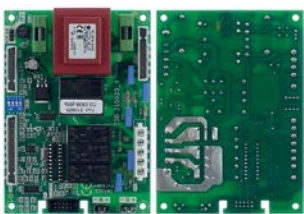

1

<b>GEV No.</b>	402045	<b>Ref. No.</b>	SA3600
<b>description</b>	PCB hand blenders FM3 with potentiometer 230V		



1

<b>GEV No.</b>	400899	<b>Ref. No.</b>	0215018	
<b>description</b>	power PCB dishwasher LP10/20/30 without EPROM			
<b>accessories for</b>	400899			
	<b>GEV No.</b>	400761	<b>Ref. No.</b>	—
	plug connector 5-pole			
	<b>GEV No.</b>	400900	<b>Ref. No.</b>	—
	EPROM CODE 225029-3			
	<b>GEV No.</b>	401558	<b>Ref. No.</b>	—
	EPROM CODE 81000-1			
	<b>GEV No.</b>	403241	<b>Ref. No.</b>	—
	EPROM type U61E for dishwasher CODE 81001-3			
	<b>GEV No.</b>	550048	<b>Ref. No.</b>	—
	female bullet			

## keypads

### front foils



1

<b>GEV No.</b>	400689	<b>Ref. No.</b>	A016769
<b>description</b>	keypad foil		



1

<b>GEV No.</b>	403791	<b>Ref. No.</b>	02012427 02016790
<b>description</b>	keypad foil for salamander grill model suitable for BARTSCHER ømm for mounting pos. suitable for for model L 547mm W 67mm		









## solenoid valves

### solenoid valves (water)

TP			
			
1			
<b>GEV No.</b>	370111	<b>Ref. No.</b>	0927001
<b>description</b>	solenoid valve double straight 24VAC inlet 3/4" outlet 11.5mm DN10 TP		
<b>spare parts for</b>	370111		
	<b>GEV No.</b>	371035	<b>Ref. No.</b> —
	solenoid coil 24VAC		
<b>accessories for</b>	370111		
	<b>GEV No.</b>	371220	<b>Ref. No.</b> —
	reducer TP flow rate 3l/min red tolerance ±15%		
	<b>GEV No.</b>	371221	<b>Ref. No.</b> —
	reducer TP flow rate 5.5l/min yellow tolerance ±15%		
	<b>GEV No.</b>	371222	<b>Ref. No.</b> —
	reducer TP flow rate 6l/min grey tolerance ±15%		
	<b>GEV No.</b>	371223	<b>Ref. No.</b> —
	reducer TP flow rate 10l/min white tolerance ±15%		
	<b>GEV No.</b>	371224	<b>Ref. No.</b> —
	reducer TP flow rate 12l/min bronze tolerance ±15%		
	<b>GEV No.</b>	371225	<b>Ref. No.</b> —
	reducer TP flow rate 16l/min light brown tolerance ±15%		
	<b>GEV No.</b>	371226	<b>Ref. No.</b> —
	reducer TP flow rate 20l/min red tolerance ±15%		
	<b>GEV No.</b>	371230	<b>Ref. No.</b> —
	reducer TP flow rate 0.25l/min red tolerance ±25%		
	<b>GEV No.</b>	371231	<b>Ref. No.</b> —
	reducer TP flow rate 0.35l/min violet tolerance ±25%		
	<b>GEV No.</b>	371232	<b>Ref. No.</b> —
	reducer TP flow rate 0.5l/min orange tolerance ±25%		
	<b>GEV No.</b>	371233	<b>Ref. No.</b> —
	reducer TP flow rate 0.8l/min white tolerance ±25%		
	<b>GEV No.</b>	371234	<b>Ref. No.</b> —
	reducer TP flow rate 1l/min light blue tolerance ±25%		
	<b>GEV No.</b>	371235	<b>Ref. No.</b> —
	reducer TP flow rate 1.2l/min brown tolerance ±25%		

accessories for 370111			
	<b>GEV No.</b>	371236	<b>Ref. No.</b> —
	reducer TP flow rate 1.5l/min light brown tolerance ±25%		
	<b>GEV No.</b>	371237	<b>Ref. No.</b> —
	reducer TP flow rate 2.5l/min yellow tolerance ±25%		
	<b>GEV No.</b>	371238	<b>Ref. No.</b> —
	reducer TP flow rate 3.4l/min dark green tolerance ±25%		
	<b>GEV No.</b>	371239	<b>Ref. No.</b> —
	reducer TP flow rate 5l/min black tolerance ±25%		
	<b>GEV No.</b>	371240	<b>Ref. No.</b> —
	reducer TP flow rate 8l/min blue tolerance ±20%		











TP			
			
1			
<b>GEV No.</b>	370017	<b>Ref. No.</b>	0240011
<b>description</b>	solenoid valve single straight 230VAC inlet 3/4" outlet 11.5mm DN10 TP p max 10bar		
<b>spare parts for</b>	370017		
	<b>GEV No.</b>	371013	<b>Ref. No.</b> —
	solenoid coil TP 230VAC 50/60Hz		
<b>accessories for</b>	370017		
	<b>GEV No.</b>	371220	<b>Ref. No.</b> —
	reducer TP flow rate 3l/min red tolerance ±15%		
	<b>GEV No.</b>	371221	<b>Ref. No.</b> —
	reducer TP flow rate 5.5l/min yellow tolerance ±15%		
	<b>GEV No.</b>	371222	<b>Ref. No.</b> —
	reducer TP flow rate 6l/min grey tolerance ±15%		
	<b>GEV No.</b>	371223	<b>Ref. No.</b> —
	reducer TP flow rate 10l/min white tolerance ±15%		
	<b>GEV No.</b>	371224	<b>Ref. No.</b> —
	reducer TP flow rate 12l/min bronze tolerance ±15%		
	<b>GEV No.</b>	371225	<b>Ref. No.</b> —
	reducer TP flow rate 16l/min light brown tolerance ±15%		
	<b>GEV No.</b>	371226	<b>Ref. No.</b> —
	reducer TP flow rate 20l/min red tolerance ±15%		
	<b>GEV No.</b>	371230	<b>Ref. No.</b> —
	reducer TP flow rate 0.25l/min red tolerance ±25%		
	<b>GEV No.</b>	371231	<b>Ref. No.</b> —
	reducer TP flow rate 0.35l/min violet tolerance ±25%		

Table continues overleaf

1 electric components



accessories for		370017	
	GEV No.	371232	Ref. No. —
reducer TP flow rate 0.5l/min orange tolerance ±25%			
	GEV No.	371233	Ref. No. —
reducer TP flow rate 0.8l/min white tolerance ±25%			
	GEV No.	371234	Ref. No. —
reducer TP flow rate 1l/min light blue tolerance ±25%			
	GEV No.	371235	Ref. No. —
reducer TP flow rate 1.2l/min brown tolerance ±25%			
	GEV No.	371236	Ref. No. —
reducer TP flow rate 1.5l/min light brown tolerance ±25%			
	GEV No.	371237	Ref. No. —
reducer TP flow rate 2.5l/min yellow tolerance ±25%			
	GEV No.	371238	Ref. No. —
reducer TP flow rate 3.4l/min dark green tolerance ±25%			
	GEV No.	371239	Ref. No. —
reducer TP flow rate 5l/min black tolerance ±25%			
	GEV No.	371240	Ref. No. —
reducer TP flow rate 8l/min blue tolerance ±20%			

## solenoid valves with reducers



1

GEV No.	370628	Ref. No.	017696
description	solenoid valve double straight 230VAC inlet 3/4" input 16l/min DN10 TP plastic outlet 11.5mm		

## various



1

GEV No.	370589	Ref. No.	A0YXD4A39
description	solenoid valve single straight inlet 3/4" ET outlet 11.5mm male faston 6.3mm		
For models:	105780, A120788		

## pressure switches

## for warewashing

ø 58mm with male faston 6.3mm

with connection horizontal



1

GEV No.	541002	Ref. No.	0224002
description	pressure control pressure range 110/60mbar connection 6mm ø 58mm pressure connection horizontal warewashing pressure connection ø 6mm		



1

GEV No.	541105	Ref. No.	0926049
description	pressure control pressure range 180/70mbar connection 6mm ø 58mm pressure connection horizontal warewashing		



1

GEV No.	541013	Ref. No.	0929039
description	pressure control pressure range 55/25mbar connection 6mm ø 58mm pressure connection horizontal warewashing		



1

GEV No.	541003	Ref. No.	011515 011595 0224003
description	pressure control pressure range 55/35mbar connection 6mm ø 58mm pressure connection horizontal warewashing pressure connection ø 6mm		



## compressors

### ACC/ZEL

R600A

LBP monophase

Lower evaporation temperature below -20°C



1

<b>GEV No.</b>	605150	<b>Ref. No.</b>	038281
<b>description</b>	compressor coolant R600a type HVM10AA 220-240V 50Hz LBP 8.7kg 1/6HP cylinder capacity 10cm <sup>3</sup> RSIR H 180mmWWWWWWWWW		

## fans

### axial fans

import



1

<b>GEV No.</b>	601743	<b>Ref. No.</b>	01058355
<b>description</b>	axial fan L 80mm W 80mm H 25mm 18VDC 1.8W connection coded plug cable length 300mm		

## refrigeration fans

cooling motors (complete)



1

<b>GEV No.</b>	601145	<b>Ref. No.</b>	030609
<b>description</b>	fan 230V 10W		

cold air circulating fans (other)



1

<b>GEV No.</b>	602132	<b>Ref. No.</b>	038169
<b>description</b>	fan motor 220-240V 50Hz IN 22W / OUT 5W shaft ø 4mm shaft L 20/48mm L 65mm W 66mm H 73mm fan wheel ø 150mm Qty 1 pcs		
<b>For models:</b>	700158G-McDonalds		

## cross flow fans

COPREL

with standard coil



1

<b>GEV No.</b>	601453	<b>Ref. No.</b>	030008386	
<b>description</b>	cross flow fan TFR 180 roller ø 60mm roller length 180mm laminated core thickness 16mm motor position right 230V/50-60Hz 17W universal bearing silicone connection male faston 6.3mm airflow 100m <sup>3</sup> /h -30 up to +100°C 230V 50Hz			
<b>accessories for</b>	601453			
	<b>GEV No.</b>	415114	<b>Ref. No.</b>	—
	heater battery mounting distance 185mm W 40mm H 35mm 2000W 230V temperature restriction 105°C heating circuits 2 connection cable cable length 150mm L 192mm for cross flow fan			

→ electric components



hot air motors



1

<b>GEV No.</b>	601993	<b>Ref. No.</b>	0MOT001
<b>description</b>	fan motor 230V 1 phase 50Hz 0.18/0.12kW 2800rpm speeds 1 L1 85mm L2 65mm L3 23mm D1 ø 8mm D2 ø 6mm M5x0.8 0.8A suitable capacitor 5µF/450V		
<b>accessories for</b>	601993		
	GEV No.	365017	Ref. No. —
	operating capacitor capacity 5µF 450V tolerance 5% 50/60Hz ambient temperature max. -25 to +85°C ø 28mm L 54mm M8 plastic connection male faston 6.3mm 16.10.08 protection		



1

<b>GEV No.</b>	601690	<b>Ref. No.</b>	010578043
<b>description</b>	fan motor 230V 50Hz 0.09kW 2450rpm L1 80mm L2 20mm L3 35mm L4 20mm D1 ø 12mm D2 ø 8x6mm M5		
<b>For models:</b>	105780		



1

<b>GEV No.</b>	601688	<b>Ref. No.</b>	010578050
<b>description</b>	fan wheel D1 ø 200mm H1 43mm blades 39 D2 ø 8x6mm D3 ø 8mm H2 29mm		
<b>For models:</b>	105780		

hot air fans

miscellaneous

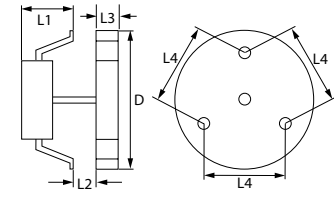

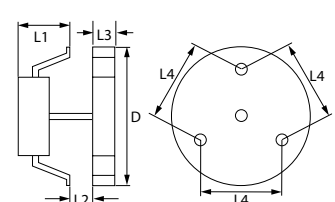

1

<b>GEV No.</b>	601124	<b>Ref. No.</b>	009G623
<b>description</b>	hot air fan 220-240V 30W L1 60mm L2 12mm L3 25mm L4 84mm fan wheel ø 150mm IMS type VRB150H2028		



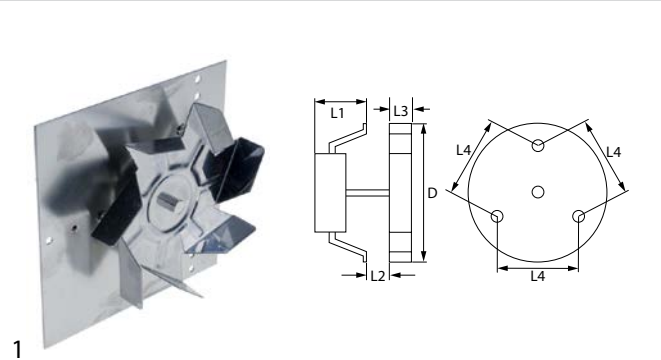

1

<b>GEV No.</b>	601054	<b>Ref. No.</b>	023117700
<b>description</b>	hot air fan 220-240V 32W 50/60Hz L1 60mm L2 10mm L3 25mm L4 87mm fan wheel ø 150mm FIME type C20X0E01/46		
<b>spare parts for</b>	601054		
	GEV No.	601441	Ref. No. —
	fan wheel ø 150mm W 25mm shaft intake ø 6x5mm stainless steel blades 7		
<b>accessories for</b>	601054		
	GEV No.	550879	Ref. No. —
	insulation ø 130mm thickness 3mm hole ø 20mm for hot air fan		



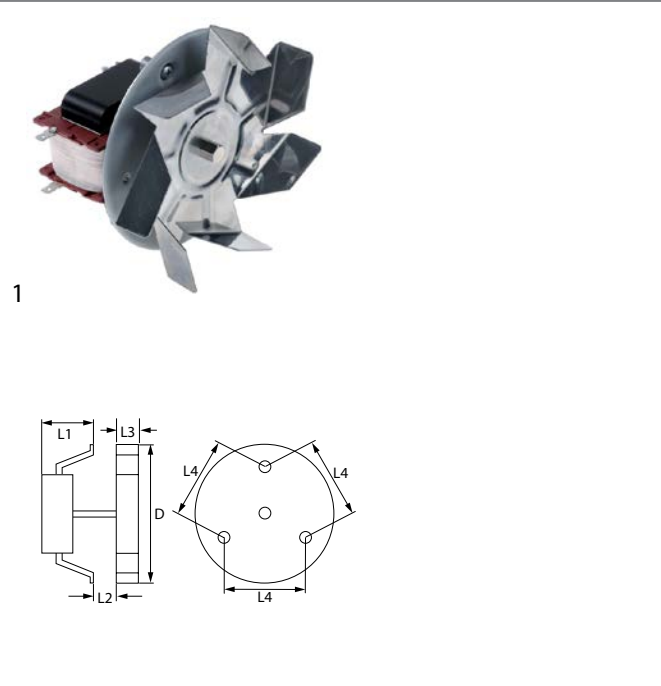

1

<b>GEV No.</b>	601548	<b>Ref. No.</b>	A0000103006
<b>description</b>	hot air fan 220-240V 40W 50/60Hz L1 65mm L2 11mm L3 25mm L4 87mm fan wheel ø 150mm FIME type C25R8023CLH		
<b>accessories for</b>	601548		
	<b>GEV No.</b>	601441	<b>Ref. No.</b> —
	fan wheel ø 150mm W 25mm shaft intake ø 6x5mm stainless steel blades 7		



1

<b>GEV No.</b>	601125	<b>Ref. No.</b>	0A036410
<b>description</b>	hot air fan 220-240V 45W 50/60Hz L1 70mm L2 11mm L3 25mm L4 87mm fan wheel ø 150mm FIME type C30R0479CLF		
<b>For models:</b>	A120788		
<b>accessories for</b>	601125		
	<b>GEV No.</b>	550879	<b>Ref. No.</b> —
	insulation ø 130mm thickness 3mm hole ø 20mm for hot air fan		

## motors

### gear motors

#### for conveyor toaster

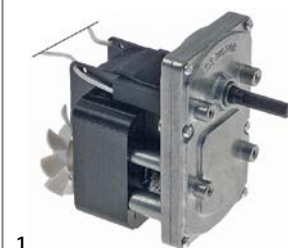

1

<b>GEV No.</b>	602131	<b>Ref. No.</b>	A01002057 QXYH6030M23G
<b>description</b>	gear motor W 230V voltage AC 50Hz 1 phaserpm shaft ø 7mm L 92mm W 60mm H 96mm		

#### for ice-cube maker

#### for paddles



1

<b>GEV No.</b>	501535	<b>Ref. No.</b>	010402530
<b>description</b>	gear motor type 50KTYZ 6W 220-240V 50/60Hz 33/40rpm shaft ø 7mm		





# pumps

## wash and rinse pumps

### LGB



1

<b>GEV No.</b>	500156	<b>Ref. No.</b>	0130109
<b>description</b>	pump inlet ø 50mm outlet ø 50mm type ZF400SX 230V 50Hz 1 phase 0.6kW 0.8HP L 210mm rotation direction right capacitor 16µF LGB		
<b>spare parts for</b>	500156		
	<b>GEV No.</b>	509020	<b>Ref. No.</b> —
	impellor ø 104mm H 25mm M8L		
	<b>GEV No.</b>	510703	<b>Ref. No.</b> —
	mechanical shaft seal for shaft ø 13mm slide ring H 13mm height counter ring 5.5mm ED ø 26mm		
	<b>GEV No.</b>	521548	<b>Ref. No.</b> —
	pump cover LGB inlet ø 50mm outlet ø 50mm		
	<b>GEV No.</b>	521734	<b>Ref. No.</b> —
	pump cover bottom part		
	<b>GEV No.</b>	523509	<b>Ref. No.</b> —
	deep-groove ball bearing type 6201-2RS shaft ø 12mm ED ø 32mm W 10mm with sealing discs deep-groove ball bearing DIN 625-1		
	<b>GEV No.</b>	532623	<b>Ref. No.</b> —
	O-ring EPDM thickness 2.62mm ID ø 120.32mm Qty 1 pcs		
<b>accessories for</b>	500156		
	<b>GEV No.</b>	365021	<b>Ref. No.</b> 0206004
	operating capacitor capacity 16µF 425V tolerance 5% 50/60Hz ambient temperature max. -25 to +85°C ø 35mm L 73mm single M8 plastic connection male faston 6.3mm 416.10.99 protection		

### OLYMPIA

### pumps



1

<b>GEV No.</b>	500003	<b>Ref. No.</b>	020727
<b>description</b>	pump inlet ø 45mm outlet ø 32mm type T30 230V 50Hz 1 phase 0.29kW 0.39HP L 190mm rotation direction right capacitor 8µF OLYMPIA		
<b>spare parts for</b>	500003		
	<b>GEV No.</b>	365013	<b>Ref. No.</b> —
	operating capacitor capacity 8µF 400V tolerance 5%Hz ambient temperature max. -25 to +85°C ø 31.5mm L 55mm M8 plastic connection male faston 6.3mm protection		
	<b>GEV No.</b>	510512	<b>Ref. No.</b> 023317
	pump cover OLYMPIA inlet ø 45mm outlet ø 31mm outlet 2 ø 24 turn direction right ø 130mm ID ø 124mm inner height 20mm		
	<b>GEV No.</b>	510554	<b>Ref. No.</b> —
	O-ring EPDM thickness 2mm ID ø 120mm Qty 1 pcs		
	<b>GEV No.</b>	510615	<b>Ref. No.</b> 012263
	impellor ø 90mm H 22mm rotation direction right thread M10L blades 4		
	<b>GEV No.</b>	510693	<b>Ref. No.</b> 0141002 021188
	mechanical shaft seal for shaft ø 12mm slide ring ext. ø 24mm slide ring H 15.5mm slide ring int. ø 11mm counter ring mounting ø 24mm height counter ring 8mm counter ring int. ø 13.5mm		



1

<b>GEV No.</b>	500525	<b>Ref. No.</b>	0150914
<b>description</b>	pump inlet ø 50mm outlet ø 30mm type T7 230V 50Hz 1 phase 0.52kW 0.71HP L 230mm rotation direction right capacitor 12.5µF OLYMPIA		
<b>spare parts for</b>	500525		
	<b>GEV No.</b>	365014	<b>Ref. No.</b> —
	operating capacitor capacity 12.5µF 450V tolerance 5%Hz ambient temperature max. -25 to +85°C ø 35mm L 70mm M8 plastic connection male faston 6.3mm 45S.C3DS.12.5 protection		
	<b>GEV No.</b>	510554	<b>Ref. No.</b> —
	O-ring EPDM thickness 2mm ID ø 120mm Qty 1 pcs		
	<b>GEV No.</b>	510693	<b>Ref. No.</b> 0141002 021188
	mechanical shaft seal for shaft ø 12mm slide ring ext. ø 24mm slide ring H 15.5mm slide ring int. ø 11mm counter ring mounting ø 24mm height counter ring 8mm counter ring int. ø 13.5mm		
	<b>GEV No.</b>	517368	<b>Ref. No.</b> —
	impellor ø 102mm H 21mm rotation direction right thread M10L suitable for Dihr blades 8		
	<b>GEV No.</b>	521556	<b>Ref. No.</b> —
	pump cover OLYMPIA inlet ø 50mm outlet ø 30mm outlet 2 ø 30 auxiliary pressure connection 10mm supporting pressure open turn direction right ø 130mm ID ø 124mm inner height 20mm		

drain pumps

ASKOLL



1

<b>GEV No.</b>	500214	<b>Ref. No.</b>	0130105 0130146
<b>description</b>	drain pump inlet ø 30mm outlet ø 22mm 230/240V 30W 50Hz ASKOLL type R113		

condensators & interference suppression filters

operating capacitors

plastic



1

<b>GEV No.</b>	365021	<b>Ref. No.</b>	0206004
<b>description</b>	operating capacitor capacity 16µF 425V tolerance 5% 50/60Hz ambient temperature max. -25 to +85°C ø 35mm L 73mm single M8 plastic connection male faston 6.3mm 416.10.99 protection		



1

<b>GEV No.</b>	365019	<b>Ref. No.</b>	0206005
<b>description</b>	operating capacitor capacity 20µF 400V tolerance 5% 50/60Hz ambient temperature max. -25 to +85°C ø 39.5mm L 70mm M8 plastic connection male faston 6.3mm 16.10.25. protection		



1

<b>GEV No.</b>	365028	<b>Ref. No.</b>	010578025
<b>description</b>	operating capacitor capacity 3µF 450V tolerance 5% 50/60Hz ambient temperature max. -25 to +85°C ø 35.5mm L 75mm M8 plastic connection male faston 6.3mm protection		
<b>For models:</b>	105780		

filters

interference suppression filters



1

<b>GEV No.</b>	365044	<b>Ref. No.</b>	0926144
<b>description</b>	interference suppression filter type FC701Y2F 250V 50-60Hz conductor 2 with E connection cable 200mm L 42mm ø 23mm Hmm Wmm plastic Qty 1 pcs		



## fuses

### fine fuses

			
1			
<b>GEV No.</b>	358533	<b>Ref. No.</b>	01143561
<b>description</b>	fine fuse size ø5x20mm 6.3A fast-acting rated 250V Qty 10 pcs		

## electric accessories

### terminals

#### terminal blocks

			
1			
<b>GEV No.</b>	693220	<b>Ref. No.</b>	030008125
<b>description</b>	lustre terminal 12-pole cross section 4mm <sup>2</sup> max. 32A max 750V temp.-resist. 150°C		

#### connection terminals with screw/faston connections

			
1			
<b>GEV No.</b>	550411	<b>Ref. No.</b>	0220011
<b>description</b>	power terminal block 6-pole max. 40A max 450V connection ø6mm <sup>2</sup> / F6.3 temp.-resist. 150°C cross section 6mm <sup>2</sup>		

#### connection terminals with screw connection

			
1			
<b>GEV No.</b>	551109	<b>Ref. No.</b>	A01506752
<b>description</b>	connecting cable 4-pole max. 15A max 500V connection screw temp.-resist. 150°C		
<b>For models:</b>	A150671, A150674		

			
1			
<b>GEV No.</b>	551021	<b>Ref. No.</b>	OAT93621 A0AT93621
<b>description</b>	porcelain terminal block 3-pole max. 15A max 500V connection screw temp.-resist. 150°C with fastening angle t.max. 150°C Qty 1 pcs		
<b>For models:</b>	151510, A151300, A1515001, A151600		

## gas taps

### PEL

#### 22S/O series











				
1				
<b>GEV No.</b>	101086	<b>Ref. No.</b>	010909	
<b>description</b>	gas tap PEL type 22S/O gas inlet M20x1.5 (tube ø 12mm) bypass nozzle ø 0.35mm gas outlet M20x1.5 (tube ø 12/10mm) thermocouple connection M9x1 pilot connection M10x1 shaft ø 10x8mm shaft L 25/17mm shaft flat lower			
<b>spare parts for</b>	101086			
	<b>GEV No.</b>	100259	<b>Ref. No.</b>	—
	bypass nozzle type PEL22 bore ø 0.35mm thread M6x0.5			
	<b>GEV No.</b>	101058	<b>Ref. No.</b>	—
	magnet unit L 39mm D1 ø 15.4mm D2 ø 13.5mm suitable for PEL22/EGA24197 standard			
	<b>GEV No.</b>	101201	<b>Ref. No.</b>	—
	gas tap front part shaft ø 10x8mm shaft L 25/17mm shaft flat upper/lower suitable for PEL22			
	<b>GEV No.</b>	101231	<b>Ref. No.</b>	—
	thermocouple nut T1: M9x1 T2: M18x1			
	<b>GEV No.</b>	101240	<b>Ref. No.</b>	—
	gas connection thread M20x1.5 tube ø 12/10mm for PEL gas taps with gasket and screws horizontal			
	<b>GEV No.</b>	101460	<b>Ref. No.</b>	—
	O-ring ø 12.37mm D1 ø 2.62mm suitable for PEL22			
	<b>GEV No.</b>	101461	<b>Ref. No.</b>	—
	screw kit suitable for PEL22 Qty 4 pcs			
<b>accessories for</b>	101086			
	<b>GEV No.</b>	100908	<b>Ref. No.</b>	—
	union screw thread M10x1 for pipe ø 4mm Qty 1 pcs			
	<b>GEV No.</b>	100909	<b>Ref. No.</b>	—
	union screw thread M10x1 for pipe ø 6mm Qty 1 pcs			
	<b>GEV No.</b>	101241	<b>Ref. No.</b>	—
	gas connection thread M20x1.5 tube ø 12/10mm for PEL gas taps vertical			

Table continues overleaf



accessories for		101086		
GEV No.		101246	Ref. No.	—
	olive for pipe ø 4mm Qty 1 pcs			
	olive for pipe ø 12mm Qty 1 pcs suitable for PEL			
	olive for pipe ø 10mm Qty 1 pcs			
	union nut thread M20x1.5 for pipe ø 10mm			
	union nut thread M20x1.5 for pipe ø 12mm			
	olive ID ø 6mm Qty 1 pcs			
	knob ø 70mm shaft ø 10x8mm shaft flat universal			
	knob dial plate silver gas tap PEL21/22/23 t.max.°C ED ø 63mm ID ø 45.5mm			

**COPRECI**

**CAL-5200**



1

GEV No.	106036	Ref. No.	010038
<b>description</b>	gas tap COPRECI type CAL-5200 gas inlet pipe flange ø21mm bypass nozzle ø 0.35mm gas outlet M14x1.5 (tube ø 6mm) thermocouple connection M8x1 pilot connection shaft ø 6x4.6mm shaft L 25/16mm shaft flat lower with pipe outlet		
<b>spare parts for</b>	106036		
	GEV No.	101060	Ref. No. —
	magnet unit standard L 39mm D1 ø 15.4mm D2 ø 11mm suitable for PEL20-21/JUNKERS/EGA		

**SABAF**



1

GEV No.	106062	Ref. No.	001G463
<b>description</b>	gas tap SABAF type 10 gas inlet pipe flange ø16mm bypass nozzle ø 0.25mm gas outlet M13x1 IT (tube ø 8mm) front fixing thermocouple connection plug-in connection shaft ø 8x6.5mm shaft L 45/12mm shaft flat lower		
<b>spare parts for</b>	106062		
	GEV No.	106723	Ref. No. —
	magnet unit L 29mm D1 ø 12.5mm D2 ø 8.5mm suitable for SABAF		
<b>accessories for</b>	106062		
	GEV No.	101277	Ref. No. —
	olive ID ø 8mm Qty 1 pcs		
	GEV No.	101376	Ref. No. —
	gasket ID ø 8mm ED ø 12mm H 3/5mm		
	GEV No.	101477	Ref. No. —
	union screw thread M13x1 tube ø 8mm Qty 1 pcs		
	GEV No.	101751	Ref. No. —
	bracket		
	GEV No.	560082	Ref. No. —
	hexagonal screw thread M4 thread L 16mm SS WS 7 Qty 20 pcs DIN 933 / ISO 4017		

**gas thermostats**

**SIT**

**630 Eurosit series**







1





GEV No.	101992	Ref. No.	035271800
<b>description</b>	gas thermostat type 630 Eurosit series t.max. 190°C 110-190°C gas inlet 3/8" gas outlet 3/8" thermocouple connection M9x1 pilot connection M10x1 probe ø 4mm probe L 202mm capillary pipe 1050mm SIT		
<b>accessories for</b>	101992		
	GEV No.	100904	Ref. No. —
	locking screw M10x1 for pipe ø 4mm Qty 1 pcs		
	GEV No.	100905	Ref. No. —
	locking screw M10x1 for pipe ø 6mm Qty 1 pcs		

Table continues overleaf



<b>accessories for</b>	101992			
	GEV No.	101273	Ref. No.	—
olive for pipe ø 12mm L 9.5mm brass Qty 1 pcs suitable for universal				
	GEV No.	101276	Ref. No.	—
union screw thread 3/8" tube ø 12mm Qty 1 pcs				
	GEV No.	101333	Ref. No.	—
plug thread 3/8" with O-ring				
	GEV No.	510655	Ref. No.	—
gasket silicone ø 7.8mm L 5mm blue Shore 55° Qty 10 pcs				



<b>GEV No.</b>	101125	<b>Ref. No.</b>	023035	
<b>description</b>	gas thermostat type 630 Eurosit series t.max. 340°C 100-340°C gas inlet 3/8" gas outlet 3/8" thermocouple connection M9x1 pilot connection M10x1 probe ø 4mm probe L 72mm capillary pipe 1050mm SIT			
<b>accessories for</b>	101125			
	GEV No.	100825	Ref. No.	—
gas tap spindle shaft ø 8x6.5mm shaft L 22/14mm suitable for EUROSIT				
	GEV No.	100904	Ref. No.	—
locking screw M10x1 for pipe ø 4mm Qty 1 pcs				
	GEV No.	100905	Ref. No.	—
locking screw M10x1 for pipe ø 6mm Qty 1 pcs				
	GEV No.	100949	Ref. No.	—
gasket suitable for 630 Eurosit series				
	GEV No.	101273	Ref. No.	—
olive for pipe ø 12mm L 9.5mm brass Qty 1 pcs suitable for universal				
	GEV No.	101276	Ref. No.	—
union screw thread 3/8" tube ø 12mm Qty 1 pcs				
	GEV No.	101333	Ref. No.	—
plug thread 3/8" with O-ring				
	GEV No.	101390	Ref. No.	—
gas tap spindle shaft ø 6x4.6mm shaft L 32/15mm gas tap with ignition flame suitable for ZANUSSI, MARENO for gas thermostat EUROSIT				
	GEV No.	101392	Ref. No.	—
adapter suitable for 630 Eurosit series				
	GEV No.	110357	Ref. No.	—
gas tap spindle shaft ø 8x6.5mm shaft L 36/12mm suitable for 630 Eurosit series				
	GEV No.	110358	Ref. No.	—
adapter shaft ø 10x8mm shaft L 29/18mm suitable for 630 Eurosit series				

710 Minisit series







<b>GEV No.</b>	101437	<b>Ref. No.</b>	010425	
<b>description</b>	gas thermostat SIT type MINISIT 710 t.max. 190°C 110-190°C gas inlet 1/2" gas outlet 3/8" thermocouple connection M9x1 pilot connection M10x1 probe ø 6mm probe L 102mm capillary pipe 1050mm probe type type A3 pressure controller yes pressure regulator 3-18mbar gland nut			
<b>spare parts for</b>	101437			
	GEV No.	101053	Ref. No.	—
magnet unit T1: M9x1 T2: M24x1 L 45mm ø 17mm suitable for Minisit				
	GEV No.	102118	Ref. No.	—
probe 110-190°C probe ø 6mm probe L 102mm capillary pipe 1050mm t.max. 190°C fryer probe type type A3 suitable for MINISIT 710				
<b>accessories for</b>	101437			
	GEV No.	100809	Ref. No.	—
O-ring EPDM thickness 2mm ID ø 21mm Qty 1 pcs				
	GEV No.	100820	Ref. No.	—
gland duct ET M14x1.5 IT M10x0.75 probe ø max. 6.5mm WS 22				
	GEV No.	100904	Ref. No.	—
locking screw M10x1 for pipe ø 4mm Qty 1 pcs				
	GEV No.	100905	Ref. No.	—
locking screw M10x1 for pipe ø 6mm Qty 1 pcs				
	GEV No.	101054	Ref. No.	—
magnet unit T1: M10x1 T2: M24x1 L 45mm ø 17mm suitable for Minisit				
	GEV No.	101136	Ref. No.	—
piezoelectric igniter suitable for Minisit with cover cap ømm connection F6.3x0.8				
	GEV No.	101137	Ref. No.	—
cover cap without piezoelectric igniter				
	GEV No.	101267	Ref. No.	—
reducer IT 3/8" ET 1/2" L 21mm				
	GEV No.	101268	Ref. No.	—
gas connection thread 3/8" angled with O-ring MINISIT 710				
	GEV No.	101269	Ref. No.	—
gas connection thread 1/2" angled with O-ring MINISIT 710				
	GEV No.	101270	Ref. No.	—
screw connection IT 3/8" ET 3/8" L 28mm				

Table continues overleaf







accessories for		101437		
	GEV No.	101272	Ref. No.	—
screw connection IT 1/2" ET 3/8" L 57mm				
	GEV No.	101273	Ref. No.	—
olive for pipe ø 12mm L 9.5mm brass Qty 1 pcs suitable for universal				
	GEV No.	101274	Ref. No.	—
olive for pipe ø 16mm Qty 1 pcs				
	GEV No.	101275	Ref. No.	—
union screw thread 1/2" for pipe ø 16mm Qty 1 pcs				
	GEV No.	101276	Ref. No.	—
union screw thread 3/8" tube ø 12mm Qty 1 pcs				
	GEV No.	110068	Ref. No.	—
knob suitable for Minisit ø 37mm				



<b>GEV No.</b>	101438	<b>Ref. No.</b>	010829
<b>description</b>	gas thermostat SIT type MINISIT 710 t.max. 340°C 100-340°C gas inlet 1/2" gas outlet 3/8" thermocouple connection M9x1 pilot connection M10x1 probe ø 5mm probe L 68mm capillary pipe 1050mm probe type type B1 pressure controller yes pressure regulator 3-18mbar gland nut		

spare parts for		101438		
	GEV No.	101053	Ref. No.	—
magnet unit T1: M9x1 T2: M24x1 L 45mm ø 17mm suitable for Minisit				
	GEV No.	102102	Ref. No.	—
probe 100-340°C probe ø 5mm probe L 68mm capillary pipe 1750mm t.max. 340°C oven/grill probe type type B1 suitable for MINISIT 710				

accessories for		101438		
	GEV No.	100809	Ref. No.	—
O-ring EPDM thickness 2mm ID ø 21mm Qty 1 pcs				
	GEV No.	100904	Ref. No.	—
locking screw M10x1 for pipe ø 4mm Qty 1 pcs				
	GEV No.	100905	Ref. No.	—
locking screw M10x1 for pipe ø 6mm Qty 1 pcs				
	GEV No.	101054	Ref. No.	—
magnet unit T1: M10x1 T2: M24x1 L 45mm ø 17mm suitable for Minisit				
	GEV No.	101136	Ref. No.	—
piezoelectric igniter suitable for Minisit with cover cap ømm connection F6.3x0.8				
	GEV No.	101137	Ref. No.	—
cover cap without piezoelectric igniter				

accessories for		101438		
	GEV No.	101267	Ref. No.	—
reducer IT 3/8" ET 1/2" L 21mm				
	GEV No.	101268	Ref. No.	—
gas connection thread 3/8" angled with O-ring MINISIT 710				
	GEV No.	101269	Ref. No.	—
gas connection thread 1/2" angled with O-ring MINISIT 710				
	GEV No.	101270	Ref. No.	—
screw connection IT 3/8" ET 3/8" L 28mm				
	GEV No.	101272	Ref. No.	—
screw connection IT 1/2" ET 3/8" L 57mm				
	GEV No.	101273	Ref. No.	—
olive for pipe ø 12mm L 9.5mm brass Qty 1 pcs suitable for universal				
	GEV No.	101274	Ref. No.	—
olive for pipe ø 16mm Qty 1 pcs				
	GEV No.	101275	Ref. No.	—
union screw thread 1/2" for pipe ø 16mm Qty 1 pcs				
	GEV No.	101276	Ref. No.	—
union screw thread 3/8" tube ø 12mm Qty 1 pcs				
	GEV No.	110068	Ref. No.	—
knob suitable for Minisit ø 37mm				

**PEL**

**24ST series**





<b>GEV No.</b>	101076	<b>Ref. No.</b>	016880	
<b>description</b>	gas thermostat PEL type 24ST 120-320°C gas inlet M20x1.5 (tube ø 12mm) bypass nozzle ø 0.35mm gas outlet M20x1.5 (tube ø 12/10mm) thermocouple connection M9x1 pilot connection M10x1 capillary pipe 1200mm probe ø 6mm probe L 100mm shaft ø 10x8mm shaft L 27/17mm shaft flat upper			
<b>spare parts for</b>	101076			
	GEV No.	100455	Ref. No.	—
bypass nozzle type PEL23/24 bore ø 0.35mm thread M8x0.5				
	GEV No.	101058	Ref. No.	—
magnet unit L 39mm D1 ø 15.4mm D2 ø 13.5mm suitable for PEL22/EGA24197 standard				
	GEV No.	106200	Ref. No.	—
nut thread M9x1 suitable for PEL 24/25S				

Table continues overleaf



accessories for 101076				
	GEV No.	100908	Ref. No.	—
	union screw thread M10x1 for pipe ø 4mm Qty 1 pcs			
	GEV No.	100909	Ref. No.	—
	union screw thread M10x1 for pipe ø 6mm Qty 1 pcs			
	GEV No.	101246	Ref. No.	—
	olive for pipe ø 4mm Qty 1 pcs			
	GEV No.	101248	Ref. No.	—
	olive for pipe ø 12mm Qty 1 pcs suitable for PEL			
	GEV No.	101249	Ref. No.	—
	olive for pipe ø 10mm Qty 1 pcs			
	GEV No.	101250	Ref. No.	—
	union nut thread M20x1.5 for pipe ø 10mm			
	GEV No.	101251	Ref. No.	—
	union nut thread M20x1.5 for pipe ø 12mm			
	GEV No.	101286	Ref. No.	—
	olive ID ø 6mm Qty 1 pcs			
	GEV No.	110079	Ref. No.	—
	knob dial plate gas thermostat 1-8 silver			
	GEV No.	110080	Ref. No.	—
	knob ø 70mm shaft ø 10x8mm shaft flat universal			

## gas valves and ignition boxes



### gas control valves



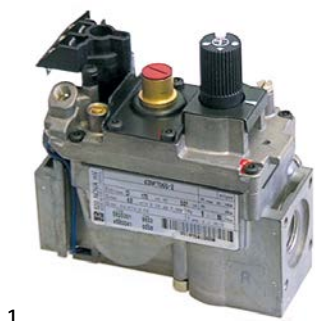

SIT

NOVASIT



1

GEV No.	101187	Ref. No.	030100014	
<b>description</b>	gas valve SIT series Novasit 820 0.17VHz gas inlet 1/2" gas outlet 1/2" thermocouple connection M9x1 pilot connection M10x1 ignition pressurebar pressure range 5-50mbar pressure regulator connection blind equiv. no. 0.820.301 supply Operator millivolt			
<b>spare parts for</b>	101187			
	GEV No.	101065	Ref. No.	—
	magnet unit with cable L 44mm D1 ø 30mm D2 ø 20mm suitable for NOVASIT			
<b>accessories for</b>	101187			
	GEV No.	100110	Ref. No.	030100000
	pilot burner SIT type 190 series 3 flames nozzle ømm gas connectionmm			

accessories for 101187				
	GEV No.	101305	Ref. No.	—
	gas connection straight 1/2" flange 45x45mm ELETTROSIT/V4400/4600/4605 suitable for SIT/HONEYWELL hole distance 36x36mm			
	GEV No.	101306	Ref. No.	—
	gas connection angled flange 45x45mm hole distance 36x36mm 1/2" ELETTROSIT/V4400/4600/4605 screw with O-ring suitable for SIT/HONEYWELL			
	GEV No.	101307	Ref. No.	—
	gas connection straight flange 45x45mm hole distance 36x36mm 3/4" ELETTROSIT/V4400/4600/4605 screw with O-ring suitable for SIT/HONEYWELL			
	GEV No.	101308	Ref. No.	—
	gas connection angled flange 45x45mm hole distance 36x36mm 3/4" ELETTROSIT/V4400/4600/4605 screw with O-ring suitable for SIT/HONEYWELL			
	GEV No.	102116	Ref. No.	040400130
	thermopile ROBERTSHAW L 900mm probe ø 9mm probe L 57mm 250-750mV screw connection 7/16"			

## ignition boxes

HONEYWELL



1

GEV No.	102367	Ref. No.	OCEN000
<b>description</b>	ignition box HONEYWELL type S4565A 2092 1 electrodes 3 waiting times safety time 10s 220-240V 4VA 50/60Hz		

## ignition parts

### pilot burners

SIT

100 series

accessories

pilot burner bottom parts



1



GEV No.	107701	Ref. No.	020484	
<b>description</b>	pilot burner bottom part SIT 100 series nozzle ø 0.2mm			
<b>spare parts for</b>	107701			
	GEV No.	100245	Ref. No.	016106
	pilot burner nozzle LPG code 20 bore ø 0.2mm Qty 1 pcs thread M8x0.75			

Table continues overleaf







spare parts for		107701	
	GEV No.	100916	Ref. No. —
compression spring for pilot burner Qty 1 pcs			
	GEV No.	100917	Ref. No. —
gasket for pilot burner Qty 1 pcs aluminium			
	GEV No.	100918	Ref. No. —
screw for pilot burner			
accessories for		107701	
	GEV No.	100246	Ref. No. —
pilot burner nozzle natural gas bore $\varnothing$ 0.35mm Qty 1 pcs thread M8x0.75			
	GEV No.	100904	Ref. No. —
locking screw M10x1 for pipe $\varnothing$ 4mm Qty 1 pcs			
	GEV No.	100905	Ref. No. —
locking screw M10x1 for pipe $\varnothing$ 6mm Qty 1 pcs			
	GEV No.	102110	Ref. No. —
pilot tube copper pipe $\varnothing$ 4mm thickness 1mm L 3000mm			
	GEV No.	102111	Ref. No. —
pilot tube copper pipe $\varnothing$ 6mm thickness 1mm L 3000mm			
	GEV No.	102742	Ref. No. —
pilot burner nozzle LPG code 25 bore $\varnothing$ 0.25mm Qty 1 pcs			

**pilot burner nozzles**

	1		
<b>GEV No.</b>	100245	<b>Ref. No.</b>	016106
<b>description</b>	pilot burner nozzle LPG code 20 bore $\varnothing$ 0.2mm Qty 1 pcs thread M8x0.75		
<b>For models:</b>	105014		

**190 series**

	1		
<b>GEV No.</b>	100110	<b>Ref. No.</b>	030100000
<b>description</b>	pilot burner SIT type 190 series 3 flames nozzle $\varnothing$ mm gas connectionmm		
accessories for		100110	
	GEV No.	100202	Ref. No. —
pilot burner nozzle natural gas code 41 Qty 1 pcs nozzle $\varnothing$ 0.41mm			
	GEV No.	100203	Ref. No. —
pilot burner nozzle LPG code 25 Qty 1 pcs nozzle $\varnothing$ 0.25mm			
	GEV No.	100701	Ref. No. —
ignition electrode connection M4 Qty 1 pcs			
	GEV No.	100906	Ref. No. —
screw connection thread M10x1 for ignition electrode brass Qty 1 pcs WS 10			

accessories for		100110	
	GEV No.	100907	Ref. No. —
screw connection thread M10x1 Qty 1 pcs type SEF 1 $\varnothing$ mm for thermocouple			
	GEV No.	100908	Ref. No. —
union screw thread M10x1 for pipe $\varnothing$ 4mm Qty 1 pcs			
	GEV No.	100909	Ref. No. —
union screw thread M10x1 for pipe $\varnothing$ 6mm Qty 1 pcs			
	GEV No.	101282	Ref. No. —
olive for pipe $\varnothing$ 4mm L 7.4mm Qty 1 pcs			
	GEV No.	101287	Ref. No. —
olive for pipe $\varnothing$ 6mm Qty 1 pcs			
	GEV No.	102110	Ref. No. —
pilot tube copper pipe $\varnothing$ 4mm thickness 1mm L 3000mm			
	GEV No.	102111	Ref. No. —
pilot tube copper pipe $\varnothing$ 6mm thickness 1mm L 3000mm			
	GEV No.	107650	Ref. No. —
pilot burner nozzle SIT LPG code 30 Qty 1 pcs			

**POLIDORO**

**pilot burners**















	1		
<b>GEV No.</b>	102295	<b>Ref. No.</b>	016081
<b>description</b>	pilot burner POLIDORO 3 flames code gas connection 4mm		
spare parts for		102295	
	GEV No.	100907	Ref. No. —
screw connection thread M10x1 Qty 1 pcs type SEF 1 $\varnothing$ mm for thermocouple			
accessories for		102295	
	GEV No.	100208	Ref. No. —
pilot burner nozzle POLIDORO LPG code 20 bore $\varnothing$ 0.2mm Qty 1 pcs			
	GEV No.	100209	Ref. No. —
pilot burner nozzle POLIDORO natural gas code 40 bore $\varnothing$ 0.4mm Qty 1 pcs			
	GEV No.	100701	Ref. No. —
ignition electrode connection M4 Qty 1 pcs			
	GEV No.	100906	Ref. No. —
screw connection thread M10x1 for ignition electrode brass Qty 1 pcs WS 10			
	GEV No.	100908	Ref. No. —
union screw thread M10x1 for pipe $\varnothing$ 4mm Qty 1 pcs			
	GEV No.	100909	Ref. No. —
union screw thread M10x1 for pipe $\varnothing$ 6mm Qty 1 pcs			

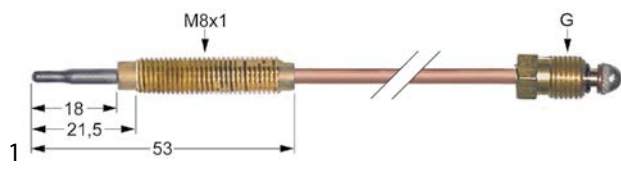

Table continues overleaf



<b>accessories for</b>	102295		
	GEV No.	101280	Ref. No. —
	olive for pipe ø 4mm Qty 1 pcs		
	GEV No.	101287	Ref. No. —
	olive for pipe ø 6mm Qty 1 pcs		
	GEV No.	102110	Ref. No. —
	pilot tube copper pipe ø 4mm thickness 1mm L 3000mm		
	GEV No.	102111	Ref. No. —
	pilot tube copper pipe ø 6mm thickness 1mm L 3000mm		



**electrodes**

			
<b>GEV No.</b>	100724	<b>Ref. No.</b>	010288
<b>description</b>	ignition electrode D1 ø 8mm BL1 13mm BL2 28mm BL3 8mm connection F 2.8x0.8mm M10x0.75		
<b>accessories for</b>	100724		
	GEV No.	519546	Ref. No. —
	nut thread M10x0.75 H 3.45mm WS 14 brass Qty 1 pcs		

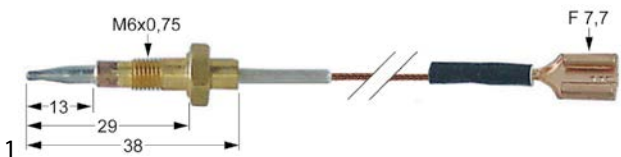
**thermocouples**

<b>threaded thermocouples</b>			
<b>threaded thermocouples standard</b>			
<b>with socket with thread M8x1</b>			
<b>type Junkers with aluminised tip</b>			
			
<b>GEV No.</b>	102233	<b>Ref. No.</b>	016991 019991
<b>description</b>	thermocouple M8x1 L 750mm M8x1		
<b>accessories for</b>	102233		
	GEV No.	102067	Ref. No. —
	nut thread M8x1 H 3mm brass Qty 1 pcs type SEF 1		

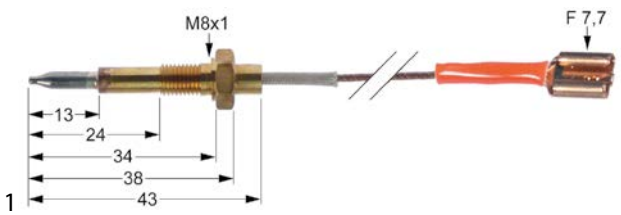
<b>threaded thermocouples with cable link</b>			
			
<b>GEV No.</b>	102274	<b>Ref. No.</b>	001Q855
<b>description</b>	thermocouple with 1 conductor L 450mm connection F 7.7mm M6x0.75		
<b>accessories for</b>	102274		
	GEV No.	102680	Ref. No. —
	nut thread M6x0.75 H 2.6mm WS 8 brass Qty 1 pcs type SEF 2		

			
<b>GEV No.</b>	102275	<b>Ref. No.</b>	001Q876
<b>description</b>	thermocouple with 1 conductor L 450mm connection F 7.7mm M6x0.75		
<b>accessories for</b>	102275		
	GEV No.	102680	Ref. No. —
	nut thread M6x0.75 H 2.6mm WS 8 brass Qty 1 pcs type SEF 2		



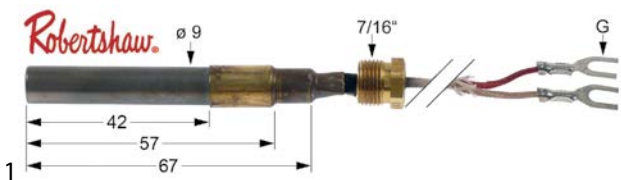

**thermopiles**





			
<b>GEV No.</b>	102116	<b>Ref. No.</b>	040400130
<b>description</b>	thermopile ROBERTSHAW L 900mm probe ø 9mm probe L 57mm 250-750mV screw connection 7/16"		

**gas burners**





<b>hob burners</b>			
<b>universal hob burners</b>			
<b>GEV</b>			
			
<b>GEV No.</b>	106379	<b>Ref. No.</b>	N/A
<b>description</b>	air mixing tube for burner cap ø 80mm L 23mm D1 ø 20mm D2 ø 15.6mm D3 ø 14mm		











			
1			
<b>GEV No.</b>	103068	<b>Ref. No.</b>	A042200
<b>description</b>	burner cap ø 100mm		
<b>accessories for</b>	103068		
	<b>GEV No.</b>	103067	<b>Ref. No.</b> A042000
	burner ring for burner cap ø 100mm		
	<b>GEV No.</b>	104102	<b>Ref. No.</b> A041800
	burner head for burner cap ø 100mm ext. ø 130		
	<b>GEV No.</b>	104103	<b>Ref. No.</b> A041600
	burner holder suitable for burner ø100mm with nozzle holder		





			
1			
<b>GEV No.</b>	103066	<b>Ref. No.</b>	A042100
<b>description</b>	burner cap ø 80mm		
<b>accessories for</b>	103066		
	<b>GEV No.</b>	103065	<b>Ref. No.</b> A041900
	burner ring for burner cap ø 80mm		
	<b>GEV No.</b>	104100	<b>Ref. No.</b> A041700
	burner head for burner cap ø 80mm		
	<b>GEV No.</b>	104101	<b>Ref. No.</b> A041500
	burner holder for burner cap ø 80mm with nozzle holder with mixing sleeve		

			
1			
<b>GEV No.</b>	104102	<b>Ref. No.</b>	A041800
<b>description</b>	burner head for burner cap ø 100mm ext. ø 130		

			
1			
<b>GEV No.</b>	104100	<b>Ref. No.</b>	A041700
<b>description</b>	burner head for burner cap ø 80mm		
<b>accessories for</b>	104100		
	<b>GEV No.</b>	103065	<b>Ref. No.</b> A041900
	burner ring for burner cap ø 80mm		
	<b>GEV No.</b>	103066	<b>Ref. No.</b> A042100
	burner cap ø 80mm		
	<b>GEV No.</b>	104103	<b>Ref. No.</b> A041600
	burner holder suitable for burner ø100mm with nozzle holder		





			
1			
<b>GEV No.</b>	104101	<b>Ref. No.</b>	A041500
<b>description</b>	burner holder for burner cap ø 80mm with nozzle holder with mixing sleeve		
<b>accessories for</b>	104101		
	<b>GEV No.</b>	103065	<b>Ref. No.</b> A041900
	burner ring for burner cap ø 80mm		
	<b>GEV No.</b>	103066	<b>Ref. No.</b> A042100
	burner cap ø 80mm		
	<b>GEV No.</b>	104100	<b>Ref. No.</b> A041700
	burner head for burner cap ø 80mm		

			
1			
<b>GEV No.</b>	104103	<b>Ref. No.</b>	A041600
<b>description</b>	burner holder suitable for burner ø100mm with nozzle holder		
<b>accessories for</b>	104103		
	<b>GEV No.</b>	103067	<b>Ref. No.</b> A042000
	burner ring for burner cap ø 100mm		
	<b>GEV No.</b>	103068	<b>Ref. No.</b> A042200
	burner cap ø 100mm		
	<b>GEV No.</b>	104102	<b>Ref. No.</b> A041800
	burner head for burner cap ø 100mm ext. ø 130		

			
1			
<b>GEV No.</b>	103067	<b>Ref. No.</b>	A042000
<b>description</b>	burner ring for burner cap ø 100mm		
<b>accessories for</b>	103067		
	<b>GEV No.</b>	103068	<b>Ref. No.</b> A042200
	burner cap ø 100mm		
	<b>GEV No.</b>	104102	<b>Ref. No.</b> A041800
	burner head for burner cap ø 100mm ext. ø 130		
	<b>GEV No.</b>	104103	<b>Ref. No.</b> A041600
	burner holder suitable for burner ø100mm with nozzle holder		









			
1			
<b>GEV No.</b>	103065	<b>Ref. No.</b>	A041900
<b>description</b>	burner ring for burner cap ø 80mm		
<b>accessories for</b>	103065		
	<b>GEV No.</b>	103066	<b>Ref. No.</b> A042100
burner cap ø 80mm			
	<b>GEV No.</b>	104100	<b>Ref. No.</b> A041700
burner head for burner cap ø 80mm			
	<b>GEV No.</b>	104101	<b>Ref. No.</b> A041500
burner holder for burner cap ø 80mm with nozzle holder with mixing sleeve			

**SABAF**

**2 series - standard**



			
1			
<b>GEV No.</b>	105993	<b>Ref. No.</b>	001U588
<b>description</b>	burner cap 1.8kW ø 75mm bright finish		

			
1			
<b>GEV No.</b>	105054	<b>Ref. No.</b>	001U589
<b>description</b>	burner cap 3kW ø 100mm H 3.5mm bright finish		
<b>accessories for</b>	105054		
	<b>GEV No.</b>	105058	<b>Ref. No.</b> —
burner head 3kW for igniter ø 6mm for burner cap ø 100mm			
	<b>GEV No.</b>	105059	<b>Ref. No.</b> —
burner lower part 3kW for igniter ø 6mm for thermocouple ø 6mm without nozzle for burner cap ø 100mm			

**2 series - flat skirt version**

			
1			
<b>GEV No.</b>	105993	<b>Ref. No.</b>	001U588
<b>description</b>	burner cap 1.8kW ø 75mm bright finish		

			
1			
<b>GEV No.</b>	105994	<b>Ref. No.</b>	001U587 0210003003
<b>description</b>	burner cap 1kW ø 55mm bright finish		





			
1			
<b>GEV No.</b>	105054	<b>Ref. No.</b>	001U589
<b>description</b>	burner cap 3kW ø 100mm H 3.5mm bright finish		
<b>accessories for</b>	105054		
	<b>GEV No.</b>	105058	<b>Ref. No.</b> —
burner head 3kW for igniter ø 6mm for burner cap ø 100mm			
	<b>GEV No.</b>	105059	<b>Ref. No.</b> —
burner lower part 3kW for igniter ø 6mm for thermocouple ø 6mm without nozzle for burner cap ø 100mm			

			
1			
<b>GEV No.</b>	105995	<b>Ref. No.</b>	001Q808
<b>description</b>	burner head 1.8kW for burner cap ø 75mm		





			
1			
<b>GEV No.</b>	105996	<b>Ref. No.</b>	001Q805
<b>description</b>	burner head 1kW for burner cap ø 55mm		

			
1			
<b>GEV No.</b>	105992	<b>Ref. No.</b>	001Q811
<b>description</b>	burner head 3kW for burner cap ø 100mm		

**triple ring burner series - standard version**

			
1			
<b>GEV No.</b>	105063	<b>Ref. No.</b>	001U591
<b>description</b>	burner cap 3.6kW ø 131mm H 4mm mounting pos. outer		
<b>accessories for</b>	105063		
	<b>GEV No.</b>	105064	<b>Ref. No.</b> 001U590
burner cap 3.6kW ø 61mm H 6.5mm mounting pos. inner bright finish			
	<b>GEV No.</b>	105065	<b>Ref. No.</b> —
burner head 3.6kW for burner cap ø 61/131mm			
	<b>GEV No.</b>	105717	<b>Ref. No.</b> —
burner lower part 3.6kW for igniter ø 6mm for thermocouple ø 6mm with nozzle ø1.35mm ID ø 64mm for burner cap ø 61/131mm			
	<b>GEV No.</b>	105922	<b>Ref. No.</b> —
burner lower part 3.6kW for igniter ø 6mm for thermocouple ø 6mm with nozzle ø1.35mm ID ø 75mm for burner cap ø 61/131mm			



			
1			
<b>GEV No.</b>	105064	<b>Ref. No.</b>	001U590
<b>description</b>	burner cap 3.6kW ø 61mm H 6.5mm mounting pos. inner bright finish		
<b>accessories for</b>	105064		
	<b>GEV No.</b>	105063	<b>Ref. No.</b> 001U591
	burner cap 3.6kW ø 131mm H 4mm mounting pos. outer		
	<b>GEV No.</b>	105065	<b>Ref. No.</b> —
	burner head 3.6kW for burner cap ø 61/131mm		
	<b>GEV No.</b>	105717	<b>Ref. No.</b> —
	burner lower part 3.6kW for igniter ø 6mm for thermocouple ø 6mm with nozzle ø1.35mm ID ø 64mm for burner cap ø 61/131mm		
	<b>GEV No.</b>	105922	<b>Ref. No.</b> —
	burner lower part 3.6kW for igniter ø 6mm for thermocouple ø 6mm with nozzle ø1.35mm ID ø 75mm for burner cap ø 61/131mm		

			
1			
<b>GEV No.</b>	105991	<b>Ref. No.</b>	001Q815 E0L01A192G
<b>description</b>	burner head for burner cap ø 131mm		





producer-specific hob burners

BARTSCHER





70, 85 (old) series

			
1			
<b>GEV No.</b>	104056	<b>Ref. No.</b>	2510140
<b>description</b>	air mixing sleeve		
<b>accessories for</b>	104056		
	<b>GEV No.</b>	105291	<b>Ref. No.</b> N/A
	burner head for burner cap ø 70mm 3.5kW		
	<b>GEV No.</b>	105292	<b>Ref. No.</b> 2510601
	burner cap ø 70mm 3.5kW		
	<b>GEV No.</b>	105293	<b>Ref. No.</b> 2510602
	venturi		
	<b>GEV No.</b>	105294	<b>Ref. No.</b> 2510603
	burner holder with nozzle holder		
	<b>GEV No.</b>	105296	<b>Ref. No.</b> —
	cover for pilot burner suitable for 700 series Qty 1 pcs		

triple ring burner series - flat skirt version

			
1			
<b>GEV No.</b>	105063	<b>Ref. No.</b>	001U591
<b>description</b>	burner cap 3.6kW ø 131mm H 4mm mounting pos. outer		
<b>accessories for</b>	105063		
	<b>GEV No.</b>	105064	<b>Ref. No.</b> 001U590
	burner cap 3.6kW ø 61mm H 6.5mm mounting pos. inner bright finish		
	<b>GEV No.</b>	105065	<b>Ref. No.</b> —
	burner head 3.6kW for burner cap ø 61/131mm		
	<b>GEV No.</b>	105717	<b>Ref. No.</b> —
	burner lower part 3.6kW for igniter ø 6mm for thermocouple ø 6mm with nozzle ø1.35mm ID ø 64mm for burner cap ø 61/131mm		
	<b>GEV No.</b>	105922	<b>Ref. No.</b> —
	burner lower part 3.6kW for igniter ø 6mm for thermocouple ø 6mm with nozzle ø1.35mm ID ø 75mm for burner cap ø 61/131mm		

			
1			
<b>GEV No.</b>	104053	<b>Ref. No.</b>	2510134
<b>description</b>	burner head for burner cap ø 125mm		

			
1			
<b>GEV No.</b>	105064	<b>Ref. No.</b>	001U590
<b>description</b>	burner cap 3.6kW ø 61mm H 6.5mm mounting pos. inner bright finish		
<b>accessories for</b>	105064		
	<b>GEV No.</b>	105063	<b>Ref. No.</b> 001U591
	burner cap 3.6kW ø 131mm H 4mm mounting pos. outer		
	<b>GEV No.</b>	105065	<b>Ref. No.</b> —
	burner head 3.6kW for burner cap ø 61/131mm		
	<b>GEV No.</b>	105717	<b>Ref. No.</b> —
	burner lower part 3.6kW for igniter ø 6mm for thermocouple ø 6mm with nozzle ø1.35mm ID ø 64mm for burner cap ø 61/131mm		
	<b>GEV No.</b>	105922	<b>Ref. No.</b> —
	burner lower part 3.6kW for igniter ø 6mm for thermocouple ø 6mm with nozzle ø1.35mm ID ø 75mm for burner cap ø 61/131mm		

			
1			
<b>GEV No.</b>	104052	<b>Ref. No.</b>	2510136
<b>description</b>	burner head for burner cap ø 80mm		

			
1			
<b>GEV No.</b>	105198	<b>Ref. No.</b>	2530085
<b>description</b>	fastening angle		

70. 90 (TopLine) series



<b>GEV No.</b>	105289	<b>Ref. No.</b>	2519002
<b>description</b>	air mixing sleeve L 50mm ED ø 45mm ID ø 42mm aluminium		
<b>accessories for</b>	105289		
	<b>GEV No.</b>	105280	<b>Ref. No.</b> 2510351
	<b>GEV No.</b>	105281	<b>Ref. No.</b> 2510352
	<b>GEV No.</b>	105282	<b>Ref. No.</b> —
	<b>GEV No.</b>	105283	<b>Ref. No.</b> 2510354
	<b>GEV No.</b>	105284	<b>Ref. No.</b> 2510355
	<b>GEV No.</b>	105285	<b>Ref. No.</b> 2510353
	<b>GEV No.</b>	105286	<b>Ref. No.</b> 2510357
	<b>GEV No.</b>	105287	<b>Ref. No.</b> 2510341 2510358
	<b>GEV No.</b>	105288	<b>Ref. No.</b> 2510340 2510356
	<b>GEV No.</b>	105290	<b>Ref. No.</b> 021647



<b>GEV No.</b>	105281	<b>Ref. No.</b>	2510352
<b>description</b>	burner cap C ø 80mm 3.5kW with central hole ID ø 32mm		
<b>accessories for</b>	105281		
	<b>GEV No.</b>	105280	<b>Ref. No.</b> 2510351
	<b>GEV No.</b>	105282	<b>Ref. No.</b> —
	<b>GEV No.</b>	105289	<b>Ref. No.</b> 2519002
	<b>GEV No.</b>	105290	<b>Ref. No.</b> 021647



<b>GEV No.</b>	105287	<b>Ref. No.</b>	2510341 2510358
<b>description</b>	burner cap E ø 125mm 7kW with central hole		
<b>accessories for</b>	105287		
	<b>GEV No.</b>	105286	<b>Ref. No.</b> 2510357
	<b>GEV No.</b>	105288	<b>Ref. No.</b> 2510340 2510356
	<b>GEV No.</b>	105289	<b>Ref. No.</b> 2519002
	<b>GEV No.</b>	105290	<b>Ref. No.</b> 021647



<b>GEV No.</b>	105284	<b>Ref. No.</b>	2510355
<b>description</b>	burner cap ID ø 54mm D ø 105mm 5.6kW with central hole		
<b>accessories for</b>	105284		
	<b>GEV No.</b>	105283	<b>Ref. No.</b> 2510354
	<b>GEV No.</b>	105285	<b>Ref. No.</b> 2510353
	<b>GEV No.</b>	105289	<b>Ref. No.</b> 2519002
	<b>GEV No.</b>	105290	<b>Ref. No.</b> 021647



<b>GEV No.</b>	105280	<b>Ref. No.</b>	2510351
<b>description</b>	burner head C for burner cap ø 80mm 3.5kW		
<b>accessories for</b>	105280		
	<b>GEV No.</b>	105281	<b>Ref. No.</b> 2510352
	<b>GEV No.</b>	105282	<b>Ref. No.</b> —
	<b>GEV No.</b>	105289	<b>Ref. No.</b> 2519002





Table continues overleaf



<b>accessories for</b>	105280		
	<b>GEV No.</b>	105290	<b>Ref. No.</b> 021647
	nozzle holder nozzle mounting M11x1		





 <p>1</p>			
<b>GEV No.</b>	105283	<b>Ref. No.</b>	2510354
<b>description</b>	burner head D for burner cap ø 105mm 5.6kW		
<b>accessories for</b>	105283		
	<b>GEV No.</b>	105284	<b>Ref. No.</b> 2510355
	burner cap ID ø 54mm D ø 105mm 5.6kW with central hole		
	<b>GEV No.</b>	105285	<b>Ref. No.</b> 2510353
	venturi D for burner cap ø 105mm 5.6kW		
	<b>GEV No.</b>	105289	<b>Ref. No.</b> 2519002
	air mixing sleeve L 50mm ED ø 45mm ID ø 42mm aluminium		
	<b>GEV No.</b>	105290	<b>Ref. No.</b> 021647
	nozzle holder nozzle mounting M11x1		

 <p>1</p>			
<b>GEV No.</b>	105286	<b>Ref. No.</b>	2510357
<b>description</b>	burner head E for burner cap ø 125mm 7kW		
<b>accessories for</b>	105286		
	<b>GEV No.</b>	105287	<b>Ref. No.</b> 2510341 2510358
	burner cap E ø 125mm 7kW with central hole		
	<b>GEV No.</b>	105288	<b>Ref. No.</b> 2510340 2510356
	venturi E for burner cap ø 125mm 7kW		
	<b>GEV No.</b>	105289	<b>Ref. No.</b> 2519002
	air mixing sleeve L 50mm ED ø 45mm ID ø 42mm aluminium		
	<b>GEV No.</b>	105290	<b>Ref. No.</b> 021647
	nozzle holder nozzle mounting M11x1		



 <p>1</p>			
<b>GEV No.</b>	105290	<b>Ref. No.</b>	021647
<b>description</b>	nozzle holder nozzle mounting M11x1		
<b>accessories for</b>	105290		
	<b>GEV No.</b>	105280	<b>Ref. No.</b> 2510351
	burner head C for burner cap ø 80mm 3.5kW		
	<b>GEV No.</b>	105281	<b>Ref. No.</b> 2510352
	burner cap C ø 80mm 3.5kW with central hole ID ø 32mm		
	<b>GEV No.</b>	105282	<b>Ref. No.</b> —
	venturi C for burner cap ø 80mm 3.5kW		



<b>accessories for</b>	105290		
	<b>GEV No.</b>	105283	<b>Ref. No.</b> 2510354
	burner head D for burner cap ø 105mm 5.6kW		
	<b>GEV No.</b>	105284	<b>Ref. No.</b> 2510355
	burner cap ID ø 54mm D ø 105mm 5.6kW with central hole		
	<b>GEV No.</b>	105285	<b>Ref. No.</b> 2510353
	venturi D for burner cap ø 105mm 5.6kW		
	<b>GEV No.</b>	105286	<b>Ref. No.</b> 2510357
	burner head E for burner cap ø 125mm 7kW		
	<b>GEV No.</b>	105287	<b>Ref. No.</b> 2510341 2510358
	burner cap E ø 125mm 7kW with central hole		
	<b>GEV No.</b>	105288	<b>Ref. No.</b> 2510340 2510356
	venturi E for burner cap ø 125mm 7kW		
	<b>GEV No.</b>	105289	<b>Ref. No.</b> 2519002
	air mixing sleeve L 50mm ED ø 45mm ID ø 42mm aluminium		



 <p>1</p>			
<b>GEV No.</b>	104452	<b>Ref. No.</b>	2510350
<b>description</b>	venturi C for burner cap ø 80mm 3.5kW		

 <p>1</p>			
<b>GEV No.</b>	105285	<b>Ref. No.</b>	2510353
<b>description</b>	venturi D for burner cap ø 105mm 5.6kW		
<b>accessories for</b>	105285		
	<b>GEV No.</b>	105283	<b>Ref. No.</b> 2510354
	burner head D for burner cap ø 105mm 5.6kW		
	<b>GEV No.</b>	105284	<b>Ref. No.</b> 2510355
	burner cap ID ø 54mm D ø 105mm 5.6kW with central hole		
	<b>GEV No.</b>	105289	<b>Ref. No.</b> 2519002
	air mixing sleeve L 50mm ED ø 45mm ID ø 42mm aluminium		
	<b>GEV No.</b>	105290	<b>Ref. No.</b> 021647
	nozzle holder nozzle mounting M11x1		







			
1			
<b>GEV No.</b>	105288	<b>Ref. No.</b>	2510340 2510356
<b>description</b>	venturi E for burner cap ø 125mm 7kW		
<b>accessories for</b>	105288		
	<b>GEV No.</b>	105286	<b>Ref. No.</b> 2510357
	burner head E for burner cap ø 125mm 7kW		
	<b>GEV No.</b>	105287	<b>Ref. No.</b> 2510341 2510358
	burner cap E ø 125mm 7kW with central hole		
	<b>GEV No.</b>	105289	<b>Ref. No.</b> 2519002
	air mixing sleeve L 50mm ED ø 45mm ID ø 42mm aluminium		
	<b>GEV No.</b>	105290	<b>Ref. No.</b> 021647
	nozzle holder nozzle mounting M11x1		

70N series			
			
1			
<b>GEV No.</b>	104056	<b>Ref. No.</b>	2510140
<b>description</b>	air mixing sleeve		
<b>accessories for</b>	104056		
	<b>GEV No.</b>	105291	<b>Ref. No.</b> N/A
	burner head for burner cap ø 70mm 3.5kW		
	<b>GEV No.</b>	105292	<b>Ref. No.</b> 2510601
	burner cap ø 70mm 3.5kW		
	<b>GEV No.</b>	105293	<b>Ref. No.</b> 2510602
	venturi		
	<b>GEV No.</b>	105294	<b>Ref. No.</b> 2510603
	burner holder with nozzle holder		
	<b>GEV No.</b>	105296	<b>Ref. No.</b> —
	cover for pilot burner suitable for 700 series Qty 1 pcs		

			
1			
<b>GEV No.</b>	105292	<b>Ref. No.</b>	2510601
<b>description</b>	burner cap ø 70mm 3.5kW		
<b>accessories for</b>	105292		
	<b>GEV No.</b>	104056	<b>Ref. No.</b> 2510140
	air mixing sleeve		
	<b>GEV No.</b>	105291	<b>Ref. No.</b> N/A
	burner head for burner cap ø 70mm 3.5kW		

<b>accessories for</b>	105292		
	<b>GEV No.</b>	105293	<b>Ref. No.</b> 2510602
	venturi		
	<b>GEV No.</b>	105294	<b>Ref. No.</b> 2510603
	burner holder with nozzle holder		
	<b>GEV No.</b>	105296	<b>Ref. No.</b> —
	cover for pilot burner suitable for 700 series Qty 1 pcs		





			
1			
<b>GEV No.</b>	105291	<b>Ref. No.</b>	N/A
<b>description</b>	burner head for burner cap ø 70mm 3.5kW		
<b>accessories for</b>	105291		
	<b>GEV No.</b>	104056	<b>Ref. No.</b> 2510140
	air mixing sleeve		
	<b>GEV No.</b>	105292	<b>Ref. No.</b> 2510601
	burner cap ø 70mm 3.5kW		
	<b>GEV No.</b>	105293	<b>Ref. No.</b> 2510602
	venturi		
	<b>GEV No.</b>	105294	<b>Ref. No.</b> 2510603
	burner holder with nozzle holder		
	<b>GEV No.</b>	105296	<b>Ref. No.</b> —
	cover for pilot burner suitable for 700 series Qty 1 pcs		

			
1			
<b>GEV No.</b>	105294	<b>Ref. No.</b>	2510603
<b>description</b>	burner holder with nozzle holder		
<b>accessories for</b>	105294		
	<b>GEV No.</b>	104056	<b>Ref. No.</b> 2510140
	air mixing sleeve		
	<b>GEV No.</b>	105291	<b>Ref. No.</b> N/A
	burner head for burner cap ø 70mm 3.5kW		
	<b>GEV No.</b>	105292	<b>Ref. No.</b> 2510601
	burner cap ø 70mm 3.5kW		
	<b>GEV No.</b>	105293	<b>Ref. No.</b> 2510602
	venturi		
	<b>GEV No.</b>	105296	<b>Ref. No.</b> —
	cover for pilot burner suitable for 700 series Qty 1 pcs		























			
1			
<b>GEV No.</b>	105293	<b>Ref. No.</b>	2510602
<b>description</b>	venturi		
<b>accessories for</b>	105293		
	<b>GEV No.</b>	104056	<b>Ref. No.</b> 2510140
	air mixing sleeve		
	<b>GEV No.</b>	105291	<b>Ref. No.</b> N/A
	burner head for burner cap ø 70mm 3.5kW		
	<b>GEV No.</b>	105292	<b>Ref. No.</b> 2510601
	burner cap ø 70mm 3.5kW		
	<b>GEV No.</b>	105294	<b>Ref. No.</b> 2510603
	burner holder with nozzle holder		
	<b>GEV No.</b>	105296	<b>Ref. No.</b> —
	cover for pilot burner suitable for 700 series Qty 1 pcs		

			
1			
<b>GEV No.</b>	103030	<b>Ref. No.</b>	2510190
<b>description</b>	burner cap C ø 85mm 3.5kW		
<b>accessories for</b>	103030		
	<b>GEV No.</b>	104045	<b>Ref. No.</b> 2510189
	burner head C for burner cap ø 85mm 3.5kW		
	<b>GEV No.</b>	104048	<b>Ref. No.</b> 2510195
	venturi C for burner cap ø 85mm 3.5kW		
	<b>GEV No.</b>	104051	<b>Ref. No.</b> 2510197
	air mixing sleeve		

90 (old) series

			
1			
<b>GEV No.</b>	104051	<b>Ref. No.</b>	2510197
<b>description</b>	air mixing sleeve		
<b>accessories for</b>	104051		
	<b>GEV No.</b>	103030	<b>Ref. No.</b> 2510190
	burner cap C ø 85mm 3.5kW		
	<b>GEV No.</b>	103031	<b>Ref. No.</b> 2510193
	burner cap D ø 115mm 5.5kW		
	<b>GEV No.</b>	103032	<b>Ref. No.</b> —
	burner cap E ø 125mm 7kW with central hole		
	<b>GEV No.</b>	104045	<b>Ref. No.</b> 2510189
	burner head C for burner cap ø 85mm 3.5kW		
	<b>GEV No.</b>	104046	<b>Ref. No.</b> 2510192
	burner head D for burner cap ø 115mm 5.5kW		
	<b>GEV No.</b>	104047	<b>Ref. No.</b> 2510194
	burner head E for burner cap ø 125mm 7kW		
	<b>GEV No.</b>	104048	<b>Ref. No.</b> 2510195
	venturi C for burner cap ø 85mm 3.5kW		
	<b>GEV No.</b>	104049	<b>Ref. No.</b> 2510201
	venturi D for burner cap ø 115mm 5.5kW		
	<b>GEV No.</b>	104050	<b>Ref. No.</b> 2510202
	venturi E for burner cap ø 125mm 7kW		





			
1			
<b>GEV No.</b>	103031	<b>Ref. No.</b>	2510193
<b>description</b>	burner cap D ø 115mm 5.5kW		
<b>accessories for</b>	103031		
	<b>GEV No.</b>	104046	<b>Ref. No.</b> 2510192
	burner head D for burner cap ø 115mm 5.5kW		
	<b>GEV No.</b>	104049	<b>Ref. No.</b> 2510201
	venturi D for burner cap ø 115mm 5.5kW		
	<b>GEV No.</b>	104051	<b>Ref. No.</b> 2510197
	air mixing sleeve		





			
1			
<b>GEV No.</b>	104045	<b>Ref. No.</b>	2510189
<b>description</b>	burner head C for burner cap ø 85mm 3.5kW		
<b>accessories for</b>	104045		
	<b>GEV No.</b>	103030	<b>Ref. No.</b> 2510190
	burner cap C ø 85mm 3.5kW		
	<b>GEV No.</b>	104048	<b>Ref. No.</b> 2510195
	venturi C for burner cap ø 85mm 3.5kW		
	<b>GEV No.</b>	104051	<b>Ref. No.</b> 2510197
	air mixing sleeve		







			
1			
<b>GEV No.</b>	104046	<b>Ref. No.</b>	2510192
<b>description</b>	burner head D for burner cap ø 115mm 5.5kW		
<b>accessories for</b>	104046		
	<b>GEV No.</b>	103031	<b>Ref. No.</b> 2510193
	burner cap D ø 115mm 5.5kW		
	<b>GEV No.</b>	104049	<b>Ref. No.</b> 2510201
	venturi D for burner cap ø 115mm 5.5kW		
	<b>GEV No.</b>	104051	<b>Ref. No.</b> 2510197
	air mixing sleeve		

			
1			
<b>GEV No.</b>	104047	<b>Ref. No.</b>	2510194
<b>description</b>	burner head E for burner cap ø 125mm 7kW		
<b>accessories for</b>	104047		
	<b>GEV No.</b>	103032	<b>Ref. No.</b> —
	burner cap E ø 125mm 7kW with central hole		
	<b>GEV No.</b>	104050	<b>Ref. No.</b> 2510202
	venturi E for burner cap ø 125mm 7kW		
	<b>GEV No.</b>	104051	<b>Ref. No.</b> 2510197
	air mixing sleeve		

			
1			
<b>GEV No.</b>	104048	<b>Ref. No.</b>	2510195
<b>description</b>	venturi C for burner cap ø 85mm 3.5kW		
<b>accessories for</b>	104048		
	<b>GEV No.</b>	103030	<b>Ref. No.</b> 2510190
	burner cap C ø 85mm 3.5kW		
	<b>GEV No.</b>	104045	<b>Ref. No.</b> 2510189
	burner head C for burner cap ø 85mm 3.5kW		
	<b>GEV No.</b>	104051	<b>Ref. No.</b> 2510197
	air mixing sleeve		

			
1			
<b>GEV No.</b>	104049	<b>Ref. No.</b>	2510201
<b>description</b>	venturi D for burner cap ø 115mm 5.5kW		
<b>accessories for</b>	104049		
	<b>GEV No.</b>	103031	<b>Ref. No.</b> 2510193
	burner cap D ø 115mm 5.5kW		
	<b>GEV No.</b>	104046	<b>Ref. No.</b> 2510192
	burner head D for burner cap ø 115mm 5.5kW		
	<b>GEV No.</b>	104051	<b>Ref. No.</b> 2510197
	air mixing sleeve		

			
1			
<b>GEV No.</b>	104050	<b>Ref. No.</b>	2510202
<b>description</b>	venturi E for burner cap ø 125mm 7kW		
<b>accessories for</b>	104050		
	<b>GEV No.</b>	103032	<b>Ref. No.</b> —
	burner cap E ø 125mm 7kW with central hole		
	<b>GEV No.</b>	104047	<b>Ref. No.</b> 2510194
	burner head E for burner cap ø 125mm 7kW		
	<b>GEV No.</b>	104051	<b>Ref. No.</b> 2510197
	air mixing sleeve		

**Snack series**

			
1			
<b>GEV No.</b>	106379	<b>Ref. No.</b>	N/A
<b>description</b>	air mixing tube for burner cap ø 80mm L 23mm D1 ø 20mm D2 ø 15.6mm D3 ø 14mm		









			
1			
<b>GEV No.</b>	103068	<b>Ref. No.</b>	A042200
<b>description</b>	burner cap ø 100mm		
<b>accessories for</b>	103068		
	<b>GEV No.</b>	103067	<b>Ref. No.</b> A042000
	burner ring for burner cap ø 100mm		
	<b>GEV No.</b>	104102	<b>Ref. No.</b> A041800
	burner head for burner cap ø 100mm ext. ø 130		





Table continues overleaf







<b>accessories for</b>	103068		
	<b>GEV No.</b>	104103	<b>Ref. No.</b> A041600
burner holder suitable for burner ø100mm with nozzle holder			





<b>accessories for</b>	104101		
	<b>GEV No.</b>	104100	<b>Ref. No.</b> A041700
burner head for burner cap ø 80mm			





<b>1</b>			
<b>GEV No.</b>	103066	<b>Ref. No.</b>	A042100
<b>description</b>	burner cap ø 80mm		
<b>accessories for</b>	103066		
	<b>GEV No.</b>	103065	<b>Ref. No.</b> A041900
burner ring for burner cap ø 80mm			
	<b>GEV No.</b>	104100	<b>Ref. No.</b> A041700
burner head for burner cap ø 80mm			
	<b>GEV No.</b>	104101	<b>Ref. No.</b> A041500
burner holder for burner cap ø 80mm with nozzle holder with mixing sleeve			



<b>1</b>			
<b>GEV No.</b>	104103	<b>Ref. No.</b>	A041600
<b>description</b>	burner holder suitable for burner ø100mm with nozzle holder		
<b>accessories for</b>	104103		
	<b>GEV No.</b>	103067	<b>Ref. No.</b> A042000
burner ring for burner cap ø 100mm			
	<b>GEV No.</b>	103068	<b>Ref. No.</b> A042200
burner cap ø 100mm			
	<b>GEV No.</b>	104102	<b>Ref. No.</b> A041800
burner head for burner cap ø 100mm ext. ø 130			

<b>1</b>			
<b>GEV No.</b>	104102	<b>Ref. No.</b>	A041800
<b>description</b>	burner head for burner cap ø 100mm ext. ø 130		

<b>1</b>			
<b>GEV No.</b>	103067	<b>Ref. No.</b>	A042000
<b>description</b>	burner ring for burner cap ø 100mm		
<b>accessories for</b>	103067		
	<b>GEV No.</b>	103068	<b>Ref. No.</b> A042200
burner cap ø 100mm			
	<b>GEV No.</b>	104102	<b>Ref. No.</b> A041800
burner head for burner cap ø 100mm ext. ø 130			
	<b>GEV No.</b>	104103	<b>Ref. No.</b> A041600
burner holder suitable for burner ø100mm with nozzle holder			

<b>1</b>			
<b>GEV No.</b>	104100	<b>Ref. No.</b>	A041700
<b>description</b>	burner head for burner cap ø 80mm		
<b>accessories for</b>	104100		
	<b>GEV No.</b>	103065	<b>Ref. No.</b> A041900
burner ring for burner cap ø 80mm			
	<b>GEV No.</b>	103066	<b>Ref. No.</b> A042100
burner cap ø 80mm			
	<b>GEV No.</b>	104103	<b>Ref. No.</b> A041600
burner holder suitable for burner ø100mm with nozzle holder			

<b>1</b>			
<b>GEV No.</b>	103065	<b>Ref. No.</b>	A041900
<b>description</b>	burner ring for burner cap ø 80mm		
<b>accessories for</b>	103065		
	<b>GEV No.</b>	103066	<b>Ref. No.</b> A042100
burner cap ø 80mm			
	<b>GEV No.</b>	104100	<b>Ref. No.</b> A041700
burner head for burner cap ø 80mm			
	<b>GEV No.</b>	104101	<b>Ref. No.</b> A041500
burner holder for burner cap ø 80mm with nozzle holder with mixing sleeve			

<b>1</b>			
<b>GEV No.</b>	104101	<b>Ref. No.</b>	A041500
<b>description</b>	burner holder for burner cap ø 80mm with nozzle holder with mixing sleeve		
<b>accessories for</b>	104101		
	<b>GEV No.</b>	103065	<b>Ref. No.</b> A041900
burner ring for burner cap ø 80mm			
	<b>GEV No.</b>	103066	<b>Ref. No.</b> A042100
burner cap ø 80mm			

accessories

pan supports



1			
<b>GEV No.</b>	210245	<b>Ref. No.</b>	N/A
<b>description</b>	pan support W 370mm L 580mm		

bar burners

bar burners



1			
<b>GEV No.</b>	105443	<b>Ref. No.</b>	024075
<b>description</b>	bar burner ø 40mm Wmm Hmm L 490mm flange width 43mm flange length 43mm pasta cooker		

solid top burners



1			
<b>GEV No.</b>	105251	<b>Ref. No.</b>	02510069
<b>description</b>	solid top burner ø 120mm H 102mm L 340mm		









accessories

nozzle holders



1			
<b>GEV No.</b>	104724	<b>Ref. No.</b>	010037
<b>description</b>	nozzle holder		



1			
<b>GEV No.</b>	105290	<b>Ref. No.</b>	021647
<b>description</b>	nozzle holder nozzle mounting M11x1		
<b>accessories for</b>	105290		
	<b>GEV No.</b>	105280	<b>Ref. No.</b> 2510351
	burner head C for burner cap ø 80mm 3.5kW		
	<b>GEV No.</b>	105281	<b>Ref. No.</b> 2510352
	burner cap C ø 80mm 3.5kW with central hole ID ø 32mm		
	<b>GEV No.</b>	105283	<b>Ref. No.</b> 2510354
	burner head D for burner cap ø 105mm 5.6kW		
	<b>GEV No.</b>	105284	<b>Ref. No.</b> 2510355
	burner cap ID ø 54mm D ø 105mm 5.6kW with central hole		
	<b>GEV No.</b>	105285	<b>Ref. No.</b> 2510353
	venturi D for burner cap ø 105mm 5.6kW		
	<b>GEV No.</b>	105286	<b>Ref. No.</b> 2510357
	burner head E for burner cap ø 125mm 7kW		
	<b>GEV No.</b>	105287	<b>Ref. No.</b> 2510341 2510358
	burner cap E ø 125mm 7kW with central hole		
	<b>GEV No.</b>	105288	<b>Ref. No.</b> 2510340 2510356
	venturi E for burner cap ø 125mm 7kW		
	<b>GEV No.</b>	105289	<b>Ref. No.</b> 2519002
	air mixing sleeve L 50mm ED ø 45mm ID ø 42mm aluminium		

miscellaneous



1			
<b>GEV No.</b>	105501	<b>Ref. No.</b>	136069110
<b>description</b>	flame spreader		



## gas nozzles

### main nozzles

#### gas nozzles M6x0.75



1

<b>GEV No.</b>	104778	<b>Ref. No.</b>	003090429
<b>description</b>	gas injector thread M6x0.75 WS 7 bore ø 1.45mm		

#### gas nozzles M9x1



1

<b>GEV No.</b>	100957	<b>Ref. No.</b>	016118
<b>description</b>	gas injector thread M9x1 WS 10 bore ø 0.8mm		
<b>For models:</b>	105.014, 105014		



1

<b>GEV No.</b>	100956	<b>Ref. No.</b>	016123
<b>description</b>	gas injector thread M9x1 WS 10 bore ø 1.3mm		
<b>For models:</b>	105014		

#### gas nozzles (other)



1

<b>GEV No.</b>	101942	<b>Ref. No.</b>	051123010
<b>description</b>	gas injector thread M6x1 natural gas WS 10 bore ø 1.25mm		



1

<b>GEV No.</b>	100999	<b>Ref. No.</b>	051123009
<b>description</b>	gas injector LPG		

## pilot burner nozzles

### pilot burner nozzles SIT

#### 100 series



1

<b>GEV No.</b>	100245	<b>Ref. No.</b>	016106
<b>description</b>	pilot burner nozzle LPG code 20 bore ø 0.2mm Qty 1 pcs thread M8x0.75		
<b>For models:</b>	105014		

## auxiliary gas parts

### screw connections

#### union screws



1

<b>GEV No.</b>	102506	<b>Ref. No.</b>	021295
<b>description</b>	screw connection thread M10x1 Qty 5 pcs for igniter		

## equipment-specific units

### for meat mincers

#### gearboxes



1

<b>GEV No.</b>	699296	<b>Ref. No.</b>	240309-2 A062101
<b>description</b>	gearbox ø 36mm H 60mm model K5		

### for dough mixers

#### gearboxes



1

<b>GEV No.</b>	699296	<b>Ref. No.</b>	240309-2 A062101
<b>description</b>	gearbox ø 36mm H 60mm model K5		



## for planetary mixers

### gearboxes



1

<b>GEV No.</b>	699296	<b>Ref. No.</b>	240309-2 A062101
<b>description</b>	gearbox ø 36mm H 60mm model K5		

### beaters



1

<b>GEV No.</b>	699393	<b>Ref. No.</b>	A150017
<b>description</b>	whisk shaft intake ø 12.7mm H 185mm suitable for KitchenAid		

## for hand blenders

### couplings



1

<b>GEV No.</b>	699008	<b>Ref. No.</b>	SL1496
<b>description</b>	coupling D1 ø 20mm D2 ø 23mm int. ø 1 8mm int. ø 2 8mm L 33.5mm FM3		
<b>accessories for</b>	699008		
	<b>GEV No.</b>	697417	<b>Ref. No.</b> —
<b>description</b>	grub screw thread M5 L 10mm stainless steel DIN 914/ISO 4027 WS 2.5 with spike Qty 1 pcs		

## for ice-cube maker

### cutting grid



1

<b>GEV No.</b>	480100	<b>Ref. No.</b>	0481925998215
<b>description</b>	cutting grid for ice-cube maker L 350mm W 285mm H 40mm		

## for espresso machines

### brewing units

### filter holder gaskets

### O-rings



1

<b>GEV No.</b>	510409	<b>Ref. No.</b>	0929046
<b>description</b>	O-ring EPDM thickness 5.34mm ID ø 56.52mm Qty 1 pcs		

## for pour machines

### coffee pots



1

<b>GEV No.</b>	960004	<b>Ref. No.</b>	A210.142
<b>description</b>	coffee pot 1.8l plastic/steel		

### coffee filters

### paper filters

### basket filters



1

<b>GEV No.</b>	960100	<b>Ref. No.</b>	190013
<b>description</b>	paper filter for coffee makers D1 ø 90mm D2 ø 250mm Qty 1000 pcs		

**filter pans**

filter pans

**BARTSCHER**



1

<b>GEV No.</b>	950000	<b>Ref. No.</b>	A038004 A0ND003+A040583
<b>description</b>	filter pan aluminium with percolator tube edition since year of construction 10/2007 ø 205mm H 50mm suitable for PRO 40T		
<b>For models:</b>	A190141		

**drain taps**

drain taps



1

<b>GEV No.</b>	531128	<b>Ref. No.</b>	A0ND029
<b>description</b>	outlet tap complete tube ø 19mm pipe length 22mm thread M15x1 black		
<b>For models:</b>	A190141, A190161		
<b>spare parts for</b>	531128		
	<b>GEV No.</b>	531129	<b>Ref. No.</b> A0ND032
	gasket for outlet tap H 29mm ø 14.5mm suitable for BARTSCHER		



1

<b>GEV No.</b>	531151	<b>Ref. No.</b>	A040580
<b>description</b>	outlet tap tube ø 22.5mm pipe length 52mm thread M16 black		

**components**



1

<b>GEV No.</b>	531129	<b>Ref. No.</b>	A0ND032
<b>description</b>	gasket for outlet tap H 29mm ø 14.5mm suitable for BARTSCHER		
<b>For models:</b>	A190141, A190161		

**liquid level pipes**

liquid level pipes



1

<b>GEV No.</b>	531131	<b>Ref. No.</b>	A0ND043
<b>description</b>	water level tube ED ø 12mm ID ø 10mm H 202mm for coffee machine		
<b>For models:</b>	A190141		
<b>accessories for</b>	531131		
	<b>GEV No.</b>	504297	<b>Ref. No.</b> A0ND036
	gasket for water level tube ED ø 13mm ID ø 6mm silicone		



1

<b>GEV No.</b>	531130	<b>Ref. No.</b>	A039690
<b>description</b>	water level tube ED ø 12mm ID ø 10mm H 262mm for coffee machine		
<b>For models:</b>	A190161		
<b>accessories for</b>	531130		
	<b>GEV No.</b>	504297	<b>Ref. No.</b> A0ND036
	gasket for water level tube ED ø 13mm ID ø 6mm silicone		

**accessories**

**gaskets**



1

<b>GEV No.</b>	504297	<b>Ref. No.</b>	A0ND036
<b>description</b>	gasket for water level tube ED ø 13mm ID ø 6mm silicone		
<b>For models:</b>	A190141, A190161		



miscellaneous



1

<b>GEV No.</b>	531308	<b>Ref. No.</b>	A039688 A040627
<b>description</b>	pipe L 335mm W 43mm tube ø 9mm		
<b>For models:</b>	A190161		



1

<b>GEV No.</b>	531208	<b>Ref. No.</b>	A0ND038
<b>description</b>	reset pin L 107mm W 33mm suitable for BARTSCHER		
<b>For models:</b>	A190141, A190161		

for crepes makers

accessories



1

<b>GEV No.</b>	697850	<b>Ref. No.</b>	010444614
<b>description</b>	batter spreader for crepes maker L 320mm W 275mm wood		
<b>For models:</b>	104447		



1

<b>GEV No.</b>	694339	<b>Ref. No.</b>	010444615
<b>description</b>	crêpe spatula L 430mm W 57mm thickness 4mm wood		
<b>For models:</b>	104447		

for deep fryers

lids



1

<b>GEV No.</b>	970745	<b>Ref. No.</b>	016240415
<b>description</b>	lid for fryer SS L 295mm W 215mm H 7mm		

basket holders



1

<b>GEV No.</b>	970744	<b>Ref. No.</b>	016240426
<b>description</b>	basket support for fryer L 139mm W 44mm H 8mm suitable for BARTSCHER		

miscellaneous



1

<b>GEV No.</b>	692498	<b>Ref. No.</b>	A040572
<b>description</b>	mounting set fryer		
<b>For models:</b>	A150107, A150207, A150671		

for grills

sumps



1

<b>GEV No.</b>	693206	<b>Ref. No.</b>	A016490
<b>description</b>	grease collecting tray		

1 

<b>GEV No.</b>	692237	<b>Ref. No.</b>	A041541
<b>description</b>	grease collecting tray L 357mm W 37mm H 29mm		
<b>For models:</b>	A150674		

**for hot dog machines**

water containers

1 

<b>GEV No.</b>	693169	<b>Ref. No.</b>	A042233034
<b>description</b>	water container for hot dog machine ø 205mm H 65mm		

**for panini grill**

guiding pieces

1 

<b>GEV No.</b>	699289	<b>Ref. No.</b>	A042575
<b>description</b>	support bracket mounting pos. rear L 35mm W 14mm H 12.5mm		
<b>For models:</b>	A150671, A150674		

**for contact grills**

miscellaneous

1 

<b>GEV No.</b>	701381	<b>Ref. No.</b>	A041543
<b>description</b>	handle L 350mm W 406mm H 20mm Panini		
<b>For models:</b>	A150674		

1 

<b>GEV No.</b>	692239	<b>Ref. No.</b>	A040548
<b>description</b>	spindle for contact grill L 404mm ø 12mm		
<b>For models:</b>	A150674		

**for pizza ovens**

firebricks

1 

<b>GEV No.</b>	850015	<b>Ref. No.</b>	0300180131
<b>description</b>	firebrick L 620mm W 305mm H 25mm delivery freight forwarding company only		

1 

<b>GEV No.</b>	850113	<b>Ref. No.</b>	022552
<b>description</b>	firebrick L 620mm W 610mm H 25mm delivery freight forwarding company only		

**for rechauds**

warming plates

warming plates

1 

<b>GEV No.</b>	693132	<b>Ref. No.</b>	A000800
<b>description</b>	warming plate plate size 280x155x8mm with handle suitable for PLA5/PLA12		

for rice cookers



1

<b>GEV No.</b>	694342	<b>Ref. No.</b>	A01505131
<b>description</b>	silicon insert for rice cooker ø 293mm thickness 1.3mm		

for saladettes

guide bars

1

<b>GEV No.</b>	693176	<b>Ref. No.</b>	048234001
<b>description</b>	guide bar for saladette		

for salamander grills



1

<b>GEV No.</b>	692729	<b>Ref. No.</b>	02013882
<b>description</b>	belt for salamander grill L 385mm W 13mm Hmm ED ømm ID ømm		



1

<b>GEV No.</b>	697836	<b>Ref. No.</b>	A039868
<b>description</b>	gear wheel teeth 16 shaft intake ø 8mm ø 35mm tooth width 3mm W 18mm for toaster		
<b>For models:</b>	151510		



1

<b>GEV No.</b>	692728	<b>Ref. No.</b>	02013873
<b>description</b>	spindle for salamander grill L 493mm Wmm Hmm ED ø 5mm ID ømm		

for sliding doors

door guides



1

<b>GEV No.</b>	693219	<b>Ref. No.</b>	041615
<b>description</b>	guide for sliding door aluminium		

for dishwashers

containers

dosing containers



1

<b>GEV No.</b>	361255	<b>Ref. No.</b>	0481241867008
<b>description</b>	rinse aid container		

salt tanks



1



<b>GEV No.</b>	510929	<b>Ref. No.</b>	011628 012247
<b>description</b>	salt tank ø 120mm H 117mm hose ø 10mm mounting ø 70mm overall height 157mm		

<b>spare parts for</b>	510929			
	<b>GEV No.</b>	506015	<b>Ref. No.</b>	—
	O-ring EPDM thickness 3.53mm ID ø 39.69mm Qty 1 pcs			
	<b>GEV No.</b>	510018	<b>Ref. No.</b>	—
	nut ø 92mm H 10.5mm for salt tank ID ø 64mm			
	<b>GEV No.</b>	524177	<b>Ref. No.</b>	—
	lid ø 69mm H 20mm for salt tank ID ø 50mm			





Table continues overleaf





accessories for		510929	
	GEV No.	510071	Ref. No. —
flat gasket rubber ED ø 81mm ID ø 68mm thickness 3mm for salt tank Qty 1 pcs			
	GEV No.	510654	Ref. No. —
gasket H 6mm D1 ø 82mm D2 ø 68mm			
	GEV No.	510883	Ref. No. —
gasket rubber ED ø 86mm ID ø 66mm thickness 2mm for salt tank Qty 1 pcs			



GEV No.	510032	Ref. No.	0406998
description salt tank without gasket new model			
spare parts for 510032			
	GEV No.	506015	Ref. No. —
O-ring EPDM thickness 3.53mm ID ø 39.69mm Qty 1 pcs			
	GEV No.	510018	Ref. No. —
nut ø 92mm H 10.5mm for salt tank ID ø 64mm			
	GEV No.	510071	Ref. No. —
flat gasket rubber ED ø 81mm ID ø 68mm thickness 3mm for salt tank Qty 1 pcs			
	GEV No.	524177	Ref. No. —
lid ø 69mm H 20mm for salt tank ID ø 50mm			

boilers

boilers for dishwashers

	1		
GEV No.	518379	Ref. No.	0982017
description boiler			





hood mechanics for dishwashers

guide bars

	1		
GEV No.	693174	Ref. No.	058233013
description guide bar			



air traps

air traps

	1		
GEV No.	510103	Ref. No.	011500 011672
description air trap L 85mm W 20mm H 80mm hose ø 6mm plastic			
spare parts for 510103			
	GEV No.	505045	Ref. No. —
O-ring EPDM thickness 1.78mm ID ø 5.28mm Qty 1 pcs			
	GEV No.	505094	Ref. No. —
air trap			
	GEV No.	510016	Ref. No. 011498 011675 020696
eye bolt for rinse aid container connection			
	GEV No.	510105	Ref. No. 011674
hose connector for air trap			

	1		
GEV No.	518200	Ref. No.	0984005
description air trap ø 34mm H 78mm hose ø 6mm plastic			
spare parts for 518200			
	GEV No.	504618	Ref. No. —
O-ring EPDM thickness 2.62mm ID ø 15.54mm Qty 1 pcs			
	GEV No.	510075	Ref. No. —
flat gasket rubber ED ø 22mm ID ø 13mm thickness 1.5mm Qty 1 pcs			
	GEV No.	510106	Ref. No. —
hose connector for air trap			

air trap accessories

	1		
GEV No.	510105	Ref. No.	011674
description hose connector for air trap			
spare parts for 510105			
	GEV No.	510017	Ref. No. 0468007
union screw			

## washing and rinsing systems



1

<b>GEV No.</b>	524406	<b>Ref. No.</b>	011909
<b>description</b>	bush for wash arm		



1

<b>GEV No.</b>	510016	<b>Ref. No.</b>	011498 011675 020696
<b>description</b>	eye bolt for rinse aid container connection		



1

<b>GEV No.</b>	510112	<b>Ref. No.</b>	011601
<b>description</b>	Thumb screw thread M10 thread L 10mm ø 22mm H 4.5mm SS		

## for toasters

## pliers

## pliers



1

<b>GEV No.</b>	690010	<b>Ref. No.</b>	A040894
<b>description</b>	plier for toaster H 180mm total length 100mm		
<b>For models:</b>	A151300, A151600		

## knobs

## producer-specific knobs

## BARTSCHER



1

<b>GEV No.</b>	112626 <sup>1</sup>	<b>Ref. No.</b>	A040082
<b>description</b>	knob oven t.max.°C° ø 41mm shaft ø 6x4.6mm shaft flat lower black		
<b>For models:</b>	A151300, A151600		

<sup>1</sup>with rosette 58mm

1

<b>GEV No.</b>	112622 <sup>1</sup>	<b>Ref. No.</b>	0KG20526
<b>description</b>	knob thermostat 1-10 t.max.°C° ø 41mm shaft ø 6x4.6mm shaft flat lower black		
<b>For models:</b>	A203093, A203094		

<sup>1</sup>with rosette 58mm

1

<b>GEV No.</b>	112618 <sup>1</sup>	<b>Ref. No.</b>	A040078
<b>description</b>	knob thermostat t.max. 190°C 50-190°C ø 41mm shaft ø 6x4.6mm shaft flat lower black		
<b>For models:</b>	A150107, A150207		

<sup>1</sup>with rosette 58mm

1

<b>GEV No.</b>	112617 <sup>1</sup>	<b>Ref. No.</b>	01044465A A039853
<b>description</b>	knob thermostat t.max. 300°C 50-300°C ø 41mm shaft ø 6x4.6mm shaft flat lower black		
<b>For models:</b>	104447, A150671, A150674		

<sup>1</sup>with rosette 58mm



1

<b>GEV No.</b>	112619 <sup>1</sup>	<b>Ref. No.</b>	040574
<b>description</b>	knob thermostat t.max. 80°C 30-80°C ø 41mm shaft ø 6x4.6mm shaft flat lower black		
<b>For models:</b>	103.122, 103063		

<sup>1</sup>with rosette 58mm



1

<b>GEV No.</b>	112620 <sup>1</sup>	<b>Ref. No.</b>	A0YXD1A4A09
<b>description</b>	knob thermostat t.max. 300°C 50-300°C ø 48mm shaft ø 6x4.6mm shaft flat upper black		
<b>For models:</b>	105780, A120788		

<sup>1</sup>with rosette 70mm



1

<b>GEV No.</b>	112616 <sup>1</sup>	<b>Ref. No.</b>	010578016
<b>description</b>	knob time 120min + ON t.max.°C°C ø 41mm shaft ø 6x4.6mm shaft flat lower black		
<b>For models:</b>	105780		

<sup>1</sup>with rosette 58mm



1

<b>GEV No.</b>	112621 <sup>1</sup>	<b>Ref. No.</b>	A0YXD1A4A08
<b>description</b>	knob time 120min t.max.°C°C ø 48mm shaft ø 6x4.6mm shaft flat upper black		
<b>For models:</b>	A120788		

<sup>1</sup>with rosette 70mm



1

<b>GEV No.</b>	112624 <sup>1</sup>	<b>Ref. No.</b>	A040898
<b>description</b>	knob time 15min t.max.°C°C ø 41mm shaft ø 6mm shaft flat black rosette ø 58mm		
<b>For models:</b>	A151300, A151600		

<sup>1</sup>with rosette 58mm

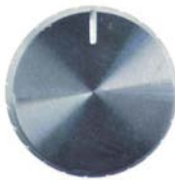

1

<b>GEV No.</b>	112535	<b>Ref. No.</b>	01143562
<b>description</b>	knob switch zero mark t.max.°C°C ø 23mm shaft ø 6x4.6mm shaft flat upper silver		



1

<b>GEV No.</b>	112625 <sup>1</sup>	<b>Ref. No.</b>	A040899
<b>description</b>	knob time 15min t.max.°C°C ø 41mm shaft ø 6x4.6mm shaft flat lower black		
<b>For models:</b>	A151300, A151600		

<sup>1</sup>with rosette 58mm



1

<b>GEV No.</b>	112537	<b>Ref. No.</b>	A02011006
<b>description</b>	knob switch zero mark t.max.°C°C ø 41mm shaft ø 6x4.6mm shaft flat left black		



1

<b>GEV No.</b>	112533 <sup>1</sup>	<b>Ref. No.</b>	OAT93617 A0AT93617 EB-600-00
<b>description</b>	knob energy regulator t.max.°C°C ø 48mm shaft ø 6x4.6mm shaft flat upper black		
<b>For models:</b>	151510, A1515001		

<sup>1</sup>with rosette 70mm



1

<b>GEV No.</b>	112649 <sup>1</sup>	<b>Ref. No.</b>	016240421
<b>description</b>	knob switch zero mark t.max.°C°C ø 50mm shaft ø 6x4.6mm shaft flat upper black		
<b>accessories for</b>	112649		
	<b>GEV No.</b>	<b>Ref. No.</b>	016240423
	slide ring ø 50mm black plastic for knob		

<sup>1</sup>with rosette 55mm



1

<b>GEV No.</b>	112653	<b>Ref. No.</b>	016240423
<b>description</b>	slide ring ø 50mm black plastic for knob		
<b>accessories for</b>	112653		
	<b>GEV No.</b>	112649	<b>Ref. No.</b> 016240421
	knob switch zero mark t.max.°C° 50mm shaft ø 6x4.6mm shaft flat upper black		

accessories

rosettes



1

<b>GEV No.</b>	112058	<b>Ref. No.</b>	003Q677
<b>description</b>	rosette gas tap with ignition flame knob		



1

<b>GEV No.</b>	111897	<b>Ref. No.</b>	065043001
<b>description</b>	rosette knob		

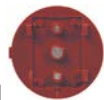

1

<b>GEV No.</b>	112049	<b>Ref. No.</b>	065043002
<b>description</b>	rosette knob		

handles and hand wheels

cylindrical handles

fixed



1

<b>GEV No.</b>	693170	<b>Ref. No.</b>	A030012157
<b>description</b>	cylindrical handle for lid		

cone handles



1

<b>GEV No.</b>	697834	<b>Ref. No.</b>	A040576
<b>description</b>	cone handle thread M6x1 ø 13mm plastic L 53mm black thread L 6mm		
<b>For models:</b>	A150107, A150207		

mushroom cap handles



1

<b>GEV No.</b>	111441	<b>Ref. No.</b>	016240439
<b>description</b>	mushroom cap handle with screw thread M4 handle ø 28mm L 24mm black for lid		

handle bars

handle bars



1

<b>GEV No.</b>	692128	<b>Ref. No.</b>	010578060
<b>description</b>	handle rod tube ø 19mm L 690mm stainless steel		
<b>For models:</b>	105780		
<b>accessories for</b>	692128		
	<b>GEV No.</b>	694306	<b>Ref. No.</b> A0308983
	console for handle rod tube ø 17mm plastic mounting pos. left/right Qty 1 pcs		

1

<b>GEV No.</b>	694307	<b>Ref. No.</b>	A0YXD1A34
<b>description</b>	handle rod tube ø 19mm thickness 1mm L 453mm SS		
<b>For models:</b>	A120788		



## consoles



<b>GEV No.</b>	694306	<b>Ref. No.</b>	A0308983
<b>description</b>	console for handle rod tube ø 17mm plastic mounting pos. left/right Qty 1 pcs		
<b>For models:</b>	105780, A120788		
<b>accessories for</b>	694306		
	<b>GEV No.</b>	692128	<b>Ref. No.</b>
			010578060
	handle rod tube ø 19mm L 690mm stainless steel		

## bracket handles



<b>GEV No.</b>	697997	<b>Ref. No.</b>	A0ND006
<b>description</b>	handle L 107mm H 20mm mounting distance 60mm for container ø 20mm W 46mm black		
<b>For models:</b>	A190141, A190161		



<b>GEV No.</b>	698580	<b>Ref. No.</b>	A0ND001
<b>description</b>	pull handle L 114mm H 33mm mounting distance 106mm thread M3 W 30mm		
<b>For models:</b>	A190141, A190161		



<b>GEV No.</b>	691510	<b>Ref. No.</b>	016210828 A040575
<b>description</b>	pull handle L 130mm H 44mm mounting distance 112mm		
<b>For models:</b>	103.122, 103063, A150107, A150207		



<b>GEV No.</b>	698563	<b>Ref. No.</b>	A0ND024
<b>description</b>	pull handle L 144mm H 42mm mounting distance 136mm thread M3 W 32mm		



<b>GEV No.</b>	700965	<b>Ref. No.</b>	A039859 EB-600-18
<b>description</b>	pull handle L 275mm H 60mm mounting distance 197mm thread M8x1.25		
<b>For models:</b>	151510, EB600		

## folding grill handles



<b>GEV No.</b>	693178	<b>Ref. No.</b>	040212006
<b>description</b>	folding grill handle		



<b>GEV No.</b>	693253	<b>Ref. No.</b>	0A040212002
<b>description</b>	folding grill handle		



<b>GEV No.</b>	692149	<b>Ref. No.</b>	A0GH81334
<b>description</b>	handle L 155mm ø 30mm seat ø 10mm for contact grill		
<b>For models:</b>	A150671, A150674		

## recessed handles



<b>GEV No.</b>	697995	<b>Ref. No.</b>	016240427
<b>description</b>	recessed handle L 90mm W 60mm H 23.5mm mounting distance 75mm plastic for fryer		



miscellaneous

			
1			
<b>GEV No.</b>	691511	<b>Ref. No.</b>	A02011007
<b>description</b>	door handle L 160mm W 36mm hole distance 116mm		

			
1			
<b>GEV No.</b>	701455	<b>Ref. No.</b>	65131014
<b>description</b>	oven hinge mounting distance 118mm lug mounting 13mm lever length 117mm groove distance 11mm spring thickness 4mm mounting ear position right spring length 55mm L 155mm W 22mm		

hinges

oven hinges

			
1			
<b>GEV No.</b>	701380	<b>Ref. No.</b>	0A0YXD4A42
<b>description</b>	hinge mounting distance 142mm lever length 116mm groove distance 7mm spring thickness 3.5mm mounting ear position L 155mm W 19mm		
<b>For models:</b>	A120788		

			
1			
<b>GEV No.</b>	701404	<b>Ref. No.</b>	06532728
<b>description</b>	oven hinge mounting distance 118mm mounting distance 2mm lug mounting 14mm lever length 117mm groove distance 11mm spring thickness 4mm mounting ear position left/right spring length 55mm L 155mm mounting pos. W 22mm		

			
1			
<b>GEV No.</b>	701454	<b>Ref. No.</b>	65131015
<b>description</b>	oven hinge mounting distance 118mm lug mounting 13mm lever length 117mm groove distance 11mm spring thickness 4mm mounting ear position left spring length 55mm L 155mm W 22mm		

			
1			
<b>GEV No.</b>	701217	<b>Ref. No.</b>	0CER001
<b>description</b>	oven hinge mounting distance 142mm lever length 118mm groove distance 10mm spring thickness 3.5mm spring length 57mm L 155mm mounting pos. left/right W 21mm		



<b>GEV No.</b>	700000	<b>Ref. No.</b>	01057803
<b>description</b>	oven hinge mounting distance 142mm mounting distance 2mm lug mountingmm lever length 127mm groove distance 10mm spring thickness 3.7mm mounting ear position L 155mm mounting pos. left/right		
<b>For models:</b>	105780		
<b>accessories for</b>	700000		
	<b>GEV No.</b>	693045	<b>Ref. No.</b> —
	opposite support L 110mm W 12mm mounting distance 94mm		
	<b>GEV No.</b>	700707	<b>Ref. No.</b> —
	opposite support mounting distance 94mm L 140mm mounting pos. left W 13mm with welded metal sheet H 110mm for hinge		

<b>GEV No.</b>	700006	<b>Ref. No.</b>	022752
<b>description</b>	oven hinge mounting distance 173mm mounting distance 2 105mm lug mounting 14mm lever length 120mm groove distance 11mm spring thickness 3.5mm mounting ear position left spring length 112mm W 25mm		
<b>accessories for</b>	700006		
	<b>GEV No.</b>	700001	<b>Ref. No.</b> —
	opposite support L 118mm W 17mm mounting distance 94mm		
	<b>GEV No.</b>	700007	<b>Ref. No.</b> 022751
	oven hinge mounting distance 173mm mounting distance 2 105mm lug mounting 14mm lever length 120mm groove distance 11mm spring thickness 3.5mm mounting ear position right spring length 112mm W 25mm		

<b>GEV No.</b>	700007	<b>Ref. No.</b>	022751
<b>description</b>	oven hinge mounting distance 173mm mounting distance 2 105mm lug mounting 14mm lever length 120mm groove distance 11mm spring thickness 3.5mm mounting ear position right spring length 112mm W 25mm		
<b>accessories for</b>	700007		
	<b>GEV No.</b>	700001	<b>Ref. No.</b> —
	opposite support L 118mm W 17mm mounting distance 94mm		

miscellaneous

<b>GEV No.</b>	700926	<b>Ref. No.</b>	040607
<b>description</b>	door hinge L 75mm W 60mm mounting distance 48mm		
<b>For models:</b>	103.122, 103063		

fittings for catering equipment

outlet taps

universal

<b>GEV No.</b>	697834	<b>Ref. No.</b>	A040576
<b>description</b>	cone handle thread M6x1 $\varnothing$ 13mm plastic L 53mm black thread L 6mm		
<b>For models:</b>	A150107, A150207		

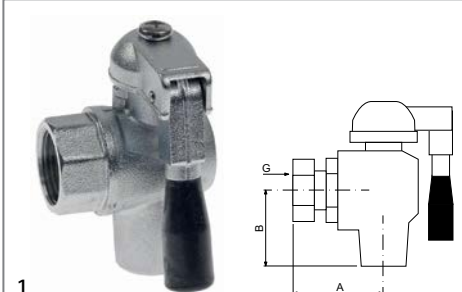

1

<b>GEV No.</b>	541540	<b>Ref. No.</b>	016210829 A040578
<b>description</b>	outlet tap stainless steel W 38mm H 40mm thread 3/4" IT		
<b>For models:</b>	A150107, A150207		
<b>spare parts for</b>	541540		
	<b>GEV No.</b>	<b>Ref. No.</b>	A040576
	cone handle thread M6x1 ø 13mm plastic L 53mm black thread L 6mm		



1

<b>GEV No.</b>	692499	<b>Ref. No.</b>	016210831 A041308
<b>description</b>	reducer L 46mm thread 1/2" ET / 3/4" ET ø 26mm		
<b>For models:</b>	A150107, A150207		



1

<b>GEV No.</b>	541749	<b>Ref. No.</b>	016210830
<b>description</b>	rosette for outlet tap thread D1 ø 63mm D2 ø 25mm		
<b>For models:</b>	A150207		

### dispenser tap

#### complete



1

<b>GEV No.</b>	527165	<b>Ref. No.</b>	A040375
<b>description</b>	outlet tap complete ø 40mm inlet 3/8" plastic black		

## equipment feet and end caps

### equipment feet

#### with screw mounting



1

<b>GEV No.</b>	513287	<b>Ref. No.</b>	0926117
<b>description</b>	equipment foot tube ø 60mm thread M12 thread L 33mm H 155-235mm SS size 2" Qty 1 pcs		

#### screw-in feet



1

<b>GEV No.</b>	693204	<b>Ref. No.</b>	047122001
<b>description</b>	equipment foot hot bar		



1

<b>GEV No.</b>	700966	<b>Ref. No.</b>	A038973
<b>description</b>	equipment foot thread L 20mm ø 37mm H 20mm Qty 1 pcs		
<b>For models:</b>	105780, A120788		



1

<b>GEV No.</b>	693133	<b>Ref. No.</b>	030012167
<b>description</b>	equipment foot thread M10 saladette		





1

<b>GEV No.</b>	693139	<b>Ref. No.</b>	031136
<b>description</b>	equipment foot thread M8 BETA I/II		



## bolting feet

 <p>1</p>			
<b>GEV No.</b>	697849	<b>Ref. No.</b>	01044461
<b>description</b>	equipment foot H 28mm thread M8 D1 ø 50mm D2 ø 38mm thread L 10mm		
<b>For models:</b>	104447		

 <p>1</p>			
<b>GEV No.</b>	697996	<b>Ref. No.</b>	016240431
<b>description</b>	equipment foot ø 23mm H 23.5mm bore ø 5mm Qty 1 pcs		

 <p>1</p>			
<b>GEV No.</b>	697998	<b>Ref. No.</b>	01058356
<b>description</b>	equipment foot ø 24/36mm H 25mm bore ø 19mm Qty 1 pcs thread M8x1.25		

 <p>1</p>			
<b>GEV No.</b>	691509	<b>Ref. No.</b>	0AT93602 A042567 A0AT93602 EB-600-04
<b>description</b>	equipment foot ø 28mm H 17.5mm rubber bore ø 6mm Qty 1 pcs		
<b>For models:</b>	151510, A114001, A150107, A150207, A150671, A150674, A151300, A1515001, A151600, A203093, A203094, EB600		

## baskets

### fryer baskets

#### BARTSCHER

 <p>1</p>			
<b>GEV No.</b>	970741	<b>Ref. No.</b>	016240416 165513 165519 165522
<b>description</b>	fryer basket W1 140mm L1 210mm H1 125mm chrome-plated steel		

 <p>1</p>			
<b>GEV No.</b>	970811	<b>Ref. No.</b>	165514 165520 165523
<b>description</b>	fryer basket W1 190mm L1 240mm H1 145mm L2 445mm H2 170mm H3 280mm chrome-plated steel plastic		

 <p>1</p>			
<b>GEV No.</b>	970716	<b>Ref. No.</b>	016210815 165516 A040571
<b>description</b>	fryer basket W1 192mm L1 230mm H1 140mm L2 470mm H2 200mm H3 220mm		
<b>For models:</b>	A150107, A150207		

 <p>1</p>			
<b>GEV No.</b>	970825	<b>Ref. No.</b>	165518
<b>description</b>	fryer basket W1 192mm L1 230mm H1 142mm L2 460mm H2 195mm H3 230mm stainless steel		

 <p>1</p>			
<b>GEV No.</b>	697833	<b>Ref. No.</b>	A041303
<b>description</b>	handle for fryer basket L 142mm H 21mm W 39mm		
<b>For models:</b>	A150107, A150207		

## crumb screens

 <p>1</p>			
<b>GEV No.</b>	970743	<b>Ref. No.</b>	016210816 A041310
<b>description</b>	crumb screen L 245mm W 205mm H 5mm chrome-plated steel for fryer		
<b>For models:</b>	A150107, A150207		



1

<b>GEV No.</b>	970742	<b>Ref. No.</b>	016240418
<b>description</b>	crumb screen L 216mm W 149mm H 37mm chrome-plated steel for fryer		

miscellaneous



Image not available

1

<b>GEV No.</b>	693209	<b>Ref. No.</b>	A030048022V
<b>description</b>	basket without bottom		

shelves and shelf rails

grates

producer-specific

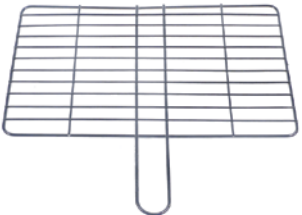

1

<b>GEV No.</b>	970715	<b>Ref. No.</b>	A040581
<b>description</b>	chargrill grid W 223mm D 352mm H 9mm chrome-plated steel with handle for toaster wire gauge frame 4mm lengthwise wires gauge 2.5mm crossing wires 4 BARTSCHER		
<b>For models:</b>	A151300, A151600		

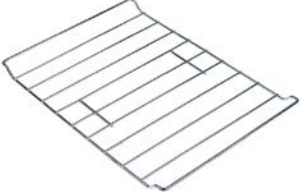

1

<b>GEV No.</b>	210198	<b>Ref. No.</b>	A030048044
<b>description</b>	chargrill grid W 245mm D 346mm chrome-plated steel		

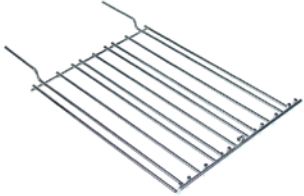

1

<b>GEV No.</b>	210200	<b>Ref. No.</b>	030048019
<b>description</b>	chargrill grid W 250mm D 315mm		



1

<b>GEV No.</b>	210201	<b>Ref. No.</b>	030048021
<b>description</b>	chargrill grid W 250mm D 315mm		



1

<b>GEV No.</b>	210260	<b>Ref. No.</b>	OAT93606 A0AT93606
<b>description</b>	chargrill grid W 250mm D 450mm chrome-plated steel with handle suitable for salamander grill		
<b>For models:</b>	A1515001		

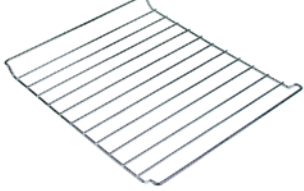

1

<b>GEV No.</b>	210197	<b>Ref. No.</b>	A030048042
<b>description</b>	chargrill grid W 290mm D 357mm chrome-plated steel		



1

<b>GEV No.</b>	210199	<b>Ref. No.</b>	A030048043
<b>description</b>	chargrill grid W 290mm D 397mm chrome-plated steel		

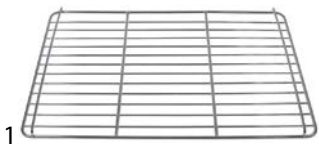

<b>GEV No.</b>	970813	<b>Ref. No.</b>	786002 786005
<b>description</b>	chargrill grid W 315mm D 435mm H 15mm chrome-plated steel L 315mm crossing wires 2		

## gaskets

### refrigeration gaskets

#### plug-in gaskets

##### profile 9399

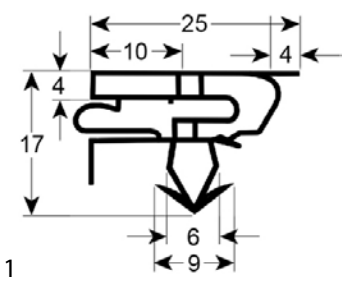

<b>GEV No.</b>	902156	<b>Ref. No.</b>	0700075
<b>description</b>	refrigeration gasket profile 9399 W 415mm L 430mm plug size		

#### screw-in gaskets

##### profile 9031

We offer custom-made gaskets for this profile

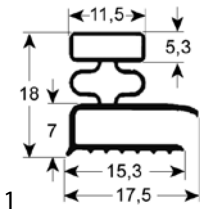

<b>GEV No.</b>	900266	<b>Ref. No.</b>	030012200
<b>description</b>	refrigeration gasket profile 9031 W 440mm L 600mm external size		

##### profile 9970

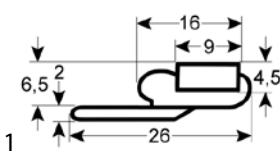

<b>GEV No.</b>	902470	<b>Ref. No.</b>	038275
<b>description</b>	refrigeration gasket profile 9970 W 420mm L 505mm external size		
<b>For models:</b>	700158G-McDonalds		

### gaskets for heated units

#### door seals with fixing hook



<b>GEV No.</b>	901178	<b>Ref. No.</b>	010578049
<b>description</b>	door seal L 330mm W 680mm with 12 holes type series until 03/2013		
<b>For models:</b>	105780		



<b>GEV No.</b>	901946	<b>Ref. No.</b>	012078919
<b>description</b>	door seal W 320mm with 8 mounting clips H 260mm		



<b>GEV No.</b>	900264	<b>Ref. No.</b>	A030044013
<b>description</b>	door seal W 360mm with mounting clip H 225mm		



<b>GEV No.</b>	900265	<b>Ref. No.</b>	030044015
<b>description</b>	door seal W 405mm long side open with mounting clip H 245mm		



1

<b>GEV No.</b>	901842	<b>Ref. No.</b>	0105780491
<b>description</b>	door seal W 680mm H 330mm type series since 03/2013 16 holes		

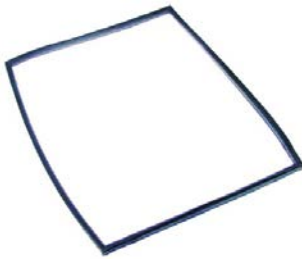

1

<b>GEV No.</b>	900393	<b>Ref. No.</b>	030004007
<b>description</b>	oven gasket L 330mm W 420mm external size		



1

<b>GEV No.</b>	901354	<b>Ref. No.</b>	A038980
<b>description</b>	oven gasket L 430mm W 330mm with 8 mounting clips		
<b>For models:</b>	A120788		

O-rings

EPDM

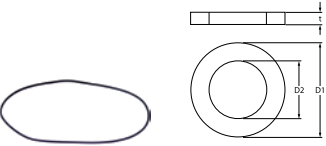

1

<b>GEV No.</b>	521717	<b>Ref. No.</b>	019380 021858
<b>description</b>	O-ring EPDM thickness 1.78mm ID ø 120.37mm Qty 1 pcs		

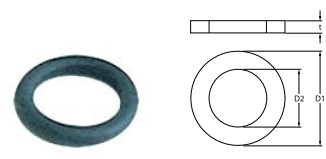

1

<b>GEV No.</b>	529412	<b>Ref. No.</b>	011499 011676 011677 0456048
<b>description</b>	O-ring EPDM thickness 2.62mm ID ø 10.78mm Qty 1 pcs		

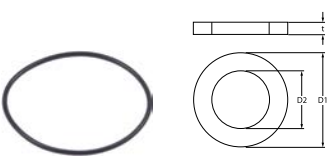

1

<b>GEV No.</b>	532618	<b>Ref. No.</b>	016240424
<b>description</b>	O-ring EPDM thickness 2mm ID ø 48.5mm Qty 1 pcs		

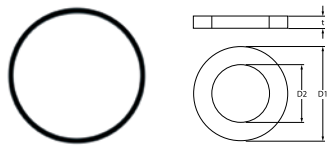

1

<b>GEV No.</b>	510009	<b>Ref. No.</b>	011691
<b>description</b>	O-ring EPDM thickness 3.53mm ID ø 101.2mm Qty 1 pcs		

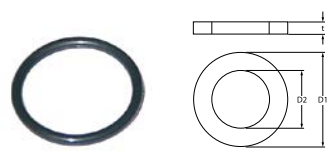

1

<b>GEV No.</b>	510072	<b>Ref. No.</b>	011630 012249 0456016
<b>description</b>	O-ring EPDM thickness 3.53mm ID ø 32.93mm Qty 1 pcs		

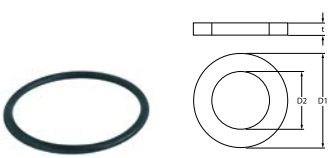

1

<b>GEV No.</b>	532118	<b>Ref. No.</b>	021145 214289
<b>description</b>	O-ring EPDM thickness 3.53mm ID ø 55.56mm Qty 10 pcs		



1

<b>GEV No.</b>	532498	<b>Ref. No.</b>	0456047
<b>description</b>	O-ring EPDM thickness 3.53mm ID ø 9.12mm Qty 1 pcs		

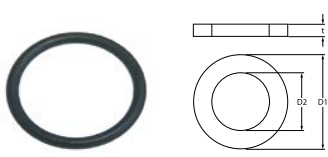

1

<b>GEV No.</b>	510408	<b>Ref. No.</b>	011510 011620
<b>description</b>	O-ring EPDM thickness 5.34mm ID ø 47mm Qty 1 pcs		

1			
<b>GEV No.</b>	510409	<b>Ref. No.</b>	0929046
<b>description</b>	O-ring EPDM thickness 5.34mm ID ø 56.52mm Qty 1 pcs		

<b>Viton</b>			
1			
<b>GEV No.</b>	532504	<b>Ref. No.</b>	030010104
<b>description</b>	O-ring Viton thickness 2.62mm ID ø 20.24mm Qty 1 pcs		

1			
<b>GEV No.</b>	550496	<b>Ref. No.</b>	049671
<b>description</b>	O-ring Viton thickness 3.53mm ID ø 50.39mm Qty 1 pcs		

## sealing washers

<b>fibre gaskets</b>			
1			
<b>GEV No.</b>	529160	<b>Ref. No.</b>	004652632
<b>description</b>	flat gasket fibre ED ø 32mm ID ø 26mm thickness 1.5mm for drain tap suitable for 541540 Qty 1 pcs		
<b>For models:</b>	A150107, A150207		

1			
<b>GEV No.</b>	510405	<b>Ref. No.</b>	012291
<b>description</b>	flat gasket fibre ED ø 56mm ID ø 42mm thickness 2mm for thread 1¼" Qty 1 pcs		

<b>rubber gaskets</b>			
1			
<b>GEV No.</b>	513059	<b>Ref. No.</b>	0437063
<b>description</b>	flat gasket rubber ED ø 52mm ID ø 40mm thickness 3mm Qty 1 pcs		

1			
<b>GEV No.</b>	521124	<b>Ref. No.</b>	0481946669609
<b>description</b>	flat gasket rubber ED ø 52mm ID ø 42mm thickness 6mm Qty 1 pcs		

1			
<b>GEV No.</b>	518060	<b>Ref. No.</b>	0456040
<b>description</b>	gasket rubber ED ø 132mm ID ø 122mm thickness 5mm		

## PTFE gaskets

1			
<b>GEV No.</b>	510012	<b>Ref. No.</b>	011662
<b>description</b>	flat gasket PTFE ED ø 16.5mm ID ø 12.5mm thickness 1.5mm Qty 1 pcs equiv. no. 437008		

## silicone gaskets

1			
<b>GEV No.</b>	504296	<b>Ref. No.</b>	A040382
<b>description</b>	flat gasket silicone ED ø 29mm ID ø 12mm thickness 1.6mm Qty 1 pcs for coffee machine		
<b>For models:</b>	A190141, A190161		

1			
<b>GEV No.</b>	511646	<b>Ref. No.</b>	A0ND011
<b>description</b>	gasket silicone ED ø 63mm ID ø 55mm thickness 2.3mm Qty 1 pcs for heating element		
<b>For models:</b>	A190141, A190161		

## special gaskets

<b>miscellaneous</b>			
1			
<b>GEV No.</b>	504297	<b>Ref. No.</b>	A0ND036
<b>description</b>	gasket for water level tube ED ø 13mm ID ø 6mm silicone		
<b>For models:</b>	A190141, A190161		



### thermostat gaskets



<b>GEV No.</b>	512205	<b>Ref. No.</b>	016240433
<b>description</b>	gasket for temperature probe ED ø 15mm plastic Qty 1 pcs		

## transmission technology and ball bearings

### chains

#### roller chains 04B-1 single



<b>GEV No.</b>	697844	<b>Ref. No.</b>	A039870
<b>description</b>	chain DIN/ISO 04 B-1 splitting 6mm links 58 L 365mm internal width 2.8mm rollerø 4mm single		
<b>For models:</b>	151510		

## springs

### torsion springs



<b>GEV No.</b>	700569	<b>Ref. No.</b>	A0GH81313
<b>description</b>	torsion spring ø 21.5mm L2 40mm wire gauge ø 3.3mm L1 100mm L3 45mm		
<b>For models:</b>	A150671, A150674		

### compression springs



<b>GEV No.</b>	112063	<b>Ref. No.</b>	0011564
<b>description</b>	knob spring ø 24mm L 28mm wire gauge ø 0.9mm		

### tension springs



<b>GEV No.</b>	693175	<b>Ref. No.</b>	030014013
<b>description</b>	tension spring total length 330mm		

## kitchen accessories

### gastronorm

#### bridges



<b>GEV No.</b>	693210	<b>Ref. No.</b>	047233076
<b>description</b>	bridge for Gastronorm container		





Image not available

<b>GEV No.</b>	693218	<b>Ref. No.</b>	047233173
<b>description</b>	bridge for Gastronorm container		

### baking sheets



<b>GEV No.</b>	693167	<b>Ref. No.</b>	031165
<b>description</b>	baking sheet suitable for BETA I/II		



<b>GEV No.</b>	694532	<b>Ref. No.</b>	100 403 100.303
<b>description</b>	baking sheet W 325mm L 530mm perforated		







## dosing pumps

### piston pumps

#### with solenoid coil



1

<b>GEV No.</b>	361013	<b>Ref. No.</b>	010799
<b>description</b>	dosing pump inlet 4x6mm outlet 5mm 230V rinse aid duty cycle 25% type EKP-M 50Hz impulse 3imp/s		
<b>spare parts for</b>	361013		
	<b>GEV No.</b>	361482	<b>Ref. No.</b> —
	solenoid coil 230VAC for type EKP-M		
	<b>GEV No.</b>	361811	<b>Ref. No.</b> —
	hose connector for dosing pump hose ø 6.3mm T1: M12x1.5 chrome-plated brass		
	<b>GEV No.</b>	371090	<b>Ref. No.</b> —
	power socket plug type DIN 43650A screw		
<b>accessories for</b>	361013		
	<b>GEV No.</b>	361366	<b>Ref. No.</b> —
	PCB dishwasher 11F suitable for DB2 type DB2/EV1/EKP-M		
	<b>GEV No.</b>	361505	<b>Ref. No.</b> —
	screw pipe fitting straight nickel-plated brass thread 3/8" IT hose ø 6x8mm		

#### spare parts

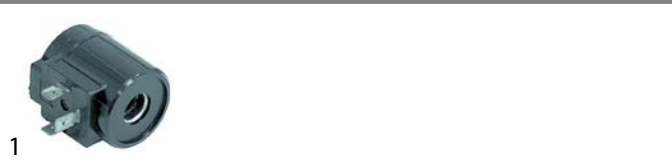

1

<b>GEV No.</b>	361113	<b>Ref. No.</b>	011525 011639
<b>description</b>	solenoid coil 230VAC for type DB2		





## membrane dosing pumps

### self-priming

#### SEKO



1

<b>GEV No.</b>	361364 <sup>1</sup>	<b>Ref. No.</b>	0209025
<b>description</b>	dosing pump type DIB5E self-sucking rinse aid pump rate 0-5cm <sup>3</sup> per stroke pressure connection ø 4x6mm suction connection ø 4x6mm SEKO supporting pressure closed		
<b>spare parts for</b>	361364		
	<b>GEV No.</b>	361301	<b>Ref. No.</b> —
	hose connector for type DIB3E/DIB5E		
	<b>GEV No.</b>	361302	<b>Ref. No.</b> —
	valve bush for type DIB3E/DIB5E		
	<b>GEV No.</b>	361304	<b>Ref. No.</b> —
	O-ring EPDM ID ø 11.11mm thickness 1.78mm Qty 1 pcs for type DIB3E/DIB5E		
	<b>GEV No.</b>	361305	<b>Ref. No.</b> —
	valve disc for type DIB3E/DIB5E DIB3P/DIB5P		
	<b>GEV No.</b>	361306	<b>Ref. No.</b> —
	membrane for type DIB3E/DIB5E ø 49mm hole ø 5mm		
	<b>GEV No.</b>	361307	<b>Ref. No.</b> —
	membrane dosing pump ø 68mm hole ø 6mm for type DIB3P/DIB5P		
	<b>GEV No.</b>	361459	<b>Ref. No.</b> —
	hose connector ø 6mm for dosing pump		
	<b>GEV No.</b>	361481	<b>Ref. No.</b> —
	lip valve for type DIB3P/DIB5P DIB3E/DIB5E		
<b>accessories for</b>	361364		
	<b>GEV No.</b>	361240	<b>Ref. No.</b> —
	hose connector 1-way hose ø 6mm plastic connection M10x1		
	<b>GEV No.</b>	361241	<b>Ref. No.</b> —
	hose connector 1-way hose ø 9mm plastic connection M10x1		

<sup>1</sup>auxiliary pressure connection closed





## hoses

### drain hoses



1

<b>GEV No.</b>	518068	<b>Ref. No.</b>	020453
<b>description</b>	drain hose DN34 L 2000mm elbow ø inside 50mm elbow ext. ø 59mm inner hose ø 35mm outer hose ø 42mm PVC		

### industrial hoses

#### Niplaflex hoses



1

<b>GEV No.</b>	570561	<b>Ref. No.</b>	011637
<b>description</b>	pressure hose ID ø 10mm ED ø 17mm L 40m thickness 3.5mm operating p. 10bar burst p. 30bar t.max. 110°C		



1

<b>GEV No.</b>	530561	<b>Ref. No.</b>	011503
<b>description</b>	pressure hose ID ø 10mm ED ø 17mm L 5m thickness 3.5mm operating p. 10bar burst p. 30bar t.max. 110°C		

## ancillary products

### clamps

#### hose clamps

##### DIN 3017 - W2



1

<b>GEV No.</b>	520110	<b>Ref. No.</b>	0423010 neu 21.05.96
<b>description</b>	hose clamp ø 8-12mm width 9mm Qty 10 pcs DIN 3017		

## measuring equipment

### thermometers

#### thermometers with core sensor



1

<b>GEV No.</b>	541096	<b>Ref. No.</b>	A293043
<b>description</b>	penetration thermometer L 139mm -50 up to +300°C display digital ø 35mm NTC probe L 120mm		



1

<b>GEV No.</b>	541097	<b>Ref. No.</b>	A292044
<b>description</b>	penetration thermometer L 143mm -10 up to 100°C t.max. 100°C display analogue ø 27mm probe L 120mm		

#### miscellaneous



1

<b>GEV No.</b>	541093	<b>Ref. No.</b>	A292048
<b>description</b>	thermometer -30 up to +30°C size ø60mm display analogue		

1

<b>GEV No.</b>	541098	<b>Ref. No.</b>	A292049
<b>description</b>	thermometer -30 up to +50°C size ø52mm display analogue		



1

<b>GEV No.</b>	541094	<b>Ref. No.</b>	A292043
<b>description</b>	thermometer -40 up to +25°C size 124x30mm display analogue		

## fastening material

### screws

#### knurled screws



1

<b>GEV No.</b>	510112	<b>Ref. No.</b>	011601
<b>description</b>	Thumb screw thread M10 thread L 10mm ø 22mm H 4.5mm SS		

### nuts

#### hexagonal nuts

#### hexagonal nuts inch thread



1

<b>GEV No.</b>	501318	<b>Ref. No.</b>	152-2
<b>description</b>	nut thread 1/4" H 6.5mm SS WS 22 Qty 1 pcs		

## fasteners

### clamps

#### hose clamps

#### DIN 3017 - W2



1

<b>GEV No.</b>	520110	<b>Ref. No.</b>	0423010 neu 21.05.96
<b>description</b>	hose clamp ø 8-12mm width 9mm Qty 10 pcs DIN 3017		

### roll pins



1

<b>GEV No.</b>	692236	<b>Ref. No.</b>	A0GH81316
<b>description</b>	roll pin ø 4mm L 40mm		
<b>For models:</b>	A150671, A150674		

## consumables

### coffee filters

#### basket filters

#### paper filters



1

<b>GEV No.</b>	960100	<b>Ref. No.</b>	190013
<b>description</b>	paper filter for coffee makers D1 ø 90mm D2 ø 250mm Qty 1000 pcs		

### fuses

#### fine fuses



1

<b>GEV No.</b>	358533	<b>Ref. No.</b>	01143561
<b>description</b>	fine fuse size ø5x20mm 6.3A fast-acting rated 250V Qty 10 pcs		



<b>A</b>			
axial fans		37	
<b>B</b>			
bar burners		58	
bi-metal thermostats		17, 18	
<b>C</b>			
cam switches		26	
clamps		24, 80, 81	
coffee filters		81	
compressors		37	
condensators & interference suppression filters		41	
consumables		81	
contactors		32	
control thermostats		18, 22	
cross flow fans		37	
<b>D</b>			
door seals with fixing hook		75	
dosing pumps		79	
drain hoses		80	
drain pumps		41	
<b>E</b>			
electric accessories		42	
electric timers		30	
energy regulators		17	
<b>F</b>			
fans		37	
fasteners		81	
fastening material		81	
filters		41	
fine fuses		81	
fluorescent lamps		29	
fuses		42, 81	
<b>G</b>			
gas burners		48	
gas control valves		46	
gas nozzles		59	
gas taps		42	
gas thermostats		43	
gaskets for heated units		75	
gastronorm		78	
grates		74	
<b>H</b>			
halogen lamp		29	
heating elements		3	
heating elements for bain maries		4	
heating elements for charrills		10	
heating elements for chip scuttles		5	
heating elements for coffee machine		7	
heating elements for contact grills		8	
heating elements for convection		14	
heating elements for fryers		5	
heating elements for griddles		7	
heating elements for heated cabinets		11	
heating elements for heating bridges		11	
heating elements for ovens		3	
heating elements for pizza ovens		9	
heating elements for salamanders/toasters		10	
heating elements for tilting bratt pan		8	
heating plates		12	
hexagonal nuts		81	
hob burners		48	
hose clamps		80, 81	
hoses		80	
hot air fans		38	
hot air motors		38	
hot plates		16	
<b>I</b>			
ignition boxes		46	
immersion heating elements		12	
indicator lights		27	
indicator lights (complete)		27	
induction coils		3	
industrial hoses		80	
<b>K</b>			
knurled screws		81	
<b>L</b>			
lamps		27	
light bulbs		29	
<b>M</b>			
magnetic switches		27	
magnetrons		33	
measuring equipment		80	
mechanical timers		31	
microswitches		25	
motors		39	
<b>N</b>			
Niplaflex hoses		80	
nuts		81	
<b>O</b>			
operating capacitors		41	
O-rings		76	
oven hinges		70	

oven lamps	29
<b>P</b>	
pilot burners	46
plug-in gaskets	75
pressure switches	36
probe clips	24
probes	33
programme timers	30
pumps	40
push/momentary push switches	25
<b>Q</b>	
quartz heating elements	12
<b>R</b>	
radiation heaters	16
refrigeration fans	37
refrigeration gaskets	75
refrigeration thermostats	24
relays	32
rocker/momentary rocker switches	24
rod thermostats	24
roll pins	81
rotary switches	27
<b>S</b>	
safety bi-metal thermostats	17
safety rod thermostats	24
safety thermostats	21
screw-in gaskets	75
screws	81
sealing washers	77
shelves and shelf rails	74
solenoid valves	35
solid top burners	58
switches and momentary switches	24
system switches (ROLD)	26
<b>T</b>	
terminals	42
thermocouples	48
thermostat gaskets	78
thermostats	17
timers	30
toggle switches	25
<b>W</b>	
wash and rinse pumps	40