



GAS COMPONENTS



ELECTRIC COMPONENTS



WATER TECHNOLOGY



MECHANICAL COMPONENTS



TOOLS

Spare parts suitable for

BARON

Find the complete and up-to-date range of products in our GEV Webshop



Manufacturer catalogue

The most important spare parts and accessories arranged clearly for every manufacturer

- ✓ Complete product range and all appliance data always up to date in the GEV Webshop
- ✓ Alphabetical Index at the end of the catalogue

GEV Webshop

www.gev-online.co.uk

www.gev-online.com





- 🔍 Add to Favourites
- 🔍 Sign In with email address and usual password
- 🔍 Easy-order – place several items in your basket at the same time
- 🔍 Quick Item search – no login needed











heating elements

heating elements for ovens

			
GEV No.	418025	Ref. No.	41826620041 BN41826620041 BN826620041
description	heating element 1500W 230V L 525mm W 240mm lug length 70mm lug width 22mm hole distance 56mm hole ø 5mm tube ø 6.3mm connection male faston 6.3mm heating circuits 1 dry heating element rectangular flange oven		
For models:	SERIE 900, SERIE700		





			
GEV No.	418028	Ref. No.	41826620060 BN41826620060
description	heating element for griddle		
For models:	SERIE 900		

heating elements for bain maries

			
GEV No.	415091	Ref. No.	MA1037039513
description	heating element 1000W 230V heating circuits 1 L 295mm W 85mm connection length 20mm connection M3 tube ø 6.5mm 2 hole fixing thread M14x1 immersion heater/dry heating element bain marie/chip scuttle L1 145mm L2 150mm H 18mm mounting distance 79mm		
spare parts for	415091		
	GEV No.	510417	Ref. No. —
flat gasket fibre ED ø 20mm ID ø 14mm thickness 2mm Qty 1 pcs			
accessories for	415091		
	GEV No.	520228	Ref. No. —
tooth lock washer ID ø 15.3mm ED ø 24mm steel Qty 1 pcs for thread M14			
	GEV No.	521133	Ref. No. —
nut thread M14x1.5 H 6mm WS 19 zinc-coated steel Qty 1 pcs			
	GEV No.	527169	Ref. No. —
hexagonal nut thread M3 H 2.8mm WS 5.5 brass Qty 1 pcs			
	GEV No.	550261	Ref. No. —
nut thread M14x1 H 4mm WS 19 SS Qty 1 pcs			
	GEV No.	550262	Ref. No. —
flat gasket copper ED ø 20mm ID ø 14mm thickness 2mm			
	GEV No.	560110	Ref. No. —
plain washer ID ø 3.2mm ED ø 7mm thickness 0.5mm SS Qty 20 pcs DIN 125A for thread M3			

accessories for	415091		
	GEV No.	560130	Ref. No. —
hexagonal nut thread M3 H 2.4mm WS 5.5 SS DIN/ISO DIN 934 / ISO 4032/8673 Qty 20 pcs			

			
GEV No.	416796	Ref. No.	6A045700 BN6A045700
description	heating element 1500W 240V heating circuits 1 L 325mm W 180mm connection male faston 6.3mm tube ø 6.3mm 2 hole fixing thread 1/4" dry heating element bain marie L1 155mm L2 170mm H 34mm mounting distance 174mm		

accessories for	416796		
	GEV No.	361182	Ref. No. —
nut thread 1/4" H 5mm nickel-plated brass WS 17 Qty 1 pcs			
	GEV No.	510417	Ref. No. —
flat gasket fibre ED ø 20mm ID ø 14mm thickness 2mm Qty 1 pcs			
	GEV No.	520228	Ref. No. —
tooth lock washer ID ø 15.3mm ED ø 24mm steel Qty 1 pcs for thread M14			
	GEV No.	550262	Ref. No. —
flat gasket copper ED ø 20mm ID ø 14mm thickness 2mm			







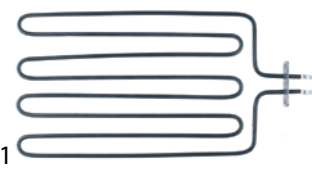

heating elements for frying pans

			
GEV No.	416698	Ref. No.	MA1037317700
description	heating element 1350W 230V L 460mm W 95mm connection M4 tube ø 6.3mm dry heating element multi purpose roasting pan H 40mm connection distance 89mm		

heating elements for chip scuttles

			
GEV No.	418037	Ref. No.	41826620031 BN826620031
description	heating element 700W 230V heating circuits 1 L 425mm W 220mm flange length 70mm flange width 22mm hole distance 56mm connection length 41mm connection male faston 6.3mm tube ø 6.5mm rectangular flange hole ø 5mm dry heating element W2 30mm		







			
GEV No.	415091	Ref. No.	MA1037039513
description	heating element 1000W 230V heating circuits 1 L 295mm W 85mm connection length 20mm connection M3 tube ø 6.5mm 2 hole fixing thread M14x1 immersion heater/dry heating element bain marie/chip scuttle L1 145mm L2 150mm H 18mm mounting distance 79mm		
spare parts for	415091		
	GEV No.	510417	Ref. No. —
	flat gasket fibre ED ø 20mm ID ø 14mm thickness 2mm Qty 1 pcs		
accessories for	415091		
	GEV No.	520228	Ref. No. —
	tooth lock washer ID ø 15.3mm ED ø 24mm steel Qty 1 pcs for thread M14		
	GEV No.	521133	Ref. No. —
	nut thread M14x1.5 H 6mm WS 19 zinc-coated steel Qty 1 pcs		
	GEV No.	527169	Ref. No. —
	hexagonal nut thread M3 H 2.8mm WS 5.5 brass Qty 1 pcs		
	GEV No.	550261	Ref. No. —
	nut thread M14x1 H 4mm WS 19 SS Qty 1 pcs		
	GEV No.	550262	Ref. No. —
	flat gasket copper ED ø 20mm ID ø 14mm thickness 2mm		
	GEV No.	560110	Ref. No. —
	plain washer ID ø 3.2mm ED ø 7mm thickness 0.5mm SS Qty 20 pcs DIN 125A for thread M3		
	GEV No.	560130	Ref. No. —
	hexagonal nut thread M3 H 2.4mm WS 5.5 SS DIN/ISO DIN 934 / ISO 4032/8673 Qty 20 pcs		

heating elements for fryers





off-center connection



with thread

			
GEV No.	416070	Ref. No.	85326002137
description	heating element 10200W 230/400V heating circuits 3 L 300mm W 180mm H 33mm flange length 19.5mm flange length 1 9.5mm flange length 2 9.8mm flange ø1 62mm flange ø2 57mm thermostat sleeves ø 6.5mm sensor screw connection 2x M10x1 thermostat sleeve upper/lower L1 18mm L2 282mm W1 30mm W2 35mm thread M54x1.5 windings 5 tube ø 8.5mm cable length 450mm rotation flange immersion heater fryer connection length 130mm 2		
For models:	SERIE 900, SERIE700		
spare parts for	416070		
	GEV No.	510243	Ref. No. 41824710530 4185326090145 824710530 85326090145 BN41824710530
	O-ring Viton thickness 3.53mm ID ø 55.56mm Qty 1 pcs		

spare parts for	416070		
	GEV No.	550496	Ref. No. —
	O-ring Viton thickness 3.53mm ID ø 50.39mm Qty 1 pcs		
accessories for	416070		
	GEV No.	510243	Ref. No. 41824710530 4185326090145 824710530 85326090145 BN41824710530
	O-ring Viton thickness 3.53mm ID ø 55.56mm Qty 1 pcs		
	GEV No.	550662	Ref. No. —
	ring nut thread M54x1.5 H 7mm		

miscellaneous

			
GEV No.	418778	Ref. No.	41826620132 BN41826620132
description	heating element 9000W 230/400V heating circuits 3 mounting pos. right L 310mm W 205mm H 32mm flange length 36mm flange length 1 28.2mm flange length 2 7.8mm flange ø1 62mm flange ø2 58mm thermostat sleeves ø 8mm thermostat sleeve upper/lower L1 25mm L2 285mm W1 34mm W2 35mm tube ø 8.5mm cable length 300mm rotation flange fryer 2 sensor screw connection M10x1		
accessories for	418778		
	GEV No.	510243	Ref. No. 41824710530 4185326090145 824710530 85326090145 BN41824710530
	O-ring Viton thickness 3.53mm ID ø 55.56mm Qty 1 pcs		
	GEV No.	510245	Ref. No. 4185326090144 85326090144
	O-ring Viton thickness 3.53mm ID ø 50.8mm Qty 1 pcs		
	GEV No.	691649	Ref. No. 41C122110
	conversion kit		

			
GEV No.	418038	Ref. No.	41826620130
description	heating element 9000W 230V heating circuits 3 L 310mm W 205mm H 32mm number of thermostat sleeves 1 L1 24mm L2 285mm W1 32mm W2 135mm cable length 300mm rotation flange		
For models:	SERIE 600		
accessories for	418038		
	GEV No.	510243	Ref. No. 41824710530 4185326090145 824710530 85326090145 BN41824710530
	O-ring Viton thickness 3.53mm ID ø 55.56mm Qty 1 pcs		
	GEV No.	510245	Ref. No. 4185326090144 85326090144
	O-ring Viton thickness 3.53mm ID ø 50.8mm Qty 1 pcs		



center connection			
GEV No.	415297	Ref. No.	4185326002136 BN4185326002136 SI0108058 SIRO108058
description	heating element 6800W 230/400V heating circuits 3 L 299mm W 107mm H 35mm flange length 19.5mm flange length 1 9.5mm flange length 2 9.8mm flange ø1 62mm flange ø2 57mm thermostat sleeves ø 8.5mm sensor screw connection 2x M10x1 thermostat sleeve upper/lower L1 16mm L2 283mm W1 30mm W2 77mm thread M54x1.5 tube ø 8.5mm cable length 450mm rotation flange immersion heater		
For models:	SERIE 900, SERIE700		
accessories for	415297		
	GEV No.	Ref. No.	41824710530 4185326090145 824710530 85326090145 BN41824710530
	O-ring Viton thickness 3.53mm ID ø 55.56mm Qty 1 pcs		
	GEV No.	Ref. No.	4185326090144 85326090144
	O-ring Viton thickness 3.53mm ID ø 50.8mm Qty 1 pcs		
	GEV No.	Ref. No.	—
	ring nut thread M54x1.5		

GEV No.	418713	Ref. No.	9000482 BN9000482
description	heating element 9000W 230/400V heating circuits 3 L 395mm W 135mm H 267mm L1 35mm L2 40mm L3 320mm W1 22mm W2 90mm H1 40mm H2 195mm H3 32mm hole distance 121mm hole ø 6mm flange length 132mm flange width 38mm tube ø 8.5mm connection length 18mm		
For models:	7FRI/E610		





GEV No.	420526	Ref. No.	BN9000480
description	heating element 9000W 230V heating circuits 3 L 390mm W 135mm H 230mm L1 50mm L2 40mm L3 315mm W1 20mm W2 94mm H1 105mm H2 170mm H3 35mm threaded hole distance 122mm		

miscellaneous			
GEV No.	418777	Ref. No.	41C1122110 BN41C1122110
description	heating element 9000W 230/400V heating circuits 3 L 310mm W 205mm H 32mm sensor screw connection M9x1 L1 24mm L2 285mm W1 32mm W2 135mm cable length 300mm rotation flange immersion heater		

6 hole fixing			
GEV No.	416810	Ref. No.	MA1037317100
description	heating element 6000W 230/400V heating circuits 3 L 320mm W 175mm H 205mm W1 5mm H1 165mm H2 40mm thread M12x1 tube ø 8.5mm connection male faston 6.3mm immersion heater 6 hole fixing		

GEV No.	418710	Ref. No.	9000483 BN9000483
description	heating element 13000W 230/400V heating circuits 3 L 385mm W 200mm H 270mm L1 40mm L2 30mm L3 315mm W1 54mm W2 92mm H1 30mm H2 200mm H3 35mm hole distance 122mm hole ø 6mm flange length 132mm flange width 38mm tube ø 8.5mm		



GEV No.	416811	Ref. No.	MA1037317200
description	heating element 9000W 230V heating circuits 3 L 320mm W 175mm H 205mm W1 5mm H1 165mm H2 40mm thread M12x1 tube ø 8.5mm connection male faston 6.3mm immersion heater 6 hole fixing		
spare parts for	416811		
	GEV No.	521110	Ref. No. —
	flat gasket fibre ED ø 20mm ID ø 13mm thickness 2mm Qty 1 pcs		
accessories for	416811		
	GEV No.	520229	Ref. No. —
	nut thread M12x1 H 4mm WS 16 zinc-coated steel Qty 1 pcs		
	GEV No.	521131	Ref. No. —
	nut thread M12x1 H 3.5mm WS 17 SS Qty 1 pcs		
	GEV No.	528110	Ref. No. —
	O-ring EPDM thickness 2.62mm ID ø 12.37mm Qty 1 pcs		

heating elements for griddles







GEV No.	418027	Ref. No.	41826620070 BN41826620070 BN826620070
description	heating element 1250W 230V heating circuits 1 L 407mm W 88mm H 20mm tube ø 8.5mm bracket mounting connection male faston 6.3mm hole distance 60mm hole ø 5mm griddle dry heating element lug length 25mm lug width 15mm		
For models:	SERIE700		



GEV No.	418026	Ref. No.	41826620140 BN41826620140
description	heating element 1250W 230V heating circuits 1 L 450mm W 94mm H 99mm tube ø 8.5mm L1 25mm connection male faston 6.3mm connection distance 88mm dry heating element		
For models:	SERIE 600		



GEV No.	415076	Ref. No.	MA1037300713
description	heating element 1300W 230V heating circuits 1 L 490mm W 78mm H 70mm tube ø 6.3mm W1 17mm W2 44mm connection M4 connection length 20mm dry heating element		
accessories for	415076		
	GEV No.	521103	Ref. No. —
	nut thread M4 H 3mm WS 7 brass Qty 20 pcs		
	GEV No.	521104	Ref. No. —
	washer ID ø 4.3mm ED ø 8mm thickness 0.5mm brass Qty 20 pcs for thread M4		
	GEV No.	560111	Ref. No. —
	plain washer ID ø 4.3mm ED ø 9mm thickness 0.8mm SS Qty 20 pcs DIN 125A for thread M4		
	GEV No.	560131	Ref. No. —
	hexagonal nut thread M4 H 3.2mm WS 7 SS DIN/ISO DIN 934 / ISO 4032/8673 Qty 20 pcs		



GEV No.	420109	Ref. No.	CR0582840
description	heating element 2500W 230V heating circuits 1 L 635mm W 90mm H 80mm L1 30mm connection M5 connection distance 81.5mm tube ø 8.5mm connection length 18mm dry heating element for griddle		



GEV No.	418444	Ref. No.	41826620061 BN826620061
description	heating element 2666W 230V heating circuits 1 L 555mm W 100mm H 23mm tube ø 8.5mm bracket mounting connection male faston 6.3mm hole distance 92mm griddle dry heating element lug length 30mm lug width 18mm		



GEV No.	420110	Ref. No.	CR0685730
description	heating element 3500W 230V heating circuits 1 L 635mm W 140mm H 80mm tube ø 8.5mm L1 35mm connection M5 connection length 18mm for griddle connection distance 131.5mm dry heating element		

heating elements for tilting bratt pan









GEV No.	415076	Ref. No.	MA1037300713
description	heating element 1300W 230V heating circuits 1 L 490mm W 78mm H 70mm tube ø 6.3mm W1 17mm W2 44mm connection M4 connection length 20mm dry heating element		
accessories for	415076		
	GEV No.	521103	Ref. No. —
	nut thread M4 H 3mm WS 7 brass Qty 20 pcs		
	GEV No.	521104	Ref. No. —
	washer ID ø 4.3mm ED ø 8mm thickness 0.5mm brass Qty 20 pcs for thread M4		

Table continues overleaf





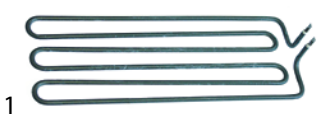

accessories for	415076		
	GEV No.	560111	Ref. No. —
	plain washer ID ø 4.3mm ED ø 9mm thickness 0.8mm SS Qty 20 pcs DIN 125A for thread M4		
	GEV No.	560131	Ref. No. —
	hexagonal nut thread M4 H 3.2mm WS 7 SS DIN/ISO DIN 934 / ISO 4032/8673 Qty 20 pcs		

			
1			
GEV No.	416806	Ref. No.	6A050190 BN6A050190
description	heating element 3490W 230V L 480mm W 185mm H 65mm dry heating element tube ø 8.5mm W1 78mm W2 30mm connection distance 22mm		

			
1			
GEV No.	418039	Ref. No.	41826620090 BN41826620090
description	heating element for tilting bratt pan 1200W 230V L 292mm W 86mm H 20mm connection male faston 6.3mm dry heating element tube ø 8.5mm 2 hole fixing thread 1/4" mounting distance 78mm connection length 90mm		
For models:	SERIE700		
accessories for	418039		
	GEV No.	361182	Ref. No. —
	nut thread 1/4" H 5mm nickel-plated brass WS 17 Qty 1 pcs		
	GEV No.	510417	Ref. No. —
	flat gasket fibre ED ø 20mm ID ø 14mm thickness 2mm Qty 1 pcs		
	GEV No.	520228	Ref. No. —
	tooth lock washer ID ø 15.3mm ED ø 24mm steel Qty 1 pcs for thread M14		
	GEV No.	550262	Ref. No. —
	flat gasket copper ED ø 20mm ID ø 14mm thickness 2mm		



			
1			
GEV No.	417164	Ref. No.	41826620120 BN41826620120 BN826620120
description	heating element for tilting bratt pan 2000W 230V L 290mm W 143mm H 26mm connection male faston 6.3mm dry heating element tube ø 8.5mm 2 hole fixing thread 1/4" mounting distance 132mm connection length 83mm		
For models:	SERIE 900		
accessories for	417164		
	GEV No.	550163	Ref. No. —
	ring terminal size M4 ø4.3mm 1.5-2.5mm ² Qty 100 pcs insulation PVC Cu gal Sn blue t.max. 75°C		

			
1			
GEV No.	416805	Ref. No.	6A050210 BN6A050210
description	heating element for tilting bratt pan 2350W 230V L 400mm W 160mm H 55mm connection M5 dry heating element tube ø 8.5mm L1 210mm L2 190mm 2 hole fixing thread 1/4" mounting distance 152mm		
spare parts for	416805		
	GEV No.	550262	Ref. No. —
	flat gasket copper ED ø 20mm ID ø 14mm thickness 2mm		
accessories for	416805		
	GEV No.	361182	Ref. No. —
	nut thread 1/4" H 5mm nickel-plated brass WS 17 Qty 1 pcs		
	GEV No.	510417	Ref. No. —
	flat gasket fibre ED ø 20mm ID ø 14mm thickness 2mm Qty 1 pcs		
	GEV No.	520228	Ref. No. —
	tooth lock washer ID ø 15.3mm ED ø 24mm steel Qty 1 pcs for thread M14		







heating elements for pasta cookers



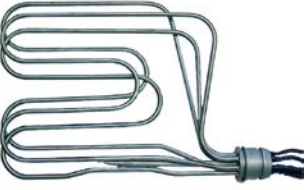

			
1			
GEV No.	418032	Ref. No.	4185326002063 BN4185326002063
description	heating element 2000W 240V heating circuits 1 L 280mm W 75mm Hmm 2 hole fixing connection M4 thread 1/4" tube ø 8.5mm mounting distance 67mm pasta cooker		
For models:	SERIE700		
accessories for	418032		
	GEV No.	361182	Ref. No. —
	nut thread 1/4" H 5mm nickel-plated brass WS 17 Qty 1 pcs		
	GEV No.	510417	Ref. No. —
	flat gasket fibre ED ø 20mm ID ø 14mm thickness 2mm Qty 1 pcs		
	GEV No.	520228	Ref. No. —
	tooth lock washer ID ø 15.3mm ED ø 24mm steel Qty 1 pcs for thread M14		
	GEV No.	550262	Ref. No. —
	flat gasket copper ED ø 20mm ID ø 14mm thickness 2mm		









			
1			
GEV No.	418031	Ref. No.	41826620150 41826620152 BN41826620152
description	heating element 2200W 230V heating circuits 1 L 300mm W 34mm H 42mm flange with thread thread 1" tube ø 6mm thermostat sleeves ø 6.5mm length thermostat sleeves 190mm cable length 400mm pasta cooker immersion heater		
For models:	SERIE 600		
accessories for	418031		
	GEV No.	510404	Ref. No. —
	flat gasket fibre ED ø 44mm ID ø 34mm thickness 2mm Qty 1 pcs		
	GEV No.	528018	Ref. No. —
	flat gasket PTFE ED ø 41mm ID ø 33mm thickness 3mm size 1" Qty 1 pcs		

			
1			
GEV No.	418033	Ref. No.	4185326002064 BN4185326002064
description	heating element 3000W 240V L 447mm W 70mm 2 hole fixing connection M4 tube ø 8.5mm mounting distance 62mm pasta cooker immersion heater		
For models:	SERIE 900		

			
1			
GEV No.	415977	Ref. No.	1870000 MA1870000 MA1870000R
description	heating element 5670W 230V heating circuits 3 L 292mm W 225mm H 26mm rotation flange tube ø 6.3mm thermostat sleeves ø 9mm length thermostat sleeves 185mm L1 42mm L2 250mm W1 197mm W2 28mm cable length 460mm number of thermostat sleeves 1 connection length 50mm flange length 1 9mm flange length 2 15.5mm flange length 24.5mm flange ø1 43.8mm flange ø2 39.7mm thermostat sleeve centred, adjacent pasta cooker sensor screw connection M10x1		
accessories for	415977		
	GEV No.	514016	Ref. No. MA1814500
	flat gasket PTFE ED ø 45mm ID ø 40mm thickness 4mm Qty 1 pcs equiv. no. 1036500400/1814500 suitable for MARENO		
	GEV No.	514017	Ref. No. 0105246 MA1814400 R0105246 SIR0105246
	O-ring silicone thickness 3.53mm ID ø 32.93mm Qty 1 pcs		
	GEV No.	514018	Ref. No. MA1814600
	bush		
	GEV No.	514020	Ref. No. MA1815014
	bush		
	GEV No.	514021	Ref. No. MA1814700
	O-ring silicone thickness 3.53mm ID ø 49.21mm Qty 1 pcs		

accessories for	415977		
	GEV No.	514022	Ref. No. MA14044599
	nut thread 1½" H 12mm SS WS 59 Qty 1 pcs		
	GEV No.	540435	Ref. No. MA1869600
	threaded rod thread M10 hollow		
	GEV No.	540436	Ref. No. MA1033514900
	hexagonal nut thread M10x1.25 H 4mm WS 13 brass Qty 1 pcs		
	GEV No.	540438	Ref. No. MA1868700
	long nut thread M10 L 25mm WS 13 brass Qty 1 pcs		
	GEV No.	540439	Ref. No. MA1869500
	distance washer		

			
1			
GEV No.	416795	Ref. No.	8218100 BN8218100
description	heating element 7500W 230V heating circuits 3 L 300mm W 237mm Hmm 6 hole fixing connection M5 thread M14x1 tube ø 8.9mm complete auxiliary equipment		
spare parts for	416795		
	GEV No.	507309	Ref. No. 41824710280 824710280 BN824710280
	O-ring EPDM thickness 2.62mm ID ø 17.13mm Qty 1 pcs		
	GEV No.	550261	Ref. No. —
	nut thread M14x1 H 4mm WS 19 SS Qty 1 pcs		
accessories for	416795		
	GEV No.	510417	Ref. No. —
	flat gasket fibre ED ø 20mm ID ø 14mm thickness 2mm Qty 1 pcs		
	GEV No.	520228	Ref. No. —
	tooth lock washer ID ø 15.3mm ED ø 24mm steel Qty 1 pcs for thread M14		
	GEV No.	521133	Ref. No. —
	nut thread M14x1.5 H 6mm WS 19 zinc-coated steel Qty 1 pcs		
	GEV No.	550262	Ref. No. —
	flat gasket copper ED ø 20mm ID ø 14mm thickness 2mm		



			
1			
GEV No.	415971	Ref. No.	MA1870100 MA1870100R
description	heating element 9000W 230/415V heating circuits 3 L 245mm W 320mm H 25mm rotation flange tube ø 6.3mm thermostat sleeves ø 7mm length thermostat sleeves 210mm L1 55mm L2 190mm W1 28mm W2 292mm cable length 600mm number of thermostat sleeves 1 connection length 35mm flange length 1 9mm flange length 2 15.5mm flange length 24.5mm flange ø1 43.8mm flange ø2 39.7mm mounting pos. left suitable for 600 series thermostat sleeve centred, adjacent pasta cooker sensor screw connection M10x1		
accessories for	415971		
	GEV No.	514016	Ref. No. MA1814500
	flat gasket PTFE ED ø 45mm ID ø 40mm thickness 4mm Qty 1 pcs equiv. no. 1036500400/1814500 suitable for MARENO		
	GEV No.	514017	Ref. No. 0105246 MA1814400 R0105246 SIR0105246
	O-ring silicone thickness 3.53mm ID ø 32.93mm Qty 1 pcs		
	GEV No.	514018	Ref. No. MA1814600
	bush		
	GEV No.	514019	Ref. No. —
	threaded rod thread M8 L 45mm brass		
	GEV No.	514020	Ref. No. MA1815014
	bush		
	GEV No.	514021	Ref. No. MA1814700
	O-ring silicone thickness 3.53mm ID ø 49.21mm Qty 1 pcs		
	GEV No.	514022	Ref. No. MA14044599
	nut thread 1½" H 12mm SS WS 59 Qty 1 pcs		
	GEV No.	540435	Ref. No. MA1869600
	threaded rod thread M10 hollow		
	GEV No.	540436	Ref. No. MA1033514900
	hexagonal nut thread M10x1.25 H 4mm WS 13 brass Qty 1 pcs		
	GEV No.	540438	Ref. No. MA1868700
	long nut thread M10 L 25mm WS 13 brass Qty 1 pcs		
	GEV No.	540439	Ref. No. MA1869500
	distance washer		

heating elements for salamanders/toast-

			
1			
GEV No.	416654	Ref. No.	0111641850 BN0111641850
description	heating element 2000W 230V L 230mm W 230mm L1 22mm L2 208mm W1 83mm W2 63mm hole distance 96mm tube ø 8.5mm flange length 106mm flange width 32mm heating circuits 1 hole ø 5mm tilt flange dry heating element H 8.5mm		

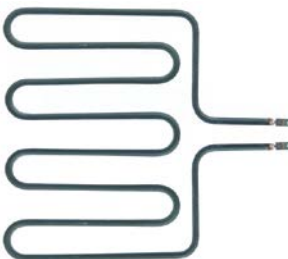
			
1			
GEV No.	420288	Ref. No.	BN011LIN1400011
description	heating element 1900W 400V heating circuits 1 L 245mm W 230mm L1 60mm L2 185mm W1 100mm W2 30mm connection distance 25mm windings 4 connection M4 dry heating element tube ø 6.25mm H 6.25mm		

ceramic heaters

245x60mm

			
1			
GEV No.	415104	Ref. No.	MA1037317601
description	ceramic emitter 1000W 230V cable beaded cord L 245mm W 60mm H 35mm		
spare parts for	415104		
	GEV No.	415109	Ref. No. —
	spring clip		
accessories for	415104		
	GEV No.	415110	Ref. No. —
	reflector L 245mm W 95mm H 31mm thickness 0.75mm hole ø 15x40mm		



immersion heating elements

with round flange ø47.5mm



GEV No.	415269	Ref. No.	01120288520 BN01120288520
description	heating element 2700W 230V heating circuits 3 mounting ø 47.5mm L 257mm W 28mm H 45mm round flange connection male faston 6.3mm immersion heater tube ø 6.3mm H1 11mm H2 34mm connection length 28mm		
accessories for	415269		
	GEV No.	510408	Ref. No. 0118462630 BN0118462630
	O-ring EPDM thickness 5.34mm ID ø 47mm Qty 1 pcs		
	GEV No.	510562	Ref. No. —
	O-ring silicone thickness 5.34mm ID ø 47mm Qty 1 pcs		
	GEV No.	520235	Ref. No. —
	3 hole flange hole distance 70.5mm perforation ø 6.5mm ID ø 53.5mm		
	GEV No.	520236	Ref. No. —
	flange for heating element ID ø 50mm ED ø 90mm hole ø 6.5mm 3 holes		
	GEV No.	550002	Ref. No. —
	tension strap H 10mm L 21mm W 10mm hole ø 6.5mm for heating element		
	GEV No.	550362	Ref. No. —
	blind flange ø 64mm mounting ø 47.5mm		

with round flange ø57.5mm



GEV No.	416279	Ref. No.	BN011DW30001011/A
description	heating element 12000W 230V heating circuits 3 mounting ø 57.5mm L 470mm W 48mm H 34mm round flange connection M5 immersion heater tube ø 8.5mm connection length 30mm thermostat sleeves ø 7mm number of thermostat sleeves 1 length thermostat sleeves 295mm thermostat sleeve eccentric, non clinging		
accessories for	416279		
	GEV No.	550002	Ref. No. —
	tension strap H 10mm L 21mm W 10mm hole ø 6.5mm for heating element		







GEV No.	418040	Ref. No.	41853310062 BN41853310062
description	heating element 6000W 230V heating circuits 3 L 385mm W 32mm H 42mm tube ø 6.3mm thermostat sleeves ø 7mm length thermostat sleeves 275mm number of thermostat sleeves 1 thermostat sleeve clinging connection male faston 6.3mm connection length 27mm immersion heater round flange mounting ø 57.5mm		
For models:	SERIE 900, SERIE700		
accessories for	418040		
	GEV No.	550002	Ref. No. —
	tension strap H 10mm L 21mm W 10mm hole ø 6.5mm for heating element		

GEV No.	418041	Ref. No.	41853310185 BN41853310185
description	heating element 8000W 230V heating circuits 3 L 470mm W 42mm H 31mm tube ø 6.4mm thermostat sleeves ø 7mm length thermostat sleeves 278mm number of thermostat sleeves 1 thermostat sleeve clinging connection male faston 6.3mm connection length 27mm immersion heater round flange mounting ø 57.5mm		
For models:	SERIE 900		
spare parts for	418041		
	GEV No.	510409	Ref. No. —
	O-ring EPDM thickness 5.34mm ID ø 56.52mm Qty 1 pcs		
accessories for	418041		
	GEV No.	550002	Ref. No. —
	tension strap H 10mm L 21mm W 10mm hole ø 6.5mm for heating element		

GEV No.	418112	Ref. No.	0A037484 6A037484 BN6A037484
description	heating element 15000W 220V heating circuits 6 L 310mm W 230mm H 130mm thermostat sleeves ø 6/4mm length thermostat sleeves 137/125mm number of thermostat sleeves 2 thermostat sleeve clinging / not clinging connection male faston 6.3mm immersion heater		
For models:	ECVME 10, ECVME 20, ECVME 21, ECVMG 10, ECVMG 20, ECVMG 21, ECVPE 10, ECVPE 20, ECVPE 21, ECVPG 10, ECVPG 20, ECVPG 21		
spare parts for	418112		
	GEV No.	375638	Ref. No. 0A046186 BN6A046186
	bi-metal thermostat hole distance 23.5mm 1NC 1-pole connection F6.3 2 hole fixing		
accessories for	418112		
	GEV No.	550692	Ref. No. 0A037485 BN6A037485
	gasket silicone thickness 7mm ID ø 193.7mm Qty 1 pcs for heating element suitable for BARON equiv. no. A037485		





 <p>1</p>			
GEV No.	418111	Ref. No.	0A037483 BN6A037483
description	heating element 7500W 220V heating circuits 6 L 310mm W 145mm H 130mm thermostat sleeves ø 6x4mm length thermostat sleeves 137/125mm number of thermostat sleeves 2 thermostat sleeve clinging / not clinging connection male faston 6.3mm immersion heater special fixing		
For models:	ECVME 6, ECVMG 6, ECVPE 6, ECVPG 6		
accessories for	418111		
	GEV No.	550692	Ref. No. 0A037485 BN6A037485
	gasket silicone thickness 7mm ID ø 193.7mm Qty 1 pcs for heating element suitable for BARON equiv. no. A037485		

 <p>1"</p> <p>1</p>			
GEV No.	420074	Ref. No.	CR0682160 CR0682160R
description	heating element 260W 230V heating circuits 1 L 242mm W 18mm H 6.25mm tube ø 6.25mm thermostat sleeves ø 5mm length thermostat sleeves 230mm number of thermostat sleeves 1 thermostat sleeve centred, adjacent connection male faston 6.3mm connection length 35mm immersion heater flange with thread WS 32 thread 1"		
spare parts for	420074		
	GEV No.	503158	Ref. No. —
	flat gasket FIBER ED ø 44mm ID ø 33mm thickness 2mm Qty 1 pcs		
accessories for	420074		
	GEV No.	507532	Ref. No. —
	nut thread 1" H 10mm WS 40 brass Qty 1 pcs		

heating elements for convection

 <p>1</p>			
GEV No.	418110	Ref. No.	0A037470 BN6A037470
description	heating element 10500W 230V heating circuits 3 ID ø 370mm ED ø 384mm L 405mm H 141mm L1 20mm W1 105mm H1 41mm H2 100mm flange length 142mm flange width 25mm hole distance 63mm connection M5 tube ø 6.5mm convection heating element hole ø 6mm rectangular flange		
For models:	ECVME 10, ECVME 20, ECVME 6, ECVPE 20		

 <p>1</p>			
GEV No.	418107	Ref. No.	0A037460 BN6A037460
description	heating element 7500W 230V heating circuits 3 ID ø 368mm ED ø 385mm L 405mm H 135mm L1 24mm W1 105mm H1 35mm H2 100mm flange length 142mm flange width 24mm hole distance 64mm connection M5 connection length 92mm tube ø 8.5mm convection heating element hole ø 5.5mm rectangular flange		
For models:	ECVME 10, ECVME 20, ECVME 21, ECVME 6, ECVPE 10, ECVPE 21, ECVPE 6		

 <p>1</p>			
GEV No.	418108	Ref. No.	0A037480 BN6A037480
description	heating element 7500W 230V heating circuits 3 ID ø 475mm ED ø 495mm L 515mm H 143mm L1 15mm W1 105mm H1 43mm H2 100mm flange length 142mm flange width 25mm hole distance 64mm connection M4 tube ø 8.5mm convection heating element hole ø 6mm rectangular flange		
For models:	ECVME 10, ECVME 20, ECVME 21, ECVME 6, ECVPE 10, ECVPE 21		

 <p>1</p>			
GEV No.	418109	Ref. No.	0A037475 BN6A037475
description	heating element 9000W 230V heating circuits 3 ID ø 470mm ED ø 485mm L 520mm H 155mm L1 18mm W1 104mm H1 50mm H2 105mm flange length 142mm flange width 25mm hole distance 63mm connection M5 tube ø 6.5mm convection heating element hole ø 6.3mm rectangular flange		
For models:	ECVME 10, ECVME 20, ECVME 6, ECVPE 20		



radiation heaters



1

GEV No.	490079	Ref. No.	6A001405MAG BN6A001405MAG
description	radiation heater octagonal 3400W 230V L 300mm W 300mm heating circuits 2 H 30mm with heating coil energy regulation with temperature signalization connections 4+2 connection type cable AD		
spare parts for	490079		
	GEV No.	390931	Ref. No. —
safety thermostat for radiation heater			



1

GEV No.	490153	Ref. No.	41853400030 BN41853400030 MACM189500
description	radiation heater octagonal 3400W 230V L 300mm W 300mm heating circuits 2 H 30mm with heating coil energy regulation with temperature signalization connections 4+2 connection type cable cable length 900mm AD		
For models:	SERIE 900, SERIE700		

square



1

GEV No.	490202	Ref. No.	826620230 BN826620230 CR0735680
description	radiation heater L 300mm W 300mm 4000W 400V H 40mm connection type screw with pan detection		

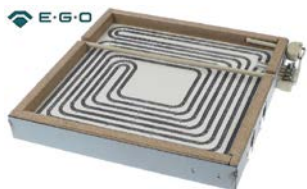

1

GEV No.	490195	Ref. No.	CR0688660
description	radiation heater L 300mm W 300mm 4000W 400V heating circuits 2 H 40mm connection type screw without pan detection EGO		



1

GEV No.	418029	Ref. No.	41826900711 41826900713
description	radiation heater rectangular 1500W 230V L 450mm W 190mm heating circuits 1 connections 2 IRCA		
For models:	SERIE 600		



1

GEV No.	418030	Ref. No.	41826900721
description	radiation heater rectangular 2500W 230V L 450mm W 295mm heating circuits 1 connections 2 IRCA		
For models:	SERIE 600		



1

GEV No.	490172	Ref. No.	826620241 BN826620241
description	radiation heater rectangular 4500W 400V L 280mm W 400mm heating circuits 2 connections 2x 2 connection type cable cable length 800mm IRCA		
For models:	7BRF/E805		

1-circuit



1

GEV No.	490138	Ref. No.	41853400060 BN41853400060
description	heating element 1200W 230V heating circuits 1		
For models:	SERIE 600, SERIE700		

1

GEV No.	490113	Ref. No.	41853400050 BN41853400050
description	radiation heater ø 200mm 1800W 230V heating circuits 1 energy regulation with temperature signalization with ribbon heater connections 2+2 connection type male faston 6.3mm CERAMASPEED		
For models:	SERIE 600, SERIE700		



1

GEV No.	490150	Ref. No.	CR0791310
description	radiation heater ø 250mm 2500W 230V heating circuits 1 energy regulation with temperature signalization with heating coil connections 2+2 connection type male faston 6.3mm EGO		

2-circuit



1

GEV No.	490139	Ref. No.	41853400040 41R100007 41R447765 BN41853400040 CR0511560
description	radiation heater ø 250mm 2500W 230V heating circuits 2 energy regulation with temperature signalization partial power 1000W with ribbon heater connections 3+2 connection type male faston 6.3mm EGO		



1

GEV No.	490118	Ref. No.	41826900692
description	radiation heater ø 250mm 2500W heating circuits 2 partial power 1000W		
For models:	SERIE 600, SERIE 900, SERIE700		

foil heating elements



1

GEV No.	418034	Ref. No.	41826620170 BN41826620170 BN826620170
description	foil heating element L 400mm W 290mm 1500W 230V t.max. 175°C with temperature limiter silicone cable length 1000mm thickness 1mm		
For models:	SERIE 600		



1

GEV No.	418035	Ref. No.	41826620160 BN41826620160
description	foil heating element L 490mm W 400mm 2300W 230V t.max. 175°C with temperature limiter 140°C silicone cable length 1000mm thickness 1mm		
For models:	SERIE 600		

hot plates

square & rectangular

with radiused edge



1

GEV No.	490067	Ref. No.	6A036740	
description	hot plate dimensions 220x220mm 2000W 400V with spill ring connection 4 screw clamps protector no square			
accessories for	490067			
	GEV No.	693464	Ref. No.	—
	sealing cord ø 10mm Qty supplied by meter			



1

GEV No.	490074 ¹	Ref. No.	41826620080 BN41826620080 BN826620080 MA1937400
description	hot plate dimensions 300x300mm 4000W 400V with spill ring connection 4 screw clamps protector yes square		
For models:	SERIE 900		

¹incl. protector

round

with radiused edge

for domestic and commercial kitchens



1

GEV No.	490017	Ref. No.	6A048910 BN6A048910
description	hot plate ø 180mm 2000W 400V connection 4 screw clamps with 8mm spill ring		



1

GEV No.	490020	Ref. No.	MA1832313
description	hot plate ø 220mm 2600W 230V connection 4 screw clamps with 8mm spill ring		
accessories for	490020		
	GEV No.	550796	Ref. No. —
fixing plate for hot plate ø220mm			



1

GEV No.	490021	Ref. No.	41826620010 BN41826620010
description	hot plate ø 220mm 2600W 400V connection 4 screw clamps with 8mm spill ring		
For models:	SERIE 600, SERIE700		

energy regulators

EGO

1-circuit



1

GEV No.	380015	Ref. No.	41826630141 65080250 826630140 LA65080250 LAR65080250
description	energy regulator 230V 13A single-circuit turn direction right shaft ø 6x4.6mm shaft L 23mm mounting thread M4 power release 6-100% no. 50.57021.010		
For models:	SERIE 900, SERIE700		



1

GEV No.	380013	Ref. No.	41826630210 BN826630210
description	energy regulator 400V 7A single-circuit turn direction right shaft ø 6x4.6mm mounting thread M4 no. 50.57031.010		

2-circuit



1

GEV No.	380024	Ref. No.	41853400010 BN41853400010
description	energy regulator 240V 13A turn direction right shaft ø 6x4.6mm shaft L 36mm mounting thread M4 no. 50.67079.601 with operation switch 1-pole		
For models:	SERIE 600, SERIE 900, SERIE700		



1

GEV No.	380027	Ref. No.	41853400020 BN41853400020 MACM293900
description	energy regulator EGO 230V 13A dual circuit turn direction right shaft ø 6x4.6mm shaft L 23mm mounting thread M4 power release 6-70% no. 50.55021.100		
For models:	SERIE 600, SERIE700		



thermostats

bi-metal thermostats

bi-metal thermostats



GEV No.	375638	Ref. No.	0A046186 BN6A046186
description	bi-metal thermostat hole distance 23.5mm 1NC 1-pole connection F6.3 2 hole fixing		

control and safety thermostats

EGO

control thermostats

55.10/19_ series

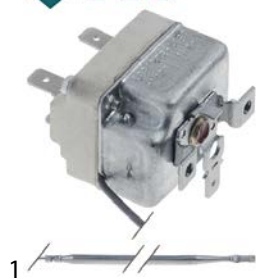

GEV No.	375548	Ref. No.	CR0682740
description	thermostat t.max. 142°C temperature range fixed 142°C 1-pole 1CO 16A probe ø 4mm probe L 157mm capillary pipe 870mm capillary pipe isolated 870mm gland nut shaft ø 6x4.6mm shaft Lmm shaft position		



GEV No.	375606	Ref. No.	41826630370
description	thermostat t.max. 171°C temperature range 85-171°C 1-pole 1NO 16A probe ø 6mm probe L 133mm capillary pipe 870mm capillary pipe isolated 700mm gland nut shaft ø 6x4.6mm shaft L 23mm shaft position lower rotation 270°		
For models:	SERIE 600		



GEV No.	375444	Ref. No.	41826630371 41826630372 BN41826630371 BN41826630372
description	thermostat t.max. 182°C temperature range 95-182°C 1-pole 1NO 16A probe ø 6mm probe L 133mm capillary pipe 870mm capillary pipe isolated 750mm gland nut M9x1 shaft ø 6x4.6mm shaft L 23mm shaft position lower rotation 270°		



GEV No.	375604	Ref. No.	41826630191 BN826630191
description	thermostat t.max. 320°C temperature range 64-320°C 1-pole 1NO 0.5A probe ø 4mm probe L 124mm capillary pipe 1470mm capillary pipe isolatedmm gland nut shaft ø 6x4.6mm shaft L 23mm shaft position upper rotation 270°		
For models:	7BRF/E805, SERIE 900, SERIE700		



GEV No.	375945	Ref. No.	CR0734520
description	thermostat t.max. 470°C temperature range 90-470°C 1-pole 1NO 16A probe ø 3.9mm probe L 163mm capillary pipe 870mm capillary pipe isolated 600mm shaft ø 4.5x6mm shaft L 23mm shaft position upper rotation 270°		

→ electric components



1

GEV No.	375636	Ref. No.	0A046195 BN6A046195
description	thermostat t.max. 60°C temperature range fixed 60°C 1-pole 1CO 16A probe ø 11mm probe L 29mm capillary pipe 1470mm capillary pipe isolated 1450mm gland nut screw-in probe probe thread M14x1		

55.13_series



1

GEV No.	375492	Ref. No.	4185326010005 BN4185326010005
description	thermostat t.max. 190°C temperature range 94-190°C 1-pole 1NO 16A probe ø 6mm probe L 94mm capillary pipe 1090mm capillary pipe isolated 960mm gland nut M10x1 shaft ø 6x4.6mm shaft L 23mm shaft position upper rotation 310° probe material SS		
For models:	SERIE 900, SERIE700		

55.14_series



1

GEV No.	375874	Ref. No.	MA1037117700
description	thermostat t.max. 90°C temperature range 30-90°C 1-pole 1NO 16A probe ø 6mm probe L 74mm capillary pipe 900mm capillary pipe isolated 800mm gland nut M10x1 shaft ø 6x4.6mm shaft L 23mm shaft position 180° shaft position rotation 270°		

55.34_series

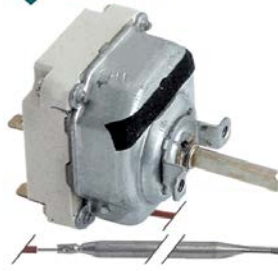

1

GEV No.	375602	Ref. No.	4185326010016 BN4185326010016
description	thermostat t.max. 120°C temperature range 45-120°C 3-pole 3CO 16A probe ø 6mm probe L 140mm capillary pipe 900mm capillary pipe isolated 870mm gland nut shaft ø 6x4.6mm shaft L 23mm shaft position upper rotation 270°		
For models:	SERIE 900, SERIE700		



1

GEV No.	375887	Ref. No.	6A044650 BN6A044650
description	thermostat t.max. 125°C temperature range 65-125°C 3-pole 3NO 16A probe ø 6mm probe L 77mm capillary pipe 880mm capillary pipe isolated 880mm gland nut shaft L 23mm shaft position upper°		



1

GEV No.	375385	Ref. No.	8219601 BN8219601
description	thermostat t.max. 180°C temperature range 100-180°C 3-pole 3NO 16A probe ø 6mm probe L 131mm capillary pipe 2000mm capillary pipe isolated 1800mm gland nut shaft ø 6x4.6mm shaft L 23mm shaft position upper rotation 270°		
For models:	7FRI/E610		



GEV No.	375603	Ref. No.	41826630123 41826630161 BN826630123
description	thermostat t.max. 300°C temperature range 50-300°C 3-pole 3NO 16A probe ø 3mm probe L 219mm capillary pipe 900mm capillary pipe isolated 900mm gland nut shaft ø 6x4.6mm shaft L 23mm shaft position upper rotation 270°		



GEV No.	375944	Ref. No.	CR0582770
description	thermostat t.max. 350°C temperature range 100-350°C 3-pole 3NOA probe ø 3mm probe L 147mm capillary pipe 900mm capillary pipe isolatedmm gland nut shaft ø 6x4.6mm shaft L 26mm shaft position upper rotation 270° probe material SS		



GEV No.	375192	Ref. No.	MA1309115
description	thermostat t.max. 300°C temperature range 50-300°C 3-pole 3NO 16A probe ø 3mm probe L 219mm capillary pipe 900mm capillary pipe isolatedmm gland nut shaft ø 6x4.6mm shaft L 23mm shaft position upper rotation 270°		

safety thermostats

55.10/19_ series



GEV No.	375376	Ref. No.	85322001046 BN4185322001046
description	safety thermostat capillary pipe 870mm probe ø 6mm 1-pole probe L 133mm 0.5A capillary pipe isolatedmm gland nut M10x1 switch-off temp. 224°C probe		
For models:	SERIE 900, SERIE700		



GEV No.	375412	Ref. No.	6A044600 BN6A044600
description	thermostat t.max. 320°C temperature range 50-320°C 3-pole 3NO 16A probe ø 3.1mm probe L 226mm capillary pipe 1480mm capillary pipe isolated 1400mm gland nut shaft ø 6x4.6mm shaft L 23mm shaft position upper rotation 318°		



GEV No.	375886	Ref. No.	41826630240 BN826630240
description	safety thermostat switch-off temp. 140°C 1-pole 1NC 0.5A probe ø 3mm probe L 226mm capillary pipe 900mm capillary pipe isolated 840mm gland nut probe probe material SS		

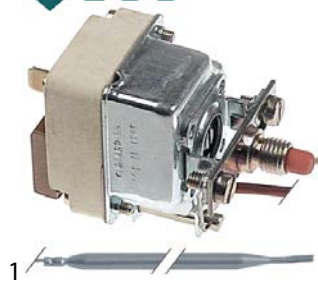

GEV No.	375617	Ref. No.	41826630390 BN41826630390
description	thermostat switch-off temp. 230°C 1-pole 1NC 16A probe ø 6mm probe L 133mm capillary pipe 870mm capillary pipe isolated 700mm gland nut probe SS mounting thread M8x1		
For models:	SERIE 600		



GEV No.	375888	Ref. No.	6A049407 BN6A049407
description	safety thermostat switch-off temp. 132°C 3-pole 3NC 20A probe ø 6mm probe L 87mm capillary pipe 890mm capillary pipe isolated 850mm gland nut starting temperature 118°C probe SS probe material SS		

55.14_series



GEV No.	375260	Ref. No.	A6010006
description	safety thermostat switch-off temp. 240°C 1-pole 16A probe ø 6mm probe L 77mm capillary pipe 1280mm capillary pipe isolated 1050mm gland nut M10x1 probe SS		



GEV No.	375622	Ref. No.	41853310064 BN41853310064
description	safety thermostat switch-off temp. 147°C 1-pole 20A probe ø 6mm probe L 89mm capillary pipe 900mm capillary pipe isolated 800mm gland nut probe		
For models:	SERIE 900, SERIE700		

55.32_series



GEV No.	375199	Ref. No.	MA1878900
description	safety thermostat switch-off temp. 132°C 3-pole 2x20/1x0.5A probe ø 6mm probe L 77mm capillary pipe 890mm capillary pipe isolated mm gland nut M10x1 probe SS		

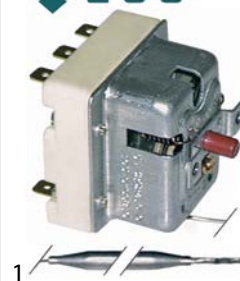

GEV No.	375277	Ref. No.	41826630350 85326010002 BN41826630350
description	safety thermostat switch-off temp. 150°C 3-pole 3NC 20A probe ø 6mm probe L 79mm capillary pipe 900mm capillary pipe isolated 700mm gland nut probe		
For models:	SERIE 600, SERIE 900, SERIE700		



GEV No.	375707	Ref. No.	41826630380 BN41826630380
description	safety thermostat switch-off temp. 230°C 3-pole 20A probe ø 6mm probe L 87mm capillary pipe 1490mm capillary pipe isolated 1100mm gland nut M9x1 probe SS		
For models:	SERIE 600		



GEV No.	375873	Ref. No.	1878600 MA1878600
description	safety thermostat switch-off temp. 236°C 3-pole 20A probe ø 6mm probe L 77mm capillary pipe 1190mm capillary pipe isolated 990mm gland nut starting temperature 218°C probe		
accessories for	375873		
	GEV No.	550148	Ref. No. —
	gland duct ET M12x0.75 IT M9x1 probe ø max. 6.5mm WS 17 silicone		



GEV No.	375375	Ref. No.	4185326010036 BN4185326010036 BN85326010036
description	safety thermostat switch-off temp. 230°C 3-pole 20A probe ø 6mm probe L 94mm capillary pipe 900mm capillary pipe isolated 670mm gland nut M10x1 probe SS		
For models:	SERIE 900, SERIE700		



GEV No.	375312	Ref. No.	8219602 BN8219602
description	safety thermostat switch-off temp. 245°C 3-pole 3NC 20A probe ø 4mm probe L 120mm capillary pipe 1800mm capillary pipe isolated 1800mm gland nut probe SS		
For models:	7FRI/E610		
accessories for	375312		
	GEV No.	550981	Ref. No. —
	probe clip for pipe ø 8.5mm for probe ø 6mm for heating elements spacing 0.4mm Qty 1 pcs		



GEV No.	375445	Ref. No.	MACM097701
description	safety thermostat switch-off temp. 230°C 3-pole 2x20/1x0.5A probe ø 4mm probe L 120mm capillary pipe 900mm capillary pipe isolated 700mm gland nut probe		



GEV No.	375635	Ref. No.	0A046190 BN6A046190
description	safety thermostat switch-off temp. 300°C 1-pole 20A probe ø 11mm probe L 16mm capillary pipe 900mm capillary pipe isolated 900mm gland nut screw-in probe probe thread M14x1		
For models:	ECVME 10, ECVME 20, ECVME 21, ECVME 6, ECVMG 10, ECVMG 20, ECVMG 21, ECVMG 6, ECVPE 10, ECVPE 20, ECVPE 21, ECVPE 6, ECVPG 10, ECVPG 20, ECVPG 21, ECVPG 6		



GEV No.	375357	Ref. No.	MA1942900
description	safety thermostat switch-off temp. 325°C 1-pole 0.5A probe ø 3mm probe L 188mm capillary pipe 900mm capillary pipe isolatedmm gland nut probe		



GEV No.	375599	Ref. No.	41826630010 BN826630010
description	safety thermostat switch-off temp. 360°C 1-pole 0.5A probe ø 6mm probe L 79mm capillary pipe 890mm capillary pipe isolatedmm gland nut probe SS		

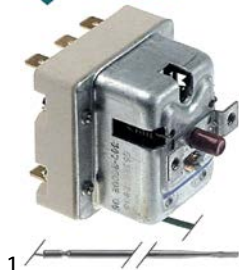

GEV No.	375562	Ref. No.	41826630130 BN826630130
description	safety thermostat switch-off temp. 360°C 3-pole 20A probe ø 4mm probe L 120mm capillary pipe 900mm capillary pipe isolated 900mm gland nut probe SS		



GEV No.	375187	Ref. No.	MA1878500
description	safety thermostat switch-off temp. 360°C 3-pole 3NC 2x20/1x0.5A probe ø 6mm probe L 79mm capillary pipe 890mm capillary pipe isolatedmm gland nut probe SS		

control thermostats with operation switch

55.10/19_ series

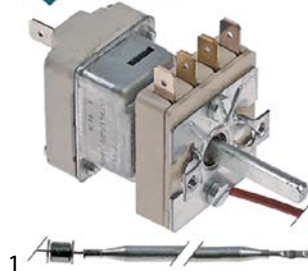

GEV No.	375875	Ref. No.	1037317300 MA1037317300
description	thermostat t.max. 180°C temperature range 53-180°C 1-pole 1NO 16A probe ø 6mm probe L 133mm capillary pipe 1170mm capillary pipe isolated 1000mm gland nut shaft ø 6x4.6mm shaft L 23mm rotation 270° outer switch 2NO		

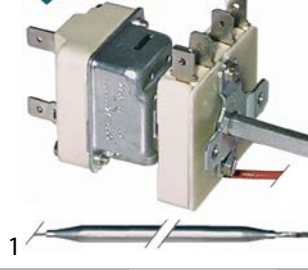

GEV No.	390039	Ref. No.	41826630230 BN826630230
description	thermostat t.max. 90°C temperature range 30-90°C 1-pole 1CO 16A probe ø 6mm probe L 173mm capillary pipe 980mm capillary pipe isolated 980mm gland nut shaft ø 6x4.6mm shaft L 23mm shaft position upper rotation 270° outer switch 2NO		

accessories for	390039			
	GEV No.	111934	Ref. No.	—
	knob thermostat t.max. 90°C ø 50mm shaft ø 6x4.6mm shaft flat upper black temperature range 30-90°C rotation 270°			

55.34_ series



GEV No.	375140	Ref. No.	CR0688650
description	thermostat t.max. 650°C temperature range 50°C/50-600°C/70-650°C 3-pole 3NO 16A probe ø 4mm probe L 228mm capillary pipe 1200mm capillary pipe isolated 1200mm gland nut shaft ø 6x4.6mm shaft L 23mm shaft position left rotation 318° outer switch 2NO		



various

safety thermostats

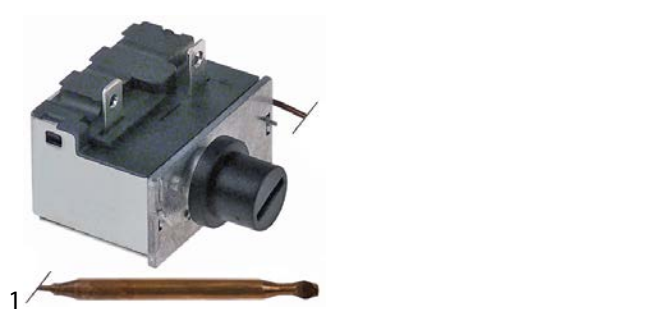

GEV No.	375637	Ref. No.	0A046185 BN6A046185
description	safety thermostat switch-off temp. 135°C temperature range°C 1-pole 1NC 16A probe ø 6mm probe L 75mm capillary pipe 600mm capillary pipe isolatedmm gland nut shaft ømm probe copper 250V		
For models:	ECVPE 10, ECVPE 20, ECVPE 21, ECVPE 6, ECVPG 10, ECVPG 20, ECVPG 21, ECVPG 6		



GEV No.	390194	Ref. No.	011DW2000430 BN011DW2000430
description	safety thermostat switch-off temp. 90-110°C 1-pole 16A probe ø 6.5mm probe L 87mm capillary pipe 1500mm capillary pipe isolated 1497mm connection male faston 6.3mm adjustable		

accessories

probe clips

spring clips

for safety thermostat



GEV No.	550417	Ref. No.	MA1033515200
description	probe clip for pipe ø 2x8.5mm for probe ø 6mm for heating elements spacing 15-19mm Qty 1 pcs		

capillary tube clips

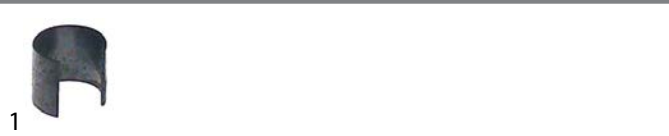

GEV No.	550970	Ref. No.	MA1033709500
description	capillary tube clip for pipe ø 8.5mm		

gland nut accessories

washers with slot

GEV No.	510241	Ref. No.	BN6A038803
description	washer with slot ED ø 7.8mm slit width 1.3mm Qty 10		

gaskets

GEV No.	550982	Ref. No.	6A038804 BN6A038804
description	gasket graphite ø 7.5mm L 7mm Qty 1 pcs for gland nut		
For models:	7FRI/G815		

locking screws

GEV No.	106605	Ref. No.	CM012401 MACM012401
description	union screw thread M10x1 probe ø max. 4.5mm		

connecting bows

GEV No.	550060	Ref. No.	6A045900 821550060 BN6A045900 MA1988500 MA921200
description	connecting bow long for thermostat Qty 1 pcs		

switches and momentary switches

push/momentary push switches

30x22mm

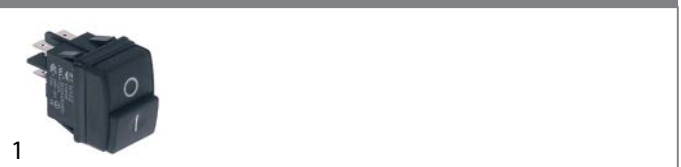

GEV No.	301086	Ref. No.	0A038550 BN6A038550
description	push switch mounting measurements 30x22mm black 2NO 250V 12A 0-1 connection male faston 6.3mm ambient temperature max. 85/55°C protection IP54 with protective collar		
For models:	ECVME 10, ECVME 20, ECVME 21, ECVME 6, ECVMG 10, ECVMG 20, ECVMG 21, ECVMG 6, ECVPE 10, ECVPE 20, ECVPE 21, ECVPE 6, ECVPG 10, ECVPG 20, ECVPG 21, ECVPG 6		



ø25mm

			
1			
GEV No.	345162 ¹	Ref. No.	41826630200 BN826630200
description	push switch mounting ø 25mm yellow 2NO 250V 16A illuminated connection male faston 6.3mm ambient temperature max. 85°C protection IP40		

¹illuminated

			
1			
GEV No.	346318	Ref. No.	41826630050 BN41826630050 BN826630050
description	momentary push switch mounting ø 25mm red 1NO 250V 16A with cover cap ignition connection male faston 6.3mm ambient temperature max. 85°C protection IP65		
For models:	SERIE 900, SERIE GIANO 110, SERIE GIANO 140, SERIE700		
accessories for	346318		

	GEV No.	345039	Ref. No.	41826630060 41826630420 826630060 826630420 BN826630060 BN826630420 CR0410310
protective cover round ED ø 33mm external size 23mm internal size 21mm H 12mm clear mounting ø 25mm				

				
1				
GEV No.	345039	Ref. No.	41826630060 41826630420 BN826630060 BN826630420 CR0410310	
description	protective cover round ED ø 33mm external size 23mm internal size 21mm H 12mm clear mounting ø 25mm			
For models:	7BM/E410, 7BMV/E800, 7FRI/G815, 7FT/G800, 7FTT/G405, 7FTT/G410, SERIE 600, SERIE 900, SERIE GIANO 110, SERIE GIANO 140, SERIE700			
accessories for	345039			
	GEV No.	345001	Ref. No.	—
momentary push switch mounting ø 25mm yellow 1NO/indicator light 250V 16A cover connection male faston 6.3mm ambient temperature max. 85°C protection IP65				

2 hole fixing

			
1			
GEV No.	346359	Ref. No.	3108870 BN3108870
description	momentary push switch connection cable ambient temperature max. 85°C protection IP40 door contact switch		
For models:	ECVME 10, ECVME 20, ECVME 21, ECVME 6, ECVMG 10, ECVMG 20, ECVMG 21, ECVMG 6, ECVPE 10, ECVPE 20, ECVPE 21, ECVPE 6, ECVPG 10, ECVPG 20, ECVPG 21, ECVPG 6		

accessories

blank elements

			
1			
GEV No.	346353	Ref. No.	3102870 BN3102870
description	dummy element		

microswitches

lever actuated

			
1			
GEV No.	345255	Ref. No.	41826630310
description	microswitch with lever 250V 16A 1CO connection male faston 6.3mm L 35mm L1 28mm ambient temperature max. 125°C mounting distance 22mm actuating force: 136g lever length 27mm		
For models:	SERIE 600, SERIE 900, SERIE700		

			
1			
GEV No.	345773	Ref. No.	85326043085
description	microswitch with lever 250V 16A 1CO connection male faston 6.3mm L 60mm ambient temperature max. 125°C mounting distance 22mm actuating force: 65g lever length 51mm		
For models:	SERIE 900, SERIE700		

pin-plunger actuated

			
1			
GEV No.	345326	Ref. No.	1037312900 MA1037312900
description	microswitch with plunger 250V 16A 1NO connection male faston 6.3mm ambient temperature max. 85°C mounting distance 22mm type XP52Z11 actuating force: 350g red stroke 15mm		







M10			
			
1			
GEV No.	345032	Ref. No.	6A039800 BN6A039800
description	microswitch with plunger thread M10x1 thread L 12mm 250V 16A 1CO connection male faston 6.3mm stroke 7mm mounting distance 22mm L 28mm ambient temperature max. 125°C type SP9603 actuating force: 180g		
For models:	7FRI/E610		

cam switches

on/off

			
1			
GEV No.	300021	Ref. No.	41826630290 BN41826630290 BN826630290 MA1230100
description	cam switch 4 operating positions 4NO sequence 0-1-0-1 16A shaft ø 6x4.6mm shaft L 23mm connection screw ceramic		
For models:	SERIE 600, SERIE 900, SERIE700		

7-position

			
1			
GEV No.	300025	Ref. No.	41826630070 BN41826630070 MA1616100
description	cam switch 7 operating positions 1NO/2CO sequence 0-1-2-3-4-5-6 16A shaft ø 6x4.6mm shaft L 23mm connection screw 7-position ceramic		
For models:	SERIE 600, SERIE 900, SERIE700		
accessories for	300025		
	GEV No.	112172	Ref. No. —
knob universal ø 70mm black without adaptor/dial plate			
	GEV No.	112213	Ref. No. —
knob dial plate silver switch 7-position t.max.°C ED ø 63mm ID ø 45.5mm			
	GEV No.	112311	Ref. No. —
knob adapter shaft ø 6x4.6mm L 0mm with spring			

4 operating positions

			
1			
GEV No.	300081	Ref. No.	MA1309000
description	cam switch 4 operating positions 3NO/2CO sequence 0-1-2-3 16A shaft ø 6x4.6mm shaft L 23mm connection screw		

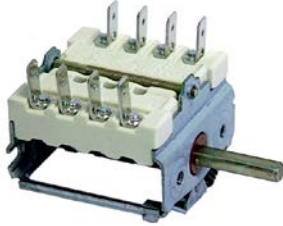
			
1			
GEV No.	300184	Ref. No.	41826630330 6A046750 BN41826630330 BN6A046750
description	cam switch 4 operating positions sequence 0-3-2-1 shaft ø 6x4.6mm connection male faston 4-pole		
For models:	SERIE 600		

			
1			
GEV No.	300239	Ref. No.	CR0581810
description	operation switch 4 operating positions 4NO sequence 0-1-2-3 16A shaft ø 6x4.6mm shaft L 23mm connection male faston 6.3mm plastic		

5 operating positions

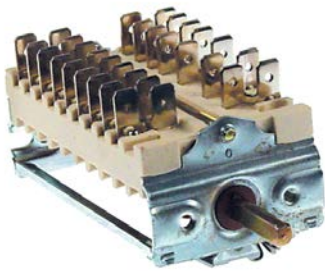
			
1			
GEV No.	346352	Ref. No.	0A046015 BN6A046015
description	cam switch 5 operating positions 5NO/2CO sequence 1-0-2-3-4 16A shaft ø 6x4.6mm shaft L 23mm connection male faston 6.3mm ceramic		



with potentiometer



GEV No.	300252	Ref. No.	CR0737320
description	potentiometer 2 operating positions 2NO sequence 0-1 16A shaft \varnothing 6x4.6mm shaft L 23mm connection coded plug cable length 1420mm 10kOhm 12V with cable and indicator light		

operation switches



GEV No.	300002	Ref. No.	41826630150 BN6A046001
description	cam switch 2 operating positions 4NO 16A sequence 0-1 shaft \varnothing 6x4.6mm shaft L 23mm connection male faston 6.3mm ceramic		
For models:	SERIE 600, SERIE 900, SERIE700		



GEV No.	300166	Ref. No.	4185326030019 BN4185326030019
description	cam switch 2 operating positions 4NO 16A sequence 0-1 shaft \varnothing 6x4.6mm shaft L 23mm connection male faston 6.3mm ceramic 4-pole ambient temperature max. 318°C		
For models:	SERIE 900, SERIE700		



GEV No.	300080	Ref. No.	65085010 710300 MA710300 R65085010
description	cam switch 2 operating positions 4NO 16A sequence 0-1 shaft \varnothing 6x4.6mm shaft L 23mm connection screw operation switch ceramic ambient temperature max. 150°C		
accessories for	300080		
	GEV No.	551456	Ref. No. —
gasket for switch ED \varnothing 14mm ID \varnothing 2.5mm thickness 3.5mm white			

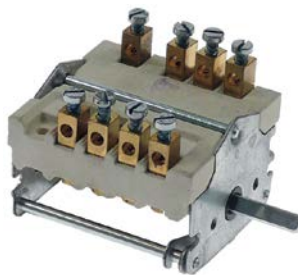

GEV No.	300180	Ref. No.	CR0686110
description	cam switch 2 operating positions operation switch 32A sequence 0-1 shaft \varnothing 6x4.6mm shaft L 23mm connection screw ceramic		



GEV No.	300200	Ref. No.	65260030 LAR65260030 MA1037313200
description	operation switch 2 operating positions 2NO 16A sequence 0-1 shaft \varnothing 6x4.6mm shaft L 23mm connection male faston 6.3mm operation switch ceramic		

magnetic switches

40x13mm

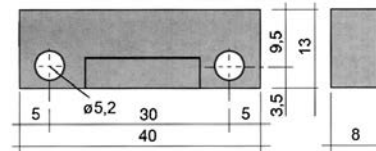

GEV No.	346351	Ref. No.	418SA047085 BN6A047085
description	magnetic switch L 40mm W 13mm 1NO 250V 0.04A P max. 10W connection cable cable length 650mm		



accessories

magnets

1

GEV No.	345336	Ref. No.	3108889 BN3108890
description	magnet ø 4.8mm L 63mm H 11mm W 18.8mm hole distance 51mm M4		
For models:	ECVME 10, ECVME 20, ECVME 21, ECVME 6, ECVMG 10, ECVMG 20, ECVMG 21, ECVMG 6, ECYPE 10, ECYPE 20, ECYPE 21, ECYPE 6, ECVPG 10, ECVPG 20, ECVPG 21, ECVPG 6		

miscellaneous

1

GEV No.	346360	Ref. No.	3108879 BN3108879
description	switch mounting pos. door		
For models:	ECVME 20, ECVME 21, ECVME 6, ECVMG 10, ECVMG 20, ECVMG 21, ECVMG 6, ECYPE 10, ECYPE 20, ECYPE 21, ECYPE 6, ECVPG 10, ECVPG 20, ECVPG 21, ECVPG 6		

control equipment

MOELLER/EATON

switches (complete)

rotary switches

1

GEV No.	346461	Ref. No.	LAR65080150
description	rotary switch mounting measurements ø22mm black latching 1NC/1NO sequence 0-1		

SIEMENS

3SB series ø16mm

fascias

1

GEV No.	346357	Ref. No.	3102860 BN3102860
description	blank mounting measurements ø16mm black		

push buttons

1

GEV No.	346356	Ref. No.	3102801 BN3102801
description	push button mounting measurements ø16mm green		

3SB series ø22mm old

1

GEV No.	346354	Ref. No.	3102803 BN3102803
description	contact block SIEMENS 1NO 3SB2404-0B brown max 250V 10A		

encoders and potentiometers

1

GEV No.	401194	Ref. No.	3103267 BN3103267
description	encoder		
For models:	ECVME 10, ECVME 20, ECVME 21, ECVME 6, ECVMG 10, ECVMG 20, ECVMG 21, ECVMG 6, ECYPE 10, ECYPE 20, ECYPE 21, ECYPE 6, ECVPG 10, ECVPG 20, ECVPG 21, ECVPG 6		

1

GEV No.	401338	Ref. No.	LAR65301450
description	encoder		



			
1			
GEV No.	300252	Ref. No.	CR0737320
description	potentiometer 2 operating positions 2NO sequence 0-1 16A shaft \varnothing 6x4.6mm shaft L 23mm connection coded plug cable length 1420mm 10kOhm 12V with cable and indicator light		

			
1			
GEV No.	300188	Ref. No.	3103260 BN3103260
description	potentiometer rotation 310° oven		

lamps

indicator lights

indicator lights 2-piece (lens and indicator lamp)

indicator light lenses

\varnothing 12mm (type SDY-3)

			
1			
GEV No.	359262	Ref. No.	6A001438 BN6A001438
description	indicator light housings mounting measurements \varnothing 12mm green round Qty 1 pcs		

			
1			
GEV No.	359261	Ref. No.	6A001436 BN6A001436
description	indicator light housings mounting measurements \varnothing 12mm red round Qty 1 pcs		

			
1			
GEV No.	359260	Ref. No.	6A001437 BN6A001437
description	indicator light housings mounting measurements \varnothing 12mm yellow round Qty 1 pcs		

indicator lamps for socket type SA / SC / SD / SF / SR			
			
1			
GEV No.	359522	Ref. No.	41826650050 BN41826650050 BN826650050
description	indicator lamp 400V green connection male faston 6.3mm Qty 1 pcs		
For models:	7BRF/E805, 7FRI/E610		

indicator lamps for socket type SRZ / SDK / SDY / SFK			
			
1			
GEV No.	359131	Ref. No.	6A038506
description	indicator lamp 400V clear connection male faston 6.3mm		
For models:	7BRF/E805, 7FRI/E610, 7NP/EI50		



			
1			
GEV No.	359133	Ref. No.	6A001435
description	indicator lamp 400V green connection male faston 6.3mm		



indicator lights (complete)			
\varnothing 10mm			
with screw socket			
			
1			
GEV No.	359380	Ref. No.	CR0682520
description	indicator light \varnothing 10mm 230V red connection male faston 6.3mm socket screw base		

			
1			
GEV No.	359379	Ref. No.	CR0587500
description	indicator light \varnothing 10mm 230V yellow connection male faston 6.3mm socket screw base		

\varnothing 12mm			
with screw socket			
			
1			
GEV No.	359994	Ref. No.	6A039207 BN6A039207
description	indicator light \varnothing 12mm 400V clear connection male faston 6.3mm		
For models:	7BM/E410, 7BMV/E800, 7BRF/E805, 7FRI/E610, 7NP/EI50		



ø13mm			
with screw socket			
			
1			
GEV No.	359145	Ref. No.	41826650020 41826650021 BN41826650021
description	indicator light ø 13mm 230V green t.max. 120°C		
For models:	SERIE 600, SERIE 900, SERIE GIANO 110, SERIE700		
accessories for	359145		
	GEV No.	Ref. No.	—
	510302		
	O-ring EPDM ID ø 12.42mm thickness 1.78mm Qty 1 pcs		
	GEV No.	Ref. No.	—
	511505		
	O-ring EPDM thickness 1.78mm ID ø 12.42mm Qty 10 pcs		

			
1			
GEV No.	359146	Ref. No.	41826650030 41826650031 BN41826650031
description	indicator light ø 13mm 230V yellow		
For models:	SERIE 600, SERIE 900, SERIE GIANO 110, SERIE700		
accessories for	359146		
	GEV No.	Ref. No.	—
	510302		
	O-ring EPDM ID ø 12.42mm thickness 1.78mm Qty 1 pcs		
	GEV No.	Ref. No.	—
	511505		
	O-ring EPDM thickness 1.78mm ID ø 12.42mm Qty 10 pcs		

ø18mm			
			
1			
GEV No.	346358	Ref. No.	3102850 BN3102850
description	lamp socket ø 18mm 230V without cap		

fluorescent lamps

accessories			
ballasts			
			
1			
GEV No.	401187	Ref. No.	0A047060 BN6A047060
description	electrical ballast 60W for fluorescent lamps		
For models:	ECVME 10, ECVME 20, ECVME 6, ECVME 10, ECVMG 20, ECVMG 6, ECVPE 10, ECVPE 20, ECVPE 6, ECVPG 10, ECVPG 20, ECVPG 6		

oven lamps

sockets			
G4 / G5,3 / G6,35			
			
1			
GEV No.	359836	Ref. No.	3108860 BN3108860
description	lamp socket socket G4 for halogen lamp		
For models:	ECVME 10, ECVME 20, ECVME 21, ECVME 6, ECVMG 10, ECVMG 20, ECVMG 21, ECVMG 6, ECVPE 10, ECVPE 20, ECVPE 21, ECVPE 6, ECVPG 10, ECVPG 20, ECVPG 21, ECVPG 6		

residual heat indicators

			
1			
GEV No.	359326	Ref. No.	41853400070 BN41853400070
description	residual heat indicator 4-fold		
For models:	SERIE 600, SERIE 900, SERIE700		

			
1			
GEV No.	359328	Ref. No.	41853400080 BN41853400080
description	residual heat indicator double		
For models:	SERIE 600, SERIE 900, SERIE700		



timers

programme timers

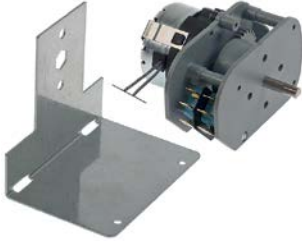

1

GEV No.	360633	Ref. No.	0A047080
description	time switch kit 14000F3 operation time 120min impulse electric shaft ø 6x4.6mm shaft L 20mm CDC 230V engines 1 chambers 2		



1

GEV No.	360336	Ref. No.	3102335 BN3102335
description	timer FIBER P25 engines 1 chambers 1 operation time 30s 230V shaft ø 6x4.6mm shaft L 18mm manuf. no. P255J01C6R7 motor type M51BJ0R6400		
For models:	ECVME 10, ECVME 20, ECVME 21, ECVME 6, ECVMG 10, ECVMG 20, ECVMG 21, ECVMG 6, ECVPE 10, ECVPE 20, ECVPE 21, ECVPE 6, ECVPG 10, ECVPG 20, ECVPG 21, ECVPG 6		
spare parts for	360336		
	GEV No.	360673	Ref. No. —
	motor kit pinion ø 6.8mm teeth 15 230V voltage AC 50/60Hz turn direction clockwise motor ø 48mm H 18.5mm motor type UDS-40NE1RNZ165 cable length 150mm with holder		



1

GEV No.	360337	Ref. No.	3102320 BN3102320
description	timer FIBER P25 engines 1 chambers 2 operation time 8min 230V shaft ø 6mm shaft Lmm manuf. no. P255J02J2E4 motor type M51BJ0R6400		
spare parts for	360337		
	GEV No.	360673	Ref. No. —
	motor kit pinion ø 6.8mm teeth 15 230V voltage AC 50/60Hz turn direction clockwise motor ø 48mm H 18.5mm motor type UDS-40NE1RNZ165 cable length 150mm with holder		

alarm devices

buzzers



1

GEV No.	350086	Ref. No.	LA65301440 LAR65301440
description	buzzer 12VDC connection cable 200mm PCB buzzer 20dB		



1

GEV No.	350080	Ref. No.	3103266 BN3103266
description	buzzer buzzer		
For models:	ECVME 10, ECVME 20, ECVME 21, ECVME 6, ECVMG 10, ECVMG 20, ECVMG 21, ECVMG 6, ECVPE 10, ECVPE 20, ECVPE 21, ECVPE 6, ECVPG 10, ECVPG 20, ECVPG 21, ECVPG 6		

contactors

GENERAL ELECTRIC (AEG)

power contactors



1

GEV No.	380239	Ref. No.	0A047031 6A047031 BN6A047031
description	power contactor resistive load 20A 230VAC (AC3/400V) 8.4A/4kW main contacts 3NO auxiliary contacts 1NC connection screw connection type LS05 01A type AEG LS05 01A type GE MC1A 301A		
For models:	ECVME 6, ECVPE 6, ECVPG 6		



1

GEV No.	380337	Ref. No.	0A047037 BN0A047037 BN6A047037
description	power contactor resistive load 20A 230VAC (AC3/400V) 8.4A/4kW main contacts 4NO auxiliary contacts connection screw connection type AEG LS05 400A type GE MC1A 400A		
For models:	ECVME 10, ECVME 20, ECVME 21, ECVME 6, ECVMG 10, ECVMG 20, ECVMG 21, ECVMG 6, ECVPE 10, ECVPE 20, ECVPE 21, ECVPE 6, ECVPG 10, ECVPG 20, ECVPG 21, ECVPG 6		

1

GEV No.	380245	Ref. No.	0A047034 BN6A047034
description	power contactor resistive load 25A 230VAC (AC3/400V) 9A/4kW main contacts 3NO auxiliary contacts 1NC connection screw connection type AEG LS4K 01A type GE CL00A 301 H 85mm		
For models:	ECVME 10, ECVME 6, ECVPE 10, ECVPE 20, ECVPE 21, ECVPE 6, ECVPG 10, ECVPG 20, ECVPG 21		



1

GEV No.	380385	Ref. No.	0A047035 BN6A047035
description	power contactor resistive load 60A 230VAC (AC3/400V) 32A/16kW main contacts 3NO auxiliary contacts 1NC connection screw connection type AEG LS15K 01A type GE CL04A 310		
For models:	ECVME 20, ECVME 21, ECVPE 20, ECVPE 21		



1

GEV No.	380262	Ref. No.	0A047036 BN6A047036
description	power contactor resistive load 32A 230VAC (AC3/400V) 17A/7.5kW main contacts 3NO auxiliary contacts 1NC connection screw connection type AEG LS7K01A type GE CL02A 301 H 85mm		
For models:	ECVME 20, ECVPE 10, ECVPE 20		

auxiliary contacts



1

GEV No.	380242	Ref. No.	0A047038 BN6A047038
description	auxiliary contact contacts 1NO/1NC for contactors M+LS05 connection screw AC-12 10A type AEG HS05K 11HS type GE MARN 211		
For models:	ECVME 21, ECVME 6, ECVMG 10, ECVMG 20, ECVMG 21, ECVMG 6, ECVPE 10, ECVPE 20, ECVPE 21, ECVPE 6, ECVPG 10, ECVPG 20, ECVPG 21, ECVPG 6		



1

GEV No.	380261	Ref. No.	41853310065 BN41853310065
description	power contactor resistive load 32A 230VAC (AC3/400V) 17A/7.5kW main contacts 3NO auxiliary contacts 1NO connection screw connection type AEG LS7K 10A type GE CL02A 310		
For models:	SERIE 900, SERIE700		



1

GEV No.	380243	Ref. No.	0A047039 BN6A047039
description	auxiliary contact contacts 2NO/2NC for contactors M+LS05 connection screw AC-12 10A type AEG HS05K 22HS type GE MARN 422		



1

GEV No.	380387	Ref. No.	0A047040 BN6A047040
description	auxiliary contact contacts 3NO/1NC AC15 6A for contactors M+LS05 connection screw AC-12 10A		



ISKRA (FANAL)

power contactors





GEV No.	380204	Ref. No.	85326046038
description	power contactor resistive load 25A 230VAC (AC3/400V) 9A/4kW main contacts 3NO auxiliary contacts 1NO connection screw connection type Fanal DSL9 10 type ISKRA KNL9 10		
For models:	SERIE 600, SERIE 900, SERIE700		

LOVATO

power contactors



GEV No.	380855	Ref. No.	6A047200 BN826630300
description	power contactor resistive load 25A 230VAC (AC3/400V) 4.2kW main contacts 3NO auxiliary contacts 1NO		
accessories for	380855		
	GEV No.	380055	Ref. No. —
	RC circuit voltage AC/DC suitable for BF09-32 rated 240V		
	GEV No.	380118	Ref. No. —
	auxiliary contact contacts 1NO/1NC AC1 10A for contactors BF series connection screw type G480/11		

SIEMENS

power contactors



GEV No.	381387	Ref. No.	CM187301 MACM187301
description	power contactor resistive load 22A 230VAC (AC3/400V) 4kW main contacts 3NO auxiliary contacts 1NO connection screw connection type 3RT2016-1AP01		



GEV No.	380389	Ref. No.	187300 CM187300 MACM187300
description	power contactor resistive load 22A 230VAC (AC3/400V) 9A/4kW main contacts 3NO auxiliary contacts 1NO connection screw connection type 3RT10-16-1AP01		

relays

power relays

with bracket mounting



GEV No.	380139	Ref. No.	41826630250 BN826630250
description	power relays FINDER 230VAC 16A 2CO connection F6.3 bracket mounting dimensions 68x38.2x35.8mm manuf. no. 62.82.8.230.0000		
For models:	SERIE 900, SERIE700		

with male contacts

bullet connectors, 8 contacts

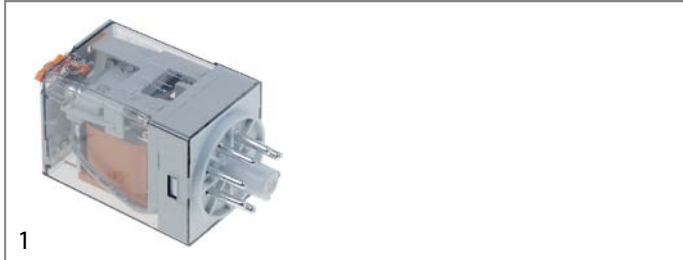

GEV No.	380951	Ref. No.	CR0683840
description	power relays FINDER 230VAC 10A 2CO connection plug-in connection round 8-pole manuf. no. 60.12.4.101.0040 90.26/ZVE8 250V		



female contact 2.0mm

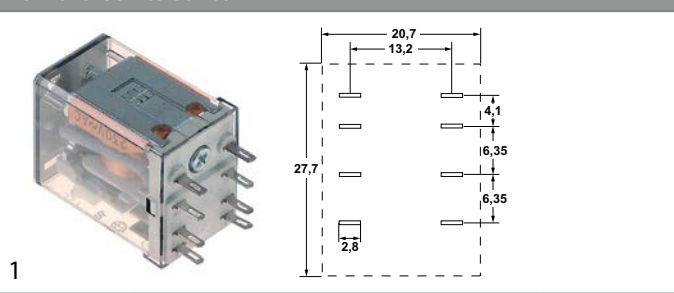

GEV No.	380377	Ref. No.	0A047070 FR995940
description	power relays FINDER 220-240VAC 10A 2CO connection F2 plug-in connection manuf. no. 55.32.8.230.0000 94.92.3 250V		
accessories for	380377		
	GEV No.	380341	Ref. No. —
	relay socket 4-pole contacts 12 300V voltage AC 6A Italiana Relè manuf. no. ZMD4		
	GEV No.	380378	Ref. No. —
	relay socket 2-pole 55/85 dimensions 70.5x30x27mm 250V voltage AC 10A FINDER manuf. no. 94.72		
	GEV No.	380384	Ref. No. 0A047074 BN6A047074
	relay socket 2-pole contacts male faston 2.8mm 250V voltage AC 10A W 23mm for		
	GEV No.	380399	Ref. No. —
	relay socket 4-pole dimensions 76.2x27x86.1mm 250V voltage AC 1A FINDER manuf. no. 94.94.3		

relay sockets

	GEV No.	380384	Ref. No.	0A047074 BN6A047074
	description	relay socket 2-pole contacts male faston 2.8mm 250V voltage AC 10A W 23mm for		
	accessories for	380384		
	GEV No.	380804	Ref. No.	—
		support bracket		

	GEV No.	380638	Ref. No.	MA2609500
	description	relay socket 8-pole dimensions 51x41x23mm 250V 10A FINDER manuf. no. 90.26		

time relays

time relays

	GEV No.	380386	Ref. No.	0A047065 BN6A047065
	description	time relay CROUZET MUS2-88826004 time range 0.1s-100h 24-240VAC 0.7A 1NO connection grip connection		

transformers

open transformers

with clamp terminal

	GEV No.	401189	Ref. No.	0A047047 BN6A047047
	description	transformer 20VA		
	For models:	ECVME 10, ECVME 20, ECVME 21, ECVME 6, ECVMG 10, ECVMG 20, ECVMG 21, ECVMG 6, ECVPE 10, ECVPE 20, ECVPE 21, ECVPE 6, ECVPG 10, ECVPG 20, ECVPG 21, ECVPG 6		

for lighting

	GEV No.	401188	Ref. No.	0A047061 BN6A047061
	description	transformer primary 240V secondary 11.5V 100VA		
	For models:	ECVME 21, ECVMG 21, ECVPE 21, ECVPG 21		



probes

producer-specific probes

probes

1 

GEV No.	379936	Ref. No.	3103275 BN3103275
description	temperature probe Pt100 cable Vetrotex probe -200 up to +600°C cable -50 up to +350°C connection 2-wire thread probe ø4-6x100mm cable length 1m		
For models:	ECVME 10, ECVME 20, ECVME 21, ECVME 6, ECVMG 20, ECVMG 21, ECVMG 6, ECVPE 10, ECVPE 20, ECVPE 21, ECVPE 6, ECVPG 10, ECVPG 20, ECVPG 21, ECVPG 6		

1 

GEV No.	379935	Ref. No.	3103270 BN3103270
description	temperature probe Pt100 cable Vetrotex probe -200 up to +600°C cable -50 up to +350°C connection 2-wire thread probe ø6x100mm cable length 0.8m		

1 

GEV No.	379937	Ref. No.	3103282 BN3103282
description	temperature probe thermocouple K (NiCr-Ni) cable PTFE probe -50 up to 1150°C cable -40 up to +250°C connection 2-wire thread probe ø4x120mm cable length 2.4m -40 up to +250°C		
For models:	ECVME 10, ECVME 20, ECVME 21, ECVME 6, ECVMG 10, ECVMG 20, ECVMG 21, ECVMG 6, ECVPE 10, ECVPE 20, ECVPE 21, ECVPE 6, ECVPG 10, ECVPG 20, ECVPG 21, ECVPG 6		

core probes

1 

GEV No.	379939	Ref. No.	3103280 BN3103280
description	core temperature probe Pt100 cable PTFE probe -40 up to +250°C cable -40 up to +250°C connection plug probe ø4x100mm thread cable length 1.25m handle ø 10mm handle length 90/100mm		
For models:	ECVME 10, ECVME 20, ECVME 21, ECVME 6, ECVMG 10, ECVMG 20, ECVMG 21, ECVMG 6, ECVPE 10, ECVPE 20, ECVPE 21, ECVPE 6, ECVPG 10, ECVPG 20, ECVPG 21, ECVPG 6		
accessories for	379939		
	GEV No.	379938	Ref. No.
			3103285 BN3103285
			female connector 4-pole

accessories

plugs/bushes

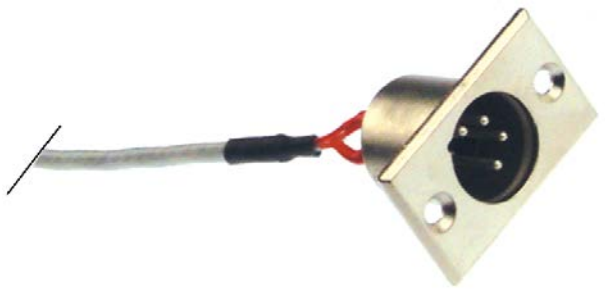
1 

GEV No.	379938	Ref. No.	3103285 BN3103285
description	female connector 4-pole		
For models:	ECVME 10, ECVME 20, ECVME 21, ECVME 6, ECVMG 10, ECVMG 20, ECVMG 21, ECVMG 6, ECVPE 10, ECVPE 20, ECVPE 21, ECVPE 6, ECVPG 10, ECVPG 20, ECVPG 21, ECVPG 6		

1 

GEV No.	379940	Ref. No.	3103290 BN3103290
description	lid		
For models:	ECVME 10, ECVME 20, ECVME 21, ECVME 6, ECVMG 10, ECVMG 20, ECVMG 21, ECVMG 6, ECVPE 10, ECVPE 20, ECVPE 21, ECVPE 6, ECVPG 10, ECVPG 20, ECVPG 21, ECVPG 6		

electronics

PCBs

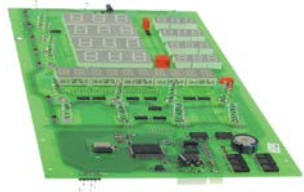
1 

GEV No.	401191	Ref. No.	3103251 BN3103251
description	keypad PCB		
For models:	ECVME 10, ECVME 20, ECVME 21, ECVME 6, ECVMG 10, ECVMG 20, ECVMG 21, ECVMG 6, ECVPE 10, ECVPE 20, ECVPE 21, ECVPE 6, ECVPG 10, ECVPG 20, ECVPG 21, ECVPG 6		

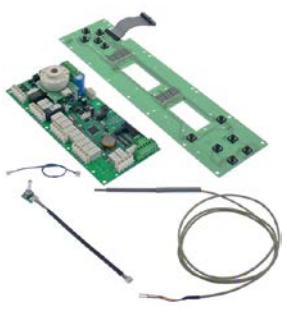
1

GEV No.	401958	Ref. No.	LAR65302150 LAR65302190
description	keypad PCB combi-steamer without steam generator suitable for LAINOX 2 type K probes		
spare parts for	401958		
	GEV No.	Ref. No.	—
	temperature probe Pt100 cable Vetrotex probe -200 up to +600°C cable -50 up to +350°C probe ø6x100mm cable length 1.4m without screw connection 3-wire resistance at 0°C 1000hm		
	GEV No.	Ref. No.	—
	temperature probe thermocouple K (NiCr-Ni) probe -50 up to 1150°C cable -50 up to +180°C cable length 1.5m thread M10x1 adapter length 93mm adapter ø 6mm cable colours silver/yellow probe L 90/14mm probe ø 6/3mm		
accessories for	401958		
	GEV No.	Ref. No.	—
	temperature probe thermocouple K (NiCr-Ni) probe -50 up to 1150°C cable -50 up to +180°C cable length 1.5m thread M10x1 adapter length 93mm adapter ø 6mm cable colours silver/yellow probe L 90/14mm probe ø 6/3mm		

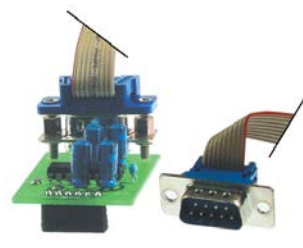

1

GEV No.	401193	Ref. No.	3103246 BN3103246
description	PCB HACCP interface		
For models:	ECVME 10, ECVME 20, ECVME 21, ECVME 6, ECVMG 10, ECVMG 20, ECVMG 21, ECVMG 6, ECYPE 10, ECYPE 20, ECYPE 21, ECYPE 6, ECVP 10, ECVP 20, ECVP 21, ECVP 6		



1

GEV No.	402972	Ref. No.	011AD160001 41853400170 6A001408 BN011AD160001 BN6A001408
description	relay PCB L 69mm W 59mm		

solenoïd valves

solenoïd valves (water)



1

GEV No.	401192	Ref. No.	3103249 BN3103249
description	main PCB		
For models:	ECVME 10, ECVME 20, ECVME 21, ECVME 6, ECVMG 10, ECVMG 20, ECVMG 21, ECVMG 6, ECYPE 10, ECYPE 20, ECYPE 21, ECYPE 6, ECVP 10, ECVP 20, ECVP 21, ECVP 6		

ELBI

angled



1

GEV No.	370833	Ref. No.	CR0682320 CR0682320R
description	solenoid valve single angled 230VAC inlet 3/4" outlet 11.5mm input 18.5-20l/min DN10 ELBI		



1

GEV No.	401195	Ref. No.	3103245 3198400 BN3103245 BN3198400
description	PCB combi-steamer CV10E complete without potentiometer		

RPE



1

GEV No.	374021	Ref. No.	3103610 BN3103610
description	solenoid valve double straight 230VAC inlet 3/4" outlet 10mm DN10 RPE		
For models:	ECYPE 10, ECYPE 20, ECYPE 21, ECYPE 6, ECVP 10, ECVP 21, ECVP 6		



			
1			
GEV No.	374017	Ref. No.	3103620 BN3103620
description	solenoid valve single straight 230VAC inlet 3/4" outlet 10mm input 6l/min DN10 RPE polyamide flow regulating valve inlet white membranes NBR pressure range 0.2-10bar		
For models:	ECVME 10, ECVME 20, ECVME 21, ECVME 6, ECVMG 10, ECVMG 20, ECVMG 21, ECVMG 6		

TP
solenoid valves with reducers

			
1			
GEV No.	370354	Ref. No.	41826630220 BN826630220
description	solenoid valve single angled 230VAC inlet 3/4" outlet 11.5mm output 5l/min t.max. 90°C TP plastic flow regulating valve outlet black flow regulating valve inlet white		

metal
CEME
solenoid valves

			
1			
GEV No.	370353	Ref. No.	3103600 BN3103600
description	solenoid valve 2-ways 230VAC inlet 1/2" IT outlet 1/2" IT L 61mm brass		

ball valves electric

			
1			
GEV No.	401190	Ref. No.	3103590 BN3103590
description	ball valve inlet 3/4" IT outlet 3/4" IT IP42 230V L 68mm 50/60Hz closed off-current mode of operation electric connection cable 300mm 3.5W duty cycle 50%		
For models:	ECVPE 10, ECVPE 20, ECVPE 21, ECVPE 6, ECVPG 10, ECVPG 20, ECVPG 21, ECVPG 6		

pressure switches

for steam control

			
1			
GEV No.	541795	Ref. No.	CR0587800
description	pressure control ø 45mm pressure connection vertical steam control pressure range -1 up to +1bar connection male faston 6.3mm BECK pressure connection 3/8"		

			
1			
GEV No.	541074	Ref. No.	3103630 BN3103630 LAR63070050
description	pressure control ø 45mm triggering pressure 0.5bar reset pressure 0.35bar pressure connection vertical steam control pressure range 0.35/0.51bar connection 1/8" pressure connection 1/8"		
For models:	ECVME 10, ECVME 20, ECVME 21, ECVME 6, ECVMG 10, ECVMG 20, ECVMG 21, ECVMG 6		

electrodes

			
1			
GEV No.	401208	Ref. No.	0A037482 BN6A037482
description	level electrode 1/4" total length 150mm probe L 124mm insulated probe length 69mm PTFE insulated connection male faston 6.3mm stainless steel ø 2.5mm		
For models:	ECVME 10, ECVME 20, ECVME 21, ECVME 6, ECVMG 10, ECVMG 20, ECVMG 21, ECVMG 6, ECVPE 10, ECVPE 20, ECVPE 21, ECVPE 6, ECVPG 10, ECVPG 20, ECVPG 21, ECVPG 6		



			
1			
GEV No.	401209	Ref. No.	0A037481 BN6A037481
description	level electrode 1/4" total length 180mm probe L 155mm insulated probe length 70mm PTFE insulated connection male faston 6.3mm stainless steel ø 2.5mm		
For models:	ECVME 10, ECVME 20, ECVME 21, ECVME 6, ECVMG 10, ECVMG 20, ECVMG 21, ECVMG 6, ECVPE 10, ECVPE 20, ECVPE 21, ECVPE 6, ECVPG 10, ECVPG 20, ECVPG 21, ECVPG 6		

fans



axial fans

ebm-papst



			
1			
GEV No.	601030 ¹	Ref. No.	3102350 65060050 BN3102350 LA65060050 LAR65060050
description	axial fan L 119mm W 119mm H 38mm 230VAC 50Hz 18W bearing ball bearing manuf. no. 4656Z metal connection male faston 2.8mm ebm-papst fan wheel ø 110mm temp.-resist. 75°C		
For models:	ECVME 10, ECVME 20, ECVME 21, ECVME 6, ECVMG 10, ECVMG 20, ECVMG 21, ECVMG 6, ECVPE 10, ECVPE 20, ECVPE 21, ECVPE 6, ECVPG 10, ECVPG 20, ECVPG 21, ECVPG 6		
accessories for	601030		
	GEV No.	550898	Ref. No. —
	connecting cable cable length 2000mm connection F 2.8 connection distance 7.9mm for axial flow fan		
	GEV No.	692497	Ref. No. —
	guard ø 105mm mounting distance 150mm for axial fan ebm-papst-mm		

¹with ball bearings

import

			
1			
GEV No.	601080 ¹	Ref. No.	MACM303000
description	axial fan L 119mm W 119mm H 38mm 230VAC 50/60Hz 23/20W bearing ball bearing connection male faston 2.8mm metal ADDA fan wheel ø 110mm temp.-resist. 70°C		
accessories for	601080		
	GEV No.	550898	Ref. No. —
	connecting cable cable length 2000mm connection F 2.8 connection distance 7.9mm for axial flow fan		
	GEV No.	692519	Ref. No. —
	guard L 120mm W 120mm plastic		

¹with ball bearings

			
1			
GEV No.	602074	Ref. No.	FR995910
description	axial fan 230 50/60Hz 66/80W connection cable 2400mm blowing fan wheel ø 200mm 2490/2745rpm		
accessories for	602074		
	GEV No.	365198	Ref. No. —
	operating capacitor capacity 2µF 450V 50/60Hz ambient temperature max. -25 up to +70°C ø 40mm L 61mm M8 aluminium connection male faston 6.3mm		



hot air motors

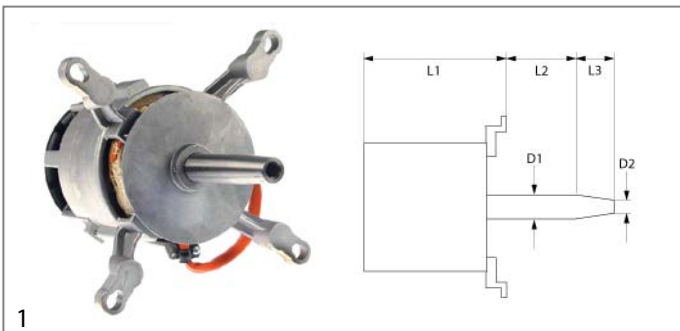

GEV No.	500644	Ref. No.	3102300 BN3102300
description	fan motor 230/400V 3 phase 50/60Hz 0.55kW 0.58HP 1420/1700rpm speeds 1 L1 188mm L2 67mm L3 46mm D1 ø 24mm D2 ø 20mm M12L IT 1.1/1.9A Cos(fi) 0.6 at 50Hz 1420/1700rpm type ST80/4 no. 654282 mounting distance 185mm		
accessories for	500644		
	GEV No.	560449	Ref. No. —
	hexagonal screw thread M12x1.5 L thread L 22mm bore ø 6.3mm WS 19 total length 30mm		

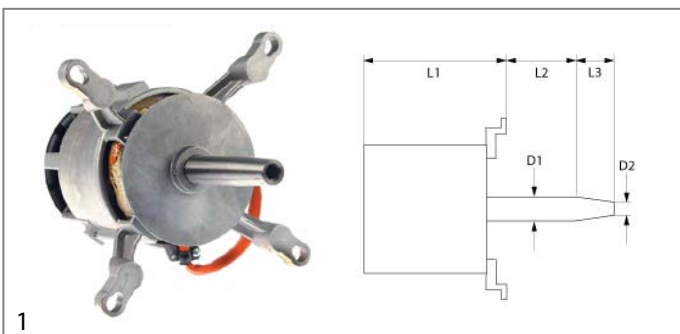

GEV No.	500646	Ref. No.	3102200 BN3102200
description	fan motor 230V 1 phase 50/60Hz 0.55kW 1400/1680rpm speeds 1 L1 188mm L2 67mm L3 47mm D1 ø 24mm D2 ø 20mm M12L IT 2.4A suitable capacitor 20µF/450V Cos(fi) 0.95 at 50Hz 1400rpm at 60Hz 1680rpm type LM80/4 no. 601259		
accessories for	500646		
	GEV No.	365019	Ref. No. —
	operating capacitor capacity 20µF 400V tolerance 5% 50/60Hz ambient temperature max. -25 to +85°C ø 39.5mm L 70mm M8 plastic connection male faston 6.3mm 16.10.25. protection		
	GEV No.	560449	Ref. No. —
	hexagonal screw thread M12x1.5 L thread L 22mm bore ø 6.3mm WS 19 total length 30mm		

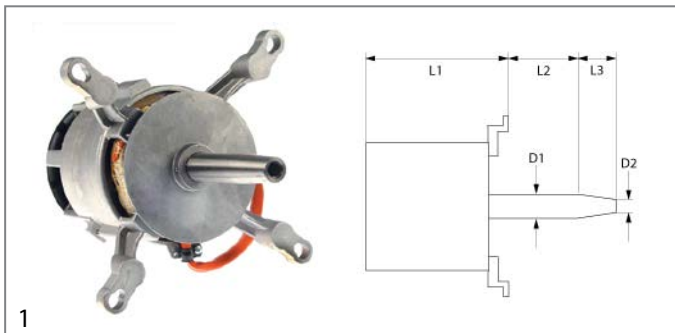

GEV No.	500647	Ref. No.	3102210 BN3102210
description	fan motor 230V 1 phase 50Hz 0.13/0.55kW 700/1400rpm speeds 2 L1 188mm L2 64mm L3 46mm D1 ø 24mm D2 ø 20mm 0.66/2.4A suitable capacitor 25µF Cos(fi) 0.98 at 50Hz 700/1400rpm at 60Hz 850/1700rpm 4P/8P type LM/FB80 no. 483823		

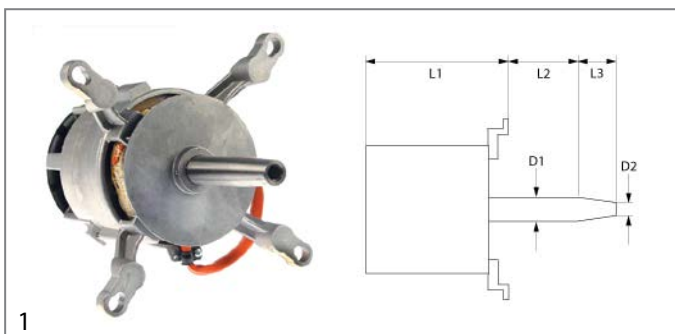

GEV No.	500649	Ref. No.	3102212 BN3102212
description	fan motor 230V 1 phase 50Hz 0.13/0.55kW 700/1400rpm speeds 2 L1 200mm L2 67mm L3 47mm D1 ø 24mm D2 ø 20mm M12L IT 0.66/2.4A suitable capacitor 8/25 µF Cos(fi) 0.98 at 50Hz 700/1400rpm at 60Hz 850/1700rpm 4P/8P type LM/FB80 no. 635521		
For models:	ECVME 10, ECVME 20, ECVME 21, ECVME 6, ECVMG 10, ECVMG 20, ECVMG 21, ECVMG 6, ECVPE 10, ECVPE 20, ECVPE 21, ECVPE 6		

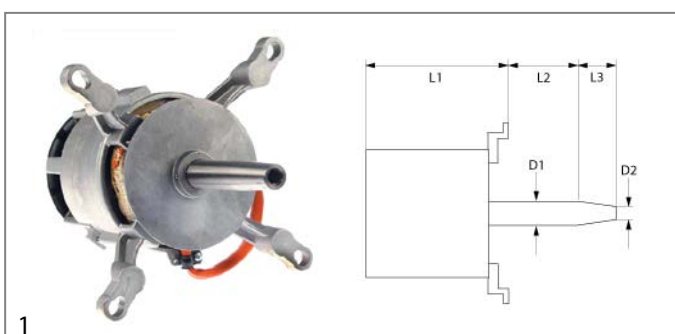

GEV No.	500645	Ref. No.	3102310 BN3102310
description	fan motor 400V 3 phase 50Hz 0.13/0.55kW 720/1440rpm speeds 2 L1 188mm L2 64mm L3 46mm D1 ø 24mm D2 ø 20mm 0.4/0.85A Cos(fi) 0.60/0.75 at 50Hz 720/1440rpm at 60Hz 860/1720rpm type FB80 4/8 no. 520481		

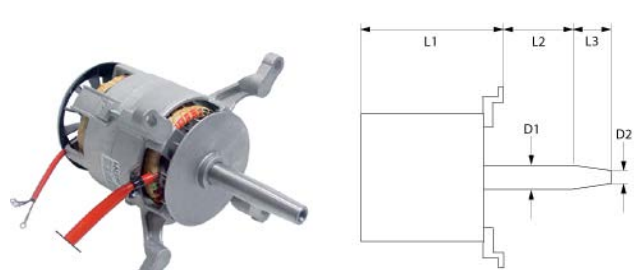
1

GEV No.	500648	Ref. No.	3103212 BN3102312
description	fan motor 400V 3 phase 50Hz 0.13/0.55kW 720/1440rpm speeds 2 L1 198mm L2 65mm L3 47mm D1 ø 24mm D2 ø 20mm M12L IT 400 0.4/0.85A Cos(fi) 0.60/0.75 at 50Hz 720/1440rpm at 60Hz 860/1720rpm type FB80 4/8 no. 500256		
For models:	ECVME 10, ECVME 20, ECVME 21, ECVME 6, ECVPE 10, ECVPE 20, ECVPE 21, ECVPE 6, ECVPG 10, ECVPG 20, ECVPG 21, ECVPG 6		



1

GEV No.	601214	Ref. No.	3101630 BN3101630
description	fan wheel D1 ø 335mm H1 135mm blades 12 D2 ø 19.5mm D3 ø 23.5mm H2 51mm		
For models:	ECVME 20, ECVMG 20, ECVPE 20, ECVPG 20		
accessories for	601214		
	GEV No.	560449	Ref. No. —
	hexagonal screw thread M12x1.5 L thread L 22mm bore ø 6.3mm WS 19 total length 30mm		



1

GEV No.	601213	Ref. No.	3101600 BN3101600
description	fan wheel D1 ø 335mm H1 135mm blades 16 D2 ø 19.5mm D3 ø 23.5mm H2 50.5mm		
For models:	ECVME 10, ECVME 21, ECVME 6, ECVMG 10, ECVMG 21, ECVMG 6, ECVPE 10, ECVPE 21, ECVPE 6, ECVPG 10, ECVPG 21, ECVPG 6		



1

GEV No.	550850	Ref. No.	3102500 BN3102500
description	flange pair for fan motor ED ø 70mm int. ø 1 43.5mm int. ø 2 24.5mm thickness 5mm brass		
For models:	ECVME 10, ECVME 20, ECVME 21, ECVME 6, ECVMG 10, ECVMG 20, ECVMG 21, ECVMG 6, ECVPE 10, ECVPE 20, ECVPE 21, ECVPE 6, ECVPG 10, ECVPG 20, ECVPG 21, ECVPG 6		



1



GEV No.	550849	Ref. No.	3102400 BN3102400
description	gasket for fan motor ID ø 24mm ED ø 36mm thickness 4.5mm		

hot air fans

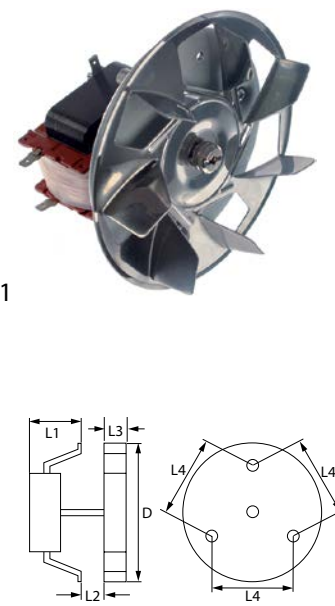
miscellaneous



1

GEV No.	601696	Ref. No.	MA4330800
description	hot air fan 230V 40W 50/60Hz L1 70mm L2 11mm L3 29mm L4 87mm fan wheel ø 155mm with ball bearing		
spare parts for	601696		
	GEV No.	550879	Ref. No. —
	insulation ø 130mm thickness 3mm hole ø 20mm for hot air fan		
	GEV No.	601261	Ref. No. —
	fan wheel ø 154mm W 25mm shaft intake ø 6x5mm chrome-plated blades 7		









pumps

wash and rinse pumps

OLYMPIA

pumps



GEV No.	500530	Ref. No.	BN011DW22009
description	pump inlet ø 60mm outlet ø 48mm type T15 230V 50Hz 1 phase 1.1kW 1.5HP L 305mm rotation direction right OLYMPIA		
spare parts for	500530		
	GEV No.	365021	Ref. No. —
	operating capacitor capacity 16µF 425V tolerance 5% 50/60Hz ambient temperature max. -25 to +85°C ø 35mm L 73mm single M8 plastic connection male faston 6.3mm 416.10.99 protection		
	GEV No.	510693	Ref. No. —
	mechanical shaft seal for shaft ø 12mm slide ring ext. ø 24mm slide ring H 15.5mm slide ring int. ø 11mm counter ring mounting ø 24mm height counter ring 8mm counter ring int. ø 13.5mm		
	GEV No.	521039	Ref. No. —
	fanwheel cover ID ø 156mm ED ø 161mm H 76mm for wash pump		
	GEV No.	521262	Ref. No. —
	impellor ø 102mm H 19mm rotation direction right thread M10L blades 6		
	GEV No.	521559	Ref. No. —
	pump cover OLYMPIA inlet ø 60mm outlet ø 48mm outlet 2 ø 31 auxiliary pressure connection 10mm supporting pressure open turn direction right ø 170mm ID ø 150mm inner height 22mm		
	GEV No.	521727	Ref. No. —
	pump cover gasket EPDM thickness 1.78mm ID ø 145mm Qty 1 pcs		

fuses

fine fuses

fine fuse holders

	GEV No.	550848	Ref. No.	0A034500 BN6A034500
description	fuse holder suitable fuse ø5x20mm			
For models:	ECVME 10, ECVME 20, ECVME 21, ECVME 6, ECVMG 10, ECVMG 20, ECVMG 21, ECVMG 6, ECVPE 10, ECVPE 20, ECVPE 21, ECVPE 6, ECVPG 10, ECVPG 20, ECVPG 21, ECVPG 6			

electric accessories

cables



accessories

cable glands

	GEV No.	550311	Ref. No.	8217570 BN8217570
description	cable gland ID ø 6mm mounting ø 9mm ED ø 14mm Neoprene -30 up to +90°C Qty 10 pcs			

threaded cable glands

screw connections

	GEV No.	550971	Ref. No.	MA1037115100
description	cable gland thread PG16 cable ø 14mm mounting ø 22.5mm Qty 1 pcs plastic WS 27			
	GEV No.	550973	Ref. No.	MA1037112400
description	cable gland thread PG21 cable ø 17mm mounting ø 28mm Qty 1 pcs plastic WS 34			



fastening nuts

			
1			
GEV No.	550972	Ref. No.	MA1037115200
description	nut thread PG16 WS 30 plastic Qty 1 pcs thickness 6mm mounting \varnothing mm cable \varnothing mm		

			
1			
GEV No.	550974	Ref. No.	MA1037114500
description	nut thread PG21 WS 34 plastic Qty 1 pcs thickness 7.5mm mounting \varnothing mm cable \varnothing mm		

terminals

porcelain clamps

			
1			
GEV No.	550115	Ref. No.	MA1037117600
description	porcelain terminal block 2-pole 10mm ² max. 30A max 450V L 37mm W 37mm H 23mm mounting distance mm Qty 1 pcs		

connection terminals with screw/faston connections

			
1			
GEV No.	550278	Ref. No.	MA1037117300
description	power terminal block 3-pole max. 40A max 400V connection \varnothing 6mm ² / F6.3 temp.-resist. 150°C cross section 6mm ²		

			
1			
GEV No.	550534 ¹	Ref. No.	CR0588180
description	power terminal block 3-pole max. 40A max 450V connection \varnothing 6mm ² / F6.3 temp.-resist. 150°C cross section 6mm ² mounting distance 67mm with ground lug		

¹with ground lug

			
1			
GEV No.	550411	Ref. No.	MA1037104000
description	power terminal block 6-pole max. 40A max 450V connection \varnothing 6mm ² / F6.3 temp.-resist. 150°C cross section 6mm ²		

			
1			
GEV No.	550977 ¹	Ref. No.	41826630100 BN826630100 CR0588170
description	power terminal block 6-pole max. 40A max 450V connection \varnothing 6mm ² / F6.3 temp.-resist. 150°C cross section 6mm ² with ground lug		

¹with ground lug

connection terminals with screw connection

			
1			
GEV No.	550470	Ref. No.	41826630180 418564500550
description	power terminal block 3-pole max. 40A max 400V connection M6/M6 temp.-resist. 150°C cross section 6mm ²		

rail-mounted terminals

miscellaneous

			
1			
GEV No.	551079	Ref. No.	MA20802799
description	rail-mounted terminal 6mm ² yellow/green for DIN rail 35mm H 35mm 1-pole		

various

			
1			
GEV No.	693955	Ref. No.	MA1878400
description	terminal grounding cable		



gas taps

PEL

21S series







1



GEV No.	103329	Ref. No.	6A011490 BN6A011490
description	gas tap PEL type 21S gas inlet M16x1.5 (tube ø 10mm) bypass nozzle ø 0.35mm gas outlet M16x1.5 (tube ø 10/8mm) thermocouple connection M8x1 pilot connection M10x1 shaft ø 8x6.5mm shaft L 22/15mm shaft flat upper		
For models:	7FT/G800, 7FTT/G405, 7FTT/G410, 7PCV/G120		



1

GEV No.	101397	Ref. No.	41826920040 BN41826920040 MA1888700
description	gas tap PEL type 21S gas inlet M16x1.5 (tube ø 10mm) bypass nozzle ø 0.35mm gas outlet M16x1.5 (tube ø 10/8mm) thermocouple connection M9x1 pilot connection M10x1 shaft ø 8x6.5mm shaft L 22/15mm shaft flat lower		
For models:	SERIE 600, SERIE 900, SERIE GIANO 110, SERIE GIANO 140, SERIE700		

spare parts for	101397			
	GEV No.	100408	Ref. No.	—
	bypass nozzle type PEL20/21 bore ø 0.35mm thread M5x0.5			
	GEV No.	101060	Ref. No.	—
	magnet unit standard L 39mm D1 ø 15.4mm D2 ø 11mm suitable for PEL20-21/JUNKERS/EGA			
	GEV No.	101206	Ref. No.	—
	gas tap front part shaft ø 8x6.5mm shaft L 22/15mm shaft flat upper/lower suitable for PEL21			
	GEV No.	101231	Ref. No.	—
	thermocouple nut T1: M9x1 T2: M18x1			

accessories for	101397			
	GEV No.	100908	Ref. No.	0100777 41822450040 41822450110 6A016110 822450040 822450110 BN6A017000 BN822450040 MA673500 R0100777 SIR0100777
	union screw thread M10x1 for pipe ø 4mm Qty 1 pcs			
	GEV No.	100909	Ref. No.	822450450
	union screw thread M10x1 for pipe ø 6mm Qty 1 pcs			

accessories for	101397			
	GEV No.	101246	Ref. No.	41822450120 6A016120 822450120 MA673600
	olive for pipe ø 4mm Qty 1 pcs			
	GEV No.	101278	Ref. No.	41822450100 6A011480 822450100 MA86720
	olive for pipe ø 10mm Qty 1 pcs			
	GEV No.	101286	Ref. No.	—
	olive ID ø 6mm Qty 1 pcs			
	GEV No.	101300	Ref. No.	41822450090 822450090 MA1326500
	union nut thread M16x1.5 tube ø 10mm			
	GEV No.	101450	Ref. No.	—
	olive for pipe ø 8mm L 12.7mm Qty 1 pcs ED ø 10mm			
	GEV No.	101451	Ref. No.	—
	union nut thread M16x1.5 tube ø 8mm			
	GEV No.	110081	Ref. No.	—
	knob ø 70mm shaft ø 8x6.5mm shaft flat universal			
	GEV No.	112206	Ref. No.	—
	knob dial plate silver gas tap PEL21/22/23 t.max.°C ED ø 63mm ID ø 45.5mm			

	GEV No.	101824	Ref. No.	CR0580450
description	gas tap PEL type 21S gas inlet pipe flange ø21mm bypass nozzle ø 0.9mm gas outlet M16x1.5 (tube ø 10/8mm) thermocouple connection M9x1 pilot connection M10x1 shaft ø 8x6.5mm shaft L 22/15mm shaft flat upper pipe input ø 9mm			















22S/O series			
1			
GEV No.	101086	Ref. No.	41826920060 4185327060012 41853310186 6A011500 BN41826920060 BN4185327060012 BN6A011500 BN826920060 MA1888600
description	gas tap PEL type 22S/O gas inlet M20x1.5 (tube ø 12mm) bypass nozzle ø 0.35mm gas outlet M20x1.5 (tube ø 12/10mm) thermocouple connection M9x1 pilot connection M10x1 shaft ø 10x8mm shaft L 25/17mm shaft flat lower		
For models:	SERIE 600, SERIE 900, SERIE GIANO 110, SERIE700		
spare parts for	101086		
	GEV No.	100259	Ref. No. —
bypass nozzle type PEL22 bore ø 0.35mm thread M6x0.5			
	GEV No.	101058	Ref. No. 6A014100 BN6A014100
magnet unit L 39mm D1 ø 15.4mm D2 ø 13.5mm suitable for PEL22/EGA24197 standard			
	GEV No.	101201	Ref. No. —
gas tap front part shaft ø 10x8mm shaft L 25/17mm shaft flat upper/lower suitable for PEL22			
	GEV No.	101231	Ref. No. —
thermocouple nut T1: M9x1 T2: M18x1			
	GEV No.	101240	Ref. No. —
gas connection thread M20x1.5 tube ø 12/10mm for PEL gas taps with gasket and screws horizontal			
	GEV No.	101460	Ref. No. —
O-ring ø 12.37mm D1 ø 2.62mm suitable for PEL22			
	GEV No.	101461	Ref. No. —
screw kit suitable for PEL22 Qty 4 pcs			
accessories for	101086		
	GEV No.	100908	Ref. No. 0100777 41822450040 41822450110 6A016110 822450040 822450110 BN6A017000 BN822450040 MA673500 RO100777 SIR0100777
union screw thread M10x1 for pipe ø 4mm Qty 1 pcs			
	GEV No.	100909	Ref. No. 822450450
union screw thread M10x1 for pipe ø 6mm Qty 1 pcs			
	GEV No.	101241	Ref. No. —
gas connection thread M20x1.5 tube ø 12/10mm for PEL gas taps vertical			

accessories for 101086			
	GEV No.	101246	Ref. No. 41822450120 6A016120 822450120 MA673600
olive for pipe ø 4mm Qty 1 pcs			
	GEV No.	101248	Ref. No. MA673300
olive for pipe ø 12mm Qty 1 pcs suitable for PEL			
	GEV No.	101249	Ref. No. —
olive for pipe ø 10mm Qty 1 pcs			
	GEV No.	101250	Ref. No. —
union nut thread M20x1.5 for pipe ø 10mm			
	GEV No.	101251	Ref. No. MA673100
union nut thread M20x1.5 for pipe ø 12mm			
	GEV No.	101286	Ref. No. —
olive ID ø 6mm Qty 1 pcs			
	GEV No.	110080	Ref. No. —
knob ø 70mm shaft ø 10x8mm shaft flat universal			
	GEV No.	112206	Ref. No. —
knob dial plate silver gas tap PEL21/22/23 t.max.°C ED ø 63mm ID ø 45.5mm			

23S/O series			
1			
GEV No.	101091	Ref. No.	41853310038 BN41853310038
description	gas tap PEL type 23S/O gas inlet M28x1.5 (tube ø 20mm) bypass nozzle ø 0.35mm gas outlet M24x1.5 (tube ø 16mm) thermocouple connection M9x1 pilot connection M10x1 shaft ø 10x8mm shaft L 35/19mm shaft flat upper		
For models:	SERIE 900		
spare parts for	101091		
	GEV No.	100455	Ref. No. —
bypass nozzle type PEL23/24 bore ø 0.35mm thread M8x0.5			
	GEV No.	101045	Ref. No. —
magnet unit T1: M9x1 T2: M22x1 L 46mm ø 18mm suitable for PEL23S M9x1			
	GEV No.	101244	Ref. No. —
gas connection thread M24x1.5 tube ø 12/16mm horizontal for PEL gas taps			
	GEV No.	101336	Ref. No. —
gas tap front part shaft ø 10x8mm shaft L 35/17mm shaft flat upper/lower suitable for PEL23S			
	GEV No.	101463	Ref. No. —
screw suitable for PEL23S Qty 4 pcs			

Table continues overleaf



spare parts for 101091			
	GEV No.	528455	Ref. No. —
O-ring Viton thickness 2.62mm ID ø 18.72mm Qty 1 pcs			
accessories for 101091			
	GEV No.	100908	Ref. No. 0100777 41822450040 41822450110 6A016110 822450040 822450110 BN6A017000 BN822450040 MA673500 R0100777 SIR0100777
union screw thread M10x1 for pipe ø 4mm Qty 1 pcs			
	GEV No.	100909	Ref. No. 822450450
union screw thread M10x1 for pipe ø 6mm Qty 1 pcs			
	GEV No.	101246	Ref. No. 41822450120 6A016120 822450120 MA673600
olive for pipe ø 4mm Qty 1 pcs			
	GEV No.	101252	Ref. No. —
union nut thread M24x1.5 for pipe ø 12mm			
	GEV No.	101253	Ref. No. MA1421000
union nut thread M24x1.5 PEL for pipe ø 16mm			
	GEV No.	101254	Ref. No. —
union nut thread M28x1.5 tube ø 20mm			
	GEV No.	101255	Ref. No. —
olive for pipe ø 12mm Qty 1 pcs			
	GEV No.	101256	Ref. No. MA1127400
olive for pipe ø 16mm Qty 1 pcs			
	GEV No.	101257	Ref. No. —
olive for pipe ø 20mm Qty 1 pcs			
	GEV No.	101286	Ref. No. —
olive ID ø 6mm Qty 1 pcs			
	GEV No.	110080	Ref. No. —
knob ø 70mm shaft ø 10x8mm shaft flat universal			
	GEV No.	112206	Ref. No. —
knob dial plate silver gas tap PEL21/22/23 t.max.°C ED ø 63mm ID ø 45.5mm			

gas thermostats

SIT

630 Eurosit series









GEV No.	107688	Ref. No.	CR0585671
description	gas thermostat 100-340°C gas inlet 3/8" gas outlet 3/8" thermocouple connection M9x1 pilot connection M10x1 probe ø 4mm probe L 72mm capillary pipe 1050mm		



GEV No.	101188	Ref. No.	MACM097000
description	gas thermostat type 630 Eurosit series t.max. 190°C 110-190°C gas inlet 3/8" gas outlet 3/8" thermocouple connection M9x1 pilot connection M10x1 probe ø 4mm probe L 202mm capillary pipe 1050mm SIT		

accessories for 101188			
	GEV No.	100904	Ref. No. 6A011608 BN6A011608 MA1394700
locking screw M10x1 for pipe ø 4mm Qty 1 pcs			
	GEV No.	100905	Ref. No. 6A011607 BN6A011607
locking screw M10x1 for pipe ø 6mm Qty 1 pcs			
	GEV No.	101273	Ref. No. 0100842 MA417810 R0100842 SIR0100842
olive for pipe ø 12mm L 9.5mm brass Qty 1 pcs suitable for universal			
	GEV No.	101276	Ref. No. MA459300
union screw thread 3/8" tube ø 12mm Qty 1 pcs			
	GEV No.	101333	Ref. No. MA1888200
plug thread 3/8" with O-ring			

GEV No.	101992	Ref. No.	41826920350 BN41826920350
description	gas thermostat type 630 Eurosit series t.max. 190°C 110-190°C gas inlet 3/8" gas outlet 3/8" thermocouple connection M9x1 pilot connection M10x1 probe ø 4mm probe L 202mm capillary pipe 1050mm SIT		
For models:	SERIE 600		
accessories for	101992		
	GEV No.	100904	Ref. No. 6A011608 BN6A011608 MA1394700
locking screw M10x1 for pipe ø 4mm Qty 1 pcs			
	GEV No.	100905	Ref. No. 6A011607 BN6A011607
locking screw M10x1 for pipe ø 6mm Qty 1 pcs			
	GEV No.	101273	Ref. No. 0100842 MA417810 R0100842 SIR0100842
olive for pipe ø 12mm L 9.5mm brass Qty 1 pcs suitable for universal			
	GEV No.	101276	Ref. No. MA459300
union screw thread 3/8" tube ø 12mm Qty 1 pcs			
	GEV No.	101333	Ref. No. MA1888200
plug thread 3/8" with O-ring			
	GEV No.	510655	Ref. No. —
gasket silicone ø 7.8mm L 5mm blue Shore 55° Qty 10 pcs			



GEV No.	103076	Ref. No.	CR0508680
description	gas thermostat type 630 Eurosit series t.max. 190°C 110-190°C gas inlet 3/8" gas outlet 3/8" thermocouple connection M9x1 pilot connection M10x1 probe ø 4mm probe L 202mm capillary pipe 1050mm SIT		



GEV No.	101915	Ref. No.	41826920012 BN826920012
description	gas thermostat type 630 Eurosit series t.max. 320°C 80-320°C gas in- let 3/8" gas outlet 3/8" thermocouple connection M9x1 pilot connec- tion M10x1 probe ø 4mm probe L 72mm capillary pipe 1050mm SIT		
accessories for	101915		
	GEV No.	100825	Ref. No. —
gas tap spindle shaft ø 8x6.5mm shaft L 22/14mm suitable for EUROSIT			
	GEV No.	100904	Ref. No. 6A011608 BN6A011608 MA1394700
locking screw M10x1 for pipe ø 4mm Qty 1 pcs			
	GEV No.	100905	Ref. No. 6A011607 BN6A011607
locking screw M10x1 for pipe ø 6mm Qty 1 pcs			
	GEV No.	100949	Ref. No. —
gasket suitable for 630 Eurosit series			
	GEV No.	101273	Ref. No. 0100842 MA417810 R0100842 SIR0100842
olive for pipe ø 12mm L 9.5mm brass Qty 1 pcs suitable for universal			
	GEV No.	101276	Ref. No. MA459300
union screw thread 3/8" tube ø 12mm Qty 1 pcs			
	GEV No.	101333	Ref. No. MA1888200
plug thread 3/8" with O-ring			
	GEV No.	101390	Ref. No. —
gas tap spindle shaft ø 6x4.6mm shaft L 32/15mm gas tap with igni- tion flame suitable for ZANUSSI, MARENO for gas thermostat EUROSIT			
	GEV No.	101392	Ref. No. 41824710060 824710060 BN41824710060 BN824710060 MA1868600
adapter suitable for 630 Eurosit series			
	GEV No.	110357	Ref. No. 41822160011 822160011 BN822160011
gas tap spindle shaft ø 8x6.5mm shaft L 36/12mm suitable for 630 Eurosit series			
	GEV No.	110358	Ref. No. —
adapter shaft ø 10x8mm shaft L 29/18mm suitable for 630 Eurosit series			

			
GEV No.	101125	Ref. No.	41826920010 MA1887600
description	gas thermostat type 630 Eurosit series t.max. 340°C 100-340°C gas inlet 3/8" gas outlet 3/8" thermocouple connection M9x1 pilot connection M10x1 probe ø 4mm probe L 72mm capillary pipe 1050mm SIT		
For models:	SERIE 900, SERIE GIANO 110, SERIE700		
accessories for	101125		
	GEV No.	100825	Ref. No. —
gas tap spindle shaft ø 8x6.5mm shaft L 22/14mm suitable for EUROSIT			
	GEV No.	100904	Ref. No. 6A011608 BN6A011608 MA1394700
locking screw M10x1 for pipe ø 4mm Qty 1 pcs			
	GEV No.	100905	Ref. No. 6A011607 BN6A011607
locking screw M10x1 for pipe ø 6mm Qty 1 pcs			
	GEV No.	100949	Ref. No. —
gasket suitable for 630 Eurosit series			
	GEV No.	101273	Ref. No. 0100842 MA417810 R0100842 SIR0100842
olive for pipe ø 12mm L 9.5mm brass Qty 1 pcs suitable for universal			
	GEV No.	101276	Ref. No. MA459300
union screw thread 3/8" tube ø 12mm Qty 1 pcs			
	GEV No.	101333	Ref. No. MA1888200
plug thread 3/8" with O-ring			
	GEV No.	101390	Ref. No. —
gas tap spindle shaft ø 6x4.6mm shaft L 32/15mm gas tap with ignition flame suitable for ZANUSSI, MARENO for gas thermostat EUROSIT			
	GEV No.	101392	Ref. No. 41824710060 824710060 BN41824710060 BN824710060 MA1868600
adapter suitable for 630 Eurosit series			
	GEV No.	110357	Ref. No. 41822160011 822160011 BN822160011
gas tap spindle shaft ø 8x6.5mm shaft L 36/12mm suitable for 630 Eurosit series			
	GEV No.	110358	Ref. No. —
adapter shaft ø 10x8mm shaft L 29/18mm suitable for 630 Eurosit series			

710 Minisit series











			
GEV No.	101135	Ref. No.	85327020200 BN4185327020200 MA1393200
description	gas thermostat SIT type MINISIT 710 t.max. 190°C 110-190°C gas inlet 1/2" gas outlet 3/8" thermocouple connection M9x1 pilot connection M10x1 probe ø 6mm probe L 102mm capillary pipe 1050mm probe type type A3 pressure controller no pressure regulator or bar gland nut		
For models:	SERIE 900, SERIE700		
spare parts for	101135		
	GEV No.	101053	Ref. No. 6A015200
magnet unit T1: M9x1 T2: M24x1 L 45mm ø 17mm suitable for Minisit			
	GEV No.	102118	Ref. No. —
probe 110-190°C probe ø 6mm probe L 102mm capillary pipe 1050mm t.max. 190°C fryer probe type type A3 suitable for MINISIT 710			
accessories for	101135		
	GEV No.	100809	Ref. No. —
O-ring EPDM thickness 2mm ID ø 21mm Qty 1 pcs			
	GEV No.	100820	Ref. No. —
gland duct ET M14x1.5 IT M10x0.75 probe ø max. 6.5mm WS 22			
	GEV No.	100904	Ref. No. 6A011608 BN6A011608 MA1394700
locking screw M10x1 for pipe ø 4mm Qty 1 pcs			
	GEV No.	100905	Ref. No. 6A011607 BN6A011607
locking screw M10x1 for pipe ø 6mm Qty 1 pcs			
	GEV No.	101054	Ref. No. —
magnet unit T1: M10x1 T2: M24x1 L 45mm ø 17mm suitable for Minisit			
	GEV No.	101136	Ref. No. 4185327020230 85327020230
piezoelectric igniter suitable for Minisit with cover cap ømm connection F6.3x0.8			
	GEV No.	101137	Ref. No. —
cover cap without piezoelectric igniter			
	GEV No.	101267	Ref. No. —
reducer IT 3/8" ET 1/2" L 21mm			
	GEV No.	101268	Ref. No. —
gas connection thread 3/8" angled with O-ring MINISIT 710			
	GEV No.	101269	Ref. No. —
gas connection thread 1/2" angled with O-ring MINISIT 710			
	GEV No.	101270	Ref. No. —
screw connection IT 3/8" ET 3/8" L 28mm			

Table continues overleaf



accessories for		101135	
	GEV No.	101272	Ref. No. —
screw connection IT 1/2" ET 3/8" L 57mm			
	GEV No.	101273	Ref. No. 0100842 MA417810 R0100842 SIR0100842
olive for pipe ø 12mm L 9.5mm brass Qty 1 pcs suitable for universal			
	GEV No.	101274	Ref. No. —
olive for pipe ø 16mm Qty 1 pcs			
	GEV No.	101275	Ref. No. —
union screw thread 1/2" for pipe ø 16mm Qty 1 pcs			
	GEV No.	101276	Ref. No. MA459300
union screw thread 3/8" tube ø 12mm Qty 1 pcs			
	GEV No.	110068	Ref. No. 41824710160 824710160 BN824710160
knob suitable for Minisit ø 37mm			

accessories for		101991	
	GEV No.	101246	Ref. No. 41822450120 6A016120 822450120 MA673600
olive for pipe ø 4mm Qty 1 pcs			
	GEV No.	101278	Ref. No. 41822450100 6A011480 822450100 MA86720
olive for pipe ø 10mm Qty 1 pcs			
	GEV No.	101286	Ref. No. —
olive ID ø 6mm Qty 1 pcs			
	GEV No.	101300	Ref. No. 41822450090 822450090 MA1326500
union nut thread M16x1.5 tube ø 10mm			
	GEV No.	101450	Ref. No. —
olive for pipe ø 8mm L 12.7mm Qty 1 pcs ED ø 10mm			
	GEV No.	101451	Ref. No. —
union nut thread M16x1.5 tube ø 8mm			
	GEV No.	110079	Ref. No. —
knob dial plate gas thermostat 1-8 silver			
	GEV No.	110081	Ref. No. —
knob ø 70mm shaft ø 8x6.5mm shaft flat universal			

PEL

25ST series



GEV No.	101991	Ref. No.	41826920330 BN41826920330
description	gas thermostat PEL type 25ST 100-300°C gas inlet M16x1.5 (tube ø 10mm) bypass nozzle ø 0mm gas outlet M16x1.5 (tube ø 10/8mm) thermocouple connection M9x1 pilot connection M10x1 capillary pipe 1200mm probe ø 6mm probe L 100mm shaft ø 8x6.5mm shaft L 21/15mm shaft flat upper		
For models:	SERIE 600		
spare parts for	101991		
	GEV No.	101060	Ref. No. —
magnet unit standard L 39mm D1 ø 15.4mm D2 ø 11mm suitable for PEL20-21/JUNKERS/EGA			
	GEV No.	106191	Ref. No. —
bypass nozzle type PEL22 bore ø 0mm thread M6x0.5			
	GEV No.	106200	Ref. No. —
nut thread M9x1 suitable for PEL 24/25S			
accessories for	101991		
	GEV No.	100908	Ref. No. 0100777 41822450040 41822450110 6A016110 822450040 822450110 BN6A017000 BN822450040 MA673500 R0100777 SIR0100777
union screw thread M10x1 for pipe ø 4mm Qty 1 pcs			
	GEV No.	100909	Ref. No. 822450450
union screw thread M10x1 for pipe ø 6mm Qty 1 pcs			

GEV No.	107470	Ref. No.	CR0933740
description	gas thermostat PEL type 25ST 90-250°C gas inlet M16x1.5 (tube ø 10mm) bypass nozzle ø 1mm gas outlet M16x1.5 (tube ø 10/8mm) thermocouple connection M8x1 pilot connection M10x1 capillary pipe 1200mm probe ø 6mm probe L 120mm shaft ø 8x6.5mm shaft L 26/15mm shaft flat upper		

GEV No.	107515	Ref. No.	CR0933730
description	gas thermostat PEL type 25ST up to 280°C gas inlet M16x1.5 (tube ø 10mm) bypass nozzle ø 1mm gas outlet M16x1.5 (tube ø 10/8mm) thermocouple connection M8x1 pilot connection M10x1 capillary pipe 1200mm probe ø 6mm probe L 120mm shaft ø 8x6.5mm shaft L 26/15mm shaft flat upper		



gas valves and ignition boxes

gas control valves

SIT

NOVASIT

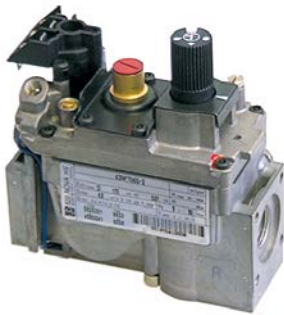







1			
GEV No.	101187	Ref. No.	1870800 41826920090 BN41826920090 BN826920090 MA1870800
description	gas valve SIT series Novasit 820 0.17VHz gas inlet 1/2" gas outlet 1/2" thermocouple connection M9x1 pilot connection M10x1 ignition pressurebar pressure range 5-50mbar pressure regulator connection blind equiv. no. 0.820.301 supply Operator millivolt		
For models:	SERIE 900, SERIE700		
spare parts for	101187		
	GEV No.	101065	Ref. No. —
	magnet unit with cable L 44mm D1 ø 30mm D2 ø 20mm suitable for NOVASIT		
accessories for	101187		
	GEV No.	100110	Ref. No. 41826920110 826920110 BN41826920110 BN826920110 MA1949700
	pilot burner SIT type 190 series 3 flames nozzle ømm gas connectionmm		
	GEV No.	101305	Ref. No. —
	gas connection straight 1/2" flange 45x45mm ELETTROSIT/V4400/4600/4605 suitable for SIT/HONEYWELL hole distance 36x36mm		
	GEV No.	101306	Ref. No. MA2865800
	gas connection angled flange 45x45mm hole distance 36x36mm 1/2" ELETTROSIT/V4400/4600/4605 screw with O-ring suitable for SIT/HONEYWELL		
	GEV No.	101307	Ref. No. —
	gas connection straight flange 45x45mm hole distance 36x36mm 3/4" ELETTROSIT/V4400/4600/4605 screw with O-ring suitable for SIT/HONEYWELL		
	GEV No.	101308	Ref. No. —
	gas connection angled flange 45x45mm hole distance 36x36mm 3/4" ELETTROSIT/V4400/4600/4605 screw with O-ring suitable for SIT/HONEYWELL		
	GEV No.	102116	Ref. No. 826920100 BN826920100
	thermopile ROBERTSHAW L 900mm probe ø 9mm probe L 57mm 250-750mV screw connection 7/16"		



1			
GEV No.	101908	Ref. No.	418SA050010 MA1871200
description	gas valve SIT series Novasit 820 230V 50Hz gas inlet 1/2" gas outlet 1/2" thermocouple connection M9x1 pilot connection M10x1 ignition pressurebar pressure regulator connection blind equiv. no. 0.820.018 output pilot burner M10x1 input pressure max. 60bar setting range 3-30bar		
spare parts for	101908		
	GEV No.	101065	Ref. No. —
	magnet unit with cable L 44mm D1 ø 30mm D2 ø 20mm suitable for NOVASIT		
	GEV No.	101313	Ref. No. —
	solenoid coil 230V 50Hz		
accessories for	101908		
	GEV No.	100006	Ref. No. —
	piezoelectric igniter suitable for ELETTROSIT body plastic blowing connection ø2.4mm ø 14mm		
	GEV No.	101305	Ref. No. —
	gas connection straight 1/2" flange 45x45mm ELETTROSIT/V4400/4600/4605 suitable for SIT/HONEYWELL hole distance 36x36mm		
	GEV No.	101306	Ref. No. MA2865800
	gas connection angled flange 45x45mm hole distance 36x36mm 1/2" ELETTROSIT/V4400/4600/4605 screw with O-ring suitable for SIT/HONEYWELL		
	GEV No.	101307	Ref. No. —
	gas connection straight flange 45x45mm hole distance 36x36mm 3/4" ELETTROSIT/V4400/4600/4605 screw with O-ring suitable for SIT/HONEYWELL		
	GEV No.	101308	Ref. No. —
	gas connection angled flange 45x45mm hole distance 36x36mm 3/4" ELETTROSIT/V4400/4600/4605 screw with O-ring suitable for SIT/HONEYWELL		
	GEV No.	101312	Ref. No. —
	microswitch		
	GEV No.	101314	Ref. No. —
	solenoid coil 24V 50Hz		
	GEV No.	101317	Ref. No. —
	plug with cable L 1000mm suitable for NOVASIT		
	GEV No.	101318	Ref. No. —
	cover cap for solenoid coil suitable for NOVASIT		



1

GEV No.	106001	Ref. No.	3103650 BN3103650
description	gas valve SIT series Novasit 826 230V 50Hz gas inlet 1/2" gas outlet 1/2" thermocouple connection pilot connection closed ignition pressure 3-5mbar pressure range 2-50mbar pressure regulator connection standard equiv. no. 0.826.011 power supply for modulator 230VAC rectified		
For models:	ECVMG 10, ECVMG 20, ECVMG 21, ECVMG 6, ECVPG 10, ECVPG 20, ECVPG 21, ECVPG 6		
spare parts for	106001		
	GEV No.	101542	Ref. No. —
	solenoid coil 50Hz NOVA 822/826/827 suitable for NOVASIT 230V		
accessories for	106001		
	GEV No.	101305	Ref. No. —
	gas connection straight 1/2" flange 45x45mm ELETROSIT/V4400/4600/4605 suitable for SIT/HONEYWELL hole distance 36x36mm		
	GEV No.	101306	Ref. No. MA2865800
	gas connection angled flange 45x45mm hole distance 36x36mm 1/2" ELETROSIT/V4400/4600/4605 screw with O-ring suitable for SIT/HONEYWELL		
	GEV No.	101307	Ref. No. —
	gas connection straight flange 45x45mm hole distance 36x36mm 3/4" ELETROSIT/V4400/4600/4605 screw with O-ring suitable for SIT/HONEYWELL		
	GEV No.	101308	Ref. No. —
	gas connection angled flange 45x45mm hole distance 36x36mm 3/4" ELETROSIT/V4400/4600/4605 screw with O-ring suitable for SIT/HONEYWELL		
	GEV No.	101859	Ref. No. —
	panel-mounted inlet with cable L 1000mm for rectifier suitable for NOVASIT		

ignition boxes

BRAHMA



1

GEV No.	102337	Ref. No.	3103675 BN3103675
description	ignition box BRAHMA type CM11F electrodes 2 waiting time 1.5s safety time 5s 220-240V 7VA 50-60Hz		
For models:	ECVMG 10, ECVMG 20, ECVMG 21, ECVMG 6, ECVPG 10, ECVPG 20, ECVPG 21, ECVPG 6		

ignition parts

pilot burners

SIT



100 series



1

GEV No.	107103	Ref. No.	6A013100 BN6A013100
description	pilot burner SIT 1 flame nozzle ø 0.2mm gas connection 6mm		
spare parts for	107103		
	GEV No.	100245	Ref. No. —
	pilot burner nozzle LPG code 20 bore ø 0.2mm Qty 1 pcs thread M8x0.75		
	GEV No.	100885	Ref. No. BN6A013104
	air mixing sleeve for pilot burner Qty 1 pcs		
	GEV No.	100916	Ref. No. —
	compression spring for pilot burner Qty 1 pcs		
	GEV No.	100917	Ref. No. —
	gasket for pilot burner Qty 1 pcs aluminium		
	GEV No.	100918	Ref. No. —
	screw for pilot burner		
	GEV No.	107160	Ref. No. —
	pilot burner cap SIT 1 flame Hmm Lmm Qty 1 pcs		
	GEV No.	107166	Ref. No. —
	pilot burner head SIT 1 flame Hmm Lmm Qty 1 pcs		
	GEV No.	107701	Ref. No. —
	pilot burner bottom part SIT 100 series nozzle ø 0.2mm		
accessories for	107103		
	GEV No.	100246	Ref. No. —
	pilot burner nozzle natural gas bore ø 0.35mm Qty 1 pcs thread M8x0.75		
	GEV No.	100904	Ref. No. 6A011608 BN6A011608 MA1394700
	locking screw M10x1 for pipe ø 4mm Qty 1 pcs		
	GEV No.	100905	Ref. No. 6A011607 BN6A011607
	locking screw M10x1 for pipe ø 6mm Qty 1 pcs		
	GEV No.	102110	Ref. No. —
	pilot tube copper pipe ø 4mm thickness 1mm L 3000mm		
	GEV No.	102111	Ref. No. —
	pilot tube copper pipe ø 6mm thickness 1mm L 3000mm		
	GEV No.	107171	Ref. No. —
	pilot burner nozzle SIT natural/liquid gas bore ø 0.25mm Qty 1 pcs		

Table continues overleaf

accessories for 107103	
	GEV No. 107700 Ref. No. —
pilot burner bottom part SIT 100 series nozzle ø 0.25mm	
	GEV No. 107702 Ref. No. —
pilot burner bottom part SIT 100 series nozzle ø 0.35mm	





GEV No. 106906	Ref. No.	27090022 6A001456 6A013200 85327090022 BN6A001456 BN6A013200 LAR63050020
-----------------------	-----------------	--

description pilot burner SIT type 100 series 3 flames nozzle ø 0.2mm gas connection 6mm

For models: SERIE 900, SERIE700

spare parts for 106906

	GEV No. 100245 Ref. No. —
pilot burner nozzle LPG code 20 bore ø 0.2mm Qty 1 pcs thread M8x0.75	

	GEV No. 100855 Ref. No. —
pilot burner bracket triple	

	GEV No. 100885 Ref. No. BN6A013104
air mixing sleeve for pilot burner Qty 1 pcs	

	GEV No. 100916 Ref. No. —
compression spring for pilot burner Qty 1 pcs	

	GEV No. 100917 Ref. No. —
gasket for pilot burner Qty 1 pcs aluminium	

	GEV No. 100918 Ref. No. —
screw for pilot burner	

	GEV No. 107162 Ref. No. —
pilot burner cap SIT 3 flames Hmm Lmm Qty 1 pcs	

	GEV No. 107701 Ref. No. —
pilot burner bottom part SIT 100 series nozzle ø 0.2mm	





accessories for 106906

	GEV No. 100245 Ref. No. —
pilot burner nozzle LPG code 20 bore ø 0.2mm Qty 1 pcs thread M8x0.75	

	GEV No. 100246 Ref. No. —
pilot burner nozzle natural gas bore ø 0.35mm Qty 1 pcs thread M8x0.75	

	GEV No. 100904 Ref. No. 6A011608 BN6A011608 MA1394700
locking screw M10x1 for pipe ø 4mm Qty 1 pcs	

	GEV No. 100905 Ref. No. 6A011607 BN6A011607
locking screw M10x1 for pipe ø 6mm Qty 1 pcs	

accessories for 106906	
	GEV No. 102110 Ref. No. —
pilot tube copper pipe ø 4mm thickness 1mm L 3000mm	
	GEV No. 102111 Ref. No. —
pilot tube copper pipe ø 6mm thickness 1mm L 3000mm	
	GEV No. 107171 Ref. No. —
pilot burner nozzle SIT natural/liquid gas bore ø 0.25mm Qty 1 pcs	
	GEV No. 107700 Ref. No. —
pilot burner bottom part SIT 100 series nozzle ø 0.25mm	
	GEV No. 107702 Ref. No. —
pilot burner bottom part SIT 100 series nozzle ø 0.35mm	

accessories

ignition electrodes

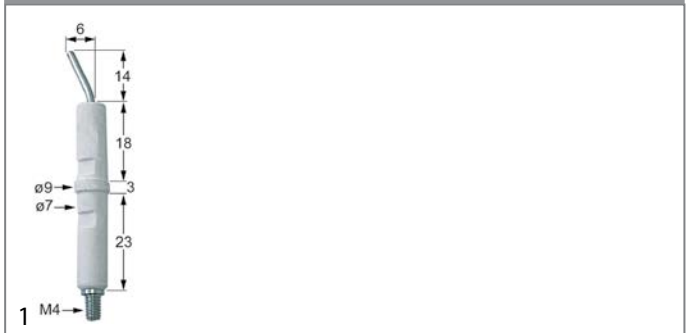

GEV No. 100706	Ref. No.	41853310150 636700 85326010046 BN41853310150 MA224211 MA636700
-----------------------	-----------------	---

description ignition electrode connection M4 Qty 1 pcs

For models: SERIE 900, SERIE700

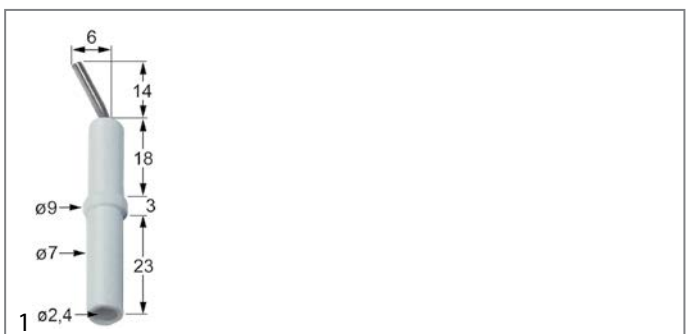



GEV No. 100707	Ref. No.	6A013302 BN6A013302
-----------------------	-----------------	------------------------

description ignition electrode D1 ø 7mm D2 ø 9mm connection ø2.4mm L1 14mm L2 6mm BL1 18mm BL2 3mm BL3 23mm to clip Qty 1 pcs







For models: 7FR/G815













miscellaneous			
			
1			
GEV No.	100885	Ref. No.	BN6A013104
description	air mixing sleeve for pilot burner Qty 1 pcs		

140 - 145 -150 series			
			
1			
GEV No.	106943 ¹	Ref. No.	1887700 MA1887700
description	pilot burner SIT type 140 series 1 flame nozzle ømm gas connecti-onmm		
spare parts for	106943		
			
GEV No.	100907	Ref. No.	MA1891700
description	screw connection thread M10x1 Qty 1 pcs type SEF 1 ømm for thermocouple		

¹incl. thermocouple fitting











			
1			
GEV No.	107131	Ref. No.	41826902140 41826920070 BN826920070
description	pilot burner SIT type 140 series 2 flames nozzle ømm gas connecti-onmm		
spare parts for	107131		
			
GEV No.	100907	Ref. No.	MA1891700
description	screw connection thread M10x1 Qty 1 pcs type SEF 1 ømm for thermocouple		
accessories for	107131		
			
GEV No.	100204	Ref. No.	MA1888000
description	pilot burner nozzle SIT LPG code 14 bore ø 0.18/0.20mm Qty 1 pcs suitable for 140 series		
			
GEV No.	100205	Ref. No.	41822140380 822140380 BN822140380
description	pilot burner nozzle SIT LPG code 19 bore ø 0.23/0.26mm Qty 1 pcs suitable for SIT 150 series		
			
GEV No.	100206	Ref. No.	—
description	pilot burner nozzle SIT natural gas code 36 bore ø 0.60/0.55mm Qty 1 pcs suitable for SIT 150 series		
			
GEV No.	100207	Ref. No.	41822140120 6A013107 822140120 MA1887800
description	pilot burner nozzle SIT natural gas code 27 bore ø 0.40/0.38mm suitable for SIT 140 series		
			
GEV No.	100216	Ref. No.	—
description	pilot burner nozzle SIT natural gas code 38 bore ø 0.45mm Qty 1 pcs suitable for SIT 150 series		

accessories for	107131		
			
GEV No.	100701	Ref. No.	41826650010 826650010 BN41826650010 MA1888300 MA1949900
description	ignition electrode connection M4 Qty 1 pcs		
			
GEV No.	100803	Ref. No.	—
description	gasket for pilot burner Qty 1 pcs		
			
GEV No.	100897	Ref. No.	41822450050 822450050 BN822450050 MA1888100
description	olive for pipe ø 4mm Qty 1 pcs for pilot burner		
			
GEV No.	100898	Ref. No.	41822450470 822450470 BN41822450470
description	olive for pipe ø 6mm Qty 1 pcs for pilot burner		
			
GEV No.	100906	Ref. No.	6A011707 MA1888400
description	screw connection thread M10x1 for ignition electrode brass Qty 1 pcs WS 10		
			
GEV No.	100908	Ref. No.	0100777 41822450040 41822450110 6A016110 822450040 822450110 BN6A017000 BN822450040 MA673500 R0100777 SIR0100777
description	union screw thread M10x1 for pipe ø 4mm Qty 1 pcs		
			
GEV No.	100909	Ref. No.	822450450
description	union screw thread M10x1 for pipe ø 6mm Qty 1 pcs		

			
1			
GEV No.	107114 ¹	Ref. No.	41826920030 BN826920030 MACM029000
description	pilot burner SIT type 140 series 2 flames nozzle ømm gas connecti-onmm		
For models:	7FT/G800, 7FTT/G405, 7FTT/G410		
spare parts for	107114		
			
GEV No.	100907	Ref. No.	MA1891700
description	screw connection thread M10x1 Qty 1 pcs type SEF 1 ømm for thermocouple		
accessories for	107114		
			
GEV No.	100204	Ref. No.	MA1888000
description	pilot burner nozzle SIT LPG code 14 bore ø 0.18/0.20mm Qty 1 pcs suitable for 140 series		
			
GEV No.	100205	Ref. No.	41822140380 822140380 BN822140380
description	pilot burner nozzle SIT LPG code 19 bore ø 0.23/0.26mm Qty 1 pcs suitable for SIT 150 series		
			
GEV No.	100206	Ref. No.	—
description	pilot burner nozzle SIT natural gas code 36 bore ø 0.60/0.55mm Qty 1 pcs suitable for SIT 150 series		

¹incl. thermocouple fitting
Table continues overleaf















accessories for		107114	
	GEV No.	100207	Ref. No.
			41822140120 6A013107 822140120 MA1887800
pilot burner nozzle SIT natural gas code 27 bore ø 0.40/0.38mm suitable for SIT 140 series			
	GEV No.	100216	Ref. No.
			—
pilot burner nozzle SIT natural gas code 38 bore ø 0.45mm Qty 1 pcs suitable for SIT 150 series			
	GEV No.	100701	Ref. No.
			41826650010 826650010 BN41826650010 MA1888300 MA1949900
ignition electrode connection M4 Qty 1 pcs			
	GEV No.	100801	Ref. No.
			—
gasket for pilot burner Qty 1 pcs			
	GEV No.	100897	Ref. No.
			41822450050 822450050 BN822450050 MA1888100
olive for pipe ø 4mm Qty 1 pcs for pilot burner			
	GEV No.	100898	Ref. No.
			41822450470 822450470 BN41822450470
olive for pipe ø 6mm Qty 1 pcs for pilot burner			
	GEV No.	100906	Ref. No.
			6A011707 MA1888400
screw connection thread M10x1 for ignition electrode brass Qty 1 pcs WS 10			
	GEV No.	100908	Ref. No.
			0100777 41822450040 41822450110 6A016110 822450040 822450110 BN6A017000 BN822450040 MA673500 R0100777 SIR0100777
union screw thread M10x1 for pipe ø 4mm Qty 1 pcs			
	GEV No.	100909	Ref. No.
			822450450
union screw thread M10x1 for pipe ø 6mm Qty 1 pcs			
	GEV No.	102110	Ref. No.
			—
pilot tube copper pipe ø 4mm thickness 1mm L 3000mm			
	GEV No.	102111	Ref. No.
			—
pilot tube copper pipe ø 6mm thickness 1mm L 3000mm			















160 series



GEV No.	100109	Ref. No.	MACM040800
description	pilot burner SIT type 160 series 1 flame nozzle ømm gas connectionmm		
spare parts for	100109		
	GEV No.	100907	Ref. No.
			MA1891700
screw connection thread M10x1 Qty 1 pcs type SEF 1 ømm for thermocouple			

accessories for		100109	
	GEV No.	100202	Ref. No.
			—
pilot burner nozzle natural gas code 41 Qty 1 pcs nozzle ø 0.41mm			
	GEV No.	100203	Ref. No.
			822140370
pilot burner nozzle LPG code 25 Qty 1 pcs nozzle ø 0.25mm			
	GEV No.	100701	Ref. No.
			41826650010 826650010 BN41826650010 MA1888300 MA1949900
ignition electrode connection M4 Qty 1 pcs			
	GEV No.	100801	Ref. No.
			—
gasket for pilot burner Qty 1 pcs			
	GEV No.	100869	Ref. No.
			—
pilot burner nozzle natural gas code 51 Qty 1 pcs suitable for 160 series nozzle ø 0.51mm			
	GEV No.	100906	Ref. No.
			6A011707 MA1888400
screw connection thread M10x1 for ignition electrode brass Qty 1 pcs WS 10			
	GEV No.	100908	Ref. No.
			0100777 41822450040 41822450110 6A016110 822450040 822450110 BN6A017000 BN822450040 MA673500 R0100777 SIR0100777
union screw thread M10x1 for pipe ø 4mm Qty 1 pcs			
	GEV No.	100909	Ref. No.
			822450450
union screw thread M10x1 for pipe ø 6mm Qty 1 pcs			
	GEV No.	101282	Ref. No.
			MA469000
olive for pipe ø 4mm L 7.4mm Qty 1 pcs			
	GEV No.	101287	Ref. No.
			—
olive for pipe ø 6mm Qty 1 pcs			
	GEV No.	102110	Ref. No.
			—
pilot tube copper pipe ø 4mm thickness 1mm L 3000mm			
	GEV No.	102111	Ref. No.
			—
pilot tube copper pipe ø 6mm thickness 1mm L 3000mm			
	GEV No.	107650	Ref. No.
			822140360 BN822140360 CR0410100
pilot burner nozzle SIT LPG code 30 Qty 1 pcs			



 <p>1</p>			
GEV No.	100056	Ref. No.	41826920370 BN41826920370
description	pilot burner SIT type 160 series 3 flames nozzle ømm gas connecti- onmm		
For models:	SERIE 600		
spare parts for	100056		
	GEV No.	100907	Ref. No. MA1891700
screw connection thread M10x1 Qty 1 pcs type SEF 1 ømm for thermocouple			
accessories for	100056		
	GEV No.	100202	Ref. No. —
pilot burner nozzle natural gas code 41 Qty 1 pcs nozzle ø 0.41mm			
	GEV No.	100203	Ref. No. 822140370
pilot burner nozzle LPG code 25 Qty 1 pcs nozzle ø 0.25mm			
	GEV No.	100701	Ref. No. 41826650010 826650010 BN41826650010 MA1888300 MA1949900
ignition electrode connection M4 Qty 1 pcs			
	GEV No.	100801	Ref. No. —
gasket for pilot burner Qty 1 pcs			
	GEV No.	100869	Ref. No. —
pilot burner nozzle natural gas code 51 Qty 1 pcs suitable for 160 series nozzle ø 0.51mm			
	GEV No.	100870	Ref. No. —
olive for pipe ø 4mm Qty 1 pcs suitable for 160 series for pilot burner			
	GEV No.	100906	Ref. No. 6A011707 MA1888400
screw connection thread M10x1 for ignition electrode brass Qty 1 pcs WS 10			
	GEV No.	100908	Ref. No. 0100777 41822450040 41822450110 6A016110 822450040 822450110 BN6A017000 BN822450040 MA673500 R0100777 SIR0100777
union screw thread M10x1 for pipe ø 4mm Qty 1 pcs			
	GEV No.	100909	Ref. No. 822450450
union screw thread M10x1 for pipe ø 6mm Qty 1 pcs			
	GEV No.	101282	Ref. No. MA469000
olive for pipe ø 6mm L 7.4mm Qty 1 pcs			
	GEV No.	101287	Ref. No. —
olive for pipe ø 6mm Qty 1 pcs			
	GEV No.	102110	Ref. No. —
pilot tube copper pipe ø 4mm thickness 1mm L 3000mm			
	GEV No.	102111	Ref. No. —
pilot tube copper pipe ø 6mm thickness 1mm L 3000mm			

accessories for	100056		
	GEV No.	107650	Ref. No. 822140360 BN822140360 CR0410100
pilot burner nozzle SIT LPG code 30 Qty 1 pcs			









190 series			
 <p>1</p>			
GEV No.	100110	Ref. No.	41826920110 BN41826920110 BN826920110 MA1949700
description	pilot burner SIT type 190 series 3 flames nozzle ømm gas connecti- onmm		
For models:	SERIE 900, SERIE700		
accessories for	100110		
	GEV No.	100202	Ref. No. —
pilot burner nozzle natural gas code 41 Qty 1 pcs nozzle ø 0.41mm			
	GEV No.	100203	Ref. No. 822140370
pilot burner nozzle LPG code 25 Qty 1 pcs nozzle ø 0.25mm			
	GEV No.	100701	Ref. No. 41826650010 826650010 BN41826650010 MA1888300 MA1949900
ignition electrode connection M4 Qty 1 pcs			
	GEV No.	100906	Ref. No. 6A011707 MA1888400
screw connection thread M10x1 for ignition electrode brass Qty 1 pcs WS 10			
	GEV No.	100907	Ref. No. MA1891700
screw connection thread M10x1 Qty 1 pcs type SEF 1 ømm for thermocouple			
	GEV No.	100908	Ref. No. 0100777 41822450040 41822450110 6A016110 822450040 822450110 BN6A017000 BN822450040 MA673500 R0100777 SIR0100777
union screw thread M10x1 for pipe ø 4mm Qty 1 pcs			
	GEV No.	100909	Ref. No. 822450450
union screw thread M10x1 for pipe ø 6mm Qty 1 pcs			
	GEV No.	101282	Ref. No. MA469000
olive for pipe ø 4mm L 7.4mm Qty 1 pcs			
	GEV No.	101287	Ref. No. —
olive for pipe ø 6mm Qty 1 pcs			
	GEV No.	102110	Ref. No. —
pilot tube copper pipe ø 4mm thickness 1mm L 3000mm			

Table continues overleaf

accessories for	100110		
	GEV No.	102111	Ref. No. —
pilot tube copper pipe ø 6mm thickness 1mm L 3000mm			
	GEV No.	107650	Ref. No. 822140360 BN822140360 CR0410100
pilot burner nozzle SIT LPG code 30 Qty 1 pcs			

JUNKERS

CB 505 series

pilot burners











GEV No.	100073	Ref. No.	MA509900
description	pilot burner JUNKERS type CB505018 3 flames natural gas nozzle no.9 gas connection 6mm with primary air		
spare parts for	100073		
	GEV No.	100231	Ref. No. —
pilot burner nozzle natural gas gas pressure 25mbar code 4 Qty 1 pcs suitable for JUNKERS CB5050_			
	GEV No.	100703	Ref. No. —
ignition electrode D1 ø 9mm connection M4 D2 ø 11mm L1 8mm BL1 13mm BL2 4mm BL3 22mm to clip			
	GEV No.	100907	Ref. No. MA1891700
screw connection thread M10x1 Qty 1 pcs type SEF 1 ømm for thermocouple			
	GEV No.	101282	Ref. No. MA469000
olive for pipe ø 4mm L 7.4mm Qty 1 pcs			
	GEV No.	101283	Ref. No. —
union screw thread M10x1 for pipe ø 4mm Qty 1 pcs			
	GEV No.	101292	Ref. No. —
union screw for igniter suitable for CB 502/505 Qty 1 pcs			
accessories for	100073		
	GEV No.	100217	Ref. No. —
pilot burner nozzle LPG gas pressure 30mbar code 3 Qty 1 pcs suitable for JUNKERS CB5050_			
	GEV No.	100230	Ref. No. —
pilot burner nozzle LPG gas pressure 50mbar code 2 Qty 1 pcs suitable for JUNKERS CB5050_			
	GEV No.	100232	Ref. No. —
pilot burner nozzle natural gas gas pressure 25mbar code 9 Qty 1 pcs suitable for JUNKERS CB5050_			
	GEV No.	100233	Ref. No. —
pilot burner nozzle LPG gas pressure 50mbar code 8 Qty 1 pcs suitable for JUNKERS CB5050_			
	GEV No.	100234	Ref. No. —
pilot burner nozzle natural gas gas pressure 20mbar code 14 Qty 1 pcs suitable for JUNKERS CB5050_			
	GEV No.	100909	Ref. No. 822450450
union screw thread M10x1 for pipe ø 6mm Qty 1 pcs			

accessories for	100073		
	GEV No.	101288	Ref. No. —
olive for pipe ø 6mm L 6mm aluminium Qty 1 pcs ED ø 8.5mm			















POLIDORO







pilot burners



GEV No.	102800	Ref. No.	41853310042 BN41853310042
description	pilot burner POLIDORO 3 flames code gas connection 6mm		
For models:	SERIE 900, SERIE700		
spare parts for	102800		
	GEV No.	100906	Ref. No. 6A011707 MA1888400
screw connection thread M10x1 for ignition electrode brass Qty 1 pcs WS 10			
	GEV No.	100907	Ref. No. MA1891700
screw connection thread M10x1 Qty 1 pcs type SEF 1 ømm for thermocouple			
	GEV No.	100909	Ref. No. 822450450
union screw thread M10x1 for pipe ø 6mm Qty 1 pcs			
	GEV No.	101287	Ref. No. —
olive for pipe ø 6mm Qty 1 pcs			
accessories for	102800		
	GEV No.	100208	Ref. No. —
pilot burner nozzle POLIDORO LPG code 20 bore ø 0.2mm Qty 1 pcs			
	GEV No.	100209	Ref. No. —
pilot burner nozzle POLIDORO natural gas code 40 bore ø 0.4mm Qty 1 pcs			
	GEV No.	100701	Ref. No. 41826650010 826650010 BN41826650010 MA1888300 MA1949900
ignition electrode connection M4 Qty 1 pcs			
	GEV No.	100908	Ref. No. 0100777 41822450040 41822450110 6A016110 822450040 822450110 BN6A017000 BN822450040 MA673500 R0100777 SIR0100777
union screw thread M10x1 for pipe ø 4mm Qty 1 pcs			
	GEV No.	101280	Ref. No. —
olive for pipe ø 4mm Qty 1 pcs			



 <p>1</p>			
GEV No.	100051	Ref. No.	4185327090026 BN4185327090026 SIR0108109
description	pilot burner POLIDORO 3 flames code gas connectionmm		
For models:	SERIE 900, SERIE700		
spare parts for	100051		
	GEV No.	100907	Ref. No. MA1891700
	screw connection thread M10x1 Qty 1 pcs type SEF 1 ømm for thermocouple		
accessories for	100051		
	GEV No.	100000	Ref. No. —
	pilot burner nozzle POLIDORO LPG code 22 bore ø 0.22mm Qty 1 pcs		
	GEV No.	100208	Ref. No. —
	pilot burner nozzle POLIDORO LPG code 20 bore ø 0.2mm Qty 1 pcs		
	GEV No.	100209	Ref. No. —
	pilot burner nozzle POLIDORO natural gas code 40 bore ø 0.4mm Qty 1 pcs		
	GEV No.	100701	Ref. No. 41826650010 826650010 BN41826650010 MA1888300 MA1949900
	ignition electrode connection M4 Qty 1 pcs		
	GEV No.	100906	Ref. No. 6A011707 MA1888400
	screw connection thread M10x1 for ignition electrode brass Qty 1 pcs WS 10		
	GEV No.	100907	Ref. No. MA1891700
	screw connection thread M10x1 Qty 1 pcs type SEF 1 ømm for thermocouple		
	GEV No.	100908	Ref. No. 0100777 41822450040 41822450110 6A016110 822450040 822450110 BN6A017000 BN822450040 MA673500 R0100777 SIR0100777
	union screw thread M10x1 for pipe ø 4mm Qty 1 pcs		
	GEV No.	100909	Ref. No. 822450450
	union screw thread M10x1 for pipe ø 6mm Qty 1 pcs		
	GEV No.	102110	Ref. No. —
	pilot tube copper pipe ø 4mm thickness 1mm L 3000mm		
	GEV No.	102111	Ref. No. —
	pilot tube copper pipe ø 6mm thickness 1mm L 3000mm		
	GEV No.	102508	Ref. No. —
	union screw thread M10x1 for pipe ø 4mm Qty 5 pcs		
	GEV No.	102509	Ref. No. —
	union screw thread M10x1 for pipe ø 6mm Qty 5 pcs		

accessories for	100051		
	GEV No.	102699	Ref. No. —
	pilot burner nozzle POLIDORO natural gas code 25.2 bore ø 2x0.25mm Qty 1 pcs 2 bores		
	GEV No.	102795	Ref. No. —
	olive for pipe ø 4mm Qty 1 pcs		
	GEV No.	102797	Ref. No. —
	olive for pipe ø 6mm Qty 1 pcs		
	GEV No.	106703	Ref. No. BN6A013230
	pilot burner nozzle POLIDORO natural gas code 27.2 bore ø 2x0.27mm Qty 1 pcs		
	GEV No.	106704	Ref. No. BN6A013240
	pilot burner nozzle POLIDORO LPG code 16.2 bore ø 2x0.16mm Qty 1 pcs		
	GEV No.	106763	Ref. No. —
	pilot burner nozzle POLIDORO natural gas code 27.2A bore ø 2x 0.27mm Qty 1 pcs		
	GEV No.	106859	Ref. No. —
	pilot burner nozzle POLIDORO LPG code 24 bore ø 0.24mm Qty 1 pcs		





















 <p>1</p>			
GEV No.	100076	Ref. No.	6A013220 BN6A013220
description	pilot burner POLIDORO 3 flames natural gas code 29.2 gas connection 6mm		
For models:	7BR/GM30, 7FRI/G815		
spare parts for	100076		
	GEV No.	100907	Ref. No. MA1891700
	screw connection thread M10x1 Qty 1 pcs type SEF 1 ømm for thermocouple		
accessories for	100076		
	GEV No.	100000	Ref. No. —
	pilot burner nozzle POLIDORO LPG code 22 bore ø 0.22mm Qty 1 pcs		
	GEV No.	100208	Ref. No. —
	pilot burner nozzle POLIDORO LPG code 20 bore ø 0.2mm Qty 1 pcs		
	GEV No.	100209	Ref. No. —
	pilot burner nozzle POLIDORO natural gas code 40 bore ø 0.4mm Qty 1 pcs		
	GEV No.	100701	Ref. No. 41826650010 826650010 BN41826650010 MA1888300 MA1949900
	ignition electrode connection M4 Qty 1 pcs		
	GEV No.	100906	Ref. No. 6A011707 MA1888400
	screw connection thread M10x1 for ignition electrode brass Qty 1 pcs WS 10		
	GEV No.	100907	Ref. No. MA1891700
	screw connection thread M10x1 Qty 1 pcs type SEF 1 ømm for thermocouple		

Table continues overleaf

accessories for		100076	
	GEV No.	100908	Ref. No.
			0100777 41822450040 41822450110 6A016110 822450040 822450110 BN6A017000 BN822450040 MA673500 R0100777 SIR0100777
	union screw thread M10x1 for pipe ø 4mm Qty 1 pcs		
	GEV No.	100909	Ref. No.
			822450450
	union screw thread M10x1 for pipe ø 6mm Qty 1 pcs		
	GEV No.	102110	Ref. No.
			—
	pilot tube copper pipe ø 4mm thickness 1mm L 3000mm		
	GEV No.	102111	Ref. No.
			—
	pilot tube copper pipe ø 6mm thickness 1mm L 3000mm		
	GEV No.	102508	Ref. No.
			—
	union screw thread M10x1 for pipe ø 4mm Qty 5 pcs		
	GEV No.	102509	Ref. No.
			—
	union screw thread M10x1 for pipe ø 6mm Qty 5 pcs		
	GEV No.	102699	Ref. No.
			—
	pilot burner nozzle POLIDORO natural gas code 25.2 bore ø 2x0.25mm Qty 1 pcs 2 bores		
	GEV No.	102795	Ref. No.
			—
	olive for pipe ø 4mm Qty 1 pcs		
	GEV No.	102797	Ref. No.
			—
	olive for pipe ø 6mm Qty 1 pcs		
	GEV No.	106703	Ref. No.
			BN6A013230
	pilot burner nozzle POLIDORO natural gas code 27.2 bore ø 2x0.27mm Qty 1 pcs		
	GEV No.	106704	Ref. No.
			BN6A013240
	pilot burner nozzle POLIDORO LPG code 16.2 bore ø 2x0.16mm Qty 1 pcs		
	GEV No.	106763	Ref. No.
			—
	pilot burner nozzle POLIDORO natural gas code 27.2A bore ø 2x 0.27mm Qty 1 pcs		
	GEV No.	106859	Ref. No.
			—
	pilot burner nozzle POLIDORO LPG code 24 bore ø 0.24mm Qty 1 pcs		















PRO-GAS			
140 - 145 -150 series			
pilot burners			
	1		
GEV No.	101930	Ref. No.	41826920140 BN41826920140 BN826920140
description	pilot burner 1 flame without nozzle		
spare parts for	101930		
	GEV No.	100907	Ref. No.
			MA1891700
	screw connection thread M10x1 Qty 1 pcs type SEF 1 ømm for thermocouple		
accessories for	101930		
	GEV No.	100204	Ref. No.
			MA1888000
	pilot burner nozzle SIT LPG code 14 bore ø 0.18/0.20mm Qty 1 pcs suitable for 140 series		
	GEV No.	100205	Ref. No.
			41822140380 822140380 BN822140380
	pilot burner nozzle SIT LPG code 19 bore ø 0.23/0.26mm Qty 1 pcs suitable for SIT 150 series		
	GEV No.	100206	Ref. No.
			—
	pilot burner nozzle SIT natural gas code 36 bore ø 0.60/0.55mm Qty 1 pcs suitable for SIT 150 series		
	GEV No.	100207	Ref. No.
			41822140120 6A013107 822140120 MA1887800
	pilot burner nozzle SIT natural gas code 27 bore ø 0.40/0.38mm suitable for SIT 140 series		
	GEV No.	100216	Ref. No.
			—
	pilot burner nozzle SIT natural gas code 38 bore ø 0.45mm Qty 1 pcs suitable for SIT 150 series		
	GEV No.	100701	Ref. No.
			41826650010 826650010 BN41826650010 MA1888300 MA1949900
	ignition electrode connection M4 Qty 1 pcs		
	GEV No.	100803	Ref. No.
			—
	gasket for pilot burner Qty 1 pcs		
	GEV No.	100897	Ref. No.
			41822450050 822450050 BN822450050 MA1888100
	olive for pipe ø 4mm Qty 1 pcs for pilot burner		
	GEV No.	100898	Ref. No.
			41822450470 822450470 BN41822450470
	olive for pipe ø 6mm Qty 1 pcs for pilot burner		
	GEV No.	100906	Ref. No.
			6A011707 MA1888400
	screw connection thread M10x1 for ignition electrode brass Qty 1 pcs WS 10		

Table continues overleaf



accessories for 101930					
	<table border="1"> <tr> <td>GEV No.</td> <td>100908</td> <td>Ref. No.</td> <td>0100777 41822450040 41822450110 6A016110 822450040 822450110 BN6A017000 BN822450040 MA673500 R0100777 SIR0100777</td> </tr> </table>	GEV No.	100908	Ref. No.	0100777 41822450040 41822450110 6A016110 822450040 822450110 BN6A017000 BN822450040 MA673500 R0100777 SIR0100777
GEV No.	100908	Ref. No.	0100777 41822450040 41822450110 6A016110 822450040 822450110 BN6A017000 BN822450040 MA673500 R0100777 SIR0100777		
union screw thread M10x1 for pipe ø 4mm Qty 1 pcs					
	<table border="1"> <tr> <td>GEV No.</td> <td>100909</td> <td>Ref. No.</td> <td>822450450</td> </tr> </table>	GEV No.	100909	Ref. No.	822450450
GEV No.	100909	Ref. No.	822450450		
union screw thread M10x1 for pipe ø 6mm Qty 1 pcs					

producer-specific pilot burners

BARON

600 series

	1		
GEV No.	101929	Ref. No.	41822160360 41822160361 BN41822160361
description	mushroom cap suitable for BARON		
For models:	6PG, SERIE 600		

	1		
GEV No.	101899	Ref. No.	41822410310 41822410311 BN41822410311
description	pilot burner type angled suitable for BARON		
For models:	SERIE 600		

700 / 900 / GIANO 110 / GIANO 140 series





















	1		
GEV No.	101930	Ref. No.	41826920140 BN41826920140 BN826920140
description	pilot burner 1 flame without nozzle		
spare parts for	101930		
	GEV No.	100907	Ref. No. MA1891700
screw connection thread M10x1 Qty 1 pcs type SEF 1 ømm for thermocouple			
accessories for	101930		
	GEV No.	100204	Ref. No. MA1888000
pilot burner nozzle SIT LPG code 14 bore ø 0.18/0.20mm Qty 1 pcs suitable for 140 series			
	GEV No.	100205	Ref. No. 41822140380 822140380 BN822140380
pilot burner nozzle SIT LPG code 19 bore ø 0.23/0.26mm Qty 1 pcs suitable for SIT 150 series			
	GEV No.	100206	Ref. No. —
pilot burner nozzle SIT natural gas code 36 bore ø 0.60/0.55mm Qty 1 pcs suitable for SIT 150 series			
	GEV No.	100207	Ref. No. 41822140120 6A013107 822140120 MA1887800
pilot burner nozzle SIT natural gas code 27 bore ø 0.40/0.38mm suitable for SIT 140 series			
	GEV No.	100216	Ref. No. —
pilot burner nozzle SIT natural gas code 38 bore ø 0.45mm Qty 1 pcs suitable for SIT 150 series			
	GEV No.	100701	Ref. No. 41826650010 826650010 BN41826650010 MA1888300 MA1949900
ignition electrode connection M4 Qty 1 pcs			
	GEV No.	100803	Ref. No. —
gasket for pilot burner Qty 1 pcs			
	GEV No.	100897	Ref. No. 41822450050 822450050 BN822450050 MA1888100
olive for pipe ø 4mm Qty 1 pcs for pilot burner			
	GEV No.	100898	Ref. No. 41822450470 822450470 BN41822450470
olive for pipe ø 6mm Qty 1 pcs for pilot burner			
	GEV No.	100906	Ref. No. 6A011707 MA1888400
screw connection thread M10x1 for ignition electrode brass Qty 1 pcs WS 10			

Table continues overleaf

accessories for 101930					
	<table border="1"> <tr> <th>GEV No.</th> <th>100908</th> <th>Ref. No.</th> <td>0100777 41822450040 41822450110 6A016110 822450040 822450110 BN6A017000 BN822450040 MA673500 R0100777 SIR0100777</td> </tr> </table> <p>union screw thread M10x1 for pipe ø4mm Qty 1 pcs</p>	GEV No.	100908	Ref. No.	0100777 41822450040 41822450110 6A016110 822450040 822450110 BN6A017000 BN822450040 MA673500 R0100777 SIR0100777
GEV No.	100908	Ref. No.	0100777 41822450040 41822450110 6A016110 822450040 822450110 BN6A017000 BN822450040 MA673500 R0100777 SIR0100777		
	<table border="1"> <tr> <th>GEV No.</th> <th>100909</th> <th>Ref. No.</th> <td>822450450</td> </tr> </table> <p>union screw thread M10x1 for pipe ø6mm Qty 1 pcs</p>	GEV No.	100909	Ref. No.	822450450
GEV No.	100909	Ref. No.	822450450		

			
1			
GEV No.	107739	Ref. No.	822160580 BN822160580
description	pilot burner 1 gas connection M9x1mm bore ø 3mm		

					
1					
GEV No.	107487	Ref. No.	N/A		
description	pilot burner natural/liquid gas				
spare parts for	107487				
	<table border="1"> <tr> <th>GEV No.</th> <th>100204</th> <th>Ref. No.</th> <td>MA1888000</td> </tr> </table> <p>pilot burner nozzle SIT LPG code 14 bore ø 0.18/0.20mm Qty 1 pcs suitable for 140 series</p>	GEV No.	100204	Ref. No.	MA1888000
GEV No.	100204	Ref. No.	MA1888000		
	<table border="1"> <tr> <th>GEV No.</th> <th>100207</th> <th>Ref. No.</th> <td>41822140120 6A013107 822140120 MA1887800</td> </tr> </table> <p>pilot burner nozzle SIT natural gas code 27 bore ø 0.40/0.38mm suitable for SIT 140 series</p>	GEV No.	100207	Ref. No.	41822140120 6A013107 822140120 MA1887800
GEV No.	100207	Ref. No.	41822140120 6A013107 822140120 MA1887800		
	<table border="1"> <tr> <th>GEV No.</th> <th>100897</th> <th>Ref. No.</th> <td>41822450050 822450050 BN822450050 MA1888100</td> </tr> </table> <p>olive for pipe ø 4mm Qty 1 pcs for pilot burner</p>	GEV No.	100897	Ref. No.	41822450050 822450050 BN822450050 MA1888100
GEV No.	100897	Ref. No.	41822450050 822450050 BN822450050 MA1888100		
	<table border="1"> <tr> <th>GEV No.</th> <th>100898</th> <th>Ref. No.</th> <td>41822450470 822450470 BN41822450470</td> </tr> </table> <p>olive for pipe ø 6mm Qty 1 pcs for pilot burner</p>	GEV No.	100898	Ref. No.	41822450470 822450470 BN41822450470
GEV No.	100898	Ref. No.	41822450470 822450470 BN41822450470		

spare parts for 107487					
	<table border="1"> <tr> <th>GEV No.</th> <th>100908</th> <th>Ref. No.</th> <td>0100777 41822450040 41822450110 6A016110 822450040 822450110 BN6A017000 BN822450040 MA673500 R0100777 SIR0100777</td> </tr> </table> <p>union screw thread M10x1 for pipe ø 4mm Qty 1 pcs</p>	GEV No.	100908	Ref. No.	0100777 41822450040 41822450110 6A016110 822450040 822450110 BN6A017000 BN822450040 MA673500 R0100777 SIR0100777
GEV No.	100908	Ref. No.	0100777 41822450040 41822450110 6A016110 822450040 822450110 BN6A017000 BN822450040 MA673500 R0100777 SIR0100777		
	<table border="1"> <tr> <th>GEV No.</th> <th>100909</th> <th>Ref. No.</th> <td>822450450</td> </tr> </table> <p>union screw thread M10x1 for pipe ø 6mm Qty 1 pcs</p>	GEV No.	100909	Ref. No.	822450450
GEV No.	100909	Ref. No.	822450450		
	<table border="1"> <tr> <th>GEV No.</th> <th>101930</th> <th>Ref. No.</th> <td>41826920140 826920140 BN41826920140 BN826920140</td> </tr> </table> <p>pilot burner 1 flame without nozzle</p>	GEV No.	101930	Ref. No.	41826920140 826920140 BN41826920140 BN826920140
GEV No.	101930	Ref. No.	41826920140 826920140 BN41826920140 BN826920140		
	<table border="1"> <tr> <th>GEV No.</th> <th>102754</th> <th>Ref. No.</th> <td>41822160302 41826920220 41826920221 41826920222 822160302 826920220 826920221 826920222 BN41822160302 BN41826920222</td> </tr> </table> <p>nozzle holder</p>	GEV No.	102754	Ref. No.	41822160302 41826920220 41826920221 41826920222 822160302 826920220 826920221 826920222 BN41822160302 BN41826920222
GEV No.	102754	Ref. No.	41822160302 41826920220 41826920221 41826920222 822160302 826920220 826920221 826920222 BN41822160302 BN41826920222		











					
1					
GEV No.	107488	Ref. No.	N/A		
description	pilot burner natural/liquid gas				
spare parts for	107488				
	<table border="1"> <tr> <th>GEV No.</th> <th>100204</th> <th>Ref. No.</th> <td>MA1888000</td> </tr> </table> <p>pilot burner nozzle SIT LPG code 14 bore ø 0.18/0.20mm Qty 1 pcs suitable for 140 series</p>	GEV No.	100204	Ref. No.	MA1888000
GEV No.	100204	Ref. No.	MA1888000		
	<table border="1"> <tr> <th>GEV No.</th> <th>100207</th> <th>Ref. No.</th> <td>41822140120 6A013107 822140120 MA1887800</td> </tr> </table> <p>pilot burner nozzle SIT natural gas code 27 bore ø 0.40/0.38mm suitable for SIT 140 series</p>	GEV No.	100207	Ref. No.	41822140120 6A013107 822140120 MA1887800
GEV No.	100207	Ref. No.	41822140120 6A013107 822140120 MA1887800		
	<table border="1"> <tr> <th>GEV No.</th> <th>100897</th> <th>Ref. No.</th> <td>41822450050 822450050 BN822450050 MA1888100</td> </tr> </table> <p>olive for pipe ø 4mm Qty 1 pcs for pilot burner</p>	GEV No.	100897	Ref. No.	41822450050 822450050 BN822450050 MA1888100
GEV No.	100897	Ref. No.	41822450050 822450050 BN822450050 MA1888100		
	<table border="1"> <tr> <th>GEV No.</th> <th>100898</th> <th>Ref. No.</th> <td>41822450470 822450470 BN41822450470</td> </tr> </table> <p>olive for pipe ø 6mm Qty 1 pcs for pilot burner</p>	GEV No.	100898	Ref. No.	41822450470 822450470 BN41822450470
GEV No.	100898	Ref. No.	41822450470 822450470 BN41822450470		

Table continues overleaf



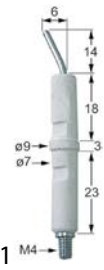
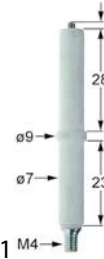

spare parts for 107488				
	GEV No.	100908	Ref. No.	0100777 41822450040 41822450110 6A016110 822450040 822450110 BN6A017000 BN822450040 MA673500 R0100777 SIR0100777
union screw thread M10x1 for pipe ø 4mm Qty 1 pcs				
	GEV No.	100909	Ref. No.	822450450
union screw thread M10x1 for pipe ø 6mm Qty 1 pcs				
	GEV No.	101930	Ref. No.	41826920140 826920140 BN41826920140 BN826920140
pilot burner 1 flame without nozzle				
	GEV No.	102763	Ref. No.	41822160461 822160460 822160461 BN41822160461 BN822160461
nozzle holder				
	GEV No.	106616	Ref. No.	41822450610 822450610 BN41822450610 BN822450610
elbow screw joint T1: M10x1 tube ø 6mm				

	GEV No.	100706	Ref. No.	41853310150 636700 85326010046 BN41853310150 MA224211 MA636700
description ignition electrode connection M4 Qty 1 pcs				
For models: SERIE 900, SERIE700				

	GEV No.	102314	Ref. No.	4185326010061 BN4185326010061 CR0687080
description ignition electrode D1 ø 7mm D2 ø 9mm connection M4 L1 2mm BL1 28mm BL2 3mm BL3 23mm to clip				
For models: SERIE 900, SERIE700				

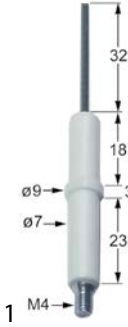
electrodes

	GEV No.	100701	Ref. No.	41826650010 BN41826650010 MA1888300 MA1949900
description ignition electrode connection M4 Qty 1 pcs				
For models: SERIE 600, SERIE 900, SERIE GIANO 110, SERIE GIANO 140, SERIE700				
accessories for 100701				
	GEV No.	100906	Ref. No.	6A011707 MA1888400
screw connection thread M10x1 for ignition electrode brass Qty 1 pcs WS 10				

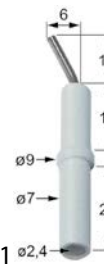
	GEV No.	100707	Ref. No.	6A013302 BN6A013302
description ignition electrode D1 ø 7mm D2 ø 9mm connection ø2.4mm L1 14mm L2 6mm BL1 18mm BL2 3mm BL3 23mm to clip Qty 1 pcs				
For models: 7FRI/G815				

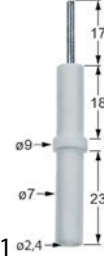
	GEV No.	106619	Ref. No.	6A013301 BN6A013301
description ignition electrode D1 ø 7mm D2 ø 9mm L1 17mm BL1 18mm BL2 3mm BL3 23mm to clip connection ø 2.4mm				
For models: 7FT/G800, 7FTT/G405, 7FTT/G410				

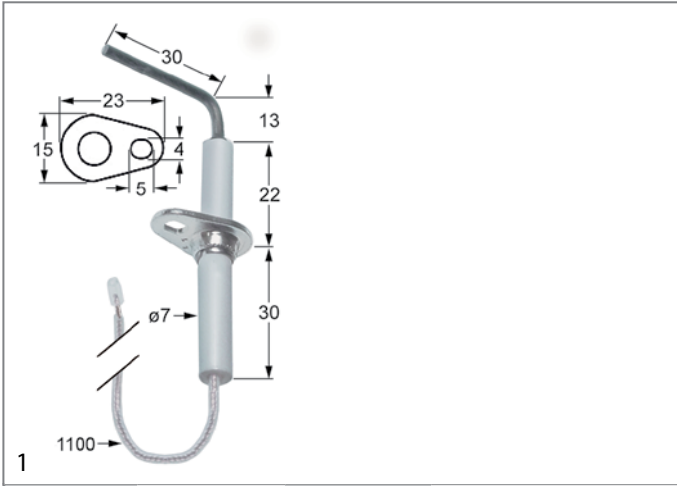

GEV No.	102335	Ref. No.	3104900 BN3104900
description	ignition electrode flange length 23mm flange width 15mm D1 ø 7mm L1 13mm L2 30mm BL1 22mm BL2 30mm cable length 1100mm fixing dimensions ø5x4mm with flange		
For models:	ECVMG 10, ECVMG 20, ECVMG 21, ECVMG 6, ECVPG 10, ECVPG 20, ECVPG 21, ECVPG 6		



GEV No.	100906	Ref. No.	6A011707 MA1888400
description	screw connection thread M10x1 for ignition electrode brass Qty 1 pcs WS 10		
For models:	7FT/G800, 7FTT/G405, 7FTT/G410		

ignition cables

pre-assembled cables

GEV No.	100026	Ref. No.	4185326050065 BN2532997 BN4185326050065 BN85326050065
description	ignition cable cable length 1000mm connection ø4mm / F6.3mm		
For models:	SERIE 900, SERIE700		

GEV No.	100179	Ref. No.	41826690061 41826690062 BN826690062 LAR66600400
description	ignition cable cable length 1200mm connection F2.8mm / ø2.4mm		
For models:	SERIE 900, SERIE GIANO 110, SERIE GIANO 140, SERIE700		

GEV No.	100191	Ref. No.	41826690550 BN826690550
description	ignition cable cable length 2000mm connection F2.8mm / ø2.4mm		

GEV No.	102189	Ref. No.	CR0508710
description	ignition cable cable length 300mm connection ø2.4mm / lug M4		

GEV No.	100197	Ref. No.	41826690051 41826690052 BN8220191 BN826690052
description	ignition cable cable length 600mm connection F2.8mm / ø2.4mm		
For models:	SERIE 900, SERIE GIANO 110, SERIE GIANO 140, SERIE700		

GEV No.	100186	Ref. No.	1936300 MA1936300
description	ignition cable cable length 600mm connection ø2.4mm / lug M4		

GEV No.	100016	Ref. No.	2510698 41826690011 BN2510698 BN41826690011
description	ignition cable cable length 900mm connection ø2.4mm / ø2.4mm		
For models:	7FRI/G815		



GEV No.	100019	Ref. No.	85326050610 BN4185326050610
description	ignition cable cable length 900mm connection ø2.4mm / ø4mm		
For models:	SERIE 900, SERIE700		

piezoelectric igniters



mounting diameter 18mm

GEV No.	100003	Ref. No.	1936100 MA1936100
description	piezoelectric igniter body metal blowing mounting ø 18mm connec- tion F2.8x0.8		





			
1			
GEV No.	100012	Ref. No.	41861310850 BN41861310850 BN861310850
description	piezoelectric igniter body plastic blowing mounting ø 18mm connection ø2.4mm		
spare parts for	100012		
		GEV No.	101339
		Ref. No.	—
	cover cap for piezoelectric igniter		

			
1			
GEV No.	100009	Ref. No.	418261310850 41826630020 6A041105 BN41826630020 BN6A041105
description	piezoelectric igniter body plastic blowing mounting ø 18mm connection ø2.4mm front measurements 26mm M18x1.5		
For models:	7FRI/G815, 7FT/G800, 7FTT/G405, 7FTT/G410, SERIE 600, SERIE 900, SERIE GIANO 110, SERIE GIANO 140, SERIE700		
accessories for	100009		
		GEV No.	101339
		Ref. No.	—
	cover cap for piezoelectric igniter		
		GEV No.	106869
		Ref. No.	—
	cover cap for piezoelectric igniter ID ø 22mm ED ø 35mm H 25mm		
		GEV No.	107931
		Ref. No.	—
	cover cap for piezoelectric igniter ID ø 21mm ED ø 36mm		

miscellaneous			
			
1			
GEV No.	nla ¹	Ref. No.	4185327020230 BN4185327020230 BN85327020230
description	piezoelectric igniter suitable for Minisit with cover cap ømm connection F6.3x0.8		
For models:	SERIE 900, SERIE700		
spare parts for	101136		
		GEV No.	100001
		Ref. No.	—
	piezoelectric igniter suitable for Minisit connection F6.3x0.8 ømm		

¹no longer available

accessories			
			
1			
GEV No.	691392	Ref. No.	41822160540 BN822160540
description	ring for piezoelectric igniter ID ø 18mm ED ø 30mm H 2mm mounting ø 22mm		

ignition units			
			
1			
GEV No.	102485	Ref. No.	MA2971400
description	ignition unit outputs 2 220-240VAC 0.6VA 50-60Hz		

			
1			
GEV No.	101015	Ref. No.	41826630040 41826630400 BN41826630400 BN826630400
description	ignition unit outputs 4 230VAC 0.6VA 50Hz		

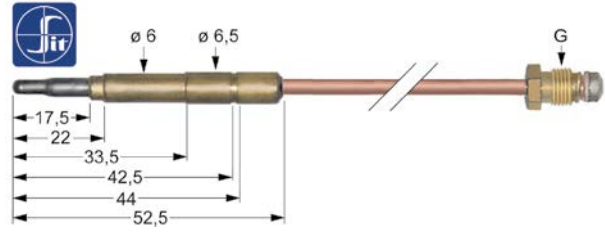
thermocouples			
plug-in thermocouples			
plug-in thermocouples standard			
with barrel socket ø6(6.5)mm			
thermocouples SIT			
			
1			
GEV No.	107621	Ref. No.	41853310070 BN41853310070 SI0100815 SIR0100815
description	thermocouple SIT M10x1 L 1500mm plug connection ø6.0(6.5)mm		
For models:	SERIE 900, SERIE700		

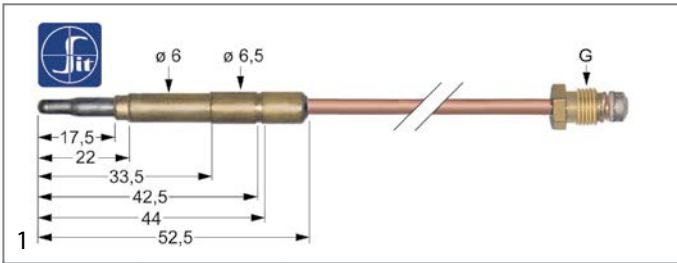

GEV No.	107601	Ref. No.	MA1206400
description	thermocouple SIT M8x1 L 600mm plug connection ϕ 6.0(6.5)mm		

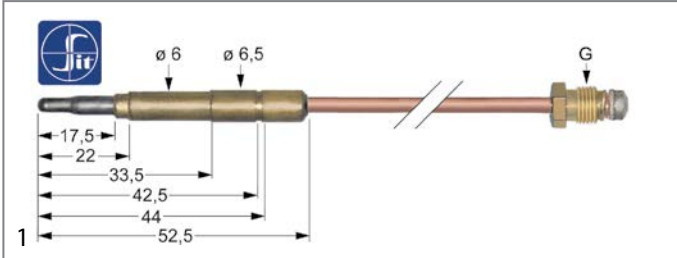

GEV No.	107608	Ref. No.	1031504300 6A011912 BN6A011912 MA1031504300
description	thermocouple SIT M9x1 L 500mm plug connection ϕ 6.0(6.5)mm		

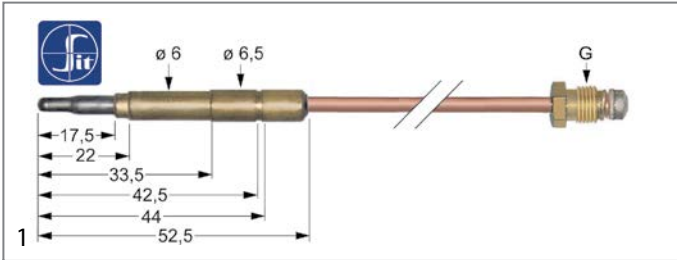

GEV No.	107609	Ref. No.	85326010055
description	thermocouple SIT M9x1 L 600mm plug connection ϕ 6.0(6.5)mm		
For models:	SERIE 900, SERIE700		

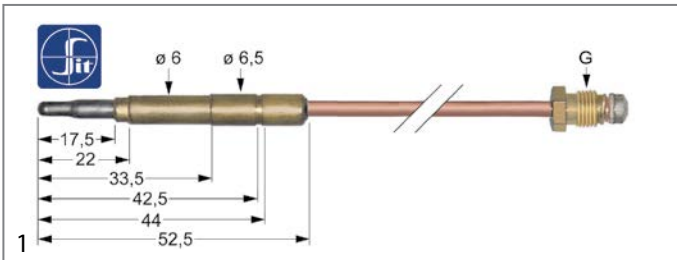

GEV No.	107611	Ref. No.	41826920080 4185326010057 6A011904 BN41826920080 BN4185326010057 BN826920080 MA1916000 MACM029100
description	thermocouple SIT M9x1 L 850mm plug connection ϕ 6.0(6.5)mm		
For models:	7FT/G800, 7FTT/G405, 7FTT/G410, 7PCV/G120, SERIE 600, SERIE 900, SERIE GIANO 110, SERIE GIANO 140, SERIE700		

plug-in thermocouples with interruption

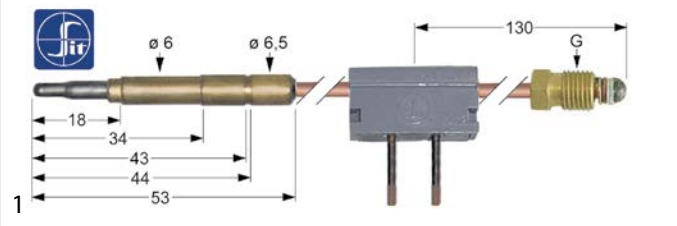

GEV No.	107164	Ref. No.	6A011910 BN6A011910 CR0843660
description	thermocouple SIT with interrupter M9x1 L 1000mm plug connection ϕ 6.0(6.5)mm soldering connection		
For models:	7FR/G815		

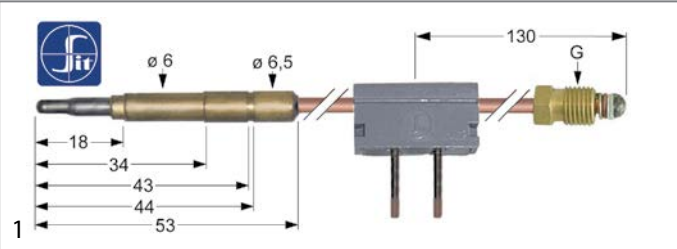

GEV No.	102068	Ref. No.	41826920130 BN41826920130
description	thermocouple SIT with interrupter M9x1 L 320mm plug connection ϕ 6.0mm soldering connection		
For models:	SERIE 900, SERIE700		

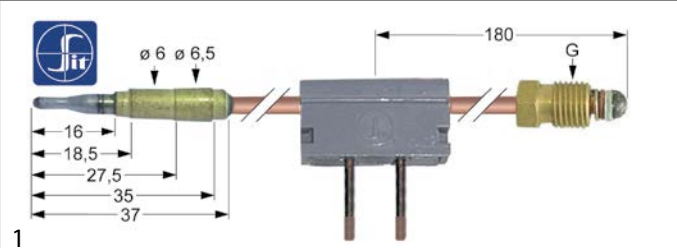

GEV No.	107234	Ref. No.	826920120 BN826920120
description	thermocouple SIT with interrupter M9x1 L 400mm plug connection ϕ 6.0mm soldering connection		

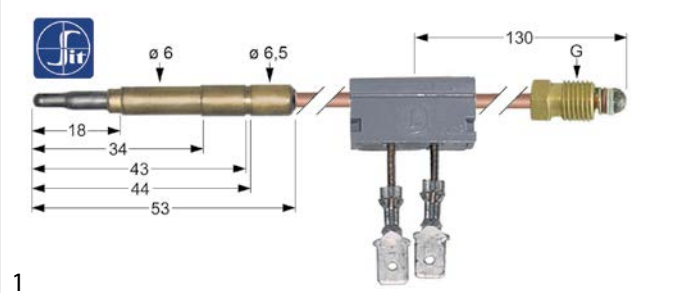

GEV No.	107177	Ref. No.	41826920050 6A011909 BN41826920050 BN6A011909
description	thermocouple SIT with interrupter M9x1 L 600mm plug connection ϕ 6.0mm F 6.3mm		
For models:	7FT/G800, 7FTT/G405, 7FTT/G410, SERIE 600, SERIE 900, SERIE GIANO 110, SERIE700		



1

GEV No.	102247	Ref. No.	1955500 CR0508700 MA1955500
description	thermocouple with interrupter M9x1 L 600mm plug connection ø6.0mm cable 700mm		

threaded thermocouples
threaded thermocouples standard
with socket with thread M8x1

SIT

1

GEV No.	107633	Ref. No.	MA1665000
description	thermocouple SIT M8x1 L 1200mm M8x1		
accessories for	107633		
	GEV No.	Ref. No.	6A012300 BN6A012300 MA939300
	102067		
	nut thread M8x1 H 3mm brass Qty 1 pcs type SEF 1		

thermopiles

1

GEV No.	102116	Ref. No.	826920100 BN826920100
description	thermopile ROBERTSHAW L 900mm probe ø 9mm probe L 57mm 250-750mV screw connection 7/16"		

accessories

nuts

1

GEV No.	102067	Ref. No.	6A012300 BN6A012300 MA939300
description	nut thread M8x1 H 3mm brass Qty 1 pcs type SEF 1		

screws

1

GEV No.	100920	Ref. No.	6A013401 BN6A013401
description	thermocouple fitting thread M8x1 / M9x1 Qty 1 pcs		
For models:	7FT/G800, 7FTT/G405, 7FTT/G410		

1

GEV No.	101260	Ref. No.	MA1359100
description	thermocouple fitting thread M8x1 Qty 1 pcs		

gas burners
hob burners

producer-specific hob burners

BARON

600 series

1

GEV No.	105666	Ref. No.	41822410340 BN41822410340
description	burner cap ø 104mm		
For models:	SERIE 600		

1

GEV No.	105667	Ref. No.	41822410350 BN41822410350
description	burner head for burner cap ø 104mm		
For models:	SERIE 600		



			
1			
GEV No.	102752	Ref. No.	41822410360 BN41822410360
description	venturi		
For models:	SERIE 600		

700, 900 (new) series

			
1			

GEV No.	105677	Ref. No.	41822120020 BN41822120020 BN822120020
description	air mixing sleeve L 40mm ID ø 40mm ED ø 42mm aluminium		

accessories for 105677

	GEV No.	102753	Ref. No.	41822160022 822160022 BN41822160022 BN822160022
nozzle holder brass				

	GEV No.	105668	Ref. No.	41822410071 822410071 BN41822410071 BN822410071
burner cap 3.5kW ø 84mm				

	GEV No.	105669	Ref. No.	41822410041 822410041 BN41822410041 BN822410041
burner head 3.5kW for burner cap ø 84mm				

	GEV No.	105670	Ref. No.	41822410011 41822410012 822410011 822410012 BN41822410012 BN822410012
venturi 3.5kW for burner cap ø 84mm				

	GEV No.	105671	Ref. No.	41822410081 822410081 BN41822410081 BN822410081
burner cap 5.7kW ø 102mm				

	GEV No.	105672	Ref. No.	41822410051 822410051 BN41822410051 BN822410051
burner head 5.7kW for burner cap ø 102mm				

	GEV No.	105673	Ref. No.	41822410021 41822410022 822410021 822410022 BN41822410022 BN822410022
venturi 5.7kW for burner cap ø 102mm				

	GEV No.	105674	Ref. No.	41822410091 822410091 BN41822410091 BN822410091
burner cap 7kW ø 125mm with central hole				

	GEV No.	105675	Ref. No.	41822410061 822410061 BN41822410061 BN822410061
burner head 7kW for burner cap ø 125mm				

accessories for 105677

	GEV No.	105676	Ref. No.	41822410031 41822410032 822410031 822410032 BN41822410032 BN822410032
venturi 7/10kW for burner cap ø 125mm				

	GEV No.	105803	Ref. No.	41822160030 41822160031 41822160032 822160030 822160031 822160032 BN41822160031 BN822160031
screw connection thread M16x1.5 L 34mm ID ø 9/10.2mm				

			
1			

GEV No.	105668	Ref. No.	41822410071 BN41822410071 BN822410071
description	burner cap 3.5kW ø 84mm		
For models:	7PCV/G120, SERIE 900, SERIE GIANO 110, SERIE GIANO 140, SERIE700		

accessories for 105668

	GEV No.	102753	Ref. No.	41822160022 822160022 BN41822160022 BN822160022
nozzle holder brass				

	GEV No.	105289	Ref. No.	0100264 2519002 BN2519002 R0100264 SIR0100264
air mixing sleeve L 50mm ED ø 45mm ID ø 42mm aluminium				



	GEV No.	105669	Ref. No.	41822410041 822410041 BN41822410041 BN822410041
burner head 3.5kW for burner cap ø 84mm				

	GEV No.	105670	Ref. No.	41822410011 41822410012 822410011 822410012 BN41822410012 BN822410012
venturi 3.5kW for burner cap ø 84mm				

	GEV No.	105803	Ref. No.	41822160030 41822160031 41822160032 822160030 822160031 822160032 BN41822160031 BN822160031
screw connection thread M16x1.5 L 34mm ID ø 9/10.2mm				





 <p>1</p>			
GEV No.	105671	Ref. No.	41822410081 BN41822410081 BN822410081
description	burner cap 5.7kW ø 102mm		
For models:	7PCV/G120, SERIE 900, SERIE GIANO 110, SERIE GIANO 140		
accessories for	105671		
	GEV No.	102753	Ref. No. 41822160022 822160022 BN41822160022 BN822160022
nozzle holder brass			
	GEV No.	105289	Ref. No. 0100264 2519002 BN2519002 R0100264 SIR0100264
air mixing sleeve L 50mm ED ø 45mm ID ø 42mm aluminium			
	GEV No.	105672	Ref. No. 41822410051 822410051 BN41822410051 BN822410051
burner head 5.7kW for burner cap ø 102mm			
	GEV No.	105673	Ref. No. 41822410021 41822410022 822410021 822410022 BN41822410022 BN822410022
venturi 5.7kW for burner cap ø 102mm			
	GEV No.	105803	Ref. No. 41822160030 41822160031 41822160032 822160030 822160031 822160032 BN41822160031 BN822160031
screw connection thread M16x1.5 L 34mm ID ø 9/10.2mm			

accessories for	105674		
	GEV No.	105676	Ref. No. 41822410031 41822410032 822410031 822410032 BN41822410032 BN822410032
venturi 7/10kW for burner cap ø 125mm			
	GEV No.	105803	Ref. No. 41822160030 41822160031 41822160032 822160030 822160031 822160032 BN41822160031 BN822160031
screw connection thread M16x1.5 L 34mm ID ø 9/10.2mm			

 <p>1</p>			
GEV No.	105674	Ref. No.	41822410091 BN41822410091 BN822410091
description	burner cap 7kW ø 125mm with central hole		
For models:	SERIE 900, SERIE GIANO 110, SERIE GIANO 140		
accessories for	105674		
	GEV No.	102753	Ref. No. 41822160022 822160022 BN41822160022 BN822160022
nozzle holder brass			
	GEV No.	105289	Ref. No. 0100264 2519002 BN2519002 R0100264 SIR0100264
air mixing sleeve L 50mm ED ø 45mm ID ø 42mm aluminium			
	GEV No.	105675	Ref. No. 41822410061 822410061 BN41822410061 BN822410061
burner head 7kW for burner cap ø 125mm			

 <p>1</p>			
GEV No.	107695	Ref. No.	822410650 BN822410650
description	burner head 3.5kW for burner cap ø 84mm		

 <p>1</p>			
GEV No.	107188	Ref. No.	822410660 BN822410660
description	burner head 5.7kW ø 141mm for burner cap ø 102mm		

 <p>1</p>			
GEV No.	107696	Ref. No.	822410670 BN822410670
description	burner head 7/10kW for burner cap ø 125mm		





 <p>1</p>			
GEV No.	102753	Ref. No.	41822160022 BN41822160022 BN822160022
description	nozzle holder brass		
For models:	SERIE 900, SERIE GIANO 110, SERIE GIANO 140, SERIE700		
accessories for	102753		
	GEV No.	105289	Ref. No. 0100264 2519002 BN2519002 R0100264 SIR0100264
air mixing sleeve L 50mm ED ø 45mm ID ø 42mm aluminium			
	GEV No.	105668	Ref. No. 41822410071 822410071 BN41822410071 BN822410071
burner cap 3.5kW ø 84mm			

Table continues overleaf



accessories for		102753	
	GEV No.	105669	Ref. No. 41822410041 822410041 BN41822410041 BN822410041
burner head 3.5kW for burner cap ø 84mm			
	GEV No.	105670	Ref. No. 41822410011 41822410012 822410011 822410012 BN41822410012 BN822410012
venturi 3.5kW for burner cap ø 84mm			
	GEV No.	105671	Ref. No. 41822410081 822410081 BN41822410081 BN822410081
burner cap 5.7kW ø 102mm			
	GEV No.	105672	Ref. No. 41822410051 822410051 BN41822410051 BN822410051
burner head 5.7kW for burner cap ø 102mm			
	GEV No.	105673	Ref. No. 41822410021 41822410022 822410021 822410022 BN41822410022 BN822410022
venturi 5.7kW for burner cap ø 102mm			
	GEV No.	105674	Ref. No. 41822410091 822410091 BN41822410091 BN822410091
burner cap 7kW ø 125mm with central hole			
	GEV No.	105675	Ref. No. 41822410061 822410061 BN41822410061 BN822410061
burner head 7kW for burner cap ø 125mm			
	GEV No.	105676	Ref. No. 41822410031 41822410032 822410031 822410032 BN41822410032 BN822410032
venturi 7/10kW for burner cap ø 125mm			
	GEV No.	105803	Ref. No. 41822160030 41822160031 41822160032 822160030 822160031 822160032 BN41822160031 BN822160031
screw connection thread M16x1.5 L 34mm ID ø 9/10.2mm			

	1		
GEV No.	105803	Ref. No.	41822160030 41822160031 41822160032 BN41822160031 BN822160031
description screw connection thread M16x1.5 L 34mm ID ø 9/10.2mm			
accessories for		105803	
	GEV No.	102753	Ref. No. 41822160022 822160022 BN41822160022 BN822160022
nozzle holder brass			

accessories for		105803	
	GEV No.	105289	Ref. No. 0100264 2519002 BN2519002 R0100264 SIR0100264
air mixing sleeve L 50mm ED ø 45mm ID ø 42mm aluminium			
	GEV No.	105668	Ref. No. 41822410071 822410071 BN41822410071 BN822410071
burner cap 3.5kW ø 84mm			
	GEV No.	105669	Ref. No. 41822410041 822410041 BN41822410041 BN822410041
burner head 3.5kW for burner cap ø 84mm			
	GEV No.	105670	Ref. No. 41822410011 41822410012 822410011 822410012 BN41822410012 BN822410012
venturi 3.5kW for burner cap ø 84mm			
	GEV No.	105671	Ref. No. 41822410081 822410081 BN41822410081 BN822410081
burner cap 5.7kW ø 102mm			
	GEV No.	105672	Ref. No. 41822410051 822410051 BN41822410051 BN822410051
burner head 5.7kW for burner cap ø 102mm			
	GEV No.	105673	Ref. No. 41822410021 41822410022 822410021 822410022 BN41822410022 BN822410022
venturi 5.7kW for burner cap ø 102mm			
	GEV No.	105674	Ref. No. 41822410091 822410091 BN41822410091 BN822410091
burner cap 7kW ø 125mm with central hole			
	GEV No.	105675	Ref. No. 41822410061 822410061 BN41822410061 BN822410061
burner head 7kW for burner cap ø 125mm			
	GEV No.	105676	Ref. No. 41822410031 41822410032 822410031 822410032 BN41822410032 BN822410032
venturi 7/10kW for burner cap ø 125mm			



 <p>1</p>			
GEV No.	105670	Ref. No.	41822410011 41822410012 BN41822410012 BN822410012
description	venturi 3.5kW for burner cap ø 84mm		
For models:	7PCV/G120, SERIE 900, SERIE GIANO 110, SERIE GIANO 140, SERIE700		
accessories for	105670		
	GEV No.	102753	Ref. No. 41822160022 822160022 BN41822160022 BN822160022
nozzle holder brass			
	GEV No.	105289	Ref. No. 0100264 2519002 BN2519002 R0100264 SIR0100264
air mixing sleeve L 50mm ED ø 45mm ID ø 42mm aluminium			
	GEV No.	105668	Ref. No. 41822410071 822410071 BN41822410071 BN822410071
burner cap 3.5kW ø 84mm			
	GEV No.	105669	Ref. No. 41822410041 822410041 BN41822410041 BN822410041
burner head 3.5kW for burner cap ø 84mm			
	GEV No.	105803	Ref. No. 41822160030 41822160031 41822160032 822160030 822160031 822160032 BN41822160031 BN822160031
screw connection thread M16x1.5 L 34mm ID ø 9/10.2mm			

 <p>1</p>			
GEV No.	105673	Ref. No.	41822410021 41822410022 BN41822410022 BN822410022
description	venturi 5.7kW for burner cap ø 102mm		
For models:	7PCV/G120, SERIE 900, SERIE GIANO 110, SERIE GIANO 140, SERIE700		
accessories for	105673		
	GEV No.	102753	Ref. No. 41822160022 822160022 BN41822160022 BN822160022
nozzle holder brass			

accessories for	105673		
	GEV No.	105289	Ref. No. 0100264 2519002 BN2519002 R0100264 SIR0100264
air mixing sleeve L 50mm ED ø 45mm ID ø 42mm aluminium			
	GEV No.	105671	Ref. No. 41822410081 822410081 BN41822410081 BN822410081
burner cap 5.7kW ø 102mm			
	GEV No.	105672	Ref. No. 41822410051 822410051 BN41822410051 BN822410051
burner head 5.7kW for burner cap ø 102mm			
	GEV No.	105803	Ref. No. 41822160030 41822160031 41822160032 822160030 822160031 822160032 BN41822160031 BN822160031
screw connection thread M16x1.5 L 34mm ID ø 9/10.2mm			

 <p>1</p>			
GEV No.	105676	Ref. No.	41822410031 41822410032 BN41822410032 BN822410032
description	venturi 7/10kW for burner cap ø 125mm		
For models:	SERIE 900, SERIE GIANO 110, SERIE GIANO 140		
accessories for	105676		
	GEV No.	102753	Ref. No. 41822160022 822160022 BN41822160022 BN822160022
nozzle holder brass			
	GEV No.	105289	Ref. No. 0100264 2519002 BN2519002 R0100264 SIR0100264
air mixing sleeve L 50mm ED ø 45mm ID ø 42mm aluminium			
	GEV No.	105674	Ref. No. 41822410091 822410091 BN41822410091 BN822410091
burner cap 7kW ø 125mm with central hole			
	GEV No.	105675	Ref. No. 41822410061 822410061 BN41822410061 BN822410061
burner head 7kW for burner cap ø 125mm			

Table continues overleaf





accessories for 105676					
	<table border="1"> <tr> <td>GEV No.</td> <td>105803</td> <td>Ref. No.</td> <td>41822160030 41822160031 41822160032 822160030 822160031 822160032 BN41822160031 BN822160031</td> </tr> </table>	GEV No.	105803	Ref. No.	41822160030 41822160031 41822160032 822160030 822160031 822160032 BN41822160031 BN822160031
GEV No.	105803	Ref. No.	41822160030 41822160031 41822160032 822160030 822160031 822160032 BN41822160031 BN822160031		
screw connection thread M16x1.5 L 34mm ID ø 9/10.2mm					

700, 900, Giano series





GEV No.	105677	Ref. No.	41822120020 BN41822120020 BN822120020
description	air mixing sleeve L 40mm ID ø 40mm ED ø 42mm aluminium		

accessories for 105677					
	<table border="1"> <tr> <td>GEV No.</td> <td>102753</td> <td>Ref. No.</td> <td>41822160022 822160022 BN41822160022 BN822160022</td> </tr> </table>	GEV No.	102753	Ref. No.	41822160022 822160022 BN41822160022 BN822160022
GEV No.	102753	Ref. No.	41822160022 822160022 BN41822160022 BN822160022		
nozzle holder brass					

	<table border="1"> <tr> <td>GEV No.</td> <td>105668</td> <td>Ref. No.</td> <td>41822410071 822410071 BN41822410071 BN822410071</td> </tr> </table>	GEV No.	105668	Ref. No.	41822410071 822410071 BN41822410071 BN822410071
GEV No.	105668	Ref. No.	41822410071 822410071 BN41822410071 BN822410071		
burner cap 3.5kW ø 84mm					

	<table border="1"> <tr> <td>GEV No.</td> <td>105669</td> <td>Ref. No.</td> <td>41822410041 822410041 BN41822410041 BN822410041</td> </tr> </table>	GEV No.	105669	Ref. No.	41822410041 822410041 BN41822410041 BN822410041
GEV No.	105669	Ref. No.	41822410041 822410041 BN41822410041 BN822410041		
burner head 3.5kW for burner cap ø 84mm					

	<table border="1"> <tr> <td>GEV No.</td> <td>105670</td> <td>Ref. No.</td> <td>41822410011 41822410012 822410011 822410012 BN41822410012 BN822410012</td> </tr> </table>	GEV No.	105670	Ref. No.	41822410011 41822410012 822410011 822410012 BN41822410012 BN822410012
GEV No.	105670	Ref. No.	41822410011 41822410012 822410011 822410012 BN41822410012 BN822410012		
venturi 3.5kW for burner cap ø 84mm					



	<table border="1"> <tr> <td>GEV No.</td> <td>105671</td> <td>Ref. No.</td> <td>41822410081 822410081 BN41822410081 BN822410081</td> </tr> </table>	GEV No.	105671	Ref. No.	41822410081 822410081 BN41822410081 BN822410081
GEV No.	105671	Ref. No.	41822410081 822410081 BN41822410081 BN822410081		
burner cap 5.7kW ø 102mm					

	<table border="1"> <tr> <td>GEV No.</td> <td>105672</td> <td>Ref. No.</td> <td>41822410051 822410051 BN41822410051 BN822410051</td> </tr> </table>	GEV No.	105672	Ref. No.	41822410051 822410051 BN41822410051 BN822410051
GEV No.	105672	Ref. No.	41822410051 822410051 BN41822410051 BN822410051		
burner head 5.7kW for burner cap ø 102mm					

	<table border="1"> <tr> <td>GEV No.</td> <td>105673</td> <td>Ref. No.</td> <td>41822410021 41822410022 822410021 822410022 BN41822410022 BN822410022</td> </tr> </table>	GEV No.	105673	Ref. No.	41822410021 41822410022 822410021 822410022 BN41822410022 BN822410022
GEV No.	105673	Ref. No.	41822410021 41822410022 822410021 822410022 BN41822410022 BN822410022		
venturi 5.7kW for burner cap ø 102mm					

	<table border="1"> <tr> <td>GEV No.</td> <td>105674</td> <td>Ref. No.</td> <td>41822410091 822410091 BN41822410091 BN822410091</td> </tr> </table>	GEV No.	105674	Ref. No.	41822410091 822410091 BN41822410091 BN822410091
GEV No.	105674	Ref. No.	41822410091 822410091 BN41822410091 BN822410091		
burner cap 7kW ø 125mm with central hole					

	<table border="1"> <tr> <td>GEV No.</td> <td>105675</td> <td>Ref. No.</td> <td>41822410061 822410061 BN41822410061 BN822410061</td> </tr> </table>	GEV No.	105675	Ref. No.	41822410061 822410061 BN41822410061 BN822410061
GEV No.	105675	Ref. No.	41822410061 822410061 BN41822410061 BN822410061		
burner head 7kW for burner cap ø 125mm					

accessories for 105677					
	<table border="1"> <tr> <td>GEV No.</td> <td>105676</td> <td>Ref. No.</td> <td>41822410031 41822410032 822410031 822410032 BN41822410032 BN822410032</td> </tr> </table>	GEV No.	105676	Ref. No.	41822410031 41822410032 822410031 822410032 BN41822410032 BN822410032
GEV No.	105676	Ref. No.	41822410031 41822410032 822410031 822410032 BN41822410032 BN822410032		
venturi 7/10kW for burner cap ø 125mm					
	<table border="1"> <tr> <td>GEV No.</td> <td>105803</td> <td>Ref. No.</td> <td>41822160030 41822160031 41822160032 822160030 822160031 822160032 BN41822160031 BN822160031</td> </tr> </table>	GEV No.	105803	Ref. No.	41822160030 41822160031 41822160032 822160030 822160031 822160032 BN41822160031 BN822160031
GEV No.	105803	Ref. No.	41822160030 41822160031 41822160032 822160030 822160031 822160032 BN41822160031 BN822160031		
screw connection thread M16x1.5 L 34mm ID ø 9/10.2mm					





GEV No.	105668	Ref. No.	41822410071 BN41822410071 BN822410071
description	burner cap 3.5kW ø 84mm		
For models:	7PCV/G120, SERIE 900, SERIE GIANO 110, SERIE GIANO 140, SERIE700		

accessories for 105668					
	<table border="1"> <tr> <td>GEV No.</td> <td>102753</td> <td>Ref. No.</td> <td>41822160022 822160022 BN41822160022 BN822160022</td> </tr> </table>	GEV No.	102753	Ref. No.	41822160022 822160022 BN41822160022 BN822160022
GEV No.	102753	Ref. No.	41822160022 822160022 BN41822160022 BN822160022		
nozzle holder brass					

	<table border="1"> <tr> <td>GEV No.</td> <td>105289</td> <td>Ref. No.</td> <td>0100264 2519002 BN2519002 R0100264 SIR0100264</td> </tr> </table>	GEV No.	105289	Ref. No.	0100264 2519002 BN2519002 R0100264 SIR0100264
GEV No.	105289	Ref. No.	0100264 2519002 BN2519002 R0100264 SIR0100264		
air mixing sleeve L 50mm ED ø 45mm ID ø 42mm aluminium					

	<table border="1"> <tr> <td>GEV No.</td> <td>105669</td> <td>Ref. No.</td> <td>41822410041 822410041 BN41822410041 BN822410041</td> </tr> </table>	GEV No.	105669	Ref. No.	41822410041 822410041 BN41822410041 BN822410041
GEV No.	105669	Ref. No.	41822410041 822410041 BN41822410041 BN822410041		
burner head 3.5kW for burner cap ø 84mm					



	<table border="1"> <tr> <td>GEV No.</td> <td>105670</td> <td>Ref. No.</td> <td>41822410011 41822410012 822410011 822410012 BN41822410012 BN822410012</td> </tr> </table>	GEV No.	105670	Ref. No.	41822410011 41822410012 822410011 822410012 BN41822410012 BN822410012
GEV No.	105670	Ref. No.	41822410011 41822410012 822410011 822410012 BN41822410012 BN822410012		
venturi 3.5kW for burner cap ø 84mm					

	<table border="1"> <tr> <td>GEV No.</td> <td>105803</td> <td>Ref. No.</td> <td>41822160030 41822160031 41822160032 822160030 822160031 822160032 BN41822160031 BN822160031</td> </tr> </table>	GEV No.	105803	Ref. No.	41822160030 41822160031 41822160032 822160030 822160031 822160032 BN41822160031 BN822160031
GEV No.	105803	Ref. No.	41822160030 41822160031 41822160032 822160030 822160031 822160032 BN41822160031 BN822160031		
screw connection thread M16x1.5 L 34mm ID ø 9/10.2mm					



 <p>1</p>			
GEV No.	105671	Ref. No.	41822410081 BN41822410081 BN822410081
description	burner cap 5.7kW ø 102mm		
For models:	7PCV/G120, SERIE 900, SERIE GIANO 110, SERIE GIANO 140		
accessories for	105671		
	GEV No.	102753	Ref. No. 41822160022 822160022 BN41822160022 BN822160022
nozzle holder brass			
	GEV No.	105289	Ref. No. 0100264 2519002 BN2519002 R0100264 SIR0100264
air mixing sleeve L 50mm ED ø 45mm ID ø 42mm aluminium			
	GEV No.	105672	Ref. No. 41822410051 822410051 BN41822410051 BN822410051
burner head 5.7kW for burner cap ø 102mm			
	GEV No.	105673	Ref. No. 41822410021 41822410022 822410021 822410022 BN41822410022 BN822410022
venturi 5.7kW for burner cap ø 102mm			
	GEV No.	105803	Ref. No. 41822160030 41822160031 41822160032 822160030 822160031 822160032 BN41822160031 BN822160031
screw connection thread M16x1.5 L 34mm ID ø 9/10.2mm			



 <p>1</p>			
GEV No.	105674	Ref. No.	41822410091 BN41822410091 BN822410091
description	burner cap 7kW ø 125mm with central hole		
For models:	SERIE 900, SERIE GIANO 110, SERIE GIANO 140		
accessories for	105674		
	GEV No.	102753	Ref. No. 41822160022 822160022 BN41822160022 BN822160022
nozzle holder brass			
	GEV No.	105289	Ref. No. 0100264 2519002 BN2519002 R0100264 SIR0100264
air mixing sleeve L 50mm ED ø 45mm ID ø 42mm aluminium			
	GEV No.	105675	Ref. No. 41822410061 822410061 BN41822410061 BN822410061
burner head 7kW for burner cap ø 125mm			

accessories for 105674			
	GEV No.	105676	Ref. No. 41822410031 41822410032 822410031 822410032 BN41822410032 BN822410032
venturi 7/10kW for burner cap ø 125mm			
	GEV No.	105803	Ref. No. 41822160030 41822160031 41822160032 822160030 822160031 822160032 BN41822160031 BN822160031
screw connection thread M16x1.5 L 34mm ID ø 9/10.2mm			

 <p>1</p>			
GEV No.	105669	Ref. No.	41822410041 BN41822410041 BN822410041
description	burner head 3.5kW for burner cap ø 84mm		
For models:	7PCV/G120, SERIE 900, SERIE GIANO 110, SERIE GIANO 140		
accessories for	105669		
	GEV No.	102753	Ref. No. 41822160022 822160022 BN41822160022 BN822160022
nozzle holder brass			
	GEV No.	105289	Ref. No. 0100264 2519002 BN2519002 R0100264 SIR0100264
air mixing sleeve L 50mm ED ø 45mm ID ø 42mm aluminium			
	GEV No.	105668	Ref. No. 41822410071 822410071 BN41822410071 BN822410071
burner cap 3.5kW ø 84mm			
	GEV No.	105670	Ref. No. 41822410011 41822410012 822410011 822410012 BN41822410012 BN822410012
venturi 3.5kW for burner cap ø 84mm			
	GEV No.	105803	Ref. No. 41822160030 41822160031 41822160032 822160030 822160031 822160032 BN41822160031 BN822160031
screw connection thread M16x1.5 L 34mm ID ø 9/10.2mm			

 <p>1</p>			
GEV No.	105672	Ref. No.	41822410051 BN41822410051 BN822410051
description	burner head 5.7kW for burner cap ø 102mm		
For models:	7PCV/G120, SERIE 900, SERIE GIANO 110, SERIE GIANO 140, SERIE700		
accessories for	105672		
	GEV No.	102753	Ref. No. 41822160022 822160022 BN41822160022 BN822160022
nozzle holder brass			
	GEV No.	105289	Ref. No. 0100264 2519002 BN2519002 R0100264 SIR0100264
air mixing sleeve L 50mm ED ø 45mm ID ø 42mm aluminium			
	GEV No.	105671	Ref. No. 41822410081 822410081 BN41822410081 BN822410081
burner cap 5.7kW ø 102mm			
	GEV No.	105673	Ref. No. 41822410021 41822410022 822410021 822410022 BN41822410022 BN822410022
venturi 5.7kW for burner cap ø 102mm			
	GEV No.	105803	Ref. No. 41822160030 41822160031 41822160032 822160030 822160031 822160032 BN41822160031 BN822160031
screw connection thread M16x1.5 L 34mm ID ø 9/10.2mm			

 <p>1</p>			
GEV No.	105675	Ref. No.	41822410061 BN41822410061 BN822410061
description	burner head 7kW for burner cap ø 125mm		
For models:	SERIE 900, SERIE GIANO 110, SERIE GIANO 140		
accessories for	105675		
	GEV No.	102753	Ref. No. 41822160022 822160022 BN41822160022 BN822160022
nozzle holder brass			
	GEV No.	105289	Ref. No. 0100264 2519002 BN2519002 R0100264 SIR0100264
air mixing sleeve L 50mm ED ø 45mm ID ø 42mm aluminium			
	GEV No.	105674	Ref. No. 41822410091 822410091 BN41822410091 BN822410091
burner cap 7kW ø 125mm with central hole			

accessories for	105675		
	GEV No.	105676	Ref. No. 41822410031 41822410032 822410031 822410032 BN41822410032 BN822410032
venturi 7/10kW for burner cap ø 125mm			
	GEV No.	105803	Ref. No. 41822160030 41822160031 41822160032 822160030 822160031 822160032 BN41822160031 BN822160031
screw connection thread M16x1.5 L 34mm ID ø 9/10.2mm			

 <p>1</p>			
GEV No.	102753	Ref. No.	41822160022 BN41822160022 BN822160022
description	nozzle holder brass		
For models:	SERIE 900, SERIE GIANO 110, SERIE GIANO 140, SERIE700		
accessories for	102753		
	GEV No.	105289	Ref. No. 0100264 2519002 BN2519002 R0100264 SIR0100264
air mixing sleeve L 50mm ED ø 45mm ID ø 42mm aluminium			
	GEV No.	105668	Ref. No. 41822410071 822410071 BN41822410071 BN822410071
burner cap 3.5kW ø 84mm			
	GEV No.	105669	Ref. No. 41822410041 822410041 BN41822410041 BN822410041
burner head 3.5kW for burner cap ø 84mm			
	GEV No.	105670	Ref. No. 41822410011 41822410012 822410011 822410012 BN41822410012 BN822410012
venturi 3.5kW for burner cap ø 84mm			
	GEV No.	105671	Ref. No. 41822410081 822410081 BN41822410081 BN822410081
burner cap 5.7kW ø 102mm			
	GEV No.	105672	Ref. No. 41822410051 822410051 BN41822410051 BN822410051
burner head 5.7kW for burner cap ø 102mm			
	GEV No.	105673	Ref. No. 41822410021 41822410022 822410021 822410022 BN41822410022 BN822410022
venturi 5.7kW for burner cap ø 102mm			
	GEV No.	105674	Ref. No. 41822410091 822410091 BN41822410091 BN822410091
burner cap 7kW ø 125mm with central hole			

Table continues overleaf





accessories for 102753					
	<table border="1"> <tr> <th>GEV No.</th> <td>105675</td> <th>Ref. No.</th> <td>41822410061 822410061 BN41822410061 BN822410061</td> </tr> </table> <p>burner head 7kW for burner cap ø 125mm</p>	GEV No.	105675	Ref. No.	41822410061 822410061 BN41822410061 BN822410061
GEV No.	105675	Ref. No.	41822410061 822410061 BN41822410061 BN822410061		
	<table border="1"> <tr> <th>GEV No.</th> <td>105676</td> <th>Ref. No.</th> <td>41822410031 41822410032 822410031 822410032 BN41822410032 BN822410032</td> </tr> </table> <p>venturi 7/10kW for burner cap ø 125mm</p>	GEV No.	105676	Ref. No.	41822410031 41822410032 822410031 822410032 BN41822410032 BN822410032
GEV No.	105676	Ref. No.	41822410031 41822410032 822410031 822410032 BN41822410032 BN822410032		
	<table border="1"> <tr> <th>GEV No.</th> <td>105803</td> <th>Ref. No.</th> <td>41822160030 41822160031 41822160032 822160030 822160031 822160032 BN41822160031 BN822160031</td> </tr> </table> <p>screw connection thread M16x1.5 L 34mm ID ø 9/10.2mm</p>	GEV No.	105803	Ref. No.	41822160030 41822160031 41822160032 822160030 822160031 822160032 BN41822160031 BN822160031
GEV No.	105803	Ref. No.	41822160030 41822160031 41822160032 822160030 822160031 822160032 BN41822160031 BN822160031		

	1				
GEV No.	105803	Ref. No.	41822160030 41822160031 41822160032 BN41822160031 BN822160031		
description	screw connection thread M16x1.5 L 34mm ID ø 9/10.2mm				
accessories for 105803					
	<table border="1"> <tr> <th>GEV No.</th> <td>102753</td> <th>Ref. No.</th> <td>41822160022 822160022 BN41822160022 BN822160022</td> </tr> </table> <p>nozzle holder brass</p>	GEV No.	102753	Ref. No.	41822160022 822160022 BN41822160022 BN822160022
GEV No.	102753	Ref. No.	41822160022 822160022 BN41822160022 BN822160022		
	<table border="1"> <tr> <th>GEV No.</th> <td>105289</td> <th>Ref. No.</th> <td>0100264 2519002 BN2519002 R0100264 SIR0100264</td> </tr> </table> <p>air mixing sleeve L 50mm ED ø 45mm ID ø 42mm aluminium</p>	GEV No.	105289	Ref. No.	0100264 2519002 BN2519002 R0100264 SIR0100264
GEV No.	105289	Ref. No.	0100264 2519002 BN2519002 R0100264 SIR0100264		
	<table border="1"> <tr> <th>GEV No.</th> <td>105668</td> <th>Ref. No.</th> <td>41822410071 822410071 BN41822410071 BN822410071</td> </tr> </table> <p>burner cap 3.5kW ø 84mm</p>	GEV No.	105668	Ref. No.	41822410071 822410071 BN41822410071 BN822410071
GEV No.	105668	Ref. No.	41822410071 822410071 BN41822410071 BN822410071		
	<table border="1"> <tr> <th>GEV No.</th> <td>105669</td> <th>Ref. No.</th> <td>41822410041 822410041 BN41822410041 BN822410041</td> </tr> </table> <p>burner head 3.5kW for burner cap ø 84mm</p>	GEV No.	105669	Ref. No.	41822410041 822410041 BN41822410041 BN822410041
GEV No.	105669	Ref. No.	41822410041 822410041 BN41822410041 BN822410041		
	<table border="1"> <tr> <th>GEV No.</th> <td>105670</td> <th>Ref. No.</th> <td>41822410011 41822410012 822410011 822410012 BN41822410012 BN822410012</td> </tr> </table> <p>venturi 3.5kW for burner cap ø 84mm</p>	GEV No.	105670	Ref. No.	41822410011 41822410012 822410011 822410012 BN41822410012 BN822410012
GEV No.	105670	Ref. No.	41822410011 41822410012 822410011 822410012 BN41822410012 BN822410012		
	<table border="1"> <tr> <th>GEV No.</th> <td>105671</td> <th>Ref. No.</th> <td>41822410081 822410081 BN41822410081 BN822410081</td> </tr> </table> <p>burner cap 5.7kW ø 102mm</p>	GEV No.	105671	Ref. No.	41822410081 822410081 BN41822410081 BN822410081
GEV No.	105671	Ref. No.	41822410081 822410081 BN41822410081 BN822410081		
	<table border="1"> <tr> <th>GEV No.</th> <td>105672</td> <th>Ref. No.</th> <td>41822410051 822410051 BN41822410051 BN822410051</td> </tr> </table> <p>burner head 5.7kW for burner cap ø 102mm</p>	GEV No.	105672	Ref. No.	41822410051 822410051 BN41822410051 BN822410051
GEV No.	105672	Ref. No.	41822410051 822410051 BN41822410051 BN822410051		

accessories for 105803					
	<table border="1"> <tr> <th>GEV No.</th> <td>105673</td> <th>Ref. No.</th> <td>41822410021 41822410022 822410021 822410022 BN41822410022 BN822410022</td> </tr> </table> <p>venturi 5.7kW for burner cap ø 102mm</p>	GEV No.	105673	Ref. No.	41822410021 41822410022 822410021 822410022 BN41822410022 BN822410022
GEV No.	105673	Ref. No.	41822410021 41822410022 822410021 822410022 BN41822410022 BN822410022		
	<table border="1"> <tr> <th>GEV No.</th> <td>105674</td> <th>Ref. No.</th> <td>41822410091 822410091 BN41822410091 BN822410091</td> </tr> </table> <p>burner cap 7kW ø 125mm with central hole</p>	GEV No.	105674	Ref. No.	41822410091 822410091 BN41822410091 BN822410091
GEV No.	105674	Ref. No.	41822410091 822410091 BN41822410091 BN822410091		
	<table border="1"> <tr> <th>GEV No.</th> <td>105675</td> <th>Ref. No.</th> <td>41822410061 822410061 BN41822410061 BN822410061</td> </tr> </table> <p>burner head 7kW for burner cap ø 125mm</p>	GEV No.	105675	Ref. No.	41822410061 822410061 BN41822410061 BN822410061
GEV No.	105675	Ref. No.	41822410061 822410061 BN41822410061 BN822410061		
	<table border="1"> <tr> <th>GEV No.</th> <td>105676</td> <th>Ref. No.</th> <td>41822410031 41822410032 822410031 822410032 BN41822410032 BN822410032</td> </tr> </table> <p>venturi 7/10kW for burner cap ø 125mm</p>	GEV No.	105676	Ref. No.	41822410031 41822410032 822410031 822410032 BN41822410032 BN822410032
GEV No.	105676	Ref. No.	41822410031 41822410032 822410031 822410032 BN41822410032 BN822410032		

	1				
GEV No.	105670	Ref. No.	41822410011 41822410012 BN41822410012 BN822410012		
description	venturi 3.5kW for burner cap ø 84mm				
For models:	7PCV/G120, SERIE 900, SERIE GIANO 110, SERIE GIANO 140, SERIE700				
accessories for 105670					
	<table border="1"> <tr> <th>GEV No.</th> <td>102753</td> <th>Ref. No.</th> <td>41822160022 822160022 BN41822160022 BN822160022</td> </tr> </table> <p>nozzle holder brass</p>	GEV No.	102753	Ref. No.	41822160022 822160022 BN41822160022 BN822160022
GEV No.	102753	Ref. No.	41822160022 822160022 BN41822160022 BN822160022		
	<table border="1"> <tr> <th>GEV No.</th> <td>105289</td> <th>Ref. No.</th> <td>0100264 2519002 BN2519002 R0100264 SIR0100264</td> </tr> </table> <p>air mixing sleeve L 50mm ED ø 45mm ID ø 42mm aluminium</p>	GEV No.	105289	Ref. No.	0100264 2519002 BN2519002 R0100264 SIR0100264
GEV No.	105289	Ref. No.	0100264 2519002 BN2519002 R0100264 SIR0100264		
	<table border="1"> <tr> <th>GEV No.</th> <td>105668</td> <th>Ref. No.</th> <td>41822410071 822410071 BN41822410071 BN822410071</td> </tr> </table> <p>burner cap 3.5kW ø 84mm</p>	GEV No.	105668	Ref. No.	41822410071 822410071 BN41822410071 BN822410071
GEV No.	105668	Ref. No.	41822410071 822410071 BN41822410071 BN822410071		
	<table border="1"> <tr> <th>GEV No.</th> <td>105669</td> <th>Ref. No.</th> <td>41822410041 822410041 BN41822410041 BN822410041</td> </tr> </table> <p>burner head 3.5kW for burner cap ø 84mm</p>	GEV No.	105669	Ref. No.	41822410041 822410041 BN41822410041 BN822410041
GEV No.	105669	Ref. No.	41822410041 822410041 BN41822410041 BN822410041		
	<table border="1"> <tr> <th>GEV No.</th> <td>105803</td> <th>Ref. No.</th> <td>41822160030 41822160031 41822160032 822160030 822160031 822160032 BN41822160031 BN822160031</td> </tr> </table> <p>screw connection thread M16x1.5 L 34mm ID ø 9/10.2mm</p>	GEV No.	105803	Ref. No.	41822160030 41822160031 41822160032 822160030 822160031 822160032 BN41822160031 BN822160031
GEV No.	105803	Ref. No.	41822160030 41822160031 41822160032 822160030 822160031 822160032 BN41822160031 BN822160031		

 <p>1</p>			
GEV No.	105673	Ref. No.	41822410021 41822410022 BN41822410022 BN822410022
description	venturi 5.7kW for burner cap ø 102mm		
For models:	7PCV/G120, SERIE 900, SERIE GIANO 110, SERIE GIANO 140, SERIE700		
accessories for	105673		
	GEV No.	102753	Ref. No. 41822160022 822160022 BN41822160022 BN822160022
nozzle holder brass			
	GEV No.	105289	Ref. No. 0100264 2519002 BN2519002 R0100264 SIR0100264
air mixing sleeve L 50mm ED ø 45mm ID ø 42mm aluminium			
	GEV No.	105671	Ref. No. 41822410081 822410081 BN41822410081 BN822410081
burner cap 5.7kW ø 102mm			
	GEV No.	105672	Ref. No. 41822410051 822410051 BN41822410051 BN822410051
burner head 5.7kW for burner cap ø 102mm			
	GEV No.	105803	Ref. No. 41822160030 41822160031 41822160032 822160030 822160031 822160032 BN41822160031 BN822160031
screw connection thread M16x1.5 L 34mm ID ø 9/10.2mm			

 <p>1</p>			
GEV No.	105676	Ref. No.	41822410031 41822410032 BN41822410032 BN822410032
description	venturi 7/10kW for burner cap ø 125mm		
For models:	SERIE 900, SERIE GIANO 110, SERIE GIANO 140		
accessories for	105676		
	GEV No.	102753	Ref. No. 41822160022 822160022 BN41822160022 BN822160022
nozzle holder brass			

accessories for	105676		
	GEV No.	105289	Ref. No. 0100264 2519002 BN2519002 R0100264 SIR0100264
air mixing sleeve L 50mm ED ø 45mm ID ø 42mm aluminium			
	GEV No.	105674	Ref. No. 41822410091 822410091 BN41822410091 BN822410091
burner cap 7kW ø 125mm with central hole			
	GEV No.	105675	Ref. No. 41822410061 822410061 BN41822410061 BN822410061
burner head 7kW for burner cap ø 125mm			
	GEV No.	105803	Ref. No. 41822160030 41822160031 41822160032 822160030 822160031 822160032 BN41822160031 BN822160031
screw connection thread M16x1.5 L 34mm ID ø 9/10.2mm			

solid tops

 <p>1</p>			
GEV No.	105678	Ref. No.	41822160041 BN822160041
description	burner ring for solid top		

 <p>1</p>			
GEV No.	105679	Ref. No.	41826390030 BN826390030
description	round burner ø 190mm for solid top		





pan supports			
			
1			
GEV No.	210212	Ref. No.	41822410110 41822410390 BN41822410390
description	pan support W 272mm L 395mm H 65mm		
For models:	7PCV/G120, SERIE700		

			
1			
GEV No.	210213	Ref. No.	41822410100 41822410400 BN41822410100 BN41822410400 BN822410400
description	pan support W 345mm holder length 345mm total length 390mm		
For models:	SERIE 900, SERIE GIANO 110, SERIE GIANO 140		

			
1			
GEV No.	210213	Ref. No.	41822410100 41822410400 BN41822410100 BN41822410400 BN822410400
description	pan support W 345mm holder length 345mm total length 390mm		
For models:	SERIE 900, SERIE GIANO 110, SERIE GIANO 140		

			
1			
GEV No.	210051	Ref. No.	41826330160 BN41826330160
description	pan support W 580mm L 390mm H 70mm SS type series 700		

			
1			
GEV No.	210051	Ref. No.	41826330160 BN41826330160
description	pan support W 580mm L 390mm H 70mm SS type series 700		

air mixers			
			
1			
GEV No.	106805	Ref. No.	CR0508400
description	air mixer		

			
1			
GEV No.	105711	Ref. No.	2510517 BN2510517
description	air mixing tube L 42mm ED ø 20mm brass		

accessories			
pan supports			
			
1			
GEV No.	210212	Ref. No.	41822410110 41822410390 BN41822410390
description	pan support W 272mm L 395mm H 65mm		
For models:	7PCV/G120, SERIE700		

			
1			
GEV No.	106615	Ref. No.	41822120040 BN822120040
description	air mixing tube L 42mm ø 22mm		
For models:	7FT/G800, 7FTT/G405, 7FTT/G410		

bar burners

bar burners



GEV No.	104216	Ref. No.	85149000 LAR63010120
description	bar burner 1-row ø 50mm Wmm Hmm L 485mm		



GEV No.	105687	Ref. No.	4185322006437 4185322010923 BN4185322010923
description	bar burner 2 row L 370mm W 220mm ømm H 50mm chargrill		
For models:	SERIE700		



GEV No.	105683	Ref. No.	41826390140
description	bar burner 2 row L 415mm W 180mm ømm H 55mm bain marie		
For models:	SERIE 600		



GEV No.	105684	Ref. No.	41826390020 41826390023 BN41826390023
description	bar burner 2 row L 437mm W 220mm ømm H 144mm griddle		
For models:	7FT/G800, 7FTT/G405, 7FTT/G410, SERIE 600, SERIE700		



GEV No.	105686	Ref. No.	41826390120 BN41826390120
description	bar burner 2 row L 440mm W 225mm ømm H 50mm bain marie		
For models:	SERIE 600		



GEV No.	104156	Ref. No.	MA1828112
description	bar burner 2 row L 445mm W 200mm ømm H 50mm chargrill stainless steel		



GEV No.	105475	Ref. No.	4185322006438 4185322010924 BN4185322010924
description	bar burner 2 row L 575mm W 225mm ømm H 45mm 11kW chargrill		
For models:	SERIE 900		



GEV No.	105685	Ref. No.	41826390012 BN41826390012 BN826390012
description	bar burner 2 row L 585mm W 220mm ømm H 55mm griddle		
For models:	SERIE 900, SERIE GIANO 110, SERIE GIANO 140		





GEV No.	103155	Ref. No.	2519270 BN2519270
description	bar burner 3 row L 610mm W 280mm ømm H 60mm chargrill		





GEV No.	105696	Ref. No.	41R320830
description	bar burner 4 row L 230mm W 103mm ømm H 61mm oven		
For models:	SERIE700		



			
GEV No.	105694	Ref. No.	41826390071 41826390072 BN41826390072
description	bar burner 6 row L 310mm W 620mm ømm H 50mm tilting bratt pan		
For models:	SERIE700		

			
GEV No.	105695	Ref. No.	41826390061 41826390063 BN826390063
description	bar burner 6 row L 310mm W 620mm ømm H 50mm tilting bratt pan		
For models:	SERIE 900		

			
GEV No.	104240	Ref. No.	MA1031501000
description	bar burner ø 40mm Wmm Hmm L 400mm flange ø 61mm 1-row charrill with bolt M5x12		

			
GEV No.	105680	Ref. No.	41826390050 BN41826390050
description	bar burner ø 50mm Wmm Hmm L 440mm flange width 71mm flange ø 75mm oven		
For models:	SERIE 900, SERIE700		

			
GEV No.	105777 ¹	Ref. No.	3104830 BN3104830
description	bar burner ø 50mm Wmm Hmm L 440mm with bolt M5x25 flange width 57mm flange length 57mm combi-steamer		
For models:	ECVMG 10, ECVMG 6, ECVPG 10, ECVPG 6		

¹for ovens with 6+10 grids

			
GEV No.	105779 ¹	Ref. No.	3104840 BN3104840
description	bar burner ø 50mm Wmm Hmm L 440mm with bolt M5x25 flange width 57mm flange length 57mm gas range		
For models:	ECVMG 21, ECVPG 21		

¹for ovens with 20 grids

			
GEV No.	105697	Ref. No.	41853310053 BN41853310053
description	bar burner ø 50mm Wmm Hmm L 450mm with bolt M5x12 flange width 65mm flange length 71mm kettle		
For models:	SERIE 900		

			
GEV No.	105523	Ref. No.	MACM088100
description	bar burner ø 50mm Wmm Hmm L 475mm flange ø 75mm		

			
GEV No.	105778	Ref. No.	3104850 BN3104850
description	bar burner ø 50mm Wmm Hmm L 600mm flange width 57mm flange length 57mm convection oven		
For models:	ECVMG 20, ECVPG 20		

			
GEV No.	105681	Ref. No.	41826390040
description	bar burner ø 50mm Wmm Hmm L 607mm flange ø 75mm flange width 71mm oven		
For models:	SERIE 900		





			
1			
GEV No.	105436	Ref. No.	BN2510697
description	bar burner ø 50mm Wmm Hmm L 608mm flange width 71mm gas range flange ø 75mm		

			
1			
GEV No.	105690	Ref. No.	4185327090079 BN4185327090079
description	bar burner ø 60mm Wmm Hmm L 258mm flange width 67mm flange length 67mm pasta cooker		
For models:	SERIE700		
accessories for	105690		
	GEV No.	100508	Ref. No. —
	gas injector thread M9x1 WS 10 bore ø 1.45mm		
	GEV No.	100513	Ref. No. —
	gas injector thread M9x1 WS 10 bore ø 2.15mm		

			
1			
GEV No.	105691	Ref. No.	4185327090085 BN4185327090085
description	bar burner ø 60mm Wmm Hmm L 390mm flange width 67mm flange length 67mm pasta cooker		
For models:	SERIE 900		

			
1			
GEV No.	210257	Ref. No.	MA1041301200
description	chargrill grid L 500mm W 330mm		

			
1			
GEV No.	210258	Ref. No.	MA1041301900
description	chargrill grid L 500mm W 370mm		

			
1			
GEV No.	211069	Ref. No.	4185322009860 BN4185322009860
description	chargrill grid L 585mm W 385mm H 30mm		
For models:	SERIE 900		

			
1			
GEV No.	211067	Ref. No.	4185322009848
description	chargrill grid L 620mm W 375mm		
For models:	SERIE 900		

			
1			
GEV No.	211065	Ref. No.	4185322009351 BN4185322009351
description	chargrill grid L 778mm W 465mm H 60mm		
For models:	SERIE700		

			
1			
GEV No.	211062	Ref. No.	4185322005074 BN4185322005074
description	lava rock grid L 388mm W 298mm H 20mm		
For models:	SERIE700		

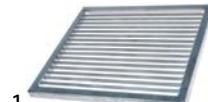
			
1			
GEV No.	211064	Ref. No.	4185322005075 BN4185322005075
description	lava rock grid L 390mm W 340mm H 20mm		
For models:	SERIE700		

			
1			
GEV No.	211029	Ref. No.	MA1829522
description	lava rock grid L 464mm W 310mm		



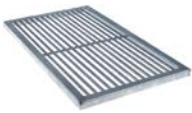

 <p>1</p>			
GEV No.	211066	Ref. No.	4185322007835 BN4185322007835
description	lava rock grid L 535mm W 315mm H 20mm		
For models:	SERIE 900		

 <p>1</p>			
GEV No.	211068	Ref. No.	4185322007864 BN4185322007864
description	lava rock grid L 535mm W 360mm H 20mm		
For models:	SERIE 900		

chargrill grids

 <p>1</p>			
GEV No.	210257	Ref. No.	MA1041301200
description	chargrill grid L 500mm W 330mm		

 <p>1</p>			
GEV No.	210258	Ref. No.	MA1041301900
description	chargrill grid L 500mm W 370mm		

 <p>1</p>			
GEV No.	211069	Ref. No.	4185322009860 BN4185322009860
description	chargrill grid L 585mm W 385mm H 30mm		
For models:	SERIE 900		

 <p>1</p>			
GEV No.	211067	Ref. No.	4185322009848
description	chargrill grid L 620mm W 375mm		
For models:	SERIE 900		

 <p>1</p>			
GEV No.	211065	Ref. No.	4185322009351 BN4185322009351
description	chargrill grid L 778mm W 465mm H 60mm		
For models:	SERIE700		

lava rock grids

 <p>1</p>			
GEV No.	211062	Ref. No.	4185322005074 BN4185322005074
description	lava rock grid L 388mm W 298mm H 20mm		
For models:	SERIE700		

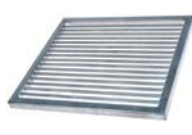
 <p>1</p>			
GEV No.	211064	Ref. No.	4185322005075 BN4185322005075
description	lava rock grid L 390mm W 340mm H 20mm		
For models:	SERIE700		

 <p>1</p>			
GEV No.	211029	Ref. No.	MA1829522
description	lava rock grid L 464mm W 310mm		

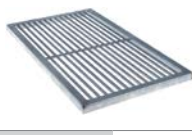
 <p>1</p>			
GEV No.	211066	Ref. No.	4185322007835 BN4185322007835
description	lava rock grid L 535mm W 315mm H 20mm		
For models:	SERIE 900		

 <p>1</p>			
GEV No.	211068	Ref. No.	4185322007864 BN4185322007864
description	lava rock grid L 535mm W 360mm H 20mm		
For models:	SERIE 900		



tube burners



1

GEV No.	105528	Ref. No.	85322001231
description	tubular burner L 295mm W 55mm H 70mm mounting pos. centre/ right for fryer oval		
For models:	SERIE 900, SERIE700		



1

GEV No.	105527	Ref. No.	85322001230
description	tubular burner L 295mm W 55mm H 70mm mounting pos. left for fryer oval		
For models:	SERIE 900, SERIE700		



1

GEV No.	105689	Ref. No.	41826390130 BN41826390130
description	tubular burner ø 74mm L 170mm H 60mm round for fryer/pasta cooker		
For models:	SERIE 600		

solid top burners



1

GEV No.	105251	Ref. No.	0100294 R0100294 S10100294 S1R0100294
description	solid top burner ø 120mm H 102mm L 340mm		

accessories

covers



1

GEV No.	106809	Ref. No.	41821530120
description	cover L 445mm W 170mm H 25mm for burner		
For models:	7PCV/G120		

gaskets



1

GEV No.	512513	Ref. No.	BN825110530
description	gasket burner chamber level glass suitable for LAINOX hole ø 4.5mm hole distance 56mm thickness 1.5mm		



1

GEV No.	512512	Ref. No.	BN825110520
description	gasket ø 37.5mm thickness 1.5mm hole distance 25mm		

nozzle holders



1

GEV No.	102700	Ref. No.	41822160260
description	nozzle holder		



1



GEV No.	105230	Ref. No.	MA1033717200	
description	nozzle holder			
accessories for	105230			
	GEV No.	103140	Ref. No.	CR0795730
	burner head seat ø 75mm for burner cap ø 85mm 3.5kW			
	GEV No.	103141	Ref. No.	—
	burner head ø 95mm suitable for burner 5.5kW			
	GEV No.	103146	Ref. No.	—
	burner lower part for burner cap ø 85mm 3.5kW			
	GEV No.	103147	Ref. No.	MA1032101300
	burner lower part for burner cap ø 95mm 5.5/7kW			

Table continues overleaf



accessories for 105230			
	GEV No.	107143	Ref. No. CM297300 MACM297300
burner head for burner cap ø 95mm 5.5kW			



GEV No.	102753	Ref. No.	41822160022 BN41822160022 BN822160022
----------------	--------	-----------------	---

description nozzle holder brass

For models: SERIE 900, SERIE GIANO 110, SERIE GIANO 140, SERIE700

accessories for 102753

	GEV No.	105289	Ref. No. 0100264 2519002 BN2519002 R0100264 SIR0100264
air mixing sleeve L 50mm ED ø 45mm ID ø 42mm aluminium			

	GEV No.	105668	Ref. No. 41822410071 822410071 BN41822410071 BN822410071
burner cap 3.5kW ø 84mm			

	GEV No.	105669	Ref. No. 41822410041 822410041 BN41822410041 BN822410041
burner head 3.5kW for burner cap ø 84mm			

	GEV No.	105670	Ref. No. 41822410011 41822410012 822410011 822410012 BN41822410012 BN822410012
venturi 3.5kW for burner cap ø 84mm			

	GEV No.	105671	Ref. No. 41822410081 822410081 BN41822410081 BN822410081
burner cap 5.7kW ø 102mm			

	GEV No.	105672	Ref. No. 41822410051 822410051 BN41822410051 BN822410051
burner head 5.7kW for burner cap ø 102mm			

	GEV No.	105673	Ref. No. 41822410021 41822410022 822410021 822410022 BN41822410022 BN822410022
venturi 5.7kW for burner cap ø 102mm			

	GEV No.	105674	Ref. No. 41822410091 822410091 BN41822410091 BN822410091
burner cap 7kW ø 125mm with central hole			

	GEV No.	105675	Ref. No. 41822410061 822410061 BN41822410061 BN822410061
burner head 7kW for burner cap ø 125mm			

accessories for 102753			
	GEV No.	105676	Ref. No. 41822410031 41822410032 822410031 822410032 BN41822410032 BN822410032
venturi 7/10kW for burner cap ø 125mm			

	GEV No.	105803	Ref. No. 41822160030 41822160031 41822160032 822160030 822160031 822160032 BN41822160031 BN822160031
screw connection thread M16x1.5 L 34mm ID ø 9/10.2mm			



GEV No.	106599	Ref. No.	CR0508630
description nozzle holder nozzle M10x1 M14x1 screw pipe fitting M16x1.5 tube ø 10mm			

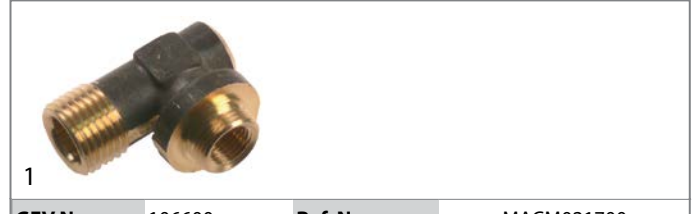



GEV No.	106600	Ref. No.	MACM021700
description nozzle holder nozzle M10x1 M14x1 screw pipe fitting M16x1.5 tube ø 10mm			



GEV No.	105803	Ref. No.	41822160030 41822160031 41822160032 BN41822160031 BN822160031
description screw connection thread M16x1.5 L 34mm ID ø 9/10.2mm			

accessories for 105803

	GEV No.	102753	Ref. No. 41822160022 822160022 BN41822160022 BN822160022
nozzle holder brass			

	GEV No.	105289	Ref. No. 0100264 2519002 BN2519002 R0100264 SIR0100264
air mixing sleeve L 50mm ED ø 45mm ID ø 42mm aluminium			



	GEV No.	105668	Ref. No. 41822410071 822410071 BN41822410071 BN822410071
burner cap 3.5kW ø 84mm			

Table continues overleaf



accessories for		105803	
	GEV No.	105669	Ref. No. 41822410041 822410041 BN41822410041 BN822410041
burner head 3.5kW for burner cap ø 84mm			
	GEV No.	105670	Ref. No. 41822410011 41822410012 822410011 822410012 BN41822410012 BN822410012
venturi 3.5kW for burner cap ø 84mm			
	GEV No.	105671	Ref. No. 41822410081 822410081 BN41822410081 BN822410081
burner cap 5.7kW ø 102mm			
	GEV No.	105672	Ref. No. 41822410051 822410051 BN41822410051 BN822410051
burner head 5.7kW for burner cap ø 102mm			
	GEV No.	105673	Ref. No. 41822410021 41822410022 822410021 822410022 BN41822410022 BN822410022
venturi 5.7kW for burner cap ø 102mm			
	GEV No.	105674	Ref. No. 41822410091 822410091 BN41822410091 BN822410091
burner cap 7kW ø 125mm with central hole			
	GEV No.	105675	Ref. No. 41822410061 822410061 BN41822410061 BN822410061
burner head 7kW for burner cap ø 125mm			
	GEV No.	105676	Ref. No. 41822410031 41822410032 822410031 822410032 BN41822410032 BN822410032
venturi 7/10kW for burner cap ø 125mm			

miscellaneous

	1		
GEV No.	109078	Ref. No.	MA1033600
description	level glass for burner		

gas nozzles

main nozzles

gas nozzles M10x1



GEV No.	100155	Ref. No.	MA2902500
---------	--------	----------	-----------

description gas injector thread M10x1 bore ø 1.45mm L 30mm WS 12



GEV No.	106403	Ref. No.	MA707200
---------	--------	----------	----------

description gas injector thread M10x1 bore ø 1.9mm L 30mm WS 12



GEV No.	106465	Ref. No.	41822140270 BN822140270
---------	--------	----------	----------------------------

description gas injector thread M10x1 WS 12 bore ø 0.8mm



GEV No.	106451	Ref. No.	BN4182214
---------	--------	----------	-----------

description gas injector thread M10x1 WS 12 bore ø 0.9mm



GEV No.	106473	Ref. No.	41822140150 BN822140150
---------	--------	----------	----------------------------

description gas injector thread M10x1 WS 12 bore ø 1.05mm

For models: 7PCV/G120





GEV No.	106466	Ref. No.	41822140280 BN822140280
---------	--------	----------	----------------------------

description gas injector thread M10x1 WS 12 bore ø 1.15mm





			
1			
GEV No.	106609	Ref. No.	41822140010 BN41822140010
description	gas injector thread M10x1 WS 12 bore ø 1.1mm		
For models:	7FT/G800, 7FTT/G405, 7FTT/G410		

			
1			
GEV No.	106454	Ref. No.	41822140210 BN41822140210 BN822140210
description	gas injector thread M10x1 WS 12 bore ø 1.8mm		

			
1			
GEV No.	106611	Ref. No.	41822140020 BN41822140020
description	gas injector thread M10x1 WS 12 bore ø 1.25mm		
For models:	7FT/G800, 7FTT/G405, 7FTT/G410		

			
1			
GEV No.	106614	Ref. No.	41822140050 BN41822140050
description	gas injector thread M10x1 WS 12 bore ø 1.9mm		
For models:	7FT/G800, 7FTT/G405, 7FTT/G410		

			
1			
GEV No.	106610	Ref. No.	41822140160 BN822140160
description	gas injector thread M10x1 WS 12 bore ø 1.2mm		

			
1			
GEV No.	106458	Ref. No.	41822140060 BN41822140060
description	gas injector thread M10x1 WS 12 bore ø 2.1mm		
For models:	7FT/G800, 7FTT/G405, 7FTT/G410		

			
1			
GEV No.	106328	Ref. No.	BN822140030
description	gas injector thread M10x1 WS 12 bore ø 1.3mm		

			
1			
GEV No.	106474	Ref. No.	41822140220 BN822140220
description	gas injector thread M10x1 WS 12 bore ø 2mm		

			
1			
GEV No.	106612	Ref. No.	41822140040 BN822140040
description	gas injector thread M10x1 WS 12 bore ø 1.45mm		

			
1			
GEV No.	100536	Ref. No.	822140140 BN822140140
description	gas injector thread M10x1 WS 12 bore ø 0.95mm		
For models:	7PCV/G120		

			
1			
GEV No.	106613	Ref. No.	41822140190 BN822140190
description	gas injector thread M10x1 WS 12 bore ø 1.55mm		

 <p>1</p>			
GEV No.	100472	Ref. No.	0100931 MA522111 R0100931 SIR0100931
description	gas injector thread M10x1 WS 12 bore ø 1.4mm		

 <p>1</p>			
GEV No.	103234	Ref. No.	MA1630800
description	nozzle thread M10x1 WS 12 bore ø 1.5mm		

pilot burner nozzles

pilot burner nozzle AB

 <p>1</p>			
GEV No.	100203	Ref. No.	822140370
description	pilot burner nozzle LPG code 25 Qty 1 pcs nozzle ø 0.25mm		

pilot burner nozzles POLIDORO

 <p>1</p>			
GEV No.	106704	Ref. No.	BN6A013240
description	pilot burner nozzle POLIDORO LPG code 16.2 bore ø 2x0.16mm Qty 1 pcs		

 <p>1</p>			
GEV No.	106703	Ref. No.	BN6A013230
description	pilot burner nozzle POLIDORO natural gas code 27.2 bore ø 2x0.27mm Qty 1 pcs		

pilot burner nozzles SIT

140/150 series

 <p>1</p>			
GEV No.	100204	Ref. No.	MA1888000
description	pilot burner nozzle SIT LPG code 14 bore ø 0.18/0.20mm Qty 1 pcs suitable for 140 series		

 <p>1</p>			
GEV No.	100205	Ref. No.	41822140380 BN822140380
description	pilot burner nozzle SIT LPG code 19 bore ø 0.23/0.26mm Qty 1 pcs suitable for SIT 150 series		
For models:	7FT/G800, 7FTT/G405, 7FTT/G410, 7PCV/G120		

 <p>1</p>			
GEV No.	100207	Ref. No.	41822140120 6A013107 MA1887800
description	pilot burner nozzle SIT natural gas code 27 bore ø 0.40/0.38mm suitable for SIT 140 series		
For models:	7FT/G800, 7FTT/G405, 7FTT/G410, 7PCV/G120, SERIE 900, SERIE GIANO 110, SERIE GIANO 140, SERIE700		

160 series

 <p>1</p>			
GEV No.	107649	Ref. No.	41822140440 BN41822140440 MA1033719600
description	pilot burner nozzle SIT LPG code 20 Qty 1 pcs		

 <p>1</p>			
GEV No.	107172	Ref. No.	MA1874700
description	pilot burner nozzle SIT LPG code 25 Qty 1 pcs		

 <p>1</p>			
GEV No.	107650	Ref. No.	822140360 BN822140360 CR0410100
description	pilot burner nozzle SIT LPG code 30 Qty 1 pcs		

 <p>1</p>			
GEV No.	107174	Ref. No.	1033719700 MA1033719700
description	pilot burner nozzle SIT natural gas code 41 Qty 1 pcs		



bypass nozzles

bypass nozzles PEL20/21



GEV No.	100554	Ref. No.	41822450200 BN6A023722
description	bypass nozzle type PEL20/21 bore ø 0.45mm thread M5x0.5		



GEV No.	100526	Ref. No.	41822450210 BN41822450210 BN822450210
description	bypass nozzle type PEL20/21 bore ø 0.5mm thread M5x0.5		



GEV No.	100548	Ref. No.	BN6A023723
description	bypass nozzle type PEL20/21 bore ø 0.65mm thread M5x0.5		



GEV No.	100278	Ref. No.	41822450230 BN41822450230 BN822450230
description	bypass nozzle type PEL20/21 bore ø 0.75mm thread M5x0.5		



GEV No.	100555	Ref. No.	41822450240 BN822450240
description	bypass nozzle type PEL20/21 bore ø 0.8mm thread M5x0.5		



GEV No.	100528	Ref. No.	41822450260 BN822450260 MA1889000
description	bypass nozzle type PEL20/21 bore ø 0.9mm thread M5x0.5		
For models:	7FT/G800, 7FTT/G405, 7FTT/G410, 7PCV/G120		



GEV No.	100531	Ref. No.	BN6A023724
description	bypass nozzle type PEL20/21 bore ø 1.15mm thread M5x0.5		



GEV No.	100394	Ref. No.	41822450690 BN822450690
description	bypass nozzle type PEL20/21 bore ø 1.25mm thread M5x0.5		
For models:	7FT/G800, 7FTT/G405, 7FTT/G410		



GEV No.	100532	Ref. No.	41822450280 BN822450280 SIR0102065
description	bypass nozzle type PEL20/21 bore ø 1.2mm thread M5x0.5		
For models:	7PCV/G120		



GEV No.	100549	Ref. No.	41822450300 BN822450300
description	bypass nozzle type PEL20/21 bore ø 1.35mm thread M5x0.5		



GEV No.	100533	Ref. No.	41822450290 BN822450290
description	bypass nozzle type PEL20/21 bore ø 1.3mm thread M5x0.5		
For models:	7PCV/G120		



GEV No.	100534	Ref. No.	BN6A023725 MA1883400
description	bypass nozzle type PEL20/21 bore ø 1.4mm thread M5x0.5		



GEV No.	106608	Ref. No.	41822450310 BN822450310
description	bypass nozzle type PEL20/21 bore ø 1.6mm thread M5x0.5		
For models:	7FT/G800, 7FTT/G405, 7FTT/G410		



GEV No.	100529	Ref. No.	MA1889100
description	bypass nozzle type PEL20/21 bore ø 1mm thread M5x0.5		



GEV No.	106871	Ref. No.	CR0586570
description	bypass nozzle type PEL20/21 bore ø 2.2mm thread M5x0.5		



bypass nozzles PEL22



GEV No.	106870	Ref. No.	BN2510472 CR0683130
description	bypass nozzle type PEL22 bore ø 1.35mm thread M6x0.5		



			
1			
GEV No.	106499	Ref. No.	41822450550
description	bypass nozzle type PEL22 bore ø 1.3mm thread M6x0.5		



			
1			
GEV No.	101248	Ref. No.	MA673300
description	olive for pipe ø 12mm Qty 1 pcs suitable for PEL		
accessories for	101248		
	GEV No.	101251	Ref. No. MA673100
	union nut thread M20x1.5 for pipe ø 12mm		

auxiliary gas parts





screw connections

double nipples



			
1			
GEV No.	106617	Ref. No.	41822450170 BN822450170
description	screw connection T1: 3/8" T2: M16x1.5 tube ø 10mm		



			
1			
GEV No.	101256	Ref. No.	MA1127400
description	olive for pipe ø 16mm Qty 1 pcs		
accessories for	101256		
	GEV No.	101253	Ref. No. MA1421000
	union nut thread M24x1.5 PEL for pipe ø 16mm		

olives

			
1			
GEV No.	101278	Ref. No.	41822450100 6A011480 MA86720
description	olive for pipe ø 10mm Qty 1 pcs		
For models:	7FT/G800, 7FTT/G405, 7FTT/G410, 7PCV/G120		
accessories for	101278		
	GEV No.	100943	Ref. No. —
	union nut thread M17x1 tube ø 10mm		
	GEV No.	101300	Ref. No. 41822450090 822450090 MA1326500
	union nut thread M16x1.5 tube ø 10mm		
	GEV No.	101478	Ref. No. MA1665200
	union nut thread 3/8" for pipe ø 10mm		

			
1			
GEV No.	106598	Ref. No.	MA866200
description	olive for pipe ø 18mm Qty 1 pcs ED ø 21mm		

			
1			
GEV No.	101273	Ref. No.	0100842 MA417810 R0100842 SIR0100842
description	olive for pipe ø 12mm L 9.5mm brass Qty 1 pcs suitable for universal		
accessories for	101273		
	GEV No.	100944	Ref. No. —
	union nut thread M18x1.5 for pipe ø 12mm		
	GEV No.	101276	Ref. No. MA459300
	union screw thread 3/8" tube ø 12mm Qty 1 pcs		



			
1			
GEV No.	101282	Ref. No.	MA469000
description	olive for pipe ø 4mm L 7.4mm Qty 1 pcs		
accessories for	101282		
	GEV No.	100908	Ref. No. 0100777 41822450040 41822450110 6A016110 822450040 822450110 BN6A017000 BN822450040 MA673500 R0100777 SIR0100777
	union screw thread M10x1 for pipe ø 4mm Qty 1 pcs		
	GEV No.	101283	Ref. No. —
	union screw thread M10x1 for pipe ø 4mm Qty 1 pcs		

			
1			
GEV No.	106637	Ref. No.	BN6A016900
description	olive for pipe ø 4mm L 7mm Qty 1 pcs		





 <p>1</p>							
GEV No.	101246	Ref. No.	41822450120 6A016120 MA673600				
description	olive for pipe ø 4mm Qty 1 pcs						
For models:	7FT/G800, 7FTT/G405, 7FTT/G410						
accessories for	101246						
 <table border="1"> <tr> <td>GEV No.</td> <td>100908</td> <td>Ref. No.</td> <td>0100777 41822450040 41822450110 6A016110 822450040 822450110 BN6A017000 BN822450040 MA673500 R0100777 SIR0100777</td> </tr> </table> <p>union screw thread M10x1 for pipe ø 4mm Qty 1 pcs</p>				GEV No.	100908	Ref. No.	0100777 41822450040 41822450110 6A016110 822450040 822450110 BN6A017000 BN822450040 MA673500 R0100777 SIR0100777
GEV No.	100908	Ref. No.	0100777 41822450040 41822450110 6A016110 822450040 822450110 BN6A017000 BN822450040 MA673500 R0100777 SIR0100777				

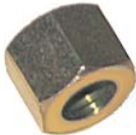

 <p>1</p>			
GEV No.	100897	Ref. No.	41822450050 BN822450050 MA1888100
description	olive for pipe ø 4mm Qty 1 pcs for pilot burner		
For models:	7FT/G800, 7FTT/G405, 7FTT/G410, 7PCV/G120		



 <p>1</p>							
GEV No.	100898	Ref. No.	41822450470 BN41822450470				
description	olive for pipe ø 6mm Qty 1 pcs for pilot burner						
accessories for	100898						
 <table border="1"> <tr> <td>GEV No.</td> <td>100909</td> <td>Ref. No.</td> <td>822450450</td> </tr> </table> <p>union screw thread M10x1 for pipe ø 6mm Qty 1 pcs</p>				GEV No.	100909	Ref. No.	822450450
GEV No.	100909	Ref. No.	822450450				

<p>union nuts</p>  <p>1</p>			
GEV No.	101478	Ref. No.	MA1665200
description	union nut thread 3/8" for pipe ø 10mm		

 <p>1</p>			
GEV No.	101476	Ref. No.	MA1665300
description	union nut thread M13x1 for pipe ø 8mm		

 <p>1</p>							
GEV No.	101300	Ref. No.	41822450090 MA1326500				
description	union nut thread M16x1.5 tube ø 10mm						
accessories for	101300						
 <table border="1"> <tr> <td>GEV No.</td> <td>101278</td> <td>Ref. No.</td> <td>41822450100 6A011480 822450100 MA86720</td> </tr> </table> <p>olive for pipe ø 10mm Qty 1 pcs</p>				GEV No.	101278	Ref. No.	41822450100 6A011480 822450100 MA86720
GEV No.	101278	Ref. No.	41822450100 6A011480 822450100 MA86720				

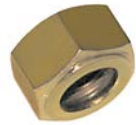
 <p>1</p>							
GEV No.	101251	Ref. No.	MA673100				
description	union nut thread M20x1.5 for pipe ø 12mm						
accessories for	101251						
 <table border="1"> <tr> <td>GEV No.</td> <td>101248</td> <td>Ref. No.</td> <td>MA673300</td> </tr> </table> <p>olive for pipe ø 12mm Qty 1 pcs suitable for PEL</p>				GEV No.	101248	Ref. No.	MA673300
GEV No.	101248	Ref. No.	MA673300				

 <p>1</p>							
GEV No.	101253	Ref. No.	MA1421000				
description	union nut thread M24x1.5 PEL for pipe ø 16mm						
accessories for	101253						
 <table border="1"> <tr> <td>GEV No.</td> <td>101256</td> <td>Ref. No.</td> <td>MA1127400</td> </tr> </table> <p>olive for pipe ø 16mm Qty 1 pcs</p>				GEV No.	101256	Ref. No.	MA1127400
GEV No.	101256	Ref. No.	MA1127400				

union screws

			
1			
GEV No.	100904	Ref. No.	6A011608 BN6A011608 MA1394700
description	locking screw M10x1 for pipe ø 4mm Qty 1 pcs		
For models:	7FRI/G815, 7FT/G800, 7FTT/G405, 7FTT/G410		





			
2			
GEV No.	100905	Ref. No.	6A011607 BN6A011607
description	locking screw M10x1 for pipe ø 6mm Qty 1 pcs		





			
1			
GEV No.	100906	Ref. No.	6A011707 MA1888400
description	screw connection thread M10x1 for ignition electrode brass Qty 1 pcs WS 10		
For models:	7FT/G800, 7FTT/G405, 7FTT/G410		

			
1			
GEV No.	100907	Ref. No.	MA1891700
description	screw connection thread M10x1 Qty 1 pcs type SEF 1 ømm for thermocouple		

			
1			
GEV No.	106597	Ref. No.	MA866000
description	union screw thread 3/4" for pipe ø 18mm L 20mm Qty 1 pcs WS 27		

			
1			
GEV No.	100908	Ref. No.	0100777 41822450040 41822450110 6A016110 BN6A017000 BN822450040 MA673500 R0100777 SIR0100777
description	union screw thread M10x1 for pipe ø 4mm Qty 1 pcs		
For models:	7FT/G800, 7FTT/G405, 7FTT/G410, 7PCV/G120		
accessories for	100908		

	GEV No.	100897	Ref. No.	41822450050 822450050 BN822450050 MA1888100
olive for pipe ø 4mm Qty 1 pcs for pilot burner				
	GEV No.	101246	Ref. No.	41822450120 6A016120 822450120 MA673600
olive for pipe ø 4mm Qty 1 pcs				
	GEV No.	101280	Ref. No.	—
olive for pipe ø 4mm Qty 1 pcs				
	GEV No.	101282	Ref. No.	MA469000
olive for pipe ø 4mm L 7.4mm Qty 1 pcs				

				
1				
GEV No.	100909	Ref. No.	822450450	
description	union screw thread M10x1 for pipe ø 6mm Qty 1 pcs			
accessories for	100909			
	GEV No.	100898	Ref. No.	41822450470 822450470 BN41822450470
olive for pipe ø 6mm Qty 1 pcs for pilot burner				
	GEV No.	101286	Ref. No.	—
olive ID ø 6mm Qty 1 pcs				
	GEV No.	101287	Ref. No.	—
olive for pipe ø 6mm Qty 1 pcs				
	GEV No.	101288	Ref. No.	—
olive for pipe ø 6mm L 6mm aluminium Qty 1 pcs ED ø 8.5mm				



			
1			
GEV No.	103237	Ref. No.	MA459500
description	union screw thread M14x1.5 for pipe ø 10mm Qty 1 pcs		



angle pieces			
			
1			
GEV No.	106618	Ref. No.	41822450010 BN822450010
description	elbow screw joint		
For models:	7FT/G800, 7FTT/G405, 7FTT/G410		

			
1			
GEV No.	106616	Ref. No.	41822450610 BN41822450610 BN822450610
description	elbow screw joint T1: M10x1 tube ø 6mm		

gas lines

main gas lines

producer-specific

			
1			
GEV No.	107546	Ref. No.	41823561360 BN41823561360
description	gas line tube ø 10mm L 430mm aluminium		
For models:	7PCV/G120		
accessories for	107546		
	GEV No.	101278	Ref. No.
			41822450100 6A011480 822450100 MA86720
	olive for pipe ø 10mm Qty 1 pcs		
	GEV No.	101300	Ref. No.
			41822450090 822450090 MA1326500
	union nut thread M16x1.5 tube ø 10mm		

equipment-specific units

for vegetable slicers

miscellaneous

			
1			
GEV No.	110703	Ref. No.	MA1829200
description	cylindrical handle thread M10 ø 28mm L 87mm		

for cheese graters

miscellaneous

			
1			
GEV No.	110703	Ref. No.	MA1829200
description	cylindrical handle thread M10 ø 28mm L 87mm		

for ice-cube maker

hoses

formed hoses

straight

silicone hoses

			
1			
GEV No.	530063	Ref. No.	MA1036100700
description	silicone hose ID ø 18mm ED ø 25mm L 1m t.max. 200°C transparent		

for espresso machines

level glasses

level glasses

level glass pipes

			
1			
GEV No.	693327	Ref. No.	41853310179 BN41853310179
description	water level tube ø 10mm H 100mm		
For models:	SERIE 900, SERIE700		

pipes

union nuts

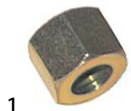

1

GEV No.	101478	Ref. No.	MA1665200
description	union nut thread 3/8" for pipe ø 10mm		

for pyroceram ranges

ceramic hobs

ceramic glass plates



1

GEV No.	691407	Ref. No.	6A001400 BN6A001400
description	ceramic plate L 550mm W 320mm thickness 6mm		

for deep fryers

spare parts and accessories



1

GEV No.	550768	Ref. No.	41822110101 BN41822110101
description	bush L 17mm ID ø 6mm thread M12x1		

for griddles

housing and bezels



1

GEV No.	691349	Ref. No.	MA1044314900
description	spraying protection L 520mm W 390mm H 75mm		



1

GEV No.	691350	Ref. No.	MA1044315000
description	spraying protection L 520mm W 590mm H 75mm		



1

GEV No.	691351	Ref. No.	MA1044320700
description	spraying protection L 520mm W 790mm H 75mm		



sumps



1	GEV No.	691386	Ref. No.	41826161370 BN41826161370
description grease collecting tray L 110mm W 170mm H 85mm				

drain stoppers



1	GEV No.	691331	Ref. No.	MA97313000
description outflow plug for grease drain flange 30x70mm H 100mm				

for convection ovens/combi-steamers

miscellaneous



1	GEV No.	693325	Ref. No.	41853310100
description frame for level glass				

for tilting bratt pans

spindles



1	GEV No.	693320	Ref. No.	41822160171 BN41822160171 BN822160171
description threaded rod				
For models: SERIE 900, SERIE700				

miscellaneous



1	GEV No.	694535	Ref. No.	822160140 BN822160140
description spindle L 460mm ø 10mm for tilting bratt pan				



1	GEV No.	693321	Ref. No.	41822160160 41822160162 BN41822160162 BN822160162
description threaded bush				
For models: SERIE 900, SERIE700				

for boiling pans

glass panels



1	GEV No.	693324	Ref. No.	41853310043
description glass panel L 29mm W 29mm thickness 3.5mm square				

for dishwashers

hood mechanics for dishwashers

guide bars



1	GEV No.	517378	Ref. No.	41RDW11600029 BN41RDW11600029
description guide bar L 650mm mounting pos. left for hood mechanics thickness 25mm				



1	GEV No.	513019	Ref. No.	41RWD11600028
description guide bar L 695mm mounting pos. right thickness 25mm				

knobs

producer-specific knobs

BARON

ø55mm

1 

GEV No.	111696	Ref. No.	41824710260 BN41824710260 BN824710260
description	knob energy regulator 1-8 + MAX t.max. °C °C ø 55mm shaft ø 6x4.6mm shaft flat upper black		
For models:	SERIE 900, SERIE700		

1 

GEV No.	111694	Ref. No.	41824710110 BN41824710110 BN824710110
description	knob gas thermostat Eurosit t.max. 320°C 80-320°C ø 55mm shaft ø 8x6.5mm shaft flat upper black		
For models:	SERIE 900, SERIE GIANO 110, SERIE700		



1 

Image not available

GEV No.	112481	Ref. No.	824710710 BN824710710
description	knob switch 0-1-2-3 ø 55mm shaft ø 6x4.6mm shaft flat upper black		

1 

GEV No.	111695	Ref. No.	41824710270 BN41824710270 BN824710270
description	knob thermostat t.max. 300°C 50-300°C ø 55mm shaft ø 6x4.6mm shaft flat upper black rotation 240°		
For models:	SERIE 900, SERIE700		

ø70mm

1 

GEV No.	111693	Ref. No.	41824710410 BN41824710410 BN824710410
description	knob energy regulator 1-10 t.max. °C °C ø 70mm shaft ø 6x4.6mm shaft flat upper black		
For models:	SERIE 600, SERIE 900, SERIE700		

1 

GEV No.	111692	Ref. No.	41824710290 BN41824710290 BN824710290
description	knob energy regulator t.max. °C °C ø 70mm shaft ø 6x4.6mm shaft flat upper black		
For models:	7NP/EI50, SERIE 600, SERIE 900, SERIE700		

1 

GEV No.	112464	Ref. No.	41824710750 BN41824710750
description	knob gas tap PEL21/22/23 ø 70mm shaft ø 10x8mm shaft flat lower black		



1 

GEV No.	111700	Ref. No.	41824710130 BN41824710130 BN824710130
description	knob gas tap PEL21/22/23 t.max. °C °C ø 70mm shaft ø 10x8mm shaft flat lower black		
For models:	SERIE 900, SERIE700		





 <p>1</p>			
GEV No.	111689	Ref. No.	41824710100 BN41824710100 BN824710100
description	knob gas tap PEL21/22/23 t.max.°C ø 70mm shaft ø 8x6.5mm shaft flat upper black		
For models:	7FT/G800, 7FTT/G405, 7FTT/G410, 7PCV/G120, SERIE 600, SERIE 900, SERIE GIANO 110, SERIE GIANO 140, SERIE700		

 <p>1</p>			
GEV No.	111698	Ref. No.	41824710070 BN41824710070 BN824710070
description	knob gas thermostat Eurosit t.max. 300°C 100-300°C ø 70mm shaft ø 8x6.5mm shaft flat upper black		
For models:	SERIE 900, SERIE GIANO 110, SERIE GIANO 140, SERIE700		

 <p>1</p>			
GEV No.	111690	Ref. No.	41824710120 BN41824710120
description	knob gas tap PEL22/23 t.max.°C ø 70mm shaft ø 10x8mm shaft flat upper black		
accessories for	111690		
	GEV No.	111708	Ref. No.
marker red			41824710080 824710080 BN41824710080 BN824710080

 <p>1</p>			
GEV No.	111705	Ref. No.	41824710490 BN41824710490 BN824710490
description	knob gas thermostat PEL Min-Max t.max.°C ø 70mm shaft ø 8x6.5mm shaft flat upper black		
For models:	SERIE 600		

 <p>1</p>			
GEV No.	112862	Ref. No.	824710120 BN824710120
description	knob gas tap PEL22/23 t.max.°C ø 70mm shaft ø 10x8mm shaft flat upper chrome-plated		

 <p>1</p>			
GEV No.	111697	Ref. No.	41824710470 BN41824710470 BN824710470
description	knob gas thermostat PEL t.max. 300°C 150-300°C ø 70mm shaft ø 8x6.5mm shaft flat upper black		
For models:	SERIE 600		

 <p>1</p>			
GEV No.	112465	Ref. No.	824710690 824710700 BN824710690 BN824710700
description	knob gas thermostat Eurosit t.max. 190°C 110-190°C ø 70mm shaft ø 8x6.5mm shaft flat upper black		
For models:	7FRI/G815		

 <p>1</p>			
GEV No.	112466	Ref. No.	41824710230 BN41824710230 BN824710230
description	knob switch 0-1-0-1 t.max.°C ø 70mm shaft ø 6x4.6mm shaft flat horizontal black		
For models:	7BRF/E805		

			
1			
GEV No.	111701	Ref. No.	41824710480 BN41824710480 BN824710480
description	knob switch 4-position t.max. °C°C ø 70mm shaft ø 6x4.6mm shaft flat upper black		

			
1			
GEV No.	111691	Ref. No.	41824710320 BN41824710320 BN824710320
description	knob switch 7-position t.max. °C°C ø 70mm shaft ø 6x4.6mm shaft flat upper black		
For models:	SERIE 600, SERIE 900, SERIE700		

			
1			
GEV No.	111702	Ref. No.	41824710240 BN824710240
description	knob thermostat t.max. 100°C 40-100°C ø 70mm shaft ø 6x4.6mm shaft flat upper black		
For models:	7BM/E410, 7BMV/E800, SERIE 600, SERIE 900, SERIE GIANO 110, SERIE700		

			
1			
GEV No.	112463	Ref. No.	824710680 BN824710680
description	knob thermostat t.max. 190°C 120-190°C ø 70mm shaft ø 6x4.6mm shaft flat upper black rotation 270°		
For models:	7FRI/E610		

			
1			
GEV No.	111706	Ref. No.	41824710580 BN41824710580 BN824710580
description	knob thermostat t.max. 200°C 100-200°C ø 70mm shaft ø 6x4.6mm shaft flat upper black rotation 270°		
For models:	SERIE 600		

			
1			
GEV No.	111707	Ref. No.	41824710220 BN41824710220 BN824710220
description	knob thermostat t.max. 200°C 140-200°C ø 70mm shaft ø 6x4.6mm shaft flat upper black		
For models:	SERIE 900, SERIE700		

			
1			
GEV No.	111699	Ref. No.	41824710250 BN41824710250 BN824710250
description	knob thermostat t.max. 300°C 50-300°C ø 70mm shaft ø 6x4.6mm shaft flat upper black		
For models:	7BRF/E805, SERIE 600, SERIE 900, SERIE700		

			
1			
GEV No.	111703	Ref. No.	41824710500 BN41824710500 BN824710500
description	knob water t.max. °C°C ø 70mm shaft ø 10x8mm shaft flat upper black		
For models:	SERIE 600		



			
1			
GEV No.	111708	Ref. No.	41824710080 BN41824710080 BN824710080
description	marker red		
For models:	SERIE 900, SERIE GIANO 110, SERIE GIANO 140, SERIE700		

bracket handles

			
1			
GEV No.	691327	Ref. No.	MACM073100
description	pull handle L 119mm H 37mm mounting distance 105mm handle M6		

accessories

gaskets

			
1			
GEV No.	693918	Ref. No.	825110510 BN825110510
description	gasket for knob rubber D1 ø 19mm D2 ø 4mm thickness 1mm		
For models:	7BRF/E805		

			
1			
GEV No.	693796	Ref. No.	825110500 BN825110500
description	gasket for knob rubber D1 ø 38mm D2 ø 4mm thickness 1mm		

handles and hand wheels

cylindrical handles

fixed

			
1			
GEV No.	110703	Ref. No.	MA1829200
description	cylindrical handle thread M10 ø 28mm L 87mm		

cone handles

			
1			
GEV No.	691395	Ref. No.	41824710510 BN41824710510 BN824710510
description	cone handle thread M8 ø 24mm L 59mm black		

levers

without handle

			
1			
GEV No.	514013	Ref. No.	MA1031400400
description	lever equiv. no. 1031400400		

lever handles

			
1			
GEV No.	514015	Ref. No.	MA1036702000
description	lever handle plastic black		

hand cranks

			
1			
GEV No.	693323	Ref. No.	41826900620 BN41826900620 BN826900620
description	hand crank bore ø 10mm L 130mm with folding handle		
accessories for	693323		
			
GEV No.	691397	Ref. No.	418227994250 8227994250 BN8227994250
roll pin ø 4mm L 26mm			

locks

espagnolette locks

producer-specific

BARON



1			
GEV No.	514302	Ref. No.	0A011409 BN6A011409
description	ball ø 8mm		
For models:	ECVME 10, ECVME 20, ECVME 21, ECVME 6, ECVMG 10, ECVMG 20, ECVMG 21, ECVMG 6, ECVPE 10, ECVPE 20, ECVPE 21, ECVPE 6, ECVPG 10, ECVPG 20, ECVPG 21, ECVPG 6		



1			
GEV No.	514300	Ref. No.	3107935 BN3107935
description	bush		
For models:	ECVME 10, ECVME 20, ECVME 21, ECVME 6, ECVMG 10, ECVMG 20, ECVMG 21, ECVMG 6, ECVPE 10, ECVPE 20, ECVPE 21, ECVPE 6, ECVPG 10, ECVPG 20, ECVPG 21, ECVPG 6		



1			
GEV No.	514297	Ref. No.	3107915 BN3107915
description	catch hook L 78.6mm D1 ø 28mm D2 ø 32mm D3 ø 40mm		
For models:	ECVME 10, ECVME 20, ECVME 21, ECVME 6, ECVMG 10, ECVMG 20, ECVMG 21, ECVMG 6, ECVPE 10, ECVPE 20, ECVPE 21, ECVPE 6, ECVPG 10, ECVPG 20, ECVPG 21, ECVPG 6		



1			
GEV No.	514416	Ref. No.	3107991 BN3107991
description	catch hook L 92.5mm D1 ø 28mm D2 ø 32mm D3 ø 40mm		



1			
GEV No.	514301	Ref. No.	3107955 BN3107955
description	compression spring ø 6.5mm L 14mm wire gauge ø 1.2mm		
For models:	ECVME 10, ECVME 20, ECVME 21, ECVME 6, ECVMG 10, ECVMG 20, ECVMG 21, ECVMG 6, ECVPE 10, ECVPE 20, ECVPE 21, ECVPE 6, ECVPG 10, ECVPG 20, ECVPG 21, ECVPG 6		











1			
GEV No.	514296	Ref. No.	3107910 BN3107910
description	door catch H 28mm D1 ø 44mm D2 ø 35mm D3 ø 32mm mounting distance 10mm		
For models:	ECVME 10, ECVME 20, ECVME 21, ECVME 6, ECVMG 10, ECVMG 20, ECVMG 21, ECVMG 6, ECVPE 10, ECVPE 20, ECVPE 21, ECVPE 6, ECVPG 10, ECVPG 20, ECVPG 21, ECVPG 6		





1				
GEV No.	514295	Ref. No.	3107990 BN3107990	
description	door handle complete			
spare parts for	514295			
	GEV No.	514298	Ref. No.	3107945 BN3107945
	plate			
	GEV No.	514299	Ref. No.	3107941 BN3107941
	ring			
	GEV No.	514300	Ref. No.	3107935 BN3107935
	bush			
	GEV No.	514301	Ref. No.	3107955 BN3107955
	compression spring ø 6.5mm L 14mm wire gauge ø 1.2mm			
	GEV No.	514302	Ref. No.	0A011409 BN6A011409
	ball ø 8mm			
	GEV No.	514303	Ref. No.	3107930 BN3107930
	pin ø 8mm L 19.5mm			
	GEV No.	514416	Ref. No.	3107991 BN3107991
	catch hook L 92.5mm D1 ø 28mm D2 ø 32mm D3 ø 40mm			
accessories for	514295			
	GEV No.	514296	Ref. No.	3107910 BN3107910
	door catch H 28mm D1 ø 44mm D2 ø 35mm D3 ø 32mm mounting distance 10mm			

mechanical components, equipment accessories



 <p>1</p>			
GEV No.	514394	Ref. No.	3107900 BN3107900
description	door handle complete		
spare parts for	514394		
 <p>GEV No. 514297 Ref. No. 3107915 BN3107915</p> <p>catch hook L 78.6mm D1 ø 28mm D2 ø 32mm D3 ø 40mm</p>			
 <p>GEV No. 514298 Ref. No. 3107945 BN3107945</p> <p>plate</p>			
 <p>GEV No. 514299 Ref. No. 3107941 BN3107941</p> <p>ring</p>			
 <p>GEV No. 514300 Ref. No. 3107935 BN3107935</p> <p>bush</p>			
 <p>GEV No. 514301 Ref. No. 3107955 BN3107955</p> <p>compression spring ø 6.5mm L 14mm wire gauge ø 1.2mm</p>			
 <p>GEV No. 514302 Ref. No. 0A011409 BN6A011409</p> <p>ball ø 8mm</p>			
 <p>GEV No. 514303 Ref. No. 3107930 BN3107930</p> <p>pin ø 8mm L 19.5mm</p>			
accessories for	514394		
 <p>GEV No. 514296 Ref. No. 3107910 BN3107910</p> <p>door catch H 28mm D1 ø 44mm D2 ø 35mm D3 ø 32mm mounting distance 10mm</p>			

 <p>1</p>			
GEV No.	514303	Ref. No.	3107930 BN3107930
description	pin ø 8mm L 19.5mm		
For models:	ECVME 10, ECVME 20, ECVME 21, ECVME 6, ECVMG 10, ECVMG 20, ECVMG 21, ECVMG 6, ECVPE 10, ECVPE 20, ECVPE 21, ECVPE 6, ECVPG 10, ECVPG 20, ECVPG 21, ECVPG 6		



 <p>1</p>			
GEV No.	514298	Ref. No.	3107945 BN3107945
description	plate		
For models:	ECVME 10, ECVME 20, ECVME 21, ECVME 6, ECVMG 10, ECVMG 20, ECVMG 21, ECVMG 6, ECVPE 10, ECVPE 20, ECVPE 21, ECVPE 6, ECVPG 10, ECVPG 20, ECVPG 21, ECVPG 6		



 <p>1</p>			
GEV No.	514299	Ref. No.	3107941 BN3107941
description	ring		
For models:	ECVME 10, ECVME 20, ECVME 21, ECVME 6, ECVMG 10, ECVMG 20, ECVMG 21, ECVMG 6, ECVPE 10, ECVPE 20, ECVPE 21, ECVPE 6, ECVPG 10, ECVPG 20, ECVPG 21, ECVPG 6		

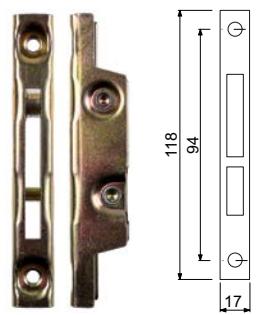

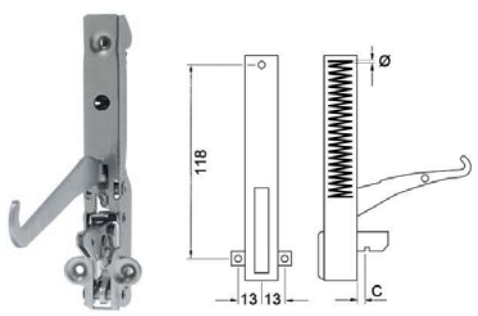
hinges

oven hinges

 <p>1</p> <p>118 94 17</p>			
GEV No.	700001	Ref. No.	41826410050 6A035930 BN41826410050 MA1304500
description	opposite support L 118mm W 17mm mounting distance 94mm		
For models:	SERIE 900, SERIE GIANO 110, SERIE700		

 <p>1</p> <p>118 13 13 C</p>			
GEV No.	690030	Ref. No.	1034400400 CR1075440
description	oven hinge mounting distance 118mm lug mounting 13mm lever length 117mm groove distance 10mm spring thickness 3.5mm mounting ear position left/right spring length 60mm L 155mm W 21mm		
accessories for	690030		
 <p>GEV No. 700003 Ref. No. —</p> <p>opposite support L 110mm W 12mm mounting distance 94mm</p>			

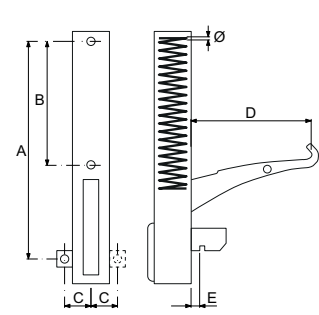
 <p>1</p>			
GEV No.	700006	Ref. No.	41826410060 6A035910
description	oven hinge mounting distance 173mm mounting distance 2 105mm lug mounting 14mm lever length 120mm groove distance 11mm spring thickness 3.5mm mounting ear position left spring length 112mm W 25mm		
For models:	SERIE 900, SERIE GIANO 110, SERIE700		
accessories for	700006		
	GEV No.	700001	Ref. No. 41826410050 6A035930 826410050 BN41826410050 MA1304500
opposite support L 118mm W 17mm mounting distance 94mm			
	GEV No.	700007	Ref. No. 41826410070 6A035920 826410070 BN6A035920
oven hinge mounting distance 173mm mounting distance 2 105mm lug mounting 14mm lever length 120mm groove distance 11mm spring thickness 3.5mm mounting ear position right spring length 112mm W 25mm			

 <p>1</p>			
			
GEV No.	700007	Ref. No.	41826410070 6A035920 BN6A035920
description	oven hinge mounting distance 173mm mounting distance 2 105mm lug mounting 14mm lever length 120mm groove distance 11mm spring thickness 3.5mm mounting ear position right spring length 112mm W 25mm		
For models:	SERIE 900, SERIE GIANO 110, SERIE700		
accessories for	700007		
	GEV No.	700001	Ref. No. 41826410050 6A035930 826410050 BN41826410050 MA1304500
opposite support L 118mm W 17mm mounting distance 94mm			

door bearing

 <p>1</p>			
GEV No.	691451	Ref. No.	2547860 BN2547860
description	hinge bearing mounting pos. bottom left/upper right with bolt		
For models:	7BRF/E805, 7FRI/E610, 7FRI/G815		

 <p>1</p>			
GEV No.	514292	Ref. No.	3106800 BN3106800
description	hinge bearing mounting pos. lower without bolt		

 <p>1</p>			
GEV No.	514294	Ref. No.	3106850 BN3106850
description	hinge bearing mounting pos. lower without bolt		

 <p>1</p>			
GEV No.	514291	Ref. No.	3106700 BN3106700
description	hinge bearing mounting pos. upper left without bolt		

 <p>1</p>			
GEV No.	691452	Ref. No.	2547870 BN2547870
description	hinge bearing mounting pos. upper left/bottom right with bolt		
For models:	7BRF/E805, 7FRI/E610, 7FRI/G815		

 <p>1</p>			
GEV No.	514293	Ref. No.	3106750 BN3106750
description	hinge bearing mounting pos. upper right without bolt		



fittings for catering equipment

outlet taps

universal

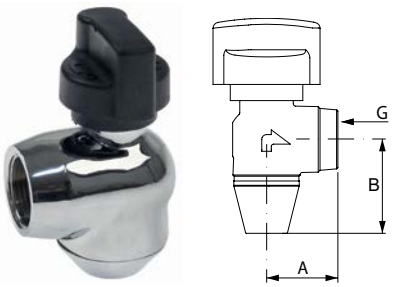

1

GEV No.	540699	Ref. No.	CR0846920
description	outlet tap W 35mm H 35mm thread 3/4" IT		

producer-specific

BARON



1

GEV No.	514325	Ref. No.	MA1950700
description	ball valve connection 1" IT - 1" IT DN25 total length 83mm with lever handle		



1

GEV No.	540658	Ref. No.	MA1450500
description	ball valve connection 3/4" IT - 3/4" IT DN20 total length 69mm		









1

GEV No.	514006	Ref. No.	41823550170 BN41823550170
description	drain pipe L 200mm thread ø 22mm		
For models:	SERIE 600		



1

GEV No.	540776	Ref. No.	41826900950 BN41826900950	
description	outlet tap L 83mm without handle thread 3/4" IT shaft L 9mm shaft ø 10x7.3mm handle M6			
For models:	SERIE 600			
spare parts for	540776			
	GEV No.	532453	Ref. No.	—
	O-ring EPDM thickness 2.62mm ID ø 21.89mm Qty 1 pcs			
accessories for	540776			
	GEV No.	110734	Ref. No.	—
	lever for outlet tap			
	GEV No.	514006	Ref. No.	41823550170 823550170 BN41823550170
	drain pipe L 200mm thread ø 22mm			
	GEV No.	514217	Ref. No.	—
	handle for outlet tap			
	GEV No.	540651	Ref. No.	—
	drain pipe total length 210mm shaft ø 22mm			
	GEV No.	540734	Ref. No.	—
	drain pipe thread			
	GEV No.	693082	Ref. No.	—
	lever handle thread			

aerators and air bleeders



1

GEV No.	540826	Ref. No.	41853310021
description	aerator and air bleeder thread 1/2" ET WS 24 chrome-plated brass L 30mm		
For models:	SERIE 900, SERIE700		

mechanical components, equipment accessories





drain taps

brass

drain taps





1

GEV No.	540275	Ref. No.	41853310027 BN41853310027 BN6A021000
description	drain tap 2" IT with union nut A 90mm B 151mm B1 80mm chrome-plated brass		
For models:	SERIE 900		
spare parts for	540275		
	GEV No.	540214	Ref. No. —
	handle ID ø 6mm L 145mm		
accessories for	540275		
	GEV No.	529484	Ref. No. —
	flat gasket fibre ED ø 58mm ID ø 50mm thickness 2mm Qty 1 pcs		
	GEV No.	542448	Ref. No. —
	gasket silicone 60x49x2 for drain tap 2"		



1

GEV No.	540276	Ref. No.	41853310059 BN41853310059
description	drain tap connection with union nut thread 1½"		
For models:	SERIE700		
spare parts for	540276		
	GEV No.	532374	Ref. No. —
	O-ring silicone thickness 5.34mm ID ø 43.82mm Qty 10 pcs		
accessories for	540276		
	GEV No.	514251	Ref. No. —
	gasket fibre ED ø 46mm ID ø 38mm thickness 2mm Qty 1 pcs		

FITTINGS FOR CATERING EQUIPMENT BARON

accessories



1

GEV No.	540959	Ref. No.	6A001451 BN6A001451
description	gasket for drain tap hose ext. ø 60mm ID ø 50mm H 2mm		



1

GEV No.	540119	Ref. No.	MA1420925
description	O-ring EPDM thickness 2.5mm ID ø 59mm Qty 1 pcs		

safety fittings

safety fittings



1

GEV No.	548000	Ref. No.	41853310056 BN41853310056
description	safety fitting thread 1"		
For models:	SERIE 900, SERIE700		
spare parts for	548000		
	GEV No.	540826	Ref. No. 41853310021 853310021
	aerator and air bleeder thread 1/2" ET WS 24 chrome-plated brass L 30mm		

safety valves



1

GEV No.	514122	Ref. No.	6A001482 BN6A001482
description	safety valve triggering pressure 0.5bar with CE approval thread 3/4"		



filters

device filters

1			
GEV No.	692816	Ref. No.	140408 935320 BN140408 FR935320
description	filter L 290mm W 290mm H 5mm for fridge		

equipment feet and end caps

equipment feet

with fixing plate

1			
GEV No.	700724	Ref. No.	MA6086113
description	equipment foot tube ø 58mm plate size 70x70mm hole distance 56x56mm H 130-210mm SS size 2 1/4" Qty 1 pcs		

1			
GEV No.	700742	Ref. No.	41826490142 BN826490142
description	equipment foot tube ø 64mm plate size 88x100mm hole distance 70x80mm H 135-200mm SS size 2" Qty 1 pcs		
For models:	7BM/E410, 7BMV/E800, 7BRF/E805, 7FRI/E610, 7FRI/G815, 7FT/G800, 7FTT/G405, 7FTT/G410, 7PCV/G120		

bolting feet

1			
GEV No.	514009	Ref. No.	MA1036021613
description	equipment foot L 50mm W 29mm H 25mm bore ø 10mm mounting distance 40mm Qty 1 pcs		

baskets

fryer baskets

<p>BARON</p>			
1			
GEV No.	970622	Ref. No.	418031940170 9000337 BN9000337
description	fryer basket L1 320mm W1 160mm H1 120mm L2 430mm H2 184mm H3 210mm		
For models:	7FRI/E610		

1			
GEV No.	970623	Ref. No.	418031940180 BN9000338
description	fryer basket L1 320mm W1 245mm H1 120mm		

crumb screens

1			
GEV No.	970614	Ref. No.	CR0508560
description	crumb screen L 400mm W 220mm suitable for fryer		

1			
GEV No.	970615	Ref. No.	MA1031112600
description	crumb screen L 388mm W 186mm suitable for fryer		

shelves and shelf rails

chargrill grids



1	GEV No.	210039	Ref. No.	BN2543460
	description	chargrill grid L 485mm W 380mm H 32mm		

grates

universal

with upstand

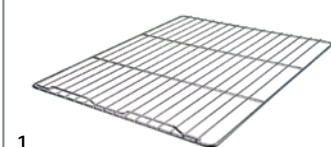

1	GEV No.	970527	Ref. No.	MA2306800	
	description	grate W 530mm D 650mm GN 2/1 chrome-plated steel with hinge camp crossing wires 2 suitable for refrigerator			
	accessories for	970527			
		GEV No.	690330	Ref. No.	—
		rack L 1000mm W 22mm H 4mm aperture 3x8mm hole distance 12.5mm stainless steel			
		GEV No.	694700	Ref. No.	—
		shelf support L 31/28mm W 22mm H 18mm SS Qty 12 pcs			
		GEV No.	694701	Ref. No.	—
		shelf support L 31/28mm W 22mm H 17mm SS with hook Qty 12 pcs			

grates



1	GEV No.	692114	Ref. No.	822410120 822410121 BN822410121
	description	chimney grate L 400mm W 70mm H 25mm		

gaskets

refrigeration gaskets

plug-in gaskets

profile 9048

We offer custom-made gaskets for this profile

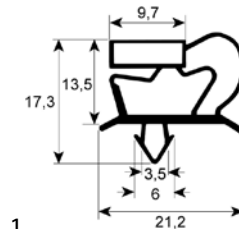

1	GEV No.	900310	Ref. No.	FR4500451 FR935306
	description	refrigeration gasket profile 9048 W 677mm L 1512mm plug size door		

profile 9794

We offer custom-made gaskets for this profile

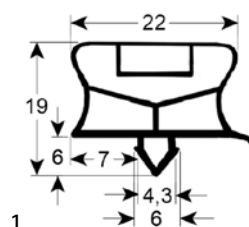

1	GEV No.	900684	Ref. No.	41RFR925281 4500661 BN41RFR925281 FR4500661
	description	refrigeration gasket profile 9794 W 390mm L 580mm plug size		

profile 9794Z (blast freezer)

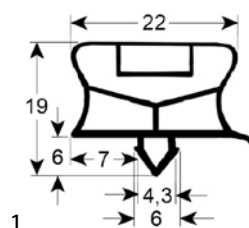

1	GEV No.	901820 ¹	Ref. No.	FR4501151 FR965128
	description	blast freezer gasket profile 9794Z W 336mm L 692mm suitable for FRIULINOX		

¹for blast freezer

GEV No.	901813 ¹	Ref. No.	4500701 925314 FR4500701 FR925314
description	blast freezer gasket profile 9794Z W 580mm L 461mm for blast chiller suitable for FRIULINOX		

¹for blast freezer

gaskets for heated units

door seals

GEV No.	900454	Ref. No.	3108820 BN3108820
description	door seal profile 2510 W 447mm L 1448mm external size		
For models:	ECVME 21, ECVMG 21, ECVPE 21, ECVPG 21		

GEV No.	900451	Ref. No.	3108600 BN3108600
description	door seal profile 2510 W 450mm L 540mm external size Qty 1		
For models:	ECVME 6, ECVMG 6, ECVPE 6, ECVPG 6		

GEV No.	900452	Ref. No.	3108700 BN3108700
description	door seal profile 2510 W 450mm L 780mm external size Qty 1		
For models:	ECVME 10, ECVMG 10, ECVPE 10, ECVPG 10		

GEV No.	900453	Ref. No.	3108800 BN3108800
description	door seal profile 2510 W 640mm L 770mm external size Qty 1		
For models:	ECVME 20, ECVMG 20, ECVPE 20, ECVPG 20		

GEV No.	900829	Ref. No.	2510674 BN2510674
description	door seal profile 2741 Qty supplied by meter		

GEV No.	900682	Ref. No.	2510685 BN2510685
description	door seal W 250mm L 550mm 3-sided		

door seals with fixing hook

GEV No.	901917	Ref. No.	CR0931990
description	door seal L 570mm W 295mm 4-sided		

O-rings

EPDM

GEV No.	540119	Ref. No.	MA1420925
description	O-ring EPDM thickness 2.5mm ID ø 59mm Qty 1 pcs		

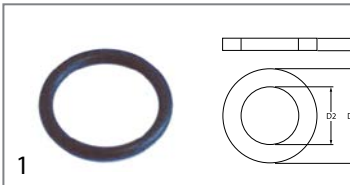

GEV No.	507309	Ref. No.	41824710280 BN824710280
description	O-ring EPDM thickness 2.62mm ID ø 17.13mm Qty 1 pcs		

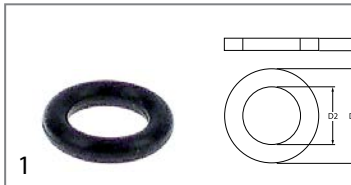

GEV No.	532497	Ref. No.	41824710550 BN41824710550
description	O-ring Viton thickness 1.78mm ID ø 5.28mm Qty 1 pcs		

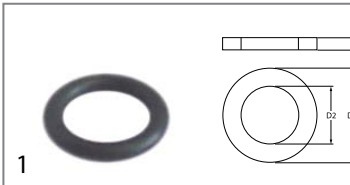

GEV No.	528487	Ref. No.	MA2867700
description	O-ring EPDM thickness 2.62mm ID ø 9.19mm Qty 1 pcs		



GEV No.	510245	Ref. No.	4185326090144 BN4185326090144 BN85326090144
description	O-ring Viton thickness 3.53mm ID ø 50.8mm Qty 1 pcs		

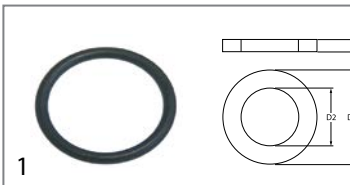

GEV No.	510408	Ref. No.	0118462630 BN0118462630
description	O-ring EPDM thickness 5.34mm ID ø 47mm Qty 1 pcs		

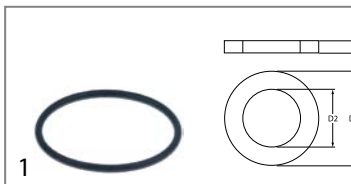

GEV No.	510243	Ref. No.	41824710530 4185326090145 BN41824710530 BN4185326090145
description	O-ring Viton thickness 3.53mm ID ø 55.56mm Qty 1 pcs		
For models:	SERIE 900, SERIE700		

silicone

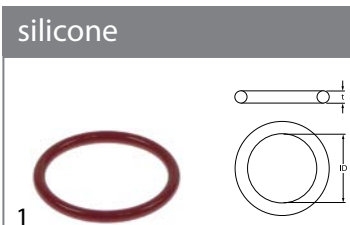

GEV No.	514017	Ref. No.	0105246 MA1814400 R0105246 SIR0105246
description	O-ring silicone thickness 3.53mm ID ø 32.93mm Qty 1 pcs		

sealing washers

PTFE gaskets

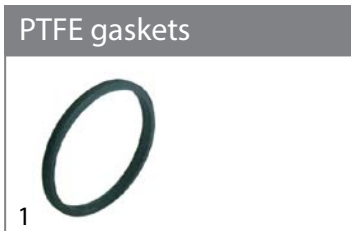

GEV No.	514016	Ref. No.	MA1814500
description	flat gasket PTFE ED ø 45mm ID ø 40mm thickness 4mm Qty 1 pcs equiv. no. 1036500400/1814500 suitable for MARENO		

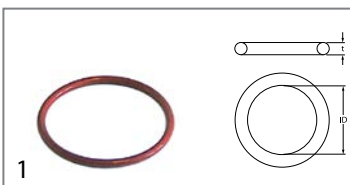

GEV No.	514021	Ref. No.	MA1814700
description	O-ring silicone thickness 3.53mm ID ø 49.21mm Qty 1 pcs		

silicone gaskets



GEV No.	691332	Ref. No.	MA2993700
description	flat gasket silicone ED ø 13.8mm ID ø 6mm thickness 1.5mm Qty 1 pcs		

Viton

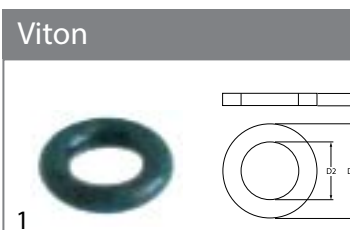

GEV No.	528687	Ref. No.	MACM097900
description	O-ring Viton thickness 1.78mm ID ø 3.69mm Qty 1 pcs		



foam rubber gaskets



1

GEV No.	691329	Ref. No.	MA1036607700
description	foam rubber gasket W 10mm thickness 5mm self-adhesive Qty supplied by meter		

sealing cords

square



1

GEV No.	693739	Ref. No.	6A098410 825110080 BN6A098410
description	sealing cord square size 12x12mm t.max. 550°C braided L 5m		

evaporators

for fridges

producer-specific



1

GEV No.	750234	Ref. No.	8013412110 935674 FR6521640 FR935674
description	evaporator L 250mm W 140mm H 500mm		



1

GEV No.	750198	Ref. No.	8018133210 FR6522092
description	evaporator L 495mm W 60mm H 460mm		

springs

torsion springs



1

GEV No.	700431	Ref. No.	41R320890
description	torsion spring ø 31mm wire gauge ø 4mm L1 32mm L2 257mm L3 32mm		
For models:	SERIE700		



1

GEV No.	700432	Ref. No.	41853310009 4185331009 BN41853310009
description	torsion spring ø 52mm wire gauge ø 4.1mm L1 19mm L2 116mm L3 19mm		
For models:	SERIE 900		

compression springs



1

GEV No.	514301	Ref. No.	3107955 BN3107955
description	compression spring ø 6.5mm L 14mm wire gauge ø 1.2mm		
For models:	ECVME 10, ECVME 20, ECVME 21, ECVME 6, ECVMG 10, ECVMG 20, ECVMG 21, ECVMG 6, ECVPE 10, ECVPE 20, ECVPE 21, ECVPE 6, ECVPG 10, ECVPG 20, ECVPG 21, ECVPG 6		

tension springs



1

GEV No.	700430	Ref. No.	41823210031 BN41823210031 BN823210031
description	tension spring ø 33.9mm total length 200mm wire gauge ø 4.2mm		



1

GEV No.	700429	Ref. No.	41823210020 BN41823210020
description	tension spring ø 45mm total length 160mm wire gauge ø 5.3mm		
For models:	SERIE700		

kitchen accessories

gastronorm

bridges



1

GEV No.	691337	Ref. No.	CR0506490
description	bridge for Gastronorm container L1 525mm L2 505mm SS W 72mm H 15mm Qty 1 pcs		

manometers



1

GEV No.	541334	Ref. No.	0102491 41853310148 BN41853310148 R0102491 SIR0102491
description	manometer ø 60mm pressure range 0 up to 1bar thread 1/8" marking 0.5 kettle connection on the backside		
For models:	SERIE 900, SERIE700		



1

GEV No.	541901	Ref. No.	CR0589110
description	manometer ø 63mm pressure range 0 up to 1bar 0 up to 14.5PSI thread 1/4" connection on the backside		

hoses

industrial hoses

silicone hoses

without fabric



1

GEV No.	530063	Ref. No.	MA1036100700
description	silicone hose ID ø 18mm ED ø 25mm L 1m t.max. 200°C transparent		

valves and tank inlets

ball valves

universal

ball valves with butterfly handle



1

GEV No.	540658	Ref. No.	MA1450500
description	ball valve connection 3/4" IT - 3/4" IT DN20 total length 69mm		

ball valves with lever handle



1

GEV No.	540758	Ref. No.	6A023010 BN6A023010
description	ball valve connection 1" IT - 1" ET DN25 total length 90mm with lever handle handle length 95mm		
For models:	7FRI/E610, 7FRI/G815		



1

GEV No.	514325	Ref. No.	MA1950700
description	ball valve connection 1" IT - 1" IT DN25 total length 83mm with lever handle		

producer-specific

BARON





1

GEV No.	514400	Ref. No.	MA1031400313
description	ball valve connection 1/2" IT - 1/2" IT total length 47mm handle length 68mm		

accessories for	514400			
	GEV No.	514098	Ref. No.	—



extension for lever L 220mm



 <p>1</p>			
GEV No.	514266	Ref. No.	41826900960 BN41826900960
description	ball valve inlet 3/8" ET outlet 3/8" ET DN10 L 68mm without handle shaft ø 10x8mm		
For models:	SERIE 600		
accessories for	514266		
	GEV No.	112738	Ref. No. —
knob water cold t.max.°C ø 70mm shaft ø 10x8mm shaft flat universal black			

<p>ball valves electric</p>  <p>1</p>			
GEV No.	401190	Ref. No.	3103590 BN3103590
description	ball valve inlet 3/4" IT outlet 3/4" IT IP42 230V L 68mm 50/60Hz closed off-current mode of operation electric connection cable 300mm 3.5W duty cycle 50%		
For models:	ECVPE 10, ECVPE 20, ECVPE 21, ECVPE 6, ECVPG 10, ECVPG 20, ECVPG 21, ECVPG 6		

<p>shut-off valves</p> <p>universal</p>  <p>1</p>			
GEV No.	514270	Ref. No.	41853321733 BN41853321733
description	shut-off valve mounting pos. right		
For models:	SERIE 900, SERIE700		

<p>producer-specific</p> <p>BARON</p>  <p>1</p>			
GEV No.	514266	Ref. No.	41826900960 BN41826900960
description	ball valve inlet 3/8" ET outlet 3/8" ET DN10 L 68mm without handle shaft ø 10x8mm		
For models:	SERIE 600		
accessories for	514266		
	GEV No.	112738	Ref. No. —
knob water cold t.max.°C ø 70mm shaft ø 10x8mm shaft flat universal black			

 <p>1</p>			
GEV No.	514267	Ref. No.	41826900070 BN41826900070 BN826900070
description	inlet tap connection 1/2" 1/2" total length 35mm mounting pos. right rosette thread G2 27x19G shaft ø 8-10mm		
spare parts for	514267		
	GEV No.	111704	Ref. No. 41824710140 824710140 BN41824710140 BN824710140
knob connection 10x8 ø 70mm water cold (1/2 turn) shaft ø 10x8mm shaft flat upper t.max.°C			
	GEV No.	111709	Ref. No. 41824710150 824710150 BN41824710150 BN824710150
knob connection 10x8 water warm (1/2 turn) total lengthmm mounting pos. ø 70mm			
	GEV No.	514083	Ref. No. —
rosette connection 27x19G chrome-plated total lengthmm mounting pos.			
	GEV No.	514084	Ref. No. —
nut thread 27x19G WS 34			

			
GEV No.	111704	Ref. No.	41824710140 BN41824710140 BN824710140
description	knob connection 10x8 ø 70mm water cold (1/2 turn) shaft ø 10x8mm shaft flat upper t.max.°C		

			
GEV No.	111709	Ref. No.	41824710150 BN41824710150 BN824710150
description	knob connection 10x8 water warm (1/2 turn) total lengthmm mounting pos. ø 70mm		

			
GEV No.	514271	Ref. No.	41853321537 BN41853321537
description	shut-off valve connection 1/2" 1/2" total length 35mm mounting pos. left rosette thread G2 27x19G shaft ø 8-10mm		
For models:	SERIE 900, SERIE700		
spare parts for	514271		

			
GEV No.	111704	Ref. No.	41824710140 824710140 BN41824710140 BN824710140
description	knob connection 10x8 ø 70mm water cold (1/2 turn) shaft ø 10x8mm shaft flat upper t.max.°C		



			
GEV No.	111709	Ref. No.	41824710150 824710150 BN41824710150 BN824710150
description	knob connection 10x8 water warm (1/2 turn) total lengthmm mounting pos. ø 70mm		

GEV No.	514083	Ref. No.	—
description	rosette connection 27x19G chrome-plated total lengthmm mounting pos.		

GEV No.	514084	Ref. No.	—
description	nut thread 27x19G WS 34		

inlet taps



GEV No.	514269	Ref. No.	41826900260 BN826900260	
description	inlet tap connection 1/2" ET tube ø 18mm projection 100mm overall height 230mm spout height 140mm rotation 360°			
For models:	SERIE 900, SERIE700			
spare parts for	514269			
	GEV No.	548176	Ref. No.	—
tap head without plunger bush bearing thread 1/2" T2: M24x1 D1 ø 18mm D2 ø 24mm H1 18-24mm H2 29mm H3 10mm shaft intake ø 8mm suitable for RUBINETTERIE DEL FRIULI				
	GEV No.	551335	Ref. No.	—
star handle shaft intake ø 8mm shaft length H1 12mm H2 22mm D1 ø 32mm suitable for RUBINETTERIE DEL FRIULI marking blue				



GEV No.	540787	Ref. No.	41853310001 BN41853310001
description	inlet tap connection 1/2" IT tube ø 20mm rotation 90° H1 165mm H2 100mm L 120mm		
For models:	SERIE 900, SERIE700		

tank inlets

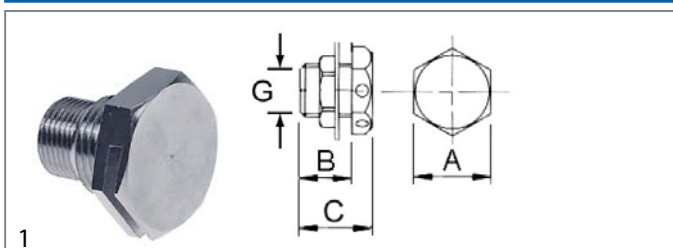

GEV No.	691390	Ref. No.	41822160230 BN822160230
description	tank inlet connection 1/2" - 3/8" WS 30 L1 22mm L2 29mm		



drain systems and wash basins

standpipes

producer-specific

BARON



1

GEV No.	691388	Ref. No.	41822160210 BN822160210
description	overflow pipe ø 20mm L 115mm		
spare parts for	691388		
	GEV No.	504618	Ref. No.
			—
	O-ring EPDM thickness 2.62mm ID ø 15.54mm Qty 1 pcs		

tools

cleaning tools

scrapers



1

GEV No.	705008	Ref. No.	2510513 BN2510513
description	scraper for griddle		
spare parts for	705008		
	GEV No.	705021	Ref. No.
			—
	spare blades for scraper Qty 10 pcs		



1

GEV No.	705009	Ref. No.	2510513 (old version) BN2510513 (old version) MA1030000600
description	scraper for griddle W 80mm		

fastening material

screws

grub screws

DIN 916/ISO 4029



1

GEV No.	560173	Ref. No.	6A009190 BN6A009190
description	grub screw thread M4 L 10mm SS DIN 916/ISO 4029 intake internal hexagon WS 2 Qty 20 pcs		
For models:	7FT/G800, 7FTT/G405, 7FTT/G410		

nuts

long nuts



1

GEV No.	540438	Ref. No.	MA1868700
description	long nut thread M10 L 25mm WS 13 brass Qty 1 pcs		

hexagonal nuts

hexagonal nuts metric (without norm)



1

GEV No.	540436	Ref. No.	MA1033514900
description	hexagonal nut thread M10x1.25 H 4mm WS 13 brass Qty 1 pcs		



1

GEV No.	102382	Ref. No.	MA1033700200
description	nut thread M14x1 H 3.5mm WS 18 brass Qty 1 pcs		



1

GEV No.	101345	Ref. No.	41822180010 BN6A010820 BN822180010
description	nut thread M15x1 H 3mm WS 19 brass Qty 1 pcs		
For models:	7FT/G800, 7FTT/G405, 7FTT/G410		



 1			
GEV No.	102067	Ref. No.	6A012300 BN6A012300 MA939300
description	nut thread M8x1 H 3mm brass Qty 1 pcs type SEF 1		

hexagonal nuts inch thread

 1			
GEV No.	514022	Ref. No.	MA14044599
description	nut thread 1½" H 12mm SS WS 59 Qty 1 pcs		

fasteners

roll pins

 1			
GEV No.	691398	Ref. No.	418227993140 BN418227993140
description	roll pin ø 3mm L 16mm		
For models:	7FT/G800, 7FTT/G405, 7FTT/G410		

 1			
GEV No.	691397	Ref. No.	418227994250 BN8227994250
description	roll pin ø 4mm L 26mm		

consumables

sealants and adhesives

high temperature silicone

 1			
GEV No.	890059	Ref. No.	6A098350 BN6A098350
description	high temperature silicone FERMITOPP 300 neutral curing -40 up to +265°C black cartridge 310ml		
description	Fermitopp HN 300 - cartridge 310ml - black Is used for sealing expansion joints on heating flues, ovens, reactors, chimneys, stacks, etc. The sealant is neutrally cross-linking, reacts with the moisture in the air and is characterised by extremely good hot air-resistance. The adhesive surfaces must be dry, clean and free of loose parts and in the case of porous substrates they should, if necessary, be given a first coat of primer. Post-smoothing e.g. with soap solution must take place before skinning. Highly refractory, odourless, UV/water/colour/hot-air resistant Temperature range -50°C to +250°C		

cleaning agents

combi-steamer detergents/descalers

Notice: Articles labelled 'DANGEROUS GOODS' are delivered by road through a forwarder for reasons of safety and are charged separately!

 1			
GEV No.	802056	Ref. No.	4185312300
description	detergent for combi-steamer Combi Clean content 11kg		



fuses

fine fuses

fine fuse holders

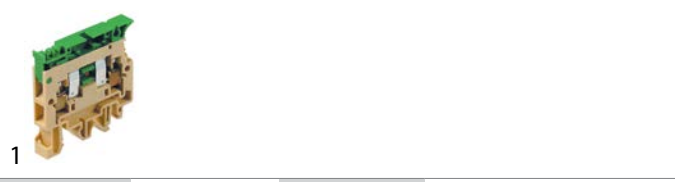

GEV No.	550848	Ref. No.	0A034500 BN6A034500
description	fuse holder suitable fuse ø5x20mm		
For models:	ECVME 10, ECVME 20, ECVME 21, ECVME 6, ECVMG 10, ECVMG 20, ECVMG 21, ECVMG 6, ECVPE 10, ECVPE 20, ECVPE 21, ECVPE 6, ECVPG 10, ECVPG 20, ECVPG 21, ECVPG 6		

A			
alarm devices	28	gas taps	40
axial fans	35	gas thermostats	42
B		gaskets for heated units	99
ball valves	102	gastronorm	102
ball valves electric	34, 103	grates	98
ballasts	27	grub screws	105
bar burners	72	H	
bi-metal thermostats	15, 15	heating elements	3
C		heating elements for bain maries	3
cable glands	38, 38	heating elements for chip scuttles	3
cables	38	heating elements for convection	11
cam switches	23	heating elements for fryers	4
capillary tube clips	21	heating elements for frying pans	3
ceramic heaters	9	heating elements for griddles	6
cleaning agents	106	heating elements for ovens	3
cleaning tools	105	heating elements for pasta cookers	7
combi-steamer detergents/descalers	106	heating elements for salamanders/toasters	9
consumables	106	heating elements for tilting bratt pan	6
contactors	28	hexagonal nuts	105
control equipment	25	high temperature silicone	106
control thermostats	15	hob burners	61
D		hoses	102
door seals	99	hot air fans	37
door seals with fixing hook	99	hot air motors	36
drain systems and wash basins	105	hot plates	13
E		I	
electric accessories	38	ignition boxes	47
electrodes	34	ignition cables	58
energy regulators	14	ignition units	59
espagnolette locks	92	immersion heating elements	10
evaporators	101	indicator lights	26
F		indicator lights (complete)	26
fans	35	industrial hoses	102
fasteners	106	inlet spouts	104
fastening material	105	inlet taps	104
fine fuses	107	L	
fluorescent lamps	27	lamps	26
foam rubber gaskets	101	long nuts	105
foil heating elements	13	M	
fuses	38, 107	magnetic switches	24
G		microswitches	22
gas burners	61	N	
gas control valves	46	nuts	105
gas lines	85	O	
gas nozzles	78	O-rings	99
		oven hinges	93
		oven lamps	27

P

piezoelectric igniters	58
pilot burners	47
plug-in gaskets	98
pressure switches	34
probe clips	21
probes	32
programme timers	28
pumps	38
push/momentary push switches	21

R

radiation heaters	12
refrigeration gaskets	98
relays	30
residual heat indicators	27
roll pins	106

S

safety thermostats	17
screws	105
sealants and adhesives	106
sealing cords	101
sealing washers	100
shelves and shelf rails	98
shut-off valves	103
silicone	106
silicone hoses	102
solenoid valves	33
solid top burners	76
spring clips	21
standpipes	105
switches and momentary switches	21

T

tank inlets	104
terminals	39
thermocouples	59
thermostats	15
threaded cable glands	38
time relays	31
timers	28
tools	105
transformers	31
tube burners	76

V

valves and tank inlets	102
------------------------	-----

W

wash and rinse pumps	38
----------------------	----