



GAS COMPONENTS



ELECTRIC COMPONENTS



WATER TECHNOLOGY



MECHANICAL COMPONENTS



TOOLS

Spare parts suitable for

AURORA

Find the complete and up-to-date range of products in our GEV Webshop



Manufacturer catalogue

The most important spare parts and accessories arranged clearly for every manufacturer

- ✓ Complete product range and all appliance data always up to date in the GEV Webshop
- ✓ Alphabetical Index at the end of the catalogue

GEV Webshop

www.gev-online.co.uk

www.gev-online.com





- 🔍 Add to Favourites
- 🔍 Sign In with email address and usual password
- 🔍 Easy-order – place several items in your basket at the same time
- 🔍 Quick Item search – no login needed





heating elements



heating elements for coffee machine

			
1			
GEV No.	417262	Ref. No.	000644.F
description	heating element 2000W 230/400V heating circuits 3 mounting ø 39mm hole distance 58mm L 178mm W 33mm H 33mm hole ø 10mm length thermostat sleeves 140mm thermostat sleeves ø 5mm number of thermostat sleeves 1 thermostat sleeve eccentric, non clinging tube ø 8mm connection 2.5 210 3 hole flange		
For models:	Alexia, C		

			
1			
GEV No.	417055	Ref. No.	000644
description	heating element 2000W 230V heating circuits 2 hole distance 54mm L 215mm W 38mm H 58mm L1 20mm L2 40mm L3 175mm H1 33mm H2 26mm hole ø 9mm tube ø 8mm connection M6 immersion heater 4 hole flange		

			
1			
GEV No.	417211	Ref. No.	N/A
description	heating element 2000W 230V heating circuits 2 mounting ø 42.5mm hole distance 40mm L 167mm W 33mm H 52mm L1 2mm L2 40mm L3 107mm H1 25mm H2 27mm hole ø 10mm connection M6 immersion heater 4 hole flange		

			
1			
GEV No.	417056	Ref. No.	N/A
description	heating element 2500W 230V heating circuits 2 hole distance 54mm L 328mm W 37mm H 56mm L1 25mm L2 35mm L3 263mm H1 26mm H2 26mm hole ø 10mm connection M6x1 immersion heater 4 hole flange		

			
1			
GEV No.	417058	Ref. No.	N/A
description	heating element 2500W 230V heating circuits 2 thread 1¼" L 330mm W 38mm H 22mm tube ø 8mm connection M5 immersion heater flange with thread WS 40		
spare parts for	417058		
	GEV No.	510405	Ref. No.
	flat gasket fibre ED ø 56mm ID ø 42mm thickness 2mm for thread 1¼" Qty 1 pcs		
accessories for	417058		
	GEV No.	528021	Ref. No.
	flat gasket PTFE ED ø 53mm ID ø 42.5mm thickness 3mm Qty 1 pcs equiv. no. 12001/02286 suitable for Astoria/Aurora/Brasilia/Wega		

			
1			
GEV No.	417263	Ref. No.	000645.F
description	heating element 3000W 230/400V heating circuits 3 mounting ø 39mm hole distance 58mm L 305mm W 33mm H 33mm hole ø 10mm length thermostat sleeves 148mm thermostat sleeves ø 5mm number of thermostat sleeves 1 thermostat sleeve eccentric, non clinging tube ø 8mm connection M3 immersion heater 3 hole flange		
For models:	Alexia, C		

			
1			
GEV No.	417091	Ref. No.	N/A
description	heating element 4000W 230V heating circuits 2 hole distance 53mm L 455mm W 39mm H 58mm L1 30mm L2 50mm L3 380mm H1 26mm H2 32mm hole ø 9mm tube ø 8mm connection M6 immersion heater 4 hole flange		

			
1			
GEV No.	417264	Ref. No.	000646.F
description	heating element 6000W 230/400V heating circuits 3 mounting ø 39mm hole distance 58mm L 520mm W 33mm H 33mm hole ø 10mm length thermostat sleeves 146mm thermostat sleeves ø 5mm number of thermostat sleeves 1 thermostat sleeve eccentric, non clinging tube ø 8mm connection M3 immersion heater 3 hole flange		
For models:	Alexia, C		

accessories

hexagonal nuts

			
1			
GEV No.	361184	Ref. No.	521381
description	nut thread 1/2" H 6mm nickel-plated brass WS 24 Qty 1 pcs		
For models:	C		

flange gaskets

			
1			
GEV No.	528740	Ref. No.	000308.F
description	gasket ID ø 44mm PTFE thickness 3.5mm hole ø 9.5mm hole distance 58mm suitable for ITALCREM, VISACREM for heating element coffee machine parts		
For models:	Alexia, C		

			
1			
GEV No.	528020	Ref. No.	000306.A N/A
description	gasket fibre D1 ø 56mm D2 ø 95mm thickness 2mm hole ø 10mm hole distance 54mm		



thermostats

bi-metal thermostats

safety bi-metal thermostats



1

GEV No.	390852	Ref. No.	05.1700.10.20
description	bi-metal safety thermostat hole distance 39-44mm switch-off temp. 135°C 2NC 2-pole 16A connection F6.3		
For models:	Alexia, C		



1

GEV No.	390688	Ref. No.	05.1700.10.20 old
description	bi-metal safety thermostat hole distance 39mm switch-off temp. 130°C 2NC 2-pole 10A connection male faston 3.2mm mounting ø 31mm		

electronics

PCBs



1

GEV No.	402248	Ref. No.	550.9.5.13.41
description	display coffee machine L 80mm W 36mm		
For models:	Alexia		

central units



1

GEV No.	402250	Ref. No.	550.9.5.25.32
description	central unit 3 groups for coffee machine 230V 50/60Hz type 3d5 MAESTRO 3GRCTD voltage AC		
For models:	Alexia		

dosing electronics

GICAR



1

GEV No.	402247	Ref. No.	88.1.13.01
description	dosing electronics with level controller 250V voltage AC 50/60Hz 3/3/3/8A type ET30 Plus EM 2GRC		
For models:	C		

keypads

keypad units



1

GEV No.	402702	Ref. No.	88 1.22.02
description	keypad unit buttons 5 lighting LED		
For models:	C		



1

GEV No.	402251	Ref. No.	550.9.9.08.55
description	keypad unit buttons 6 L 113mm W 35.5mm with LED		
For models:	Alexia		

solenoid valves



Solenoid valve - accessories



1

GEV No.	525765	Ref. No.	000187
description	mounting plate for solenoid valve		



			
1			
GEV No.	528952	Ref. No.	000187old
description	mounting plate for solenoid valve		
accessories for	528952		
	GEV No.	528954	Ref. No.
			—
			
	nozzle hole ø 0.8mm thread M6 thread L 6mm brass		

electrodes

			
1			
GEV No.	401157	Ref. No.	000436
description	level electrode 1/4" total length 150mm probe L 122mm insulated probe length 26mm connection male faston 6.3mm stainless steel ø 2.5mm		
For models:	Alexia, C		

equipment-specific units

for espresso machines

filter holders

filter holders standard

filter holder without spout

			
1			
GEV No.	525984	Ref. No.	N/A
description	filter holder suitable for AURORA/BRASILIA/FAEMA without outlet mounting ø 82.5mm outlet 3/8" ID ø 62mm wedge height 10.5mm wedge position horizontal number of wedges 2 lever straight		

filter holders short

			
1			
GEV No.	525776	Ref. No.	000047 000047.57
description	filter holder mounting ø 82.8mm outlet 3/8" ID ø 61.5mm handle M12x1.75 wedge height 9.7mm wedge position horizontal number of wedges 2 lever inclined chrome-plated brass		
For models:	Alexia, C		

filters

for 1 cup

			
1			
GEV No.	527631	Ref. No.	N/A
description	coffee filter ø 70mm mounting ø 60.7mm H 17mm cups 1 amount of coffee 8g		

brewing units

shower screens

with upstand and central hole

			
1			
GEV No.	525772	Ref. No.	000182
description	shower screen ø 56.5mm H 6.3mm hole ø 5.6mm		

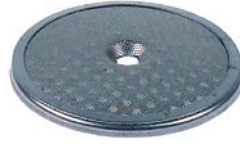
			
1			
GEV No.	529031	Ref. No.	000182
description	shower screen ø 56.7mm H 6.1mm hole ø 5.5mm		
For models:	Alexia, C		

			
1			
GEV No.	529092	Ref. No.	N/A
description	shower screen ø 56.7mm H 6mm hole ø 7.1mm		

filter holder gaskets

flat

with external notch

			
1			
GEV No.	528049	Ref. No.	N/A
description	filter holder gasket D1 ø 72mm D2 ø 56.5mm H 9mm with outside notch Qty 1 pcs		

standard



1

GEV No.	525775	Ref. No.	000177
description	filter holder gasket D1 ø 72mm D2 ø 56.5mm H 8.8mm with outside notch Qty 1 pcs		
For models:	Alexia, C		

brewing units with solenoid valve

pipes



1

GEV No.	526079	Ref. No.	800643
description	drain pipe for solenoid valve ø 6mm L 255mm copper		
For models:	Alexia, C		



1

GEV No.	526081	Ref. No.	800637
description	injection pipe ø 6mm ID ø 4mm L 200mm T1: 1/8"		
For models:	Alexia, C		

components

nozzles

bushes



1

GEV No.	528321	Ref. No.	000178
description	filter support D1 ø 13mm ID ø 5mm int. ø 1 11mm H 9mm brass		
For models:	Alexia, C		

with thread



1

GEV No.	528486	Ref. No.	000184
description	nozzle bore ø 0.7mm thread M6x0.75 L 9mm WS 7		
For models:	Alexia, C		

water dispersions

water dispersions

group 2



1

GEV No.	525767	Ref. No.	000183
description	water distributor ø 30mm H 13mm ET M10x1 IT M5 grooves 6 2.5mm brass		
For models:	Alexia, C		

safety valves

gaskets



1

GEV No.	526078	Ref. No.	000360
description	gasket D1 ø 15mm thickness 4mm Viton for safety valve		
For models:	Alexia, C		

springs



1

GEV No.	526077	Ref. No.	000361
description	compression spring ø 7mm L 26mm wire gauge ø 0.8mm for safety valve		
For models:	Alexia, C		

steam/water taps

steam/water taps

steam/water taps



1

GEV No.	526074	Ref. No.	407.800515
description	steam/water tap inlet 1/4" outlet 3/8" brass		
For models:	Alexia, C		
accessories for	526074		



GEV No.	111318	Ref. No.	—
----------------	--------	-----------------	---

knob ø 50mm thread Tr18x2 black





GEV No.	361184	Ref. No.	521381
----------------	--------	-----------------	--------



nut thread 1/2" H 6mm nickel-plated brass WS 24 Qty 1 pcs





steam taps			
steam taps (complete)			
			
1			
GEV No.	525491	Ref. No.	N/A
description	steam tap complete with handle inlet 1/4" brass pipe SS pipe length 180mm tube ø 10mm		

			
1			
GEV No.	525492	Ref. No.	N/A
description	water pipe complete with handle inlet 1/4" brass pipe SS pipe length 100mm tube ø 10mm		

miscellaneous			
			
1			
GEV No.	111279	Ref. No.	B-MC-0058
description	knob spring ø 29mm L 5mm wire gauge ø 1.1mm		
For models:	Alexia		

components			
bushes			
			
1			
GEV No.	526010	Ref. No.	521013
description	bush steam/water tap D1 ø 10.5mm D2 ø 9mm ID ø 6.3mm H 4.6mm brass		
For models:	Alexia, C		
accessories for	526010		
	GEV No.	Ref. No.	—
			
	shaft steam tap ø 14.8mm L 92.5mm thread M6 brass		

			
1			
GEV No.	526023	Ref. No.	521112
description	bush steam/water tap D1 ø 12mm D2 ø 8.5mm ID ø 7mm H 6mm brass		
For models:	Alexia, C		

gaskets			
			
1			
GEV No.	527970	Ref. No.	000049
description	flat gasket PTFE ED ø 24mm ID ø 18mm thickness 2mm Qty 1 pcs		
For models:	Alexia		

			
1			
GEV No.	526080	Ref. No.	521106
description	gasket D1 ø 12.5mm thickness 6.6mm silicone with notch		
For models:	Alexia, C		

			
1			
GEV No.	525774	Ref. No.	000213
description	gasket D1 ø 16mm ID ø 4mm thickness 4mm		

springs			
			
1			
GEV No.	111279	Ref. No.	B-MC-0058
description	knob spring ø 29mm L 5mm wire gauge ø 1.1mm		
For models:	Alexia		

			
1			
GEV No.	526024	Ref. No.	521014
description	spring ø 10.3mm L 31mm wire gauge ø 1.2mm		
For models:	Alexia, C		

			
1			
GEV No.	526025	Ref. No.	521019
description	spring ø 12mm L 16mm wire gauge ø 1.45mm		
For models:	Alexia, C		

tap bodies



1

GEV No.	526073	Ref. No.	521107
description	tap body T1: 1/4" T2: 3/8" T3: M16x1 IT L 35mm		
For models:	Alexia, C		

washers



1

GEV No.	560382	Ref. No.	521382
description	washer D1 ø 6mm D2 ø 20mm thickness 1.5mm steam/water tap		

screw connections



1

GEV No.	526075	Ref. No.	521010
description	screw connection T1: M16x1 T2: 1/2" L 51.4mm brass		
For models:	Alexia, C		

water taps

knobs



1

GEV No.	111142	Ref. No.	000602 + 000.511.40.7
description	knob water		

steam/water pipes

steam pipes



1

GEV No.	526083	Ref. No.	800203.INOX
description	steam pipe H 180mm ø 14.5mm tube ø 10mm IT M8.5x0.75 stainless steel with plastic hose		
For models:	Alexia, C		



1

GEV No.	525773	Ref. No.	800202
description	steam pipe thread 3/8" H 185mm L 235mm W 110mm ø 14.3mm tube ø 10mm stainless steel		
spare parts for	525773		
	GEV No.	526083	Ref. No.
			800203.INOX
	steam pipe H 180mm ø 14.5mm tube ø 10mm IT M8.5x0.75 stainless steel with plastic hose		

nozzles for steam pipes



1

GEV No.	526082	Ref. No.	800209.INOX
description	nozzle thread M8.5x0.75 ø 12.5mm L 16mm bore ø 1.55mm		
For models:	Alexia, C		

water pipes



1

GEV No.	529629	Ref. No.	800206
description	water pipe ø 15mm L 102mm tube ø 10mm suitable for AURORA		

accessories

union nuts



1

GEV No.	528337	Ref. No.	000201
description	union nut thread 1/2" L 16mm hole ø 12.5mm brass		



1

GEV No.	529706	Ref. No.	521111
description	union nut thread 3/8" L 21mm hole ø 12.5mm brass		
For models:	Alexia, C		

fine filters

holders





1

GEV No.	528321	Ref. No.	000178
description	filter support D1 ø 13mm ID ø 5mm int. ø 1 11mm H 9mm brass		
For models:	Alexia, C		





fine filters			
			
1			
GEV No.	529911	Ref. No.	000179
description	fine filter flat ø 11mm H 0.25mm		
For models:	Alexia, C		

intake valves			
			
1			
GEV No.	525771	Ref. No.	800518
description	intake valve water connection 3/8"		





level glasses			
			
1			
GEV No.	529424	Ref. No.	000464
description	gasket D1 ø 18.5mm D2 ø 11mm H 13.5mm water level glass suitable for AURORA		
For models:	Alexia, C		

pressure rings			
			
1			
GEV No.	529409	Ref. No.	000506
description	press ring D1 ø 20mm D2 ø 18mm thickness 10mm		
For models:	Alexia, C		



level glass pipes			
			
1			
GEV No.	525766	Ref. No.	000319
description	water level tube ø 12mm H 155mm ID ø 8mm		
For models:	Alexia, C		

scales			
			
1			
GEV No.	526020	Ref. No.	000699
description	sticker L 119mm W 30mm Min/Max transparent		
For models:	Alexia, C		

non-return valves			
			
1			
GEV No.	526022	Ref. No.	800630
description	non-return valve T1: 3/8" T2: 3/8" T3: 1/8"		
For models:	Alexia		

knobs				
steam/water taps				
				
1				
GEV No.	111013	Ref. No.	000222	
description	knob ø 51mm thread Tr18x2 black			
For models:	C			
accessories for	111013			
	GEV No.	111008	Ref. No.	521225
knob dial plate water white				
	GEV No.	111009	Ref. No.	521224
knob dial plate steam				
	GEV No.	111277	Ref. No.	521223
nut for knob thread M24x1.5 ED ø 38mm H 21mm				

			
1			
GEV No.	111142	Ref. No.	000602 + 000.511.40.7
description	knob water		

			
1			
GEV No.	111278	Ref. No.	B-MC-0082
description	turning handle ø 48.5mm		
For models:	Alexia		
accessories for	111278		
	GEV No.	111279	Ref. No. B-MC-0058
	knob spring ø 29mm L 5mm wire gauge ø 1.1mm		
	GEV No.	551303	Ref. No. —
	cotter pin ø 1.8mm L 17mm steel Qty 20 pcs		

knob dial plates

			
1			
GEV No.	111009	Ref. No.	521224
description	knob dial plate steam		
For models:	C		

			
1			
GEV No.	111008	Ref. No.	521225
description	knob dial plate water white		
For models:	C		

accessories

			
1			
GEV No.	528762	Ref. No.	88 2211
description	cotter pin ø 1.8mm L 17mm		
For models:	Alexia, C		

			
1			
GEV No.	111142	Ref. No.	000602 + 000.511.40.7
description	knob water		

			
1			
GEV No.	111277	Ref. No.	521223
description	nut for knob thread M24x1.5 ED ø 38mm H 21mm		
For models:	C		

miscellaneous

			
1			
GEV No.	111131	Ref. No.	N/A
description	knob water		

accessories

miscellaneous

			
1			
GEV No.	111277	Ref. No.	521223
description	nut for knob thread M24x1.5 ED ø 38mm H 21mm		
For models:	C		

handles and hand wheels

lever handles

			
1			
GEV No.	111140	Ref. No.	N/A
description	lever handle plastic black suitable for AURORA		

gaskets

O-rings

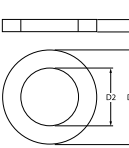
EPDM			
			
			
1			
GEV No.	528485	Ref. No.	521296
description	O-ring EPDM thickness 1.78mm ID ø 6.07mm Qty 1 pcs		
For models:	Alexia, C		



silicone

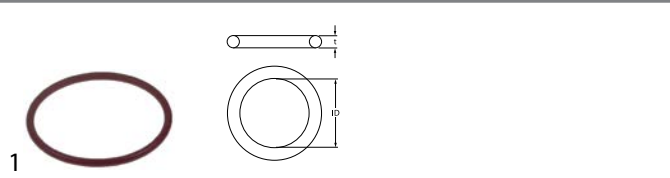

GEV No.	532586	Ref. No.	000962
description	O-ring silicone thickness 2.62mm ID ø 40.95mm Qty 1 pcs		
For models:	Alexia, C		

Viton

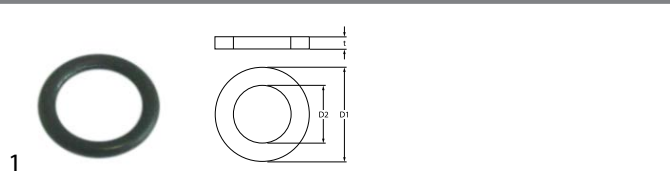

GEV No.	528291	Ref. No.	07.0610.15.80
description	O-ring Viton thickness 2.62mm ID ø 11.91mm Qty 1 pcs		
For models:	Alexia		

NBR

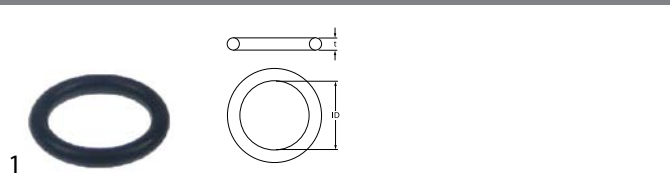

GEV No.	532587	Ref. No.	07.0610.08.30 30.000.05.88
description	O-ring NBR thickness 1.78mm ID ø 8.73mm Qty 1 pcs		

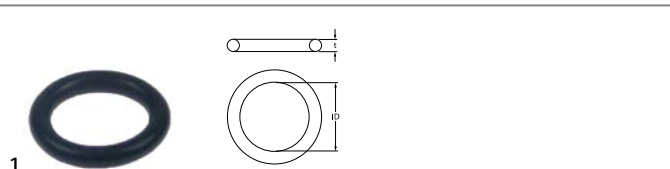

GEV No.	532585	Ref. No.	000205
description	O-ring NBR thickness 2.62mm ID ø 10.78mm Qty 1 pcs		

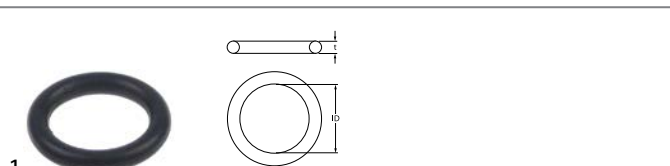

GEV No.	532557	Ref. No.	521228
description	O-ring NBR thickness 2.62mm ID ø 12.37mm Qty 1 pcs		
For models:	Alexia, C		

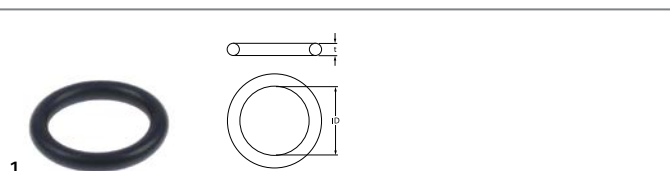

GEV No.	532556	Ref. No.	000215
description	O-ring NBR thickness 2.62mm ID ø 13.1mm Qty 1 pcs		
For models:	Alexia		

sealing washers

copper gaskets

DIN-7603-C



GEV No.	510650	Ref. No.	000466
description	gasket copper ED ø 28mm ID ø 22mm thickness 3mm Qty 1 pcs		
For models:	Alexia, C		

PTFE gaskets



GEV No.	528314	Ref. No.	521226
description	flat gasket PTFE ED ø 20mm ID ø 17mm thickness 2mm Qty 1 pcs suitable for Astoria/Azkoyen/Espresso/Wega		
For models:	Alexia, C		



GEV No.	527970	Ref. No.	000049
description	flat gasket PTFE ED ø 24mm ID ø 18mm thickness 2mm Qty 1 pcs		
For models:	Alexia		

springs

compression springs





GEV No.	528335	Ref. No.	000204
description	compression spring ø 10mm L 30mm wire gauge ø 1.6mm windings 7		





GEV No.	525768	Ref. No.	000611
description	compression spring ø 21mm L 23mm wire gauge ø 2mm windings 3		
For models:	Alexia, C		

			
1			
GEV No.	526077	Ref. No.	000361
description	compression spring \varnothing 7mm L 26mm wire gauge \varnothing 0.8mm for safety valve		
For models:	Alexia, C		

			
1			
GEV No.	528319	Ref. No.	000180
description	compression spring \varnothing 9.1mm L 15mm wire gauge \varnothing 0.6mm windings 4.5		
For models:	Alexia, C		

			
1			
GEV No.	541227	Ref. No.	N/A
description	manometer double scale \varnothing 60mm pressure range 0-2.5 / 0-16bar connection on the backside thread 1/8"		

			
1			
GEV No.	541279	Ref. No.	407312
description	manometer double scale \varnothing 63mm pressure range 0-2.5 / 0-25bar connection on the backside thread 1/8"		
For models:	Alexia		

			
1			
GEV No.	541225	Ref. No.	N/A
description	manometer \varnothing 51mm pressure range 0 up to 3bar thread 1/4" marking 2 connection on the backside		

manometers

			
1			
GEV No.	541233	Ref. No.	N/A
description	manometer double scale \varnothing 60mm pressure range 0-2.5 / 0-15bar connection on the backside thread 1/8"		

			
1			
GEV No.	541287	Ref. No.	N/A
description	manometer double scale \varnothing 60mm pressure range 0-2.5 / 0-15bar connection on the backside thread 1/8"		

			
1			
GEV No.	541222	Ref. No.	N/A
description	manometer double scale \varnothing 60mm pressure range 0-2.5 / 0-16bar connection on the backside thread 1/8"		

			
1			
GEV No.	541226	Ref. No.	N/A
description	manometer double scale \varnothing 60mm pressure range 0-2.5 / 0-16bar connection on the backside thread 1/8"		

dosing pumps

accessories

hose couplings

metal

			
1			
GEV No.	361184	Ref. No.	521381
description	nut thread 1/2" H 6mm nickel-plated brass WS 24 Qty 1 pcs		
For models:	C		

fastening material

screws

flat-headed bolts

			
1			
GEV No.	560062	Ref. No.	02.2101.04.10
description	flat-headed bolt thread M4 thread L 10mm SS DIN 7985/ISO 7045 Qty 20 pcs intake Phillips head \varnothing 8mm head thickness 2mm		



hexagonal screws

 <p>1</p>			
GEV No.	560083	Ref. No.	02.2105.05.10
description	hexagonal screw thread M5 thread L 10mm SS WS 8 Qty 20 pcs DIN 933 / ISO 4017		
For models:	Alexia, C		

cylinder head bolts

DIN 912/ISO 4762			
 <p>1</p>			
GEV No.	560025	Ref. No.	02.2102.04.10
description	cylinder head bolt thread M4 thread L 10mm WS 3 SS Qty 20 pcs DIN 912/ISO 4762		
For models:	Alexia, C		

nuts

hexagonal nuts

hexagonal nuts inch thread

 <p>1</p>			
GEV No.	361184	Ref. No.	521381
description	nut thread 1/2" H 6mm nickel-plated brass WS 24 Qty 1 pcs		
For models:	C		

fasteners

cotter pins

 <p>1</p>			
GEV No.	528762	Ref. No.	88 2211
description	cotter pin ø 1.8mm L 17mm		
For models:	Alexia, C		

B

bi-metal thermostats 4

C

cotter pins 13

cylinder head bolts 13

D

dosing pumps 12

E

electrodes 5

F

fasteners 13

fastening material 12

flat-headed bolts 12

H

heating elements 3

heating elements for coffee machine 3

hexagonal nuts 13

hexagonal screws 13

hose couplings 12

N

nuts 13

O

O-rings 10

S

safety bi-metal thermostats 4

screws 12

sealing washers 11

solenoid valves 4

T

thermostats 4