



GAS COMPONENTS



ELECTRIC COMPONENTS



WATER TECHNOLOGY



MECHANICAL COMPONENTS



TOOLS

Spare parts suitable for

ASTORIA-CMA

Find the complete and up-to-date range of products in our GEV Webshop



Manufacturer catalogue

The most important spare parts and accessories arranged clearly for every manufacturer

- ✓ Complete product range and all appliance data always up to date in the GEV Webshop
- ✓ Alphabetical Index at the end of the catalogue

GEV Webshop

www.gev-online.co.uk

www.gev-online.com









- 🔍 Add to Favourites
- 🔍 Sign In with email address and usual password
- 🔍 Easy-order – place several items in your basket at the same time
- 🔍 Quick Item search – no login needed







heating elements

heating elements for coffee machine

| | | | |
|---|---|---|--------|
|  | | | |
| GEV No. | 417006 | Ref. No. | 17201 |
| description | heating element 1300W 230V heating circuits 1 thread 1¼" L 110mm W 27mm H 30mm tube ø 6.4mm connection male faston 6.3mm immersion heater connection length 30mm flange with thread WS 37 with thread for safety thermostat | | |
| For models: | CK, CK-CKE, CK-CKE-CK-1, CK-CKE-CKE-1, CKE, CKP, CKPE, CKX-CKXE, CKX-CKXE-CKX-1, CKX-CKXE-CKXE-1 | | |
| accessories for | 417006 | | |
| |  | GEV No. | 510405 |
| | | Ref. No. | — |
| | | flat gasket fibre ED ø 56mm ID ø 42mm thickness 2mm for thread 1¼" Qty 1 pcs | |
| |  | GEV No. | 528021 |
| | | Ref. No. | — |
| | | flat gasket PTFE ED ø 53mm ID ø 42.5mm thickness 3mm Qty 1 pcs equiv. no. 12001/02286 suitable for Astoria/Aurora/Brasilia/Wega | |

| | | | |
|---|---|---|--------|
|  | | | |
| GEV No. | 417090 | Ref. No. | N/A |
| description | heating element 1450W 230V heating circuits 1 mounting ø 42mm hole distance 74mm L 132mm W 36mm H 40mm windings 3 hole ø 10mm tube ø 6.3mm connection M6 immersion heater 2 hole flange | | |
| accessories for | 417090 | | |
| |  | GEV No. | 527156 |
| | | Ref. No. | 12001 |
| | | flat gasket PTFE ED ø 57.8mm ID ø 43.3mm thickness 2mm Qty 1 pcs | |
| |  | GEV No. | 528002 |
| | | Ref. No. | 12001 |
| | | flat gasket PTFE ED ø 57mm ID ø 42mm thickness 3mm Qty 1 pcs equiv. no. 12001/W10470 suitable for | |

| | | | |
|---|---|-----------------|-------|
|  | | | |
| GEV No. | 417579 | Ref. No. | 17003 |
| description | heating element 1700W 230V heating circuits 2 mounting ø 42mm hole distance 74mm L 175mm W 35mm H 54mm L1 50mm L2 40mm L3 90mm H1 29mm H2 25mm hole ø 9.5mm tube ø 8mm thermostat sleeves ø 7mm length thermostat sleeves 140mm thermostat sleeve centre not clinging number of thermostat sleeves 1 connection M6 | | |
| For models: | Argenta, Argenta-AEP-1, Argenta-AEP-2, Argenta-AEP-3, Argenta-AEP-4, Argenta-AEP-J, Argenta-SAE-1, Argenta-SAE-2, Argenta-SAE-3, Argenta-SAE-4, Argenta-SAE-J, Brava, Brava-SME-1, Brava-SME-2, Brava-SME-3, Brava-SME-4, Brava-SMSA-1, Brava-SMSA-2, Brava-SMSA-3, Brava-SMSA-4, Denise, Divina, Divina-AEP-1, Divina-AEP-2, Divina-AEP-3, Divina-AEP-4, Divina-AEP-J, Divina-SAE-1, Divina-SAE-2, Divina-SAE-3, Divina-SAE-4, Divina-SAE-J, Dora, Gloria-AEP-1, Gloria-AEP-2, Gloria-AEP-3, Gloria-AEP-4, Gloria-DISPLAY-LCL-2, Gloria-DISPLAY-LCL-3, Gloria-SAE-1, Gloria-SAE-2, Gloria-SAE-3, Gloria-SAE-4, Rapallo-AEP-1, Rapallo-AEP-2, Rapallo-AEP-3, Rapallo-AEP-4, Vania | | |

| | | | |
|--|--|---|----------------|
|  | | | |
| GEV No. | 417039 | Ref. No. | 17002 17006 |
| description | heating element 2000W 230V heating circuits 2 mounting ø 42mm hole distance 74mm L 185mm W 30mm H 50mm L1 25mm L2 60mm L3 87mm H1 25mm H2 20mm hole ø 10.5mm tube ø 8mm connection M6 immersion heater 2 hole flange | | |
| For models: | Argenta, Argenta-AEP-1, Argenta-AEP-2, Argenta-AEP-3, Argenta-AEP-4, Argenta-AEP-J, Argenta-SAE-1, Argenta-SAE-2, Argenta-SAE-3, Argenta-SAE-4, Argenta-SAE-J, Brava, Brava-SME-1, Brava-SME-2, Brava-SME-3, Brava-SME-4, Brava-SMSA-1, Brava-SMSA-2, Brava-SMSA-3, Brava-SMSA-4, Denise, Divina, Divina-AEP-1, Divina-AEP-2, Divina-AEP-3, Divina-AEP-4, Divina-AEP-J, Divina-SAE-1, Divina-SAE-2, Divina-SAE-3, Divina-SAE-4, Divina-SAE-J, Dora, Gloria-AEP-1, Gloria-AEP-2, Gloria-AEP-3, Gloria-AEP-4, Gloria-DISPLAY-LCL-2, Gloria-DISPLAY-LCL-3, Gloria-SAE-1, Gloria-SAE-2, Gloria-SAE-3, Gloria-SAE-4, Rapallo-AEP-1, Rapallo-AEP-2, Rapallo-AEP-3, Rapallo-AEP-4, Rapallo-AL-1, Rapallo-AL-2, Rapallo-AL-3...(Other models you can see in the webshop) | | |
| accessories for | 417039 | | |
| |  | GEV No. | 528001 |
| | | Ref. No. | — |
| | | flat gasket fibre ED ø 56.5mm ID ø 41.8mm thickness 3.2mm Qty 1 pcs | |
| |  | GEV No. | 528002 |
| | | Ref. No. | 12001 |
| | | flat gasket PTFE ED ø 57mm ID ø 42mm thickness 3mm Qty 1 pcs equiv. no. 12001/W10470 suitable for | |

| | | | |
|---|--|-----------------|---------|
|  | | | |
| GEV No. | 417641 | Ref. No. | 4617006 |
| description | heating element 2177W 240V heating circuits 3 mounting ø 42mm hole distance 74mm L 180mm W 35mm H 54mm hole ø 9.5mm tube ø 8.5mm thermostat sleeves ø 7mm length thermostat sleeves 140mm thermostat sleeve centre not clinging number of thermostat sleeves 1 | | |





| | | | |
|--|---|-----------------|-------|
|  | | | |
| GEV No. | 417231 | Ref. No. | 17007 |
| description | heating element 2350W 230V heating circuits 3 mounting ø 40mm hole distance 43mm L 180mm W 30mm H 30mm hole ø 9mm thermostat sleeves ø 6mm tube ø 6mm | | |
| For models: | CompattaArgenta | | |



| | | | |
|---|--|-----------------|-------|
|  | | | |
| GEV No. | 417107 | Ref. No. | 17051 |
| description | heating element 2600W 230V heating circuits 2 mounting ø 42mm hole distance 74mm L 295mm W 36mm H 41mm L1 22mm L2 38mm L3 235mm H1 30mm H2 11mm hole ø 10mm tube ø 8.5mm thermostat sleeves ø 6mm length thermostat sleeves 186mm thermostat sleeve not clinging number of thermostat sleeves 1 connection M6x1 immersion heater 2 hole flange | | |
| For models: | Argenta, Argenta-AEP-1, Argenta-AEP-2, Argenta-AEP-3, Argenta-AEP-4, Argenta-AEP-J, Argenta-SAE-1, Argenta-SAE-2, Argenta-SAE-3, Argenta-SAE-4, Argenta-SAE-J, Brava, Brava-SME-1, Brava-SME-2, Brava-SME-3, Brava-SME-4, Brava-SMSA-1, Brava-SMSA-2, Brava-SMSA-3, Brava-SMSA-4, Denise, Divina, Divina-AEP-1, Divina-AEP-2, Divina-AEP-3, Divina-AEP-4, Divina-AEP-J, Divina-SAE-1, Divina-SAE-2, Divina-SAE-3, Divina-SAE-4, Divina-SAE-J, Dora, Gloria-AEP-1, Gloria-AEP-2, Gloria-AEP-3, Gloria-AEP-4, Gloria-DISPLAY-LCL-2, Gloria-DISPLAY-LCL-3, Gloria-SAE-1, Gloria-SAE-2, Gloria-SAE-3, Gloria-SAE-4, Rapallo-AEP-1, Rapallo-AEP-2, Rapallo-AEP-3, Rapallo-AEP-4, Rapallo-AL-1, Rapallo-AL-2, Rapallo-AL-3...(Other models you can see in the webshop) | | |

| | | | |
|---|---|-----------------|-------|
|  | | | |
| GEV No. | 417294 | Ref. No. | 17012 |
| description | heating element 2700/2950W 230/240V heating circuits 3 mounting ø 42mm hole distance 74mm L 180mm W 34mm H 47mm L1 35mm L2 50mm L3 85mm H1 31mm H2 16mm hole ø 10mm tube ø 8mm thermostat sleeves ø 6mm length thermostat sleeves 158mm thermostat sleeve centre not clinging number of thermostat sleeves 1 connection M3 immersion heater 2 hole flange | | |
| For models: | CMA, Giada-1, Giada-2, Rapallo-AL-1, Rapallo-AL-2, Rapallo-AL-3, Rapallo-AL-4, Sara-1GR-1, Sara-2GR-2, Sibilla-AEP-1, Sibilla-AEP-2, Sibilla-AEP-3, Sibilla-DISPLAY-2, Sibilla-DISPLAY-3, Sibilla-SAE-1, Sibilla-SAE-2, Sibilla-SAE-3 | | |

| | | | |
|---|--|-----------------|-------|
|  | | | |
| GEV No. | 417233 | Ref. No. | 17058 |
| description | heating element 3000W 230V heating circuits 3 mounting ø 42mm hole distance 74mm L 315mm W 30mm H 45mm L1 30mm L2 60mm L3 225mm H1 31mm H2 14mm hole ø 9.5mm tube ø 8mm thermostat sleeves ø 6mm length thermostat sleeves 150mm | | |
| For models: | Argenta-AEP-1, Argenta-AEP-2, Argenta-AEP-3, Argenta-AEP-4, Argenta-AEP-J, Argenta-SAE-1, Argenta-SAE-2, Argenta-SAE-3, Argenta-SAE-4, Argenta-SAE-J, Brava-SME-1, Brava-SME-2, Brava-SME-3, Brava-SME-4, Brava-SMSA-1, Brava-SMSA-2, Brava-SMSA-3, Brava-SMSA-4, Divina-AEP-1, Divina-AEP-2, Divina-AEP-3, Divina-AEP-4, Divina-AEP-J, Divina-SAE-1, Divina-SAE-2, Divina-SAE-3, Divina-SAE-4, Divina-SAE-J, Gloria-AEP-1, Gloria-AEP-2, Gloria-AEP-3, Gloria-AEP-4, Gloria-DISPLAY-LCL-2, Gloria-DISPLAY-LCL-3, Gloria-SAE-1, Gloria-SAE-2, Gloria-SAE-3, Gloria-SAE-4, Rapallo-AEP-1, Rapallo-AEP-2, Rapallo-AEP-3, Rapallo-AEP-4, Rapallo-AL-1, Rapallo-AL-2, Rapallo-AL-3, Rapallo-AL-4 | | |

| | | | |
|--|--|---|-----------------------|
|  | | | |
| GEV No. | 417000 | Ref. No. | 17059 |
| description | heating element 3400W 230V heating circuits 3 mounting ø 43mm hole distance 74mm L 315mm W 35mm H 38mm L1 35mm L2 65mm L3 205mm H1 31mm H2 7mm hole ø 9.2mm tube ø 8.3mm thermostat sleeves ø 6mm length thermostat sleeves 155mm thermostat sleeve centre number of thermostat sleeves 1 connection M3 immersion heater 2 hole flange | | |
| For models: | Argenta-AEP-1, Argenta-AEP-2, Argenta-AEP-3, Argenta-AEP-4, Argenta-AEP-J, Argenta-SAE-1, Argenta-SAE-2, Argenta-SAE-3, Argenta-SAE-4, Argenta-SAE-J, Brava-SME-1, Brava-SME-2, Brava-SME-3, Brava-SME-4, Brava-SMSA-1, Brava-SMSA-2, Brava-SMSA-3, Brava-SMSA-4, Divina-AEP-1, Divina-AEP-2, Divina-AEP-3, Divina-AEP-4, Divina-AEP-J, Divina-SAE-1, Divina-SAE-2, Divina-SAE-3, Divina-SAE-4, Divina-SAE-J, Gloria-AEP-1, Gloria-AEP-2, Gloria-AEP-3, Gloria-AEP-4, Gloria-DISPLAY-LCL-2, Gloria-DISPLAY-LCL-3, Gloria-SAE-1, Gloria-SAE-2, Gloria-SAE-3, Gloria-SAE-4, Rapallo-AEP-1, Rapallo-AEP-2, Rapallo-AEP-3, Rapallo-AEP-4, Rapallo-AL-1, Rapallo-AL-2, Rapallo-AL-3, Rapallo-AL-4, Sibilla-AEP-1, Sibilla-AEP-2, Sibilla-AEP-3, Sibilla-DISPLAY-2...(Other models you can see in the webshop) | | |
| accessories for | 417000 | | |
| |  | GEV No. 527156 | Ref. No. 12001 |
| | | flat gasket PTFE ED ø 57.8mm ID ø 43.3mm thickness 2mm Qty 1 pcs | |
| |  | GEV No. 527169 | Ref. No. 23050 |
| | | hexagonal nut thread M3 H 2.8mm WS 5.5 brass Qty 1 pcs | |
| |  | GEV No. 560110 | Ref. No. — |
| | | plain washer ID ø 3.2mm ED ø 7mm thickness 0.5mm SS Qty 20 pcs DIN 125A for thread M3 | |
| |  | GEV No. 560130 | Ref. No. — |
| | | hexagonal nut thread M3 H 2.4mm WS 5.5 SS DIN/ISO DIN 934 / ISO 4032/8673 Qty 20 pcs | |

| | | | |
|--|--|-----------------|-------|
|  | | | |
| GEV No. | 417463 | Ref. No. | 17017 |
| description | heating element 3400W 230V heating circuits 3 mounting ø 43mm hole distance 75mm L 215mm W 34mm H 45mm L1 35mm L2 65mm L3 115mm H1 31mm H2 14mm hole ø 9.5mm tube ø 8.2mm thermostat sleeves ø 6mm length thermostat sleeves 157mm thermostat sleeve centre not clinging number of thermostat sleeves 1 connection M3 immersion heater 2 hole flange | | |
| For models: | Giada-1, Giada-2, Sara-1GR-1, Sara-2GR-2 | | |

| | | | |
|--|--|-----------------|-------|
|  | | | |
| GEV No. | 417064 | Ref. No. | 17101 |
| description | heating element 3700W 230V heating circuits 2 mounting ø 42mm hole distance 75mm L 575mm W 34mm H 47mm L1 27mm L2 38mm L3 510mm H1 20mm H2 27mm hole ø 10mm connection M4 immersion heater 2 hole fixing | | |
| For models: | Argenta, Argenta-AEP-1, Argenta-AEP-2, Argenta-AEP-3, Argenta-AEP-4, Argenta-AEP-J, Argenta-SAE-1, Argenta-SAE-2, Argenta-SAE-3, Argenta-SAE-4, Argenta-SAE-J, Brava, Brava-SME-1, Brava-SME-2, Brava-SME-3, Brava-SME-4, Brava-SMSA-1, Brava-SMSA-2, Brava-SMSA-3, Brava-SMSA-4, Denise, Divina, Divina-AEP-1, Divina-AEP-2, Divina-AEP-3, Divina-AEP-4, Divina-AEP-J, Divina-SAE-1, Divina-SAE-2, Divina-SAE-3, Divina-SAE-4, Divina-SAE-J, Dora, Gloria-AEP-1, Gloria-AEP-2, Gloria-AEP-3, Gloria-AEP-4, Gloria-DISPLAY-LCL-2, Gloria-DISPLAY-LCL-3, Gloria-SAE-1, Gloria-SAE-2, Gloria-SAE-3, Gloria-SAE-4, Rapallo-AEP-1, Rapallo-AEP-2, Rapallo-AEP-3, Rapallo-AEP-4, Rapallo-AL-1, Rapallo-AL-2, Rapallo-AL-3...(Other models you can see in the webshop) | | |





| | | | |
|---|--|-----------------|-------|
|  | | | |
| 1 | | | |
| GEV No. | 417088 | Ref. No. | 17104 |
| description | heating element 3700W 230V heating circuits 3 mounting ø 42mm hole distance 74mm L 570mm W 35mm H 46mm L1 30mm L2 50mm L3 485mm H1 34mm H2 12mm hole ø 9mm tube ø 8.5mm thermostat sleeves ø 6mm length thermostat sleeves 160mm thermostat sleeve centre not clinging number of thermostat sleeves 1 connection M3 immersion heater 2 hole flange | | |
| For models: | Argenta, Argenta-AEP-1, Argenta-AEP-2, Argenta-AEP-3, Argenta-AEP-4, Argenta-AEP-J, Argenta-SAE-1, Argenta-SAE-2, Argenta-SAE-3, Argenta-SAE-4, Argenta-SAE-J, Brava, Brava-SME-1, Brava-SME-2, Brava-SME-3, Brava-SME-4, Brava-SMSA-1, Brava-SMSA-2, Brava-SMSA-3, Brava-SMSA-4, Denise, Divina, Divina-AEP-1, Divina-AEP-2, Divina-AEP-3, Divina-AEP-4, Divina-AEP-J, Divina-SAE-1, Divina-SAE-2, Divina-SAE-3, Divina-SAE-4, Divina-SAE-J, Dora, Gloria-AEP-1, Gloria-AEP-2, Gloria-AEP-3, Gloria-AEP-4, Gloria-DISPLAY-LCL-2, Gloria-DISPLAY-LCL-3, Gloria-SAE-1, Gloria-SAE-2, Gloria-SAE-3, Gloria-SAE-4, Rapallo-AEP-1, Rapallo-AEP-2, Rapallo-AEP-3, Rapallo-AEP-4, Rapallo-AL-1, Rapallo-AL-2, Rapallo-AL-3...(Other models you can see in the webshop) | | |

| | | | |
|--|--|-----------------|-------|
|  | | | |
| 1 | | | |
| GEV No. | 417580 | Ref. No. | 17106 |
| description | heating element 5000W 230V heating circuits 2 mounting ø 42mm hole distance 74mm L 570mm W 32mm H 44mm L1 40mm L2 35mm L3 495mm H1 34mm H2 12mm hole ø 9mm tube ø 8.5mm thermostat sleeves ø 1mm length thermostat sleeves 160mm thermostat sleeve centre not clinging number of thermostat sleeves 1 connection M6 immersion heater 2 hole flange | | |
| For models: | Argenta, Argenta-AEP-1, Argenta-AEP-2, Argenta-AEP-3, Argenta-AEP-4, Argenta-AEP-J, Argenta-SAE-1, Argenta-SAE-2, Argenta-SAE-3, Argenta-SAE-4, Argenta-SAE-J, Brava, Brava-SME-1, Brava-SME-2, Brava-SME-3, Brava-SME-4, Brava-SMSA-1, Brava-SMSA-2, Brava-SMSA-3, Brava-SMSA-4, Denise, Divina, Divina-AEP-1, Divina-AEP-2, Divina-AEP-3, Divina-AEP-4, Divina-AEP-J, Divina-SAE-1, Divina-SAE-2, Divina-SAE-3, Divina-SAE-4, Divina-SAE-J, Dora, Gloria-AEP-1, Gloria-AEP-2, Gloria-AEP-3, Gloria-AEP-4, Gloria-DISPLAY-LCL-2, Gloria-DISPLAY-LCL-3, Gloria-SAE-1, Gloria-SAE-2, Gloria-SAE-3, Gloria-SAE-4, Rapallo-AEP-1, Rapallo-AEP-2, Rapallo-AEP-3, Rapallo-AEP-4, Rapallo-AL-1, Rapallo-AL-2, Rapallo-AL-3...(Other models you can see in the webshop) | | |

| | | | |
|---|--|-----------------|--------|
|  | | | |
| 1 | | | |
| GEV No. | 419174 | Ref. No. | 17057 |
| description | heating element 4000/4355W 230/240V heating circuits 3 mounting ø 42mm hole distance 75mm L 315mm W 38mm H 45mm L1 33mm L2 62mm L3 220mm H1 31mm H2 14mm hole ø 9.5mm tube ø 8.5mm thermostat sleeves ø 6mm length thermostat sleeves 157mm thermostat sleeve centre not clinging number of thermostat sleeves 1 connection M3 immersion heater 2 hole flange | | |
| For models: | Argenta, Argenta-AEP-1, Argenta-AEP-2, Argenta-AEP-3, Argenta-AEP-4, Argenta-AEP-J, Argenta-SAE-1, Argenta-SAE-2, Argenta-SAE-3, Argenta-SAE-4, Argenta-SAE-J, Brava, Brava-SME-1, Brava-SME-2, Brava-SME-3, Brava-SME-4, Brava-SMSA-1, Brava-SMSA-2, Brava-SMSA-3, Brava-SMSA-4, Denise, Divina, Divina-AEP-1, Divina-AEP-2, Divina-AEP-3, Divina-AEP-4, Divina-AEP-J, Divina-SAE-1, Divina-SAE-2, Divina-SAE-3, Divina-SAE-4, Divina-SAE-J, Dora, Gloria-AEP-1, Gloria-AEP-2, Gloria-AEP-3, Gloria-AEP-4, Gloria-DISPLAY-LCL-2, Gloria-DISPLAY-LCL-3, Gloria-SAE-1, Gloria-SAE-2, Gloria-SAE-3, Gloria-SAE-4, Rapallo-AEP-1, Rapallo-AEP-2, Rapallo-AEP-3, Rapallo-AEP-4, Rapallo-AL-1, Rapallo-AL-2, Rapallo-AL-3...(Other models you can see in the webshop) | | |
| accessories for | 419174 | | |
| |  | GEV No. | 528002 |
| | | Ref. No. | 12001 |
| | flat gasket PTFE ED ø 57mm ID ø 42mm thickness 3mm Qty 1 pcs equiv. no. 12001/W10470 suitable for | | |

| | | | |
|--|--|-----------------|---------|
|  | | | |
| 1 | | | |
| GEV No. | 527770 | Ref. No. | WY17107 |
| description | heating element 5000W 230V heating circuits 3 mounting ø 42mm hole distance 74mm L 570mm W 32mm H 50mm L1 35mm L2 60mm L3 475mm H1 35mm H2 18mm hole ø 9mm tube ø 8mm thermostat sleeves ø 6mm length thermostat sleeves 148mm | | |

| | | | |
|--|--|-----------------|-------------------|
|  | | | |
| 1 | | | |
| GEV No. | 417230 | Ref. No. | 17052 17052001 |
| description | heating element 6000W 230V heating circuits 3 mounting ø 40mm hole distance 43mm L 575mm W 33mm H 33mm hole ø 9mm thermostat sleeves ø 6mm length thermostat sleeves 140mm number of thermostat sleeves 1 tube ø 8.5mm | | |

| | | | |
|--|---|-----------------|-------------------|
|  | | | |
| 1 | | | |
| GEV No. | 417234 | Ref. No. | 17102 17102001 |
| description | heating element 6000W 230V heating circuits 3 mounting ø 40mm hole distance 43mm L 575mm W 33mm H 33mm hole ø 9mm thermostat sleeves ø 6mm length thermostat sleeves 150mm tube ø 8mm | | |

| | | | |
|---|---|-----------------|---------|
|  | | | |
| 1 | | | |
| GEV No. | 527771 | Ref. No. | WY17060 |
| description | heating element 4500W 230V heating circuits 3 mounting ø 42mm hole distance 74mm L 325mm W 32mm H 50mm L1 35mm L2 55mm L3 225mm H1 32mm H2 18mm hole ø 10mm tube ø 8mm thermostat sleeves ø 6mm length thermostat sleeves 148mm | | |

| | | | |
|---|---|-----------------|-------|
|  | | | |
| 1 | | | |
| GEV No. | 417162 | Ref. No. | 17301 |
| description | heating element 800W 230V heating circuits 1 ø 55mm flange 11.5x27mm H 55mm H1 25mm H2 30mm connection male faston 6.3mm compression flange tube ø 6.3mm immersion heater | | |
| For models: | Prima | | |



heating cartridges



| | | | |
|--------------------|---|-----------------|-------|
| GEV No. | 417465 | Ref. No. | 17509 |
| description | heating cartridge 10W 24V ø 6.4mm L 32mm cable length 600mm dry heating element | | |
| For models: | DPiu-1, Giada-1, Giada-2, Sara-1GR-1, Sara-2GR-2 | | |



| | | | |
|--------------------|---|-----------------|-------|
| GEV No. | 417464 | Ref. No. | 17507 |
| description | heating cartridge 150W 230V ø 6.4mm L 53mm cable length 600mm | | |
| For models: | CMA, DPiu-1, Giada-1, Giada-2, Sara-1GR-1, Sara-2GR-2 | | |

thermostats

bi-metal thermostats

safety bi-metal thermostats



| | | | |
|--------------------|---|-----------------|-------|
| GEV No. | 390434 | Ref. No. | 20301 |
| description | bi-metal safety thermostat hole distance 37mm switch-off temp. 145°C 2NC 2-pole 20A connection F6.3 2 hole fixing | | |
| For models: | Argenta | | |





| | | | |
|--------------------|--|-----------------|-------|
| GEV No. | 390370 | Ref. No. | 20304 |
| description | bi-metal safety thermostat hole distance 37mm switch-off temp. 145°C 1NC 1-pole 16A connection F6.3 M4 | | |
| For models: | CK, CK-CKE, CK-CKE-CK-1, CK-CKE-CKE-1, CKE, CKP, CKPE, CKX-CKXE, CKX-CKXE-CKX-1, CKX-CKXE-CKXE-1 | | |

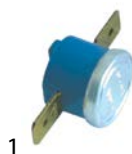

| | | | |
|--------------------|---|-----------------|----------|
| GEV No. | 390432 | Ref. No. | 20300008 |
| description | bi-metal safety thermostat switch-off temp. 120°C 3NC 3-pole 25A connection M5 | | |
| For models: | Argenta-AEP-1, Argenta-AEP-2, Argenta-AEP-3, Argenta-AEP-4, Argenta-AEP-J, Argenta-SAE-1, Argenta-SAE-2, Argenta-SAE-3, Argenta-SAE-4, Argenta-SAE-J, Brava, Brava-SME-1, Brava-SME-2, Brava-SME-3, Brava-SME-4, Brava-SMSA-1, Brava-SMSA-2, Brava-SMSA-3, Brava-SMSA-4, CK-CKE-CK-1, CK-CKE-CKE-1, CKX-CKXE-CKX-1, CKX-CKXE-CKXE-1, CompattaArgenta, Denise, Divina, Divina-AEP-1, Divina-AEP-2, Divina-AEP-3, Divina-AEP-4, Divina-AEP-J, Divina-SAE-1, Divina-SAE-2, Divina-SAE-3, Divina-SAE-4, Divina-SAE-J, Gloria-AEP-1, Gloria-AEP-2, Gloria-AEP-3, Gloria-AEP-4, Gloria-DISPLAY-LCL-2, Gloria-DISPLAY-LCL-3, Gloria-SAE-1, Gloria-SAE-2, Gloria-SAE-3, Gloria-SAE-4, Vania | | |

bi-metal thermostats



| | | | |
|---|--|-----------------|-------------------|
| GEV No. | 390436 | Ref. No. | 20300009 |
| description | bi-metal thermostat hole distance 37mm switch-off temp. 100°C 1NC 1-pole 16A connection F6.3 | | |
| For models: | Prima | | |
| accessories for | 390436 | | |
|  | GEV No. | 550389 | Ref. No. — |
| bracket for contact thermostat | | | |



| | | | |
|---|--|-----------------|-------------------|
| GEV No. | 390435 | Ref. No. | 20300011 |
| description | bi-metal thermostat hole distance 37mm switch-off temp. 170°C 1NC 1-pole 16A connection F6.3 | | |
| accessories for | 390435 | | |
|  | GEV No. | 550389 | Ref. No. — |
| bracket for contact thermostat | | | |



| | | | |
|--------------------|--|-----------------|----------|
| GEV No. | 390727 | Ref. No. | 20300011 |
| description | bi-metal thermostat hole distance 37mm switch-off temp. 180°C 1NC 1-pole AV connection F6.3 ø 16mm | | |
| For models: | DPiu-1, Prima | | |

control and safety thermostats

EGO

safety thermostats

55.32_ series



| | | | |
|--------------------|---|-----------------|----------|
| GEV No. | 390324 | Ref. No. | 20300015 |
| description | safety thermostat switch-off temp. 169°C 3-pole 3NC 20A probe ø 4mm probe L 128mm capillary pipe 890mm capillary pipe isolated 210/210mm gland nut probe SS | | |



55.33_series



| | | | |
|--------------------|---|-----------------|------------|
| GEV No. | 390883 | Ref. No. | WY20300019 |
| description | safety thermostat switch-off temp. 160°C 3-pole 20A probe ø 4mm probe L 155mm capillary pipe 880mm capillary pipe isolated 350mm gland nut probe SS | | |

IMIT / TEMPOMATIC / ARTHERMO

control thermostats

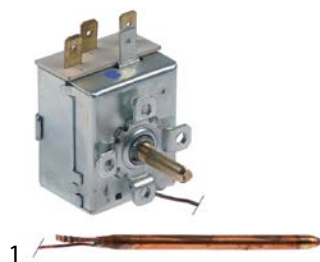

| | | | |
|--------------------|--|-----------------|---------------------|
| GEV No. | 375280 | Ref. No. | 20314 (alternative) |
| description | thermostat t.max. 86°C temperature range 0-86°C 1-pole 1CO 16A probe ø 6.5mm probe L 98mm capillary pipe 920mm capillary pipe isolatedmm gland nut shaft ø 6x4.6mm shaft L 20mm shaft position +135° rotation 270° probe material copper | | |



| | | | |
|--------------------|---|-----------------|-------|
| GEV No. | 375847 | Ref. No. | 20314 |
| description | thermostat t.max. 90°C temperature range 0-90°C 1-pole 1CO 15A probe ø 6.5mm probe L 100mm capillary pipe 1500mm capillary pipe isolatedmm gland nut shaft ø 6x4.6mm shaft L 18mm shaft position +135° rotation 270° 250V | | |
| For models: | Sibilla-AEP-1, Sibilla-AEP-2, Sibilla-AEP-3, Sibilla-DISPLAY-2, Sibilla-DISPLAY-3, Sibilla-SAE-1, Sibilla-SAE-2, Sibilla-SAE-3 | | |

rod thermostats

safety rod thermostats



| | | | |
|--------------------|--|-----------------|-------|
| GEV No. | 390433 | Ref. No. | 20302 |
| description | safety rod thermostat switch-off temp. 145°C temperature range 0-145°C 2-pole 2NC 20A probe ø 8mm probe L 187mm capillary pipemm capillary pipe isolatedmm gland nut shaft ømm thermostat sleeves ø 16mm length thermostat sleeves 200mm | | |
| For models: | Argenta, Argenta-AEP-1, Argenta-AEP-2, Argenta-AEP-3, Argenta-AEP-4, Argenta-AEP-J, Argenta-SAE-1, Argenta-SAE-2, Argenta-SAE-3, Argenta-SAE-4, Argenta-SAE-J, Brava, Brava-SME-1, Brava-SME-2, Brava-SME-3, Brava-SME-4, Brava-SMSA-1, Brava-SMSA-2, Brava-SMSA-3, Brava-SMSA-4, CK-CKE-CK-1, CK-CKE-CKE-1, CKX-CKXE-CKX-1, CKX-CKXE-CKXE-1, CompattaArgenta, Denise, Divina, Divina-AEP-1, Divina-AEP-2, Divina-AEP-3, Divina-AEP-4, Divina-AEP-J, Divina-SAE-1, Divina-SAE-2, Divina-SAE-3, Divina-SAE-4, Divina-SAE-J, Dora, Gloria-AEP-1, Gloria-AEP-2, Gloria-AEP-3, Gloria-AEP-4, Gloria-DISPLAY-LCL-2, Gloria-DISPLAY-LCL-3, Gloria-SAE-1, Gloria-SAE-2, Gloria-SAE-3, Gloria-SAE-4, Vania | | |



| | | | |
|--------------------|--|-----------------|---------|
| GEV No. | 391022 | Ref. No. | 2030005 |
| description | safety rod thermostat switch-off temp. 145°C temperature range 0-145°C 3-pole 3NC 20A probe ø 8mm probe L 187mm capillary pipemm capillary pipe isolatedmm gland nut shaft ømm thermostat sleeves ø 16mm length thermostat sleeves 200mm | | |

switches and momentary switches



rocker/momentary rocker switches

30x22mm





| | | | |
|--------------------|---|-----------------|----------------|
| GEV No. | 301020 | Ref. No. | 18266 18268 |
| description | momentary rocker switch mounting measurements 30x22mm red 2NO 250V 16A illuminated 0-1 connection male faston 6.3mm ambient temperature max. 100/55°C protection IP65 | | |
| For models: | CK, CK-CKE-CK-1, CK-CKE-CKE-1, CKE, CKX-CKXE, CKX-CKXE-CKX-1, CKX-CKXE-CKXE-1 | | |



| | | | |
|---|---|-----------------|-----------------------|
|  | | | |
| 1 | | | |
| GEV No. | 301001 | Ref. No. | 18260 |
| description | rocker switch mounting measurements 30x22mm red 2NO 250V 16A illuminated 0-I connection male faston 6.3mm ambient temperature max. 125/55°C protection IP65 | | |
| For models: | Argenta, Argenta-AEP-1, Argenta-AEP-2, Argenta-AEP-3, Argenta-AEP-4, Argenta-AEP-J, Argenta-SAE-1, Argenta-SAE-2, Argenta-SAE-3, Argenta-SAE-4, Argenta-SAE-J, Brava, Brava-SME-1, Brava-SME-2, Brava-SME-3, Brava-SME-4, Brava-SMSA-1, Brava-SMSA-2, Brava-SMSA-3, Brava-SMSA-4, CK, CK-CKE, CK-CKE-CK-1, CK-CKE-CKE-1, CKE, CKP, CKPE, CKX-CKXE, CKX-CKXE-CKX-1, CKX-CKXE-CKXE-1, Coffee-Grinder-R, Coffee-grinder-R-1, CompattaArgenta, Denise, Divina, Divina-AEP-1, Divina-AEP-2, Divina-AEP-3, Divina-AEP-4, Divina-AEP-J, Divina-SAE-1, Divina-SAE-2, Divina-SAE-3, Divina-SAE-4, Divina-SAE-J, Dora, Giada-1, Giada-2, Rapallo-AEP-1, Rapallo-AEP-2...(Other models you can see in the webshop) | | |
| accessories for | 301001 | | |
|  | GEV No. | 301036 | Ref. No. 19049 |
| | protective cover internal size 30x22mm for rocker switch mounting measurementsmm | | |

| | | | |
|---|--|-----------------|-------|
|  | | | |
| 1 | | | |
| GEV No. | 301036 | Ref. No. | 19049 |
| description | protective cover internal size 30x22mm for rocker switch mounting measurementsmm | | |
| For models: | Argenta-AEP-1, Argenta-AEP-2, Argenta-AEP-3, Argenta-AEP-4, Argenta-AEP-J, Argenta-SAE-1, Argenta-SAE-2, Argenta-SAE-3, Argenta-SAE-4, Argenta-SAE-J, Brava-SME-1, Brava-SME-2, Brava-SME-3, Brava-SME-4, Brava-SMSA-1, Brava-SMSA-2, Brava-SMSA-3, Brava-SMSA-4, CK, CK-CKE, CK-CKE-CK-1, CK-CKE-CKE-1, CKE, CKP, CKPE, CKX-CKXE, CKX-CKXE-CKX-1, CKX-CKXE-CKXE-1, CMA, CompattaArgenta, Divina, Divina-AEP-1, Divina-AEP-2, Divina-AEP-3, Divina-AEP-4, Divina-AEP-J, Divina-SAE-1, Divina-SAE-2, Divina-SAE-3, Divina-SAE-4, Divina-SAE-J, Giada-1, Giada-2, Gloria-AEP-1, Gloria-AEP-2, Gloria-AEP-3, Gloria-AEP-4, Gloria-DISPLAY-LCL-2, Gloria-DISPLAY-LCL-3, Gloria-SAE-1...(Other models you can see in the webshop) | | |

| | | | |
|---|--|-----------------|-----------------------|
|  | | | |
| 1 | | | |
| GEV No. | 301009 | Ref. No. | 18262 |
| description | rocker switch mounting measurements 30x22mm white 2NO 250V 16A illuminated 0-I connection male faston 6.3mm ambient temperature max. 125/55°C protection IP65 | | |
| For models: | Argenta, Argenta-AEP-1, Argenta-AEP-2, Argenta-AEP-3, Argenta-AEP-4, Argenta-AEP-J, Argenta-SAE-1, Argenta-SAE-2, Argenta-SAE-3, Argenta-SAE-4, Argenta-SAE-J, Brava, Brava-SME-1, Brava-SME-2, Brava-SME-3, Brava-SME-4, Brava-SMSA-1, Brava-SMSA-2, Brava-SMSA-3, Brava-SMSA-4, CompattaArgenta, Denise, Divina-AEP-1, Divina-AEP-2, Divina-AEP-3, Divina-AEP-4, Divina-AEP-J, Divina-SAE-1, Divina-SAE-2, Divina-SAE-3, Divina-SAE-4, Divina-SAE-J, Rapallo-AEP-1, Rapallo-AEP-2, Rapallo-AEP-3, Rapallo-AEP-4, Rapallo-AL-1, Rapallo-AL-2, Rapallo-AL-3, Rapallo-AL-4, Sibilla-AEP-1, Sibilla-AEP-2, Sibilla-AEP-3, Sibilla-DISPLAY-2, Sibilla-DISPLAY-3, Sibilla-SAE-1, Sibilla-SAE-2, Sibilla-SAE-3, Vania | | |
| accessories for | 301009 | | |
|  | GEV No. | 301036 | Ref. No. 19049 |
| | protective cover internal size 30x22mm for rocker switch mounting measurementsmm | | |

| | | | |
|---|---|-----------------|-------|
|  | | | |
| 1 | | | |
| GEV No. | 301249 | Ref. No. | 18135 |
| description | rocker switch mounting measurements 30x22mm red 2CO 250V 16A I O connection male faston 6.3mm ambient temperature max. 125/55°C protection IP40 | | |
| For models: | CK, CK-CKE, CK-CKE-CK-1, CK-CKE-CKE-1, CKE, CKP, CKPE, CKX-CKXE, CKX-CKXE-CKX-1, CKX-CKXE-CKXE-1 | | |

push/momentary push switches

30x22mm

| | | | |
|---|--|-----------------|-------|
|  | | | |
| 1 | | | |
| GEV No. | 301036 | Ref. No. | 19049 |
| description | protective cover internal size 30x22mm for rocker switch mounting measurementsmm | | |
| For models: | Argenta-AEP-1, Argenta-AEP-2, Argenta-AEP-3, Argenta-AEP-4, Argenta-AEP-J, Argenta-SAE-1, Argenta-SAE-2, Argenta-SAE-3, Argenta-SAE-4, Argenta-SAE-J, Brava-SME-1, Brava-SME-2, Brava-SME-3, Brava-SME-4, Brava-SMSA-1, Brava-SMSA-2, Brava-SMSA-3, Brava-SMSA-4, CK, CK-CKE, CK-CKE-CK-1, CK-CKE-CKE-1, CKE, CKP, CKPE, CKX-CKXE, CKX-CKXE-CKX-1, CKX-CKXE-CKXE-1, CMA, CompattaArgenta, Divina, Divina-AEP-1, Divina-AEP-2, Divina-AEP-3, Divina-AEP-4, Divina-AEP-J, Divina-SAE-1, Divina-SAE-2, Divina-SAE-3, Divina-SAE-4, Divina-SAE-J, Giada-1, Giada-2, Gloria-AEP-1, Gloria-AEP-2, Gloria-AEP-3, Gloria-AEP-4, Gloria-DISPLAY-LCL-2, Gloria-DISPLAY-LCL-3, Gloria-SAE-1...(Other models you can see in the webshop) | | |

| | | | |
|---|---|-----------------|-------|
|  | | | |
| 1 | | | |
| GEV No. | 301015 | Ref. No. | 18135 |
| description | rocker switch mounting measurements 30x22mm red 2CO 250V 16A illuminated connection male faston 6.3mm ambient temperature max. 125/55°C protection IP40 | | |

| | | | |
|---|--|-----------------|-------|
|  | | | |
| 1 | | | |
| GEV No. | 301060 | Ref. No. | 18263 |
| description | rocker switch mounting measurements 30x22mm red 2NO 250V 16A illuminated connection male faston 6.3mm ambient temperature max. 125/55°C protection IP40 | | |
| For models: | DPiu-1, ELE-03, Giada-Fridge-Cup-warmer-1, Gloria-AEP-1, Gloria-AEP-2, Gloria-AEP-3, Gloria-AEP-4, Gloria-DISPLAY-LCL-2, Gloria-DISPLAY-LCL-3, Gloria-SAE-1, Gloria-SAE-2, Gloria-SAE-3, Gloria-SAE-4, Prima, Sara-Fridge-Cup-warmer | | |



ø25mm



1

| | | | |
|--------------------|--|-----------------|-------|
| GEV No. | 347264 | Ref. No. | 18245 |
| description | momentary push switch mounting ø 25mm white 1NO 250V 16A connection male faston 6.3mm ambient temperature max. 85°C protection IP40 | | |
| For models: | Argenta-AEP-1, Argenta-AEP-2, Argenta-AEP-3, Argenta-AEP-4, Argenta-AEP-J, Argenta-SAE-1, Argenta-SAE-2, Argenta-SAE-3, Argenta-SAE-4, Argenta-SAE-J, Brava, Brava-SME-1, Brava-SME-2, Brava-SME-3, Brava-SME-4, Brava-SMSA-1, Brava-SMSA-2, Brava-SMSA-3, Brava-SMSA-4, CompattaArgenta, Divina-AEP-1, Divina-AEP-2, Divina-AEP-3, Divina-AEP-4, Divina-AEP-J, Divina-SAE-1, Divina-SAE-2, Divina-SAE-3, Divina-SAE-4, Divina-SAE-J, Rapallo-AEP-1, Rapallo-AEP-2, Rapallo-AEP-3, Rapallo-AEP-4, Rapallo-AL-1, Rapallo-AL-2, Rapallo-AL-3, Rapallo-AL-4, Sibilla-AEP-1, Sibilla-AEP-2, Sibilla-AEP-3, Sibilla-DISPLAY-2, Sibilla-DISPLAY-3, Sibilla-SAE-1, Sibilla-SAE-2, Sibilla-SAE-3 | | |



2

| | | | |
|--------------------|---|-----------------|-------|
| GEV No. | 345037 | Ref. No. | 18245 |
| description | push switch mounting ø 25mm red 2NO 250V 16A connection male faston 6.3mm ambient temperature max. 85°C protection IP40 | | |

accessories

push buttons



1

| | | | |
|---|--|-----------------|----------|
| GEV No. | 347183 | Ref. No. | 15373060 |
| description | push button mounting ø 14.3mm chrome-plated | | |
| For models: | Gloria-AEP-1, Gloria-AEP-2, Gloria-AEP-3, Gloria-AEP-4, Gloria-DISPLAY-LCL-2, Gloria-DISPLAY-LCL-3, Gloria-SAE-1, Gloria-SAE-2, Gloria-SAE-3, Gloria-SAE-4 | | |
| accessories for | 347183 | | |
| | GEV No. | Ref. No. | 18371057 |
|  | switch 2NO 250V 16A connection male faston 6.3mm | | |



1

| | | | |
|--------------------|--|-----------------|----------|
| GEV No. | 347184 | Ref. No. | 15373059 |
| description | push button mounting ø 14.3mm chrome-plated | | |
| For models: | Gloria-AEP-1, Gloria-AEP-2, Gloria-AEP-3, Gloria-AEP-4, Gloria-DISPLAY-LCL-2, Gloria-DISPLAY-LCL-3, Gloria-SAE-1, Gloria-SAE-2, Gloria-SAE-3, Gloria-SAE-4 | | |

toggle switches

M6



1

| | | | |
|--------------------|---|-----------------|--------|
| GEV No. | 347196 | Ref. No. | 22723C |
| description | toggle switch thread M6x0.75 1CO 250V 3A ON-OFF plug cable material silicone plug type coded cable length 1000mm | | |
| For models: | Argenta-AEP-1, Argenta-AEP-2, Argenta-AEP-3, Argenta-AEP-4, Argenta-AEP-J, Argenta-SAE-1, Argenta-SAE-2, Argenta-SAE-3, Argenta-SAE-4, Argenta-SAE-J, Brava, Brava-SME-1, Brava-SME-2, Brava-SME-3, Brava-SME-4, Brava-SMSA-1, Brava-SMSA-2, Brava-SMSA-3, Brava-SMSA-4, CompattaArgenta, Divina, Divina-AEP-1, Divina-AEP-2, Divina-AEP-3, Divina-AEP-4, Divina-AEP-J, Divina-SAE-1, Divina-SAE-2, Divina-SAE-3, Divina-SAE-4, Divina-SAE-J, Rapallo-AEP-1, Rapallo-AEP-2, Rapallo-AEP-3, Rapallo-AEP-4, Rapallo-AL-1, Rapallo-AL-2, Rapallo-AL-3, Rapallo-AL-4, Sibilla-AEP-1, Sibilla-AEP-2, Sibilla-AEP-3, Sibilla-DISPLAY-2, Sibilla-DISPLAY-3, Sibilla-SAE-1, Sibilla-SAE-2, Sibilla-SAE-3, Vania | | |

microswitches

roller-lever actuated

microswitches



1

| | | | |
|--------------------|---|-----------------|-------|
| GEV No. | 346893 | Ref. No. | 18253 |
| description | microswitch with handle with a switch 250V 16A 1CO connection male faston 6.3mm ambient temperature max. 125°C mounting distance 22mm white | | |
| For models: | CKP, CKPE, CMA, DPiu-1, Giada-1, Giada-2, Sara-1GR-1, Sara-2GR-2 | | |

with mounting components



1

| | | | |
|--------------------|---|-----------------|-------|
| GEV No. | 346152 | Ref. No. | 28239 |
| description | microswitch with handle with a switch 250V 16A 1NO connection male faston 6.3mm L 28mm ambient temperature max. 125°C mounting distance 22mm type U83161.3 actuating force: 40g white | | |
| For models: | Coffee-Grinder-M, Coffee-grinder-M-1 | | |



system switches (ROLD)





1

| | | | |
|--------------------|--|-----------------|----------|
| GEV No. | 347182 | Ref. No. | 15373058 |
| description | element holder mounting measurements 20.6x16.4mm chrome-plated arched for push buttons 13x17mm | | |
| For models: | Rapallo-AEP-1, Rapallo-AEP-2, Rapallo-AEP-3, Rapallo-AEP-4, Sibilla-AEP-1, Sibilla-AEP-2, Sibilla-AEP-3, Sibilla-DISPLAY-2, Sibilla-DISPLAY-3, Sibilla-SAE-1, Sibilla-SAE-2, Sibilla-SAE-3 | | |

| | | | |
|---|--|-----------------|----------|
|  | | | |
| GEV No. | 347193 | Ref. No. | 18371058 |
| description | momentary switch unit 1NO 250V 16A connection male faston 6.3mm | | |
| For models: | Gloria-AEP-1, Gloria-AEP-2, Gloria-AEP-3, Gloria-AEP-4, Gloria-DISPLAY-LCL-2, Gloria-DISPLAY-LCL-3, Gloria-SAE-1, Gloria-SAE-2, Gloria-SAE-3, Gloria-SAE-4, Rapallo-AEP-1, Rapallo-AEP-2, Rapallo-AEP-3, Rapallo-AEP-4, Sibilla-AEP-1, Sibilla-AEP-2, Sibilla-AEP-3, Sibilla-DISPLAY-2, Sibilla-DISPLAY-3, Sibilla-SAE-1, Sibilla-SAE-2, Sibilla-SAE-3 | | |

| | | | |
|---|--|-----------------|--------------------------|
|  | | | |
| GEV No. | 347181 | Ref. No. | 15373057 |
| description | push button size 13x17mmmm chrome-plated | | |
| For models: | Rapallo-AEP-1, Rapallo-AEP-2, Rapallo-AEP-3, Rapallo-AEP-4, Sibilla-AEP-1, Sibilla-AEP-2, Sibilla-AEP-3, Sibilla-DISPLAY-2, Sibilla-DISPLAY-3, Sibilla-SAE-1, Sibilla-SAE-2, Sibilla-SAE-3 | | |
| accessories for | 347181 | | |
|  | GEV No. | 347182 | Ref. No. 15373058 |
| | element holder mounting measurements 20.6x16.4mm chrome-plated arched for push buttons 13x17mm | | |

| | | | |
|---|--|-----------------|--------------------------|
|  | | | |
| GEV No. | 347192 | Ref. No. | 18371057 |
| description | switch 2NO 250V 16A connection male faston 6.3mm | | |
| For models: | Gloria-AEP-1, Gloria-AEP-2, Gloria-AEP-3, Gloria-AEP-4, Gloria-DISPLAY-LCL-2, Gloria-DISPLAY-LCL-3, Gloria-SAE-1, Gloria-SAE-2, Gloria-SAE-3, Gloria-SAE-4, Rapallo-AEP-1, Rapallo-AEP-2, Rapallo-AEP-3, Rapallo-AEP-4, Sibilla-AEP-1, Sibilla-AEP-2, Sibilla-AEP-3, Sibilla-DISPLAY-2, Sibilla-DISPLAY-3, Sibilla-SAE-1, Sibilla-SAE-2, Sibilla-SAE-3 | | |
| accessories for | 347192 | | |
|  | GEV No. | 347183 | Ref. No. 15373060 |
| | push button mounting ø 14.3mm chrome-plated | | |

key lock switches

| | | | |
|---|--|-----------------|----------|
|  | | | |
| GEV No. | 402220 | Ref. No. | 22723022 |
| description | key lock switch 1 group thread M12x1 1NO mounting ø 12mm | | |
| For models: | Giada-1, Giada-2, Gloria-AEP-1, Gloria-AEP-2, Gloria-AEP-3, Gloria-AEP-4, Gloria-DISPLAY-LCL-2, Gloria-DISPLAY-LCL-3, Gloria-SAE-1, Gloria-SAE-2, Gloria-SAE-3, Gloria-SAE-4, Sara-1GR-1, Sara-2GR-2 | | |

| | | | |
|---|---|-----------------|----------|
|  | | | |
| GEV No. | 402219 | Ref. No. | 22723003 |
| description | key lock switch 1 group thread M12x1 1NO mounting ø 12mm cable length 500mm | | |
| For models: | CMA, Giada-1, Giada-2, Sara-1GR-1, Sara-2GR-2 | | |

rotary switches

BREMAS

A1700 series

| | | | |
|---|--|-----------------|----------------------------|
|  | | | |
| GEV No. | 346104 | Ref. No. | 18201 18211 8318201R |
| description | rotary switch 2 0-1 sets of contacts 3 type CA0170003 400V 20A shaft ø 5x5mm shaft L 21mm shaft square connection screw | | |
| For models: | Argenta, Argenta-AEP-1, Argenta-AEP-2, Argenta-AEP-3, Argenta-AEP-4, Argenta-AEP-J, Argenta-SAE-1, Argenta-SAE-2, Argenta-SAE-3, Argenta-SAE-4, Argenta-SAE-J, Brava, Brava-SME-1, Brava-SME-2, Brava-SME-3, Brava-SME-4, Brava-SMSA-1, Brava-SMSA-2, Brava-SMSA-3, Brava-SMSA-4, CompattaArgenta, Denise, Divina-AEP-1, Divina-AEP-2, Divina-AEP-3, Divina-AEP-4, Divina-AEP-J, Divina-SAE-1, Divina-SAE-2, Divina-SAE-3, Divina-SAE-4, Divina-SAE-J, Dora, Gloria-AEP-1, Gloria-AEP-2, Gloria-AEP-3, Gloria-AEP-4, Gloria-DISPLAY-LCL-2, Gloria-DISPLAY-LCL-3, Gloria-SAE-1, Gloria-SAE-2, Gloria-SAE-3, Gloria-SAE-4, Rapallo-AEP-1, Rapallo-AEP-2, Rapallo-AEP-3, Rapallo-AEP-4, Rapallo-AL-1, Rapallo-AL-2, Rapallo-AL-3... (Other models you can see in the webshop) | | |
| accessories for | 346104 | | |
|  | GEV No. | 111012 | Ref. No. — |
| | knob switch zero mark t.max. °C ø 34/60mm shaft ø 5x5mm shaft flat black H 22mm L 50mm | | |

| | | | |
|---|---|-----------------|---|
|  | | | |
| GEV No. | 346100 | Ref. No. | 18104 18104+2x23564049+15271 8318104R |
| description | rotary switch 3 1-0-2 sets of contacts 8 type CS0177412 400V 20A shaft ø 5x5mm shaft L 21mm shaft square connection screw | | |
| For models: | Argenta-AEP-1, Argenta-AEP-2, Argenta-AEP-3, Argenta-AEP-4, Argenta-AEP-J, Argenta-SAE-1, Argenta-SAE-2, Argenta-SAE-3, Argenta-SAE-4, Argenta-SAE-J, Brava, Brava-SME-1, Brava-SME-2, Brava-SME-3, Brava-SME-4, Brava-SMSA-1, Brava-SMSA-2, Brava-SMSA-3, Brava-SMSA-4, CompattaArgenta, Divina-AEP-1, Divina-AEP-2, Divina-AEP-3, Divina-AEP-4, Divina-AEP-J, Divina-SAE-1, Divina-SAE-2, Divina-SAE-3, Divina-SAE-4, Divina-SAE-J, Gloria-AEP-1, Gloria-AEP-2, Gloria-AEP-3, Gloria-AEP-4, Gloria-DISPLAY-LCL-2, Gloria-DISPLAY-LCL-3, Gloria-SAE-1, Gloria-SAE-2, Gloria-SAE-3, Gloria-SAE-4, Rapallo-AEP-1, Rapallo-AEP-2, Rapallo-AEP-3, Rapallo-AEP-4, Rapallo-AL-1, Rapallo-AL-2, Rapallo-AL-3, Rapallo-AL-4, Sibilla-AEP-1, Sibilla-AEP-2... (Other models you can see in the webshop) | | |



A2500 series

| | | | |
|---|---|-----------------|-------|
|  | | | |
| 1 | | | |
| GEV No. | 346105 | Ref. No. | 18207 |
| description | rotary switch 2 0-1 sets of contacts 3 type CA0250003V 690V 32A shaft ø 5x5mm shaft L 23mm shaft square connection screw | | |
| For models: | Argenta-AEP-1, Argenta-AEP-2, Argenta-AEP-3, Argenta-AEP-4, Argenta-AEP-J, Argenta-SAE-1, Argenta-SAE-2, Argenta-SAE-3, Argenta-SAE-4, Argenta-SAE-J, Brava, Brava-SME-1, Brava-SME-2, Brava-SME-3, Brava-SME-4, Brava-SMSA-1, Brava-SMSA-2, Brava-SMSA-3, Brava-SMSA-4, CompattaArgenta, Divina-AEP-1, Divina-AEP-2, Divina-AEP-3, Divina-AEP-4, Divina-AEP-J, Divina-SAE-1, Divina-SAE-2, Divina-SAE-3, Divina-SAE-4, Divina-SAE-J, Dora, Gloria-AEP-1, Gloria-AEP-2, Gloria-AEP-3, Gloria-AEP-4, Gloria-DISPLAY-LCL-2, Gloria-DISPLAY-LCL-3, Gloria-SAE-1, Gloria-SAE-2, Gloria-SAE-3, Gloria-SAE-4, Rapallo-AEP-1, Rapallo-AEP-2, Rapallo-AEP-3, Rapallo-AEP-4, Rapallo-AL-1, Rapallo-AL-2, Rapallo-AL-3, Rapallo-AL-4, Sibilla-AEP-1...(Other models you can see in the webshop) | | |

| | | | |
|---|---|-----------------|-------|
|  | | | |
| 1 | | | |
| GEV No. | 346101 | Ref. No. | 18103 |
| description | rotary switch 3 1-0-2 sets of contacts 8 type CS0257412 600V 32A shaft ø 5x5mm shaft L 21mm shaft square connection screw | | |

accessories

| | | | |
|---|--|-----------------|-------|
|  | | | |
| 1 | | | |
| GEV No. | 527259 | Ref. No. | 15271 |
| description | knob push-in ø 34/60mm shaft ø 5x5mm black H 21.4mm L 49mm | | |
| For models: | Argenta, Argenta-AEP-1, Argenta-AEP-2, Argenta-AEP-3, Argenta-AEP-4, Argenta-AEP-J, Argenta-SAE-1, Argenta-SAE-2, Argenta-SAE-3, Argenta-SAE-4, Argenta-SAE-J, Brava-SME-1, Brava-SME-2, Brava-SME-3, Brava-SME-4, Brava-SMSA-1, Brava-SMSA-2, Brava-SMSA-3, Brava-SMSA-4, CompattaArgenta, Denise, Divina, Divina-AEP-1, Divina-AEP-2, Divina-AEP-3, Divina-AEP-4, Divina-AEP-J, Divina-SAE-1, Divina-SAE-2, Divina-SAE-3, Divina-SAE-4, Divina-SAE-J, Dora, Gloria-AEP-1, Gloria-AEP-2, Gloria-AEP-3, Gloria-AEP-4, Gloria-DISPLAY-LCL-2, Gloria-DISPLAY-LCL-3, Gloria-SAE-1, Gloria-SAE-2, Gloria-SAE-3, Gloria-SAE-4, Rapallo-AEP-1, Rapallo-AEP-2, Rapallo-AEP-3, Rapallo-AEP-4, Rapallo-AL-1, Rapallo-AL-2, Rapallo-AL-3...(Other models you can see in the webshop) | | |

miscellaneous

| | | | |
|---|--------------------------------------|-----------------|----------|
|  | | | |
| 1 | | | |
| GEV No. | 527808 | Ref. No. | 22937001 |
| description | rotary switch with cable SPHERA/TRON | | |

accessories

| | | | |
|---|--|-----------------|-------|
| <p>symbol labels</p>  | | | |
| 1 | | | |
| GEV No. | 345793 | Ref. No. | 29068 |
| description | symbol label 0 up to 1 L 58.5mm W 58.5mm bore ø 10mm mounting distance 20mm | | |
| For models: | Argenta, Argenta-AEP-1, Argenta-AEP-2, Argenta-AEP-3, Argenta-AEP-4, Argenta-AEP-J, Argenta-SAE-1, Argenta-SAE-2, Argenta-SAE-3, Argenta-SAE-4, Argenta-SAE-J, Brava-SME-1, Brava-SME-2, Brava-SME-3, Brava-SME-4, Brava-SMSA-1, Brava-SMSA-2, Brava-SMSA-3, Brava-SMSA-4, CompattaArgenta, Denise, Divina, Divina-AEP-1, Divina-AEP-2, Divina-AEP-3, Divina-AEP-4, Divina-AEP-J, Divina-SAE-1, Divina-SAE-2, Divina-SAE-3, Divina-SAE-4, Divina-SAE-J, Dora, Gloria-AEP-1, Gloria-AEP-2, Gloria-AEP-3, Gloria-AEP-4, Gloria-DISPLAY-LCL-2, Gloria-DISPLAY-LCL-3, Gloria-SAE-1, Gloria-SAE-2, Gloria-SAE-3, Gloria-SAE-4, Rapallo-AEP-1, Rapallo-AEP-2, Rapallo-AEP-3, Rapallo-AEP-4, Rapallo-AL-1, Rapallo-AL-2, Rapallo-AL-3...(Other models you can see in the webshop) | | |

| | | | |
|--|--|-----------------|-------|
|  | | | |
| 1 | | | |
| GEV No. | 345794 | Ref. No. | 29067 |
| description | symbol label 1-0-2 L 58.5mm W 58.5mm bore ø 10mm mounting distance 20mm | | |
| For models: | Argenta, Argenta-AEP-1, Argenta-AEP-2, Argenta-AEP-3, Argenta-AEP-4, Argenta-AEP-J, Argenta-SAE-1, Argenta-SAE-2, Argenta-SAE-3, Argenta-SAE-4, Argenta-SAE-J, Brava-SME-1, Brava-SME-2, Brava-SME-3, Brava-SME-4, Brava-SMSA-1, Brava-SMSA-2, Brava-SMSA-3, Brava-SMSA-4, CompattaArgenta, Denise, Divina, Divina-AEP-1, Divina-AEP-2, Divina-AEP-3, Divina-AEP-4, Divina-AEP-J, Divina-SAE-1, Divina-SAE-2, Divina-SAE-3, Divina-SAE-4, Divina-SAE-J, Dora, Gloria-AEP-1, Gloria-AEP-2, Gloria-AEP-3, Gloria-AEP-4, Gloria-DISPLAY-LCL-2, Gloria-DISPLAY-LCL-3, Gloria-SAE-1, Gloria-SAE-2, Gloria-SAE-3, Gloria-SAE-4, Rapallo-AEP-1, Rapallo-AEP-2, Rapallo-AEP-3, Rapallo-AEP-4, Rapallo-AL-1, Rapallo-AL-2, Rapallo-AL-3...(Other models you can see in the webshop) | | |

| | | | |
|--|--|-----------------|----------|
|  | | | |
| 1 | | | |
| GEV No. | 347194 | Ref. No. | 29066001 |
| description | symbol label 1-0-2 ø 58mm bore ø 10mm mounting distance 20mm | | |
| For models: | Sibilla-AEP-1, Sibilla-AEP-2, Sibilla-AEP-3, Sibilla-DISPLAY-2, Sibilla-DISPLAY-3, Sibilla-SAE-1, Sibilla-SAE-2, Sibilla-SAE-3 | | |



magnetic switches

23x14mm

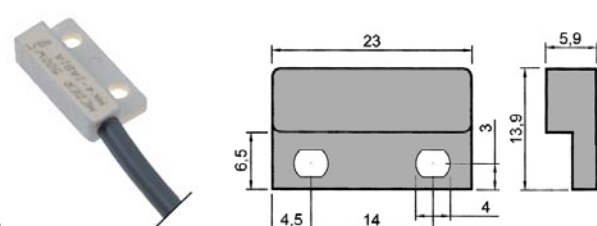

| | | | |
|--------------------|---|-----------------|----------|
| GEV No. | 346106 | Ref. No. | 18255000 |
| description | magnetic switch L 23mm W 13.9mm 1NO 90V 0.5A P max. 10W cable length 500mm mounting distance 14mm | | |
| For models: | CK-CKE-CK-1, CK-CKE-CKE-1, CKX-CKXE, CKX-CKXE-CKX-1, CKX-CKXE-CKXE-1, DPiu-1 | | |

with plug-in socket



| | | | |
|--------------------|--|-----------------|-------|
| GEV No. | 359019 | Ref. No. | 21012 |
| description | indicator light ø 10mm green 400V connection male faston 6.3mm Qty 1 pcs | | |



| | | | |
|--------------------|--|-----------------|-------|
| GEV No. | 359040 | Ref. No. | 21030 |
| description | indicator light ø 10mm red 230V connection male faston 2.8mm Qty 1 pcs | | |



| | | | |
|--------------------|---|-----------------|-------|
| GEV No. | 359034 | Ref. No. | 21012 |
| description | indicator light ø 10mm yellow 400V connection male faston 6.3mm Qty 1 pcs | | |
| For models: | Argenta, Argenta-AEP-1, Argenta-AEP-2, Argenta-AEP-3, Argenta-AEP-4, Argenta-AEP-J, Argenta-SAE-1, Argenta-SAE-2, Argenta-SAE-3, Argenta-SAE-4, Argenta-SAE-J, Brava, Brava-SME-1, Brava-SME-2, Brava-SME-3, Brava-SME-4, Brava-SMSA-1, Brava-SMSA-2, Brava-SMSA-3, Brava-SMSA-4, CompattaArgenta, Denise, Divina-AEP-1, Divina-AEP-2, Divina-AEP-3, Divina-AEP-4, Divina-AEP-J, Divina-SAE-1, Divina-SAE-2, Divina-SAE-3, Divina-SAE-4, Divina-SAE-J, Dora, Rapallo-AEP-1, Rapallo-AEP-2, Rapallo-AEP-3, Rapallo-AEP-4, Rapallo-AL-1, Rapallo-AL-2, Rapallo-AL-3, Rapallo-AL-4, Sibilla-AEP-1, Sibilla-AEP-2, Sibilla-AEP-3, Sibilla-DISPLAY-2, Sibilla-DISPLAY-3, Sibilla-SAE-1, Sibilla-SAE-2, Sibilla-SAE-3 | | |



| | | | |
|--------------------|--|-----------------|-------|
| GEV No. | 359413 | Ref. No. | 21030 |
| description | indicator light ø 10mm 230V red cable length 250mm | | |
| For models: | Argenta, Brava, CK, CK-CKE, CK-CKE-CK-1, CK-CKE-CKE-1, CKE, CKP, CKPE, CKX-CKXE, CKX-CKXE-CKX-1, CKX-CKXE-CKXE-1, Denise | | |

LED

indicator lamps

miscellaneous



| | | | |
|--------------------|---|-----------------|----------------|
| GEV No. | 400538 | Ref. No. | 22623 22625 |
| description | indicator light LED red mounting thread M8x0.75 ø 5mm | | |
| For models: | Argenta-AEP-1, Argenta-AEP-2, Argenta-AEP-3, Argenta-AEP-4, Argenta-AEP-J, Argenta-SAE-1, Argenta-SAE-2, Argenta-SAE-3, Argenta-SAE-4, Argenta-SAE-J, Brava, Brava-SME-1, Brava-SME-2, Brava-SME-3, Brava-SME-4, Brava-SMSA-1, Brava-SMSA-2, Brava-SMSA-3, Brava-SMSA-4, CK, CK-CKE, CK-CKE-CK-1, CK-CKE-CKE-1, CKE, CKP, CKPE, CKX-CKXE-CKX-1, CKX-CKXE-CKXE-1, CompattaArgenta, Divina, Dora, Gloria-AEP-1, Gloria-AEP-2, Gloria-AEP-3, Gloria-AEP-4, Gloria-DISPLAY-LCL-2, Gloria-DISPLAY-LCL-3, Gloria-SAE-1, Gloria-SAE-2, Gloria-SAE-3, Gloria-SAE-4, Rapallo-AEP-1, Rapallo-AEP-2, Rapallo-AEP-3, Rapallo-AEP-4, Rapallo-AL-1, Rapallo-AL-2, Rapallo-AL-3, Rapallo-AL-4, Sibilla-AEP-1...(Other models you can see in the webshop) | | |

lamps

indicator lights

indicator lights (complete)

ø 6mm



| | | | |
|--------------------|---|-----------------|-------|
| GEV No. | 359009 | Ref. No. | 21023 |
| description | indicator light ø 6mm 230V red cable length 400mm with series resistor | | |
| For models: | Gloria-AEP-1, Gloria-AEP-2, Gloria-AEP-3, Gloria-AEP-4, Gloria-DISPLAY-LCL-2, Gloria-DISPLAY-LCL-3, Gloria-SAE-1, Gloria-SAE-2, Gloria-SAE-3, Gloria-SAE-4, Prima, Sibilla-AEP-1, Sibilla-AEP-2, Sibilla-AEP-3, Sibilla-DISPLAY-2, Sibilla-DISPLAY-3, Sibilla-SAE-1, Sibilla-SAE-2, Sibilla-SAE-3 | | |

ø10mm

with screw socket





| | | | |
|--------------------|--|-----------------|-------|
| GEV No. | 359400 | Ref. No. | 21011 |
| description | indicator light ø 10mm 230V green | | |
| For models: | Argenta, Argenta-AEP-1, Argenta-AEP-2, Argenta-AEP-3, Argenta-AEP-4, Argenta-AEP-J, Argenta-SAE-1, Argenta-SAE-2, Argenta-SAE-3, Argenta-SAE-4, Argenta-SAE-J, Brava, Brava-SME-1, Brava-SME-2, Brava-SME-3, Brava-SME-4, Brava-SMSA-1, Brava-SMSA-2, Brava-SMSA-3, Brava-SMSA-4, CKP, CKPE, CompattaArgenta, Denise, Divina-AEP-1, Divina-AEP-2, Divina-AEP-3, Divina-AEP-4, Divina-AEP-J, Divina-SAE-1, Divina-SAE-2, Divina-SAE-3, Divina-SAE-4, Divina-SAE-J, Dora, ELE-03, Gloria-AEP-1, Gloria-AEP-2, Gloria-AEP-3, Gloria-AEP-4, Gloria-DISPLAY-LCL-2, Gloria-DISPLAY-LCL-3, Gloria-SAE-1, Gloria-SAE-2, Gloria-SAE-3, Gloria-SAE-4, Rapallo-AEP-1, Rapallo-AEP-2, Rapallo-AEP-3, Rapallo-AEP-4...(Other models you can see in the webshop) | | |



timers

mechanical timers

| | | | |
|---|---|-----------------|-------|
|  | | | |
| 1 | | | |
| GEV No. | 350110 | Ref. No. | 28162 |
| description | timer M2 2-pole operation time 50s impulse mechanical 2NO at 250V 16A permanent position no shaft ø 3.5 x 3.5mm shaft 3.5 x 3.5mm shaft L 20mm mounting distance 28mm connection rear | | |
| For models: | Coffee-Grinder-M, Coffee-grinder-M-1, Coffee-Grinder-R | | |

| | | | |
|--|---|-----------------|----------|
|  | | | |
| 1 | | | |
| GEV No. | 527825 | Ref. No. | 22980001 |
| description | power contactor 230V resistive load 25A (AC3/400V) 4kW with cable | | |

solid state relays

miscellaneous

| | | | |
|--|---|-----------------|----------|
|  | | | |
| 1 | | | |
| GEV No. | 381202 | Ref. No. | 18460005 |
| description | power relays CARLO GAVAZZI 1 phase 50A 600V 22-48VDC L 58mm W 45mm screw type RM1A60A50 | | |

contactors

ABB

power contactors

| | | | |
|--|---|-----------------|----------------------------|
|  | | | |
| 1 | | | |
| GEV No. | 380092 | Ref. No. | 20299 20299002 20300 |
| description | power contactor resistive load 20A 230VAC (AC3/400V) 12A/5.5kW main contacts 4NO auxiliary contacts connection screw connection type B6-40-00 / B7-40-00 | | |
| For models: | CMA, Giada-1, Giada-2, Gloria-AEP-1, Gloria-AEP-2, Gloria-AEP-3, Gloria-AEP-4, Gloria-DISPLAY-LCL-2, Gloria-DISPLAY-LCL-3, Gloria-SAE-1, Gloria-SAE-2, Gloria-SAE-3, Gloria-SAE-4, Sara-1GR-1, Sara-2GR-2 | | |

relays

power relays

with bracket mounting

| | | | |
|--|---|-----------------|----------|
|  | | | |
| 1 | | | |
| GEV No. | 380368 | Ref. No. | 18460001 |
| description | power relays ZETTLER ELECTRONICS 230VAC 30A 1NO/1NC connection male faston 6.3mm bracket mounting manif. no. AZ 2280-1A-240AF AZ2280-1C-240AF | | |
| For models: | CK, CK-CKE, CK-CKE-CK-1, CK-CKE-CKE-1, CKE, CKP, CKPE, CKX-CKXE, CKX-CKXE-CKX-1, CKX-CKXE-CKXE-1 | | |

miscellaneous

power contactors



| | | | |
|---|-----------------|-----------------|-------|
|  | | | |
| 1 | | | |
| GEV No. | 380308 | Ref. No. | 18452 |
| description | power contactor | | |



with male contacts

female contact 2.0mm



| | | | |
|---|---|-----------------|-------------------|
| GEV No. | 380494 | Ref. No. | 18460003 |
| description | power relays FINDER 230VAC 7A 4CO connection F2 plug-in connection manuf. no. 55.34.8.230.0054 94.74/ZMD4 250V connection 2mm | | |
| accessories for | 380494 | | |
|  | GEV No. | 380341 | Ref. No. — |
| | relay socket 4-pole contacts 12 300V voltage AC 6A Italiana Relè manuf. no. ZMD4 | | |
|  | GEV No. | 380399 | Ref. No. — |
| | relay socket 4-pole dimensions 76.2x27x86.1mm 250V voltage AC 1A FINDER manuf. no. 94.94.3 | | |

relay sockets



| | | | |
|---|---|-----------------|-------------------|
| GEV No. | 380136 | Ref. No. | 18600 |
| description | relay socket 11-pole connection plug-in connection round 11-pole dimensions 65x28x40mm 250V voltage AC 10A Italiana Relè manuf. no. ZVE11 | | |
| For models: | Argenta | | |
| accessories for | 380136 | | |
|  | GEV No. | 380805 | Ref. No. — |
| | support bracket | | |

level relays

GICAR



| | | | |
|--------------------|---|-----------------|-------|
| GEV No. | 402103 | Ref. No. | 18080 |
| description | level controller 230/240V voltage AC 50/60Hz connection F6.3 type NRL30/1E-2C/F | | |
| For models: | Argenta, Denise, Divina | | |



| | | | |
|--------------------|---|-----------------|-------|
| GEV No. | 400230 | Ref. No. | 18402 |
| description | level relay 230V voltage AC 50/60Hz 11-pole 10A connection plug-in connection round 11-pole type RL40/1E/11 | | |
| For models: | Argenta | | |

GIEMME



| | | | |
|--------------------|---|-----------------|----------|
| GEV No. | 402216 | Ref. No. | 18081001 |
| description | level relay 115V voltage AC 50/60Hz 8A connection male faston 6.3mm type RL1E/2C/F | | |
| For models: | Argenta-AEP-1, Argenta-AEP-2, Argenta-AEP-3, Argenta-AEP-4, Argenta-AEP-J, Argenta-SAE-1, Argenta-SAE-2, Argenta-SAE-3, Argenta-SAE-4, Argenta-SAE-J, Brava, Brava-SME-1, Brava-SME-2, Brava-SME-3, Brava-SME-4, Brava-SMSA-1, Brava-SMSA-2, Brava-SMSA-3, Brava-SMSA-4, CompattaArgenta, Divina, Divina-AEP-1, Divina-AEP-2, Divina-AEP-3, Divina-AEP-4, Divina-AEP-J, Divina-SAE-1, Divina-SAE-2, Divina-SAE-3, Divina-SAE-4, Divina-SAE-J, Dora, Gloria-AEP-1, Gloria-AEP-2, Gloria-AEP-3, Gloria-AEP-4, Gloria-DISPLAY-LCL-2, Gloria-DISPLAY-LCL-3, Gloria-SAE-1, Gloria-SAE-2, Gloria-SAE-3, Gloria-SAE-4, Rapallo-AEP-1, Rapallo-AEP-2, Rapallo-AEP-3, Rapallo-AEP-4, Rapallo-AL-1, Rapallo-AL-2, Rapallo-AL-3, Rapallo-AL-4... (Other models you can see in the webshop) | | |



| | | | |
|--------------------|---|-----------------|----------|
| GEV No. | 400537 | Ref. No. | 18080001 |
| description | level relay 230V voltage AC 50/60Hz 8A connection F6.3 type RL1E/2C/F | | |
| For models: | Argenta-AEP-1, Argenta-AEP-2, Argenta-AEP-3, Argenta-AEP-4, Argenta-AEP-J, Argenta-SAE-1, Argenta-SAE-2, Argenta-SAE-3, Argenta-SAE-4, Argenta-SAE-J, Brava, Brava-SME-1, Brava-SME-2, Brava-SME-3, Brava-SME-4, Brava-SMSA-1, Brava-SMSA-2, Brava-SMSA-3, Brava-SMSA-4, CompattaArgenta, Divina, Divina-AEP-1, Divina-AEP-2, Divina-AEP-3, Divina-AEP-4, Divina-AEP-J, Divina-SAE-1, Divina-SAE-2, Divina-SAE-3, Divina-SAE-4, Divina-SAE-J, Dora, Gloria-AEP-1, Gloria-AEP-2, Gloria-AEP-3, Gloria-AEP-4, Gloria-DISPLAY-LCL-2, Gloria-DISPLAY-LCL-3, Gloria-SAE-1, Gloria-SAE-2, Gloria-SAE-3, Gloria-SAE-4, Rapallo-AEP-1, Rapallo-AEP-2, Rapallo-AEP-3, Rapallo-AEP-4, Rapallo-AL-1, Rapallo-AL-2, Rapallo-AL-3, Rapallo-AL-4... (Other models you can see in the webshop) | | |



probes

producer-specific probes

probes

| | | | |
|--------------------|---|-----------------|-------|
| 1 |  | | |
| GEV No. | 379556 | Ref. No. | 20306 |
| description | temperature probe NTC 10kOhm cable silicone probe -40 up to +110°C cable -50 up to +180°C connection plug thread 1/8" probe ø6x11mm cable length 0.1m | | |
| For models: | CMA, DPiu-1, Giada-1, Giada-2, Gloria-AEP-1, Gloria-AEP-2, Gloria-AEP-3, Gloria-AEP-4, Gloria-DISPLAY-LCL-2, Gloria-DISPLAY-LCL-3, Gloria-SAE-1, Gloria-SAE-2, Gloria-SAE-3, Gloria-SAE-4, Sara-1GR-1, Sara-2GR-2 | | |

| | | | |
|--------------------|--|-----------------|---------|
| 1 |  | | |
| GEV No. | 527772 | Ref. No. | WY20255 |
| description | temperature probe NTC 200kOhm cable silicone probe -40 up to +150°C cable -50 up to +180°C connection coded plug thread 1/4" probe ø8x20mm cable length 1.5m | | |

sensors

| | | | |
|--------------------|---|-----------------|-------|
| 1 |  | | |
| GEV No. | 379556 | Ref. No. | 20306 |
| description | temperature probe NTC 10kOhm cable silicone probe -40 up to +110°C cable -50 up to +180°C connection plug thread 1/8" probe ø6x11mm cable length 0.1m | | |
| For models: | CMA, DPiu-1, Giada-1, Giada-2, Gloria-AEP-1, Gloria-AEP-2, Gloria-AEP-3, Gloria-AEP-4, Gloria-DISPLAY-LCL-2, Gloria-DISPLAY-LCL-3, Gloria-SAE-1, Gloria-SAE-2, Gloria-SAE-3, Gloria-SAE-4, Sara-1GR-1, Sara-2GR-2 | | |

electronics

electronics accessories

| | | | |
|--------------------|--|-----------------|----------|
| 1 |  | | |
| GEV No. | 527612 | Ref. No. | 15182997 |
| description | gasket for display L 110mm W 55mm thickness 2mm Neoprene | | |
| For models: | Gloria-AEP-1, Gloria-AEP-2, Gloria-AEP-3, Gloria-AEP-4, Gloria-DISPLAY-LCL-2, Gloria-DISPLAY-LCL-3, Gloria-SAE-1, Gloria-SAE-2, Gloria-SAE-3, Gloria-SAE-4 | | |

| | | | |
|--------------------|---|-----------------|------------|
| 1 |  | | |
| GEV No. | 527765 | Ref. No. | WY15373050 |
| description | housing L 119mm W 51mm plastic | | |

| | | | |
|--------------------|--|-----------------|----------|
| 1 |  | | |
| GEV No. | 527820 | Ref. No. | 15373104 |
| description | spacer piece for display L 10mm ø 4.8mm ID ø 3.1mm | | |

| | | | |
|--------------------|--|-----------------|----------|
| 1 |  | | |
| GEV No. | 527821 | Ref. No. | 15373105 |
| description | spacer piece for keypad L 11.1mm ø 4.8mm ID ø 3.1mm | | |

| | | | |
|--------------------|--|-----------------|----------|
| 1 |  | | |
| GEV No. | 527819 | Ref. No. | 15373106 |
| description | spacer piece for keypad L 22.5mm ø 4.8mm ID ø 3.1mm | | |

| | | | |
|--------------------|--|-----------------|----------|
| 1 |  | | |
| GEV No. | 527823 | Ref. No. | 15373107 |
| description | spacer piece for keypad with internal and external thread thread M3 L 6mm | | |

| | | | |
|--------------------|--|-----------------|----------|
| 1 |  | | |
| GEV No. | 527822 | Ref. No. | 15373108 |
| description | spacer piece with thread thread M3 L 5mm | | |
| For models: | Giada-1, Giada-2, Sara-1GR-1, Sara-2GR-2 | | |





EPROMS

| | | | |
|---|--|-----------------|--------------------|
|  | | | |
| 1 | | | |
| GEV No. | 402720 | Ref. No. | 18199006 27C512 |
| description | EPROM 2-piece CODE SC51 V.436 2.04.09 | | |
| For models: | Giada-1, Giada-2, Sara-1GR-1, Sara-2GR-2 | | |

PCBs

| | | | |
|---|--|-----------------|------------|
|  | | | |
| 1 | | | |
| GEV No. | 527760 | Ref. No. | WY18371077 |
| description | display for coffee machine L 84mm W 44mm | | |

| | | | |
|--|--|-----------------|----------|
|  | | | |
| 1 | | | |
| GEV No. | 527793 | Ref. No. | 18371078 |
| description | display L 122mm W 44mm | | |
| For models: | Gloria-AEP-1, Gloria-AEP-2, Gloria-AEP-3, Gloria-AEP-4, Gloria-DISPLAY-LCL-2, Gloria-DISPLAY-LCL-3, Gloria-SAE-1, Gloria-SAE-2, Gloria-SAE-3, Gloria-SAE-4 | | |

| | | | |
|---|---------------------------|-----------------|----------------------|
|  | | | |
| 1 | | | |
| GEV No. | 527759 | Ref. No. | 18371089 18371090 |
| description | keypad PCB L 130mm W 40mm | | |

| | | | |
|---|--|-----------------|----------|
|  | | | |
| 1 | | | |
| GEV No. | 527792 | Ref. No. | 18371079 |
| description | keypad unit L 131mm W 35mm mounting pos. horizontal buttons 7 | | |
| For models: | Gloria-AEP-1, Gloria-AEP-2, Gloria-AEP-3, Gloria-AEP-4, Gloria-DISPLAY-LCL-2, Gloria-DISPLAY-LCL-3, Gloria-SAE-1, Gloria-SAE-2, Gloria-SAE-3, Gloria-SAE-4 | | |

| | | | |
|--|--|-----------------|----------|
|  | | | |
| 1 | | | |
| GEV No. | 402717 | Ref. No. | 18090064 |
| description | keypad unit suitable for ASTORIA with display buttons 5 for EKO,05, GRANDE | | |
| For models: | Giada-1, Giada-2, Sara-1GR-1, Sara-2GR-2 | | |

| | | | |
|---|-----------------------------------|-----------------|----------------------|
|  | | | |
| 1 | | | |
| GEV No. | 527761 | Ref. No. | 18371085 18371086 |
| description | PCB L 65mm W 43mm with flattening | | |

| | | | |
|--|--|-----------------|----------|
|  | | | |
| 1 | | | |
| GEV No. | 402716 | Ref. No. | 18090021 |
| description | PCB suitable for ASTORIA with transformer series EKO | | |
| For models: | CMA, Giada-1, Giada-2, Sara-1GR-1, Sara-2GR-2 | | |

| | | | |
|---|--|-----------------|----------|
|  | | | |
| 1 | | | |
| GEV No. | 402721 | Ref. No. | 18090062 |
| description | plug for PCB 20-pole series EKO | | |
| For models: | Giada-1, Giada-2, Sara-1GR-1, Sara-2GR-2 | | |

| | | | |
|---|---|-----------------|----------------------|
|  | | | |
| 1 | | | |
| GEV No. | 402719 | Ref. No. | 18090026 18090027 |
| description | plug for PCB 26-pole | | |
| For models: | CMA, Giada-1, Giada-2, Sara-1GR-1, Sara-2GR-2 | | |

| | | | |
|---|---|-----------------|----------|
|  | | | |
| 1 | | | |
| GEV No. | 402718 | Ref. No. | 18090025 |
| description | plug for PCB 26-pole series EKO | | |
| For models: | CMA, Giada-1, Giada-2, Sara-1GR-1, Sara-2GR-2 | | |

1

| | | | |
|--------------------|---|-----------------|----------|
| GEV No. | 402714 | Ref. No. | 18090022 |
| description | relay PCB Giada, Sara | | |
| For models: | CMA, Giada-1, Giada-2, Sara-1GR-1, Sara-2GR-2 | | |



1

| | | | |
|--------------------|---|-----------------|----------|
| GEV No. | 400539 | Ref. No. | 18090016 |
| description | control box 1-3-group for coffee machine 230V type 3GR+LIV+TEA DE | | |
| For models: | Argenta-AEP-1, Argenta-AEP-2, Argenta-AEP-3, Argenta-AEP-4, Argenta-AEP-J, Argenta-SAE-1, Argenta-SAE-2, Argenta-SAE-3, Argenta-SAE-4, Argenta-SAE-J, Brava-SME-1, Brava-SME-2, Brava-SME-3, Brava-SME-4, Brava-SMSA-1, Brava-SMSA-2, Brava-SMSA-3, Brava-SMSA-4, CompattaArgenta, Divina-AEP-1, Divina-AEP-2, Divina-AEP-3, Divina-AEP-4, Divina-AEP-J, Divina-SAE-1, Divina-SAE-2, Divina-SAE-3, Divina-SAE-4, Divina-SAE-J, Rapallo-AEP-1, Rapallo-AEP-2, Rapallo-AEP-3, Rapallo-AEP-4, Rapallo-AL-1, Rapallo-AL-2, Rapallo-AL-3, Rapallo-AL-4, Sibilla-AEP-1, Sibilla-AEP-2, Sibilla-AEP-3, Sibilla-DISPLAY-2, Sibilla-DISPLAY-3, Sibilla-SAE-1, Sibilla-SAE-2, Sibilla-SAE-3 | | |

central units



1

| | | | |
|--------------------|--|-----------------|-------|
| GEV No. | 400530 | Ref. No. | 18045 |
| description | central unit for coffee machine 230V type MFC-2SN | | |
| For models: | CK, CK-CKE, CK-CKE-CK-1, CK-CKE-CKE-1, CKE, CKP, CKPE, CKX-CKXE, CKX-CKXE-CKX-1, CKX-CKXE-CKXE-1, ELE-03 | | |



1

| | | | |
|--------------------|--|-----------------|----------|
| GEV No. | 402213 | Ref. No. | 18090030 |
| description | control box 3-group coffee machine 115V type 3GR+LIV+TEA | | |
| For models: | Argenta-AEP-1, Argenta-AEP-2, Argenta-AEP-3, Argenta-AEP-4, Argenta-AEP-J, Argenta-SAE-1, Argenta-SAE-2, Argenta-SAE-3, Argenta-SAE-4, Argenta-SAE-J, Brava-SME-1, Brava-SME-2, Brava-SME-3, Brava-SME-4, Brava-SMSA-1, Brava-SMSA-2, Brava-SMSA-3, Brava-SMSA-4, Divina-AEP-1, Divina-AEP-2, Divina-AEP-3, Divina-AEP-4, Divina-AEP-J, Divina-SAE-1, Divina-SAE-2, Divina-SAE-3, Divina-SAE-4, Divina-SAE-J, Rapallo-AEP-1, Rapallo-AEP-2, Rapallo-AEP-3, Rapallo-AEP-4, Rapallo-AL-1, Rapallo-AL-2, Rapallo-AL-3, Rapallo-AL-4, Sibilla-AEP-1, Sibilla-AEP-2, Sibilla-AEP-3, Sibilla-DISPLAY-2, Sibilla-DISPLAY-3, Sibilla-SAE-1, Sibilla-SAE-2, Sibilla-SAE-3 | | |



1

| | | | |
|--------------------|--|-----------------|----------|
| GEV No. | 400531 | Ref. No. | 18045001 |
| description | control box | | |
| For models: | CK, CK-CKE, CK-CKE-CK-1, CK-CKE-CKE-1, CKE, CKP, CKPE, CKX-CKXE, CKX-CKXE-CKX-1, CKX-CKXE-CKXE-1 | | |



1

| | | | |
|--------------------|--|-----------------|----------|
| GEV No. | 527811 | Ref. No. | 18090013 |
| description | control box 3-group for coffee machine 115V type 3GR+LIV+TEA C/W | | |



1

| | | | |
|--------------------|-----------------------|-----------------|----------|
| GEV No. | 400544 | Ref. No. | 18090008 |
| description | control box 1-3-group | | |
| For models: | Divina | | |



1

| | | | |
|--------------------|---|-----------------|----------|
| GEV No. | 402214 | Ref. No. | 18090017 |
| description | control box 3-group for coffee machine 115V type 3GR+LIV+TEA DE | | |
| For models: | Argenta-AEP-1, Argenta-AEP-2, Argenta-AEP-3, Argenta-AEP-4, Argenta-AEP-J, Argenta-SAE-1, Argenta-SAE-2, Argenta-SAE-3, Argenta-SAE-4, Argenta-SAE-J, Brava, Brava-SME-1, Brava-SME-2, Brava-SME-3, Brava-SME-4, Brava-SMSA-1, Brava-SMSA-2, Brava-SMSA-3, Brava-SMSA-4, CompattaArgenta, Divina-AEP-1, Divina-AEP-2, Divina-AEP-3, Divina-AEP-4, Divina-AEP-J, Divina-SAE-1, Divina-SAE-2, Divina-SAE-3, Divina-SAE-4, Divina-SAE-J, Rapallo-AEP-1, Rapallo-AEP-2, Rapallo-AEP-3, Rapallo-AEP-4, Rapallo-AL-1, Rapallo-AL-2, Rapallo-AL-3, Rapallo-AL-4, Sibilla-AEP-1, Sibilla-AEP-2, Sibilla-AEP-3, Sibilla-DISPLAY-2, Sibilla-DISPLAY-3, Sibilla-SAE-1, Sibilla-SAE-2, Sibilla-SAE-3, Vania | | |



1

| | | | |
|--------------------|--|-----------------|----------------------|
| GEV No. | 402228 | Ref. No. | 18090038 18090080 |
| description | control box 4-group for coffee machine 230V type NEW PLUS2 4GR+DISPLAY+STEAM | | |
| For models: | Gloria-AEP-1, Gloria-AEP-2, Gloria-AEP-3, Gloria-AEP-4, Gloria-DISPLAY-LCL-2, Gloria-DISPLAY-LCL-3, Gloria-SAE-1, Gloria-SAE-2, Gloria-SAE-3, Gloria-SAE-4 | | |



1

| | | | |
|--------------------|--|-----------------|----------|
| GEV No. | 400796 | Ref. No. | 18090031 |
| description | control box 3-group for coffee machine 230V type 3GR+LIV+TEA | | |
| For models: | Argenta-AEP-1, Argenta-AEP-2, Argenta-AEP-3, Argenta-AEP-4, Argenta-AEP-J, Argenta-SAE-1, Argenta-SAE-2, Argenta-SAE-3, Argenta-SAE-4, Argenta-SAE-J, Brava-SME-1, Brava-SME-2, Brava-SME-3, Brava-SME-4, Brava-SMSA-1, Brava-SMSA-2, Brava-SMSA-3, Brava-SMSA-4, Divina-AEP-1, Divina-AEP-2, Divina-AEP-3, Divina-AEP-4, Divina-AEP-J, Divina-SAE-1, Divina-SAE-2, Divina-SAE-3, Divina-SAE-4, Divina-SAE-J, Rapallo-AEP-1, Rapallo-AEP-2, Rapallo-AEP-3, Rapallo-AEP-4, Rapallo-AL-1, Rapallo-AL-2, Rapallo-AL-3, Rapallo-AL-4, Sibilla-AEP-1, Sibilla-AEP-2, Sibilla-AEP-3, Sibilla-DISPLAY-2, Sibilla-DISPLAY-3, Sibilla-SAE-1, Sibilla-SAE-2, Sibilla-SAE-3 | | |



1

| | | | |
|--------------------|--|-----------------|----------|
| GEV No. | 402215 | Ref. No. | 18043001 |
| description | control box for coffee machine 115V | | |
| For models: | CK, CK-CKE, CK-CKE-CK-1, CK-CKE-CKE-1, CKE, CKP, CKPE, CKX-CKXE, CKX-CKXE-CKX-1, CKX-CKXE-CKXE-1 | | |

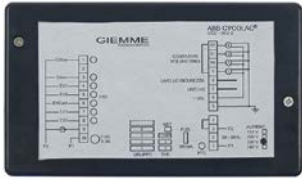

1

| | | | |
|--------------------|---|-----------------|----------------|
| GEV No. | 400379 | Ref. No. | 18076 18079 |
| description | control box 4-group | | |
| For models: | Argenta, Argenta-AEP-1, Argenta-AEP-2, Argenta-AEP-3, Argenta-AEP-4, Argenta-AEP-J, Argenta-SAE-1, Argenta-SAE-2, Argenta-SAE-3, Argenta-SAE-4, Argenta-SAE-J, Brava-SME-1, Brava-SME-2, Brava-SME-3, Brava-SME-4, Brava-SMSA-1, Brava-SMSA-2, Brava-SMSA-3, Brava-SMSA-4, CompattaArgenta, Denise, Divina-AEP-1, Divina-AEP-2, Divina-AEP-3, Divina-AEP-4, Divina-AEP-J, Divina-SAE-1, Divina-SAE-2, Divina-SAE-3, Divina-SAE-4, Divina-SAE-J, Rapallo-AEP-1, Rapallo-AEP-2, Rapallo-AEP-3, Rapallo-AEP-4, Rapallo-AL-1, Rapallo-AL-2, Rapallo-AL-3, Rapallo-AL-4, Sibilla-AEP-1, Sibilla-AEP-2, Sibilla-DISPLAY-2, Sibilla-DISPLAY-3, Sibilla-SAE-1, Sibilla-SAE-2, Sibilla-SAE-3 | | |



1

| | | | |
|--------------------|--|-----------------|-------|
| GEV No. | 527809 | Ref. No. | 18083 |
| description | control box for coffee machine 115V type 30 MICRO ST | | |



1

| | | | |
|--------------------|---|-----------------|----------|
| GEV No. | 527810 | Ref. No. | 18090019 |
| description | control box for coffee machine 115V type CONTROL d-30 | | |





1

| | | | |
|--------------------|--|-----------------|----------|
| GEV No. | 402217 | Ref. No. | 18090048 |
| description | control box for coffee machine 230V | | |
| For models: | Gloria-AEP-1, Gloria-AEP-2, Gloria-AEP-3, Gloria-AEP-4, Gloria-DISPLAY-LCL-2, Gloria-DISPLAY-LCL-3, Gloria-SAE-1, Gloria-SAE-2, Gloria-SAE-3, Gloria-SAE-4, Sibilla-AEP-1, Sibilla-AEP-2, Sibilla-AEP-3, Sibilla-DISPLAY-2, Sibilla-DISPLAY-3, Sibilla-SAE-1, Sibilla-SAE-2, Sibilla-SAE-3 | | |



1

| | | | |
|--------------------|--|-----------------|---------|
| GEV No. | 527737 | Ref. No. | WY18082 |
| description | control box for coffee machine 230V type 30 MICRO ST | | |



1

| | | | |
|--------------------|--|-----------------|------------|
| GEV No. | 527741 | Ref. No. | WY18090018 |
| description | control box for coffee machine 230V type CONTROL d - CAL | | |



1

| | | | |
|--------------------|---|-----------------|----------|
| GEV No. | 402707 | Ref. No. | 18080006 |
| description | control box for pump control 24V voltage AC | | |
| For models: | Giada-1, Giada-2, Sara-1GR-1, Sara-2GR-2 | | |

keypads

front foils



1

| | | | |
|--------------------|--|-----------------|----------|
| GEV No. | 402713 | Ref. No. | 29169020 |
| description | keypad foil black/silver/red suitable for ASTORIA L 142mm W 68mm buttons 4 | | |
| For models: | Giada-1, Giada-2, Sara-1GR-1, Sara-2GR-2 | | |



1

| | | | |
|--------------------|----------------------------|-----------------|------------|
| GEV No. | 527747 | Ref. No. | WY29169102 |
| description | keypad foil L 100mm W 50mm | | |



1

| | | | |
|--------------------|----------------------------|-----------------|------------|
| GEV No. | 527746 | Ref. No. | WY29169117 |
| description | keypad foil L 137mm W 50mm | | |



1

| | | | |
|--------------------|----------------------------|-----------------|------------|
| GEV No. | 527764 | Ref. No. | WY29169115 |
| description | keypad foil L 137mm W 50mm | | |



1

| | | | |
|--------------------|----------------------------|-----------------|------------|
| GEV No. | 527748 | Ref. No. | WY29169101 |
| description | keypad foil L 173mm W 50mm | | |



1

| | | | |
|--------------------|----------------------------|-----------------|------------|
| GEV No. | 527752 | Ref. No. | WY29169119 |
| description | keypad foil L 212mm W 50mm | | |



1

| | | | |
|--------------------|----------------------------|-----------------|------------|
| GEV No. | 527763 | Ref. No. | WY29169116 |
| description | keypad foil L 213mm W 50mm | | |



membrane keypads

1 

| | | | |
|--------------------|-----------------|-----------------|----------|
| GEV No. | 400535 | Ref. No. | 20099001 |
| description | membrane keypad | | |
| For models: | Argenta | | |

1 

| | | | |
|--------------------|---|-----------------|----------|
| GEV No. | 402708 | Ref. No. | 20127002 |
| description | membrane keypad buttons 9 suitable for ASTORIA L 135mm W 60mm | | |
| For models: | CMA, Sara-1GR-1, Sara-2GR-2 | | |

1 

| | | | |
|--------------------|--|-----------------|-------|
| GEV No. | 400536 | Ref. No. | 20100 |
| description | membrane keypad coffee machine ARGENTA | | |
| For models: | Argenta | | |

1 

| | | | |
|--------------------|---|-----------------|------------|
| GEV No. | 527754 | Ref. No. | WY20126014 |
| description | membrane keypad coffee machine ATLAS L 100mm W 50mm | | |

1 

| | | | |
|--------------------|--|-----------------|---------|
| GEV No. | 527758 | Ref. No. | WY18349 |
| description | membrane keypad for coffee machine L 50mm W 50mm | | |

1 

| | | | |
|--------------------|---|-----------------|----------|
| GEV No. | 402710 | Ref. No. | 20127004 |
| description | membrane keypad suitable for ASTORIA L 135mm W 60mm | | |
| For models: | CMA, Sara-1GR-1, Sara-2GR-2 | | |

1 

| | | | |
|--------------------|---|-----------------|----------|
| GEV No. | 402712 | Ref. No. | 20127029 |
| description | membrane keypad suitable for ASTORIA L 147mm W 73mm | | |
| For models: | Giada-1, Giada-2, Sara-1GR-1, Sara-2GR-2 | | |

1 

| | | | |
|--------------------|---|-----------------|----------|
| GEV No. | 402709 | Ref. No. | 20127003 |
| description | membrane keypad suitable for ASTORIA L 190mm W 60mm | | |
| For models: | CMA, Sara-1GR-1, Sara-2GR-2 | | |

1 

| | | | |
|--------------------|---|-----------------|----------|
| GEV No. | 402711 | Ref. No. | 20127028 |
| description | membrane keypad suitable for ASTORIA L 205mm W 73mm | | |
| For models: | Giada-1, Giada-2, Sara-1GR-1, Sara-2GR-2 | | |

keypad units

1 

| | | | |
|--------------------|---|-----------------|-------|
| GEV No. | 400350 | Ref. No. | 21274 |
| description | keypad unit | | |
| For models: | Argenta, Argenta-AEP-1, Argenta-AEP-2, Argenta-AEP-3, Argenta-AEP-4, Argenta-AEP-J, Argenta-SAE-1, Argenta-SAE-2, Argenta-SAE-3, Argenta-SAE-4, Argenta-SAE-J, Brava-SME-1, Brava-SME-2, Brava-SME-3, Brava-SME-4, Brava-SMSA-1, Brava-SMSA-2, Brava-SMSA-3, Brava-SMSA-4, Denise | | |

1 

| | | | |
|--------------------|--|-----------------|-------|
| GEV No. | 400353 | Ref. No. | 18354 |
| description | keypad unit | | |
| For models: | Argenta, Argenta-AEP-1, Argenta-AEP-2, Argenta-AEP-3, Argenta-AEP-4, Argenta-AEP-J, Argenta-SAE-1, Argenta-SAE-2, Argenta-SAE-3, Argenta-SAE-4, Argenta-SAE-J, CompattaArgenta | | |

1 

| | | | |
|--------------------|--|-----------------|----------|
| GEV No. | 400542 | Ref. No. | 18371010 |
| description | keypad unit | | |
| For models: | Divina, Divina-AEP-1, Divina-AEP-2, Divina-AEP-3, Divina-AEP-4, Divina-AEP-J, Divina-SAE-1, Divina-SAE-2, Divina-SAE-3, Divina-SAE-4, Divina-SAE-J | | |





| | | | |
|---|---|-----------------|-------|
|  | | | |
| 1 | | | |
| GEV No. | 400543 | Ref. No. | 21276 |
| description | keypad unit | | |
| For models: | Divina, Divina-AEP-1, Divina-AEP-2, Divina-AEP-3, Divina-AEP-4, Divina-AEP-J, Divina-SAE-1, Divina-SAE-2, Divina-SAE-3, Divina-SAE-4, Divina-SAE-J, Vania | | |

| | | | |
|--|---|-----------------|----------|
|  | | | |
| 1 | | | |
| GEV No. | 400532 | Ref. No. | 18371008 |
| description | keypad unit buttons 5 | | |
| For models: | CK, CK-CKE, CK-CKE-CK-1, CK-CKE-CKE-1, CKE, CKX-CKXE, CKX-CKXE-CKX-1, CKX-CKXE-CKXE-1 | | |

| | | | |
|---|---|-----------------|-------|
|  | | | |
| 1 | | | |
| GEV No. | 400352 | Ref. No. | 18365 |
| description | keypad unit 1 group buttons 5 type Dos. TH 1GR+RL L 68mm W 49mm | | |
| For models: | Argenta, Argenta-AEP-1, Argenta-AEP-2, Argenta-AEP-3, Argenta-AEP-4, Argenta-AEP-J, Argenta-SAE-1, Argenta-SAE-2, Argenta-SAE-3, Argenta-SAE-4, Argenta-SAE-J, Dora | | |

| | | | |
|--|---|-----------------|-------|
|  | | | |
| 1 | | | |
| GEV No. | 400540 | Ref. No. | 18359 |
| description | keypad unit buttons 5 | | |
| For models: | Brava, Brava-SME-1, Brava-SME-2, Brava-SME-3, Brava-SME-4, Brava-SMSA-1, Brava-SMSA-2, Brava-SMSA-3, Brava-SMSA-4 | | |

| | | | |
|--|--------------------|-----------------|----------|
|  | | | |
| 1 | | | |
| GEV No. | 400550 | Ref. No. | 18371016 |
| description | keypad unit 5-fold | | |
| For models: | Divina | | |

| | | | |
|--|---|-----------------|----------|
|  | | | |
| 1 | | | |
| GEV No. | 401636 | Ref. No. | 18371025 |
| description | keypad unit buttons 5 | | |
| For models: | Divina-AEP-1, Divina-AEP-2, Divina-AEP-3, Divina-AEP-4, Divina-AEP-J, Divina-SAE-1, Divina-SAE-2, Divina-SAE-3, Divina-SAE-4, Divina-SAE-J, Vania | | |

| | | | |
|---|--|-----------------|----------|
|  | | | |
| 1 | | | |
| GEV No. | 402209 | Ref. No. | 18371054 |
| description | keypad unit buttons 1 suitable for Astoria / Wega L 125mm W 75mm | | |
| For models: | Sibilla-AEP-1, Sibilla-AEP-2, Sibilla-AEP-3, Sibilla-DISPLAY-2, Sibilla-DISPLAY-3, Sibilla-SAE-1, Sibilla-SAE-2, Sibilla-SAE-3 | | |

| | | | |
|--|--|-----------------|-------|
|  | | | |
| 1 | | | |
| GEV No. | 527812 | Ref. No. | 18363 |
| description | keypad unit buttons 5 115V L 92mm W 44mm | | |

| | | | |
|---|--|-----------------|----------|
|  | | | |
| 1 | | | |
| GEV No. | 402218 | Ref. No. | 18371022 |
| description | keypad unit buttons 3 suitable for ASTORIA L 96mm W 48mm | | |
| For models: | Divina-AEP-1, Divina-AEP-2, Divina-AEP-3, Divina-AEP-4, Divina-AEP-J, Divina-SAE-1, Divina-SAE-2, Divina-SAE-3, Divina-SAE-4, Divina-SAE-J | | |

| | | | |
|--|---|-----------------|----------|
|  | | | |
| 1 | | | |
| GEV No. | 400541 | Ref. No. | 18359001 |
| description | keypad unit buttons 6 | | |
| For models: | Brava, Brava-SME-1, Brava-SME-2, Brava-SME-3, Brava-SME-4, Brava-SMSA-1, Brava-SMSA-2, Brava-SMSA-3, Brava-SMSA-4 | | |

| | | | |
|--|--------------------------------------|-----------------|-------------|
|  | | | |
| 1 | | | |
| GEV No. | 527753 | Ref. No. | WY83180014R |
| description | keypad unit buttons 7 L 136mm W 46mm | | |



1

| | | | |
|--------------------|--|-----------------|----------|
| GEV No. | 402211 | Ref. No. | 18371055 |
| description | keypad unit buttons 7 suitable for Astoria / Wega L 120mm W 75mm | | |
| For models: | Sibilla-AEP-1, Sibilla-AEP-2, Sibilla-AEP-3, Sibilla-DISPLAY-2, Sibilla-DISPLAY-3, Sibilla-SAE-1, Sibilla-SAE-2, Sibilla-SAE-3 | | |



1

| | | | |
|--------------------|--|-----------------|----------|
| GEV No. | 402210 | Ref. No. | 18371026 |
| description | keypad unit buttons 7 suitable for ASTORIA L 90mm W 42mm | | |
| For models: | Divina-AEP-1, Divina-AEP-2, Divina-AEP-3, Divina-AEP-4, Divina-AEP-J, Divina-SAE-1, Divina-SAE-2, Divina-SAE-3, Divina-SAE-4, Divina-SAE-J | | |



1

| | | | |
|--------------------|--|-----------------|----------|
| GEV No. | 400795 | Ref. No. | 18371049 |
| description | keypad unit coffee machine Atlas/OrionEco/EPU1PG buttons 5 L 89mm W 42mm | | |



1

| | | | |
|--------------------|--|-----------------|-----------|
| GEV No. | 527776 | Ref. No. | 83180011R |
| description | keypad unit coffee machine Gloria buttons 7 L 136mm W 45mm | | |
| For models: | Gloria-AEP-1, Gloria-AEP-2, Gloria-AEP-3, Gloria-AEP-4, Gloria-DISPLAY-LCL-2, Gloria-DISPLAY-LCL-3, Gloria-SAE-1, Gloria-SAE-2, Gloria-SAE-3, Gloria-SAE-4 | | |



1

| | | | |
|--------------------|---|-----------------|------------|
| GEV No. | 400789 | Ref. No. | WY18371027 |
| description | keypad unit coffee machine/espresso maker MININOVA/EPUMINIV buttons 5 L 66mm W 43mm | | |



1

| | | | |
|--------------------|--|-----------------|----------|
| GEV No. | 400545 | Ref. No. | 18371018 |
| description | keypad unit double | | |
| For models: | Divina, Divina-AEP-1, Divina-AEP-2, Divina-AEP-3, Divina-AEP-4, Divina-AEP-J, Divina-SAE-1, Divina-SAE-2, Divina-SAE-3, Divina-SAE-4, Divina-SAE-J | | |



1

| | | | |
|--------------------|--|-----------------|----------|
| GEV No. | 400546 | Ref. No. | 18371021 |
| description | keypad unit double | | |
| For models: | Divina, Divina-AEP-1, Divina-AEP-2, Divina-AEP-3, Divina-AEP-4, Divina-AEP-J, Divina-SAE-1, Divina-SAE-2, Divina-SAE-3, Divina-SAE-4, Divina-SAE-J | | |



1

| | | | |
|--------------------|--|-----------------|----------|
| GEV No. | 400548 | Ref. No. | 18371019 |
| description | keypad unit double | | |
| For models: | Divina, Divina-AEP-1, Divina-AEP-2, Divina-AEP-3, Divina-AEP-4, Divina-AEP-J, Divina-SAE-1, Divina-SAE-2, Divina-SAE-3, Divina-SAE-4, Divina-SAE-J | | |



1

| | | | |
|--------------------|--|-----------------|----------|
| GEV No. | 400547 | Ref. No. | 18371017 |
| description | keypad unit espresso machine DIVINA single | | |
| For models: | Divina, Divina-AEP-1, Divina-AEP-2, Divina-AEP-3, Divina-AEP-4, Divina-AEP-J, Divina-SAE-1, Divina-SAE-2, Divina-SAE-3, Divina-SAE-4, Divina-SAE-J | | |



1

| | | | |
|--------------------|--|-----------------|----------|
| GEV No. | 400549 | Ref. No. | 18371020 |
| description | keypad unit triple | | |
| For models: | Divina, Divina-AEP-1, Divina-AEP-2, Divina-AEP-3, Divina-AEP-4, Divina-AEP-J, Divina-SAE-1, Divina-SAE-2, Divina-SAE-3, Divina-SAE-4, Divina-SAE-J | | |



control panel

| | | | |
|--------------------|---|-----------------|----------|
| 1 |  | | |
| GEV No. | 527749 | Ref. No. | 15373043 |
| description | control panel L 120mm W 58mm plastic | | |

| | | | |
|--------------------|---|-----------------|------------|
| 1 |  | | |
| GEV No. | 527766 | Ref. No. | WY15373042 |
| description | control panel L 120mm W 58mm plastic | | |

| | | | |
|--------------------|---|-----------------|------------|
| 1 |  | | |
| GEV No. | 527767 | Ref. No. | WY15373044 |
| description | control panel L 120mm W 58mm plastic | | |

| | | | |
|--------------------|---|-----------------|------------|
| 1 |  | | |
| GEV No. | 527751 | Ref. No. | WY15373045 |
| description | control panel L 121mm W 58mm plastic | | |

| | | | |
|--------------------|---|-----------------|------------|
| 1 |  | | |
| GEV No. | 527755 | Ref. No. | WY15373041 |
| description | control panel L 121mm W 58mm plastic | | |

accessories

| | | | |
|--------------------|---|-----------------|----------|
| 1 |  | | |
| GEV No. | 527824 | Ref. No. | 15373048 |
| description | button L 22mm W 19.2mm chrome-plated | | |

| | | | |
|--------------------|---|-----------------|------------|
| 1 |  | | |
| GEV No. | 527743 | Ref. No. | WY15373051 |
| description | cover L 121mm W 58mm H 20mm plastic | | |

| | | | |
|--------------------|--|-----------------|------------|
| 1 |  | | |
| GEV No. | 527750 | Ref. No. | WY15373046 |
| description | cover L 121mm W 58mm H 23mm plastic | | |

| | | | |
|--------------------|--|-----------------|----------|
| 1 |  | | |
| GEV No. | 527611 | Ref. No. | 15182996 |
| description | gasket for keypad L 144mm W 55mm thickness 2mm Neoprene | | |
| For models: | Gloria-AEP-1, Gloria-AEP-2, Gloria-AEP-3, Gloria-AEP-4, Gloria-DISPLAY-LCL-2, Gloria-DISPLAY-LCL-3, Gloria-SAE-1, Gloria-SAE-2, Gloria-SAE-3, Gloria-SAE-4 | | |

| | | | |
|--------------------|--|-----------------|----------|
| 1 |  | | |
| GEV No. | 527613 | Ref. No. | 15373103 |
| description | housing for display L 135mm W 44mm H 20mm plastic | | |
| For models: | Gloria-AEP-1, Gloria-AEP-2, Gloria-AEP-3, Gloria-AEP-4, Gloria-DISPLAY-LCL-2, Gloria-DISPLAY-LCL-3, Gloria-SAE-1, Gloria-SAE-2, Gloria-SAE-3, Gloria-SAE-4 | | |

| | | | |
|--------------------|--|-----------------|------------|
| 1 |  | | |
| GEV No. | 527762 | Ref. No. | WY15373017 |
| description | housing L 119mm W 51mm H 34mm plastic | | |

| | | | |
|--------------------|--|-----------------|------------|
| 1 |  | | |
| GEV No. | 527742 | Ref. No. | WY18371041 |
| description | housing L 119mm W 52mm H 50mm plastic | | |

| | | | |
|--------------------|--|-----------------|----------------------|
| 1 |  | | |
| GEV No. | 527744 | Ref. No. | 15373111 15373116 |
| description | housing L 136mm W 45mm H 20mm plastic | | |

| | | | |
|--------------------|--|-----------------|----------|
| 1 |  | | |
| GEV No. | 527791 | Ref. No. | 18371061 |
| description | keypad unit horizontal L 105mm W 70mm buttons 1 | | |
| For models: | Sibilla-AEP-1, Sibilla-AEP-2, Sibilla-AEP-3, Sibilla-DISPLAY-2, Sibilla-DISPLAY-3, Sibilla-SAE-1, Sibilla-SAE-2, Sibilla-SAE-3 | | |



| | | | |
|---|--|-----------------|----------|
|  | | | |
| 1 | | | |
| GEV No. | 527781 | Ref. No. | 18371059 |
| description | keypad unit mounting pos. horizontal W 70mm L 105mm buttons 1 | | |
| For models: | Sibilla-AEP-1, Sibilla-AEP-2, Sibilla-AEP-3, Sibilla-DISPLAY-2, Sibilla-DISPLAY-3, Sibilla-SAE-1, Sibilla-SAE-2, Sibilla-SAE-3 | | |

| | | | |
|---|--|-----------------|----------|
|  | | | |
| 1 | | | |
| GEV No. | 511564 | Ref. No. | 18371062 |
| description | keypad unit mounting pos. horizontal W 71mm L 157mm buttons 1 | | |
| For models: | Sibilla-AEP-1, Sibilla-AEP-2, Sibilla-AEP-3, Sibilla-DISPLAY-2, Sibilla-DISPLAY-3, Sibilla-SAE-1, Sibilla-SAE-2, Sibilla-SAE-3 | | |

| | | | |
|---|--|-----------------|----------|
|  | | | |
| 1 | | | |
| GEV No. | 402212 | Ref. No. | 18371053 |
| description | switch panel complete L 158mm W 70mm buttons 3 for Astoria / Wega | | |
| For models: | Sibilla-AEP-1, Sibilla-AEP-2, Sibilla-AEP-3, Sibilla-DISPLAY-2, Sibilla-DISPLAY-3, Sibilla-SAE-1, Sibilla-SAE-2, Sibilla-SAE-3 | | |

| | | | |
|--|----------------------------|-----------------|----------|
|  | | | |
| 1 | | | |
| GEV No. | 527816 | Ref. No. | 77595000 |
| description | switch panel L 86mm W 40mm | | |

solenoid valves

solenoid valves (water)



metal

ASCO

spare parts and accessories

O-rings

| | | | |
|---|---|-----------------|-------|
|  | | | |
| 1 | | | |
| GEV No. | 371095 | Ref. No. | 12305 |
| description | O-ring Viton thickness 1.78mm ID ø 6.07mm Qty 1 pcs | | |
| For models: | Argenta, Argenta-AEP-1, Argenta-AEP-2, Argenta-AEP-3, Argenta-AEP-4, Argenta-AEP-J, Argenta-SAE-1, Argenta-SAE-2, Argenta-SAE-3, Argenta-SAE-4, Argenta-SAE-J, Brava, Brava-SME-1, Brava-SME-2, Brava-SME-3, Brava-SME-4, Brava-SMSA-1, Brava-SMSA-2, Brava-SMSA-3, Brava-SMSA-4, CK, CK-CKE, CK-CKE-CK-1, CK-CKE-CKE-1, CKE, CKP, CKPE, CKX-CKXE, CKX-CKXE-CKX-1, CKX-CKXE-CKXE-1, CMA, CompattaArgenta, Denise, Divina, Divina-AEP-1, Divina-AEP-2, Divina-AEP-3, Divina-AEP-4, Divina-AEP-J, Divina-SAE-1, Divina-SAE-2, Divina-SAE-3, Divina-SAE-4, Divina-SAE-J, Dora, DiPiù-1, Giada-1, Giada-2, Gloria-AEP-1, Gloria-AEP-2...(Other models you can see in the webshop) | | |

| | | | |
|---|--|-----------------|-----------------|
| LUCIFER | | | |
| 2-way | | | |
| 121K series | | | |
|  | | | |
| 1 | | | |
| GEV No. | 370072 | Ref. No. | 18164 |
| description | solenoid valve connection 2-ways 230VAC connection 1/8" DN 3mm slide-on receptacle DIN -20° up to 130°C LUCIFER-PARKER type series 121K coil type DZ06S6 membranes FKM (water) p max 10bar | | |
| For models: | Argenta, Denise | | |
| spare parts for | 370072 | | |
|  | GEV No. | 371031 | Ref. No. |
| | | | — |
| | solenoid coil LUCIFER-PARKER 230VAC 9VA coil type DZ06S6 seat ø 15mm | | |
| accessories for | 370072 | | |
|  | GEV No. | 371090 | Ref. No. |
| | | | 18110 |
| | power socket plug type DIN 43650A screw | | |

| | | | |
|---|--|-----------------|-----------------|
| 3-way | | | |
| 131F series | | | |
|  | | | |
| 1 | | | |
| GEV No. | 370053 | Ref. No. | 18151 18153 |
| description | solenoid valve 3-ways 230VAC DN 2.5mm slide-on receptacle DIN -10 up to 140°C type series 131F coil type DZ06S6 membranes FKM (water/steam) p max 10bar flange 32x32mm | | |
| For models: | Argenta, Argenta-AEP-1, Argenta-AEP-2, Argenta-AEP-3, Argenta-AEP-4, Argenta-AEP-J, Argenta-SAE-1, Argenta-SAE-2, Argenta-SAE-3, Argenta-SAE-4, Argenta-SAE-J, Brava, Brava-SME-1, Brava-SME-2, Brava-SME-3, Brava-SME-4, Brava-SMSA-1, Brava-SMSA-2, Brava-SMSA-3, Brava-SMSA-4, CK, CK-CKE, CK-CKE-CK-1, CK-CKE-CKE-1, CKE, CKP, CKPE, CKX-CKXE, CKX-CKXE-CKX-1, CKX-CKXE-CKXE-1, CMA, CompattaArgenta, Denise, Divina, Divina-AEP-1, Divina-AEP-2, Divina-AEP-3, Divina-AEP-4, Divina-AEP-J, Divina-SAE-1, Divina-SAE-2, Divina-SAE-3, Divina-SAE-4, Divina-SAE-J, Dora, Giada-1, Giada-2, Gloria-AEP-1, Gloria-AEP-2, Gloria-AEP-3...(Other models you can see in the webshop) | | |
| spare parts for | 370053 | | |
|  | GEV No. | 370061 | Ref. No. |
| | | | AS01 |
| | solenoid valve body LUCIFER-PARKER 3-ways outer cone | | |
|  | GEV No. | 371031 | Ref. No. |
| | | | — |
| | solenoid coil LUCIFER-PARKER 230VAC 9VA coil type DZ06S6 seat ø 15mm | | |
| accessories for | 370053 | | |
|  | GEV No. | 371090 | Ref. No. |
| | | | 18110 |
| | power socket plug type DIN 43650A screw | | |
|  | GEV No. | 371095 | Ref. No. |
| | | | 12305 |
| | O-ring Viton thickness 1.78mm ID ø 6.07mm Qty 1 pcs | | |

Table continues overleaf





| | | | |
|---|--|--------|------------|
| accessories for | 370053 | | |
|  | GEV No. | 371100 | Ref. No. — |
| | O-ring silicone thickness 1.78mm ID ø 6.07mm Qty 1 pcs | | |

| 131K series | | | |
|---|---|----------|----------------------|
|  | | | |
| 1 | | | |
| GEV No. | 370605 ¹ | Ref. No. | 18161982 18161983 |
| description | solenoid valve 2-ways 230VAC connection 1/4" L 40mm DN 4mm slide-on receptacle DIN -10 up to 140°C coil type 491514Q3 D4G membranes ruby p max 1.8bar nickel-plated brass | | |
| For models: | Giada-1, Giada-2, Giada-Fridge-Cup-warmer-1, Gloria-AEP-1, Gloria-AEP-2, Gloria-AEP-3, Gloria-AEP-4, Gloria-DISPLAY-LCL-2, Gloria-DISPLAY-LCL-3, Gloria-SAE-1, Gloria-SAE-2, Gloria-SAE-3, Gloria-SAE-4, Sara-1GR-1, Sara-2GR-2, Sara-Fridge-Cup-warmer | | |

¹nickel-plated

| spare parts and accessories | | | |
|--|--|----------|------|
| valve bodies | | | |
|  | | | |
| 1 | | | |
| GEV No. | 370061 | Ref. No. | AS01 |
| description | solenoid valve body LUCIFER-PARKER 3-ways outer cone | | |

| ODE | | | |
|---|--|----------|----------|
| solenoid valves steam (water) | | | |
| 21A1 series | | | |
|  | | | |
| 1 | | | |
| GEV No. | 370603 | Ref. No. | 18161981 |
| description | solenoid valve brass 2-ways 230VAC inlet 1/4" outlet 1/4" controllable DN 3mm slide-on receptacle DIN -10 up to 140°C ODE type series 21A1 coil type BDU p max 10bar 50Hz | | |
| For models: | Giada-1, Giada-2, Gloria-AEP-1, Gloria-AEP-2, Gloria-AEP-3, Gloria-AEP-4, Gloria-DISPLAY-LCL-2, Gloria-DISPLAY-LCL-3, Gloria-SAE-1, Gloria-SAE-2, Gloria-SAE-3, Gloria-SAE-4, Sara-1GR-1, Sara-2GR-2 | | |

| 31A series | | | |
|---|--|----------|----------|
|  | | | |
| 1 | | | |
| GEV No. | 370604 | Ref. No. | 18161980 |
| description | solenoid valve brass 3-ways 230VAC connection 1/4" DN 3mm slide-on receptacle DIN -10 up to 140°C ODE type series 31A1 coil type BDU membranes FKM (water/steam) p max 5bar controllable | | |
| For models: | Giada-1, Giada-2, Gloria-AEP-1, Gloria-AEP-2, Gloria-AEP-3, Gloria-AEP-4, Gloria-DISPLAY-LCL-2, Gloria-DISPLAY-LCL-3, Gloria-SAE-1, Gloria-SAE-2, Gloria-SAE-3, Gloria-SAE-4, Sara-1GR-1, Sara-2GR-2 | | |



| PARKER | | | |
|---|---|----------|----------|
| 2-way | | | |
| VE-140 series | | | |
|  | | | |
| 1 | | | |
| GEV No. | 370141 ¹ | Ref. No. | 18161990 |
| description | solenoid valve 2-ways 208-240 inlet 1/4" outlet 1/4" connection 1/4" L 40mm DN 3mm slide-on receptacle DIN -10 up to 140°C type series VE-140 coil type ZB09 membranes ruby p max 8bar SS | | |
| For models: | CK-CKE, CK-CKE-CK-1, CK-CKE-CKE-1, CKX-CKXE, CKX-CKXE-CKX-1, CKX-CKXE-CKXE-1, Giada-1, Giada-2, Giada-Fridge-Cup-warmer-1, Sara-1GR-1, Sara-2GR-2, Sara-Fridge-Cup-warmer | | |

¹SS housing

|  | | | |
|---|--|----------|-------------------------------------|
| 1 | | | |
| GEV No. | 370140 | Ref. No. | 18162 WY18162004 WY4618162005 |
| description | solenoid valve 2-way-ways 230VAC connection 1/8" L 30mm DN 2.5mm slide-on receptacle DIN -10 up to 140°C coil type DZ06S6 membranes ruby p max 14bar brass | | |
| For models: | Argenta, Argenta-AEP-1, Argenta-AEP-2, Argenta-AEP-3, Argenta-AEP-4, Argenta-AEP-J, Argenta-SAE-1, Argenta-SAE-2, Argenta-SAE-3, Argenta-SAE-4, Argenta-SAE-J, Brava, Brava-SME-1, Brava-SME-2, Brava-SME-3, Brava-SME-4, Brava-SMSA-1, Brava-SMSA-2, Brava-SMSA-3, Brava-SMSA-4, CK, CK-CKE-CK-1, CK-CKE-CKE-1, CKE, CKX-CKXE, CKX-CKXE-CKX-1, CKX-CKXE-CKXE-1, CMA, CompattaArgenta, Denise, Divina, Divina-AEP-1, Divina-AEP-2, Divina-AEP-3, Divina-AEP-4, Divina-AEP-J, Divina-SAE-1, Divina-SAE-2, Divina-SAE-3, Divina-SAE-4, Divina-SAE-J, Dora, ELE-03, Giada-1, Giada-2, Gloria-AEP-1, Gloria-AEP-2, Gloria-AEP-3, Gloria-AEP-4, Gloria-DISPLAY-LCL-2... (Other models you can see in the webshop) | | |

E-146 series



| | | | |
|---|---|-----------------|----------------|
| GEV No. | 370206 | Ref. No. | 18161 |
| description | solenoid valve 2-ways 230VAC connection 1/8" L 40mm DN 2.5mm slide-on receptacle DIN -20° up to 130°C PARKER type series VE-146 coil type ZB09 membranes FKM (water) p max 15bar p min 0bar | | |
| spare parts for | 370206 | | |
|  | GEV No. | 371029 | Ref. No. — |
| solenoid coil PARKER 230VAC 9VA coil type ZB09 seat ø 14mm H 33mm W 34mm D 43mm | | | |
| accessories for | 370206 | | |
|  | GEV No. | 371090 | Ref. No. 18110 |
| power socket plug type DIN 43650A screw | | | |

3-way





301X series



| | | | |
|--------------------|---|-----------------|------------|
| GEV No. | 370841 | Ref. No. | 834718151R |
| description | solenoid valve NSF 3-ways 220-240V -40 up to +140°C type series 301X coil type 483510S6 XS03XS6 F p max 14bar 50/60Hz | | |

VE-128 series



| | | | |
|---|---|-----------------|----------------|
| GEV No. | 370057 | Ref. No. | 18157 |
| description | solenoid valve 3-ways 230VAC body outer cone DN 1.2mm slide-on receptacle DIN -20° up to 140°C PARKER type series VE-128 coil type ZB09 membranes ruby p max 10bar brass flange 32x32mm | | |
| spare parts for | 370057 | | |
|  | GEV No. | 370062 | Ref. No. AS01 |
| solenoid valve body PARKER 3-ways outer cone | | | |
|  | GEV No. | 371029 | Ref. No. — |
| solenoid coil PARKER 230VAC 9VA coil type ZB09 seat ø 14mm H 33mm W 34mm D 43mm | | | |
| accessories for | 370057 | | |
|  | GEV No. | 371090 | Ref. No. 18110 |
| power socket plug type DIN 43650A screw | | | |
|  | GEV No. | 371095 | Ref. No. 12305 |
| O-ring Viton thickness 1.78mm ID ø 6.07mm Qty 1 pcs | | | |

| | | | |
|---|---------|--------|------------|
| accessories for | 370057 | | |
|  | GEV No. | 371100 | Ref. No. — |
| O-ring silicone thickness 1.78mm ID ø 6.07mm Qty 1 pcs | | | |

spare parts and accessories

valve bodies



| | | | |
|---|--|-----------------|----------------|
| GEV No. | 370062 | Ref. No. | AS01 |
| description | solenoid valve body PARKER 3-ways outer cone | | |
| accessories for | 370062 | | |
|  | GEV No. | 371029 | Ref. No. — |
| solenoid coil PARKER 230VAC 9VA coil type ZB09 seat ø 14mm H 33mm W 34mm D 43mm | | | |
|  | GEV No. | 371030 | Ref. No. — |
| solenoid coil 24VDC 12VA coil type ZB12 seat ø 14mm | | | |
|  | GEV No. | 371033 | Ref. No. — |
| solenoid coil PARKER 230VAC 9VA coil type YB09 with cable seat ø 14mm | | | |
|  | GEV No. | 371036 | Ref. No. — |
| solenoid coil 24VAC 9VA coil type ZB09 seat ø 14mm | | | |
|  | GEV No. | 371095 | Ref. No. 12305 |
| O-ring Viton thickness 1.78mm ID ø 6.07mm Qty 1 pcs | | | |
|  | GEV No. | 371100 | Ref. No. — |
| O-ring silicone thickness 1.78mm ID ø 6.07mm Qty 1 pcs | | | |

solenoid valves (refrigeration)

CASTEL

spare parts and accessories



| | | | |
|--------------------|---|-----------------|-------|
| GEV No. | 371090 | Ref. No. | 18110 |
| description | power socket plug type DIN 43650A screw | | |
| For models: | Argenta | | |



Solenoid valve - accessories

| | | | |
|---|--|-----------------|-------|
|  | | | |
| 1 | | | |
| GEV No. | 371095 | Ref. No. | 12305 |
| description | O-ring Viton thickness 1.78mm ID ø 6.07mm Qty 1 pcs | | |
| For models: | Argenta, Argenta-AEP-1, Argenta-AEP-2, Argenta-AEP-3, Argenta-AEP-4, Argenta-AEP-J, Argenta-SAE-1, Argenta-SAE-2, Argenta-SAE-3, Argenta-SAE-4, Argenta-SAE-J, Brava, Brava-SME-1, Brava-SME-2, Brava-SME-3, Brava-SME-4, Brava-SMSA-1, Brava-SMSA-2, Brava-SMSA-3, Brava-SMSA-4, CK, CK-CKE, CK-CKE-CK-1, CK-CKE-CKE-1, CKE, CKP, CKPE, CKX-CKXE, CKX-CKXE-CKX-1, CKX-CKXE-CKXE-1, CMA, CompattaArgenta, Denise, Divina, Divina-AEP-1, Divina-AEP-2, Divina-AEP-3, Divina-AEP-4, Divina-AEP-J, Divina-SAE-1, Divina-SAE-2, Divina-SAE-3, Divina-SAE-4, Divina-SAE-J, Dora, DPiu-1, Giada-1, Giada-2, Gloria-AEP-1, Gloria-AEP-2...(Other models you can see in the webshop) | | |

| | | | |
|--|--|-----------------|-------|
|  | | | |
| 1 | | | |
| GEV No. | 400213 | Ref. No. | 20251 |
| description | level electrode 1/4" total length 125mm probe L 98mm insulated probe length 26mm connection male faston 6.3mm stainless steel ø 2.5mm | | |
| For models: | Argenta, Argenta-AEP-1, Argenta-AEP-2, Argenta-AEP-3, Argenta-AEP-4, Argenta-AEP-J, Argenta-SAE-1, Argenta-SAE-2, Argenta-SAE-3, Argenta-SAE-4, Argenta-SAE-J, Brava, Brava-SME-1, Brava-SME-2, Brava-SME-3, Brava-SME-4, Brava-SMSA-1, Brava-SMSA-2, Brava-SMSA-3, Brava-SMSA-4, CK, CK-CKE, CK-CKE-CK-1, CK-CKE-CKE-1, CKE, CKP, CKPE, CKX-CKXE, CKX-CKXE-CKX-1, CKX-CKXE-CKXE-1, CMA, CompattaArgenta, Denise, Divina, Divina-AEP-1, Divina-AEP-2, Divina-AEP-3, Divina-AEP-4, Divina-AEP-J, Divina-SAE-1, Divina-SAE-2, Divina-SAE-3, Divina-SAE-4, Divina-SAE-J, Dora, Giada-1, Giada-2, Gloria-AEP-1, Gloria-AEP-2, Gloria-AEP-3...(Other models you can see in the webshop) | | |

pressure switches

for coffee machines

| | | | |
|--|--|-----------------|-------|
|  | | | |
| ø 38mm | | | |
| 1 | | | |
| GEV No. | 541089 | Ref. No. | 20155 |
| description | pressure control ø 38mm pressure range 0.5-1.2bar pressure connection vertical 16A 250V coffee machine parts connection 1/8" ambient temperature max. 125°C pressure connection 1/8" | | |
| For models: | CK, CK-CKE, CK-CKE-CK-1, CK-CKE-CKE-1, CKE, CKP, CKPE, CKX-CKXE, CKX-CKXE-CKX-1, CKX-CKXE-CKXE-1, ELE-03 | | |

| | | | |
|--|--|-----------------|-------|
|  | | | |
| 1 | | | |
| GEV No. | 401157 | Ref. No. | 20258 |
| description | level electrode 1/4" total length 150mm probe L 122mm insulated probe length 26mm connection male faston 6.3mm stainless steel ø 2.5mm | | |
| For models: | CMA, Giada-1, Giada-2, Sara-1GR-1, Sara-2GR-2 | | |

electrodes

| | | | |
|---|---|-----------------|-------|
|  | | | |
| 1 | | | |
| GEV No. | 401872 | Ref. No. | 20261 |
| description | level electrode 1/4" total length 100mm probe L 64mm insulated probe length 17mm connection male faston 6.3mm stainless steel ø 2.5mm | | |
| For models: | Sibilla-AEP-1, Sibilla-AEP-2, Sibilla-AEP-3, Sibilla-DISPLAY-2, Sibilla-DISPLAY-3, Sibilla-SAE-1, Sibilla-SAE-2, Sibilla-SAE-3 | | |

| | | | |
|---|---|-----------------|----------------|
|  | | | |
| 1 | | | |
| GEV No. | 400551 | Ref. No. | 20252 20525 |
| description | level electrode 1/4" total length 255mm probe L 230mm insulated probe length 26mm connection male faston 6.3mm chrome-plated ø 3mm rubber | | |
| For models: | CK, CK-CKE, CK-CKE-CK-1, CK-CKE-CKE-1, CKP, CKX-CKXE-CKX-1, CKX-CKXE-CKXE-1 | | |



flow meters and flow sensors

flow meters

GICAR



| | | | |
|--|---|-----------------|-------------------|
| 1 | | | |
| GEV No. | 400004 | Ref. No. | 18126 |
| description | flow meter thread 1/4" stainless steel with LED plug connection approval NSF | | |
| For models: | Argenta, Argenta-AEP-1, Argenta-AEP-2, Argenta-AEP-3, Argenta-AEP-4, Argenta-AEP-J, Argenta-SAE-1, Argenta-SAE-2, Argenta-SAE-3, Argenta-SAE-4, Argenta-SAE-J, Brava, Brava-SME-1, Brava-SME-2, Brava-SME-3, Brava-SME-4, Brava-SMSA-1, Brava-SMSA-2, Brava-SMSA-3, Brava-SMSA-4, CK-CKE, CK-CKE-CK-1, CK-CKE-CKE-1, CKE, CKPE, CKX-CKXE, CKX-CKXE-CKX-1, CKX-CKXE-CKXE-1, CMA, CompattaArgenta, Denise, Divina, Divina-AEP-1, Divina-AEP-2, Divina-AEP-3, Divina-AEP-4, Divina-AEP-J, Divina-SAE-1, Divina-SAE-2, Divina-SAE-3, Divina-SAE-4, Divina-SAE-J, Dora, DPiu-1, Giada-1, Giada-2, Gloria-AEP-1, Gloria-AEP-2, Gloria-AEP-3, Gloria-AEP-4...(Other models you can see in the webshop) | | |
| accessories for | 400004 | | |
|  | GEV No. | 400256 | Ref. No. — |
| | plug GICAR for flow meter | | |

accessories



| | | | |
|--------------------|---|-----------------|-------|
| 1 | | | |
| GEV No. | 400257 | Ref. No. | 13505 |
| description | impellor GICAR H 15mm D1 ø 26.7mm D2 ø 9.8mm for flow meter | | |



| | | | |
|--------------------|--|-----------------|-------|
| 1 | | | |
| GEV No. | 400258 | Ref. No. | 12315 |
| description | O-ring for flow meter | | |
| For models: | Argenta, Argenta-AEP-1, Argenta-AEP-2, Argenta-AEP-3, Argenta-AEP-4, Argenta-AEP-J, Argenta-SAE-1, Argenta-SAE-2, Argenta-SAE-3, Argenta-SAE-4, Argenta-SAE-J, Brava, Brava-SME-1, Brava-SME-2, Brava-SME-3, Brava-SME-4, Brava-SMSA-1, Brava-SMSA-2, Brava-SMSA-3, Brava-SMSA-4, CK, CK-CKE, CK-CKE-CK-1, CK-CKE-CKE-1, CKE, CKP, CKPE, CKX-CKXE, CKX-CKXE-CKX-1, CKX-CKXE-CKXE-1, CMA, CompattaArgenta, Denise, Divina, Divina-AEP-1, Divina-AEP-2, Divina-AEP-3, Divina-AEP-4, Divina-AEP-J, Divina-SAE-1, Divina-SAE-2, Divina-SAE-3, Divina-SAE-4, Divina-SAE-J, Dora, DPiu-1, Giada-1, Giada-2, Gloria-AEP-1, Gloria-AEP-2...(Other models you can see in the webshop) | | |

motors

gear motors

for automatic coffee machines



| | | | |
|--------------------|--|-----------------|-------------------------------|
| 1 | | | |
| GEV No. | 501379 | Ref. No. | 18333 18333001 18333002 |
| description | gear motor BCZ type 509 CC 24V 5rpm shaft ø 8.5mm for coffee machine | | |
| For models: | CMA, DPiu-1, Giada-1, Giada-2, Sara-1GR-1, Sara-2GR-2 | | |

pumps

booster pumps II

pump motors

clip connection



1

| | | | |
|--------------------|--|-----------------|-------------------------|
| GEV No. | 500061 | Ref. No. | 18300 18301 18312 |
| description | pump motor RPM type 11002755 165W 230V 50Hz connection clip L 160mm W 160mm H 170mm capacitor 10µF | | |
| For models: | Argenta, Argenta-AEP-1, Argenta-AEP-2, Argenta-AEP-3, Argenta-AEP-4, Argenta-AEP-J, Argenta-SAE-1, Argenta-SAE-2, Argenta-SAE-3, Argenta-SAE-4, Argenta-SAE-J, Brava, Brava-SME-1, Brava-SME-2, Brava-SME-3, Brava-SME-4, Brava-SMSA-1, Brava-SMSA-2, Brava-SMSA-3, Brava-SMSA-4, CK-CKE-CK-1, CK-CKE-CKE-1, CKX-CKXE-CKX-1, CKX-CKXE-CKXE-1, CompattaArgenta, Denise, Divina, Divina-AEP-1, Divina-AEP-2, Divina-AEP-3, Divina-AEP-4, Divina-AEP-J, Divina-SAE-1, Divina-SAE-2, Divina-SAE-3, Divina-SAE-4, Divina-SAE-J, Dora, Gloria-AEP-1, Gloria-AEP-2, Gloria-AEP-3, Gloria-AEP-4, Gloria-DISPLAY-LCL-2, Gloria-DISPLAY-LCL-3, Gloria-SAE-1, Gloria-SAE-2, Gloria-SAE-3, Gloria-SAE-4, Vania | | |



1

| | | | |
|---|---|-----------------|-------------------|
| GEV No. | 500072 | Ref. No. | 18303 18304 |
| description | pump motor RPM type C013726 120W 230V 50/60Hz connection clip L 145mm W 125mm H 110mm capacitor 6.3µF at 50Hz 1320rpm at 60Hz 1570rpm flange ø1 47.5mm flange ø2 38.3mm shaft diameter 5x11.5mm | | |
| For models: | Argenta-AEP-1, Argenta-AEP-2, Argenta-AEP-3, Argenta-AEP-4, Argenta-AEP-J, Argenta-SAE-1, Argenta-SAE-2, Argenta-SAE-3, Argenta-SAE-4, Argenta-SAE-J, Brava-SME-1, Brava-SME-2, Brava-SME-3, Brava-SME-4, Brava-SMSA-1, Brava-SMSA-2, Brava-SMSA-3, Brava-SMSA-4, CK-CKE, CK-CKE-CK-1, CK-CKE-CKE-1, CKX-CKXE, CKX-CKXE-CKX-1, CKX-CKXE-CKXE-1, CompattaArgenta, Divina-AEP-1, Divina-AEP-2, Divina-AEP-3, Divina-AEP-4, Divina-AEP-J, Divina-SAE-1, Divina-SAE-2, Divina-SAE-3, Divina-SAE-4, Divina-SAE-J, Gloria-AEP-1, Gloria-AEP-2, Gloria-AEP-3, Gloria-AEP-4, Gloria-DISPLAY-LCL-2, Gloria-DISPLAY-LCL-3, Gloria-SAE-1, Gloria-SAE-2, Gloria-SAE-3, Gloria-SAE-4 | | |
| accessories for | 500072 | | |
|  | GEV No. | 365012 | Ref. No. — |
| | operating capacitor capacity 6.3µF 450V tolerance 5% 50Hz ambient temperature max. -25 to +85°C ø 30mm L 61mm M8 plastic connection male faston 6.3mm protection | | |



1

| | | | |
|--------------------|--|-----------------|-------|
| GEV No. | 500225 | Ref. No. | 56406 |
| description | pump motor RPM type C042200 330W 230V 50/60Hz L 135mm W 110mm H 110mm capacitor 7µF | | |
| For models: | Argenta, Argenta-AEP-1, Argenta-AEP-2, Argenta-AEP-3, Argenta-AEP-4, Argenta-AEP-J, Argenta-SAE-1, Argenta-SAE-2, Argenta-SAE-3, Argenta-SAE-4, Argenta-SAE-J, Brava, Brava-SME-1, Brava-SME-2, Brava-SME-3, Brava-SME-4, Brava-SMSA-1, Brava-SMSA-2, Brava-SMSA-3, Brava-SMSA-4, CompattaArgenta, Denise, Divina, Divina-AEP-1, Divina-AEP-2, Divina-AEP-3, Divina-AEP-4, Divina-AEP-J, Divina-SAE-1, Divina-SAE-2, Divina-SAE-3, Divina-SAE-4, Divina-SAE-J, Giada-1, Giada-2, Gloria-AEP-1, Gloria-AEP-2, Gloria-AEP-3, Gloria-AEP-4, Gloria-DISPLAY-LCL-2, Gloria-DISPLAY-LCL-3, Gloria-SAE-1, Gloria-SAE-2, Gloria-SAE-3, Gloria-SAE-4, Sara-1GR-1, Sara-2GR-2, Vania | | |



1

| | | | |
|--------------------|--|-----------------|-------|
| GEV No. | 500226 | Ref. No. | 56402 |
| description | pump motor ZECCHIN 230V 50/60Hz connection clip L 130mm W 100mm H 155mm | | |
| For models: | Argenta, Argenta-AEP-1, Argenta-AEP-2, Argenta-AEP-3, Argenta-AEP-4, Argenta-AEP-J, Argenta-SAE-1, Argenta-SAE-2, Argenta-SAE-3, Argenta-SAE-4, Argenta-SAE-J, Brava, Brava-SME-1, Brava-SME-2, Brava-SME-3, Brava-SME-4, Brava-SMSA-1, Brava-SMSA-2, Brava-SMSA-3, Brava-SMSA-4, CompattaArgenta, Denise, Divina, Divina-AEP-1, Divina-AEP-2, Divina-AEP-3, Divina-AEP-4, Divina-AEP-J, Divina-SAE-1, Divina-SAE-2, Divina-SAE-3, Divina-SAE-4, Divina-SAE-J, Dora, Gloria-AEP-1, Gloria-AEP-2, Gloria-AEP-3, Gloria-AEP-4, Gloria-DISPLAY-LCL-2, Gloria-DISPLAY-LCL-3, Gloria-SAE-1, Gloria-SAE-2, Gloria-SAE-3, Gloria-SAE-4, Vania | | |

pump heads

FLUID-O-TECH



| | | | |
|---|---|-----------------|-------------------|
| 1 | | | |
| GEV No. | 500064 | Ref. No. | 26303 |
| description | pump head PO204 FLUID-O-TECH L 82mm 200l/h connection 3/8" GAS with bypass brass clip connection for coffee machine shaft ø 4.8x11mm | | |
| For models: | Argenta, Argenta-AEP-1, Argenta-AEP-2, Argenta-AEP-3, Argenta-AEP-4, Argenta-AEP-J, Argenta-SAE-1, Argenta-SAE-2, Argenta-SAE-3, Argenta-SAE-4, Argenta-SAE-J, Brava, Brava-SME-1, Brava-SME-2, Brava-SME-3, Brava-SME-4, Brava-SMSA-1, Brava-SMSA-2, Brava-SMSA-3, Brava-SMSA-4, CK-CKE-CK-1, CK-CKE-CKE-1, CKX-CKXE-CKX-1, CKX-CKXE-CKXE-1, CompattaArgenta, Denise, Divina, Divina-AEP-1, Divina-AEP-2, Divina-AEP-3, Divina-AEP-4, Divina-AEP-J, Divina-SAE-1, Divina-SAE-2, Divina-SAE-3, Divina-SAE-4, Divina-SAE-J, Dora, Giada-1, Giada-2, Gloria-AEP-1, Gloria-AEP-2, Gloria-AEP-3, Gloria-AEP-4, Gloria-DISPLAY-LCL-2, Gloria-DISPLAY-LCL-3, Gloria-SAE-1, Gloria-SAE-2, Gloria-SAE-3, Gloria-SAE-4...(Other models you can see in the webshop) | | |
| accessories for | 500064 | | |
|  | GEV No. | 520126 | Ref. No. — |
| | clamp for pump/motor | | |

PROCON



| | | | |
|---|---|-----------------|-------------------|
| 1 | | | |
| GEV No. | 500230 | Ref. No. | 26302 |
| description | pump head V6105 PROCON L 82mm 180l/h connection 3/8" NPT with bypass brass clip connection for coffee machine shaft ø 4.8x11mm | | |
| For models: | Argenta, Argenta-AEP-1, Argenta-AEP-2, Argenta-AEP-3, Argenta-AEP-4, Argenta-AEP-J, Argenta-SAE-1, Argenta-SAE-2, Argenta-SAE-3, Argenta-SAE-4, Argenta-SAE-J, Brava, Brava-SME-1, Brava-SME-2, Brava-SME-3, Brava-SME-4, Brava-SMSA-1, Brava-SMSA-2, Brava-SMSA-3, Brava-SMSA-4, CK-CKE-CK-1, CK-CKE-CKE-1, CKX-CKXE-CKX-1, CKX-CKXE-CKXE-1, CompattaArgenta, Denise, Divina, Divina-AEP-1, Divina-AEP-2, Divina-AEP-3, Divina-AEP-4, Divina-AEP-J, Divina-SAE-1, Divina-SAE-2, Divina-SAE-3, Divina-SAE-4, Divina-SAE-J, Dora, Giada-1, Giada-2, Gloria-AEP-1, Gloria-AEP-2, Gloria-AEP-3, Gloria-AEP-4, Gloria-DISPLAY-LCL-2, Gloria-DISPLAY-LCL-3, Gloria-SAE-1, Gloria-SAE-2, Gloria-SAE-3, Gloria-SAE-4...(Other models you can see in the webshop) | | |
| accessories for | 500230 | | |
|  | GEV No. | 520126 | Ref. No. — |
| | clamp for pump/motor | | |

accessories



| | | | |
|--------------------|--|-----------------|-------|
| 1 | | | |
| GEV No. | 527190 | Ref. No. | 56116 |
| description | filter with integrated fine filter brass T1: 3/8" T2: 3/8" pump inlet | | |
| For models: | Argenta, Argenta-AEP-1, Argenta-AEP-2, Argenta-AEP-3, Argenta-AEP-4, Argenta-AEP-J, Argenta-SAE-1, Argenta-SAE-2, Argenta-SAE-3, Argenta-SAE-4, Argenta-SAE-J, Brava, Brava-SME-1, Brava-SME-2, Brava-SME-3, Brava-SME-4, Brava-SMSA-1, Brava-SMSA-2, Brava-SMSA-3, Brava-SMSA-4, CK-CKE-CK-1, CK-CKE-CKE-1, CKX-CKXE-CKX-1, CKX-CKXE-CKXE-1, CompattaArgenta, Denise, Divina-AEP-1, Divina-AEP-2, Divina-AEP-3, Divina-AEP-4, Divina-AEP-J, Divina-SAE-1, Divina-SAE-2, Divina-SAE-3, Divina-SAE-4, Divina-SAE-J, Dora, Gloria-AEP-1, Gloria-AEP-2, Gloria-AEP-3, Gloria-AEP-4, Gloria-DISPLAY-LCL-2, Gloria-DISPLAY-LCL-3, Gloria-SAE-1, Gloria-SAE-2, Gloria-SAE-3, Gloria-SAE-4, Vania | | |

vibration pumps



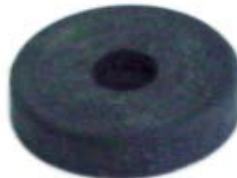

| | | | |
|--------------------|---|-----------------|-------|
| 1 | | | |
| GEV No. | 500245 | Ref. No. | 26306 |
| description | bracket for vibration pump | | |
| For models: | Argenta, CK, CK-CKE, CK-CKE-CK-1, CK-CKE-CKE-1, CKE, CKP, CKPE, CKX-CKXE, CKX-CKXE-CKX-1, CKX-CKXE-CKXE-1, Denise, Divina, Gloria-AEP-1, Gloria-AEP-2, Gloria-AEP-3, Gloria-AEP-4, Gloria-DISPLAY-LCL-2, Gloria-DISPLAY-LCL-3, Gloria-SAE-1, Gloria-SAE-2, Gloria-SAE-3, Gloria-SAE-4 | | |



| | | | |
|--------------------|---|-----------------|-------|
| 1 | | | |
| GEV No. | 500246 | Ref. No. | 15313 |
| description | foot for vibration pump | | |
| For models: | Argenta, CK, CK-CKE, CK-CKE-CK-1, CK-CKE-CKE-1, CKE, CKP, CKPE, CKX-CKXE, CKX-CKXE-CKX-1, CKX-CKXE-CKXE-1, Denise, Divina, Gloria-AEP-1, Gloria-AEP-2, Gloria-AEP-3, Gloria-AEP-4, Gloria-DISPLAY-LCL-2, Gloria-DISPLAY-LCL-3, Gloria-SAE-1, Gloria-SAE-2, Gloria-SAE-3, Gloria-SAE-4 | | |

1

| | | | |
|---|--|-----------------|-----------------------|
| GEV No. | 500123 | Ref. No. | 26304 26312 |
| description | vibration pump type 1106PAALM1N 230V 50Hz 70W inlet ø 1/8" IT outlet ø 1/8" IT outlet conical L 129mm FLUID-O-TECH | | |
| accessories for | 500123 | | |
|  | GEV No. | 371090 | Ref. No. 18110 |
| | power socket plug type DIN 43650A screw | | |
|  | GEV No. | 371120 | Ref. No. — |
| | diode type IN5408 | | |
|  | GEV No. | 390698 | Ref. No. — |
| | thermal fuse switch-off temp. 110°C suitable for ULKA pump | | |



1

| | | | |
|--------------------|---|-----------------|-------|
| GEV No. | 500438 | Ref. No. | 26304 |
| description | vibration pump type 1106PAILM1N 208/240V 50/60Hz 50W inlet ø 1/8" IT outlet ø 1/8" IT outlet conical L 128mm FLUID-O-TECH | | |
| For models: | Argenta, CK, CK-CKE, CK-CKE-CK-1, CK-CKE-CKE-1, CKE, CKP, CKPE, CKX-CKXE, CKX-CKXE-CKX-1, CKX-CKXE-CKXE-1, Denise, Divina | | |



1

| | | | |
|--------------------|---|-----------------|-------|
| GEV No. | 500173 | Ref. No. | 26316 |
| description | vibration pump type EP 5 230V 48W 50Hz inlet ø 6 outlet ø 1/8" IT ULKA outlet flat plastic L 123mm | | |
| For models: | Gloria-AEP-1, Gloria-AEP-2, Gloria-AEP-3, Gloria-AEP-4, Gloria-DISPLAY-LCL-2, Gloria-DISPLAY-LCL-3, Gloria-SAE-1, Gloria-SAE-2, Gloria-SAE-3, Gloria-SAE-4, Prima | | |



1

| | | | |
|--------------------|--|-----------------|-------|
| GEV No. | 500227 | Ref. No. | 26318 |
| description | vibration pump type NME Typ4 230V 16W 50Hz inlet ø 5 outlet ø 6.5 ULKA L 77mm 50cc/min | | |
| For models: | DPiu-1, Prima | | |

pumps for milk foamers

pumps



1

| | | | |
|--------------------|--|-----------------|-----------|
| GEV No. | 501380 | Ref. No. | 83260054R |
| description | pump set type M42x30/1 24V FLUID-O-TECH | | |
| For models: | Giada-1, Giada-2, Sara-1GR-1, Sara-2GR-2 | | |

condensators & interference suppression filters

operating capacitors

plastic



1

| | | | |
|--------------------|---|-----------------|-------|
| GEV No. | 365134 | Ref. No. | 19061 |
| description | operating capacitor capacity 16µF 450V tolerance 5% 50Hz ambient temperature max. -25 to +85°C ø 40mm L 71mm plastic connection cable 300mm MK16-450 protection | | |
| For models: | CMA, Coffee-Grinder-M, Coffee-grinder-M-1, Giada-1, Giada-2, Sara-1GR-1, Sara-2GR-2 | | |



1

| | | | |
|--------------------|--|-----------------|-------------------|
| GEV No. | 365135 | Ref. No. | 19062 19062001 |
| description | operating capacitor capacity 7µF 400V tolerance 5% 50Hz ambient temperature max. -25 to +85°C ø 30mm L 70mm plastic connection male faston 6.3mm MKA 7 protection | | |
| For models: | Argenta-AEP-1, Argenta-AEP-2, Argenta-AEP-3, Argenta-AEP-4, Argenta-AEP-J, Argenta-SAE-1, Argenta-SAE-2, Argenta-SAE-3, Argenta-SAE-4, Argenta-SAE-J, Brava-SME-1, Brava-SME-2, Brava-SME-3, Brava-SME-4, Brava-SMSA-1, Brava-SMSA-2, Brava-SMSA-3, Brava-SMSA-4, CMA, CompattaArgenta, Divina, Divina-AEP-1, Divina-AEP-2, Divina-AEP-3, Divina-AEP-4, Divina-AEP-J, Divina-SAE-1, Divina-SAE-2, Divina-SAE-3, Divina-SAE-4, Divina-SAE-J, Dora, Giada-1, Giada-2, Gloria-AEP-1, Gloria-AEP-2, Gloria-AEP-3, Gloria-AEP-4, Gloria-DISPLAY-LCL-2, Gloria-DISPLAY-LCL-3, Gloria-SAE-1, Gloria-SAE-2, Gloria-SAE-3, Gloria-SAE-4, Sara-1GR-1, Sara-2GR-2 | | |



1

| | | | |
|--------------------|--|-----------------|-------|
| GEV No. | 358608 | Ref. No. | 19104 |
| description | fine fuse size ø5x20mm 10A slow-acting rated 250V Qty 10 pcs | | |
| For models: | Argenta-AEP-1, Argenta-AEP-2, Argenta-AEP-3, Argenta-AEP-4, Argenta-AEP-J, Argenta-SAE-1, Argenta-SAE-2, Argenta-SAE-3, Argenta-SAE-4, Argenta-SAE-J, Brava-SME-1, Brava-SME-2, Brava-SME-3, Brava-SME-4, Brava-SMSA-1, Brava-SMSA-2, Brava-SMSA-3, Brava-SMSA-4, Divina-AEP-1, Divina-AEP-2, Divina-AEP-3, Divina-AEP-4, Divina-AEP-J, Divina-SAE-1, Divina-SAE-2, Divina-SAE-3, Divina-SAE-4, Divina-SAE-J, Dora, Giada-1, Giada-2, Gloria-AEP-1, Gloria-AEP-2, Gloria-AEP-3, Gloria-AEP-4, Gloria-DISPLAY-LCL-2, Gloria-DISPLAY-LCL-3, Gloria-SAE-1, Gloria-SAE-2, Gloria-SAE-3, Gloria-SAE-4, Rapallo-AEP-1, Rapallo-AEP-2, Rapallo-AEP-3, Rapallo-AEP-4, Rapallo-AL-1, Rapallo-AL-2, Rapallo-AL-3, Rapallo-AL-4, Sara-1GR-1...(Other models you can see in the webshop) | | |

fuses

fine fuses



1

| | | | |
|--------------------|--|-----------------|-------|
| GEV No. | 358532 | Ref. No. | 19101 |
| description | fine fuse size ø5x20mm 2A fast-acting rated 250V Qty 10 pcs | | |
| For models: | Argenta-AEP-1, Argenta-AEP-2, Argenta-AEP-3, Argenta-AEP-4, Argenta-AEP-J, Argenta-SAE-1, Argenta-SAE-2, Argenta-SAE-3, Argenta-SAE-4, Argenta-SAE-J, Brava-SME-1, Brava-SME-2, Brava-SME-3, Brava-SME-4, Brava-SMSA-1, Brava-SMSA-2, Brava-SMSA-3, Brava-SMSA-4, Divina-AEP-1, Divina-AEP-2, Divina-AEP-3, Divina-AEP-4, Divina-AEP-J, Divina-SAE-1, Divina-SAE-2, Divina-SAE-3, Divina-SAE-4, Divina-SAE-J, Giada-1, Giada-2, Gloria-AEP-1, Gloria-AEP-2, Gloria-AEP-3, Gloria-AEP-4, Gloria-DISPLAY-LCL-2, Gloria-DISPLAY-LCL-3, Gloria-SAE-1, Gloria-SAE-2, Gloria-SAE-3, Gloria-SAE-4, Rapallo-AEP-1, Rapallo-AEP-2, Rapallo-AEP-3, Rapallo-AEP-4, Rapallo-AL-1, Rapallo-AL-2, Rapallo-AL-3, Rapallo-AL-4, Sara-1GR-1, Sara-2GR-2...(Other models you can see in the webshop) | | |

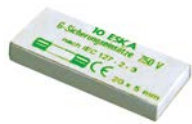

1

| | | | |
|--------------------|---|-----------------|-------|
| GEV No. | 358605 | Ref. No. | 19100 |
| description | fine fuse size ø5x20mm 3.15A slow-acting rated 250V Qty 10 pcs | | |
| For models: | CMA, Sara-1GR-1, Sara-2GR-2, Sibilla-AEP-1, Sibilla-AEP-2, Sibilla-AEP-3, Sibilla-DISPLAY-2, Sibilla-DISPLAY-3, Sibilla-SAE-1, Sibilla-SAE-2, Sibilla-SAE-3 | | |



1

| | | | |
|--------------------|---|-----------------|-------|
| GEV No. | 358607 | Ref. No. | 19103 |
| description | fine fuse size ø5x20mm 6.3A slow-acting rated 250V Qty 10 pcs | | |
| For models: | CompattaArgenta, Giada-1, Giada-2, Sara-1GR-1, Sara-2GR-2 | | |

fine fuse holders



1

| | | | |
|--------------------|--|-----------------|-------|
| GEV No. | 358597 | Ref. No. | 19106 |
| description | fine fuse size ø5x20mm 0.5A slow-acting rated 250V Qty 10 pcs | | |
| For models: | Argenta-AEP-1, Argenta-AEP-2, Argenta-AEP-3, Argenta-AEP-4, Argenta-AEP-J, Argenta-SAE-1, Argenta-SAE-2, Argenta-SAE-3, Argenta-SAE-4, Argenta-SAE-J, Brava-SME-1, Brava-SME-2, Brava-SME-3, Brava-SME-4, Brava-SMSA-1, Brava-SMSA-2, Brava-SMSA-3, Brava-SMSA-4, Divina-AEP-1, Divina-AEP-2, Divina-AEP-3, Divina-AEP-4, Divina-AEP-J, Divina-SAE-1, Divina-SAE-2, Divina-SAE-3, Divina-SAE-4, Divina-SAE-J, Giada-1, Giada-2, Gloria-AEP-1, Gloria-AEP-2, Gloria-AEP-3, Gloria-AEP-4, Gloria-DISPLAY-LCL-2, Gloria-DISPLAY-LCL-3, Gloria-SAE-1, Gloria-SAE-2, Gloria-SAE-3, Gloria-SAE-4, Rapallo-AEP-1, Rapallo-AEP-2, Rapallo-AEP-3, Rapallo-AEP-4, Rapallo-AL-1, Rapallo-AL-2, Rapallo-AL-3, Rapallo-AL-4, Sara-1GR-1, Sara-2GR-2...(Other models you can see in the webshop) | | |



1

| | | | |
|--------------------|---|-----------------|-------|
| GEV No. | 550558 | Ref. No. | 19122 |
| description | fuse holder suitable fuse ø5x20mm ø 12.5mm 10A rated 250V connection F4.8 | | |
| For models: | Argenta-AEP-1, Argenta-AEP-2, Argenta-AEP-3, Argenta-AEP-4, Argenta-AEP-J, Argenta-SAE-1, Argenta-SAE-2, Argenta-SAE-3, Argenta-SAE-4, Argenta-SAE-J, Brava-SME-1, Brava-SME-2, Brava-SME-3, Brava-SME-4, Brava-SMSA-1, Brava-SMSA-2, Brava-SMSA-3, Brava-SMSA-4, CMA, Divina-AEP-1, Divina-AEP-2, Divina-AEP-3, Divina-AEP-4, Divina-AEP-J, Divina-SAE-1, Divina-SAE-2, Divina-SAE-3, Divina-SAE-4, Divina-SAE-J, Giada-1, Giada-2, Gloria-AEP-1, Gloria-AEP-2, Gloria-AEP-3, Gloria-AEP-4, Gloria-DISPLAY-LCL-2, Gloria-DISPLAY-LCL-3, Gloria-SAE-1, Gloria-SAE-2, Gloria-SAE-3, Gloria-SAE-4, Rapallo-AEP-1, Rapallo-AEP-2, Rapallo-AEP-3, Rapallo-AEP-4, Rapallo-AL-1, Rapallo-AL-2, Rapallo-AL-3, Rapallo-AL-4, Sara-1GR-1...(Other models you can see in the webshop) | | |



electric accessories

cables

ribbon cables

group 1



| | | | |
|--------------------|--|-----------------|----------|
| GEV No. | 550839 | Ref. No. | 22554007 |
| description | ribbon cable 20-pole L 135mm plug type coded plug | | |
| For models: | Gloria-AEP-1, Gloria-AEP-2, Gloria-AEP-3, Gloria-AEP-4, Gloria-DISPLAY-LCL-2, Gloria-DISPLAY-LCL-3, Gloria-SAE-1, Gloria-SAE-2, Gloria-SAE-3, Gloria-SAE-4 | | |

group 2



| | | | |
|--------------------|---|-----------------|-------|
| GEV No. | 401871 | Ref. No. | 22608 |
| description | cable 8-pole L 900mm | | |
| For models: | Argenta, Argenta-AEP-1, Argenta-AEP-2, Argenta-AEP-3, Argenta-AEP-4, Argenta-AEP-J, Argenta-SAE-1, Argenta-SAE-2, Argenta-SAE-3, Argenta-SAE-4, Argenta-SAE-J, Brava-SME-1, Brava-SME-2, Brava-SME-3, Brava-SME-4, Brava-SMSA-1, Brava-SMSA-2, Brava-SMSA-3, Brava-SMSA-4, CK, CK-CKE, CK-CKE-CK-1, CK-CKE-CKE-1, CKPE, CKPE, CKX-CKXE, CKX-CKXE-CKX-1, CKX-CKXE-CKXE-1, CompattaArgenta, Denise, Divina-AEP-1, Divina-AEP-2, Divina-AEP-3, Divina-AEP-4, Divina-AEP-J, Divina-SAE-1, Divina-SAE-2, Divina-SAE-3, Divina-SAE-4, Divina-SAE-J, Rapallo-AEP-1, Rapallo-AEP-2, Rapallo-AEP-3, Rapallo-AEP-4, Rapallo-AL-1, Rapallo-AL-2, Rapallo-AL-3, Rapallo-AL-4, Sibilla-AEP-1...(Other models you can see in the webshop) | | |



| | | | |
|--------------------|--|-----------------|-------|
| GEV No. | 401870 | Ref. No. | 22609 |
| description | ribbon cable 8-pole L 1400mm | | |
| For models: | Argenta, Argenta-AEP-1, Argenta-AEP-2, Argenta-AEP-3, Argenta-AEP-4, Argenta-AEP-J, Argenta-SAE-1, Argenta-SAE-2, Argenta-SAE-3, Argenta-SAE-4, Argenta-SAE-J, Brava-SME-1, Brava-SME-2, Brava-SME-3, Brava-SME-4, Brava-SMSA-1, Brava-SMSA-2, Brava-SMSA-3, Brava-SMSA-4, CompattaArgenta, Denise, Divina-AEP-1, Divina-AEP-2, Divina-AEP-3, Divina-AEP-4, Divina-AEP-J, Divina-SAE-1, Divina-SAE-2, Divina-SAE-3, Divina-SAE-4, Divina-SAE-J, Rapallo-AEP-1, Rapallo-AEP-2, Rapallo-AEP-3, Rapallo-AEP-4, Rapallo-AL-1, Rapallo-AL-2, Rapallo-AL-3, Rapallo-AL-4, Sibilla-AEP-1, Sibilla-AEP-2, Sibilla-AEP-3, Sibilla-DISPLAY-2, Sibilla-DISPLAY-3, Sibilla-SAE-1, Sibilla-SAE-2, Sibilla-SAE-3 | | |

group 3



| | | | |
|--------------------|--|-----------------|-------|
| GEV No. | 400705 | Ref. No. | 22628 |
| description | ribbon cable 10-pole L 1400mm | | |
| For models: | Argenta-AEP-1, Argenta-AEP-2, Argenta-AEP-3, Argenta-AEP-4, Argenta-AEP-J, Argenta-SAE-1, Argenta-SAE-2, Argenta-SAE-3, Argenta-SAE-4, Argenta-SAE-J, Brava, Brava-SME-1, Brava-SME-2, Brava-SME-3, Brava-SME-4, Brava-SMSA-1, Brava-SMSA-2, Brava-SMSA-3, Brava-SMSA-4, CompattaArgenta, Divina-AEP-1, Divina-AEP-2, Divina-AEP-3, Divina-AEP-4, Divina-AEP-J, Divina-SAE-1, Divina-SAE-2, Divina-SAE-3, Divina-SAE-4, Divina-SAE-J, Gloria-AEP-1, Gloria-AEP-2, Gloria-AEP-3, Gloria-AEP-4, Gloria-DISPLAY-LCL-2, Gloria-DISPLAY-LCL-3, Gloria-SAE-1, Gloria-SAE-2, Gloria-SAE-3, Gloria-SAE-4, Rapallo-AEP-1, Rapallo-AEP-2, Rapallo-AEP-3, Rapallo-AEP-4, Rapallo-AL-1, Rapallo-AL-2, Rapallo-AL-3, Rapallo-AL-4, Sibilla-AEP-1, Sibilla-AEP-2...(Other models you can see in the webshop) | | |



| | | | |
|--------------------|--|-----------------|-------|
| GEV No. | 400703 | Ref. No. | 22627 |
| description | ribbon cable 10-pole L 800mm raster size 2.54mm | | |
| For models: | Argenta-AEP-1, Argenta-AEP-2, Argenta-AEP-3, Argenta-AEP-4, Argenta-AEP-J, Argenta-SAE-1, Argenta-SAE-2, Argenta-SAE-3, Argenta-SAE-4, Argenta-SAE-J, Brava, Brava-SME-1, Brava-SME-2, Brava-SME-3, Brava-SME-4, Brava-SMSA-1, Brava-SMSA-2, Brava-SMSA-3, Brava-SMSA-4, CompattaArgenta, Divina-AEP-1, Divina-AEP-2, Divina-AEP-3, Divina-AEP-4, Divina-AEP-J, Divina-SAE-1, Divina-SAE-2, Divina-SAE-3, Divina-SAE-4, Divina-SAE-J, Gloria-AEP-1, Gloria-AEP-2, Gloria-AEP-3, Gloria-AEP-4, Gloria-DISPLAY-LCL-2, Gloria-DISPLAY-LCL-3, Gloria-SAE-1, Gloria-SAE-2, Gloria-SAE-3, Gloria-SAE-4, Rapallo-AEP-1, Rapallo-AEP-2, Rapallo-AEP-3, Rapallo-AEP-4, Rapallo-AL-1, Rapallo-AL-2, Rapallo-AL-3, Rapallo-AL-4, Sibilla-AEP-1, Sibilla-AEP-2...(Other models you can see in the webshop) | | |

connection cables



| | | | |
|--------------------|---|-----------------|-------|
| GEV No. | 527813 | Ref. No. | 22558 |
| description | connection cable L 1500mm 4-pole for coffee machine connection plug | | |

ignition parts

ignition cables

pre-assembled cables



| | | | |
|--------------------|--|-----------------|-------|
| GEV No. | 100140 | Ref. No. | 22001 |
| description | ignition cable cable length 400mm connection ø2.4mm / ø4mm | | |
| For models: | Argenta, Argenta-AEP-1, Argenta-AEP-2, Argenta-AEP-3, Argenta-AEP-4, Argenta-AEP-J, Argenta-SAE-1, Argenta-SAE-2, Argenta-SAE-3, Argenta-SAE-4, Argenta-SAE-J, Brava, Brava-SME-1, Brava-SME-2, Brava-SME-3, Brava-SME-4, Brava-SMSA-1, Brava-SMSA-2, Brava-SMSA-3, Brava-SMSA-4, CompattaArgenta, Denise, Divina, Divina-AEP-1, Divina-AEP-2, Divina-AEP-3, Divina-AEP-4, Divina-AEP-J, Divina-SAE-1, Divina-SAE-2, Divina-SAE-3, Divina-SAE-4, Divina-SAE-J, Dora, Gloria-AEP-1, Gloria-AEP-2, Gloria-AEP-3, Gloria-AEP-4, Gloria-DISPLAY-LCL-2, Gloria-DISPLAY-LCL-3, Gloria-SAE-1, Gloria-SAE-2, Gloria-SAE-3, Gloria-SAE-4, Vania | | |

equipment-specific units

for espresso machines

filter holders

filter holders standard

filter holder without spout



| | | | |
|--------------------|--|-----------------|----------|
| 1 | | | |
| GEV No. | 527855 | Ref. No. | 27311000 |
| description | filter holder suitable for ASTORIA without outlet mounting ø 80.3mm outlet 3/8" ID ø 61.2mm wedge height 9.3mm wedge position diagonal number of wedges 2 | | |
| For models: | Argenta-AEP-1, Argenta-AEP-2, Argenta-AEP-3, Argenta-AEP-4, Argenta-AEP-J, Argenta-SAE-1, Argenta-SAE-2, Argenta-SAE-3, Argenta-SAE-4, Argenta-SAE-J, Brava, Brava-SME-1, Brava-SME-2, Brava-SME-3, Brava-SME-4, Brava-SMSA-1, Brava-SMSA-2, Brava-SMSA-3, Brava-SMSA-4, CK-CKE-CK-1, CK-CKE-CKE-1, CKX-CKXE-CKX-1, CKX-CKXE-CKXE-1, CompattaArgenta, Divina-AEP-1, Divina-AEP-2, Divina-AEP-3, Divina-AEP-4, Divina-AEP-J, Divina-SAE-1, Divina-SAE-2, Divina-SAE-3, Divina-SAE-4, Divina-SAE-J, Gloria-AEP-1, Gloria-AEP-2, Gloria-AEP-3, Gloria-AEP-4, Gloria-DISPLAY-LCL-2, Gloria-DISPLAY-LCL-3, Gloria-SAE-1, Gloria-SAE-2, Gloria-SAE-3, Gloria-SAE-4, Rapallo-AEP-1, Rapallo-AEP-2, Rapallo-AEP-3, Rapallo-AEP-4, Rapallo-AL-1, Rapallo-AL-2...(Other models you can see in the webshop) | | |



| | | | |
|--------------------|--|-----------------|-----|
| 1 | | | |
| GEV No. | 525978 | Ref. No. | N/A |
| description | filter holder suitable for ASTORIA/BEZZERA without outlet mounting ø 80mm outlet 3/8" ID ø 62mm wedge height 9.5mm wedge position diagonal number of wedges 2 lever straight | | |

filter holders short



| | | | |
|--------------------|---|-----------------|-------|
| 1 | | | |
| GEV No. | 529059 | Ref. No. | 27304 |
| description | filter holder mounting ø 80mm outlet 3/8" ID ø 62mm handle M12x1.75 wedge height 9.5mm wedge position diagonal number of wedges 2 lever straight chrome-plated brass | | |
| For models: | Argenta, Argenta-AEP-1, Argenta-AEP-2, Argenta-AEP-3, Argenta-AEP-4, Argenta-AEP-J, Argenta-SAE-1, Argenta-SAE-2, Argenta-SAE-3, Argenta-SAE-4, Argenta-SAE-J, Brava-SME-1, Brava-SME-2, Brava-SME-3, Brava-SME-4, Brava-SMSA-1, Brava-SMSA-2, Brava-SMSA-3, Brava-SMSA-4, CK, CK-CKE, CK-CKE-CK-1, CK-CKE-CKE-1, CKE, CKX-CKXE, CKX-CKXE-CKX-1, CKX-CKXE-CKXE-1, CompattaArgenta, Denise, Divina, Divina-AEP-1, Divina-AEP-2, Divina-AEP-3, Divina-AEP-4, Divina-AEP-J, Divina-SAE-1, Divina-SAE-2, Divina-SAE-3, Divina-SAE-4, Divina-SAE-J, Dora, Gloria-AEP-1, Gloria-AEP-2, Gloria-AEP-3, Gloria-AEP-4, Gloria-DISPLAY-LCL-2, Gloria-DISPLAY-LCL-3, Gloria-SAE-1, Gloria-SAE-2, Gloria-SAE-3...(Other models you can see in the webshop) | | |

EQUIPMENT-SPECIFIC UNITS ASTORIA-CMA

handles

with external thread



| | | | |
|---|---|-----------------|-----------------|
| 1 | | | |
| GEV No. | 529044 | Ref. No. | 15262 |
| description | handle ø 35mm thread M12x1.75 thread L 15mm L 120mm black | | |
| For models: | CK, CKE, Denise | | |
| accessories for | 529044 | | |
|  | GEV No. | 531161 | Ref. No. |
| | | | — |
| | end cap ø 24.6mm mounting ø 22.1mm H 14mm chrome-plated | | |



| | | | |
|--------------------|---|-----------------|----------|
| 1 | | | |
| GEV No. | 111150 | Ref. No. | 15263010 |
| description | handle ø 39mm thread M12x1.75 thread L 17mm L 128mm black | | |
| For models: | Argenta-AEP-1, Argenta-AEP-2, Argenta-AEP-3, Argenta-AEP-4, Argenta-AEP-J, Argenta-SAE-1, Argenta-SAE-2, Argenta-SAE-3, Argenta-SAE-4, Argenta-SAE-J, Brava-SME-1, Brava-SME-2, Brava-SME-3, Brava-SME-4, Brava-SMSA-1, Brava-SMSA-2, Brava-SMSA-3, Brava-SMSA-4, CK-CKE-CK-1, CK-CKE-CKE-1, CKX-CKXE-CKX-1, CKX-CKXE-CKXE-1, CompattaArgenta, Divina-AEP-1, Divina-AEP-2, Divina-AEP-3, Divina-AEP-4, Divina-AEP-J, Divina-SAE-1, Divina-SAE-2, Divina-SAE-3, Divina-SAE-4, Divina-SAE-J, Gloria-AEP-1, Gloria-AEP-2, Gloria-AEP-3, Gloria-AEP-4, Gloria-DISPLAY-LCL-2, Gloria-DISPLAY-LCL-3, Gloria-SAE-1, Gloria-SAE-2, Gloria-SAE-3, Gloria-SAE-4, Rapallo-AEP-1, Rapallo-AEP-2, Rapallo-AEP-3, Rapallo-AEP-4, Rapallo-AL-1, Rapallo-AL-2, Rapallo-AL-3...(Other models you can see in the webshop) | | |

end caps



| | | | |
|--------------------|---|-----------------|----------|
| 1 | | | |
| GEV No. | 527179 | Ref. No. | 15486006 |
| description | end cap ø 24.3mm chrome-plated | | |
| For models: | Argenta-AEP-1, Argenta-AEP-2, Argenta-AEP-3, Argenta-AEP-4, Argenta-AEP-J, Argenta-SAE-1, Argenta-SAE-2, Argenta-SAE-3, Argenta-SAE-4, Argenta-SAE-J, Brava-SME-1, Brava-SME-2, Brava-SME-3, Brava-SME-4, Brava-SMSA-1, Brava-SMSA-2, Brava-SMSA-3, Brava-SMSA-4, CK-CKE-CK-1, CK-CKE-CKE-1, CKX-CKXE-CKX-1, CKX-CKXE-CKXE-1, CompattaArgenta, Divina-AEP-1, Divina-AEP-2, Divina-AEP-3, Divina-AEP-4, Divina-AEP-J, Divina-SAE-1, Divina-SAE-2, Divina-SAE-3, Divina-SAE-4, Divina-SAE-J, Gloria-AEP-1, Gloria-AEP-2, Gloria-AEP-3, Gloria-AEP-4, Gloria-DISPLAY-LCL-2, Gloria-DISPLAY-LCL-3, Gloria-SAE-1, Gloria-SAE-2, Gloria-SAE-3, Gloria-SAE-4, Rapallo-AEP-1, Rapallo-AEP-2, Rapallo-AEP-3, Rapallo-AEP-4, Rapallo-AL-1, Rapallo-AL-2, Rapallo-AL-3...(Other models you can see in the webshop) | | |



| | | | |
|---|--|-----------------|----------|
| spouts | | | |
| with thread 3/8" | | | |
|  | | | |
| 1 | | | |
| GEV No. | 529000 | Ref. No. | 27032001 |
| description | filter holder spout thread 3/8" 1-way curved/long outlet distance | | |
| For models: | Argenta-AEP-1, Argenta-AEP-2, Argenta-AEP-3, Argenta-AEP-4, Argenta-AEP-J, Argenta-SAE-1, Argenta-SAE-2, Argenta-SAE-3, Argenta-SAE-4, Argenta-SAE-J, Brava, Brava-SME-1, Brava-SME-2, Brava-SME-3, Brava-SME-4, Brava-SMSA-1, Brava-SMSA-2, Brava-SMSA-3, Brava-SMSA-4, CK-CKE-CK-1, CK-CKE-CKE-1, CKX-CKXE-CKX-1, CKX-CKXE-CKXE-1, CompattaArgenta, Divina-AEP-1, Divina-AEP-2, Divina-AEP-3, Divina-AEP-4, Divina-AEP-J, Divina-SAE-1, Divina-SAE-2, Divina-SAE-3, Divina-SAE-4, Divina-SAE-J, Gloria-AEP-1, Gloria-AEP-2, Gloria-AEP-3, Gloria-AEP-4, Gloria-DISPLAY-LCL-2, Gloria-DISPLAY-LCL-3, Gloria-SAE-1, Gloria-SAE-2, Gloria-SAE-3, Gloria-SAE-4, Rapallo-AEP-1, Rapallo-AEP-2, Rapallo-AEP-3, Rapallo-AEP-4, Rapallo-AL-1, Rapallo-AL-2...(Other models you can see in the webshop) | | |

| | | | |
|---|---|-----------------|----------------|
|  | | | |
| 1 | | | |
| GEV No. | 529007 | Ref. No. | 27041 27042 |
| description | filter holder spout thread 3/8" 2-way curved/short outlet distance 45mm | | |
| For models: | Argenta, Argenta-AEP-1, Argenta-AEP-2, Argenta-AEP-3, Argenta-AEP-4, Argenta-AEP-J, Argenta-SAE-1, Argenta-SAE-2, Argenta-SAE-3, Argenta-SAE-4, Argenta-SAE-J, Brava-SME-1, Brava-SME-2, Brava-SME-3, Brava-SME-4, Brava-SMSA-1, Brava-SMSA-2, Brava-SMSA-3, Brava-SMSA-4, CK, CK-CKE, CK-CKE-CK-1, CK-CKE-CKE-1, CKE, CKX-CKXE, CKX-CKXE-CKX-1, CKX-CKXE-CKXE-1, CompattaArgenta, Denise, Divina, Divina-AEP-1, Divina-AEP-2, Divina-AEP-3, Divina-AEP-4, Divina-AEP-J, Divina-SAE-1, Divina-SAE-2, Divina-SAE-3, Divina-SAE-4, Divina-SAE-J, Dora, Gloria-AEP-1, Gloria-AEP-2, Gloria-AEP-3, Gloria-AEP-4, Gloria-DISPLAY-LCL-2, Gloria-DISPLAY-LCL-3, Gloria-SAE-1, Gloria-SAE-2, Gloria-SAE-3...(Other models you can see in the webshop) | | |

| | | | |
|---|---|-----------------|----------------|
|  | | | |
| 2 | | | |
| GEV No. | 529004 | Ref. No. | 27030 27032 |
| description | filter holder spout thread 3/8" 1-way curved/long outlet distance | | |
| For models: | Argenta, Argenta-AEP-1, Argenta-AEP-2, Argenta-AEP-3, Argenta-AEP-4, Argenta-AEP-J, Argenta-SAE-1, Argenta-SAE-2, Argenta-SAE-3, Argenta-SAE-4, Argenta-SAE-J, Brava-SME-1, Brava-SME-2, Brava-SME-3, Brava-SME-4, Brava-SMSA-1, Brava-SMSA-2, Brava-SMSA-3, Brava-SMSA-4, CK, CK-CKE, CK-CKE-CK-1, CK-CKE-CKE-1, CKE, CKX-CKXE, CKX-CKXE-CKX-1, CKX-CKXE-CKXE-1, CompattaArgenta, Denise, Divina, Divina-AEP-1, Divina-AEP-2, Divina-AEP-3, Divina-AEP-4, Divina-AEP-J, Divina-SAE-1, Divina-SAE-2, Divina-SAE-3, Divina-SAE-4, Divina-SAE-J, Dora, Gloria-AEP-1, Gloria-AEP-2, Gloria-AEP-3, Gloria-AEP-4, Gloria-DISPLAY-LCL-2, Gloria-DISPLAY-LCL-3, Gloria-SAE-1, Gloria-SAE-2, Gloria-SAE-3...(Other models you can see in the webshop) | | |

| | | | |
|---|---|-----------------|-------|
|  | | | |
| 1 | | | |
| GEV No. | 529894 | Ref. No. | 27050 |
| description | filter holder spout thread 3/8" 3-way curved outlet distance | | |
| For models: | Argenta, Argenta-AEP-1, Argenta-AEP-2, Argenta-AEP-3, Argenta-AEP-4, Argenta-AEP-J, Argenta-SAE-1, Argenta-SAE-2, Argenta-SAE-3, Argenta-SAE-4, Argenta-SAE-J, Brava, Brava-SME-1, Brava-SME-2, Brava-SME-3, Brava-SME-4, Brava-SMSA-1, Brava-SMSA-2, Brava-SMSA-3, Brava-SMSA-4, CK, CK-CKE, CK-CKE-CK-1, CK-CKE-CKE-1, CKE, CKP, CKPE, CKX-CKXE, CKX-CKXE-CKX-1, CKX-CKXE-CKXE-1, CompattaArgenta, Denise, Divina, Divina-AEP-1, Divina-AEP-2, Divina-AEP-3, Divina-AEP-4, Divina-AEP-J, Divina-SAE-1, Divina-SAE-2, Divina-SAE-3, Divina-SAE-4, Divina-SAE-J, Dora, Gloria-AEP-1, Gloria-AEP-2, Gloria-AEP-3, Gloria-AEP-4, Gloria-DISPLAY-LCL-2, Gloria-DISPLAY-LCL-3...(Other models you can see in the webshop) | | |

| | | | |
|---|--|-----------------|----------|
|  | | | |
| 1 | | | |
| GEV No. | 529032 | Ref. No. | 27042001 |
| description | filter holder spout thread 3/8" 2-way curved outlet distance 48mm | | |
| For models: | Argenta-AEP-1, Argenta-AEP-2, Argenta-AEP-3, Argenta-AEP-4, Argenta-AEP-J, Argenta-SAE-1, Argenta-SAE-2, Argenta-SAE-3, Argenta-SAE-4, Argenta-SAE-J, Brava, Brava-SME-1, Brava-SME-2, Brava-SME-3, Brava-SME-4, Brava-SMSA-1, Brava-SMSA-2, Brava-SMSA-3, Brava-SMSA-4, CK-CKE-CK-1, CK-CKE-CKE-1, CKX-CKXE-CKX-1, CKX-CKXE-CKXE-1, CompattaArgenta, Divina-AEP-1, Divina-AEP-2, Divina-AEP-3, Divina-AEP-4, Divina-AEP-J, Divina-SAE-1, Divina-SAE-2, Divina-SAE-3, Divina-SAE-4, Divina-SAE-J, Gloria-AEP-1, Gloria-AEP-2, Gloria-AEP-3, Gloria-AEP-4, Gloria-DISPLAY-LCL-2, Gloria-DISPLAY-LCL-3, Gloria-SAE-1, Gloria-SAE-2, Gloria-SAE-3, Gloria-SAE-4, Rapallo-AEP-1, Rapallo-AEP-2, Rapallo-AEP-3, Rapallo-AEP-4, Rapallo-AL-1, Rapallo-AL-2...(Other models you can see in the webshop) | | |

| | | | |
|---|--|-----------------|----------|
| accessories | | | |
|  | | | |
| 1 | | | |
| GEV No. | 529063 | Ref. No. | 27060201 |
| description | extension thread 3/8" for filter holder outlet | | |
| For models: | Argenta-AEP-1, Argenta-AEP-2, Argenta-AEP-3, Argenta-AEP-4, Argenta-AEP-J, Argenta-SAE-1, Argenta-SAE-2, Argenta-SAE-3, Argenta-SAE-4, Argenta-SAE-J, Brava, Brava-SME-1, Brava-SME-2, Brava-SME-3, Brava-SME-4, Brava-SMSA-1, Brava-SMSA-2, Brava-SMSA-3, Brava-SMSA-4, CK-CKE-CK-1, CK-CKE-CKE-1, CKX-CKXE-CKX-1, CKX-CKXE-CKXE-1, CompattaArgenta, Divina-AEP-1, Divina-AEP-2, Divina-AEP-3, Divina-AEP-4, Divina-AEP-J, Divina-SAE-1, Divina-SAE-2, Divina-SAE-3, Divina-SAE-4, Divina-SAE-J, Gloria-AEP-1, Gloria-AEP-2, Gloria-AEP-3, Gloria-AEP-4, Gloria-DISPLAY-LCL-2, Gloria-DISPLAY-LCL-3, Gloria-SAE-1, Gloria-SAE-2, Gloria-SAE-3, Gloria-SAE-4, Rapallo-AEP-1, Rapallo-AEP-2, Rapallo-AEP-3, Rapallo-AEP-4, Rapallo-AL-1, Rapallo-AL-2...(Other models you can see in the webshop) | | |

filters

for 1 cup



| | | | |
|--------------------|--|-----------------|-----|
| GEV No. | 527631 | Ref. No. | N/A |
| description | coffee filter ø 70mm mounting ø 60.7mm H 17mm cups 1 amount of coffee 8g | | |



| | | | |
|--------------------|--|-----------------|----------------|
| GEV No. | 529011 | Ref. No. | 27142 27176 |
| description | coffee filter ø 70mm mounting ø 60mm H 24.5mm cups 1 amount of coffee 7g perforation ø 0.4mm | | |

For models: Argenta, Argenta-AEP-1, Argenta-AEP-2, Argenta-AEP-3, Argenta-AEP-4, Argenta-AEP-J, Argenta-SAE-1, Argenta-SAE-2, Argenta-SAE-3, Argenta-SAE-4, Argenta-SAE-J, Brava, Brava-SME-1, Brava-SME-2, Brava-SME-3, Brava-SME-4, Brava-SMSA-1, Brava-SMSA-2, Brava-SMSA-3, Brava-SMSA-4, CK-CKE-CK-1, CK-CKE-CKE-1, CKX-CKXE, CKX-CKXE-CKX-1, CKX-CKXE-CKXE-1, CompattaArgenta, Denise, Divina, Divina-AEP-1, Divina-AEP-2, Divina-AEP-3, Divina-AEP-4, Divina-AEP-J, Divina-SAE-1, Divina-SAE-2, Divina-SAE-3, Divina-SAE-4, Divina-SAE-J, Dora, Gloria-AEP-1, Gloria-AEP-2, Gloria-AEP-3, Gloria-AEP-4, Gloria-DISPLAY-LCL-2, Gloria-DISPLAY-LCL-3, Gloria-SAE-1, Gloria-SAE-2, Gloria-SAE-3, Gloria-SAE-4, Rapallo-AEP-1...(Other models you can see in the webshop)

for 2 cups



| | | | |
|--------------------|--|-----------------|-------|
| GEV No. | 529013 | Ref. No. | 27146 |
| description | coffee filter ø 70mm mounting ø 60.5mm H 25.5mm cups 2 amount of coffee 14g perforation ø 0.3x0.3mm square | | |

For models: Argenta, Argenta-AEP-1, Argenta-AEP-2, Argenta-AEP-3, Argenta-AEP-4, Argenta-AEP-J, Argenta-SAE-1, Argenta-SAE-2, Argenta-SAE-3, Argenta-SAE-4, Argenta-SAE-J, Brava, Brava-SME-1, Brava-SME-2, Brava-SME-3, Brava-SME-4, Brava-SMSA-1, Brava-SMSA-2, Brava-SMSA-3, Brava-SMSA-4, CK, CK-CKE-CK-1, CK-CKE-CKE-1, CKX-CKXE, CKX-CKXE-CKX-1, CKX-CKXE-CKXE-1, CompattaArgenta, Denise, Divina, Divina-AEP-1, Divina-AEP-2, Divina-AEP-3, Divina-AEP-4, Divina-AEP-J, Divina-SAE-1, Divina-SAE-2, Divina-SAE-3, Divina-SAE-4, Divina-SAE-J, Dora, Gloria-AEP-1, Gloria-AEP-2, Gloria-AEP-3, Gloria-AEP-4, Gloria-DISPLAY-LCL-2, Gloria-DISPLAY-LCL-3, Gloria-SAE-1, Gloria-SAE-2, Gloria-SAE-3...(Other models you can see in the webshop)

EQUIPMENT-SPECIFIC UNITS ASTORIA-CMA

for 3 and more cups



| | | | |
|--------------------|---|-----------------|-------|
| GEV No. | 529229 | Ref. No. | 27190 |
| description | coffee filter ø 70mm mounting ø 60mm H 28mm cups 3 amount of coffee 21g | | |

For models: Argenta, Argenta-AEP-1, Argenta-AEP-2, Argenta-AEP-3, Argenta-AEP-4, Argenta-AEP-J, Argenta-SAE-1, Argenta-SAE-2, Argenta-SAE-3, Argenta-SAE-4, Argenta-SAE-J, Brava, Brava-SME-1, Brava-SME-2, Brava-SME-3, Brava-SME-4, Brava-SMSA-1, Brava-SMSA-2, Brava-SMSA-3, Brava-SMSA-4, CK, CK-CKE, CK-CKE-CK-1, CK-CKE-CKE-1, CKX-CKXE, CKX-CKXE-CKX-1, CKX-CKXE-CKXE-1, CompattaArgenta, Denise, Divina, Divina-AEP-1, Divina-AEP-2, Divina-AEP-3, Divina-AEP-4, Divina-AEP-J, Divina-SAE-1, Divina-SAE-2, Divina-SAE-3, Divina-SAE-4, Divina-SAE-J, Dora, Gloria-AEP-1, Gloria-AEP-2, Gloria-AEP-3, Gloria-AEP-4, Gloria-DISPLAY-LCL-2, Gloria-DISPLAY-LCL-3...(Other models you can see in the webshop)

blind filters



| | | | |
|--------------------|--|-----------------|-------|
| GEV No. | 529023 | Ref. No. | 27173 |
| description | blind filter ø 70mm mounting ø 60mm H 18mm | | |

For models: Argenta, Argenta-AEP-1, Argenta-AEP-2, Argenta-AEP-3, Argenta-AEP-4, Argenta-AEP-J, Argenta-SAE-1, Argenta-SAE-2, Argenta-SAE-3, Argenta-SAE-4, Argenta-SAE-J, Brava, Brava-SME-1, Brava-SME-2, Brava-SME-3, Brava-SME-4, Brava-SMSA-1, Brava-SMSA-2, Brava-SMSA-3, Brava-SMSA-4, CK, CK-CKE, CK-CKE-CK-1, CK-CKE-CKE-1, CKX-CKXE, CKX-CKXE-CKX-1, CKX-CKXE-CKXE-1, CompattaArgenta, Denise, Divina, Divina-AEP-1, Divina-AEP-2, Divina-AEP-3, Divina-AEP-4, Divina-AEP-J, Divina-SAE-1, Divina-SAE-2, Divina-SAE-3, Divina-SAE-4, Divina-SAE-J, Dora, Gloria-AEP-1, Gloria-AEP-2, Gloria-AEP-3, Gloria-AEP-4, Gloria-DISPLAY-LCL-2, Gloria-DISPLAY-LCL-3...(Other models you can see in the webshop)

filter holder springs



| | | | |
|--------------------|---|-----------------|-----|
| GEV No. | 531240 | Ref. No. | N/A |
| description | filter holder spring L 62mm W 56.5mm wire gauge ø 1mm for espresso filter holder Qty 20 pcs | | |



| | | | |
|--|--|-----------------|-------|
|  <p>1</p> | | | |
| GEV No. | 529079 | Ref. No. | 27254 |
| description | filter holder spring L 70mm W 60mm wire gauge ø 1.3mm for espresso filter holder | | |
| For models: | Argenta, Argenta-AEP-1, Argenta-AEP-2, Argenta-AEP-3, Argenta-AEP-4, Argenta-AEP-J, Argenta-SAE-1, Argenta-SAE-2, Argenta-SAE-3, Argenta-SAE-4, Argenta-SAE-J, Brava, Brava-SME-1, Brava-SME-2, Brava-SME-3, Brava-SME-4, Brava-SMSA-1, Brava-SMSA-2, Brava-SMSA-3, Brava-SMSA-4, CK, CK-CKE, CK-CKE-CK-1, CK-CKE-CKE-1, CKE, CKX-CKXE, CKX-CKXE-CKX-1, CKX-CKXE-CKXE-1, CompattaArgenta, Denise, Divina, Divina-AEP-1, Divina-AEP-2, Divina-AEP-3, Divina-AEP-4, Divina-AEP-J, Divina-SAE-1, Divina-SAE-2, Divina-SAE-3, Divina-SAE-4, Divina-SAE-J, Dora, Gloria-AEP-1, Gloria-AEP-2, Gloria-AEP-3, Gloria-AEP-4, Gloria-DISPLAY-LCL-2, Gloria-DISPLAY-LCL-3, Gloria-SAE-1, Gloria-SAE-2...(Other models you can see in the webshop) | | |

| | | | |
|--|---|-----------------|-----|
|  <p>2</p> | | | |
| GEV No. | 531243 | Ref. No. | N/A |
| description | filter holder spring L 70mm W 60mm wire gauge ø 1.3mm for espresso filter holder Qty 20 pcs | | |

brewing units

shower screens

flat

| | | | |
|---|---|-----------------|-------|
|  <p>1</p> | | | |
| GEV No. | 529084 | Ref. No. | 27100 |
| description | shower screen ø 52mm hole ø 6.4mm | | |
| For models: | Argenta, Argenta-AEP-1, Argenta-AEP-2, Argenta-AEP-3, Argenta-AEP-4, Argenta-AEP-J, Argenta-SAE-1, Argenta-SAE-2, Argenta-SAE-3, Argenta-SAE-4, Argenta-SAE-J, Brava, Brava-SME-1, Brava-SME-2, Brava-SME-3, Brava-SME-4, Brava-SMSA-1, Brava-SMSA-2, Brava-SMSA-3, Brava-SMSA-4, CK, CK-CKE, CK-CKE-CK-1, CK-CKE-CKE-1, CKE, CKX-CKXE, CKX-CKXE-CKX-1, CKX-CKXE-CKXE-1, CMA, CompattaArgenta, Denise, Divina, Divina-AEP-1, Divina-AEP-2, Divina-AEP-3, Divina-AEP-4, Divina-AEP-J, Divina-SAE-1, Divina-SAE-2, Divina-SAE-3, Divina-SAE-4, Divina-SAE-J, Dora, Gloria-AEP-1, Gloria-AEP-2, Gloria-AEP-3, Gloria-AEP-4, Gloria-DISPLAY-LCL-2, Gloria-DISPLAY-LCL-3, Gloria-SAE-1...(Other models you can see in the webshop) | | |

with upstand

| | | | |
|--|---|-----------------|-------|
|  <p>1</p> | | | |
| GEV No. | 529293 | Ref. No. | 27101 |
| description | shower screen ø 57mm H 6mm | | |
| For models: | Argenta, Brava, Denise, Divina, Dora, Rapallo-AL-1, Rapallo-AL-2, Rapallo-AL-3, Rapallo-AL-4, Vania | | |

| | | | |
|---|-----------------------------|-----------------|-------|
|  <p>1</p> | | | |
| GEV No. | 528417 | Ref. No. | 27104 |
| description | shower screen ø 58mm H 19mm | | |

| | | | |
|---|-----------------------------|-----------------|-------|
|  <p>1</p> | | | |
| GEV No. | 529080 | Ref. No. | 27104 |
| description | shower screen ø 58mm H 20mm | | |

washers

| | | | |
|---|--|-----------------|----------|
|  <p>1</p> | | | |
| GEV No. | 527871 | Ref. No. | 23260014 |
| description | plain washer ID ø 5.2mm ED ø 11.5mm thickness 1mm SS conical | | |
| For models: | Divina-AEP-1, Divina-AEP-2, Divina-AEP-3, Divina-AEP-4, Divina-AEP-J, Divina-SAE-1, Divina-SAE-2, Divina-SAE-3, Divina-SAE-4, Divina-SAE-J, Gloria-AEP-1, Gloria-AEP-2, Gloria-AEP-3, Gloria-AEP-4, Gloria-DISPLAY-LCL-2, Gloria-DISPLAY-LCL-3, Gloria-SAE-1, Gloria-SAE-2, Gloria-SAE-3, Gloria-SAE-4 | | |

filter holder gaskets

flat

with internal notch

| | | | |
|---|--|-----------------|-------|
|  <p>1</p> | | | |
| GEV No. | 526269 | Ref. No. | 12215 |
| description | filter holder gasket D1 ø 71mm D2 ø 56mm H 8.5mm with inside notch Qty 1 pcs | | |



1

| | | | |
|--------------------|--|-----------------|-------|
| GEV No. | 526270 | Ref. No. | 12217 |
| description | filter holder gasket D1 ø 72mm D2 ø 56mm H 8mm with inside notch Qty 1 pcs | | |
| For models: | Argenta, Argenta-AEP-1, Argenta-AEP-2, Argenta-AEP-3, Argenta-AEP-4, Argenta-AEP-J, Argenta-SAE-1, Argenta-SAE-2, Argenta-SAE-3, Argenta-SAE-4, Argenta-SAE-J, Brava, Brava-SME-1, Brava-SME-2, Brava-SME-3, Brava-SME-4, Brava-SMSA-1, Brava-SMSA-2, Brava-SMSA-3, Brava-SMSA-4, CK, CK-CKE, CK-CKE-CK-1, CK-CKE-CKE-1, CKE, CKX-CKXE, CKX-CKXE-CKX-1, CKX-CKXE-CKXE-1, CompattaArgenta, Denise, Divina, Divina-AEP-1, Divina-AEP-2, Divina-AEP-3, Divina-AEP-4, Divina-AEP-J, Divina-SAE-1, Divina-SAE-2, Divina-SAE-3, Divina-SAE-4, Divina-SAE-J, Dora, Gloria-AEP-1, Gloria-AEP-2, Gloria-AEP-3, Gloria-AEP-4, Gloria-DISPLAY-LCL-2, Gloria-DISPLAY-LCL-3, Gloria-SAE-1, Gloria-SAE-2...(Other models you can see in the webshop) | | |

with bevel 45x2



1

| | | | |
|--------------------|--|-----------------|-------|
| GEV No. | 528969 | Ref. No. | 12228 |
| description | filter holder gasket with bevel 45x2 D1 ø 73.5mm D2 ø 57.5mm H 8.5mm with inside notch | | |



1

| | | | |
|--------------------|--|-----------------|----------------|
| GEV No. | 528970 | Ref. No. | 12225 12227 |
| description | filter holder gasket with bevel 45x2 D1 ø 73.5mm D2 ø 57.5mm H 8mm with inside notch | | |

standard



1

| | | | |
|--------------------|--|-----------------|-------|
| GEV No. | 528098 | Ref. No. | 12216 |
| description | filter holder gasket D1 ø 66mm D2 ø 56mm H 5.5mm Qty 1 pcs | | |
| For models: | Argenta, Denise, Divina, Dora, Rapallo-AL-1, Rapallo-AL-2, Rapallo-AL-3, Rapallo-AL-4, Vania | | |

shim gaskets



1

| | | | |
|--------------------|--|-----------------|---|
| GEV No. | 531251 | Ref. No. | — |
| description | shim gasket D1 ø 66mm D2 ø 58mm thickness 0.8mm paper Qty 20 pcs | | |



1

| | | | |
|--------------------|---|-----------------|-------|
| GEV No. | 528043 | Ref. No. | 12219 |
| description | filter holder gasket D1 ø 66mm D2 ø 56mm H 6mm Qty 1 pcs | | |
| For models: | Argenta, Brava, Denise, Divina, Dora, Rapallo-AL-1, Rapallo-AL-2, Rapallo-AL-3, Rapallo-AL-4, Vania | | |

brewing units with solenoid valve
producer-specific brewing units



1

| | | | |
|--------------------|---|-----------------|-------|
| GEV No. | 528031 | Ref. No. | 12226 |
| description | filter holder gasket D1 ø 73mm D2 ø 57mm H 8.5mm rubber Qty 1 pcs | | |



1

| | | | |
|--------------------|--|-----------------|----------|
| GEV No. | 531146 | Ref. No. | 56082101 |
| description | brewing unit ARGENTA | | |
| For models: | Argenta-AEP-1, Argenta-AEP-2, Argenta-AEP-3, Argenta-AEP-4, Argenta-AEP-J, Argenta-SAE-1, Argenta-SAE-2, Argenta-SAE-3, Argenta-SAE-4, Argenta-SAE-J, Brava-SME-1, Brava-SME-2, Brava-SME-3, Brava-SME-4, Brava-SMSA-1, Brava-SMSA-2, Brava-SMSA-3, Brava-SMSA-4 | | |



| | | | | |
|---|--------------------|---|-----------------|-------|
| 1 | GEV No. | 525001 | Ref. No. | 56054 |
| | description | brewing unit complete ARGENTA | | |
| | For models: | Argenta, Argenta-AEP-1, Argenta-AEP-2, Argenta-AEP-3, Argenta-AEP-4, Argenta-AEP-J, Argenta-SAE-1, Argenta-SAE-2, Argenta-SAE-3, Argenta-SAE-4, Argenta-SAE-J, Brava-SME-1, Brava-SME-2, Brava-SME-3, Brava-SME-4, Brava-SMSA-1, Brava-SMSA-2, Brava-SMSA-3, Brava-SMSA-4, Denise | | |



| | | | | |
|---|--------------------|---|-----------------|------------------------------------|
| 1 | GEV No. | 525000 | Ref. No. | 56055 56082100+18151+23551(4st) |
| | description | brewing unit complete COMPACT suitable for ASTORIA | | |
| | For models: | CK-CKE, CK-CKE-CK-1, CK-CKE-CKE-1, CKX-CKXE-CKX-1, CKX-CKXE-CKXE-1, CompattaArgenta | | |



| | | | | |
|---|--------------------|--|-----------------|--|
| 1 | GEV No. | 525002 | Ref. No. | 56072 56072001 56082102+18151+12013+12305(2x)23560 |
| | description | brewing unit complete ARGENTA suitable for ASTORIA | | |
| | For models: | Denise, Dora, Vania | | |



| | | | | |
|---|--------------------|--|-----------------|----------------------|
| 1 | GEV No. | 527779 | Ref. No. | 56080002 56082106 |
| | description | brewing unit complete suitable for Astoria / Wega | | |
| | For models: | Divina-AEP-1, Divina-AEP-2, Divina-AEP-3, Divina-AEP-4, Divina-AEP-J, Divina-SAE-1, Divina-SAE-2, Divina-SAE-3, Divina-SAE-4, Divina-SAE-J, Gloria-AEP-1, Gloria-AEP-2, Gloria-AEP-3, Gloria-AEP-4, Gloria-DISPLAY-LCL-2, Gloria-DISPLAY-LCL-3, Gloria-SAE-1, Gloria-SAE-2, Gloria-SAE-3, Gloria-SAE-4 | | |



| | | | | |
|---|--------------------|--|-----------------|----------|
| 1 | GEV No. | 525004 | Ref. No. | 56082001 |
| | description | brewing unit complete BRAVA suitable for ASTORIA | | |



| | | | | |
|---|--------------------|--|-----------------|----------------------|
| 1 | GEV No. | 527780 | Ref. No. | 56082011 56082104 |
| | description | brewing unit complete suitable for Astoria / Wega | | |
| | For models: | Sibilla-AEP-1, Sibilla-AEP-2, Sibilla-AEP-3, Sibilla-DISPLAY-2, Sibilla-DISPLAY-3, Sibilla-SAE-1, Sibilla-SAE-2, Sibilla-SAE-3 | | |



1

| | | | |
|--------------------|-----------------------------------|-----------------|----------|
| GEV No. | 525007 | Ref. No. | 56082103 |
| description | brewing unit suitable for ASTORIA | | |

gaskets



1

| | | | |
|--------------------|--|-----------------|----------|
| GEV No. | 532554 | Ref. No. | 12223002 |
| description | O-ring silicone thickness 1.5mm ID ø 4.1mm Qty 1 pcs | | |
| For models: | Giada-1, Giada-2, Sara-1GR-1, Sara-2GR-2 | | |

nozzles



1

| | | | |
|--------------------|---|-----------------|--------|
| GEV No. | 528947 | Ref. No. | 10300C |
| description | nozzle hole ø 0.6mm L 4mm thread M6x0.75 thread L 5mm | | |



1

| | | | |
|--------------------|---|-----------------|-------|
| GEV No. | 528177 | Ref. No. | 10300 |
| description | nozzle hole ø 0.8mm | | |
| For models: | Argenta, Argenta-AEP-1, Argenta-AEP-2, Argenta-AEP-3, Argenta-AEP-4, Argenta-AEP-J, Argenta-SAE-1, Argenta-SAE-2, Argenta-SAE-3, Argenta-SAE-4, Argenta-SAE-J, Brava-SME-1, Brava-SME-2, Brava-SME-3, Brava-SME-4, Brava-SMSA-1, Brava-SMSA-2, Brava-SMSA-3, Brava-SMSA-4, CK, CK-CKE, CK-CKE-CK-1, CK-CKE-CKE-1, CKE, CKP, CKPE, CKX-CKXE, CKX-CKXE-CKX-1, CKX-CKXE-CKXE-1, CMA, CompattaArgenta, Denise, Giada-1, Giada-2, Sara-1GR-1, Sara-2GR-2 | | |

pipes



1

| | | | |
|--------------------|--|-----------------|----------------------|
| GEV No. | 527918 | Ref. No. | 15451011 15451018 |
| description | aspiration tube for cold water ø 8mm L 75mm T1: M8x1.25 PTFE | | |
| For models: | Brava, Dora, Rapallo-AEP-1, Rapallo-AEP-2, Rapallo-AEP-3, Rapallo-AEP-4, Vania | | |



1

| | | | |
|--------------------|---|-----------------|----------|
| GEV No. | 527804 | Ref. No. | 52000122 |
| description | aspiration tube group ø 12mm L 180mm T1: 1/4" copper | | |
| For models: | Argenta, Brava, Denise, Dora, Rapallo-AEP-1, Rapallo-AEP-2, Rapallo-AEP-3, Rapallo-AEP-4, Vania | | |



1

| | | | |
|--------------------|--|-----------------|----------|
| GEV No. | 527619 | Ref. No. | 15451025 |
| description | aspiration tube ø 8mm L 150mm T1: M8x1.25 PTFE | | |
| For models: | Sibilla-AEP-1, Sibilla-AEP-2, Sibilla-AEP-3, Sibilla-DISPLAY-2, Sibilla-DISPLAY-3, Sibilla-SAE-1, Sibilla-SAE-2, Sibilla-SAE-3 | | |



1

| | | | |
|--------------------|---|-----------------|----------------------|
| GEV No. | 527878 | Ref. No. | 52000166 52000168 |
| description | drain pipe ø 12mm L 92mm T1: 1/8" copper | | |
| For models: | Argenta, Argenta-AEP-1, Argenta-AEP-2, Argenta-AEP-3, Argenta-AEP-4, Argenta-AEP-J, Argenta-SAE-1, Argenta-SAE-2, Argenta-SAE-3, Argenta-SAE-4, Argenta-SAE-J, Brava-SME-1, Brava-SME-2, Brava-SME-3, Brava-SME-4, Brava-SMSA-1, Brava-SMSA-2, Brava-SMSA-3, Brava-SMSA-4, CK, CK-CKE, CK-CKE-CK-1, CK-CKE-CKE-1, CKE, CKX-CKXE, CKX-CKXE-CKX-1, CKX-CKXE-CKXE-1, CompattaArgenta, Denise, Divina, Divina-AEP-1, Divina-AEP-2, Divina-AEP-3, Divina-AEP-4, Divina-AEP-J, Divina-SAE-1, Divina-SAE-2, Divina-SAE-3, Divina-SAE-4, Divina-SAE-J, Dora, Gloria-AEP-1, Gloria-AEP-2, Gloria-AEP-3, Gloria-AEP-4, Gloria-DISPLAY-LCL-2, Gloria-DISPLAY-LCL-3, Gloria-SAE-1, Gloria-SAE-2, Gloria-SAE-3...(Other models you can see in the webshop) | | |

screw connections



1

| | | | |
|--------------------|--|-----------------|----------|
| GEV No. | 527867 | Ref. No. | 25739502 |
| description | nozzle holder thread M28x1.5 IT M18x1 L 62mm chrome-plated brass | | |
| For models: | Divina-AEP-1, Divina-AEP-2, Divina-AEP-3, Divina-AEP-4, Divina-AEP-J, Divina-SAE-1, Divina-SAE-2, Divina-SAE-3, Divina-SAE-4, Divina-SAE-J, Gloria-AEP-1, Gloria-AEP-2, Gloria-AEP-3, Gloria-AEP-4, Gloria-DISPLAY-LCL-2, Gloria-DISPLAY-LCL-3, Gloria-SAE-1, Gloria-SAE-2, Gloria-SAE-3, Gloria-SAE-4, Rapallo-AEP-1, Rapallo-AEP-2, Rapallo-AEP-3, Rapallo-AEP-4, Sibilla-AEP-1, Sibilla-AEP-2, Sibilla-AEP-3, Sibilla-DISPLAY-2, Sibilla-DISPLAY-3, Sibilla-SAE-1, Sibilla-SAE-2, Sibilla-SAE-3 | | |



| | | | |
|---|--|-----------------|----------|
|  | | | |
| 1 | | | |
| GEV No. | 527874 | Ref. No. | 25739501 |
| description | nozzle holder thread M5 IT M5 L 18mm brass WS 7 | | |
| For models: | Sibilla-AEP-1, Sibilla-AEP-2, Sibilla-AEP-3, Sibilla-DISPLAY-2, Sibilla-DISPLAY-3, Sibilla-SAE-1, Sibilla-SAE-2, Sibilla-SAE-3 | | |

brewing units manual

components

drain units

drain pipes

| | | | |
|---|--|-----------------|----------|
|  | | | |
| 1 | | | |
| GEV No. | 527790 | Ref. No. | 27421018 |
| description | drain pipe thread 1/2" int. ø 1 8mm int. ø 2 15mm L 37mm chrome-plated brass | | |

| | | | |
|--|--|-----------------|----------|
|  | | | |
| 1 | | | |
| GEV No. | 528538 | Ref. No. | 27421018 |
| description | end piece thread 1/2" int. ø 1 12mm int. ø 2 15mm L 36mm chrome-plated brass WS 26 | | |

tap aerators

| | | | |
|---|---|-----------------|----------|
|  | | | |
| 1 | | | |
| GEV No. | 527872 | Ref. No. | 27421015 |
| description | tap aerator ID ø 6mm brass ED ø 15mm L 14mm | | |

shafts

| | | | |
|---|---|-----------------|----------|
|  | | | |
| 1 | | | |
| GEV No. | 528532 | Ref. No. | 27421006 |
| description | shaft thread M4 square L 34mm W 6mm brass | | |

| | | | |
|--|---|-----------------|----------|
|  | | | |
| 1 | | | |
| GEV No. | 527795 | Ref. No. | 27421006 |
| description | shaft thread M4 triangle L 34.6mm W 6.6mm brass | | |

brewing units

| | | | |
|--|---|-----------------|-------|
|  | | | |
| 1 | | | |
| GEV No. | 527607 | Ref. No. | 56353 |
| description | brewing unit L 133mm H 121mm chrome-plated brass int. ø 1 66.2mm | | |
| For models: | Argenta, Brava, Denise, Divina, Dora, Rapallo-AL-1, Rapallo-AL-2, Rapallo-AL-3, Rapallo-AL-4, Vania | | |

bushes

| | | | |
|---|--|-----------------|----------|
|  | | | |
| 1 | | | |
| GEV No. | 528541 | Ref. No. | 27421021 |
| description | bush D1 ø 15mm D2 ø 10.8mm ID ø 8mm H 30mm brass | | |

gaskets

| | | | |
|--|---|-----------------|-------|
|  | | | |
| 1 | | | |
| GEV No. | 529270 | Ref. No. | 12201 |
| description | gasket ED ø 52mm H 7mm rubber int. ø 1 38mm | | |
| For models: | Argenta, Denise, Divina, Rapallo-AL-1, Rapallo-AL-2, Rapallo-AL-3, Rapallo-AL-4 | | |

| | | | |
|---|--|-----------------|----------|
|  | | | |
| 1 | | | |
| GEV No. | 528494 | Ref. No. | 27421010 |
| description | gasket rubber ED ø 13mm ID ø 4mm thickness 4mm Qty 1 pcs | | |

| | | | |
|---|---|-----------------|----------|
|  | | | |
| 1 | | | |
| GEV No. | 527803 | Ref. No. | 27421008 |
| description | gasket Viton ED ø 13mm ID ø 4mm thickness 4mm Qty 1 pcs | | |

gasket supports

| | | | |
|---|---|-----------------|----------------------|
|  | | | |
| 1 | | | |
| GEV No. | 528528 | Ref. No. | 27421008 27421010 |
| description | gasket support ED ø 16mm ID ø 13mm H 13mm for gasket thread M3 brass L 13mm int. ø 1 13mm | | |

miscellaneous

| | | | |
|---|---|-----------------|-------|
|  | | | |
| 1 | | | |
| GEV No. | 527851 | Ref. No. | 25050 |
| description | ball ø 12mm for brewing unit SS | | |
| For models: | Argenta, Brava, Denise, Divina, Dora, Rapallo-AL-1, Rapallo-AL-2, Rapallo-AL-3, Rapallo-AL-4, Vania | | |

| | | | |
|---|---|-----------------|-------|
|  | | | |
| 1 | | | |
| GEV No. | 527847 | Ref. No. | 27302 |
| description | bolt L 60mm for ball bearing ED ø 10mm | | |
| For models: | Argenta, Brava, Denise, Divina, Dora, Rapallo-AL-1, Rapallo-AL-2, Rapallo-AL-3, Rapallo-AL-4, Vania | | |

| | | | |
|---|--|-----------------|----------|
|  | | | |
| 1 | | | |
| GEV No. | 528530 | Ref. No. | 27421012 |
| description | bolt square brass thread M3 L 11mm W 6mm H 6mm thread L 10mm | | |

| | | | |
|---|--|-----------------|----------------------|
|  | | | |
| 1 | | | |
| GEV No. | 528531 | Ref. No. | 27421012 27421013 |
| description | bolt square brass thread M3 L 12mm W 6mm H 6mm thread L 10mm | | |

| | | | |
|---|---|-----------------|----------|
|  | | | |
| 1 | | | |
| GEV No. | 527868 | Ref. No. | 27421014 |
| description | bolt square brass thread M3 L 6mm W 5mm H 5mm | | |

| | | | |
|---|---|-----------------|----------|
|  | | | |
| 1 | | | |
| GEV No. | 528535 | Ref. No. | 27421014 |
| description | bolt square brass thread M3 L 6mm W 6mm H 6mm | | |

| | | | |
|--|---|-----------------|-------|
|  | | | |
| 1 | | | |
| GEV No. | 527853 | Ref. No. | 27301 |
| description | bolt steel L 29mm ED ø 9mm | | |
| For models: | Argenta, Brava, Denise, Dora, Rapallo-AL-1, Rapallo-AL-2, Rapallo-AL-3, Rapallo-AL-4, Vania | | |

| | | | |
|---|---|-----------------|-------|
|  | | | |
| 1 | | | |
| GEV No. | 527846 | Ref. No. | 56351 |
| description | cam thread M16x1.5 | | |
| For models: | Argenta, Brava, Denise, Divina, Rapallo-AL-1, Rapallo-AL-2, Rapallo-AL-3, Rapallo-AL-4, Vania | | |

| | | | |
|--|---|-----------------|-------------------|
|  | | | |
| 1 | | | |
| GEV No. | 527794 | Ref. No. | 56354 56354001 |
| description | cam W 30mm H 84mm | | |
| For models: | Argenta, Brava, Denise, Divina, Dora, Rapallo-AL-1, Rapallo-AL-2, Rapallo-AL-3, Rapallo-AL-4, Vania | | |





| | | | |
|--|---|-----------------|-------|
|  <p>1</p> | | | |
| GEV No. | 527614 | Ref. No. | 56352 |
| description | cylinder int. ϕ 1 51mm H 102mm ED ϕ 66mm | | |
| For models: | Argenta, Brava, Denise, Divina, Dora, Rapallo-AL-1, Rapallo-AL-2, Rapallo-AL-3, Rapallo-AL-4, Vania | | |

| | | | |
|--|--|-----------------|----------|
|  <p>1</p> | | | |
| GEV No. | 527873 | Ref. No. | 27421011 |
| description | plain washer ID ϕ 3.2mm ED ϕ 7mm thickness 0.5mm brass | | |



| | | | |
|--|--|-----------------|----------|
|  <p>1</p> | | | |
| GEV No. | 528529 | Ref. No. | 27421011 |
| description | plain washer ID ϕ 3.5mm ED ϕ 6.6mm thickness 0.5mm brass Qty 1 pcs | | |

| | | | |
|--|---|-----------------|----------|
|  <p>1</p> | | | |
| GEV No. | 526266 | Ref. No. | 27421013 |
| description | screw cap square thread M3 L 10mm W 6mm H 6mm | | |

| | | | |
|--|--|-----------------|----------|
|  <p>1</p> | | | |
| GEV No. | 527845 | Ref. No. | 15120000 |
| description | sliding plate rubber L 20mm W 16mm H 8mm for lever ED ϕ 9mm | | |
| For models: | Rapallo-AL-1, Rapallo-AL-2, Rapallo-AL-3, Rapallo-AL-4 | | |

| | | | |
|--|--|-----------------|----------|
|  <p>1</p> | | | |
| GEV No. | 528941 | Ref. No. | 27421007 |
| description | thread bolt chrome-plated steel thread M8 L 50mm for handle ED ϕ 10mm | | |

| | | | |
|---|--|-----------------|----------|
| nozzle holders | | | |
|  <p>1</p> | | | |
| GEV No. | 527867 | Ref. No. | 25739502 |
| description | nozzle holder thread M28x1.5 IT M18x1 L 62mm chrome-plated brass | | |
| For models: | Divina-AEP-1, Divina-AEP-2, Divina-AEP-3, Divina-AEP-4, Divina-AEP-J, Divina-SAE-1, Divina-SAE-2, Divina-SAE-3, Divina-SAE-4, Divina-SAE-J, Gloria-AEP-1, Gloria-AEP-2, Gloria-AEP-3, Gloria-AEP-4, Gloria-DISPLAY-LCL-2, Gloria-DISPLAY-LCL-3, Gloria-SAE-1, Gloria-SAE-2, Gloria-SAE-3, Gloria-SAE-4, Rapallo-AEP-1, Rapallo-AEP-2, Rapallo-AEP-3, Rapallo-AEP-4, Sibilla-AEP-1, Sibilla-AEP-2, Sibilla-AEP-3, Sibilla-DISPLAY-2, Sibilla-DISPLAY-3, Sibilla-SAE-1, Sibilla-SAE-2, Sibilla-SAE-3 | | |

| | | | |
|---|--|-----------------|-------|
|  <p>1</p> | | | |
| GEV No. | 528523 | Ref. No. | 27119 |
| description | nozzle holder thread M30x1.5 IT M16x1.5 IT 1 M6 ϕ 25.5mm int. ϕ 1 15.3mm int. ϕ 2 17.8mm L 66.5mm total length 82mm WS 36 chrome-plated brass | | |
| accessories for | 528523 | | |
| | GEV No. | Ref. No. | — |
| |  shaft bearing suitable for FAEMA E61 | | |

| | | | |
|---|---|-----------------|-------|
|  <p>1</p> | | | |
| GEV No. | 527253 | Ref. No. | 27119 |
| description | nozzle holder thread M30x1.5 IT M16x1.5 IT 1 M6 ϕ 25mm int. ϕ 1 10mm L 66mm total length 82mm WS 36 chrome-plated brass | | |

| | | | |
|--|---|-----------------|----------|
| springs | | | |
|  <p>1</p> | | | |
| GEV No. | 528526 | Ref. No. | 27421001 |
| description | compression spring ϕ 12.9mm L 41mm wire gauge ϕ 1.2mm | | |



| | | | |
|--------------------|---|-----------------|-------|
| GEV No. | 528536 | Ref. No. | 27250 |
| description | spring ø 48mm L 133mm wire gauge ø 8.5mm for coffee machine | | |
| For models: | Argenta, Brava, Denise, Divina, Dora, Rapallo-AL-1, Rapallo-AL-2, Rapallo-AL-3, Rapallo-AL-4, Vania | | |

levers



| | | | |
|--------------------|--------------------------------------|-----------------|----------|
| GEV No. | 528940 | Ref. No. | 27421024 |
| description | lever L 36mm thread M8 H 28mm W 14mm | | |

complete



| | | | |
|--------------------|---|-----------------|-------|
| GEV No. | 527620 | Ref. No. | 27220 |
| description | lever complete L 250mm thread M16x1.5 for Astoria / Wega | | |
| For models: | Argenta, Brava, Denise, Divina, Dora, Rapallo-AL-1, Rapallo-AL-2, Rapallo-AL-3, Rapallo-AL-4, Vania | | |

accessories



| | | | |
|--------------------|--|-----------------|----------|
| GEV No. | 527869 | Ref. No. | 27300027 |
| description | stop for lever ø 28mm ID ø 19mm H 6mm rubber | | |
| For models: | Rapallo-AL-1, Rapallo-AL-2, Rapallo-AL-3, Rapallo-AL-4 | | |

camshafts



| | | | |
|--------------------|--|-----------------|----------|
| GEV No. | 528939 | Ref. No. | 27078008 |
| description | camshaft shaft ø 8mm shaft intake ø 6.6mm L 87.3mm W 22mm H 17mm thread M6 brass | | |



| | | | |
|--------------------|--|-----------------|----------|
| GEV No. | 528527 | Ref. No. | 27421005 |
| description | spindle shaft ø 4mm L 40mm thread M4 brass for cam shaft | | |

pipes



| | | | |
|--------------------|---|-----------------|----------|
| GEV No. | 527877 | Ref. No. | 52000120 |
| description | aspiration tube L 145mm thread M18x1.5 ED ø 12mm | | |
| For models: | Argenta, Brava, Denise, Divina, Dora, Rapallo-AL-1, Rapallo-AL-2, Rapallo-AL-3, Rapallo-AL-4, Vania | | |

washers



| | | | |
|--------------------|---|-----------------|----------|
| GEV No. | 527881 | Ref. No. | 27300026 |
| description | plain washer stainless steel for spring ID ø 32mm ED ø 48mm | | |
| For models: | Rapallo-AL-1, Rapallo-AL-2, Rapallo-AL-3, Rapallo-AL-4 | | |

screw connections



| | | | |
|--------------------|--|-----------------|----------|
| GEV No. | 527801 | Ref. No. | 27421020 |
| description | fitting support ø 35mm int. ø 18mm total length 39mm brass | | |



| | | | |
|--------------------|--|-----------------|----------|
| GEV No. | 527876 | Ref. No. | 27421025 |
| description | nut IT M6 L 22.8mm WS 13 chrome-plated brass | | |



| | | | |
|--------------------|--|-----------------|----------|
| GEV No. | 527802 | Ref. No. | 27421023 |
| description | screw connection thread 1/2" int. ø 11mm int. ø 21.5mm L 9mm WS 24 chrome-plated brass | | |



| | | | |
|--|-------------------------------|-----------------|----------|
|  <p>1</p> | | | |
| GEV No. | 527875 | Ref. No. | 27421019 |
| description | stop bolt thread M6 L 16mm SS | | |

complete

producer-specific brewing units

| | | | |
|--|---|-----------------|-------------------|
|  <p>1</p> | | | |
| GEV No. | 527608 | Ref. No. | 26104 |
| description | brewing unit complete suitable for Astoria / Wega | | |
| spare parts for | 527608 | | |
|  <p>1</p> | | | |
| GEV No. | 111092 | Ref. No. | 15400 27421022 |
| description | cone handle thread M8 ø 25mm L 41mm black | | |

brewing units with lever

levers

handles

| | | | |
|--|---|-----------------|-------|
|  <p>1</p> | | | |
| GEV No. | 529269 | Ref. No. | 15261 |
| description | handle ø 35mm ID ø 16.5mm L 112mm black plastic | | |
| For models: | Argenta, Brava, Divina, Dora, Rapallo-AL-1, Rapallo-AL-2, Rapallo-AL-3, Rapallo-AL-4, Vania | | |

components

nozzles

nozzle holders

| | | | |
|--|--|-----------------|----------|
|  <p>1</p> | | | |
| GEV No. | 528180 | Ref. No. | 25739500 |
| description | nozzle holder | | |
| For models: | Divina, Divina-AEP-1, Divina-AEP-2, Divina-AEP-3, Divina-AEP-4, Divina-AEP-J, Divina-SAE-1, Divina-SAE-2, Divina-SAE-3, Divina-SAE-4, Divina-SAE-J, Gloria-AEP-1, Gloria-AEP-2, Gloria-AEP-3, Gloria-AEP-4, Gloria-DISPLAY-LCL-2, Gloria-DISPLAY-LCL-3, Gloria-SAE-1, Gloria-SAE-2, Gloria-SAE-3, Gloria-SAE-4 | | |

with thread

| | | | |
|---|--|-----------------|--------|
|  <p>1</p> | | | |
| GEV No. | 528175 | Ref. No. | 10300A |
| description | nozzle bore ø 0.6mm | | |
| For models: | Argenta, Argenta-AEP-1, Argenta-AEP-2, Argenta-AEP-3, Argenta-AEP-4, Argenta-AEP-J, Argenta-SAE-1, Argenta-SAE-2, Argenta-SAE-3, Argenta-SAE-4, Argenta-SAE-J, Brava-SME-1, Brava-SME-2, Brava-SME-3, Brava-SME-4, Brava-SMSA-1, Brava-SMSA-2, Brava-SMSA-3, Brava-SMSA-4, Denise, Divina-AEP-1, Divina-AEP-2, Divina-AEP-3, Divina-AEP-4, Divina-AEP-J, Divina-SAE-1, Divina-SAE-2, Divina-SAE-3, Divina-SAE-4, Divina-SAE-J, Gloria-AEP-1, Gloria-AEP-2, Gloria-AEP-3, Gloria-AEP-4, Gloria-DISPLAY-LCL-2, Gloria-DISPLAY-LCL-3, Gloria-SAE-1, Gloria-SAE-2, Gloria-SAE-3, Gloria-SAE-4, Prima | | |

| | | | |
|--|--|-----------------|----------|
|  <p>1</p> | | | |
| GEV No. | 528176 | Ref. No. | 10300001 |
| description | nozzle bore ø 0.7mm thread M5x0.75 conical | | |
| For models: | Argenta-AEP-1, Argenta-AEP-2, Argenta-AEP-3, Argenta-AEP-4, Argenta-AEP-J, Argenta-SAE-1, Argenta-SAE-2, Argenta-SAE-3, Argenta-SAE-4, Argenta-SAE-J, Brava, Brava-SME-1, Brava-SME-2, Brava-SME-3, Brava-SME-4, Brava-SMSA-1, Brava-SMSA-2, Brava-SMSA-3, Brava-SMSA-4, CK-CKE-CK-1, CK-CKE-CKE-1, CKX-CKXE-CKX-1, CKX-CKXE-CKXE-1, Divina-AEP-1, Divina-AEP-2, Divina-AEP-3, Divina-AEP-4, Divina-AEP-J, Divina-SAE-1, Divina-SAE-2, Divina-SAE-3, Divina-SAE-4, Divina-SAE-J, Gloria-AEP-1, Gloria-AEP-2, Gloria-AEP-3, Gloria-AEP-4, Gloria-DISPLAY-LCL-2, Gloria-DISPLAY-LCL-3, Gloria-SAE-1, Gloria-SAE-2, Gloria-SAE-3, Gloria-SAE-4, Rapallo-AEP-1, Rapallo-AEP-2, Rapallo-AEP-3, Rapallo-AEP-4, Sibilla-AEP-1, Sibilla-AEP-2, Sibilla-AEP-3...(Other models you can see in the webshop) | | |

| | | | |
|---|---|-----------------|--------|
|  | | | |
| 1 | | | |
| GEV No. | 528486 | Ref. No. | 10300C |
| description | nozzle bore \varnothing 0.7mm thread M6x0.75 L 9mm WS 7 | | |

screw connections

| | | | |
|---|---|-----------------|-------|
|  | | | |
| 1 | | | |
| GEV No. | 528519 | Ref. No. | 27118 |
| description | end cap thread 3/8" ID \varnothing 9.1mm L 21.5mm chrome-plated brass WS 22 | | |

| | | | |
|---|--|-----------------|-------|
|  | | | |
| 1 | | | |
| GEV No. | 527270 | Ref. No. | 27118 |
| description | end cap thread M16x1.5 ID \varnothing 8.9mm L 21mm chrome-plated WS 22 | | |

| | | | |
|---|---|-----------------|-------|
|  | | | |
| 1 | | | |
| GEV No. | 528316 | Ref. No. | 25789 |
| description | end cap thread M18x1.5 ID \varnothing 13.5mm L 10mm brass WS 17 | | |
| For models: | Argenta, Argenta-AEP-1, Argenta-AEP-2, Argenta-AEP-3, Argenta-AEP-4, Argenta-AEP-J, Argenta-SAE-1, Argenta-SAE-2, Argenta-SAE-3, Argenta-SAE-4, Argenta-SAE-J, Brava-SME-1, Brava-SME-2, Brava-SME-3, Brava-SME-4, Brava-SMSA-1, Brava-SMSA-2, Brava-SMSA-3, Brava-SMSA-4, CK, CK-CKE, CK-CKE-CK-1, CK-CKE-CKE-1, CKE, CKX-CKXE-CKX-1, CKX-CKXE-CKXE-1, CMA, CompattaArgenta, Denise, Dora, Giada-1, Giada-2, Sara-1GR-1, Sara-2GR-2, Vania | | |

| | | | |
|---|--|-----------------|-------|
|  | | | |
| 1 | | | |
| GEV No. | 520707 | Ref. No. | 25785 |
| description | screw cap thread 3/8" thread L 8mm brass WS 21 head thickness 6mm | | |
| For models: | Argenta-AEP-1, Argenta-AEP-2, Argenta-AEP-3, Argenta-AEP-4, Argenta-AEP-J, Argenta-SAE-1, Argenta-SAE-2, Argenta-SAE-3, Argenta-SAE-4, Argenta-SAE-J, Brava, Brava-SME-1, Brava-SME-2, Brava-SME-3, Brava-SME-4, Brava-SMSA-1, Brava-SMSA-2, Brava-SMSA-3, Brava-SMSA-4, CMA, Divina, Divina-AEP-1, Divina-AEP-2, Divina-AEP-3, Divina-AEP-4, Divina-AEP-J, Divina-SAE-1, Divina-SAE-2, Divina-SAE-3, Divina-SAE-4, Divina-SAE-J, Dora, Giada-1, Giada-2, Giada-Fridge-Cup-warmer-1, Gloria-AEP-1, Gloria-AEP-2, Gloria-AEP-3, Gloria-AEP-4, Gloria-DISPLAY-LCL-2, Gloria-DISPLAY-LCL-3, Gloria-SAE-1, Gloria-SAE-2, Gloria-SAE-3, Gloria-SAE-4, Rapallo-AEP-1, Rapallo-AEP-2, Rapallo-AEP-3, Rapallo-AEP-4, Rapallo-AL-1... (Other models you can see in the webshop) | | |

| | | | |
|---|--|-----------------|--------|
|  | | | |
| 1 | | | |
| GEV No. | 520471 | Ref. No. | 257891 |
| description | screw cap thread M18x1.5 L 18mm chrome-plated brass key number 17 | | |
| For models: | Argenta, Brava, CKP, CKPE, Denise, Divina, Dora, Rapallo-AL-1, Rapallo-AL-2, Rapallo-AL-3, Rapallo-AL-4, Vania | | |

gaskets

| | | | |
|--|--|-----------------|-------|
|  | | | |
| 1 | | | |
| GEV No. | 528186 | Ref. No. | 12013 |
| description | base plate L 34mm H 4.6mm W 34mm | | |
| For models: | Argenta, Brava, CK-CKE-CK-1, CK-CKE-CKE-1, CKX-CKXE-CKX-1, CKX-CKXE-CKXE-1, CompattaArgenta, Divina-AEP-1, Divina-AEP-2, Divina-AEP-3, Divina-AEP-4, Divina-AEP-J, Divina-SAE-1, Divina-SAE-2, Divina-SAE-3, Divina-SAE-4, Divina-SAE-J, Dora, Gloria-AEP-1, Gloria-AEP-2, Gloria-AEP-3, Gloria-AEP-4, Gloria-DISPLAY-LCL-2, Gloria-DISPLAY-LCL-3, Gloria-SAE-1, Gloria-SAE-2, Gloria-SAE-3, Gloria-SAE-4, Rapallo-AEP-1, Rapallo-AEP-2, Rapallo-AEP-3, Rapallo-AEP-4, Sibilla-AEP-1, Sibilla-AEP-2, Sibilla-AEP-3, Sibilla-DISPLAY-2, Sibilla-DISPLAY-3, Sibilla-SAE-1, Sibilla-SAE-2, Sibilla-SAE-3, Vania | | |

filter holder supports

| | | | |
|--|---|-----------------|-------|
|  | | | |
| 1 | | | |
| GEV No. | 527610 | Ref. No. | 25250 |
| description | filter holder support turn direction right ED \varnothing 90mm ID \varnothing 72mm H 36mm mounting thread M5 | | |
| For models: | Argenta-AEP-1, Argenta-AEP-2, Argenta-AEP-3, Argenta-AEP-4, Argenta-AEP-J, Argenta-SAE-1, Argenta-SAE-2, Argenta-SAE-3, Argenta-SAE-4, Argenta-SAE-J, Brava-SME-1, Brava-SME-2, Brava-SME-3, Brava-SME-4, Brava-SMSA-1, Brava-SMSA-2, Brava-SMSA-3, Brava-SMSA-4, CK, CK-CKE, CK-CKE-CK-1, CK-CKE-CKE-1, CKE, CKX-CKXE, CKX-CKXE-CKX-1, CKX-CKXE-CKXE-1, CompattaArgenta, Denise, Dora, Vania | | |



| | | | |
|---|---|-----------------|-------|
| water dispersions | | | |
| water dispersions | | | |
| group 2 | | | |
|  | | | |
| 1 | | | |
| GEV No. | 529081 | Ref. No. | 27105 |
| description | water distributor ø 30mm hole ø 1.5mm H 15mm ET M10x1 grooves 6 2.5mm brass | | |

| | | | |
|---|---|-----------------|-------|
|  | | | |
| 1 | | | |
| GEV No. | 529230 | Ref. No. | 27105 |
| description | water distributor ø 30mm hole ø 2mm H 14mm ET M10x1 grooves 6 2mm brass 2 holes perforation ø 1.7mm | | |

| | | | |
|---|---|-----------------|----------------------|
|  | | | |
| 1 | | | |
| GEV No. | 528174 | Ref. No. | 25422004 25422008 |
| description | water distributor ø 32mm hole ø 1.25mm ET M18x1.5 | | |
| For models: | Brava, Divina-AEP-1, Divina-AEP-2, Divina-AEP-3, Divina-AEP-4, Divina-AEP-J, Divina-SAE-1, Divina-SAE-2, Divina-SAE-3, Divina-SAE-4, Divina-SAE-J, Gloria-AEP-1, Gloria-AEP-2, Gloria-AEP-3, Gloria-AEP-4, Gloria-DISPLAY-LCL-2, Gloria-DISPLAY-LCL-3, Gloria-SAE-1, Gloria-SAE-2, Gloria-SAE-3, Gloria-SAE-4, Rapallo-AEP-1, Rapallo-AEP-2, Rapallo-AEP-3, Rapallo-AEP-4, Sibilla-AEP-1, Sibilla-AEP-2, Sibilla-AEP-3, Sibilla-DISPLAY-2, Sibilla-DISPLAY-3, Sibilla-SAE-1, Sibilla-SAE-2, Sibilla-SAE-3 | | |

| | | | |
|---|--|-----------------|-------|
| group 3 | | | |
|  | | | |
| 1 | | | |
| GEV No. | 527609 | Ref. No. | 25627 |
| description | water distributor ø 56.5-59mm conical H 10mm 8 holes hole ø 1.3mm mounting ø 5.6mm brass | | |
| For models: | Argenta-AEP-1, Argenta-AEP-2, Argenta-AEP-3, Argenta-AEP-4, Argenta-AEP-J, Argenta-SAE-1, Argenta-SAE-2, Argenta-SAE-3, Argenta-SAE-4, Argenta-SAE-J, Brava, Brava-SME-1, Brava-SME-2, Brava-SME-3, Brava-SME-4, Brava-SMSA-1, Brava-SMSA-2, Brava-SMSA-3, Brava-SMSA-4, CK-CKE, CK-CKE-CK-1, CK-CKE-CKE-1, CKX-CKXE-CKX-1, CKX-CKXE-CKXE-1, CompattaArgenta, Denise, Divina, Divina-AEP-1, Divina-AEP-2, Divina-AEP-3, Divina-AEP-4, Divina-AEP-J, Divina-SAE-1, Divina-SAE-2, Divina-SAE-3, Divina-SAE-4, Divina-SAE-J, Dora, Gloria-AEP-1, Gloria-AEP-2, Gloria-AEP-3, Gloria-AEP-4, Gloria-DISPLAY-LCL-2, Gloria-DISPLAY-LCL-3, Gloria-SAE-1, Gloria-SAE-2, Gloria-SAE-3, Gloria-SAE-4, Rapallo-AEP-1, Rapallo-AEP-2...(Other models you can see in the webshop) | | |

| | | | |
|---|--|-----------------|-------|
| safety valves | | | |
| safety valves | | | |
| 1/8" | | | |
|  | | | |
| 1 | | | |
| GEV No. | 529331 | Ref. No. | 20357 |
| description | safety valve connection 1/8" triggering pressure 1.8bar | | |
| For models: | CK, CK-CKE, CK-CKE-CK-1, CK-CKE-CKE-1, CKE, CKP, CKPE, CKX-CKXE, CKX-CKXE-CKX-1, CKX-CKXE-CKXE-1 | | |

| | | | |
|---|---|-----------------|-------|
| 3/8" | | | |
|  | | | |
| 1 | | | |
| GEV No. | 529312 | Ref. No. | 20350 |
| description | safety valve connection 3/8" triggering pressure 1.8bar | | |
| For models: | Argenta, Denise | | |

| | | | |
|---|--|-----------------|-------|
|  | | | |
| 1 | | | |
| GEV No. | 529316 | Ref. No. | 20356 |
| description | safety valve connection 3/8" triggering pressure 1.8bar approval ISPEL sealed | | |
| For models: | Argenta, Argenta-AEP-1, Argenta-AEP-2, Argenta-AEP-3, Argenta-AEP-4, Argenta-AEP-J, Argenta-SAE-1, Argenta-SAE-2, Argenta-SAE-3, Argenta-SAE-4, Argenta-SAE-J, Brava, Brava-SME-1, Brava-SME-2, Brava-SME-3, Brava-SME-4, Brava-SMSA-1, Brava-SMSA-2, Brava-SMSA-3, Brava-SMSA-4, Denise, Divina, Divina-AEP-1, Divina-AEP-2, Divina-AEP-3, Divina-AEP-4, Divina-AEP-J, Divina-SAE-1, Divina-SAE-2, Divina-SAE-3, Divina-SAE-4, Divina-SAE-J, Dora, Gloria-AEP-1, Gloria-AEP-2, Gloria-AEP-3, Gloria-AEP-4, Gloria-DISPLAY-LCL-2, Gloria-DISPLAY-LCL-3, Gloria-SAE-1, Gloria-SAE-2, Gloria-SAE-3, Gloria-SAE-4, Rapallo-AEP-1, Rapallo-AEP-2, Rapallo-AEP-3, Rapallo-AEP-4, Rapallo-AL-1, Rapallo-AL-2, Rapallo-AL-3...(Other models you can see in the webshop) | | |

| | | | |
|---|---|-----------------|----------------|
|  | | | |
| 1 | | | |
| GEV No. | 529332 | Ref. No. | 20351 20352 |
| description | safety valve connection 3/8" triggering pressure 1.9bar approval CE 0036 sealed | | |
| For models: | Argenta, Argenta-AEP-1, Argenta-AEP-2, Argenta-AEP-3, Argenta-AEP-4, Argenta-AEP-J, Argenta-SAE-1, Argenta-SAE-2, Argenta-SAE-3, Argenta-SAE-4, Argenta-SAE-J, Brava, Brava-SME-1, Brava-SME-2, Brava-SME-3, Brava-SME-4, Brava-SMSA-1, Brava-SMSA-2, Brava-SMSA-3, Brava-SMSA-4, CMA, CompattaArgenta, Denise, Divina, Divina-AEP-1, Divina-AEP-2, Divina-AEP-3, Divina-AEP-4, Divina-AEP-J, Divina-SAE-1, Divina-SAE-2, Divina-SAE-3, Divina-SAE-4, Divina-SAE-J, Dora, Giada-1, Giada-2, Gloria-AEP-1, Gloria-AEP-2, Gloria-AEP-3, Gloria-AEP-4, Gloria-DISPLAY-LCL-2, Gloria-DISPLAY-LCL-3, Gloria-SAE-1, Gloria-SAE-2, Gloria-SAE-3, Gloria-SAE-4, Rapallo-AEP-1, Rapallo-AEP-2, Rapallo-AEP-3...(Other models you can see in the webshop) | | |

expansion valves



1

| | | | |
|--------------------|--|-----------------|-------|
| GEV No. | 529337 | Ref. No. | 56152 |
| description | expansion valve T1: 3/8" ET T2: 1/4" ET L 48mm | | |
| For models: | Argenta, Denise | | |

brass 3-way



1

| | | | |
|--------------------|-----------------|-----------------|-------|
| GEV No. | 529334 | Ref. No. | 56300 |
| description | expansion valve | | |
| For models: | Argenta, Denise | | |



1

| | | | |
|--------------------|---|-----------------|-------|
| GEV No. | 529336 | Ref. No. | 56210 |
| description | expansion valve | | |
| For models: | CK, CK-CKE, CK-CKE-CK-1, CK-CKE-CKE-1, CKE, CKX-CKXE, CKX-CKXE-CKX-1, CKX-CKXE-CKXE-1 | | |



1

| | | | |
|--------------------|---|-----------------|-------|
| GEV No. | 529333 | Ref. No. | 20361 |
| description | expansion valve connection 3/8" | | |
| For models: | Argenta-AEP-1, Argenta-AEP-2, Argenta-AEP-3, Argenta-AEP-4, Argenta-AEP-J, Argenta-SAE-1, Argenta-SAE-2, Argenta-SAE-3, Argenta-SAE-4, Argenta-SAE-J, Brava, Brava-SME-1, Brava-SME-2, Brava-SME-3, Brava-SME-4, Brava-SMSA-1, Brava-SMSA-2, Brava-SMSA-3, Brava-SMSA-4, CMA, CompattaArgenta, Divina, Divina-AEP-1, Divina-AEP-2, Divina-AEP-3, Divina-AEP-4, Divina-AEP-J, Divina-SAE-1, Divina-SAE-2, Divina-SAE-3, Divina-SAE-4, Divina-SAE-J, Dora, Giada-1, Giada-2, Gloria-AEP-1, Gloria-AEP-2, Gloria-AEP-3, Gloria-AEP-4, Gloria-DISPLAY-LCL-2, Gloria-DISPLAY-LCL-3, Gloria-SAE-1, Gloria-SAE-2, Gloria-SAE-3, Gloria-SAE-4, Rapallo-AEP-1, Rapallo-AEP-2, Rapallo-AEP-3, Rapallo-AEP-4, Rapallo-AL-1...(Other models you can see in the webshop) | | |

EQUIPMENT-SPECIFIC UNITS ASTORIA-CMA



1

| | | | |
|--------------------|------------------------------|-----------------|-------|
| GEV No. | 528937 | Ref. No. | 20361 |
| description | expansion valve controllable | | |

drain pans

drain pans



1

| | | | |
|--------------------|--|-----------------|-------|
| GEV No. | 528600 | Ref. No. | 15502 |
| description | drain pan connection 3/8" | | |
| For models: | Argenta, Argenta-AEP-1, Argenta-AEP-2, Argenta-AEP-3, Argenta-AEP-4, Argenta-AEP-J, Argenta-SAE-1, Argenta-SAE-2, Argenta-SAE-3, Argenta-SAE-4, Argenta-SAE-J, Brava, Brava-SME-1, Brava-SME-2, Brava-SME-3, Brava-SME-4, Brava-SMSA-1, Brava-SMSA-2, Brava-SMSA-3, Brava-SMSA-4, CK-CKE, CK-CKE-CK-1, CK-CKE-CKE-1, CKP, CKPE, CKX-CKXE, CKX-CKXE-CKX-1, CKX-CKXE-CKXE-1, CompattaArgenta, Denise, Divina, Divina-AEP-1, Divina-AEP-2, Divina-AEP-3, Divina-AEP-4, Divina-AEP-J, Divina-SAE-1, Divina-SAE-2, Divina-SAE-3, Divina-SAE-4, Divina-SAE-J, Dora, DPiu-1, Giada-1, Giada-2, Gloria-AEP-1, Gloria-AEP-2, Gloria-AEP-3, Gloria-AEP-4, Gloria-DISPLAY-LCL-2...(Other models you can see in the webshop) | | |

aerators and air bleeders





1

| | | | |
|--------------------|--|-----------------|-------|
| GEV No. | 529304 | Ref. No. | 56150 |
| description | aerator and air bleeder screw connection 1/4" | | |
| For models: | Argenta, Argenta-AEP-1, Argenta-AEP-2, Argenta-AEP-3, Argenta-AEP-4, Argenta-AEP-J, Argenta-SAE-1, Argenta-SAE-2, Argenta-SAE-3, Argenta-SAE-4, Argenta-SAE-J, Brava, Brava-SME-1, Brava-SME-2, Brava-SME-3, Brava-SME-4, Brava-SMSA-1, Brava-SMSA-2, Brava-SMSA-3, Brava-SMSA-4, CK, CK-CKE, CK-CKE-CK-1, CK-CKE-CKE-1, CKE, CKP, CKPE, CKX-CKXE, CKX-CKXE-CKX-1, CKX-CKXE-CKXE-1, CMA, CompattaArgenta, Denise, Divina, Divina-AEP-1, Divina-AEP-2, Divina-AEP-3, Divina-AEP-4, Divina-AEP-J, Divina-SAE-1, Divina-SAE-2, Divina-SAE-3, Divina-SAE-4, Divina-SAE-J, Dora, Gloria-AEP-1, Gloria-AEP-2, Gloria-AEP-3, Gloria-AEP-4, Gloria-DISPLAY-LCL-2...(Other models you can see in the webshop) | | |



| | | | |
|---|--|-----------------|-------|
| boilers | | | |
| gaskets | | | |
| perforated | | | |
|  | | | |
| 1 | | | |
| GEV No. | 528151 | Ref. No. | 12003 |
| description | boiler gasket D1 ø 190mm D2 ø 140mm thickness 3mm 11 holes PTFE suitable for Astoria / Wega equiv. no. 12003 | | |
| For models: | Argenta, Argenta-AEP-1, Argenta-AEP-2, Argenta-AEP-3, Argenta-AEP-4, Argenta-AEP-J, Argenta-SAE-1, Argenta-SAE-2, Argenta-SAE-3, Argenta-SAE-4, Argenta-SAE-J, Brava, Brava-SME-1, Brava-SME-2, Brava-SME-3, Brava-SME-4, Brava-SMSA-1, Brava-SMSA-2, Brava-SMSA-3, Brava-SMSA-4, Denise, Divina, Divina-AEP-1, Divina-AEP-2, Divina-AEP-3, Divina-AEP-4, Divina-AEP-J, Divina-SAE-1, Divina-SAE-2, Divina-SAE-3, Divina-SAE-4, Divina-SAE-J, Dora, Gloria-AEP-1, Gloria-AEP-2, Gloria-AEP-3, Gloria-AEP-4, Gloria-DISPLAY-LCL-2, Gloria-DISPLAY-LCL-3, Gloria-SAE-1, Gloria-SAE-2, Gloria-SAE-3, Gloria-SAE-4, Rapallo-AEP-1, Rapallo-AEP-2, Rapallo-AEP-3, Rapallo-AEP-4, Rapallo-AL-1, Rapallo-AL-2, Rapallo-AL-3...(Other models you can see in the webshop) | | |

| | | | |
|---|---|-----------------|-------|
|  | | | |
| 1 | | | |
| GEV No. | 528150 | Ref. No. | 12003 |
| description | boiler gasket D1 ø 190mm D2 ø 140mm thickness 3mm 11 holes PTFE suitable for ASTORIA equiv. no. 12003 | | |

| | | | |
|---|--|-----------------|-------|
|  | | | |
| 1 | | | |
| GEV No. | 528097 | Ref. No. | 12018 |
| description | gasket D1 ø 170mm D2 ø 220mm thickness 2mm 12 holes PTFE | | |
| For models: | CompattaArgenta | | |

| | | | |
|---|---|-----------------|-------|
| unperforated | | | |
|  | | | |
| 1 | | | |
| GEV No. | 528096 | Ref. No. | 12016 |
| description | gasket D1 ø 61mm D2 ø 73mm thickness 2mm PTFE | | |
| For models: | CompattaArgenta | | |

| | | | |
|---|---|-----------------|------------|
| heat exchangers | | | |
| injector tubes | | | |
|  | | | |
| 1 | | | |
| GEV No. | 527774 | Ref. No. | WY52001612 |
| description | injector pipe boiler tube ø 10mm pipe length 108mm T1: 3/8" T2: 3/8" copper | | |

| | | | |
|--|---|-----------------|----------|
|  | | | |
| 1 | | | |
| GEV No. | 527800 | Ref. No. | 52000119 |
| description | injector pipe boiler tube ø 10mm pipe length 109mm T1: 3/8" T2: 3/8" copper | | |
| For models: | Argenta, Argenta-AEP-1, Argenta-AEP-2, Argenta-AEP-3, Argenta-AEP-4, Argenta-AEP-J, Argenta-SAE-1, Argenta-SAE-2, Argenta-SAE-3, Argenta-SAE-4, Argenta-SAE-J, Brava, Brava-SME-1, Brava-SME-2, Brava-SME-3, Brava-SME-4, Brava-SMSA-1, Brava-SMSA-2, Brava-SMSA-3, Brava-SMSA-4, CompattaArgenta, Denise, Divina, Divina-AEP-1, Divina-AEP-2, Divina-AEP-3, Divina-AEP-4, Divina-AEP-J, Divina-SAE-1, Divina-SAE-2, Divina-SAE-3, Divina-SAE-4, Divina-SAE-J, Dora, Gloria-AEP-1, Gloria-AEP-2, Gloria-AEP-3, Gloria-AEP-4, Gloria-DISPLAY-LCL-2, Gloria-DISPLAY-LCL-3, Gloria-SAE-1, Gloria-SAE-2, Gloria-SAE-3, Gloria-SAE-4, Rapallo-AEP-1, Rapallo-AEP-2, Rapallo-AEP-3, Rapallo-AEP-4, Rapallo-AL-1, Rapallo-AL-2...(Other models you can see in the webshop) | | |

| | | | |
|--|---|-----------------|----------|
|  | | | |
| 1 | | | |
| GEV No. | 527773 | Ref. No. | 52000184 |
| description | injector pipe boiler tube ø 10mm pipe length 112mm T1: 3/8" T2: 3/8" copper | | |

| | | | |
|--|--|-----------------|----------|
|  | | | |
| 1 | | | |
| GEV No. | 527775 | Ref. No. | 52000118 |
| description | injector pipe boiler tube ø 10mm pipe length 123mm T1: 3/8" T2: 3/8" copper | | |
| For models: | Argenta, Argenta-AEP-1, Argenta-AEP-2, Argenta-AEP-3, Argenta-AEP-4, Argenta-AEP-J, Argenta-SAE-1, Argenta-SAE-2, Argenta-SAE-3, Argenta-SAE-4, Argenta-SAE-J, Brava, Brava-SME-1, Brava-SME-2, Brava-SME-3, Brava-SME-4, Brava-SMSA-1, Brava-SMSA-2, Brava-SMSA-3, Brava-SMSA-4, Denise, Divina, Divina-AEP-1, Divina-AEP-2, Divina-AEP-3, Divina-AEP-4, Divina-AEP-J, Divina-SAE-1, Divina-SAE-2, Divina-SAE-3, Divina-SAE-4, Divina-SAE-J, Dora, Gloria-AEP-1, Gloria-AEP-2, Gloria-AEP-3, Gloria-AEP-4, Gloria-DISPLAY-LCL-2, Gloria-DISPLAY-LCL-3, Gloria-SAE-1, Gloria-SAE-2, Gloria-SAE-3, Gloria-SAE-4, Rapallo-AEP-1, Rapallo-AEP-2, Rapallo-AEP-3, Rapallo-AEP-4, Rapallo-AL-1, Rapallo-AL-2, Rapallo-AL-3...(Other models you can see in the webshop) | | |

| | | | |
|--|--|-----------------|----------|
|  | | | |
| 1 | | | |
| GEV No. | 527799 | Ref. No. | 52000360 |
| description | injector pipe boiler tube ø 10mm pipe length 75mm T1: 3/8" T2: 3/8" copper | | |
| For models: | Sibilla-AEP-1, Sibilla-AEP-2, Sibilla-AEP-3, Sibilla-DISPLAY-2, Sibilla-DISPLAY-3, Sibilla-SAE-1, Sibilla-SAE-2, Sibilla-SAE-3 | | |

| | | | |
|--|--|-----------------|----------|
|  | | | |
| 1 | | | |
| GEV No. | 527798 | Ref. No. | 25686001 |
| description | injector pipe boiler tube ø 6mm pipe length 79mm T1: 1/4" T2: 1/4" copper | | |
| For models: | Divina, Divina-AEP-1, Divina-AEP-2, Divina-AEP-3, Divina-AEP-4, Divina-AEP-J, Divina-SAE-1, Divina-SAE-2, Divina-SAE-3, Divina-SAE-4, Divina-SAE-J, Gloria-AEP-1, Gloria-AEP-2, Gloria-AEP-3, Gloria-AEP-4, Gloria-DISPLAY-LCL-2, Gloria-DISPLAY-LCL-3, Gloria-SAE-1, Gloria-SAE-2, Gloria-SAE-3, Gloria-SAE-4 | | |

| | | | |
|---|---|-----------------|----------|
|  | | | |
| 1 | | | |
| GEV No. | 527796 | Ref. No. | 52002788 |
| description | injector pipe boiler tube ø 6mm pipe length 80mm T1: 1/4" T2: 1/4" copper | | |
| For models: | CMA, Giada-1, Giada-2, Sara-1GR-1, Sara-2GR-2 | | |

| | | | |
|---|---|-----------------|----------|
|  | | | |
| 1 | | | |
| GEV No. | 527879 | Ref. No. | 52001834 |
| description | injector pipe for boiler tube ø 12mm pipe length 170mm T1: 1/2" T2: 1/2" copper | | |
| For models: | CompattaArgenta | | |

heat exchangers

| | | | |
|---|--|-----------------|----------|
|  | | | |
| 1 | | | |
| GEV No. | 527880 | Ref. No. | 63100002 |
| description | heat exchanger detachable ø 42mm L 170mm | | |
| For models: | Sibilla-AEP-1, Sibilla-AEP-2, Sibilla-AEP-3, Sibilla-DISPLAY-2, Sibilla-DISPLAY-3, Sibilla-SAE-1, Sibilla-SAE-2, Sibilla-SAE-3 | | |

| | | | |
|---|---|-----------------|-------|
|  | | | |
| 1 | | | |
| GEV No. | 527618 | Ref. No. | 63100 |
| description | heat exchanger detachable ø 42mm L 210mm for ASTORIA | | |
| For models: | Argenta, Brava, Denise, Dora, Rapallo-AEP-1, Rapallo-AEP-2, Rapallo-AEP-3, Rapallo-AEP-4, Vania | | |

| | | | |
|---|--|-----------------|-------|
|  | | | |
| 1 | | | |
| GEV No. | 527617 | Ref. No. | 63032 |
| description | heat exchanger detachable ø 60mm L 200mm for ASTORIA | | |
| For models: | CompattaArgenta | | |

| | | | |
|--|---|-----------------|-------|
|  | | | |
| 1 | | | |
| GEV No. | 527616 | Ref. No. | 63001 |
| description | heat exchanger ø 52mm L 150mm T1: 3/8" T2: 3/8" for ASTORIA | | |
| For models: | Argenta, Argenta-AEP-1, Argenta-AEP-2, Argenta-AEP-3, Argenta-AEP-4, Argenta-AEP-J, Argenta-SAE-1, Argenta-SAE-2, Argenta-SAE-3, Argenta-SAE-4, Argenta-SAE-J, Brava-SME-1, Brava-SME-2, Brava-SME-3, Brava-SME-4, Brava-SMSA-1, Brava-SMSA-2, Brava-SMSA-3, Brava-SMSA-4, Denise | | |

| | | | |
|--|---|-----------------|-------|
|  | | | |
| 1 | | | |
| GEV No. | 527615 | Ref. No. | 63002 |
| description | heat exchanger ø 52mm L 165mm T1: 3/8" T2: 3/8" for ASTORIA | | |
| For models: | Argenta, Argenta-AEP-1, Argenta-AEP-2, Argenta-AEP-3, Argenta-AEP-4, Argenta-AEP-J, Argenta-SAE-1, Argenta-SAE-2, Argenta-SAE-3, Argenta-SAE-4, Argenta-SAE-J, Brava-SME-1, Brava-SME-2, Brava-SME-3, Brava-SME-4, Brava-SMSA-1, Brava-SMSA-2, Brava-SMSA-3, Brava-SMSA-4, Denise | | |

accessories

| | | | |
|--|-------------|-----------------|-------|
|  | | | |
| Image not available | | | |
| 1 | | | |
| GEV No. | 531076 | Ref. No. | 23135 |
| description | thread bolt | | |

| | | | |
|--|--|-----------------|-------|
|  | | | |
| 1 | | | |
| GEV No. | 527854 | Ref. No. | 23133 |
| description | thread bolt for heating element thread M8 L 40mm | | |
| For models: | Argenta-AEP-1, Argenta-AEP-2, Argenta-AEP-3, Argenta-AEP-4, Argenta-AEP-J, Argenta-SAE-1, Argenta-SAE-2, Argenta-SAE-3, Argenta-SAE-4, Argenta-SAE-J, Brava, Brava-SME-1, Brava-SME-2, Brava-SME-3, Brava-SME-4, Brava-SMSA-1, Brava-SMSA-2, Brava-SMSA-3, Brava-SMSA-4, Divina-AEP-1, Divina-AEP-2, Divina-AEP-3, Divina-AEP-4, Divina-AEP-J, Divina-SAE-1, Divina-SAE-2, Divina-SAE-3, Divina-SAE-4, Divina-SAE-J, Dora, Gloria-AEP-1, Gloria-AEP-2, Gloria-AEP-3, Gloria-AEP-4, Gloria-DISPLAY-LCL-2, Gloria-DISPLAY-LCL-3, Gloria-SAE-1, Gloria-SAE-2, Gloria-SAE-3, Gloria-SAE-4, Rapallo-AEP-1, Rapallo-AEP-2, Rapallo-AEP-3, Rapallo-AEP-4, Rapallo-AL-1, Rapallo-AL-2, Rapallo-AL-3, Rapallo-AL-4, Vania | | |



| | | | |
|---|--|-----------------|----------|
|  | | | |
| 1 | | | |
| GEV No. | 527870 | Ref. No. | 23132001 |
| description | thread bolt for heating element thread M8 L 41mm | | |
| For models: | Giada-1, Giada-2, Sara-1GR-1, Sara-2GR-2, Sibilla-AEP-1, Sibilla-AEP-2, Sibilla-AEP-3, Sibilla-DISPLAY-2, Sibilla-DISPLAY-3, Sibilla-SAE-1, Sibilla-SAE-2, Sibilla-SAE-3 | | |

| | | | |
|--|---|-----------------|--------|
|  | | | |
| 1 | | | |
| GEV No. | 526076 | Ref. No. | 521105 |
| description | shaft for steam-/water-tap ø 14.75mm L 88mm brass | | |

steam/water taps

steam/water taps

steam taps

steam taps (complete)

| | | | |
|---|--|-----------------|-------|
|  | | | |
| 1 | | | |
| GEV No. | 529770 | Ref. No. | 56110 |
| description | steam tap with steam pipe | | |
| For models: | CK, CK-CKE, CK-CKE-CK-1, CK-CKE-CKE-1, CKE, CKP, CKPE, CKX-CKXE, CKX-CKXE-CKX-1, CKX-CKXE-CKXE-1 | | |

bushes

| | | | |
|---|---|-----------------|-------|
|  | | | |
| 1 | | | |
| GEV No. | 529718 | Ref. No. | 25657 |
| description | bush for steam tap D1 ø 14.7mm ID ø 7.2mm H 3.5mm brass | | |
| For models: | Argenta, Argenta-AEP-1, Argenta-AEP-2, Argenta-AEP-3, Argenta-AEP-4, Argenta-AEP-J, Argenta-SAE-1, Argenta-SAE-2, Argenta-SAE-3, Argenta-SAE-4, Argenta-SAE-J, Brava-SME-1, Brava-SME-2, Brava-SME-3, Brava-SME-4, Brava-SMSA-1, Brava-SMSA-2, Brava-SMSA-3, Brava-SMSA-4, CK, CK-CKE, CK-CKE-CK-1, CK-CKE-CKE-1, CKE, CKP, CKPE, CKX-CKXE, CKX-CKXE-CKX-1, CKX-CKXE-CKXE-1, CMA, CompattaArgenta, Denise, Dora, Giada-1, Giada-2, Giada-Fridge-Cup-warmer-1, Rapallo-AEP-1, Rapallo-AEP-2, Rapallo-AEP-3, Rapallo-AEP-4, Rapallo-AL-1, Rapallo-AL-2, Rapallo-AL-3, Rapallo-AL-4, Sara-1GR-1, Sara-2GR-2, Sara-Fridge-Cup-warmer, Sibilla-AEP-1, Sibilla-AEP-2, Sibilla-AEP-3...(Other models you can see in the webshop) | | |

knobs

| | | | |
|--|--|-----------------|------------|
|  | | | |
| 1 | | | |
| GEV No. | 527756 | Ref. No. | WY15278012 |
| description | knob steam ø 45mm shaft ø 8mm shaft flat 9.5 black | | |

gaskets

| | | | |
|--|---|-----------------|-------|
|  | | | |
| 1 | | | |
| GEV No. | 528313 | Ref. No. | 12204 |
| description | shaft sealing D1 ø 12.5mm D2 ø 7.9mm thickness 8.8mm rubber for steam tap | | |
| For models: | Argenta, Argenta-AEP-1, Argenta-AEP-2, Argenta-AEP-3, Argenta-AEP-4, Argenta-AEP-J, Argenta-SAE-1, Argenta-SAE-2, Argenta-SAE-3, Argenta-SAE-4, Argenta-SAE-J, Brava, Brava-SME-1, Brava-SME-2, Brava-SME-3, Brava-SME-4, Brava-SMSA-1, Brava-SMSA-2, Brava-SMSA-3, Brava-SMSA-4, CK, CK-CKE, CK-CKE-CK-1, CK-CKE-CKE-1, CKE, CKP, CKPE, CKX-CKXE, CKX-CKXE-CKX-1, CKX-CKXE-CKXE-1, CMA, CompattaArgenta, Denise, Divina, Divina-AEP-1, Divina-AEP-2, Divina-AEP-3, Divina-AEP-4, Divina-AEP-J, Divina-SAE-1, Divina-SAE-2, Divina-SAE-3, Divina-SAE-4, Divina-SAE-J, Dora, Giada-1, Giada-2, Giada-Fridge-Cup-warmer-1, Gloria-AEP-1, Gloria-AEP-2...(Other models you can see in the webshop) | | |

components

shafts

| | | | |
|---|---|-----------------|-------|
|  | | | |
| 1 | | | |
| GEV No. | 529218 | Ref. No. | 25309 |
| description | shaft for coffee machine tap L 145mm | | |
| For models: | Argenta, Argenta-AEP-1, Argenta-AEP-2, Argenta-AEP-3, Argenta-AEP-4, Argenta-AEP-J, Argenta-SAE-1, Argenta-SAE-2, Argenta-SAE-3, Argenta-SAE-4, Argenta-SAE-J, CompattaArgenta, Denise, Rapallo-AEP-1, Rapallo-AEP-2, Rapallo-AEP-3, Rapallo-AEP-4, Rapallo-AL-1, Rapallo-AL-2, Rapallo-AL-3, Rapallo-AL-4, Vania | | |

gasket supports

| | | | |
|---|---|-----------------|-------|
|  <p>Image not available</p> | | | |
| 1 | | | |
| GEV No. | 527195 | Ref. No. | 25616 |
| description | piston for tap ø 17.6mm L 13.1mm thread M3/M16 SS | | |
| For models: | Argenta, Argenta-AEP-1, Argenta-AEP-2, Argenta-AEP-3, Argenta-AEP-4, Argenta-AEP-J, Argenta-SAE-1, Argenta-SAE-2, Argenta-SAE-3, Argenta-SAE-4, Argenta-SAE-J, Brava-SME-1, Brava-SME-2, Brava-SME-3, Brava-SME-4, Brava-SMSA-1, Brava-SMSA-2, Brava-SMSA-3, Brava-SMSA-4, CK, CK-CKE, CK-CKE-CK-1, CK-CKE-CKE-1, CKE, CKP, CKPE, CKX-CKXE-CKX-1, CKX-CKXE-CKXE-1, CompattaArgenta, Denise, Divina, Divina-AEP-1, Divina-AEP-2, Divina-AEP-3, Divina-AEP-4, Divina-AEP-J, Divina-SAE-1, Divina-SAE-2, Divina-SAE-3, Divina-SAE-4, Divina-SAE-J, Dora, Giada-1, Giada-2, Giada-Fridge-Cup-warmer-1, Gloria-AEP-1, Gloria-AEP-2, Gloria-AEP-3, Gloria-AEP-4, Gloria-DISPLAY-LCL-2...(Other models you can see in the webshop) | | |

tap bodies



| | | | |
|--------------------|--|-----------------|-------|
| GEV No. | 529670 | Ref. No. | 53003 |
| description | tap body | | |
| For models: | Argenta, Argenta-AEP-1, Argenta-AEP-2, Argenta-AEP-3, Argenta-AEP-4, Argenta-AEP-J, Argenta-SAE-1, Argenta-SAE-2, Argenta-SAE-3, Argenta-SAE-4, Argenta-SAE-J, Brava, Brava-SME-1, Brava-SME-2, Brava-SME-3, Brava-SME-4, Brava-SMSA-1, Brava-SMSA-2, Brava-SMSA-3, Brava-SMSA-4, CK, CK-CKE, CK-CKE-CK-1, CK-CKE-CKE-1, CKE, CKP, CKPE, CKX-CKXE, CKX-CKXE-CKX-1, CKX-CKXE-CKXE-1, CMA, CompattaArgenta, Denise, Divina, Divina-AEP-1, Divina-AEP-2, Divina-AEP-3, Divina-AEP-4, Divina-AEP-J, Divina-SAE-1, Divina-SAE-2, Divina-SAE-3, Divina-SAE-4, Divina-SAE-J, Dora, Giada-1, Giada-2, Giada-Fridge-Cup-warmer-1, Gloria-AEP-1, Gloria-AEP-2... (Other models you can see in the webshop) | | |

union nuts



| | | | |
|--------------------|---|-----------------|-------|
| GEV No. | 527198 | Ref. No. | 25385 |
| description | union nut thread 3/8" ID ø 8.3mm L 19mm WS 20 | | |

union screws



| | | | |
|--------------------|--|-----------------|-------|
| GEV No. | 527196 | Ref. No. | 25461 |
| description | union screw thread M16x1 outer ID ø 10.6mm brass | | |
| For models: | Argenta, Argenta-AEP-1, Argenta-AEP-2, Argenta-AEP-3, Argenta-AEP-4, Argenta-AEP-J, Argenta-SAE-1, Argenta-SAE-2, Argenta-SAE-3, Argenta-SAE-4, Argenta-SAE-J, Brava, Brava-SME-1, Brava-SME-2, Brava-SME-3, Brava-SME-4, Brava-SMSA-1, Brava-SMSA-2, Brava-SMSA-3, Brava-SMSA-4, CK, CK-CKE, CK-CKE-CK-1, CK-CKE-CKE-1, CKE, CKP, CKPE, CKX-CKXE, CKX-CKXE-CKX-1, CKX-CKXE-CKXE-1, CMA, CompattaArgenta, Denise, Divina, Divina-AEP-1, Divina-AEP-2, Divina-AEP-3, Divina-AEP-4, Divina-AEP-J, Divina-SAE-1, Divina-SAE-2, Divina-SAE-3, Divina-SAE-4, Divina-SAE-J, Dora, Giada-1, Giada-2, Giada-Fridge-Cup-warmer-1, Gloria-AEP-1, Gloria-AEP-2... (Other models you can see in the webshop) | | |

valve bodies



| | | | |
|--------------------|--|-----------------|--------|
| GEV No. | 529073 | Ref. No. | 561021 |
| description | front part for coffee machine tap | | |
| For models: | CMA, Giada-1, Giada-2, Giada-Fridge-Cup-warmer-1, Sara-1GR-1, Sara-2GR-2, Sara-Fridge-Cup-warmer | | |



| | | | |
|--------------------|-----------------------------------|-----------------|--------|
| GEV No. | 529658 | Ref. No. | 56100R |
| description | front part for coffee machine tap | | |

screw connections



| | | | |
|--------------------|--|-----------------|----------|
| GEV No. | 527250 | Ref. No. | 25691003 |
| description | connecting fitting L 29mm ID ø 8mm WS 22 brass thread 3/8" IT - 3/8" ET | | |
| For models: | CK, CK-CKE, CK-CKE-CK-1, CK-CKE-CKE-1, CKE, CKP, CKPE, CKX-CKXE, CKX-CKXE-CKX-1, CKX-CKXE-CKXE-1 | | |



| | | | |
|--------------------|---|-----------------|----------|
| GEV No. | 527199 | Ref. No. | 25678001 |
| description | screw connection for tap L 36mm ID ø 8.6mm WS 20 brass thread 3/8" ET - 1/2" ET | | |
| For models: | Argenta-AEP-1, Argenta-AEP-2, Argenta-AEP-3, Argenta-AEP-4, Argenta-AEP-J, Argenta-SAE-1, Argenta-SAE-2, Argenta-SAE-3, Argenta-SAE-4, Argenta-SAE-J, Brava, Brava-SME-1, Brava-SME-2, Brava-SME-3, Brava-SME-4, Brava-SMSA-1, Brava-SMSA-2, Brava-SMSA-3, Brava-SMSA-4, CK-CKE, CK-CKE-CK-1, CK-CKE-CKE-1, CKX-CKXE, CKX-CKXE-CKX-1, CKX-CKXE-CKXE-1, CMA, CompattaArgenta, Divina, Divina-AEP-1, Divina-AEP-2, Divina-AEP-3, Divina-AEP-4, Divina-AEP-J, Divina-SAE-1, Divina-SAE-2, Divina-SAE-3, Divina-SAE-4, Divina-SAE-J, Dora, Giada-1, Giada-2, Giada-Fridge-Cup-warmer-1, Gloria-AEP-1, Gloria-AEP-2, Gloria-AEP-3, Gloria-AEP-4, Gloria-DISPLAY-LCL-2, Gloria-DISPLAY-LCL-3, Gloria-SAE-1, Gloria-SAE-2... (Other models you can see in the webshop) | | |

water taps

knobs



| | | | |
|--------------------|---|-----------------|-------|
| GEV No. | 111152 | Ref. No. | 15264 |
| description | knob water ø 40mm black | | |
| For models: | Argenta, Argenta-AEP-1, Argenta-AEP-2, Argenta-AEP-3, Argenta-AEP-4, Argenta-AEP-J, Argenta-SAE-1, Argenta-SAE-2, Argenta-SAE-3, Argenta-SAE-4, Argenta-SAE-J, Divina, Divina-AEP-1, Divina-AEP-2, Divina-AEP-3, Divina-AEP-4, Divina-AEP-J, Divina-SAE-1, Divina-SAE-2, Divina-SAE-3, Divina-SAE-4, Divina-SAE-J | | |



1

| | | | |
|--------------------|-------------------------------------|-----------------|------------|
| GEV No. | 527757 | Ref. No. | WY15278013 |
| description | knob water ø 45mm shaft ø 8mm black | | |



1

| | | | |
|---|--------------------------------------|-----------------|-------|
| GEV No. | 111157 | Ref. No. | 15276 |
| description | knob water ø 46mm black | | |
| For models: | Denise, Vania | | |
| accessories for | 111157 | | |
| | GEV No. | Ref. No. | — |
|  | 112494 | | |
| | knob spring L 10.5mm W 9mm Qty 1 pcs | | |



1

| | | | |
|--------------------|---|-----------------|----------|
| GEV No. | 111153 | Ref. No. | 15277998 |
| description | knob water ø 49mm shaft ø 8x6.5mm shaft flat upper black | | |
| For models: | Brava, Brava-SME-1, Brava-SME-2, Brava-SME-3, Brava-SME-4, Brava-SMSA-1, Brava-SMSA-2, Brava-SMSA-3, Brava-SMSA-4 | | |



1

| | | | |
|--------------------|-------------------------|-----------------|-------|
| GEV No. | 111156 | Ref. No. | 15253 |
| description | knob water ø 54mm black | | |
| For models: | Argenta, Dora | | |

steam/water pipes

steam pipes



1

| | | | |
|--------------------|------------|-----------------|-------|
| GEV No. | 529622 | Ref. No. | 90313 |
| description | steam pipe | | |
| For models: | Argenta | | |



1

| | | | |
|--------------------|--------------------------------|-----------------|--------|
| GEV No. | 529773 | Ref. No. | 90310R |
| description | steam pipe complete L 285mm SS | | |
| For models: | Dora | | |



1

| | | | |
|--------------------|--------------------------------|-----------------|--------|
| GEV No. | 529772 | Ref. No. | 90309R |
| description | steam pipe complete L 320mm SS | | |
| For models: | Dora | | |



1

| | | | |
|--------------------|---|-----------------|-------------------|
| GEV No. | 529777 | Ref. No. | 56108 56108100 |
| description | steam pipe complete SS | | |
| For models: | Brava, Brava-SME-1, Brava-SME-2, Brava-SME-3, Brava-SME-4, Brava-SMSA-1, Brava-SMSA-2, Brava-SMSA-3, Brava-SMSA-4, Divina-AEP-1, Divina-AEP-2, Divina-AEP-3, Divina-AEP-4, Divina-AEP-J, Divina-SAE-1, Divina-SAE-2, Divina-SAE-3, Divina-SAE-4, Divina-SAE-J | | |



1

| | | | |
|--------------------|------------------------|-----------------|-----------|
| GEV No. | 529778 | Ref. No. | 83250002R |
| description | steam pipe complete SS | | |



1

| | | | |
|--------------------|-------------------------------|-----------------|----------------------|
| GEV No. | 529226 | Ref. No. | 25763022 25763157 |
| description | steam pipe L 200mm IT 3/8" SS | | |

| | | | |
|---|--|-----------------|----------------------|
|  | | | |
| 1 | | | |
| GEV No. | 527787 | Ref. No. | 25763300 56119160 |
| description | steam pipe L 210mm W 140mm tube ø 10mm SS | | |
| For models: | Divina-AEP-1, Divina-AEP-2, Divina-AEP-3, Divina-AEP-4, Divina-AEP-J, Divina-SAE-1, Divina-SAE-2, Divina-SAE-3, Divina-SAE-4, Divina-SAE-J | | |

| | | | |
|---|--|-----------------|----------------------|
|  | | | |
| 1 | | | |
| GEV No. | 527783 | Ref. No. | 25763304 56106100 |
| description | steam pipe L 265mm W 140mm tube ø 8mm SS | | |
| For models: | Argenta-AEP-1, Argenta-AEP-2, Argenta-AEP-3, Argenta-AEP-4, Argenta-AEP-J, Argenta-SAE-1, Argenta-SAE-2, Argenta-SAE-3, Argenta-SAE-4, Argenta-SAE-J, CompattaArgenta, Giada-1, Giada-2, Giada-Fridge-Cup-warmer-1, Sara-1GR-1, Sara-2GR-2, Sara-Fridge-Cup-warmer | | |

| | | | |
|--|--|-----------------|----------------------|
|  | | | |
| 1 | | | |
| GEV No. | 527784 | Ref. No. | 25763317 56119000 |
| description | steam pipe L 270mm W 150mm tube ø 8mm SS | | |
| For models: | Brava-SME-1, Brava-SME-2, Brava-SME-3, Brava-SME-4, Brava-SMSA-1, Brava-SMSA-2, Brava-SMSA-3, Brava-SMSA-4 | | |

| | | | |
|---|---|-----------------|----------|
|  | | | |
| 1 | | | |
| GEV No. | 527782 | Ref. No. | 56119107 |
| description | steam pipe L 275mm W 150mm tube ø 8mm nickel-plated copper | | |
| For models: | Argenta-AEP-1, Argenta-AEP-2, Argenta-AEP-3, Argenta-AEP-4, Argenta-AEP-J, Argenta-SAE-1, Argenta-SAE-2, Argenta-SAE-3, Argenta-SAE-4, Argenta-SAE-J, CompattaArgenta | | |

| | | | |
|---|---|-----------------|----------------------|
|  | | | |
| 1 | | | |
| GEV No. | 527786 | Ref. No. | 25763310 56115100 |
| description | steam pipe L 280mm W 170mm tube ø 8mm SS | | |
| For models: | Argenta-AEP-1, Argenta-AEP-2, Argenta-AEP-3, Argenta-AEP-4, Argenta-AEP-J, Argenta-SAE-1, Argenta-SAE-2, Argenta-SAE-3, Argenta-SAE-4, Argenta-SAE-J, CompattaArgenta | | |

| | | | |
|--|---|-----------------|----------------------|
|  | | | |
| 1 | | | |
| GEV No. | 527785 | Ref. No. | 25763308 56114100 |
| description | steam pipe L 310mm W 140mm tube ø 8mm SS | | |
| For models: | Argenta-AEP-1, Argenta-AEP-2, Argenta-AEP-3, Argenta-AEP-4, Argenta-AEP-J, Argenta-SAE-1, Argenta-SAE-2, Argenta-SAE-3, Argenta-SAE-4, Argenta-SAE-J, CompattaArgenta | | |

| | | | |
|--|---|-----------------|----------|
|  | | | |
| 1 | | | |
| GEV No. | 561000 | Ref. No. | 56119108 |
| description | steam pipe L 345mm W 150mm tube ø 8mm nickel-plated copper | | |
| For models: | Argenta-AEP-1, Argenta-AEP-2, Argenta-AEP-3, Argenta-AEP-4, Argenta-AEP-J, Argenta-SAE-1, Argenta-SAE-2, Argenta-SAE-3, Argenta-SAE-4, Argenta-SAE-J, CompattaArgenta | | |

| | | | |
|--|--|-----------------|----------|
|  | | | |
| 1 | | | |
| GEV No. | 527777 | Ref. No. | 25763014 |
| description | steam pipe mounting pos. left with tube handle thread 3/8" H 235mm W 60mm tube ø 10mm SS | | |
| For models: | Sibilla-AEP-1, Sibilla-AEP-2, Sibilla-AEP-3, Sibilla-DISPLAY-2, Sibilla-DISPLAY-3, Sibilla-SAE-1, Sibilla-SAE-2, Sibilla-SAE-3 | | |

| | | | |
|--|--|-----------------|----------|
|  | | | |
| 1 | | | |
| GEV No. | 527778 | Ref. No. | 25763013 |
| description | steam pipe mounting pos. right with tube handle thread 3/8" H 235mm W 60mm tube ø 10mm SS | | |
| For models: | Sibilla-AEP-1, Sibilla-AEP-2, Sibilla-AEP-3, Sibilla-DISPLAY-2, Sibilla-DISPLAY-3, Sibilla-SAE-1, Sibilla-SAE-2, Sibilla-SAE-3 | | |

| | | | |
|--|--|-----------------|---------|
|  | | | |
| 1 | | | |
| GEV No. | 529487 | Ref. No. | ARGENTA |
| description | steam pipe thread 3/8" H 180mm W 120mm tube ø 10mm ARGENTA | | |

| | | | |
|--|--|-----------------|----------|
|  | | | |
| 1 | | | |
| GEV No. | 525200 | Ref. No. | 25763009 |
| description | steam pipe thread 3/8" H 200mm tube ø 10mm SS | | |
| For models: | Gloria-AEP-1, Gloria-AEP-2, Gloria-AEP-3, Gloria-AEP-4, Gloria-DISPLAY-LCL-2, Gloria-DISPLAY-LCL-3, Gloria-SAE-1, Gloria-SAE-2, Gloria-SAE-3, Gloria-SAE-4 | | |



| | | | |
|---|---------------|-----------------|--------|
|  | | | |
| 1 | | | |
| GEV No. | 529774 | Ref. No. | 90311R |
| description | steam pipe VC | | |

| | | | |
|---|--|-----------------|----------|
|  | | | |
| 1 | | | |
| GEV No. | 529231 | Ref. No. | 56119023 |
| description | steam pipe with handle L 180mm IT 3/8" | | |
| For models: | CK-CKE-CK-1, CK-CKE-CKE-1, CKX-CKXE-CKX-1, CKX-CKXE-CKXE-1 | | |

| | | | |
|--|---|-----------------|--------------------|
|  | | | |
| 1 | | | |
| GEV No. | 527769 | Ref. No. | 25763027 561181 |
| description | steam pipe with tube handle thread 3/8" H 245mm W 110mm tube ø 8mm SS | | |

| | | | |
|---|---|-----------------|--------|
|  | | | |
| 1 | | | |
| GEV No. | 529775 | Ref. No. | 90312R |
| description | steam pipe with tube handle thread 3/8" IT H 230mm W 140mm tube ø 8mm chrome-plated | | |
| For models: | Dora | | |

| | | | |
|---|--|-----------------|-------|
|  | | | |
| 1 | | | |
| GEV No. | 529770 | Ref. No. | 56110 |
| description | steam tap with steam pipe | | |
| For models: | CK, CK-CKE, CK-CKE-CK-1, CK-CKE-CKE-1, CKE, CKP, CKPE, CKX-CKXE, CKX-CKXE-CKX-1, CKX-CKXE-CKXE-1 | | |

| | | | |
|--|--|-----------------|----------|
|  | | | |
| 1 | | | |
| GEV No. | 527254 | Ref. No. | 56119001 |
| description | steam tap with tube handle thread 3/8" IT H 205mm W 135mm tube ø 8mm chrome-plated | | |

nozzles for steam pipes

| | | | |
|---|--|-----------------|----------|
|  | | | |
| 1 | | | |
| GEV No. | 527788 | Ref. No. | 25763003 |
| description | steam nozzle ø 16mm L 28mm 5 holes SS | | |
| For models: | Divina, Divina-AEP-1, Divina-AEP-2, Divina-AEP-3, Divina-AEP-4, Divina-AEP-J, Divina-SAE-1, Divina-SAE-2, Divina-SAE-3, Divina-SAE-4, Divina-SAE-J, Sibilla-AEP-1, Sibilla-AEP-2, Sibilla-AEP-3, Sibilla-DISPLAY-2, Sibilla-DISPLAY-3, Sibilla-SAE-1, Sibilla-SAE-2, Sibilla-SAE-3 | | |

| | | | |
|---|--|-----------------|----------|
|  | | | |
| 1 | | | |
| GEV No. | 527789 | Ref. No. | 25763007 |
| description | steam nozzle ø 16mm L 72mm 4 holes SS | | |
| For models: | Divina, Divina-AEP-1, Divina-AEP-2, Divina-AEP-3, Divina-AEP-4, Divina-AEP-J, Divina-SAE-1, Divina-SAE-2, Divina-SAE-3, Divina-SAE-4, Divina-SAE-J | | |

| | | | |
|---|--|-----------------|----------|
|  | | | |
| 1 | | | |
| GEV No. | 527882 | Ref. No. | 25763004 |
| description | steam nozzle thread M10x0.75 ø 17mm L 29mm 5 holes bore ø 1.5mm SS | | |
| For models: | Gloria-AEP-1, Gloria-AEP-2, Gloria-AEP-3, Gloria-AEP-4, Gloria-DISPLAY-LCL-2, Gloria-DISPLAY-LCL-3, Gloria-SAE-1, Gloria-SAE-2, Gloria-SAE-3, Gloria-SAE-4 | | |



| | | | |
|---|---|-----------------|-------|
|  | | | |
| 1 | | | |
| GEV No. | 527209 | Ref. No. | 25762 |
| description | steam nozzle thread M10x1.25 IT L 16mm 5 holes bore ø 1.5mm chrome-plated | | |
| For models: | Argenta, Argenta-AEP-1, Argenta-AEP-2, Argenta-AEP-3, Argenta-AEP-4, Argenta-AEP-J, Argenta-SAE-1, Argenta-SAE-2, Argenta-SAE-3, Argenta-SAE-4, Argenta-SAE-J, CK, CK-CKE, CK-CKE-CK-1, CK-CKE-CKE-1, CKE, CKP, CKPE, CKX-CKXE, CKX-CKXE-CKX-1, CKX-CKXE-CKXE-1, CompattaArgenta, Dora, Rapallo-AEP-1, Rapallo-AEP-2, Rapallo-AEP-3, Rapallo-AEP-4, Rapallo-AL-1, Rapallo-AL-2, Rapallo-AL-3, Rapallo-AL-4, Vania | | |

| | | | |
|---|--|-----------------|--------|
|  | | | |
| 1 | | | |
| GEV No. | 527797 | Ref. No. | 25762A |
| description | steam nozzle thread M8x0.75 ø 14mm L 25mm 5 holes SS | | |
| For models: | Argenta-AEP-1, Argenta-AEP-2, Argenta-AEP-3, Argenta-AEP-4, Argenta-AEP-J, Argenta-SAE-1, Argenta-SAE-2, Argenta-SAE-3, Argenta-SAE-4, Argenta-SAE-J, Brava, Brava-SME-1, Brava-SME-2, Brava-SME-3, Brava-SME-4, Brava-SMSA-1, Brava-SMSA-2, Brava-SMSA-3, Brava-SMSA-4, CompattaArgenta, Denise, Giada-1, Giada-2, Giada-Fridge-Cup-warmer-1, Gloria-AEP-1, Gloria-AEP-2, Gloria-AEP-3, Gloria-AEP-4, Gloria-DISPLAY-LCL-2, Gloria-DISPLAY-LCL-3, Gloria-SAE-1, Gloria-SAE-2, Gloria-SAE-3, Gloria-SAE-4, Sara-1GR-1, Sara-2GR-2, Sara-Fridge-Cup-warmer, Vania | | |

| | | | |
|---|--|-----------------|----------|
| water pipes | | | |
|  | | | |
| 1 | | | |
| GEV No. | 529771 | Ref. No. | 56119024 |
| description | water pipe complete | | |
| For models: | CK-CKE, CK-CKE-CK-1, CK-CKE-CKE-1, CKX-CKXE, CKX-CKXE-CKX-1, CKX-CKXE-CKXE-1 | | |

| | | | |
|--|---------------------|-----------------|--------|
|  | | | |
| 1 | | | |
| GEV No. | 529776 | Ref. No. | 90321R |
| description | water pipe complete | | |
| For models: | Dora | | |

| | | | |
|---|-----------|-----------------|-------|
| accessories | | | |
| bushes | | | |
|  | | | |
| 1 | | | |
| GEV No. | 529738 | Ref. No. | 15191 |
| description | bush PTFE | | |
| For models: | Divina | | |

| | | | |
|---|---|-----------------|-------------------|
|  | | | |
| 1 | | | |
| GEV No. | 529779 | Ref. No. | 12661 |
| description | bush with O-ring | | |
| For models: | Divina, Divina-AEP-1, Divina-AEP-2, Divina-AEP-3, Divina-AEP-4, Divina-AEP-J, Divina-SAE-1, Divina-SAE-2, Divina-SAE-3, Divina-SAE-4, Divina-SAE-J, Giada-1, Giada-2, Giada-Fridge-Cup-warmer-1, Gloria-AEP-1, Gloria-AEP-2, Gloria-AEP-3, Gloria-AEP-4, Gloria-DISPLAY-LCL-2, Gloria-DISPLAY-LCL-3, Gloria-SAE-1, Gloria-SAE-2, Gloria-SAE-3, Gloria-SAE-4, Sara-1GR-1, Sara-2GR-2, Sara-Fridge-Cup-warmer | | |
| spare parts for | 529779 | | |
|  | GEV No. | 529545 | Ref. No. — |
| | O-ring EPDM thickness 1.78mm ID ø 10.82mm Qty 1 pcs | | |

| | | | |
|---|--|-----------------|----------|
| tube handles | | | |
|  | | | |
| 1 | | | |
| GEV No. | 527844 | Ref. No. | 15296001 |
| description | tube handle for pipe ø 10mm | | |
| For models: | Divina, Divina-AEP-1, Divina-AEP-2, Divina-AEP-3, Divina-AEP-4, Divina-AEP-J, Divina-SAE-1, Divina-SAE-2, Divina-SAE-3, Divina-SAE-4, Divina-SAE-J, Gloria-AEP-1, Gloria-AEP-2, Gloria-AEP-3, Gloria-AEP-4, Gloria-DISPLAY-LCL-2, Gloria-DISPLAY-LCL-3, Gloria-SAE-1, Gloria-SAE-2, Gloria-SAE-3, Gloria-SAE-4, Sibilla-AEP-1, Sibilla-AEP-2, Sibilla-AEP-3, Sibilla-DISPLAY-2, Sibilla-DISPLAY-3, Sibilla-SAE-1, Sibilla-SAE-2, Sibilla-SAE-3 | | |



| | | | |
|---|---|-----------------|----------|
|  | | | |
| 1 | | | |
| GEV No. | 527251 | Ref. No. | 15296000 |
| description | tube handle for pipe ø 8mm rubber | | |
| For models: | Argenta-AEP-1, Argenta-AEP-2, Argenta-AEP-3, Argenta-AEP-4, Argenta-AEP-J, Argenta-SAE-1, Argenta-SAE-2, Argenta-SAE-3, Argenta-SAE-4, Argenta-SAE-J, CK-CKE-CK-1, CK-CKE-CKE-1, CKX-CKXE-CKX-1, CKX-CKXE-CKXE-1, Giada-1, Giada-2, Giada-Fridge-Cup-warmer-1, Rapallo-AEP-1, Rapallo-AEP-2, Rapallo-AEP-3, Rapallo-AEP-4, Rapallo-AL-1, Rapallo-AL-2, Rapallo-AL-3, Rapallo-AL-4, Sara-1GR-1, Sara-2GR-2, Sara-Fridge-Cup-warmer | | |

| | | | |
|---|----------------------------|-----------------|-------|
|  | | | |
| 1 | | | |
| GEV No. | 526268 | Ref. No. | 15295 |
| description | tube handle L 35mm plastic | | |

| | | | |
|---|--|-----------------|---------------------------|
|  | | | |
| 1 | | | |
| GEV No. | 529627 | Ref. No. | 15295 AS1001 AS1101 |
| description | tube handle ø 8mm L 30mm plastic | | |
| For models: | Argenta, Argenta-AEP-1, Argenta-AEP-2, Argenta-AEP-3, Argenta-AEP-4, Argenta-AEP-J, Argenta-SAE-1, Argenta-SAE-2, Argenta-SAE-3, Argenta-SAE-4, Argenta-SAE-J, Brava, Brava-SME-1, Brava-SME-2, Brava-SME-3, Brava-SME-4, Brava-SMSA-1, Brava-SMSA-2, Brava-SMSA-3, Brava-SMSA-4, CK, CK-CKE, CK-CKE-CK-1, CK-CKE-CKE-1, CKE, CKP, CKPE, CKX-CKXE, CKX-CKXE-CKX-1, CKX-CKXE-CKXE-1, CMA, CompattaArgenta, Denise, Divina-AEP-1, Divina-AEP-2, Divina-AEP-3, Divina-AEP-4, Divina-AEP-J, Divina-SAE-1, Divina-SAE-2, Divina-SAE-3, Divina-SAE-4, Divina-SAE-J, Dora, Giada-1, Giada-2, Giada-Fridge-Cup-warmer-1, Gloria-AEP-1, Gloria-AEP-2, Gloria-AEP-3... (Other models you can see in the webshop) | | |

| | | | |
|--|---|-----------------|-------|
| union nuts | | | |
|  | | | |
| 1 | | | |
| GEV No. | 527258 | Ref. No. | 25391 |
| description | union nut thread 3/8" IT L 31.5mm hole ø 12.8mm chrome-plated brass | | |



| | | | |
|---|---|-----------------|-----------------|
|  | | | |
| 1 | | | |
| GEV No. | 528938 | Ref. No. | 25391 |
| description | union nut thread 3/8" IT L 31mm hole ø 13.6mm chrome-plated brass | | |
| For models: | Argenta, Argenta-AEP-1, Argenta-AEP-2, Argenta-AEP-3, Argenta-AEP-4, Argenta-AEP-J, Argenta-SAE-1, Argenta-SAE-2, Argenta-SAE-3, Argenta-SAE-4, Argenta-SAE-J, Brava-SME-1, Brava-SME-2, Brava-SME-3, Brava-SME-4, Brava-SMSA-1, Brava-SMSA-2, Brava-SMSA-3, Brava-SMSA-4, CK, CK-CKE, CK-CKE-CK-1, CK-CKE-CKE-1, CKE, CKP, CKPE, CKX-CKXE, CKX-CKXE-CKX-1, CKX-CKXE-CKXE-1, CMA, CompattaArgenta, Denise, Dora, Giada-1, Giada-2, Giada-Fridge-Cup-warmer-1, Gloria-AEP-1, Gloria-AEP-2, Gloria-AEP-3, Gloria-AEP-4, Gloria-DISPLAY-LCL-2, Gloria-DISPLAY-LCL-3, Gloria-SAE-1, Gloria-SAE-2, Gloria-SAE-3, Gloria-SAE-4, Sara-1GR-1, Sara-2GR-2, Sara-Fridge-Cup-warmer, Sibilla-AEP-1...(Other models you can see in the webshop) | | |
| accessories for | 528938 | | |
| |  | | |
| | GEV No. | 505192 | Ref. No. |
| | | | 12300000 |
| | O-ring EPDM thickness 2.62mm ID ø 39.34mm Qty 1 pcs | | |

gaskets

flat gaskets

fibre gaskets

| | | | |
|---|--|-----------------|-------|
|  | | | |
| 1 | | | |
| GEV No. | 528101 | Ref. No. | 12007 |
| description | sealing disc fibre D1 ø 11mm thickness 3mm Qty 1 pcs | | |
| For models: | Argenta-AEP-1, Argenta-AEP-2, Argenta-AEP-3, Argenta-AEP-4, Argenta-AEP-J, Argenta-SAE-1, Argenta-SAE-2, Argenta-SAE-3, Argenta-SAE-4, Argenta-SAE-J, Brava, Brava-SME-1, Brava-SME-2, Brava-SME-3, Brava-SME-4, Brava-SMSA-1, Brava-SMSA-2, Brava-SMSA-3, Brava-SMSA-4, CompattaArgenta, Divina, Divina-AEP-1, Divina-AEP-2, Divina-AEP-3, Divina-AEP-4, Divina-AEP-J, Divina-SAE-1, Divina-SAE-2, Divina-SAE-3, Divina-SAE-4, Divina-SAE-J, Dora, Giada-1, Giada-2, Gloria-AEP-1, Gloria-AEP-2, Gloria-AEP-3, Gloria-AEP-4, Gloria-DISPLAY-LCL-2, Gloria-DISPLAY-LCL-3, Gloria-SAE-1, Gloria-SAE-2, Gloria-SAE-3, Gloria-SAE-4, Rapallo-AEP-1, Rapallo-AEP-2, Rapallo-AEP-3, Rapallo-AEP-4, Rapallo-AL-1, Rapallo-AL-2...(Other models you can see in the webshop) | | |

fine filters

fine filters

| | | | |
|---|---|-----------------|-------|
|  | | | |
| 1 | | | |
| GEV No. | 528317 | Ref. No. | 10252 |
| description | fine filter fabric ø 14mm H 12.5mm | | |
| For models: | Argenta, Argenta-AEP-1, Argenta-AEP-2, Argenta-AEP-3, Argenta-AEP-4, Argenta-AEP-J, Argenta-SAE-1, Argenta-SAE-2, Argenta-SAE-3, Argenta-SAE-4, Argenta-SAE-J, Brava-SME-1, Brava-SME-2, Brava-SME-3, Brava-SME-4, Brava-SMSA-1, Brava-SMSA-2, Brava-SMSA-3, Brava-SMSA-4, CK, CK-CKE, CK-CKE-CK-1, CK-CKE-CKE-1, CKE, CKP, CKPE, CKX-CKXE, CKX-CKXE-CKX-1, CKX-CKXE-CKXE-1, CMA, CompattaArgenta, Denise, Giada-1, Giada-2, Sara-1GR-1, Sara-2GR-2 | | |

| | | | |
|---|---|-----------------|----------|
|  | | | |
| 1 | | | |
| GEV No. | 529911 | Ref. No. | 10251002 |
| description | fine filter flat ø 11mm H 0.25mm | | |
| For models: | Giada-1, Giada-2, Giada-Fridge-Cup-warmer-1, Gloria-AEP-1, Gloria-AEP-2, Gloria-AEP-3, Gloria-AEP-4, Gloria-DISPLAY-LCL-2, Gloria-DISPLAY-LCL-3, Gloria-SAE-1, Gloria-SAE-2, Gloria-SAE-3, Gloria-SAE-4, Sara-1GR-1, Sara-2GR-2, Sara-Fridge-Cup-warmer | | |

| | | | |
|---|--|-----------------|----------|
|  | | | |
| 1 | | | |
| GEV No. | 528832 | Ref. No. | 10251001 |
| description | fine filter flat ø 8mm | | |
| For models: | Argenta-AEP-1, Argenta-AEP-2, Argenta-AEP-3, Argenta-AEP-4, Argenta-AEP-J, Argenta-SAE-1, Argenta-SAE-2, Argenta-SAE-3, Argenta-SAE-4, Argenta-SAE-J, Brava, Brava-SME-1, Brava-SME-2, Brava-SME-3, Brava-SME-4, Brava-SMSA-1, Brava-SMSA-2, Brava-SMSA-3, Brava-SMSA-4, CK-CKE, CK-CKE-CK-1, CK-CKE-CKE-1, CKX-CKXE, CKX-CKXE-CKX-1, CKX-CKXE-CKXE-1, CompattaArgenta, Divina, Divina-AEP-1, Divina-AEP-2, Divina-AEP-3, Divina-AEP-4, Divina-AEP-J, Divina-SAE-1, Divina-SAE-2, Divina-SAE-3, Divina-SAE-4, Divina-SAE-J, Dora, DPiu-1, Giada-1, Giada-2, Gloria-AEP-1, Gloria-AEP-2, Gloria-AEP-3, Gloria-AEP-4, Gloria-DISPLAY-LCL-2, Gloria-DISPLAY-LCL-3, Gloria-SAE-1, Gloria-SAE-2, Gloria-SAE-3...(Other models you can see in the webshop) | | |

| | | | |
|---|---|-----------------|-------|
|  | | | |
| 1 | | | |
| GEV No. | 527173 | Ref. No. | 10254 |
| description | fine filter ø 11.1mm H 7.4mm for expansion valve | | |
| For models: | Argenta-AEP-1, Argenta-AEP-2, Argenta-AEP-3, Argenta-AEP-4, Argenta-AEP-J, Argenta-SAE-1, Argenta-SAE-2, Argenta-SAE-3, Argenta-SAE-4, Argenta-SAE-J, Brava, Brava-SME-1, Brava-SME-2, Brava-SME-3, Brava-SME-4, Brava-SMSA-1, Brava-SMSA-2, Brava-SMSA-3, Brava-SMSA-4, CK-CKE, CK-CKE-CK-1, CK-CKE-CKE-1, CKX-CKXE, CKX-CKXE-CKX-1, CKX-CKXE-CKXE-1, CMA, CompattaArgenta, Denise, Divina, Divina-AEP-1, Divina-AEP-2, Divina-AEP-3, Divina-AEP-4, Divina-AEP-J, Divina-SAE-1, Divina-SAE-2, Divina-SAE-3, Divina-SAE-4, Divina-SAE-J, Dora, DPiu-1, Giada-1, Giada-2, Gloria-AEP-1, Gloria-AEP-2, Gloria-AEP-3, Gloria-AEP-4, Gloria-DISPLAY-LCL-2, Gloria-DISPLAY-LCL-3, Gloria-SAE-1...(Other models you can see in the webshop) | | |

| | | | |
|---|-------------------------------|-----------------|-------|
|  | | | |
| 1 | | | |
| GEV No. | 526267 | Ref. No. | 10252 |
| description | fine filter ø 12.5mm H 10.5mm | | |

| | | | |
|---|--|-----------------|-------|
|  | | | |
| 1 | | | |
| GEV No. | 528357 | Ref. No. | 10253 |
| description | fine filter ø 8.5mm H 22mm | | |
| For models: | Divina-AEP-1, Divina-AEP-2, Divina-AEP-3, Divina-AEP-4, Divina-AEP-J, Divina-SAE-1, Divina-SAE-2, Divina-SAE-3, Divina-SAE-4, Divina-SAE-J, Gloria-AEP-1, Gloria-AEP-2, Gloria-AEP-3, Gloria-AEP-4, Gloria-DISPLAY-LCL-2, Gloria-DISPLAY-LCL-3, Gloria-SAE-1, Gloria-SAE-2, Gloria-SAE-3, Gloria-SAE-4, Rapallo-AEP-1, Rapallo-AEP-2, Rapallo-AEP-3, Rapallo-AEP-4, Sibilla-AEP-1, Sibilla-AEP-2, Sibilla-AEP-3, Sibilla-DISPLAY-2, Sibilla-DISPLAY-3, Sibilla-SAE-1, Sibilla-SAE-2, Sibilla-SAE-3 | | |

intake valves

intake valves



1

| | | | |
|--------------------|---|-----------------|-------------------------|
| GEV No. | 529632 | Ref. No. | 61003 61004 61006 |
| description | intake valve | | |
| For models: | Argenta, Argenta-AEP-1, Argenta-AEP-2, Argenta-AEP-3, Argenta-AEP-4, Argenta-AEP-J, Argenta-SAE-1, Argenta-SAE-2, Argenta-SAE-3, Argenta-SAE-4, Argenta-SAE-J, Brava, Brava-SME-1, Brava-SME-2, Brava-SME-3, Brava-SME-4, Brava-SMSA-1, Brava-SMSA-2, Brava-SMSA-3, Brava-SMSA-4, CompattaArgenta, Denise, Divina, Divina-AEP-1, Divina-AEP-2, Divina-AEP-3, Divina-AEP-4, Divina-AEP-J, Divina-SAE-1, Divina-SAE-2, Divina-SAE-3, Divina-SAE-4, Divina-SAE-J, Gloria-AEP-1, Gloria-AEP-2, Gloria-AEP-3, Gloria-AEP-4, Gloria-DISPLAY-LCL-2, Gloria-DISPLAY-LCL-3, Gloria-SAE-1, Gloria-SAE-2, Gloria-SAE-3, Gloria-SAE-4, Rapallo-AEP-1, Rapallo-AEP-2, Rapallo-AEP-3, Rapallo-AEP-4, Rapallo-AL-1, Rapallo-AL-2, Rapallo-AL-3, Rapallo-AL-4 | | |



1

| | | | |
|--------------------|---|-----------------|-------|
| GEV No. | 527849 | Ref. No. | 53004 |
| description | intake valve L 100mm angled 90° | | |
| For models: | Argenta, Argenta-AEP-1, Argenta-AEP-2, Argenta-AEP-3, Argenta-AEP-4, Argenta-AEP-J, Argenta-SAE-1, Argenta-SAE-2, Argenta-SAE-3, Argenta-SAE-4, Argenta-SAE-J, Brava, Brava-SME-1, Brava-SME-2, Brava-SME-3, Brava-SME-4, Brava-SMSA-1, Brava-SMSA-2, Brava-SMSA-3, Brava-SMSA-4, CompattaArgenta, Denise, Divina, Divina-AEP-1, Divina-AEP-2, Divina-AEP-3, Divina-AEP-4, Divina-AEP-J, Divina-SAE-1, Divina-SAE-2, Divina-SAE-3, Divina-SAE-4, Divina-SAE-J, Dora, Gloria-AEP-1, Gloria-AEP-2, Gloria-AEP-3, Gloria-AEP-4, Gloria-DISPLAY-LCL-2, Gloria-DISPLAY-LCL-3, Gloria-SAE-1, Gloria-SAE-2, Gloria-SAE-3, Gloria-SAE-4, Rapallo-AEP-1, Rapallo-AEP-2, Rapallo-AEP-3, Rapallo-AEP-4, Rapallo-AL-1, Rapallo-AL-2...(Other models you can see in the webshop) | | |

accessories

bolts



1

| | | | |
|--------------------|---|-----------------|-------|
| GEV No. | 527171 | Ref. No. | 25315 |
| description | pressure bolt ø 8mm L 35.7mm stainless steel for filling valve | | |
| For models: | Argenta, Argenta-AEP-1, Argenta-AEP-2, Argenta-AEP-3, Argenta-AEP-4, Argenta-AEP-J, Argenta-SAE-1, Argenta-SAE-2, Argenta-SAE-3, Argenta-SAE-4, Argenta-SAE-J, Brava, Brava-SME-1, Brava-SME-2, Brava-SME-3, Brava-SME-4, Brava-SMSA-1, Brava-SMSA-2, Brava-SMSA-3, Brava-SMSA-4, CompattaArgenta, Denise, Divina, Divina-AEP-1, Divina-AEP-2, Divina-AEP-3, Divina-AEP-4, Divina-AEP-J, Divina-SAE-1, Divina-SAE-2, Divina-SAE-3, Divina-SAE-4, Divina-SAE-J, Dora, Gloria-AEP-1, Gloria-AEP-2, Gloria-AEP-3, Gloria-AEP-4, Gloria-DISPLAY-LCL-2, Gloria-DISPLAY-LCL-3, Gloria-SAE-1, Gloria-SAE-2, Gloria-SAE-3, Gloria-SAE-4, Rapallo-AEP-1, Rapallo-AEP-2, Rapallo-AEP-3, Rapallo-AEP-4, Rapallo-AL-1, Rapallo-AL-2...(Other models you can see in the webshop) | | |

EQUIPMENT-SPECIFIC UNITS ASTORIA-CMA

gaskets



1

| | | | |
|--------------------|---|-----------------|-------|
| GEV No. | 528309 | Ref. No. | 12205 |
| description | shaft sealing ED ø 13mm ID ø 7.5mm U-shape | | |
| For models: | Argenta, Argenta-AEP-1, Argenta-AEP-2, Argenta-AEP-3, Argenta-AEP-4, Argenta-AEP-J, Argenta-SAE-1, Argenta-SAE-2, Argenta-SAE-3, Argenta-SAE-4, Argenta-SAE-J, Brava, Brava-SME-1, Brava-SME-2, Brava-SME-3, Brava-SME-4, Brava-SMSA-1, Brava-SMSA-2, Brava-SMSA-3, Brava-SMSA-4, CompattaArgenta, Denise, Divina, Divina-AEP-1, Divina-AEP-2, Divina-AEP-3, Divina-AEP-4, Divina-AEP-J, Divina-SAE-1, Divina-SAE-2, Divina-SAE-3, Divina-SAE-4, Divina-SAE-J, Dora, Gloria-AEP-1, Gloria-AEP-2, Gloria-AEP-3, Gloria-AEP-4, Gloria-DISPLAY-LCL-2, Gloria-DISPLAY-LCL-3, Gloria-SAE-1, Gloria-SAE-2, Gloria-SAE-3, Gloria-SAE-4, Rapallo-AEP-1, Rapallo-AEP-2, Rapallo-AEP-3, Rapallo-AEP-4, Rapallo-AL-1, Rapallo-AL-2...(Other models you can see in the webshop) | | |

levers



1

| | | | |
|--------------------|---|-----------------|-------|
| GEV No. | 529223 | Ref. No. | 25202 |
| description | lever for intake tap thread M8 ø 8mm L 80mm chrome-plated steel | | |
| For models: | Argenta, Argenta-AEP-1, Argenta-AEP-2, Argenta-AEP-3, Argenta-AEP-4, Argenta-AEP-J, Argenta-SAE-1, Argenta-SAE-2, Argenta-SAE-3, Argenta-SAE-4, Argenta-SAE-J, Brava, Brava-SME-1, Brava-SME-2, Brava-SME-3, Brava-SME-4, Brava-SMSA-1, Brava-SMSA-2, Brava-SMSA-3, Brava-SMSA-4, CompattaArgenta, Denise, Divina, Divina-AEP-1, Divina-AEP-2, Divina-AEP-3, Divina-AEP-4, Divina-AEP-J, Divina-SAE-1, Divina-SAE-2, Divina-SAE-3, Divina-SAE-4, Divina-SAE-J, Dora, Gloria-AEP-1, Gloria-AEP-2, Gloria-AEP-3, Gloria-AEP-4, Gloria-DISPLAY-LCL-2, Gloria-DISPLAY-LCL-3, Gloria-SAE-1, Gloria-SAE-2, Gloria-SAE-3, Gloria-SAE-4, Rapallo-AEP-1, Rapallo-AEP-2, Rapallo-AEP-3, Rapallo-AEP-4, Rapallo-AL-1, Rapallo-AL-2...(Other models you can see in the webshop) | | |

miscellaneous



1

| | | | |
|--------------------|---|-----------------|-------|
| GEV No. | 528310 | Ref. No. | 25615 |
| description | piston | | |
| For models: | Argenta, Argenta-AEP-1, Argenta-AEP-2, Argenta-AEP-3, Argenta-AEP-4, Argenta-AEP-J, Argenta-SAE-1, Argenta-SAE-2, Argenta-SAE-3, Argenta-SAE-4, Argenta-SAE-J, Brava, Brava-SME-1, Brava-SME-2, Brava-SME-3, Brava-SME-4, Brava-SMSA-1, Brava-SMSA-2, Brava-SMSA-3, Brava-SMSA-4, CompattaArgenta, Denise, Divina, Divina-AEP-1, Divina-AEP-2, Divina-AEP-3, Divina-AEP-4, Divina-AEP-J, Divina-SAE-1, Divina-SAE-2, Divina-SAE-3, Divina-SAE-4, Divina-SAE-J, Dora, Gloria-AEP-1, Gloria-AEP-2, Gloria-AEP-3, Gloria-AEP-4, Gloria-DISPLAY-LCL-2, Gloria-DISPLAY-LCL-3, Gloria-SAE-1, Gloria-SAE-2, Gloria-SAE-3, Gloria-SAE-4, Rapallo-AEP-1, Rapallo-AEP-2, Rapallo-AEP-3, Rapallo-AEP-4, Rapallo-AL-1, Rapallo-AL-2...(Other models you can see in the webshop) | | |



screw connections



1

| | | | |
|--------------------|---|-----------------|-------|
| GEV No. | 527186 | Ref. No. | 23202 |
| description | angle piece thread 1/4" ET conical - 3/8" ET for filling valve ID ø 7mm | | |
| For models: | Argenta-AEP-1, Argenta-AEP-2, Argenta-AEP-3, Argenta-AEP-4, Argenta-AEP-J, Argenta-SAE-1, Argenta-SAE-2, Argenta-SAE-3, Argenta-SAE-4, Argenta-SAE-J, Brava, Brava-SME-1, Brava-SME-2, Brava-SME-3, Brava-SME-4, Brava-SMSA-1, Brava-SMSA-2, Brava-SMSA-3, Brava-SMSA-4, CMA, CompattaArgenta, Divina, Divina-AEP-1, Divina-AEP-2, Divina-AEP-3, Divina-AEP-4, Divina-AEP-J, Divina-SAE-1, Divina-SAE-2, Divina-SAE-3, Divina-SAE-4, Divina-SAE-J, Dora, Giada-1, Giada-2, Gloria-AEP-1, Gloria-AEP-2, Gloria-AEP-3, Gloria-AEP-4, Gloria-DISPLAY-LCL-2, Gloria-DISPLAY-LCL-3, Gloria-SAE-1, Gloria-SAE-2, Gloria-SAE-3, Gloria-SAE-4, Rapallo-AEP-1, Rapallo-AEP-2, Rapallo-AEP-3, Rapallo-AEP-4, Rapallo-AL-1...(Other models you can see in the webshop) | | |



2

| | | | |
|--------------------|--|-----------------|----------|
| GEV No. | 527814 | Ref. No. | 25736001 |
| description | angle piece thread 3/8" for steam pipe WS 20 brass | | |



1

| | | | |
|--------------------|---|-----------------|-------|
| GEV No. | 527187 | Ref. No. | 25680 |
| description | screw connection thread 3/8" ET - M18x1.5 ET for filling valve brass | | |
| For models: | Argenta, Argenta-AEP-1, Argenta-AEP-2, Argenta-AEP-3, Argenta-AEP-4, Argenta-AEP-J, Argenta-SAE-1, Argenta-SAE-2, Argenta-SAE-3, Argenta-SAE-4, Argenta-SAE-J, Brava, Brava-SME-1, Brava-SME-2, Brava-SME-3, Brava-SME-4, Brava-SMSA-1, Brava-SMSA-2, Brava-SMSA-3, Brava-SMSA-4, CompattaArgenta, Denise, Divina, Divina-AEP-1, Divina-AEP-2, Divina-AEP-3, Divina-AEP-4, Divina-AEP-J, Divina-SAE-1, Divina-SAE-2, Divina-SAE-3, Divina-SAE-4, Divina-SAE-J, Dora, Gloria-AEP-1, Gloria-AEP-2, Gloria-AEP-3, Gloria-AEP-4, Gloria-DISPLAY-LCL-2, Gloria-DISPLAY-LCL-3, Gloria-SAE-1, Gloria-SAE-2, Gloria-SAE-3, Gloria-SAE-4, Rapallo-AEP-1, Rapallo-AEP-2, Rapallo-AEP-3, Rapallo-AEP-4, Rapallo-AL-1, Rapallo-AL-2...(Other models you can see in the webshop) | | |



1

| | | | |
|--------------------|--|-----------------|----------|
| GEV No. | 527204 | Ref. No. | 43030001 |
| description | T-piece thread 3/8" ET - 3/8" IT - 1/4" IT L 31mm for filling valve WS 23 W 40mm brass | | |
| For models: | Argenta-AEP-1, Argenta-AEP-2, Argenta-AEP-3, Argenta-AEP-4, Argenta-AEP-J, Argenta-SAE-1, Argenta-SAE-2, Argenta-SAE-3, Argenta-SAE-4, Argenta-SAE-J, Brava, Brava-SME-1, Brava-SME-2, Brava-SME-3, Brava-SME-4, Brava-SMSA-1, Brava-SMSA-2, Brava-SMSA-3, Brava-SMSA-4, CompattaArgenta, Divina, Divina-AEP-1, Divina-AEP-2, Divina-AEP-3, Divina-AEP-4, Divina-AEP-J, Divina-SAE-1, Divina-SAE-2, Divina-SAE-3, Divina-SAE-4, Divina-SAE-J, Dora, Gloria-AEP-1, Gloria-AEP-2, Gloria-AEP-3, Gloria-AEP-4, Gloria-DISPLAY-LCL-2, Gloria-DISPLAY-LCL-3, Gloria-SAE-1, Gloria-SAE-2, Gloria-SAE-3, Gloria-SAE-4, Rapallo-AEP-1, Rapallo-AEP-2, Rapallo-AEP-3, Rapallo-AEP-4, Rapallo-AL-1, Rapallo-AL-2, Rapallo-AL-3, Rapallo-AL-4...(Other models you can see in the webshop) | | |



1

| | | | |
|--------------------|--|-----------------|-------|
| GEV No. | 527189 | Ref. No. | 43020 |
| description | T-piece thread 3/8" for pump brass | | |
| For models: | Argenta, Argenta-AEP-1, Argenta-AEP-2, Argenta-AEP-3, Argenta-AEP-4, Argenta-AEP-J, Argenta-SAE-1, Argenta-SAE-2, Argenta-SAE-3, Argenta-SAE-4, Argenta-SAE-J, Brava-SME-1, Brava-SME-2, Brava-SME-3, Brava-SME-4, Brava-SMSA-1, Brava-SMSA-2, Brava-SMSA-3, Brava-SMSA-4, CK, CK-CKE, CK-CKE-CK-1, CK-CKE-CKE-1, CKE, CKP, CKPE, CKX-CKXE, CKX-CKXE-CKX-1, CKX-CKXE-CKXE-1, CompattaArgenta, Denise, Divina, Divina-AEP-1, Divina-AEP-2, Divina-AEP-3, Divina-AEP-4, Divina-AEP-J, Divina-SAE-1, Divina-SAE-2, Divina-SAE-3, Divina-SAE-4, Divina-SAE-J, Gloria-AEP-1, Gloria-AEP-2, Gloria-AEP-3, Gloria-AEP-4, Gloria-DISPLAY-LCL-2, Gloria-DISPLAY-LCL-3, Gloria-SAE-1, Gloria-SAE-2...(Other models you can see in the webshop) | | |

level glasses

level glasses

gaskets



1

| | | | |
|--------------------|---|-----------------|-------|
| GEV No. | 529408 | Ref. No. | 12200 |
| description | gasket D1 ø 16mm D2 ø 10mm H 8mm water level glass | | |
| For models: | Argenta, Argenta-AEP-1, Argenta-AEP-2, Argenta-AEP-3, Argenta-AEP-4, Argenta-AEP-J, Argenta-SAE-1, Argenta-SAE-2, Argenta-SAE-3, Argenta-SAE-4, Argenta-SAE-J, Brava, Brava-SME-1, Brava-SME-2, Brava-SME-3, Brava-SME-4, Brava-SMSA-1, Brava-SMSA-2, Brava-SMSA-3, Brava-SMSA-4, CompattaArgenta, Denise, Divina, Divina-AEP-1, Divina-AEP-2, Divina-AEP-3, Divina-AEP-4, Divina-AEP-J, Divina-SAE-1, Divina-SAE-2, Divina-SAE-3, Divina-SAE-4, Divina-SAE-J, Dora, Gloria-AEP-1, Gloria-AEP-2, Gloria-AEP-3, Gloria-AEP-4, Gloria-DISPLAY-LCL-2, Gloria-DISPLAY-LCL-3, Gloria-SAE-1, Gloria-SAE-2, Gloria-SAE-3, Gloria-SAE-4, Rapallo-AEP-1, Rapallo-AEP-2, Rapallo-AEP-3, Rapallo-AEP-4, Rapallo-AL-1, Rapallo-AL-2...(Other models you can see in the webshop) | | |

balls



1

| | | | |
|--------------------|---|-----------------|-------|
| GEV No. | 529355 | Ref. No. | 15300 |
| description | ball ø 6mm plastic for level glass | | |
| For models: | Argenta, Argenta-AEP-1, Argenta-AEP-2, Argenta-AEP-3, Argenta-AEP-4, Argenta-AEP-J, Argenta-SAE-1, Argenta-SAE-2, Argenta-SAE-3, Argenta-SAE-4, Argenta-SAE-J, Brava, Brava-SME-1, Brava-SME-2, Brava-SME-3, Brava-SME-4, Brava-SMSA-1, Brava-SMSA-2, Brava-SMSA-3, Brava-SMSA-4, CompattaArgenta, Denise, Divina, Divina-AEP-1, Divina-AEP-2, Divina-AEP-3, Divina-AEP-4, Divina-AEP-J, Divina-SAE-1, Divina-SAE-2, Divina-SAE-3, Divina-SAE-4, Divina-SAE-J, Dora, Gloria-AEP-1, Gloria-AEP-2, Gloria-AEP-3, Gloria-AEP-4, Gloria-DISPLAY-LCL-2, Gloria-DISPLAY-LCL-3, Gloria-SAE-1, Gloria-SAE-2, Gloria-SAE-3, Gloria-SAE-4, Rapallo-AEP-1, Rapallo-AEP-2, Rapallo-AEP-3, Rapallo-AEP-4, Rapallo-AL-1, Rapallo-AL-2...(Other models you can see in the webshop) | | |

level glass holders



1

| | | | |
|--------------------|--|-----------------|-------|
| GEV No. | 527848 | Ref. No. | 53001 |
| description | bracket for level glass T1: 3/8" T2: 1/2" mounting pos. lower | | |
| For models: | Argenta, Argenta-AEP-1, Argenta-AEP-2, Argenta-AEP-3, Argenta-AEP-4, Argenta-AEP-J, Argenta-SAE-1, Argenta-SAE-2, Argenta-SAE-3, Argenta-SAE-4, Argenta-SAE-J, Brava, Brava-SME-1, Brava-SME-2, Brava-SME-3, Brava-SME-4, Brava-SMSA-1, Brava-SMSA-2, Brava-SMSA-3, Brava-SMSA-4, CompattaArgenta, Denise, Divina, Divina-AEP-1, Divina-AEP-2, Divina-AEP-3, Divina-AEP-4, Divina-AEP-J, Divina-SAE-1, Divina-SAE-2, Divina-SAE-3, Divina-SAE-4, Divina-SAE-J, Dora, Gloria-AEP-1, Gloria-AEP-2, Gloria-AEP-3, Gloria-AEP-4, Gloria-DISPLAY-LCL-2, Gloria-DISPLAY-LCL-3, Gloria-SAE-1, Gloria-SAE-2, Gloria-SAE-3, Gloria-SAE-4, Vania | | |



1

| | | | |
|--------------------|--|-----------------|-------|
| GEV No. | 529221 | Ref. No. | 53002 |
| description | bracket for level glass T1: 3/8" T2: M20x1.5 mounting pos. upper | | |
| For models: | Argenta, Argenta-AEP-1, Argenta-AEP-2, Argenta-AEP-3, Argenta-AEP-4, Argenta-AEP-J, Argenta-SAE-1, Argenta-SAE-2, Argenta-SAE-3, Argenta-SAE-4, Argenta-SAE-J, Brava, Brava-SME-1, Brava-SME-2, Brava-SME-3, Brava-SME-4, Brava-SMSA-1, Brava-SMSA-2, Brava-SMSA-3, Brava-SMSA-4, CompattaArgenta, Denise, Divina, Divina-AEP-1, Divina-AEP-2, Divina-AEP-3, Divina-AEP-4, Divina-AEP-J, Divina-SAE-1, Divina-SAE-2, Divina-SAE-3, Divina-SAE-4, Divina-SAE-J, Dora, Gloria-AEP-1, Gloria-AEP-2, Gloria-AEP-3, Gloria-AEP-4, Gloria-DISPLAY-LCL-2, Gloria-DISPLAY-LCL-3, Gloria-SAE-1, Gloria-SAE-2, Gloria-SAE-3, Gloria-SAE-4, Vania | | |

level glass pipes



1

| | | | |
|--------------------|--|-----------------|-------|
| GEV No. | 531177 | Ref. No. | 21300 |
| description | water level tube ø 11mm H 170mm ID ø 8mm | | |
| For models: | Argenta, Argenta-AEP-1, Argenta-AEP-2, Argenta-AEP-3, Argenta-AEP-4, Argenta-AEP-J, Argenta-SAE-1, Argenta-SAE-2, Argenta-SAE-3, Argenta-SAE-4, Argenta-SAE-J, Brava, Brava-SME-1, Brava-SME-2, Brava-SME-3, Brava-SME-4, Brava-SMSA-1, Brava-SMSA-2, Brava-SMSA-3, Brava-SMSA-4, CompattaArgenta, Denise, Divina, Divina-AEP-1, Divina-AEP-2, Divina-AEP-3, Divina-AEP-4, Divina-AEP-J, Divina-SAE-1, Divina-SAE-2, Divina-SAE-3, Divina-SAE-4, Divina-SAE-J, Dora, Gloria-AEP-1, Gloria-AEP-2, Gloria-AEP-3, Gloria-AEP-4, Gloria-DISPLAY-LCL-2, Gloria-DISPLAY-LCL-3, Gloria-SAE-1, Gloria-SAE-2, Gloria-SAE-3, Gloria-SAE-4, Vania | | |

EQUIPMENT-SPECIFIC UNITS ASTORIA-CMA

protective plates



1

| | | | |
|--------------------|---|-----------------|-------|
| GEV No. | 527850 | Ref. No. | 44002 |
| description | protective plate for level glass H 131mm W 65mm | | |
| For models: | Argenta, Argenta-AEP-1, Argenta-AEP-2, Argenta-AEP-3, Argenta-AEP-4, Argenta-AEP-J, Argenta-SAE-1, Argenta-SAE-2, Argenta-SAE-3, Argenta-SAE-4, Argenta-SAE-J, Brava, Brava-SME-1, Brava-SME-2, Brava-SME-3, Brava-SME-4, Brava-SMSA-1, Brava-SMSA-2, Brava-SMSA-3, Brava-SMSA-4, CompattaArgenta, Denise, Divina, Divina-AEP-1, Divina-AEP-2, Divina-AEP-3, Divina-AEP-4, Divina-AEP-J, Divina-SAE-1, Divina-SAE-2, Divina-SAE-3, Divina-SAE-4, Divina-SAE-J, Dora, Gloria-AEP-1, Gloria-AEP-2, Gloria-AEP-3, Gloria-AEP-4, Gloria-DISPLAY-LCL-2, Gloria-DISPLAY-LCL-3, Gloria-SAE-1, Gloria-SAE-2, Gloria-SAE-3, Gloria-SAE-4, Rapallo-AEP-1, Rapallo-AEP-2, Rapallo-AEP-3, Rapallo-AEP-4, Rapallo-AL-1, Rapallo-AL-2...(Other models you can see in the webshop) | | |

screw connections



1

| | | | |
|--------------------|---|-----------------|-------|
| GEV No. | 527191 | Ref. No. | 25383 |
| description | union nut thread M20x1.5 hole ø 12.6mm H 16.6mm WS 24 brass | | |
| For models: | Argenta, Argenta-AEP-1, Argenta-AEP-2, Argenta-AEP-3, Argenta-AEP-4, Argenta-AEP-J, Argenta-SAE-1, Argenta-SAE-2, Argenta-SAE-3, Argenta-SAE-4, Argenta-SAE-J, Brava, Brava-SME-1, Brava-SME-2, Brava-SME-3, Brava-SME-4, Brava-SMSA-1, Brava-SMSA-2, Brava-SMSA-3, Brava-SMSA-4, CompattaArgenta, Denise, Divina, Divina-AEP-1, Divina-AEP-2, Divina-AEP-3, Divina-AEP-4, Divina-AEP-J, Divina-SAE-1, Divina-SAE-2, Divina-SAE-3, Divina-SAE-4, Divina-SAE-J, Dora, Gloria-AEP-1, Gloria-AEP-2, Gloria-AEP-3, Gloria-AEP-4, Gloria-DISPLAY-LCL-2, Gloria-DISPLAY-LCL-3, Gloria-SAE-1, Gloria-SAE-2, Gloria-SAE-3, Gloria-SAE-4, Rapallo-AEP-1, Rapallo-AEP-2, Rapallo-AEP-3, Rapallo-AEP-4, Rapallo-AL-1, Rapallo-AL-2...(Other models you can see in the webshop) | | |

pipes

pipes



1

| | | | |
|--------------------|--|-----------------|----------|
| GEV No. | 525886 | Ref. No. | 52002050 |
| description | pipe ø 6mm T1: 1/8" T2: 1/8" | | |
| For models: | CK-CKE, CK-CKE-CK-1, CK-CKE-CKE-1, CKX-CKXE, CKX-CKXE-CKX-1, CKX-CKXE-CKXE-1 | | |



non-return valves

complete

| | | | |
|--------------------|------------------------------------|-----------------|-------|
| | | | |
| 1 | | | |
| GEV No. | 529301 | Ref. No. | 56151 |
| description | non-return valve complete T1: 3/8" | | |
| For models: | Argenta, Denise | | |

| | | | |
|--------------------|--|-----------------|-------|
| | | | |
| 1 | | | |
| GEV No. | 529335 | Ref. No. | 20358 |
| description | non-return valve inlet 1/8" outlet 1/8" L 30mm | | |
| For models: | Argenta, Brava, CK, CK-CKE, CK-CKE-CK-1, CK-CKE-CKE-1, CKE, CKP, CKPE, CKX-CKXE, CKX-CKXE-CKX-1, CKX-CKXE-CKXE-1, Denise | | |

screw connections

double nipples

| | | | |
|--------------------|--|-----------------|-------|
| | | | |
| 1 | | | |
| GEV No. | 527826 | Ref. No. | 25686 |
| description | double nipple T1: 1/4" T2: 1/4" int. ø 1 6.2mm L 24mm brass for flange | | |
| For models: | Argenta, Argenta-AEP-1, Argenta-AEP-2, Argenta-AEP-3, Argenta-AEP-4, Argenta-AEP-J, Argenta-SAE-1, Argenta-SAE-2, Argenta-SAE-3, Argenta-SAE-4, Argenta-SAE-J, Brava, Brava-SME-1, Brava-SME-2, Brava-SME-3, Brava-SME-4, Brava-SMSA-1, Brava-SMSA-2, Brava-SMSA-3, Brava-SMSA-4, CK, CK-CKE, CK-CKE-CK-1, CK-CKE-CKE-1, CKE, CKP, CKPE, CKX-CKXE-CKX-1, CKX-CKXE-CKXE-1, CMA, CompattaArgenta, Denise, Divina, Divina-AEP-1, Divina-AEP-2, Divina-AEP-3, Divina-AEP-4, Divina-AEP-J, Divina-SAE-1, Divina-SAE-2, Divina-SAE-3, Divina-SAE-4, Divina-SAE-J, Dora, Giada-1, Giada-2, Giada-Fridge-Cup-warmer-1, Gloria-AEP-1, Gloria-AEP-2, Gloria-AEP-3... (Other models you can see in the webshop) | | |

| | | | |
|--------------------|---|-----------------|----------------------|
| | | | |
| 1 | | | |
| GEV No. | 527865 | Ref. No. | 25716001 25716001 |
| description | double nipple T1: 1/4" T2: 3/8" int. ø 1 7mm int. ø 2 10.2mm L 29mm brass | | |
| For models: | CK-CKE, CK-CKE-CK-1, CK-CKE-CKE-1, CKX-CKXE, CKX-CKXE-CKX-1, CKX-CKXE-CKXE-1, CompattaArgenta | | |

| | | | |
|--------------------|--|-----------------|----------|
| | | | |
| 1 | | | |
| GEV No. | 527861 | Ref. No. | 25716002 |
| description | double nipple T1: 1/4" T2: 3/8" int. ø 1 7mm int. ø 2 8.2mm L 29mm brass | | |
| For models: | Dora, Vania | | |

| | | | |
|--------------------|---|-----------------|----------|
| | | | |
| 1 | | | |
| GEV No. | 527866 | Ref. No. | 25716003 |
| description | double nipple T1: 1/4" T2: 3/8" IT M8 int. ø 1 8.2mm L 29mm brass | | |

| | | | |
|--------------------|--|-----------------|-------|
| | | | |
| 1 | | | |
| GEV No. | 527827 | Ref. No. | 25687 |
| description | double nipple T1: 3/8" T2: 3/8" int. ø 1 8.2mm int. ø 2 10.2mm L 29mm brass for pump | | |
| For models: | Argenta, Argenta-AEP-1, Argenta-AEP-2, Argenta-AEP-3, Argenta-AEP-4, Argenta-AEP-J, Argenta-SAE-1, Argenta-SAE-2, Argenta-SAE-3, Argenta-SAE-4, Argenta-SAE-J, Brava, Brava-SME-1, Brava-SME-2, Brava-SME-3, Brava-SME-4, Brava-SMSA-1, Brava-SMSA-2, Brava-SMSA-3, Brava-SMSA-4, CK-CKE, CK-CKE-CK-1, CK-CKE-CKE-1, CKP, CKPE, CKX-CKXE, CKX-CKXE-CKX-1, CKX-CKXE-CKXE-1, CompattaArgenta, Denise, Divina, Divina-AEP-1, Divina-AEP-2, Divina-AEP-3, Divina-AEP-4, Divina-AEP-J, Divina-SAE-1, Divina-SAE-2, Divina-SAE-3, Divina-SAE-4, Divina-SAE-J, Dora, Giada-1, Giada-2, Gloria-AEP-1, Gloria-AEP-2, Gloria-AEP-3, Gloria-AEP-4, Gloria-DISPLAY-LCL-2, Gloria-DISPLAY-LCL-3...(Other models you can see in the webshop) | | |

| | | | |
|--------------------|--|-----------------|----------|
| | | | |
| 1 | | | |
| GEV No. | 527856 | Ref. No. | 25687002 |
| description | double nipple T1: 3/8" T2: 3/8" int. ø 1 8.3mm int. ø 2 10.3mm L 30mm brass Qty 1 pcs | | |
| For models: | Divina-AEP-1, Divina-AEP-2, Divina-AEP-3, Divina-AEP-4, Divina-AEP-J, Divina-SAE-1, Divina-SAE-2, Divina-SAE-3, Divina-SAE-4, Divina-SAE-J, Gloria-AEP-1, Gloria-AEP-2, Gloria-AEP-3, Gloria-AEP-4, Gloria-DISPLAY-LCL-2, Gloria-DISPLAY-LCL-3, Gloria-SAE-1, Gloria-SAE-2, Gloria-SAE-3, Gloria-SAE-4 | | |

end caps

| | | | |
|--------------------|---|-----------------|----------|
| | | | |
| 1 | | | |
| GEV No. | 527858 | Ref. No. | 25789302 |
| description | end cap thread M14x1 L 18mm WS 8 brass | | |
| For models: | Brava, Sibilla-AEP-1, Sibilla-AEP-2, Sibilla-AEP-3, Sibilla-DISPLAY-2, Sibilla-DISPLAY-3, Sibilla-SAE-1, Sibilla-SAE-2, Sibilla-SAE-3 | | |

| | | | |
|--------------------|--|-----------------|----------|
| | | | |
| 1 | | | |
| GEV No. | 527863 | Ref. No. | 25789306 |
| description | end cap thread M18x1 L 15mm WS 8 chrome-plated brass | | |
| For models: | Divina-AEP-1, Divina-AEP-2, Divina-AEP-3, Divina-AEP-4, Divina-AEP-J, Divina-SAE-1, Divina-SAE-2, Divina-SAE-3, Divina-SAE-4, Divina-SAE-J, Gloria-AEP-1, Gloria-AEP-2, Gloria-AEP-3, Gloria-AEP-4, Gloria-DISPLAY-LCL-2, Gloria-DISPLAY-LCL-3, Gloria-SAE-1, Gloria-SAE-2, Gloria-SAE-3, Gloria-SAE-4, Rapallo-AEP-1, Rapallo-AEP-2, Rapallo-AEP-3, Rapallo-AEP-4, Sibilla-AEP-1, Sibilla-AEP-2, Sibilla-AEP-3, Sibilla-DISPLAY-2, Sibilla-DISPLAY-3, Sibilla-SAE-1, Sibilla-SAE-2, Sibilla-SAE-3 | | |

| | | | |
|---|---|-----------------|----------|
|  | | | |
| GEV No. | 527862 | Ref. No. | 25789301 |
| description | end cap thread M18x1 L 26mm WS 15 brass | | |
| For models: | Brava, Rapallo-AEP-1, Rapallo-AEP-2, Rapallo-AEP-3, Rapallo-AEP-4, Sibilla-AEP-1, Sibilla-AEP-2, Sibilla-AEP-3, Sibilla-DISPLAY-2, Sibilla-DISPLAY-3, Sibilla-SAE-1, Sibilla-SAE-2, Sibilla-SAE-3 | | |

| | | | |
|---|--|-----------------|----------|
|  | | | |
| GEV No. | 527859 | Ref. No. | 25789305 |
| description | end cap thread M28x1.5 L 23mm WS 17 chrome-plated brass | | |
| For models: | Divina-AEP-1, Divina-AEP-2, Divina-AEP-3, Divina-AEP-4, Divina-AEP-J, Divina-SAE-1, Divina-SAE-2, Divina-SAE-3, Divina-SAE-4, Divina-SAE-J, Gloria-AEP-1, Gloria-AEP-2, Gloria-AEP-3, Gloria-AEP-4, Gloria-DISPLAY-LCL-2, Gloria-DISPLAY-LCL-3, Gloria-SAE-1, Gloria-SAE-2, Gloria-SAE-3, Gloria-SAE-4 | | |

reducers

| | | | |
|---|--|-----------------|----------|
|  | | | |
| GEV No. | 527857 | Ref. No. | 25750100 |
| description | reducer T1: 1/4" int. ø 1 4mm L 16mm brass | | |
| For models: | Sibilla-AEP-1, Sibilla-AEP-2, Sibilla-AEP-3, Sibilla-DISPLAY-2, Sibilla-DISPLAY-3, Sibilla-SAE-1, Sibilla-SAE-2, Sibilla-SAE-3 | | |

T-pieces

| | | | |
|---|---|-----------------|---------------------|
|  | | | |
| GEV No. | 527831 | Ref. No. | 23215 4623215001 |
| description | T-piece thread 1/4" T1: 1/2" T2: 1/2" ID ø 12.2mm int. ø 1 12.6mm L 50mm brass for boiler | | |

| | | | |
|---|--|-----------------|-------|
|  | | | |
| GEV No. | 527832 | Ref. No. | 43060 |
| description | T-piece thread 1/4" T1: 1/4" T2: 1/4" ID ø 6.2mm int. ø 1 6.2mm int. ø 2 6.2mm L 53mm brass for boiler | | |
| For models: | Argenta-AEP-1, Argenta-AEP-2, Argenta-AEP-3, Argenta-AEP-4, Argenta-AEP-J, Argenta-SAE-1, Argenta-SAE-2, Argenta-SAE-3, Argenta-SAE-4, Argenta-SAE-J, Brava, Brava-SME-1, Brava-SME-2, Brava-SME-3, Brava-SME-4, Brava-SMSA-1, Brava-SMSA-2, Brava-SMSA-3, Brava-SMSA-4, Divina, Divina-AEP-1, Divina-AEP-2, Divina-AEP-3, Divina-AEP-4, Divina-AEP-J, Divina-SAE-1, Divina-SAE-2, Divina-SAE-3, Divina-SAE-4, Divina-SAE-J, Giada-1, Giada-2, Gloria-AEP-1, Gloria-AEP-2, Gloria-AEP-3, Gloria-AEP-4, Gloria-DISPLAY-LCL-2, Gloria-DISPLAY-LCL-3, Gloria-SAE-1, Gloria-SAE-2, Gloria-SAE-3, Gloria-SAE-4, Rapallo-AEP-1, Rapallo-AEP-2, Rapallo-AEP-3, Rapallo-AEP-4, Rapallo-AL-1, Rapallo-AL-2, Rapallo-AL-3, Rapallo-AL-4... (Other models you can see in the webshop) | | |

| | | | |
|---|---|-----------------|-------|
|  | | | |
| GEV No. | 527833 | Ref. No. | 43033 |
| description | T-piece thread 1/4" T1: 3/8" T2: 3/8" ID ø 6.2mm int. ø 1 8.2mm int. ø 2 8.2mm L 53mm brass for boiler | | |
| For models: | Argenta, Argenta-AEP-1, Argenta-AEP-2, Argenta-AEP-3, Argenta-AEP-4, Argenta-AEP-J, Argenta-SAE-1, Argenta-SAE-2, Argenta-SAE-3, Argenta-SAE-4, Argenta-SAE-J, Brava, Brava-SME-1, Brava-SME-2, Brava-SME-3, Brava-SME-4, Brava-SMSA-1, Brava-SMSA-2, Brava-SMSA-3, Brava-SMSA-4, CK, CK-CKE, CK-CKE-CK-1, CK-CKE-CKE-1, CKE, CKP, CKPE, CKX-CKXE, CKX-CKXE-CKX-1, CKX-CKXE-CKXE-1, CMA, CompattaArgenta, Denise, Divina, Divina-AEP-1, Divina-AEP-2, Divina-AEP-3, Divina-AEP-4, Divina-AEP-J, Divina-SAE-1, Divina-SAE-2, Divina-SAE-3, Divina-SAE-4, Divina-SAE-J, Dora, Giada-1, Giada-2, Gloria-AEP-1, Gloria-AEP-2, Gloria-AEP-3... (Other models you can see in the webshop) | | |

miscellaneous

| | | | |
|---|--|-----------------|----------|
|  | | | |
| GEV No. | 527860 | Ref. No. | 25732100 |
| description | connecting fitting for filter T1: 3/8" T2: 3/8" int. ø 1 8.5mm int. ø 2 11.5mm L 28mm brass | | |
| For models: | Argenta-AEP-1, Argenta-AEP-2, Argenta-AEP-3, Argenta-AEP-4, Argenta-AEP-J, Argenta-SAE-1, Argenta-SAE-2, Argenta-SAE-3, Argenta-SAE-4, Argenta-SAE-J, Brava-SME-1, Brava-SME-2, Brava-SME-3, Brava-SME-4, Brava-SMSA-1, Brava-SMSA-2, Brava-SMSA-3, Brava-SMSA-4, Divina-AEP-1, Divina-AEP-2, Divina-AEP-3, Divina-AEP-4, Divina-AEP-J, Divina-SAE-1, Divina-SAE-2, Divina-SAE-3, Divina-SAE-4, Divina-SAE-J, Giada-1, Giada-2, Gloria-AEP-1, Gloria-AEP-2, Gloria-AEP-3, Gloria-AEP-4, Gloria-DISPLAY-LCL-2, Gloria-DISPLAY-LCL-3, Gloria-SAE-1, Gloria-SAE-2, Gloria-SAE-3, Gloria-SAE-4, Rapallo-AEP-1, Rapallo-AEP-2, Rapallo-AEP-3, Rapallo-AEP-4, Rapallo-AL-1, Rapallo-AL-2, Rapallo-AL-3, Rapallo-AL-4, Sara-1GR-1, Sara-2GR-2 | | |

angle pieces

| | | | |
|---|---|-----------------|---------------------|
|  | | | |
| GEV No. | 527830 | Ref. No. | 23214 4623214001 |
| description | angle piece T1: 1/2" T2: 1/2" int. ø 1 12.3mm int. ø 2 12.6mm L 50mm brass for boiler | | |



| | | | |
|--------------------|---|-----------------|-------|
| | | | |
| 1 | | | |
| GEV No. | 527828 | Ref. No. | 23203 |
| description | angle piece T1: 1/4" T2: 1/4" int. ø 1 6.2mm L 25mm brass for gas appliance | | |
| For models: | Argenta, Argenta-AEP-1, Argenta-AEP-2, Argenta-AEP-3, Argenta-AEP-4, Argenta-AEP-J, Argenta-SAE-1, Argenta-SAE-2, Argenta-SAE-3, Argenta-SAE-4, Argenta-SAE-J, Brava, Brava-SME-1, Brava-SME-2, Brava-SME-3, Brava-SME-4, Brava-SMSA-1, Brava-SMSA-2, Brava-SMSA-3, Brava-SMSA-4, CKPE, CMA, CompattaArgenta, Denise, Divina, Divina-AEP-1, Divina-AEP-2, Divina-AEP-3, Divina-AEP-4, Divina-AEP-J, Divina-SAE-1, Divina-SAE-2, Divina-SAE-3, Divina-SAE-4, Divina-SAE-J, Dora, Giada-1, Giada-2, Giada-Fridge-Cup-warmer-1, Gloria-AEP-1, Gloria-AEP-2, Gloria-AEP-3, Gloria-AEP-4, Gloria-DISPLAY-LCL-2, Gloria-DISPLAY-LCL-3, Gloria-SAE-1, Gloria-SAE-2, Gloria-SAE-3, Gloria-SAE-4, Sara-1GR-1...(Other models you can see in the webshop) | | |

| | | | |
|--------------------|--|-----------------|----------|
| | | | |
| 2 | | | |
| GEV No. | 527864 | Ref. No. | 23203001 |
| description | angle piece T1: 1/4" T2: 1/4" IT M8 int. ø 1 6.2mm brass | | |
| For models: | Sibilla-AEP-1, Sibilla-AEP-2, Sibilla-AEP-3, Sibilla-DISPLAY-2, Sibilla-DISPLAY-3, Sibilla-SAE-1, Sibilla-SAE-2, Sibilla-SAE-3 | | |

| | | | |
|--------------------|--|-----------------|-------|
| | | | |
| 1 | | | |
| GEV No. | 527829 | Ref. No. | 43052 |
| description | angle piece T1: 3/8" T2: 3/8" int. ø 1 8.4mm int. ø 2 10.2mm L 25mm brass for boiler | | |
| For models: | Argenta, Argenta-AEP-1, Argenta-AEP-2, Argenta-AEP-3, Argenta-AEP-4, Argenta-AEP-J, Argenta-SAE-1, Argenta-SAE-2, Argenta-SAE-3, Argenta-SAE-4, Argenta-SAE-J, Brava, Brava-SME-1, Brava-SME-2, Brava-SME-3, Brava-SME-4, Brava-SMSA-1, Brava-SMSA-2, Brava-SMSA-3, Brava-SMSA-4, CK, CK-CKE, CK-CKE-CK-1, CK-CKE-CKE-1, CKE, CKP, CKPE, CKX-CKXE, CKX-CKXE-CKX-1, CKX-CKXE-CKXE-1, CMA, CompattaArgenta, Denise, Divina-AEP-1, Divina-AEP-2, Divina-AEP-3, Divina-AEP-4, Divina-AEP-J, Divina-SAE-1, Divina-SAE-2, Divina-SAE-3, Divina-SAE-4, Divina-SAE-J, Giada-1, Giada-2, Gloria-AEP-1, Gloria-AEP-2, Gloria-AEP-3, Gloria-AEP-4, Gloria-DISPLAY-LCL-2...(Other models you can see in the webshop) | | |

| | | | |
|-------------------------|--|-----------------|----------|
| water containers | | | |
| | | | |
| 1 | | | |
| GEV No. | 527360 | Ref. No. | 15514101 |
| description | water container for espresso machine | | |
| For models: | CK-CKE-CK-1, CK-CKE-CKE-1, CKX-CKXE, CKX-CKXE-CKX-1, CKX-CKXE-CKXE-1 | | |

for coffee grinders

grinding burrs

grinding burrs straight

standard

| | | | |
|--------------------|--|-----------------|----------|
| | | | |
| 1 | | | |
| GEV No. | 527241 | Ref. No. | 28217000 |
| description | grinding burrs pair turn direction right D1 ø 63.3mm ID ø 38mm H 9mm tooth spacing 3mm hole ø 5.5mm bore ø 8.5mm mounting ø 50 straight suitable for WEGA, COMPAK, ASTORIA | | |
| For models: | Coffee-grinder-K-1 | | |

| | | | |
|--------------------|--|-----------------|----------|
| | | | |
| 1 | | | |
| GEV No. | 527242 | Ref. No. | 28217005 |
| description | grinding burrs pair turn direction right D1 ø 80mm ID ø 41mm H 10.3mm tooth spacing 4mm hole ø 6mm bore ø 10mm mounting ø 60.5 straight suitable for WEGA, COMPAK, ASTORIA | | |
| For models: | Coffee-grinder-K-1 | | |

dosing containers

glass cylinders

| | | | |
|--------------------|-------------------------------------|-----------------|-------|
| | | | |
| 1 | | | |
| GEV No. | 527332 | Ref. No. | 28051 |
| description | glass cylinder for dosing container | | |

coffee beans containers

coffee beans containers

glass cylinders



| | | | | |
|---|--------------------|-------------------------------------|-----------------|-------|
| 1 | GEV No. | 527332 | Ref. No. | 28051 |
| | description | glass cylinder for dosing container | | |

for cup coffee machines

aerators and air bleeders



| | | | | |
|---|--------------------|---|-----------------|-------------------|
| 1 | GEV No. | 525799 | Ref. No. | 56155 56155000 |
| | description | aerator and air bleeder connection 1/4" for boiler suitable for CMA | | |
| | For models: | Giada-1, Giada-2, Sara-1GR-1, Sara-2GR-2 | | |

brewing units

components

heating elements for brewing units



| | | | | |
|---|--------------------|---|-----------------|-------|
| 1 | GEV No. | 417465 | Ref. No. | 17509 |
| | description | heating cartridge 10W 24V ø 6.4mm L 32mm cable length 600mm dry heating element | | |
| | For models: | DPiu-1, Giada-1, Giada-2, Sara-1GR-1, Sara-2GR-2 | | |



| | | | | |
|---|--------------------|---|-----------------|-------|
| 1 | GEV No. | 417464 | Ref. No. | 17507 |
| | description | heating cartridge 150W 230V ø 6.4mm L 53mm cable length 600mm | | |
| | For models: | CMA, DPiu-1, Giada-1, Giada-2, Sara-1GR-1, Sara-2GR-2 | | |

EQUIPMENT-SPECIFIC UNITS ASTORIA-CMA

gaskets



| | | | | |
|---|--------------------|--|-----------------|----------|
| 1 | GEV No. | 525814 | Ref. No. | 12323001 |
| | description | boot D1 ø 43.5mm D2 ø 30mm for brewing unit Qty 1 pcs suitable for ASTORIA | | |
| | For models: | CMA, DPiu-1, Giada-1, Giada-2, Sara-1GR-1, Sara-2GR-2 | | |



| | | | | |
|---|--------------------|--|-----------------|----------|
| 1 | GEV No. | 525781 | Ref. No. | 15117000 |
| | description | flat gasket EPDM ED ø 40mm ID ø 34mm thickness 4mm Qty 1 pcs | | |
| | For models: | DPiu-1, Giada-1, Giada-2, Sara-1GR-1, Sara-2GR-2 | | |

shower screens



| | | | | |
|---|--------------------|---|-----------------|----------|
| 1 | GEV No. | 525796 | Ref. No. | 27103001 |
| | description | shower screen ø 41.2mm hole ø 5.7mm | | |
| | For models: | CMA, DPiu-1, Giada-1, Giada-2, Sara-1GR-1, Sara-2GR-2 | | |

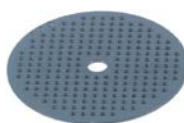

| | | | | |
|---|--------------------|--|-----------------|----------|
| 1 | GEV No. | 525797 | Ref. No. | 27103003 |
| | description | shower screen ø 41mm hole ø 4.5mm close-meshed | | |
| | For models: | DPiu-1, Giada-1, Giada-2, Sara-1GR-1, Sara-2GR-2 | | |



| | | | | |
|---|--------------------|---------------------------------|-----------------|-------|
| 1 | GEV No. | 525790 | Ref. No. | 27103 |
| | description | shower screen ø 42mm hole ø 5mm | | |
| | For models: | CMA, Sara-1GR-1, Sara-2GR-2 | | |

steam/water pipes



| | | | | |
|---|--------------------|---|-----------------|----------|
| 1 | GEV No. | 525789 | Ref. No. | 25763309 |
| | description | steam pipe H 305mm stainless steel | | |
| | For models: | Giada-1, Giada-2, Giada-Fridge-Cup-warmer-1, Sara-1GR-1, Sara-2GR-2, Sara-Fridge-Cup-warmer | | |



1

| | | | |
|--------------------|---|-----------------|--------|
| GEV No. | 525791 | Ref. No. | 25763A |
| description | water pipe fortelescopic rail thread 1/4" L 120mm | | |
| For models: | Brava, Brava-SME-1, Brava-SME-2, Brava-SME-3, Brava-SME-4, Brava-SMSA-1, Brava-SMSA-2, Brava-SMSA-3, Brava-SMSA-4, CompattaArgenta, Giada-1, Giada-2, Giada-Fridge-Cup-warmer-1, Sara-1GR-1, Sara-2GR-2, Sara-Fridge-Cup-warmer | | |

coffee spouts

coffee spouts



1

| | | | |
|--------------------|--|-----------------|----------|
| GEV No. | 525793 | Ref. No. | 30514000 |
| description | coffee spout adjustable | | |
| For models: | Giada-1, Giada-2, Sara-1GR-1, Sara-2GR-2 | | |



1

| | | | |
|--------------------|---|-----------------|----------|
| GEV No. | 525792 | Ref. No. | 25327100 |
| description | coffee spout for EKO | | |
| For models: | CMA, Giada-1, Giada-2, Sara-1GR-1, Sara-2GR-2 | | |



1

| | | | |
|--------------------|--|-----------------|-----------|
| GEV No. | 525794 | Ref. No. | 83300019R |
| description | coffee spout with milk foamer suitable for ASTORIA | | |
| For models: | Giada-1, Giada-2, Sara-1GR-1, Sara-2GR-2 | | |

milk foamers



1

| | | | |
|--------------------|--|-----------------|----------|
| GEV No. | 525795 | Ref. No. | 30513002 |
| description | milk foamer suitable for ASTORIA for EKO | | |
| For models: | Giada-1, Giada-2, Sara-1GR-1, Sara-2GR-2 | | |

coffee beans containers

coffee beans containers



1

| | | | |
|--------------------|--|-----------------|----------|
| GEV No. | 525786 | Ref. No. | 28357001 |
| description | coffee beans container complete | | |
| For models: | Coffee-grinder-K-1, Giada-1, Giada-2, Sara-1GR-1, Sara-2GR-2 | | |



1

| | | | |
|--------------------|---|-----------------|----------|
| GEV No. | 525788 | Ref. No. | 15491000 |
| description | coffee beans container ø 187mm H 255mm with adapter | | |
| For models: | CMA, Sara-1GR-1, Sara-2GR-2 | | |

accessories



1

| | | | |
|--------------------|--|-----------------|----------|
| GEV No. | 525787 | Ref. No. | 15491016 |
| description | adapter for coffee beans container ø 60mm ID ø 46.4mm H 50.6mm plastic | | |

grinding units

grinding burrs



1

| | | | |
|--------------------|--|-----------------|-------|
| GEV No. | 525785 | Ref. No. | 28234 |
| description | grinding burrs pair turn direction right D1 ø 63.9mm ID ø 38mm H 9mm tooth spacing 3.5mm hole ø 5.5mm bore ø 8mm mounting ø 57.3 | | |
| For models: | CMA, Giada-1, Giada-2, Sara-1GR-1, Sara-2GR-2 | | |

non-return valves



1

| | | | |
|--------------------|--|-----------------|----------|
| GEV No. | 525798 | Ref. No. | 20358002 |
| description | non-return valve L 61mm plastic connection 8mm | | |
| For models: | CMA, Giada-1, Giada-2, Sara-1GR-1, Sara-2GR-2 | | |

for dishwashers

boilers

accessories



1

| | | | |
|--------------------|---|-----------------|-------|
| GEV No. | 527207 | Ref. No. | 25743 |
| description | reducer thread 1/4" IT - 1/8" ET brass WS 17 | | |
| For models: | Argenta-AEP-1, Argenta-AEP-2, Argenta-AEP-3, Argenta-AEP-4, Argenta-AEP-J, Argenta-SAE-1, Argenta-SAE-2, Argenta-SAE-3, Argenta-SAE-4, Argenta-SAE-J, Brava, Brava-SME-1, Brava-SME-2, Brava-SME-3, Brava-SME-4, Brava-SMSA-1, Brava-SMSA-2, Brava-SMSA-3, Brava-SMSA-4, CK, CK-CKE, CK-CKE-CK-1, CK-CKE-CKE-1, CKE, CKP, CKPE, CKX-CKXE, CKX-CKXE-CKX-1, CKX-CKXE-CKXE-1, Divina, Divina-AEP-1, Divina-AEP-2, Divina-AEP-3, Divina-AEP-4, Divina-AEP-J, Divina-SAE-1, Divina-SAE-2, Divina-SAE-3, Divina-SAE-4, Divina-SAE-J, Sibilla-AEP-1, Sibilla-AEP-2, Sibilla-AEP-3, Sibilla-DISPLAY-2, Sibilla-DISPLAY-3, Sibilla-SAE-1, Sibilla-SAE-2, Sibilla-SAE-3 | | |

washing and rinsing systems



1

| | | | |
|--------------------|---|-----------------|-------|
| GEV No. | 520702 | Ref. No. | 25782 |
| description | end cap thread 1/4" brass WS 16 | | |
| For models: | Argenta, Argenta-AEP-1, Argenta-AEP-2, Argenta-AEP-3, Argenta-AEP-4, Argenta-AEP-J, Argenta-SAE-1, Argenta-SAE-2, Argenta-SAE-3, Argenta-SAE-4, Argenta-SAE-J, Brava, Brava-SME-1, Brava-SME-2, Brava-SME-3, Brava-SME-4, Brava-SMSA-1, Brava-SMSA-2, Brava-SMSA-3, Brava-SMSA-4, CMA, CompattaArgenta, Denise, Divina, Divina-AEP-1, Divina-AEP-2, Divina-AEP-3, Divina-AEP-4, Divina-AEP-J, Divina-SAE-1, Divina-SAE-2, Divina-SAE-3, Divina-SAE-4, Divina-SAE-J, Dora, Giada-1, Giada-2, Gloria-AEP-1, Gloria-AEP-2, Gloria-AEP-3, Gloria-AEP-4, Gloria-DISPLAY-LCL-2, Gloria-DISPLAY-LCL-3, Gloria-SAE-1, Gloria-SAE-2, Gloria-SAE-3, Gloria-SAE-4, Rapallo-AEP-1, Rapallo-AEP-2, Rapallo-AEP-3...(Other models you can see in the webshop) | | |



1

| | | | |
|--------------------|---|-----------------|-------|
| GEV No. | 520706 | Ref. No. | 25780 |
| description | screw cap thread 1/4" WS 17 | | |
| For models: | Argenta, Argenta-AEP-1, Argenta-AEP-2, Argenta-AEP-3, Argenta-AEP-4, Argenta-AEP-J, Argenta-SAE-1, Argenta-SAE-2, Argenta-SAE-3, Argenta-SAE-4, Argenta-SAE-J, Brava, Brava-SME-1, Brava-SME-2, Brava-SME-3, Brava-SME-4, Brava-SMSA-1, Brava-SMSA-2, Brava-SMSA-3, Brava-SMSA-4, CompattaArgenta, Denise, Divina, Divina-AEP-1, Divina-AEP-2, Divina-AEP-3, Divina-AEP-4, Divina-AEP-J, Divina-SAE-1, Divina-SAE-2, Divina-SAE-3, Divina-SAE-4, Divina-SAE-J, Dora, Gloria-AEP-1, Gloria-AEP-2, Gloria-AEP-3, Gloria-AEP-4, Gloria-DISPLAY-LCL-2, Gloria-DISPLAY-LCL-3, Gloria-SAE-1, Gloria-SAE-2, Gloria-SAE-3, Gloria-SAE-4, Rapallo-AEP-1, Rapallo-AEP-2, Rapallo-AEP-3, Rapallo-AEP-4, Rapallo-AL-1, Rapallo-AL-2...(Other models you can see in the webshop) | | |

knobs

steam/water taps

steam/water taps





1

| | | | |
|------------------------|--|-----------------|--------------------------------------|
| GEV No. | 111158 | Ref. No. | 15275 |
| description | knob ø 46mm | | |
| For models: | CMA, Denise, Giada-1, Giada-2, Sara-1GR-1, Sara-2GR-2, Vania | | |
| accessories for | 111158 | | |
| | GEV No. | Ref. No. | — |
| | | | knob spring L 10.5mm W 9mm Qty 1 pcs |



| | | | |
|---|-------------------------------|-----------------|------------|
|  | | | |
| 1 | | | |
| GEV No. | 527768 | Ref. No. | WY15278014 |
| description | knob ø 46mm shaft ø 8mm black | | |



| | | | |
|---|---|-----------------|----------|
|  | | | |
| 1 | | | |
| GEV No. | 111154 | Ref. No. | 15277997 |
| description | knob ø 50mm | | |
| For models: | Brava, Brava-SME-1, Brava-SME-2, Brava-SME-3, Brava-SME-4, Brava-SMSA-1, Brava-SMSA-2, Brava-SMSA-3, Brava-SMSA-4 | | |

| | | | |
|---|---|-----------------|-------|
|  | | | |
| 1 | | | |
| GEV No. | 111090 | Ref. No. | 15254 |
| description | knob ø 55mm shaft ø 10x8mm shaft flat upper black | | |
| For models: | Argenta, Dora | | |

| | | | |
|---|--|-----------------|-------|
|  | | | |
| 1 | | | |
| GEV No. | 111091 | Ref. No. | 15265 |
| description | knob steam ø 40mm shaft ø 10x8mm shaft flat upper black | | |
| For models: | Argenta, Argenta-AEP-1, Argenta-AEP-2, Argenta-AEP-3, Argenta-AEP-4, Argenta-AEP-J, Argenta-SAE-1, Argenta-SAE-2, Argenta-SAE-3, Argenta-SAE-4, Argenta-SAE-J, CompattaArgenta, Divina, Divina-AEP-1, Divina-AEP-2, Divina-AEP-3, Divina-AEP-4, Divina-AEP-J, Divina-SAE-1, Divina-SAE-2, Divina-SAE-3, Divina-SAE-4, Divina-SAE-J | | |



| | | | |
|---|---|-----------------|-------|
|  | | | |
| 1 | | | |
| GEV No. | 111151 | Ref. No. | 15251 |
| description | knob steam ø 40mm shaft ø 6x6mm shaft flat square black | | |
| For models: | Argenta, Argenta-AEP-1, Argenta-AEP-2, Argenta-AEP-3, Argenta-AEP-4, Argenta-AEP-J, Argenta-SAE-1, Argenta-SAE-2, Argenta-SAE-3, Argenta-SAE-4, Argenta-SAE-J, Brava, Brava-SME-1, Brava-SME-2, Brava-SME-3, Brava-SME-4, Brava-SMSA-1, Brava-SMSA-2, Brava-SMSA-3, Brava-SMSA-4, CK, CK-CKE, CK-CKE-CK-1, CK-CKE-CKE-1, CKE, CKP, CKPE, CKX-CKXE, CKX-CKXE-CKX-1, CKX-CKXE-CKXE-1, CompattaArgenta, Denise, Divina-AEP-1, Divina-AEP-2, Divina-AEP-3, Divina-AEP-4, Divina-AEP-J, Divina-SAE-1, Divina-SAE-2, Divina-SAE-3, Divina-SAE-4, Divina-SAE-J, Gloria-AEP-1, Gloria-AEP-2, Gloria-AEP-3, Gloria-AEP-4, Gloria-DISPLAY-LCL-2, Gloria-DISPLAY-LCL-3, Gloria-SAE-1, Gloria-SAE-2...(Other models you can see in the webshop) | | |

| | | | |
|---|---|-----------------|-------|
|  | | | |
| 1 | | | |
| GEV No. | 111152 | Ref. No. | 15264 |
| description | knob water ø 40mm black | | |
| For models: | Argenta, Argenta-AEP-1, Argenta-AEP-2, Argenta-AEP-3, Argenta-AEP-4, Argenta-AEP-J, Argenta-SAE-1, Argenta-SAE-2, Argenta-SAE-3, Argenta-SAE-4, Argenta-SAE-J, Divina, Divina-AEP-1, Divina-AEP-2, Divina-AEP-3, Divina-AEP-4, Divina-AEP-J, Divina-SAE-1, Divina-SAE-2, Divina-SAE-3, Divina-SAE-4, Divina-SAE-J | | |

| | | | |
|---|--------------------------------------|-----------------|-------------------|
|  | | | |
| 1 | | | |
| GEV No. | 111157 | Ref. No. | 15276 |
| description | knob water ø 46mm black | | |
| For models: | Denise, Vania | | |
| accessories for | 111157 | | |
|  | GEV No. | 112494 | Ref. No. — |
| | knob spring L 10.5mm W 9mm Qty 1 pcs | | |

| | | | |
|---|---|-----------------|----------|
|  | | | |
| 1 | | | |
| GEV No. | 111153 | Ref. No. | 15277998 |
| description | knob water ø 49mm shaft ø 8x6.5mm shaft flat upper black | | |
| For models: | Brava, Brava-SME-1, Brava-SME-2, Brava-SME-3, Brava-SME-4, Brava-SMSA-1, Brava-SMSA-2, Brava-SMSA-3, Brava-SMSA-4 | | |

| | | | |
|---|-------------------------|-----------------|-------|
|  | | | |
| 1 | | | |
| GEV No. | 111156 | Ref. No. | 15253 |
| description | knob water ø 54mm black | | |
| For models: | Argenta, Dora | | |

| | | | |
|---|--|-----------------|--------------------------|
|  | | | |
| 1 | | | |
| GEV No. | 111256 | Ref. No. | 15029050 |
| description | turning handle ø 47mm shaft ø 8mm black | | |
| For models: | Gloria-AEP-1, Gloria-AEP-2, Gloria-AEP-3, Gloria-AEP-4, Gloria-DISPLAY-LCL-2, Gloria-DISPLAY-LCL-3, Gloria-SAE-1, Gloria-SAE-2, Gloria-SAE-3, Gloria-SAE-4, Sibilla-AEP-1, Sibilla-AEP-2, Sibilla-AEP-3, Sibilla-DISPLAY-2, Sibilla-DISPLAY-3, Sibilla-SAE-1, Sibilla-SAE-2, Sibilla-SAE-3 | | |
| accessories for | 111256 | | |
|  | GEV No. | 111257 | Ref. No. 15029051 |
| | lid for handle | | |

knob dial plates

| | | | |
|---|--|-----------------|----------|
|  | | | |
| 1 | | | |
| GEV No. | 111257 | Ref. No. | 15029051 |
| description | lid for handle | | |
| For models: | Gloria-AEP-1, Gloria-AEP-2, Gloria-AEP-3, Gloria-AEP-4, Gloria-DISPLAY-LCL-2, Gloria-DISPLAY-LCL-3, Gloria-SAE-1, Gloria-SAE-2, Gloria-SAE-3, Gloria-SAE-4, Sibilla-AEP-1, Sibilla-AEP-2, Sibilla-AEP-3, Sibilla-DISPLAY-2, Sibilla-DISPLAY-3, Sibilla-SAE-1, Sibilla-SAE-2, Sibilla-SAE-3 | | |

miscellaneous

| | | | |
|---|---------------------------|-----------------|-------|
|  | | | |
| 1 | | | |
| GEV No. | 110205 | Ref. No. | 15271 |
| description | knob ø 27mm shaft ø 5x5mm | | |

| | | | |
|---|--|-----------------|-------|
|  | | | |
| 1 | | | |
| GEV No. | 527259 | Ref. No. | 15271 |
| description | knob push-in ø 34/60mm shaft ø 5x5mm black H 21.4mm L 49mm | | |
| For models: | Argenta, Argenta-AEP-1, Argenta-AEP-2, Argenta-AEP-3, Argenta-AEP-4, Argenta-AEP-J, Argenta-SAE-1, Argenta-SAE-2, Argenta-SAE-3, Argenta-SAE-4, Argenta-SAE-J, Brava-SME-1, Brava-SME-2, Brava-SME-3, Brava-SME-4, Brava-SMSA-1, Brava-SMSA-2, Brava-SMSA-3, Brava-SMSA-4, CompattaArgenta, Denise, Divina, Divina-AEP-1, Divina-AEP-2, Divina-AEP-3, Divina-AEP-4, Divina-AEP-J, Divina-SAE-1, Divina-SAE-2, Divina-SAE-3, Divina-SAE-4, Divina-SAE-J, Dora, Gloria-AEP-1, Gloria-AEP-2, Gloria-AEP-3, Gloria-AEP-4, Gloria-DISPLAY-LCL-2, Gloria-DISPLAY-LCL-3, Gloria-SAE-1, Gloria-SAE-2, Gloria-SAE-3, Gloria-SAE-4, Rapallo-AEP-1, Rapallo-AEP-2, Rapallo-AEP-3, Rapallo-AEP-4, Rapallo-AL-1, Rapallo-AL-2, Rapallo-AL-3...(Other models you can see in the webshop) | | |

| | | | |
|---|---|-----------------|----------|
|  | | | |
| 1 | | | |
| GEV No. | 111155 | Ref. No. | 15277999 |
| description | knob universal ø 50mm shaft 5x5 | | |
| For models: | Brava, Brava-SME-1, Brava-SME-2, Brava-SME-3, Brava-SME-4, Brava-SMSA-1, Brava-SMSA-2, Brava-SMSA-3, Brava-SMSA-4 | | |

| | | | |
|--|---|-----------------|----------|
|  | | | |
| 1 | | | |
| GEV No. | 528942 | Ref. No. | 27421022 |
| description | cone handle thread M8 ø 28mm L 46mm plastic black | | |

equipment feet and end caps

equipment feet

with screw mounting

universal

| | | | |
|--|--|-----------------|-------|
|  | | | |
| 1 | | | |
| GEV No. | 802132 | Ref. No. | 15318 |
| description | equipment foot tube ø 52mm thread M10 thread L 10mm H 60-75mm SS size 2" Qty 1 pcs | | |
| For models: | Argenta-AEP-1, Argenta-AEP-2, Argenta-AEP-3, Argenta-AEP-4, Argenta-AEP-J, Argenta-SAE-1, Argenta-SAE-2, Argenta-SAE-3, Argenta-SAE-4, Argenta-SAE-J, Brava-SME-1, Brava-SME-2, Brava-SME-3, Brava-SME-4, Brava-SMSA-1, Brava-SMSA-2, Brava-SMSA-3, Brava-SMSA-4, Divina-AEP-1, Divina-AEP-2, Divina-AEP-3, Divina-AEP-4, Divina-AEP-J, Divina-SAE-1, Divina-SAE-2, Divina-SAE-3, Divina-SAE-4, Divina-SAE-J, DPIU-1, Giada-1, Giada-2, Gloria-AEP-1, Gloria-AEP-2, Gloria-AEP-3, Gloria-AEP-4, Gloria-DISPLAY-LCL-2, Gloria-DISPLAY-LCL-3, Gloria-SAE-1, Gloria-SAE-2, Gloria-SAE-3, Gloria-SAE-4, Rapallo-AEP-1, Rapallo-AEP-2, Rapallo-AEP-3, Rapallo-AEP-4, Rapallo-AL-1, Rapallo-AL-2, Rapallo-AL-3, Rapallo-AL-4, Sara-1GR-1...(Other models you can see in the webshop) | | |

gaskets

O-rings

EPDM

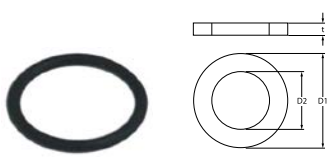
| | | | |
|--|--|-----------------|-------|
|  | | | |
| 1 | | | |
| GEV No. | 504512 | Ref. No. | 12330 |
| description | O-ring EPDM thickness 1.78mm ID ø 14mm Qty 1 pcs | | |

handles and hand wheels

cone handles

| | | | |
|---|---|-----------------|-------------------|
|  | | | |
| 1 | | | |
| GEV No. | 111092 | Ref. No. | 15400 27421022 |
| description | cone handle thread M8 ø 25mm L 41mm black | | |
| For models: | Argenta, Argenta-AEP-1, Argenta-AEP-2, Argenta-AEP-3, Argenta-AEP-4, Argenta-AEP-J, Argenta-SAE-1, Argenta-SAE-2, Argenta-SAE-3, Argenta-SAE-4, Argenta-SAE-J, Brava, Brava-SME-1, Brava-SME-2, Brava-SME-3, Brava-SME-4, Brava-SMSA-1, Brava-SMSA-2, Brava-SMSA-3, Brava-SMSA-4, CompattaArgenta, Denise, Divina, Divina-AEP-1, Divina-AEP-2, Divina-AEP-3, Divina-AEP-4, Divina-AEP-J, Divina-SAE-1, Divina-SAE-2, Divina-SAE-3, Divina-SAE-4, Divina-SAE-J, Dora, Gloria-AEP-1, Gloria-AEP-2, Gloria-AEP-3, Gloria-AEP-4, Gloria-DISPLAY-LCL-2, Gloria-DISPLAY-LCL-3, Gloria-SAE-1, Gloria-SAE-2, Gloria-SAE-3, Gloria-SAE-4, Rapallo-AEP-1, Rapallo-AEP-2, Rapallo-AEP-3, Rapallo-AEP-4, Rapallo-AL-1, Rapallo-AL-2...(Other models you can see in the webshop) | | |



| | | | |
|--------------------|---|-----------------|-------|
| | | | |
| GEV No. | 504574 | Ref. No. | 12306 |
| description | O-ring EPDM thickness 1.78mm ID ø 9.25mm Qty 1 pcs | | |
| For models: | CMA, Giada-1, Giada-2, Gloria-AEP-1, Gloria-AEP-2, Gloria-AEP-3, Gloria-AEP-4, Gloria-DISPLAY-LCL-2, Gloria-DISPLAY-LCL-3, Gloria-SAE-1, Gloria-SAE-2, Gloria-SAE-3, Gloria-SAE-4, Sara-1GR-1, Sara-2GR-2 | | |

| | | | |
|--------------------|--|-----------------|-------|
| | | | |
| GEV No. | 527158 | Ref. No. | 12312 |
| description | O-ring EPDM thickness 2mm ID ø 10mm Qty 1 pcs | | |
| For models: | Argenta, Argenta-AEP-1, Argenta-AEP-2, Argenta-AEP-3, Argenta-AEP-4, Argenta-AEP-J, Argenta-SAE-1, Argenta-SAE-2, Argenta-SAE-3, Argenta-SAE-4, Argenta-SAE-J, Brava, Brava-SME-1, Brava-SME-2, Brava-SME-3, Brava-SME-4, Brava-SMSA-1, Brava-SMSA-2, Brava-SMSA-3, Brava-SMSA-4, CK, CK-CKE, CK-CKE-CK-1, CK-CKE-CKE-1, CKE, CKP, CKPE, CKX-CKXE, CKX-CKXE-CKX-1, CKX-CKXE-CKXE-1, CompattaArgenta, Denise, Divina, Divina-AEP-1, Divina-AEP-2, Divina-AEP-3, Divina-AEP-4, Divina-AEP-J, Divina-SAE-1, Divina-SAE-2, Divina-SAE-3, Divina-SAE-4, Divina-SAE-J, Dora, Giada-1, Giada-2, Gloria-AEP-1, Gloria-AEP-2, Gloria-AEP-3, Gloria-AEP-4... (Other models you can see in the webshop) | | |

| | | | |
|--------------------|--|-----------------|-------|
| | | | |
| GEV No. | 529412 | Ref. No. | 12300 |
| description | O-ring EPDM thickness 2.62mm ID ø 10.78mm Qty 1 pcs | | |
| For models: | Argenta, Argenta-AEP-1, Argenta-AEP-2, Argenta-AEP-3, Argenta-AEP-4, Argenta-AEP-J, Argenta-SAE-1, Argenta-SAE-2, Argenta-SAE-3, Argenta-SAE-4, Argenta-SAE-J, Brava, Brava-SME-1, Brava-SME-2, Brava-SME-3, Brava-SME-4, Brava-SMSA-1, Brava-SMSA-2, Brava-SMSA-3, Brava-SMSA-4, CK, CK-CKE, CK-CKE-CK-1, CK-CKE-CKE-1, CKE, CKP, CKPE, CKX-CKXE, CKX-CKXE-CKX-1, CKX-CKXE-CKXE-1, CMA, CompattaArgenta, Denise, Divina-AEP-1, Divina-AEP-2, Divina-AEP-3, Divina-AEP-4, Divina-AEP-J, Divina-SAE-1, Divina-SAE-2, Divina-SAE-3, Divina-SAE-4, Divina-SAE-J, Dora, Giada-1, Giada-2, Giada-Fridge-Cup-warmer-1, Gloria-AEP-1, Gloria-AEP-2, Gloria-AEP-3... (Other models you can see in the webshop) | | |

| | | | |
|--------------------|---|-----------------|-------|
| | | | |
| GEV No. | 528315 | Ref. No. | 12304 |
| description | O-ring EPDM thickness 3.53mm ID ø 47.63mm Qty 1 pcs | | |
| For models: | Argenta, Argenta-AEP-1, Argenta-AEP-2, Argenta-AEP-3, Argenta-AEP-4, Argenta-AEP-J, Argenta-SAE-1, Argenta-SAE-2, Argenta-SAE-3, Argenta-SAE-4, Argenta-SAE-J, Brava, Brava-SME-1, Brava-SME-2, Brava-SME-3, Brava-SME-4, Brava-SMSA-1, Brava-SMSA-2, Brava-SMSA-3, Brava-SMSA-4, CK, CK-CKE, CK-CKE-CK-1, CK-CKE-CKE-1, CKE, CKX-CKXE, CKX-CKXE-CKX-1, CKX-CKXE-CKXE-1, CompattaArgenta, Denise, Dora, Rapallo-AEP-1, Rapallo-AEP-2, Rapallo-AEP-3, Rapallo-AEP-4, Sibilla-AEP-1, Sibilla-AEP-2, Sibilla-AEP-3, Sibilla-DISPLAY-2, Sibilla-DISPLAY-3, Sibilla-SAE-1, Sibilla-SAE-2, Sibilla-SAE-3, Vania | | |

| | | | |
|--------------------|--|-----------------|----------|
| | | | |
| GEV No. | 516026 | Ref. No. | 12300026 |
| description | O-ring EPDM thickness 2.62mm ID ø 17.86mm Qty 1 pcs | | |
| For models: | Divina-AEP-1, Divina-AEP-2, Divina-AEP-3, Divina-AEP-4, Divina-AEP-J, Divina-SAE-1, Divina-SAE-2, Divina-SAE-3, Divina-SAE-4, Divina-SAE-J, Gloria-AEP-1, Gloria-AEP-2, Gloria-AEP-3, Gloria-AEP-4, Gloria-DISPLAY-LCL-2, Gloria-DISPLAY-LCL-3, Gloria-SAE-1, Gloria-SAE-2, Gloria-SAE-3, Gloria-SAE-4, Rapallo-AEP-1, Rapallo-AEP-2, Rapallo-AEP-3, Rapallo-AEP-4, Sibilla-AEP-1, Sibilla-AEP-2, Sibilla-AEP-3, Sibilla-DISPLAY-2, Sibilla-DISPLAY-3, Sibilla-SAE-1, Sibilla-SAE-2, Sibilla-SAE-3 | | |

| | | | |
|--------------------|---|-----------------|-------|
| | | | |
| GEV No. | 523012 | Ref. No. | 12302 |
| description | O-ring EPDM thickness 3.53mm ID ø 57.15mm Qty 1 pcs | | |
| For models: | Argenta, Brava, Denise, Divina, Dora, Rapallo-AL-1, Rapallo-AL-2, Rapallo-AL-3, Rapallo-AL-4, Vania | | |

| | | | |
|--------------------|---|-----------------|----------|
| | | | |
| GEV No. | 505192 | Ref. No. | 12300000 |
| description | O-ring EPDM thickness 2.62mm ID ø 39.34mm Qty 1 pcs | | |
| For models: | Argenta-AEP-1, Argenta-AEP-2, Argenta-AEP-3, Argenta-AEP-4, Argenta-AEP-J, Argenta-SAE-1, Argenta-SAE-2, Argenta-SAE-3, Argenta-SAE-4, Argenta-SAE-J, Brava, Brava-SME-1, Brava-SME-2, Brava-SME-3, Brava-SME-4, Brava-SMSA-1, Brava-SMSA-2, Brava-SMSA-3, Brava-SMSA-4, CMA, Divina-AEP-1, Divina-AEP-2, Divina-AEP-3, Divina-AEP-4, Divina-AEP-J, Divina-SAE-1, Divina-SAE-2, Divina-SAE-3, Divina-SAE-4, Divina-SAE-J, Dora, Giada-1, Giada-2, Gloria-AEP-1, Gloria-AEP-2, Gloria-AEP-3, Gloria-AEP-4, Gloria-DISPLAY-LCL-2, Gloria-DISPLAY-LCL-3, Gloria-SAE-1, Gloria-SAE-2, Gloria-SAE-3, Gloria-SAE-4, Rapallo-AEP-1, Rapallo-AEP-2, Rapallo-AEP-3, Rapallo-AEP-4, Rapallo-AL-1, Rapallo-AL-2, Rapallo-AL-3... (Other models you can see in the webshop) | | |

| | | | |
|--------------------|---|-----------------|-------|
| | | | |
| GEV No. | 528793 | Ref. No. | 12301 |
| description | O-ring EPDM thickness 3.53mm ID ø 58.74mm Qty 1 pcs | | |
| For models: | Argenta, Brava, Denise, Divina, Dora, Rapallo-AL-1, Rapallo-AL-2, Rapallo-AL-3, Rapallo-AL-4, Vania | | |

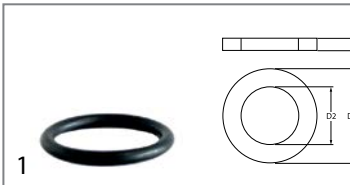

| | | | |
|--------------------|--|-----------------|----------|
| GEV No. | 532156 | Ref. No. | 12620001 |
| description | O-ring EPDM thickness 5.34mm ID ø 40.65mm Qty 10 pcs | | |
| For models: | Giada-1, Giada-2, Sara-1GR-1, Sara-2GR-2 | | |

silicone



| | | | |
|--------------------|--|-----------------|----------|
| GEV No. | 532554 | Ref. No. | 12223002 |
| description | O-ring silicone thickness 1.5mm ID ø 4.1mm Qty 1 pcs | | |
| For models: | Giada-1, Giada-2, Sara-1GR-1, Sara-2GR-2 | | |

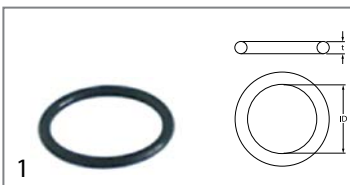

| | | | |
|--------------------|--|-----------------|----------|
| GEV No. | 532588 | Ref. No. | 12300012 |
| description | O-ring silicone thickness 1.78mm ID ø 12.42mm Qty 1 pcs | | |
| For models: | DPiu-1, Giada-1, Giada-2, Gloria-AEP-1, Gloria-AEP-2, Gloria-AEP-3, Gloria-AEP-4, Gloria-DISPLAY-LCL-2, Gloria-DISPLAY-LCL-3, Gloria-SAE-1, Gloria-SAE-2, Gloria-SAE-3, Gloria-SAE-4, Sara-1GR-1, Sara-2GR-2 | | |



| | | | |
|--------------------|---|-----------------|----------|
| GEV No. | 528516 | Ref. No. | 12300013 |
| description | O-ring silicone thickness 1mm ID ø 6mm Qty 1 pcs | | |
| For models: | Argenta-AEP-1, Argenta-AEP-2, Argenta-AEP-3, Argenta-AEP-4, Argenta-AEP-J, Argenta-SAE-1, Argenta-SAE-2, Argenta-SAE-3, Argenta-SAE-4, Argenta-SAE-J, Brava, Brava-SME-1, Brava-SME-2, Brava-SME-3, Brava-SME-4, Brava-SMSA-1, Brava-SMSA-2, Brava-SMSA-3, Brava-SMSA-4, CMA, CompattaArgenta, Denise, Giada-1, Giada-2, Giada-Fridge-Cup-warmer-1, Gloria-AEP-1, Gloria-AEP-2, Gloria-AEP-3, Gloria-AEP-4, Gloria-DISPLAY-LCL-2, Gloria-DISPLAY-LCL-3, Gloria-SAE-1, Gloria-SAE-2, Gloria-SAE-3, Gloria-SAE-4, Sara-1GR-1, Sara-2GR-2, Sara-Fridge-Cup-warmer, Vania | | |



| | | | |
|--------------------|--|-----------------|-------|
| GEV No. | 532590 | Ref. No. | 12609 |
| description | O-ring silicone thickness 2.62mm ID ø 13.95mm Qty 1 pcs | | |
| For models: | DPiu-1, Giada-1, Giada-2, Gloria-AEP-1, Gloria-AEP-2, Gloria-AEP-3, Gloria-AEP-4, Gloria-DISPLAY-LCL-2, Gloria-DISPLAY-LCL-3, Gloria-SAE-1, Gloria-SAE-2, Gloria-SAE-3, Gloria-SAE-4, Sara-1GR-1, Sara-2GR-2 | | |

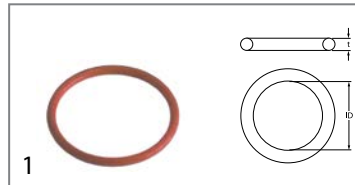

| | | | |
|--------------------|--|-----------------|-------|
| GEV No. | 532319 | Ref. No. | 12316 |
| description | O-ring silicone thickness 3.53mm ID ø 37.69mm Qty 10 pcs | | |
| For models: | CMA, DPiu-1, Giada-1, Giada-2, Sara-1GR-1, Sara-2GR-2 | | |

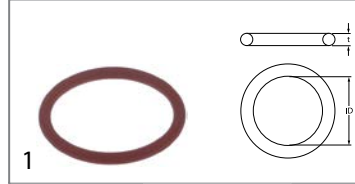

| | | | |
|--------------------|---|-----------------|-------|
| GEV No. | 532589 | Ref. No. | 12324 |
| description | O-ring silicone thickness 3mm ID ø 30mm Qty 1 pcs | | |
| For models: | CMA, DPiu-1, Giada-1, Giada-2, Gloria-AEP-1, Gloria-AEP-2, Gloria-AEP-3, Gloria-AEP-4, Gloria-DISPLAY-LCL-2, Gloria-DISPLAY-LCL-3, Gloria-SAE-1, Gloria-SAE-2, Gloria-SAE-3, Gloria-SAE-4, Sara-1GR-1, Sara-2GR-2 | | |

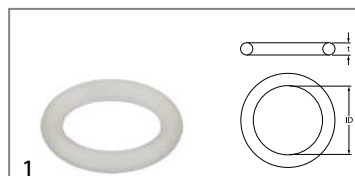

| | | | |
|--------------------|--|-----------------|----------|
| GEV No. | 532596 | Ref. No. | 12300021 |
| description | O-ring silicone thickness 4.5mm ID ø 15.5mm Qty 1 pcs | | |
| For models: | CK-CKE-CK-1, CK-CKE-CKE-1, CKX-CKXE, CKX-CKXE-CKX-1, CKX-CKXE-CKXE-1 | | |

Viton

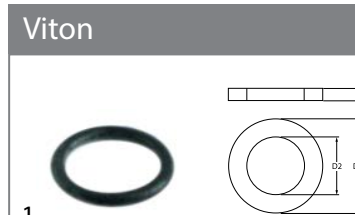

| | | | |
|--------------------|---|-----------------|-------|
| GEV No. | 532566 | Ref. No. | 12330 |
| description | O-ring Viton thickness 1.78mm ID ø 14mm Qty 1 pcs | | |
| For models: | Brava, Sibilla-AEP-1, Sibilla-AEP-2, Sibilla-AEP-3, Sibilla-DISPLAY-2, Sibilla-DISPLAY-3, Sibilla-SAE-1, Sibilla-SAE-2, Sibilla-SAE-3 | | |

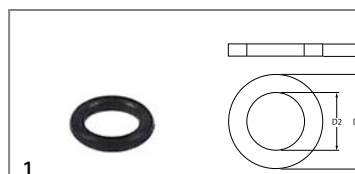

| | | | |
|--------------------|--|-----------------|-------|
| GEV No. | 371095 | Ref. No. | 12305 |
| description | O-ring Viton thickness 1.78mm ID ø 6.07mm Qty 1 pcs | | |
| For models: | Argenta, Argenta-AEP-1, Argenta-AEP-2, Argenta-AEP-3, Argenta-AEP-4, Argenta-AEP-J, Argenta-SAE-1, Argenta-SAE-2, Argenta-SAE-3, Argenta-SAE-4, Argenta-SAE-J, Brava, Brava-SME-1, Brava-SME-2, Brava-SME-3, Brava-SME-4, Brava-SMSA-1, Brava-SMSA-2, Brava-SMSA-3, Brava-SMSA-4, CK, CK-CKE, CK-CKE-CK-1, CK-CKE-CKE-1, CKE, CKP, CKPE, CKX-CKXE, CKX-CKXE-CKX-1, CKX-CKXE-CKXE-1, CMA, CompattaArgenta, Denise, Divina, Divina-AEP-1, Divina-AEP-2, Divina-AEP-3, Divina-AEP-4, Divina-AEP-J, Divina-SAE-1, Divina-SAE-2, Divina-SAE-3, Divina-SAE-4, Divina-SAE-J, Dora, DPiu-1, Giada-1, Giada-2, Gloria-AEP-1, Gloria-AEP-2...(Other models you can see in the webshop) | | |



| | | | |
|--------------------|--|-----------------|-------|
| | | | |
| GEV No. | 532592 | Ref. No. | 12336 |
| description | O-ring Viton thickness 2mm ID \varnothing 50mm Qty 1 pcs | | |
| For models: | CMA, Sara-1GR-1, Sara-2GR-2 | | |

| | | | |
|--------------------|---|-----------------|-------|
| | | | |
| GEV No. | 526272 | Ref. No. | 12304 |
| description | O-ring HNBR thickness 3.53mm ID \varnothing 47.22mm Qty 1 pcs | | |

| | | | |
|--------------------|--|-----------------|-------|
| | | | |
| GEV No. | 528525 | Ref. No. | 12024 |
| description | O-ring Viton thickness 3.53mm ID \varnothing 18.64mm Qty 1 pcs | | |

| | | | |
|--------------------|--|-----------------|----------------------|
| | | | |
| GEV No. | 532552 | Ref. No. | 12300027 12336001 |
| description | O-ring HNBR thickness 4mm ID \varnothing 25mm Qty 1 pcs | | |
| For models: | Divina-AEP-1, Divina-AEP-2, Divina-AEP-3, Divina-AEP-4, Divina-AEP-J, Divina-SAE-1, Divina-SAE-2, Divina-SAE-3, Divina-SAE-4, Divina-SAE-J, Gloria-AEP-1, Gloria-AEP-2, Gloria-AEP-3, Gloria-AEP-4, Gloria-DISPLAY-LCL-2, Gloria-DISPLAY-LCL-3, Gloria-SAE-1, Gloria-SAE-2, Gloria-SAE-3, Gloria-SAE-4, Rapallo-AEP-1, Rapallo-AEP-2, Rapallo-AEP-3, Rapallo-AEP-4, Sibilla-AEP-1, Sibilla-AEP-2, Sibilla-AEP-3, Sibilla-DISPLAY-2, Sibilla-DISPLAY-3, Sibilla-SAE-1, Sibilla-SAE-2, Sibilla-SAE-3 | | |

| | | | |
|--------------------|---|-----------------|-------|
| <p>NBR</p> | | | |
| GEV No. | 532591 | Ref. No. | 12307 |
| description | O-ring NBR thickness 1.78mm ID \varnothing 6.75mm Qty 1 pcs | | |
| For models: | CMA, Giada-1, Giada-2, Sara-1GR-1, Sara-2GR-2 | | |

sealing washers

| | | | |
|----------------------|--|-----------------|-------|
| <p>fibre gaskets</p> | | | |
| GEV No. | 528312 | Ref. No. | 12158 |
| description | flat gasket FIBER ED \varnothing 26mm ID \varnothing 20mm thickness 2.5mm Qty 1 pcs | | |
| For models: | Argenta-AEP-1, Argenta-AEP-2, Argenta-AEP-3, Argenta-AEP-4, Argenta-AEP-J, Argenta-SAE-1, Argenta-SAE-2, Argenta-SAE-3, Argenta-SAE-4, Argenta-SAE-J, Brava, Brava-SME-1, Brava-SME-2, Brava-SME-3, Brava-SME-4, Brava-SMSA-1, Brava-SMSA-2, Brava-SMSA-3, Brava-SMSA-4, CK-CKE, CK-CKE-CK-1, CK-CKE-CKE-1, CKX-CKXE, CKX-CKXE-CKX-1, CKX-CKXE-CKXE-1, CMA, CompattaArgenta, Divina-AEP-1, Divina-AEP-2, Divina-AEP-3, Divina-AEP-4, Divina-AEP-J, Divina-SAE-1, Divina-SAE-2, Divina-SAE-3, Divina-SAE-4, Divina-SAE-J, Dora, Giada-1, Giada-2, Giada-Fridge-Cup-warmer-1, Gloria-AEP-1, Gloria-AEP-2, Gloria-AEP-3, Gloria-AEP-4, Gloria-DISPLAY-LCL-2, Gloria-DISPLAY-LCL-3, Gloria-SAE-1, Gloria-SAE-2, Gloria-SAE-3...(Other models you can see in the webshop) | | |

| | | | |
|--------------------|---|-----------------|-------|
| <p>HNBR</p> | | | |
| GEV No. | 526271 | Ref. No. | 12300 |
| description | O-ring HNBR thickness 2.62mm ID \varnothing 10.78mm Qty 1 pcs | | |

| | | | |
|--------------------|---|-----------------|-------|
| | | | |
| GEV No. | 506042 | Ref. No. | 12005 |
| description | flat gasket FIBER ED \varnothing 27mm ID \varnothing 17mm thickness 2mm Qty 1 pcs | | |
| For models: | Argenta, Argenta-AEP-1, Argenta-AEP-2, Argenta-AEP-3, Argenta-AEP-4, Argenta-AEP-J, Argenta-SAE-1, Argenta-SAE-2, Argenta-SAE-3, Argenta-SAE-4, Argenta-SAE-J, Brava-SME-1, Brava-SME-2, Brava-SME-3, Brava-SME-4, Brava-SMSA-1, Brava-SMSA-2, Brava-SMSA-3, Brava-SMSA-4, Denise, Divina, Divina-AEP-1, Divina-AEP-2, Divina-AEP-3, Divina-AEP-4, Divina-AEP-J, Divina-SAE-1, Divina-SAE-2, Divina-SAE-3, Divina-SAE-4, Divina-SAE-J, Gloria-AEP-1, Gloria-AEP-2, Gloria-AEP-3, Gloria-AEP-4, Gloria-DISPLAY-LCL-2, Gloria-DISPLAY-LCL-3, Gloria-SAE-1, Gloria-SAE-2, Gloria-SAE-3, Gloria-SAE-4 | | |

| | | | |
|--------------------|--|-----------------|-------|
| | | | |
| GEV No. | 526273 | Ref. No. | 12303 |
| description | O-ring HNBR thickness 2.62mm ID \varnothing 15.8mm Qty 1 pcs | | |
| For models: | Argenta, Argenta-AEP-1, Argenta-AEP-2, Argenta-AEP-3, Argenta-AEP-4, Argenta-AEP-J, Argenta-SAE-1, Argenta-SAE-2, Argenta-SAE-3, Argenta-SAE-4, Argenta-SAE-J, Brava, Brava-SME-1, Brava-SME-2, Brava-SME-3, Brava-SME-4, Brava-SMSA-1, Brava-SMSA-2, Brava-SMSA-3, Brava-SMSA-4, CK, CK-CKE, CK-CKE-CK-1, CK-CKE-CKE-1, CKE, CKP, CKPE, CKX-CKXE, CKX-CKXE-CKX-1, CKX-CKXE-CKXE-1, CMA, CompattaArgenta, Denise, Divina-AEP-1, Divina-AEP-2, Divina-AEP-3, Divina-AEP-4, Divina-AEP-J, Divina-SAE-1, Divina-SAE-2, Divina-SAE-3, Divina-SAE-4, Divina-SAE-J, Dora, Giada-1, Giada-2, Gloria-AEP-1, Gloria-AEP-2, Gloria-AEP-3, Gloria-AEP-4...(Other models you can see in the webshop) | | |

rubber gaskets

| | | | |
|---|--|-----------------|----------|
|  | | | |
| 1 | | | |
| GEV No. | 525781 | Ref. No. | 15117000 |
| description | flat gasket EPDM ED ø 40mm ID ø 34mm thickness 4mm Qty 1 pcs | | |
| For models: | DPIu-1, Giada-1, Giada-2, Sara-1GR-1, Sara-2GR-2 | | |

| | | | |
|---|--|-----------------|-------|
|  | | | |
| 1 | | | |
| GEV No. | 528308 | Ref. No. | 12203 |
| description | flat gasket rubber ED ø 15mm ID ø 4mm thickness 4mm Qty 1 pcs | | |
| For models: | Argenta, Argenta-AEP-1, Argenta-AEP-2, Argenta-AEP-3, Argenta-AEP-4, Argenta-AEP-J, Argenta-SAE-1, Argenta-SAE-2, Argenta-SAE-3, Argenta-SAE-4, Argenta-SAE-J, Brava, Brava-SME-1, Brava-SME-2, Brava-SME-3, Brava-SME-4, Brava-SMSA-1, Brava-SMSA-2, Brava-SMSA-3, Brava-SMSA-4, CK, CK-CKE, CK-CKE-CK-1, CK-CKE-CKE-1, CKE, CKP, CKPE, CKX-CKXE, CKX-CKXE-CKX-1, CKX-CKXE-CKXE-1, CMA, CompattaArgenta, Denise, Divina, Divina-AEP-1, Divina-AEP-2, Divina-AEP-3, Divina-AEP-4, Divina-AEP-J, Divina-SAE-1, Divina-SAE-2, Divina-SAE-3, Divina-SAE-4, Divina-SAE-J, Dora, Giada-1, Giada-2, Giada-Fridge-Cup-warmer-1, Gloria-AEP-1, Gloria-AEP-2... (Other models you can see in the webshop) | | |

| | | | |
|--|--|-----------------|----------|
|  | | | |
| 1 | | | |
| GEV No. | 528494 | Ref. No. | 27421010 |
| description | gasket rubber ED ø 13mm ID ø 4mm thickness 4mm Qty 1 pcs | | |

| | | | |
|---|--|-----------------|----------|
|  | | | |
| 1 | | | |
| GEV No. | 528495 | Ref. No. | 27421017 |
| description | gasket rubber ED ø 16mm ID ø 8mm thickness 4mm Qty 1 pcs | | |

copper gaskets

DIN-7603-A

| | | | |
|---|--|-----------------|-------|
|  | | | |
| 1 | | | |
| GEV No. | 525780 | Ref. No. | 12151 |
| description | flat gasket copper ED ø 13mm ID ø 10.2mm thickness 1.5mm for thread 1/8" Qty 1 pcs | | |
| For models: | Argenta, CK-CKE, CK-CKE-CK-1, CK-CKE-CKE-1, CKE, CKX-CKXE, CKX-CKXE-CKX-1, CKX-CKXE-CKXE-1, CMA, Denise, DPIu-1, Giada-1, Giada-2, Prima, Sara-1GR-1, Sara-2GR-2 | | |

| | | | |
|---|--|-----------------|-------|
|  | | | |
| 1 | | | |
| GEV No. | 529361 | Ref. No. | 12153 |
| description | flat gasket copper ED ø 18mm ID ø 13.5mm thickness 1.5mm for thread 1/4" | | |
| For models: | Argenta, Argenta-AEP-1, Argenta-AEP-2, Argenta-AEP-3, Argenta-AEP-4, Argenta-AEP-J, Argenta-SAE-1, Argenta-SAE-2, Argenta-SAE-3, Argenta-SAE-4, Argenta-SAE-J, Brava, Brava-SME-1, Brava-SME-2, Brava-SME-3, Brava-SME-4, Brava-SMSA-1, Brava-SMSA-2, Brava-SMSA-3, Brava-SMSA-4, CK, CK-CKE, CK-CKE-CK-1, CK-CKE-CKE-1, CKE, CKP, CKPE, CKX-CKXE, CKX-CKXE-CKX-1, CKX-CKXE-CKXE-1, CMA, CompattaArgenta, Denise, Divina, Divina-AEP-1, Divina-AEP-2, Divina-AEP-3, Divina-AEP-4, Divina-AEP-J, Divina-SAE-1, Divina-SAE-2, Divina-SAE-3, Divina-SAE-4, Divina-SAE-J, Dora, DPIu-1, Giada-1, Giada-2, Giada-Fridge-Cup-warmer-1, Gloria-AEP-1... (Other models you can see in the webshop) | | |

| | | | |
|---|--|-----------------|-------|
|  | | | |
| 1 | | | |
| GEV No. | 560331 | Ref. No. | 12154 |
| description | flat gasket copper ED ø 22mm ID ø 18mm thickness 1.5mm Qty 1 pcs | | |
| For models: | Argenta, Argenta-AEP-1, Argenta-AEP-2, Argenta-AEP-3, Argenta-AEP-4, Argenta-AEP-J, Argenta-SAE-1, Argenta-SAE-2, Argenta-SAE-3, Argenta-SAE-4, Argenta-SAE-J, Brava, Brava-SME-1, Brava-SME-2, Brava-SME-3, Brava-SME-4, Brava-SMSA-1, Brava-SMSA-2, Brava-SMSA-3, Brava-SMSA-4, CK-CKE, CK-CKE-CK-1, CK-CKE-CKE-1, CKP, CKPE, CKX-CKXE, CKX-CKXE-CKX-1, CKX-CKXE-CKXE-1, CMA, CompattaArgenta, Denise, Divina, Divina-AEP-1, Divina-AEP-2, Divina-AEP-3, Divina-AEP-4, Divina-AEP-J, Divina-SAE-1, Divina-SAE-2, Divina-SAE-3, Divina-SAE-4, Divina-SAE-J, Dora, Giada-1, Giada-2, Gloria-AEP-1, Gloria-AEP-2, Gloria-AEP-3, Gloria-AEP-4, Gloria-DISPLAY-LCL-2... (Other models you can see in the webshop) | | |

| | | | |
|---|--|-----------------|-------|
|  | | | |
| 1 | | | |
| GEV No. | 527161 | Ref. No. | 12158 |
| description | flat gasket copper ED ø 25.8mm ID ø 20.4mm thickness 2mm | | |

| | | | |
|---|--|-----------------|-------|
|  | | | |
| 1 | | | |
| GEV No. | 527157 | Ref. No. | 12150 |
| description | flat gasket copper ED ø 25mm ID ø 18mm thickness 2mm | | |
| For models: | Argenta, Argenta-AEP-1, Argenta-AEP-2, Argenta-AEP-3, Argenta-AEP-4, Argenta-AEP-J, Argenta-SAE-1, Argenta-SAE-2, Argenta-SAE-3, Argenta-SAE-4, Argenta-SAE-J, Brava, Brava-SME-1, Brava-SME-2, Brava-SME-3, Brava-SME-4, Brava-SMSA-1, Brava-SMSA-2, Brava-SMSA-3, Brava-SMSA-4, CompattaArgenta, Denise, Divina, Divina-AEP-1, Divina-AEP-2, Divina-AEP-3, Divina-AEP-4, Divina-AEP-J, Divina-SAE-1, Divina-SAE-2, Divina-SAE-3, Divina-SAE-4, Divina-SAE-J, Dora, Gloria-AEP-1, Gloria-AEP-2, Gloria-AEP-3, Gloria-AEP-4, Gloria-DISPLAY-LCL-2, Gloria-DISPLAY-LCL-3, Gloria-SAE-1, Gloria-SAE-2, Gloria-SAE-3, Gloria-SAE-4, Rapallo-AEP-1, Rapallo-AEP-2, Rapallo-AEP-3, Rapallo-AEP-4, Rapallo-AL-1, Rapallo-AL-2... (Other models you can see in the webshop) | | |





| DIN-7603-C | | | |
|---|--|-----------------|-------|
|  | | | |
| 1 | | | |
| GEV No. | 527815 | Ref. No. | 12100 |
| description | gasket copper ED ø 18.7mm ID ø 13.2mm thickness 2.5mm for coffee makers | | |
| For models: | Divina-AEP-1, Divina-AEP-2, Divina-AEP-3, Divina-AEP-4, Divina-AEP-J, Divina-SAE-1, Divina-SAE-2, Divina-SAE-3, Divina-SAE-4, Divina-SAE-J, Giada-1, Giada-2, Gloria-AEP-1, Gloria-AEP-2, Gloria-AEP-3, Gloria-AEP-4, Gloria-DISPLAY-LCL-2, Gloria-DISPLAY-LCL-3, Gloria-SAE-1, Gloria-SAE-2, Gloria-SAE-3, Gloria-SAE-4, Sara-1GR-1, Sara-2GR-2 | | |

| | | | |
|---|--|-----------------|-------|
|  | | | |
| 1 | | | |
| GEV No. | 527164 | Ref. No. | 12101 |
| description | gasket copper ED ø 23mm ID ø 17mm thickness 3mm for thread 3/8" | | |
| For models: | Argenta, Argenta-AEP-1, Argenta-AEP-2, Argenta-AEP-3, Argenta-AEP-4, Argenta-AEP-J, Argenta-SAE-1, Argenta-SAE-2, Argenta-SAE-3, Argenta-SAE-4, Argenta-SAE-J, Brava, Brava-SME-1, Brava-SME-2, Brava-SME-3, Brava-SME-4, Brava-SMSA-1, Brava-SMSA-2, Brava-SMSA-3, Brava-SMSA-4, CK, CK-CKE, CK-CKE-CK-1, CK-CKE-CKE-1, CKE, CKP, CKPE, CKX-CKXE, CKX-CKXE-CKX-1, CKX-CKXE-CKXE-1, CMA, CompattaArgenta, Denise, Divina, Divina-AEP-1, Divina-AEP-2, Divina-AEP-3, Divina-AEP-4, Divina-AEP-J, Divina-SAE-1, Divina-SAE-2, Divina-SAE-3, Divina-SAE-4, Divina-SAE-J, Dora, Giada-1, Giada-2, Gloria-AEP-1, Gloria-AEP-2, Gloria-AEP-3...(Other models you can see in the webshop) | | |

| | | | |
|---|---|-----------------|-------|
|  | | | |
| 1 | | | |
| GEV No. | 528838 | Ref. No. | 12102 |
| description | gasket copper ED ø 24mm ID ø 18mm thickness 2.5mm | | |
| For models: | Argenta, Brava, Denise, Divina, Dora, Rapallo-AL-1, Rapallo-AL-2, Rapallo-AL-3, Rapallo-AL-4, Vania | | |

| | | | |
|---|---|-----------------|-------|
|  | | | |
| 1 | | | |
| GEV No. | 529360 | Ref. No. | 12105 |
| description | gasket copper ED ø 26.1mm ID ø 21mm thickness 2.1mm for thread 1/2" | | |
| For models: | CMA, CompattaArgenta, Giada-1, Giada-2, Sara-1GR-1, Sara-2GR-2 | | |

| | | | |
|---|---|-----------------|----------|
|  | | | |
| 1 | | | |
| GEV No. | 528508 | Ref. No. | 27421009 |
| description | gasket copper ED ø 26mm ID ø 20mm thickness 3mm | | |

| | | | |
|---|---|-----------------|-------|
|  | | | |
| 1 | | | |
| GEV No. | 527167 | Ref. No. | 12103 |
| description | gasket copper ED ø 9.8mm ID ø 6.5mm thickness 1.7mm | | |

| PTFE gaskets | | | |
|---|--|-----------------|----------|
|  | | | |
| 1 | | | |
| GEV No. | 528179 | Ref. No. | 12012001 |
| description | flat gasket PTFE ED ø 15mm ID ø 11mm thickness 2mm Qty 1 pcs equiv. no. 12012001 suitable for ASTORIA | | |
| For models: | Divina, Divina-AEP-1, Divina-AEP-2, Divina-AEP-3, Divina-AEP-4, Divina-AEP-J, Divina-SAE-1, Divina-SAE-2, Divina-SAE-3, Divina-SAE-4, Divina-SAE-J, Gloria-AEP-1, Gloria-AEP-2, Gloria-AEP-3, Gloria-AEP-4, Gloria-DISPLAY-LCL-2, Gloria-DISPLAY-LCL-3, Gloria-SAE-1, Gloria-SAE-2, Gloria-SAE-3, Gloria-SAE-4 | | |

| | | | |
|---|---|-----------------|-------|
|  | | | |
| 1 | | | |
| GEV No. | 528314 | Ref. No. | 12010 |
| description | flat gasket PTFE ED ø 20mm ID ø 17mm thickness 2mm Qty 1 pcs suitable for Astoria/Azkoyen/Espresso/Wega | | |
| For models: | Argenta, Argenta-AEP-1, Argenta-AEP-2, Argenta-AEP-3, Argenta-AEP-4, Argenta-AEP-J, Argenta-SAE-1, Argenta-SAE-2, Argenta-SAE-3, Argenta-SAE-4, Argenta-SAE-J, Brava, Brava-SME-1, Brava-SME-2, Brava-SME-3, Brava-SME-4, Brava-SMSA-1, Brava-SMSA-2, Brava-SMSA-3, Brava-SMSA-4, CK, CK-CKE, CK-CKE-CK-1, CK-CKE-CKE-1, CKE, CKP, CKPE, CKX-CKXE, CKX-CKXE-CKX-1, CKX-CKXE-CKXE-1, CMA, CompattaArgenta, Denise, Divina, Divina-AEP-1, Divina-AEP-2, Divina-AEP-3, Divina-AEP-4, Divina-AEP-J, Divina-SAE-1, Divina-SAE-2, Divina-SAE-3, Divina-SAE-4, Divina-SAE-J, Dora, Giada-1, Giada-2, Giada-Fridge-Cup-warmer-1, Gloria-AEP-1, Gloria-AEP-2...(Other models you can see in the webshop) | | |

| | | | |
|---|--|-----------------|-------|
|  | | | |
| 1 | | | |
| GEV No. | 527154 | Ref. No. | 12025 |
| description | flat gasket PTFE ED ø 22mm ID ø 16.8mm thickness 2mm Qty 1 pcs | | |

| | | | |
|---|--|-----------------|-------|
|  | | | |
| 1 | | | |
| GEV No. | 528945 | Ref. No. | 12025 |
| description | flat gasket PTFE ED ø 22mm ID ø 16mm thickness 1.5mm Qty 1 pcs equiv. no. W10309 suitable for ESPRESSA, WEGA | | |

| | | | |
|---|--|-----------------|----------|
|  | | | |
| 1 | | | |
| GEV No. | 528683 | Ref. No. | 27421009 |
| description | flat gasket PTFE ED ø 26mm ID ø 21mm thickness 2mm Qty 1 pcs suitable for GAGGIA, SPAZIALE | | |



| | | | |
|--------------------|--|-----------------|-------|
| GEV No. | 528524 | Ref. No. | 12023 |
| description | flat gasket PTFE ED ø 36.5mm ID ø 30.5mm thickness 2mm Qty 1 pcs | | |



| | | | |
|--------------------|--|-----------------|-------|
| GEV No. | 527162 | Ref. No. | 12023 |
| description | flat gasket PTFE ED ø 36mm ID ø 30mm thickness 3mm Qty 1 pcs | | |



| | | | |
|--------------------|--|-----------------|-------|
| GEV No. | 528022 | Ref. No. | 12017 |
| description | flat gasket PTFE ED ø 52mm ID ø 41mm thickness 2mm size 1¼" Qty 1 pcs suitable for CARIMALI, FAEMA, MARZOCCO, PAVONI | | |
| For models: | CompattaArgenta | | |



| | | | |
|--------------------|--|-----------------|-------|
| GEV No. | 527156 | Ref. No. | 12001 |
| description | flat gasket PTFE ED ø 57.8mm ID ø 43.3mm thickness 2mm Qty 1 pcs | | |



| | | | |
|--------------------|---|-----------------|-------|
| GEV No. | 528002 | Ref. No. | 12001 |
| description | flat gasket PTFE ED ø 57mm ID ø 42mm thickness 3mm Qty 1 pcs equiv. no. 12001/W10470 suitable for | | |
| For models: | Argenta, Argenta-AEP-1, Argenta-AEP-2, Argenta-AEP-3, Argenta-AEP-4, Argenta-AEP-J, Argenta-SAE-1, Argenta-SAE-2, Argenta-SAE-3, Argenta-SAE-4, Argenta-SAE-J, Brava, Brava-SME-1, Brava-SME-2, Brava-SME-3, Brava-SME-4, Brava-SMSA-1, Brava-SMSA-2, Brava-SMSA-3, Brava-SMSA-4, CK, CK-CKE, CK-CKE-CK-1, CK-CKE-CKE-1, CKE, CKP, CKPE, CKX-CKXE, CKX-CKXE-CKX-1, CKX-CKXE-CKXE-1, CMA, Denise, Divina, Divina-AEP-1, Divina-AEP-2, Divina-AEP-3, Divina-AEP-4, Divina-AEP-J, Divina-SAE-1, Divina-SAE-2, Divina-SAE-3, Divina-SAE-4, Divina-SAE-J, Dora, Giada-1, Giada-2, Gloria-AEP-1, Gloria-AEP-2, Gloria-AEP-3, Gloria-AEP-4...(Other models you can see in the webshop) | | |

Viton gaskets



| | | | |
|--------------------|--|-----------------|----------|
| GEV No. | 528476 | Ref. No. | 27421008 |
| description | flat gasket Viton ED ø 13mm ID ø 4mm thickness 4mm Qty 1 pcs | | |



| | | | |
|--------------------|---|-----------------|----------|
| GEV No. | 527803 | Ref. No. | 27421008 |
| description | gasket Viton ED ø 13mm ID ø 4mm thickness 4mm Qty 1 pcs | | |

special gaskets

group gaskets



| | | | |
|--------------------|---|-----------------|-------|
| GEV No. | 528102 | Ref. No. | 12002 |
| description | gasket D1 ø 40mm D2 ø 88mm thickness 2mm hole distance 68mm PTFE | | |
| For models: | Argenta, Argenta-AEP-1, Argenta-AEP-2, Argenta-AEP-3, Argenta-AEP-4, Argenta-AEP-J, Argenta-SAE-1, Argenta-SAE-2, Argenta-SAE-3, Argenta-SAE-4, Argenta-SAE-J, Brava, Brava-SME-1, Brava-SME-2, Brava-SME-3, Brava-SME-4, Brava-SMSA-1, Brava-SMSA-2, Brava-SMSA-3, Brava-SMSA-4, Denise, Divina, Dora, Rapallo-AEP-1, Rapallo-AEP-2, Rapallo-AEP-3, Rapallo-AEP-4, Rapallo-AL-1, Rapallo-AL-2, Rapallo-AL-3, Rapallo-AL-4, Sibilla-AEP-1, Sibilla-AEP-2, Sibilla-AEP-3, Sibilla-DISPLAY-2, Sibilla-DISPLAY-3, Sibilla-SAE-1, Sibilla-SAE-2, Sibilla-SAE-3, Vania | | |



| | | | |
|--------------------|---|-----------------|-------|
| GEV No. | 529270 | Ref. No. | 12201 |
| description | gasket ED ø 52mm H 7mm rubber int. ø 1 38mm | | |
| For models: | Argenta, Denise, Divina, Rapallo-AL-1, Rapallo-AL-2, Rapallo-AL-3, Rapallo-AL-4 | | |

springs
compression springs

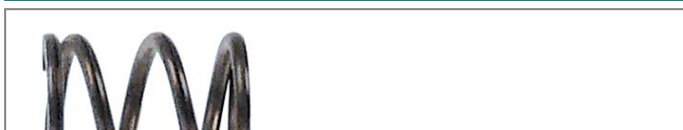

| | | | |
|--------------------|---|-----------------|-------|
| GEV No. | 529719 | Ref. No. | 10452 |
| description | compression spring ø 11.3mm L 16mm wire gauge ø 1.5mm for steam-/water-tap for espresso machine | | |
| For models: | Argenta, Argenta-AEP-1, Argenta-AEP-2, Argenta-AEP-3, Argenta-AEP-4, Argenta-AEP-J, Argenta-SAE-1, Argenta-SAE-2, Argenta-SAE-3, Argenta-SAE-4, Argenta-SAE-J, Brava, Brava-SME-1, Brava-SME-2, Brava-SME-3, Brava-SME-4, Brava-SMSA-1, Brava-SMSA-2, Brava-SMSA-3, Brava-SMSA-4, CK, CK-CKE, CK-CKE-CK-1, CK-CKE-CKE-1, CKE, CKP, CKPE, CKX-CKXE, CKX-CKXE-CKX-1, CKX-CKXE-CKXE-1, CMA, CompattaArgenta, Denise, Divina, Divina-AEP-1, Divina-AEP-2, Divina-AEP-3, Divina-AEP-4, Divina-AEP-J, Divina-SAE-1, Divina-SAE-2, Divina-SAE-3, Divina-SAE-4, Divina-SAE-J, Dora, Giada-1, Giada-2, Giada-Fridge-Cup-warmer-1, Gloria-AEP-1, Gloria-AEP-2...(Other models you can see in the webshop) | | |





| | | | |
|---|---|-----------------|-------|
|  | | | |
| 1 | | | |
| GEV No. | 529735 | Ref. No. | 10465 |
| description | compression spring ø 11.3mm L 18mm wire gauge ø 1.5mm | | |
| For models: | Divina, Divina-AEP-1, Divina-AEP-2, Divina-AEP-3, Divina-AEP-4, Divina-AEP-J, Divina-SAE-1, Divina-SAE-2, Divina-SAE-3, Divina-SAE-4, Divina-SAE-J, Giada-1, Giada-2, Giada-Fridge-Cup-warmer-1, Gloria-AEP-1, Gloria-AEP-2, Gloria-AEP-3, Gloria-AEP-4, Gloria-DISPLAY-LCL-2, Gloria-DISPLAY-LCL-3, Gloria-SAE-1, Gloria-SAE-2, Gloria-SAE-3, Gloria-SAE-4, Sara-1GR-1, Sara-2GR-2, Sara-Fridge-Cup-warmer | | |

| | | | |
|---|---|-----------------|----------|
|  | | | |
| 1 | | | |
| GEV No. | 528526 | Ref. No. | 27421001 |
| description | compression spring ø 12.9mm L 41mm wire gauge ø 1.2mm | | |

| | | | |
|---|---|-----------------|----------|
|  | | | |
| 1 | | | |
| GEV No. | 528533 | Ref. No. | 27421002 |
| description | compression spring ø 14.6mm L 43mm wire gauge ø 1.4mm | | |

| | | | |
|--|---|-----------------|----------|
|  | | | |
| 1 | | | |
| GEV No. | 528475 | Ref. No. | 27421003 |
| description | compression spring ø 14.7mm L 33mm wire gauge ø 2mm | | |

| | | | |
|---|---|-----------------|-------|
|  | | | |
| 1 | | | |
| GEV No. | 528311 | Ref. No. | 10451 |
| description | compression spring ø 14mm L 39mm wire gauge ø 2.8mm | | |
| For models: | Argenta, Argenta-AEP-1, Argenta-AEP-2, Argenta-AEP-3, Argenta-AEP-4, Argenta-AEP-J, Argenta-SAE-1, Argenta-SAE-2, Argenta-SAE-3, Argenta-SAE-4, Argenta-SAE-J, Brava, Brava-SME-1, Brava-SME-2, Brava-SME-3, Brava-SME-4, Brava-SMSA-1, Brava-SMSA-2, Brava-SMSA-3, Brava-SMSA-4, CompattaArgenta, Denise, Divina, Divina-AEP-1, Divina-AEP-2, Divina-AEP-3, Divina-AEP-4, Divina-AEP-J, Divina-SAE-1, Divina-SAE-2, Divina-SAE-3, Divina-SAE-4, Divina-SAE-J, Dora, Gloria-AEP-1, Gloria-AEP-2, Gloria-AEP-3, Gloria-AEP-4, Gloria-DISPLAY-LCL-2, Gloria-DISPLAY-LCL-3, Gloria-SAE-1, Gloria-SAE-2, Gloria-SAE-3, Gloria-SAE-4, Rapallo-AEP-1, Rapallo-AEP-2, Rapallo-AEP-3, Rapallo-AEP-4, Rapallo-AL-1, Rapallo-AL-2...(Other models you can see in the webshop) | | |

| | | | |
|--|--|-----------------|----------|
|  | | | |
| 1 | | | |
| GEV No. | 528542 | Ref. No. | 27421004 |
| description | compression spring ø 15mm L 27mm wire gauge ø 1.8mm windings 5 | | |

| | | | |
|--|---|-----------------|-------|
|  | | | |
| 1 | | | |
| GEV No. | 528536 | Ref. No. | 27250 |
| description | spring ø 48mm L 133mm wire gauge ø 8.5mm for coffee machine | | |
| For models: | Argenta, Brava, Denise, Divina, Dora, Rapallo-AL-1, Rapallo-AL-2, Rapallo-AL-3, Rapallo-AL-4, Vania | | |

coffee accessories

milk foamers

milk foamers

| | | | |
|---|-------------|-----------------|-----------|
|  | | | |
| 1 | | | |
| GEV No. | 802108 | Ref. No. | 83300000R |
| description | milk foamer | | |

| | | | |
|--|-------------------------------------|-----------------|-----------|
|  | | | |
| 1 | | | |
| GEV No. | 802137 | Ref. No. | 83300012R |
| description | milk foamer connection 3/8" plastic | | |

| | | | |
|---|--|-----------------|----------|
|  | | | |
| 1 | | | |
| GEV No. | 802100 | Ref. No. | 30515003 |
| description | milk foamer connection 6mm angle 60° plastic | | |

manometers

| | | | |
|---|---|-----------------|-----|
|  | | | |
| 1 | | | |
| GEV No. | 541233 | Ref. No. | N/A |
| description | manometer double scale ø 60mm pressure range 0-2.5 / 0-15bar connection on the backside thread 1/8" | | |

| | | | |
|--|---|-----------------|-----|
|  | | | |
| 1 | | | |
| GEV No. | 541287 | Ref. No. | N/A |
| description | manometer double scale ø 60mm pressure range 0-2.5 / 0-15bar connection on the backside thread 1/8" | | |

| | | | |
|---|---|-----------------|-----|
|  | | | |
| 1 | | | |
| GEV No. | 541222 | Ref. No. | N/A |
| description | manometer double scale ø 60mm pressure range 0-2.5 / 0-16bar connection on the backside thread 1/8" | | |

| | | | |
|---|---|-----------------|----------------|
|  | | | |
| 1 | | | |
| GEV No. | 541223 | Ref. No. | 21100 21104 |
| description | manometer double scale ø 60mm pressure range 0-2.5 / 0-16bar connection on the backside thread 1/8" | | |

| | | | |
|--|--|-----------------|----------------|
|  | | | |
| 1 | | | |
| GEV No. | 541226 | Ref. No. | 21100 21104 |
| description | manometer double scale ø 60mm pressure range 0-2.5 / 0-16bar connection on the backside thread 1/8" | | |
| For models: | Argenta, Argenta-AEP-1, Argenta-AEP-2, Argenta-AEP-3, Argenta-AEP-4, Argenta-AEP-J, Argenta-SAE-1, Argenta-SAE-2, Argenta-SAE-3, Argenta-SAE-4, Argenta-SAE-J, CompattaArgenta, Dora | | |

| | | | |
|--|---|-----------------|-----|
|  | | | |
| 1 | | | |
| GEV No. | 541227 | Ref. No. | N/A |
| description | manometer double scale ø 60mm pressure range 0-2.5 / 0-16bar connection on the backside thread 1/8" | | |

| | | | |
|---|---|-----------------|-------|
|  | | | |
| 1 | | | |
| GEV No. | 541263 | Ref. No. | 21109 |
| description | manometer double scale ø 63mm pressure range 0-2.5 / 0-16bar connection on the backside thread 1/8" | | |

| | | | |
|--|--|-----------------|-------|
|  | | | |
| 1 | | | |
| GEV No. | 541266 | Ref. No. | 21109 |
| description | manometer double scale ø 63mm pressure range 0-2.5 / 0-16bar connection on the backside thread 1/8" | | |
| For models: | CMA, Denise, Divina, Divina-AEP-1, Divina-AEP-2, Divina-AEP-3, Divina-AEP-4, Divina-AEP-J, Divina-SAE-1, Divina-SAE-2, Divina-SAE-3, Divina-SAE-4, Divina-SAE-J, Giada-1, Giada-2, Sara-1GR-1, Sara-2GR-2, Vania | | |

| | | | |
|--|---|-----------------|---------|
|  | | | |
| 1 | | | |
| GEV No. | 541279 | Ref. No. | CON..80 |
| description | manometer double scale ø 63mm pressure range 0-2.5 / 0-25bar connection on the backside thread 1/8" | | |



| | | | |
|--|---|-----------------|----------------|
|  <p>1</p> | | | |
| GEV No. | 541262 | Ref. No. | 21112 21115 |
| description | manometer double scale ø 63mm pressure range 0-3 / 0-15bar connection on the backside thread 1/8" | | |
| For models: | Brava, Brava-SME-1, Brava-SME-2, Brava-SME-3, Brava-SME-4, Brava-SMSA-1, Brava-SMSA-2, Brava-SMSA-3, Brava-SMSA-4, Gloria-AEP-1, Gloria-AEP-2, Gloria-AEP-3, Gloria-AEP-4, Gloria-DISPLAY-LCL-2, Gloria-DISPLAY-LCL-3, Gloria-SAE-1, Gloria-SAE-2, Gloria-SAE-3, Gloria-SAE-4, Rapallo-AEP-1, Rapallo-AEP-2, Rapallo-AEP-3, Rapallo-AEP-4, Rapallo-AL-1, Rapallo-AL-2, Rapallo-AL-3, Rapallo-AL-4, Sibilla-AEP-1, Sibilla-AEP-2, Sibilla-AEP-3, Sibilla-DISPLAY-2, Sibilla-DISPLAY-3, Sibilla-SAE-1, Sibilla-SAE-2, Sibilla-SAE-3 | | |

| | | | |
|--|--|-----------------|-------|
|  <p>1</p> | | | |
| GEV No. | 541261 | Ref. No. | 21105 |
| description | manometer ø 44mm pressure range 0 up to 2.5bar thread 1/8" connection on the backside | | |
| For models: | CK-CKE, CK-CKE-CK-1, CK-CKE-CKE-1, CKE, CKP, CKX-CKXE, CKX-CKXE-CKX-1, CKX-CKXE-CKXE-1 | | |

| | | | |
|--|---|-----------------|-------|
|  <p>1</p> | | | |
| GEV No. | 541225 | Ref. No. | 21101 |
| description | manometer ø 51mm pressure range 0 up to 3bar thread 1/4" marking 2 connection on the backside | | |
| For models: | Argenta, Argenta-AEP-1, Argenta-AEP-2, Argenta-AEP-3, Argenta-AEP-4, Argenta-AEP-J, Argenta-SAE-1, Argenta-SAE-2, Argenta-SAE-3, Argenta-SAE-4, Argenta-SAE-J, Dora | | |

| | | | |
|--|---|-----------------|-------|
|  <p>1</p> | | | |
| GEV No. | 541668 | Ref. No. | 21113 |
| description | manometer pressure range 3bar ø 63mm connection 1/4" | | |
| For models: | Brava, Brava-SME-1, Brava-SME-2, Brava-SME-3, Brava-SME-4, Brava-SMSA-1, Brava-SMSA-2, Brava-SMSA-3, Brava-SMSA-4, Gloria-AEP-1, Gloria-AEP-2, Gloria-AEP-3, Gloria-AEP-4, Gloria-DISPLAY-LCL-2, Gloria-DISPLAY-LCL-3, Gloria-SAE-1, Gloria-SAE-2, Gloria-SAE-3, Gloria-SAE-4, Rapallo-AEP-1, Rapallo-AEP-2, Rapallo-AEP-3, Rapallo-AEP-4, Rapallo-AL-1, Rapallo-AL-2, Rapallo-AL-3, Rapallo-AL-4 | | |

dosing pumps

peristaltic dosing pumps

SEKO

wall-mounted version

without control

| | | | |
|---|--|-----------------|----------|
|  <p>1</p> | | | |
| GEV No. | 361823 | Ref. No. | 26319001 |
| description | dosing pump without control 18l/h 230VAC detergent hose ø 6.5mm hose type I hose Santoprene suction level 1.5m type PE 18 10W cable length 600mm wall-mounted version dimensions 103x82x92mm CODE PPE0018A1002 | | |
| For models: | Giada-1, Giada-2, Gloria-AEP-1, Gloria-AEP-2, Gloria-AEP-3, Gloria-AEP-4, Gloria-DISPLAY-LCL-2, Gloria-DISPLAY-LCL-3, Gloria-SAE-1, Gloria-SAE-2, Gloria-SAE-3, Gloria-SAE-4, Sara-1GR-1, Sara-2GR-2 | | |

spare parts

| | | | |
|--|--|-----------------|----------------------|
|  <p>1</p> | | | |
| GEV No. | 361824 | Ref. No. | 28000200 28000205 |
| description | pump hose rinse aid hose ø 6x10mm hose length 137mm hose ø 6mm hose type silicone | | |
| For models: | Giada-1, Giada-2, Gloria-AEP-1, Gloria-AEP-2, Gloria-AEP-3, Gloria-AEP-4, Gloria-DISPLAY-LCL-2, Gloria-DISPLAY-LCL-3, Gloria-SAE-1, Gloria-SAE-2, Gloria-SAE-3, Gloria-SAE-4, Sara-1GR-1, Sara-2GR-2 | | |



hoses

supply hoses

stainless steel flexi hoses

universal hoses



| | | | |
|--------------------|---|-----------------|-------|
| GEV No. | 520256 | Ref. No. | 30403 |
| description | flex hose SS braid straight-straight DN8 connections 3/8" L 330mm conical seal approval DVGW operating p. 10bar test pressure 32bar burst p. 95bar | | |
| For models: | Argenta, Argenta-AEP-1, Argenta-AEP-2, Argenta-AEP-3, Argenta-AEP-4, Argenta-AEP-J, Argenta-SAE-1, Argenta-SAE-2, Argenta-SAE-3, Argenta-SAE-4, Argenta-SAE-J, Brava, Brava-SME-1, Brava-SME-2, Brava-SME-3, Brava-SME-4, Brava-SMSA-1, Brava-SMSA-2, Brava-SMSA-3, Brava-SMSA-4, CK-CKE-CK-1, CK-CKE-CKE-1, CKX-CKXE-CKX-1, CKX-CKXE-CKXE-1, CompattaArgenta, Denise, Divina, Divina-AEP-1, Divina-AEP-2, Divina-AEP-3, Divina-AEP-4, Divina-AEP-J, Divina-SAE-1, Divina-SAE-2, Divina-SAE-3, Divina-SAE-4, Divina-SAE-J, Dora, Giada-1, Giada-2, Gloria-AEP-1, Gloria-AEP-2, Gloria-AEP-3, Gloria-AEP-4, Gloria-DISPLAY-LCL-2, Gloria-DISPLAY-LCL-3, Gloria-SAE-1, Gloria-SAE-2, Gloria-SAE-3, Gloria-SAE-4...(Other models you can see in the webshop) | | |

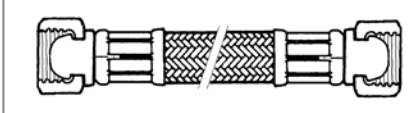
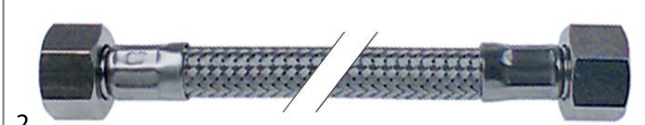

| | | | |
|--------------------|--|-----------------|-------|
| GEV No. | 520299 | Ref. No. | 30404 |
| description | flex hose SS braid straight-straight DN8 connections 3/8" L 450mm conical seal approval DVGW operating p. 10bar test pressure 32bar burst p. 95bar | | |

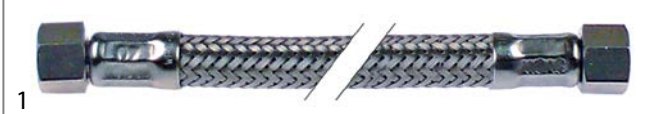

| | | | |
|--------------------|---|-----------------|-------|
| GEV No. | 520572 | Ref. No. | 30404 |
| description | flex hose SS braid straight-straight DN8 connections 3/8" L 500mm conical seal approval DVGW operating p. 10bar test pressure 32bar burst p. 95bar | | |
| For models: | Argenta, Argenta-AEP-1, Argenta-AEP-2, Argenta-AEP-3, Argenta-AEP-4, Argenta-AEP-J, Argenta-SAE-1, Argenta-SAE-2, Argenta-SAE-3, Argenta-SAE-4, Argenta-SAE-J, Brava, Brava-SME-1, Brava-SME-2, Brava-SME-3, Brava-SME-4, Brava-SMSA-1, Brava-SMSA-2, Brava-SMSA-3, Brava-SMSA-4, CK-CKE-CK-1, CK-CKE-CKE-1, CKX-CKXE-CKX-1, CKX-CKXE-CKXE-1, CompattaArgenta, Denise, Divina, Divina-AEP-1, Divina-AEP-2, Divina-AEP-3, Divina-AEP-4, Divina-AEP-J, Divina-SAE-1, Divina-SAE-2, Divina-SAE-3, Divina-SAE-4, Divina-SAE-J, Dora, Gloria-AEP-1, Gloria-AEP-2, Gloria-AEP-3, Gloria-AEP-4, Gloria-DISPLAY-LCL-2, Gloria-DISPLAY-LCL-3, Gloria-SAE-1, Gloria-SAE-2, Gloria-SAE-3, Gloria-SAE-4, Rapallo-AEP-1, Rapallo-AEP-2...(Other models you can see in the webshop) | | |

industrial hoses

hoses wire reinforced

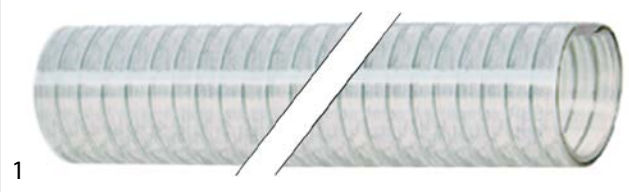

| | | | |
|--------------------|--|-----------------|-------|
| GEV No. | 520036 | Ref. No. | 15470 |
| description | drain hose ID ø 16mm ED ø 21mm L 30m wire reinforced | | |

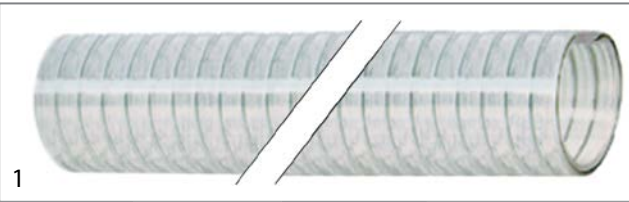

| | | | |
|--------------------|--|-----------------|-------|
| GEV No. | 520072 | Ref. No. | 15470 |
| description | drain hose ID ø 16mm ED ø 21mm L 5m wire reinforced | | |
| For models: | Argenta, Argenta-AEP-1, Argenta-AEP-2, Argenta-AEP-3, Argenta-AEP-4, Argenta-AEP-J, Argenta-SAE-1, Argenta-SAE-2, Argenta-SAE-3, Argenta-SAE-4, Argenta-SAE-J, Brava, Brava-SME-1, Brava-SME-2, Brava-SME-3, Brava-SME-4, Brava-SMSA-1, Brava-SMSA-2, Brava-SMSA-3, Brava-SMSA-4, CK, CK-CKE, CK-CKE-CK-1, CK-CKE-CKE-1, CKE, CKP, CKPE, CKX-CKXE, CKX-CKXE-CKX-1, CKX-CKXE-CKXE-1, CMA, CompattaArgenta, Denise, Divina, Divina-AEP-1, Divina-AEP-2, Divina-AEP-3, Divina-AEP-4, Divina-AEP-J, Divina-SAE-1, Divina-SAE-2, Divina-SAE-3, Divina-SAE-4, Divina-SAE-J, Dora, Giada-1, Giada-2, Gloria-AEP-1, Gloria-AEP-2, Gloria-AEP-3...(Other models you can see in the webshop) | | |

fittings, hose and pipe connectors

fittings

double nipples



| | | | |
|--------------------|--|-----------------|-------|
| GEV No. | 527193 | Ref. No. | 23210 |
| description | double nipple brass thread 1/8" - 1/8" | | |
| For models: | Argenta, CK, CK-CKE, CK-CKE-CK-1, CK-CKE-CKE-1, CKE, CKP, CKPE, CKX-CKXE, CKX-CKXE-CKX-1, CKX-CKXE-CKXE-1, Denise, DPiu-1, Giada-1, Giada-2, Prima, Sara-1GR-1, Sara-2GR-2 | | |

reducers



1

| | | | |
|--------------------|---|-----------------|-------|
| GEV No. | 527207 | Ref. No. | 25743 |
| description | reducer thread 1/4" IT - 1/8" ET brass WS 17 | | |
| For models: | Argenta-AEP-1, Argenta-AEP-2, Argenta-AEP-3, Argenta-AEP-4, Argenta-AEP-J, Argenta-SAE-1, Argenta-SAE-2, Argenta-SAE-3, Argenta-SAE-4, Argenta-SAE-J, Brava, Brava-SME-1, Brava-SME-2, Brava-SME-3, Brava-SME-4, Brava-SMSA-1, Brava-SMSA-2, Brava-SMSA-3, Brava-SMSA-4, CK, CK-CKE, CK-CKE-CK-1, CK-CKE-CKE-1, CKE, CKP, CKPE, CKX-CKXE, CKX-CKXE-CKX-1, CKX-CKXE-CKXE-1, Divina, Divina-AEP-1, Divina-AEP-2, Divina-AEP-3, Divina-AEP-4, Divina-AEP-J, Divina-SAE-1, Divina-SAE-2, Divina-SAE-3, Divina-SAE-4, Divina-SAE-J, Sibilla-AEP-1, Sibilla-AEP-2, Sibilla-AEP-3, Sibilla-DISPLAY-2, Sibilla-DISPLAY-3, Sibilla-SAE-1, Sibilla-SAE-2, Sibilla-SAE-3 | | |

T-pieces

miscellaneous



1

| | | | |
|--------------------|---|-----------------|----------|
| GEV No. | 527204 | Ref. No. | 43030001 |
| description | T-piece thread 3/8" ET - 3/8" IT - 1/4" IT L 31mm for filling valve WS 23 W 40mm brass | | |
| For models: | Argenta-AEP-1, Argenta-AEP-2, Argenta-AEP-3, Argenta-AEP-4, Argenta-AEP-J, Argenta-SAE-1, Argenta-SAE-2, Argenta-SAE-3, Argenta-SAE-4, Argenta-SAE-J, Brava, Brava-SME-1, Brava-SME-2, Brava-SME-3, Brava-SME-4, Brava-SMSA-1, Brava-SMSA-2, Brava-SMSA-3, Brava-SMSA-4, CompattaArgenta, Divina, Divina-AEP-1, Divina-AEP-2, Divina-AEP-3, Divina-AEP-4, Divina-AEP-J, Divina-SAE-1, Divina-SAE-2, Divina-SAE-3, Divina-SAE-4, Divina-SAE-J, Dora, Gloria-AEP-1, Gloria-AEP-2, Gloria-AEP-3, Gloria-AEP-4, Gloria-DISPLAY-LCL-2, Gloria-DISPLAY-LCL-3, Gloria-SAE-1, Gloria-SAE-2, Gloria-SAE-3, Gloria-SAE-4, Rapallo-AEP-1, Rapallo-AEP-2, Rapallo-AEP-3, Rapallo-AEP-4, Rapallo-AL-1, Rapallo-AL-2, Rapallo-AL-3, Rapallo-AL-4... (Other models you can see in the webshop) | | |

miscellaneous



1

| | | | |
|--------------------|--|-----------------|----------|
| GEV No. | 527250 | Ref. No. | 25691003 |
| description | connecting fitting L 29mm ID ø 8mm WS 22 brass thread 3/8" IT - 3/8" ET | | |
| For models: | CK, CK-CKE, CK-CKE-CK-1, CK-CKE-CKE-1, CKE, CKP, CKPE, CKX-CKXE, CKX-CKXE-CKX-1, CKX-CKXE-CKXE-1 | | |

water softeners

automatic softeners

with control Autotrol 366/604 (timer)



1















| | | | | |
|---|--|-----------------|-----------------|---|
| GEV No. | 530826 | Ref. No. | 26037005 | |
| description | softener automatic type ISI8 container capacity 8l amount of resin 5.6l salt amount/regeneration 1kg capacity at 16°dH/20°e/29°fH 1120l W 250mm L 450mm H 440mm connection 3/8" / 3/4" operation pressure 2-8bar water temperature 6-25°C flow rate 1500l/h with control Autotrol 366/604 (timer) supply 230VAC with timer | | | |
| spare parts for | 530826 | | | |
|  | GEV No. | 520306 | Ref. No. | — |
|  | GEV No. | 520514 | Ref. No. | — |
|  | GEV No. | 520515 | Ref. No. | — |
|  | GEV No. | 520516 | Ref. No. | — |
|  | GEV No. | 520517 | Ref. No. | — |
|  | GEV No. | 520518 | Ref. No. | — |
|  | GEV No. | 520519 | Ref. No. | — |
|  | GEV No. | 520529 | Ref. No. | — |
|  | GEV No. | 530041 | Ref. No. | — |
|  | GEV No. | 530215 | Ref. No. | — |
|  | GEV No. | 530275 | Ref. No. | — |
|  | GEV No. | 530831 | Ref. No. | — |

Table continues overleaf



| | |
|---|---|
| spare parts for 530826 | |
|  | GEV No. 560479 Ref. No. — adjusting screw conical thread M5 L 25mm |
|  | GEV No. 560480 Ref. No. — threaded plate thread M5 L 11mm W 8mm H 4mm |
| accessories for 530826 | |
|  | GEV No. 520136 Ref. No. — ion-exchange resin type Dowex HCR-S/S 25l 20.5kg |
|  | GEV No. 530179 Ref. No. — filter connection 1/2" ø 59mm L 58mm |
|  | GEV No. 530183 Ref. No. — pre-filter connection 1/2" ø 180mm L 180.5mm |
|  | GEV No. 530186 Ref. No. — filter ø 58mm L 125mm |
|  | GEV No. 530187 Ref. No. — mounting wrench |
|  | GEV No. 530238 Ref. No. — regenerant salt type BROXETTEN content 25kg format tablets |
|  | GEV No. 530240 Ref. No. — ion-exchange resin PURE type PC002 25l 20.5kg |
|  | GEV No. 530273 Ref. No. — ion-exchange resin type Dowex HCR-S/S 6l 5kg |
|  | GEV No. 530274 Ref. No. — ion-exchange resin type Dowex HCR-S/S 9l 7.5kg |
|  | GEV No. 530417 Ref. No. — connection thread 3/8" total length 43.5mm hose ø 10mm brass |
|  | GEV No. 530418 Ref. No. — connection short thread 3/4" total length 54mm hose ø 10mm brass |
|  | GEV No. 530419 Ref. No. — connection long thread 3/4" total length 65mm hose ø 10mm brass |
|  | GEV No. 530628 Ref. No. — water shock arrestor connection 3/4" - 3/4" operating p. up to 10bar water hammer max. 50bar t.max. 90°C damping range 3-50bar brass |

water filters

BRITA

accessories

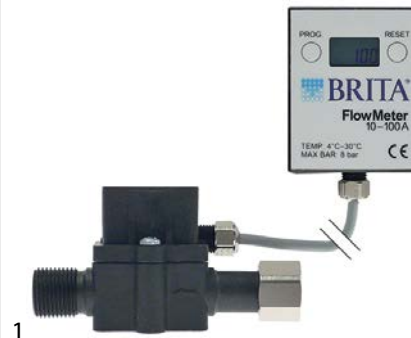



| | | | |
|--------------------|---|-----------------|----------|
| GEV No. | 530055 | Ref. No. | 26039155 |
| description | flow meter with digital display connection 3/8" IT - 3/8" ET total length 81mm flow rate 10-100l/h operation p max 8bar water temperature 4-30°C ambient temperature max. 0-60°C cable length 1500mm display 6 digits | | |



WATER&MORE

BESTMAX





| | | | |
|---|---|-----------------|-----------|
| GEV No. | 530075 | Ref. No. | 3BW812342 |
| description | softener cartridge type bestmax L capacity 3945-5200l operation p max 2-8bar water temperature max. +4 up to +30°C ø 145mm H 530mm water + more decarbonisation universal | | |
| accessories for | 530075 | | |
|  | GEV No. 530055 | Ref. No. | 26039155 |
| description | flow meter with digital display connection 3/8" IT - 3/8" ET total length 81mm flow rate 10-100l/h operation p max 8bar water temperature 4-30°C ambient temperature max. 0-60°C cable length 1500mm display 6 digits | | |
|  | GEV No. 530070 | Ref. No. | |
| description | filter head type besthead thread 3/8" | | |





| | | | |
|---|---|-----------------|--------------------------|
| GEV No. | 530074 | Ref. No. | 3BW812337 |
| description | softener cartridge type bestmax M capacity 2880-4560l operation p max 2-8bar water temperature max. +4 up to +30°C ø 130mm H 500mm water + more decarbonisation universal | | |
| accessories for | 530074 | | |
|  | GEV No. | 530055 | Ref. No. 26039155 |
| | flow meter with digital display connection 3/8" IT - 3/8" ET total length 81mm flow rate 10-100l/h operation p max 8bar water temperature 4-30°C ambient temperature max. 0-60°C cable length 1500mm display 6 digits | | |
|  | GEV No. | 530070 | Ref. No. |
| | filter head type besthead thread 3/8" | | |





| | | | |
|---|---|-----------------|--------------------------|
| GEV No. | 530076 | Ref. No. | 3BW812338 |
| description | softener cartridge type bestmax XL capacity 5155-6800l operation p max 2-8bar water temperature max. +4 up to +30°C ø 145mm H 530mm water + more decarbonisation universal | | |
| accessories for | 530076 | | |
|  | GEV No. | 530055 | Ref. No. 26039155 |
| | flow meter with digital display connection 3/8" IT - 3/8" ET total length 81mm flow rate 10-100l/h operation p max 8bar water temperature 4-30°C ambient temperature max. 0-60°C cable length 1500mm display 6 digits | | |
|  | GEV No. | 530070 | Ref. No. |
| | filter head type besthead thread 3/8" | | |



| | | | |
|---|---|-----------------|--------------------------|
| GEV No. | 530073 | Ref. No. | 3BW812336 |
| description | softener cartridge type bestmax V capacity 1895-3000l operation p max 2-8bar water temperature max. +4 up to +30°C ø 115mm H 445mm water + more decarbonisation universal | | |
| accessories for | 530073 | | |
|  | GEV No. | 530055 | Ref. No. 26039155 |
| | flow meter with digital display connection 3/8" IT - 3/8" ET total length 81mm flow rate 10-100l/h operation p max 8bar water temperature 4-30°C ambient temperature max. 0-60°C cable length 1500mm display 6 digits | | |
|  | GEV No. | 530070 | Ref. No. |
| | filter head type besthead thread 3/8" | | |

accessories

| | | | | |
|--|---|--------|-----------------|---------------|
|  | GEV No. | 530070 | Ref. No. | 3BWF500Y03A00 |
| | filter head type besthead thread 3/8" | | | |
| accessories for | 530070 | | | |
|  | GEV No. | 530055 | Ref. No. | 26039155 |
| | flow meter with digital display connection 3/8" IT - 3/8" ET total length 81mm flow rate 10-100l/h operation p max 8bar water temperature 4-30°C ambient temperature max. 0-60°C cable length 1500mm display 6 digits | | | |

| | | | | |
|--|---|--------|-----------------|----------|
|  | GEV No. | 530055 | Ref. No. | 26039155 |
| | flow meter with digital display connection 3/8" IT - 3/8" ET total length 81mm flow rate 10-100l/h operation p max 8bar water temperature 4-30°C ambient temperature max. 0-60°C cable length 1500mm display 6 digits | | | |



water cycle components

water meters

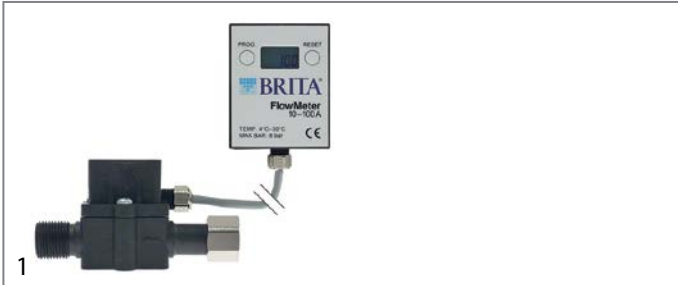
| | | | |
|--|---|-----------------|----------|
|  | | | |
| GEV No. | 530055 | Ref. No. | 26039155 |
| description | flow meter with digital display connection 3/8" IT - 3/8" ET total length 81mm flow rate 10-100l/h operation p max 8bar water temperature 4-30°C ambient temperature max. 0-60°C cable length 1500mm display 6 digits | | |

fastening material

screws

countersunk screws

| | | | |
|--|---|-----------------|-------|
|  | | | |
| GEV No. | 560215 | Ref. No. | 23510 |
| description | countersunk screw thread M5 L 14mm SS DIN 963/ISO 2009 Qty 20 pcs intake slotted head ø 9.2mm | | |
| For models: | Argenta, Argenta-AEP-1, Argenta-AEP-2, Argenta-AEP-3, Argenta-AEP-4, Argenta-AEP-J, Argenta-SAE-1, Argenta-SAE-2, Argenta-SAE-3, Argenta-SAE-4, Argenta-SAE-J, Brava-SME-1, Brava-SME-2, Brava-SME-3, Brava-SME-4, Brava-SMSA-1, Brava-SMSA-2, Brava-SMSA-3, Brava-SMSA-4, CK, CK-CKE, CK-CKE-CK-1, CK-CKE-CKE-1, CKE, CKX-CKXE, CKX-CKXE-CKX-1, CKX-CKXE-CKXE-1, CompattaArgenta, Divina, Divina-AEP-1, Divina-AEP-2, Divina-AEP-3, Divina-AEP-4, Divina-AEP-J, Divina-SAE-1, Divina-SAE-2, Divina-SAE-3, Divina-SAE-4, Divina-SAE-J, Dora, Gloria-AEP-1, Gloria-AEP-2, Gloria-AEP-3, Gloria-AEP-4, Gloria-DISPLAY-LCL-2, Gloria-DISPLAY-LCL-3, Gloria-SAE-1, Gloria-SAE-2, Gloria-SAE-3, Gloria-SAE-4...(Other models you can see in the webshop) | | |

| | | | |
|--|---|-----------------|-------|
|  | | | |
| GEV No. | 560216 | Ref. No. | 23514 |
| description | countersunk screw thread M5 L 20mm SS DIN 963/ISO 2009 Qty 20 pcs intake slotted head ø 9.2mm | | |
| For models: | Brava, Divina-AEP-1, Divina-AEP-2, Divina-AEP-3, Divina-AEP-4, Divina-AEP-J, Divina-SAE-1, Divina-SAE-2, Divina-SAE-3, Divina-SAE-4, Divina-SAE-J, Gloria-AEP-1, Gloria-AEP-2, Gloria-AEP-3, Gloria-AEP-4, Gloria-DISPLAY-LCL-2, Gloria-DISPLAY-LCL-3, Gloria-SAE-1, Gloria-SAE-2, Gloria-SAE-3, Gloria-SAE-4, Rapallo-AEP-1, Rapallo-AEP-2, Rapallo-AEP-3, Rapallo-AEP-4, Sibilla-AEP-1, Sibilla-AEP-2, Sibilla-AEP-3, Sibilla-DISPLAY-2, Sibilla-DISPLAY-3, Sibilla-SAE-1, Sibilla-SAE-2, Sibilla-SAE-3 | | |

hexagonal screws

| | | | |
|--|---|-----------------|----------|
|  | | | |
| GEV No. | 560204 | Ref. No. | 23406902 |
| description | hexagonal screw thread M8 thread L 25mm SS WS 13 Qty 1 pcs DIN 933 / ISO 4017 | | |
| For models: | CompattaArgenta | | |

cylinder head bolts

DIN 912/ISO 4762

| | | | |
|--|---|-----------------|-------|
|  | | | |
| GEV No. | 527168 | Ref. No. | 23556 |
| description | cylinder head bolt thread M10 thread L 16mm L 30mm WS 8 SS Qty 1 pcs DIN 912/ISO 4762 | | |
| For models: | Argenta, Argenta-AEP-1, Argenta-AEP-2, Argenta-AEP-3, Argenta-AEP-4, Argenta-AEP-J, Argenta-SAE-1, Argenta-SAE-2, Argenta-SAE-3, Argenta-SAE-4, Argenta-SAE-J, Brava, Brava-SME-1, Brava-SME-2, Brava-SME-3, Brava-SME-4, Brava-SMSA-1, Brava-SMSA-2, Brava-SMSA-3, Brava-SMSA-4, CompattaArgenta, Denise, Divina, Divina-AEP-1, Divina-AEP-2, Divina-AEP-3, Divina-AEP-4, Divina-AEP-J, Divina-SAE-1, Divina-SAE-2, Divina-SAE-3, Divina-SAE-4, Divina-SAE-J, Dora, Gloria-AEP-1, Gloria-AEP-2, Gloria-AEP-3, Gloria-AEP-4, Gloria-DISPLAY-LCL-2, Gloria-DISPLAY-LCL-3, Gloria-SAE-1, Gloria-SAE-2, Gloria-SAE-3, Gloria-SAE-4, Rapallo-AEP-1, Rapallo-AEP-2, Rapallo-AEP-3, Rapallo-AEP-4, Rapallo-AL-1, Rapallo-AL-2...(Other models you can see in the webshop) | | |

| | | | |
|--|--|-----------------|-------|
|  | | | |
| GEV No. | 560026 | Ref. No. | 23560 |
| description | cylinder head bolt thread M4 thread L 16mm WS 3 SS Qty 20 pcs DIN 912/ISO 4762 | | |
| For models: | Argenta, Argenta-AEP-1, Argenta-AEP-2, Argenta-AEP-3, Argenta-AEP-4, Argenta-AEP-J, Argenta-SAE-1, Argenta-SAE-2, Argenta-SAE-3, Argenta-SAE-4, Argenta-SAE-J, Brava, Brava-SME-1, Brava-SME-2, Brava-SME-3, Brava-SME-4, Brava-SMSA-1, Brava-SMSA-2, Brava-SMSA-3, Brava-SMSA-4, CK-CKE-CK-1, CK-CKE-CKE-1, CKX-CKXE-CKX-1, CKX-CKXE-CKXE-1, CompattaArgenta, Divina-AEP-1, Divina-AEP-2, Divina-AEP-3, Divina-AEP-4, Divina-AEP-J, Divina-SAE-1, Divina-SAE-2, Divina-SAE-3, Divina-SAE-4, Divina-SAE-J, Gloria-AEP-1, Gloria-AEP-2, Gloria-AEP-3, Gloria-AEP-4, Gloria-DISPLAY-LCL-2, Gloria-DISPLAY-LCL-3, Gloria-SAE-1, Gloria-SAE-2, Gloria-SAE-3, Gloria-SAE-4, Rapallo-AEP-1, Rapallo-AEP-2, Rapallo-AEP-3, Rapallo-AEP-4, Sibilla-AEP-1...(Other models you can see in the webshop) | | |

| | | | |
|--|--|-----------------|-------|
|  | | | |
| GEV No. | 560402 | Ref. No. | 23552 |
| description | cylinder head bolt thread M5 thread L 10mm L 15.5mm WS 4 SS Qty 1 pcs intake hexagonal DIN 912/ISO 4762 | | |
| For models: | Argenta, Argenta-AEP-1, Argenta-AEP-2, Argenta-AEP-3, Argenta-AEP-4, Argenta-AEP-J, Argenta-SAE-1, Argenta-SAE-2, Argenta-SAE-3, Argenta-SAE-4, Argenta-SAE-J, Brava-SME-1, Brava-SME-2, Brava-SME-3, Brava-SME-4, Brava-SMSA-1, Brava-SMSA-2, Brava-SMSA-3, Brava-SMSA-4, CK, CK-CKE, CK-CKE-CK-1, CK-CKE-CKE-1, CKE, CKX-CKXE, CKX-CKXE-CKX-1, CKX-CKXE-CKXE-1, CompattaArgenta, Denise, Dora, Vania | | |



| | | | |
|---|--|-----------------|-------|
|  | | | |
| 1 | | | |
| GEV No. | 527170 | Ref. No. | 23558 |
| description | cylinder head bolt thread M6 thread L 8mm WS 5 SS Qty 1 pcs DIN 912/ISO 4762 | | |

| | | | |
|---|---|-----------------|-------|
|  | | | |
| 1 | | | |
| GEV No. | 560368 | Ref. No. | 23554 |
| description | cylinder head bolt thread M8 thread L 16mm WS 6 SS Qty 1 pcs DIN 912/ISO 4762 | | |
| For models: | Argenta, CompattaArgenta | | |

| | | | |
|---|--|-----------------|-------|
|  | | | |
| 1 | | | |
| GEV No. | 560316 | Ref. No. | 23555 |
| description | cylinder head bolt thread M8 thread L 25mm WS 6 SS Qty 20 pcs DIN 912/ISO 4762 | | |
| For models: | Argenta, CompattaArgenta | | |

threaded rods

miscellaneous

| | | | |
|---|---------------------------------|-----------------|-------|
|  | | | |
| 1 | | | |
| GEV No. | 527174 | Ref. No. | 23134 |
| description | thread bolt thread M8 L 25mm SS | | |

nuts

hexagonal nuts

ISO 4033 / UNI5587

| | | | |
|---|---|-----------------|-------|
|  | | | |
| 1 | | | |
| GEV No. | 527852 | Ref. No. | 23049 |
| description | hexagonal nut thread M8 H 8mm WS 13 brass Qty 1 pcs | | |
| For models: | Argenta, Argenta-AEP-1, Argenta-AEP-2, Argenta-AEP-3, Argenta-AEP-4, Argenta-AEP-J, Argenta-SAE-1, Argenta-SAE-2, Argenta-SAE-3, Argenta-SAE-4, Argenta-SAE-J, Brava, Brava-SME-1, Brava-SME-2, Brava-SME-3, Brava-SME-4, Brava-SMSA-1, Brava-SMSA-2, Brava-SMSA-3, Brava-SMSA-4, CMA, Denise, Divina, Divina-AEP-1, Divina-AEP-2, Divina-AEP-3, Divina-AEP-4, Divina-AEP-J, Divina-SAE-1, Divina-SAE-2, Divina-SAE-3, Divina-SAE-4, Divina-SAE-J, Dora, Giada-1, Giada-2, Gloria-AEP-1, Gloria-AEP-2, Gloria-AEP-3, Gloria-AEP-4, Gloria-DISPLAY-LCL-2, Gloria-DISPLAY-LCL-3, Gloria-SAE-1, Gloria-SAE-2, Gloria-SAE-3, Gloria-SAE-4, Rapallo-AEP-1, Rapallo-AEP-2, Rapallo-AEP-3, Rapallo-AEP-4...(Other models you can see in the webshop) | | |

hexagonal nuts metric (without norm)

| | | | |
|---|---|-----------------|-------|
|  | | | |
| 1 | | | |
| GEV No. | 527169 | Ref. No. | 23050 |
| description | hexagonal nut thread M3 H 2.8mm WS 5.5 brass Qty 1 pcs | | |
| For models: | Argenta, Argenta-AEP-1, Argenta-AEP-2, Argenta-AEP-3, Argenta-AEP-4, Argenta-AEP-J, Argenta-SAE-1, Argenta-SAE-2, Argenta-SAE-3, Argenta-SAE-4, Argenta-SAE-J, Brava, Brava-SME-1, Brava-SME-2, Brava-SME-3, Brava-SME-4, Brava-SMSA-1, Brava-SMSA-2, Brava-SMSA-3, Brava-SMSA-4, CK, CK-CKE, CK-CKE-CK-1, CK-CKE-CKE-1, CKE, CKP, CKPE, CKX-CKXE, CKX-CKXE-CKX-1, CKX-CKXE-CKXE-1, CMA, CompattaArgenta, Denise, Divina, Divina-AEP-1, Divina-AEP-2, Divina-AEP-3, Divina-AEP-4, Divina-AEP-J, Divina-SAE-1, Divina-SAE-2, Divina-SAE-3, Divina-SAE-4, Divina-SAE-J, Dora, Giada-1, Giada-2, Giada-Fridge-Cup-warmer-1, Gloria-AEP-1, Gloria-AEP-2...(Other models you can see in the webshop) | | |

| | | | |
|---|---|-----------------|-------|
|  | | | |
| 1 | | | |
| GEV No. | 527269 | Ref. No. | 25384 |
| description | nut thread M26x1.5 H 5.7mm WS 32 brass Qty 1 pcs | | |
| For models: | Argenta, Argenta-AEP-1, Argenta-AEP-2, Argenta-AEP-3, Argenta-AEP-4, Argenta-AEP-J, Argenta-SAE-1, Argenta-SAE-2, Argenta-SAE-3, Argenta-SAE-4, Argenta-SAE-J, Brava, Brava-SME-1, Brava-SME-2, Brava-SME-3, Brava-SME-4, Brava-SMSA-1, Brava-SMSA-2, Brava-SMSA-3, Brava-SMSA-4, CK, CK-CKE, CK-CKE-CK-1, CK-CKE-CKE-1, CKE, CKP, CKPE, CKX-CKXE, CKX-CKXE-CKX-1, CKX-CKXE-CKXE-1, CMA, CompattaArgenta, Denise, Divina-AEP-1, Divina-AEP-2, Divina-AEP-3, Divina-AEP-4, Divina-AEP-J, Divina-SAE-1, Divina-SAE-2, Divina-SAE-3, Divina-SAE-4, Divina-SAE-J, Dora, Giada-1, Giada-2, Giada-Fridge-Cup-warmer-1, Gloria-AEP-1, Gloria-AEP-2, Gloria-AEP-3...(Other models you can see in the webshop) | | |

hexagonal nuts inch thread

| | | | |
|---|---|-----------------|-------|
|  | | | |
| 1 | | | |
| GEV No. | 503042 | Ref. No. | 25356 |
| description | nut thread 3/8" H 6mm brass WS 22 Qty 1 pcs | | |
| For models: | Argenta, Argenta-AEP-1, Argenta-AEP-2, Argenta-AEP-3, Argenta-AEP-4, Argenta-AEP-J, Argenta-SAE-1, Argenta-SAE-2, Argenta-SAE-3, Argenta-SAE-4, Argenta-SAE-J, Brava, Brava-SME-1, Brava-SME-2, Brava-SME-3, Brava-SME-4, Brava-SMSA-1, Brava-SMSA-2, Brava-SMSA-3, Brava-SMSA-4, CompattaArgenta, Denise, Divina, Divina-AEP-1, Divina-AEP-2, Divina-AEP-3, Divina-AEP-4, Divina-AEP-J, Divina-SAE-1, Divina-SAE-2, Divina-SAE-3, Divina-SAE-4, Divina-SAE-J, Dora, Gloria-AEP-1, Gloria-AEP-2, Gloria-AEP-3, Gloria-AEP-4, Gloria-DISPLAY-LCL-2, Gloria-DISPLAY-LCL-3, Gloria-SAE-1, Gloria-SAE-2, Gloria-SAE-3, Gloria-SAE-4, Rapallo-AEP-1, Rapallo-AEP-2, Rapallo-AEP-3, Rapallo-AEP-4, Rapallo-AL-1, Rapallo-AL-2...(Other models you can see in the webshop) | | |

washers

spring rings



1

| | | | |
|--------------------|---|-----------------|-------|
| GEV No. | 560208 | Ref. No. | 23271 |
| description | lock washer ID ø 8.3mm ED ø 15mm SS Qty 1 pcs | | |
| For models: | CompattaArgenta, DPiu-1 | | |

washers

miscellaneous



1

| | | | |
|--------------------|---|-----------------|-------|
| GEV No. | 529862 | Ref. No. | 25652 |
| description | flat washer ID ø 12.3mm ED ø 18mm thickness 1mm brass Qty 1 pcs | | |
| For models: | Argenta, Argenta-AEP-1, Argenta-AEP-2, Argenta-AEP-3, Argenta-AEP-4, Argenta-AEP-J, Argenta-SAE-1, Argenta-SAE-2, Argenta-SAE-3, Argenta-SAE-4, Argenta-SAE-J, Brava, Brava-SME-1, Brava-SME-2, Brava-SME-3, Brava-SME-4, Brava-SMSA-1, Brava-SMSA-2, Brava-SMSA-3, Brava-SMSA-4, CompattaArgenta, Denise, Divina, Divina-AEP-1, Divina-AEP-2, Divina-AEP-3, Divina-AEP-4, Divina-AEP-J, Divina-SAE-1, Divina-SAE-2, Divina-SAE-3, Divina-SAE-4, Divina-SAE-J, Dora, Gloria-AEP-1, Gloria-AEP-2, Gloria-AEP-3, Gloria-AEP-4, Gloria-DISPLAY-LCL-2, Gloria-DISPLAY-LCL-3, Gloria-SAE-1, Gloria-SAE-2, Gloria-SAE-3, Gloria-SAE-4, Rapallo-AEP-1, Rapallo-AEP-2, Rapallo-AEP-3, Rapallo-AEP-4, Rapallo-AL-1, Rapallo-AL-2, Rapallo-AL-3...(Other models you can see in the webshop) | | |



1

| | | | |
|--------------------|---|-----------------|-------|
| GEV No. | 527159 | Ref. No. | 25653 |
| description | flat washer ID ø 9mm ED ø 15.4mm thickness 1mm brass Qty 1 pcs | | |
| For models: | Argenta, Argenta-AEP-1, Argenta-AEP-2, Argenta-AEP-3, Argenta-AEP-4, Argenta-AEP-J, Argenta-SAE-1, Argenta-SAE-2, Argenta-SAE-3, Argenta-SAE-4, Argenta-SAE-J, Brava, Brava-SME-1, Brava-SME-2, Brava-SME-3, Brava-SME-4, Brava-SMSA-1, Brava-SMSA-2, Brava-SMSA-3, Brava-SMSA-4, CompattaArgenta, Denise, Divina, Divina-AEP-1, Divina-AEP-2, Divina-AEP-3, Divina-AEP-4, Divina-AEP-J, Divina-SAE-1, Divina-SAE-2, Divina-SAE-3, Divina-SAE-4, Divina-SAE-J, Gloria-AEP-1, Gloria-AEP-2, Gloria-AEP-3, Gloria-AEP-4, Gloria-DISPLAY-LCL-2, Gloria-DISPLAY-LCL-3, Gloria-SAE-1, Gloria-SAE-2, Gloria-SAE-3, Gloria-SAE-4, Rapallo-AEP-1, Rapallo-AEP-2, Rapallo-AEP-3, Rapallo-AEP-4, Rapallo-AL-1, Rapallo-AL-2, Rapallo-AL-3...(Other models you can see in the webshop) | | |



1

| | | | |
|--------------------|--|-----------------|----------|
| GEV No. | 527873 | Ref. No. | 27421011 |
| description | plain washer ID ø 3.2mm ED ø 7mm thickness 0.5mm brass | | |



1

| | | | |
|--------------------|--|-----------------|----------|
| GEV No. | 528529 | Ref. No. | 27421011 |
| description | plain washer ID ø 3.5mm ED ø 6.6mm thickness 0.5mm brass Qty 1 pcs | | |



1

| | | | |
|--------------------|---|-----------------|-------|
| GEV No. | 527148 | Ref. No. | 25651 |
| description | washer ID ø 17mm ED ø 28mm thickness 2mm brass Qty 1 pcs beveled | | |
| For models: | Argenta, Argenta-AEP-1, Argenta-AEP-2, Argenta-AEP-3, Argenta-AEP-4, Argenta-AEP-J, Argenta-SAE-1, Argenta-SAE-2, Argenta-SAE-3, Argenta-SAE-4, Argenta-SAE-J, Brava, Brava-SME-1, Brava-SME-2, Brava-SME-3, Brava-SME-4, Brava-SMSA-1, Brava-SMSA-2, Brava-SMSA-3, Brava-SMSA-4, CompattaArgenta, Denise, Divina, Divina-AEP-1, Divina-AEP-2, Divina-AEP-3, Divina-AEP-4, Divina-AEP-J, Divina-SAE-1, Divina-SAE-2, Divina-SAE-3, Divina-SAE-4, Divina-SAE-J, Dora, Gloria-AEP-1, Gloria-AEP-2, Gloria-AEP-3, Gloria-AEP-4, Gloria-DISPLAY-LCL-2, Gloria-DISPLAY-LCL-3, Gloria-SAE-1, Gloria-SAE-2, Gloria-SAE-3, Gloria-SAE-4, Rapallo-AEP-1, Rapallo-AEP-2, Rapallo-AEP-3, Rapallo-AEP-4, Rapallo-AL-1, Rapallo-AL-2...(Other models you can see in the webshop) | | |



1

| | | | |
|--------------------|---|-----------------|-------|
| GEV No. | 560328 | Ref. No. | 12155 |
| description | washer ID ø 5mm ED ø 8.5mm thickness 1mm copper Qty 1 pcs | | |
| For models: | Argenta, Argenta-AEP-1, Argenta-AEP-2, Argenta-AEP-3, Argenta-AEP-4, Argenta-AEP-J, Argenta-SAE-1, Argenta-SAE-2, Argenta-SAE-3, Argenta-SAE-4, Argenta-SAE-J, Brava, Brava-SME-1, Brava-SME-2, Brava-SME-3, Brava-SME-4, Brava-SMSA-1, Brava-SMSA-2, Brava-SMSA-3, Brava-SMSA-4, CK, CK-CKE, CK-CKE-CK-1, CK-CKE-CKE-1, CKE, CKP, CKPE, CKX-CKXE, CKX-CKXE-CKX-1, CKX-CKXE-CKXE-1, CompattaArgenta, Denise, Divina, Divina-AEP-1, Divina-AEP-2, Divina-AEP-3, Divina-AEP-4, Divina-AEP-J, Divina-SAE-1, Divina-SAE-2, Divina-SAE-3, Divina-SAE-4, Divina-SAE-J, Dora, DPiu-1, Giada-1, Giada-2, Gloria-AEP-1, Gloria-AEP-2, Gloria-AEP-3...(Other models you can see in the webshop) | | |



1

| | | | |
|--------------------|--|-----------------|-------|
| GEV No. | 560330 | Ref. No. | 12662 |
| description | washer ID ø 5mm ED ø 8mm thickness 1mm aluminium Qty 1 pcs | | |
| For models: | Divina, Divina-AEP-1, Divina-AEP-2, Divina-AEP-3, Divina-AEP-4, Divina-AEP-J, Divina-SAE-1, Divina-SAE-2, Divina-SAE-3, Divina-SAE-4, Divina-SAE-J, Gloria-AEP-1, Gloria-AEP-2, Gloria-AEP-3, Gloria-AEP-4, Gloria-DISPLAY-LCL-2, Gloria-DISPLAY-LCL-3, Gloria-SAE-1, Gloria-SAE-2, Gloria-SAE-3, Gloria-SAE-4, Sibilla-AEP-1, Sibilla-AEP-2, Sibilla-AEP-3, Sibilla-DISPLAY-2, Sibilla-DISPLAY-3, Sibilla-SAE-1, Sibilla-SAE-2, Sibilla-SAE-3 | | |



| | | | |
|---|--|-----------------|-------|
|  | | | |
| 1 | | | |
| GEV No. | 560329 | Ref. No. | 25655 |
| description | washer ID ø 8mm ED ø 12mm thickness 1mm brass Qty 1 pcs | | |
| For models: | Argenta, Argenta-AEP-1, Argenta-AEP-2, Argenta-AEP-3, Argenta-AEP-4, Argenta-AEP-J, Argenta-SAE-1, Argenta-SAE-2, Argenta-SAE-3, Argenta-SAE-4, Argenta-SAE-J, Brava, Brava-SME-1, Brava-SME-2, Brava-SME-3, Brava-SME-4, Brava-SMSA-1, Brava-SMSA-2, Brava-SMSA-3, Brava-SMSA-4, CK, CK-CKE, CK-CKE-CK-1, CK-CKE-CKE-1, CKE, CKP, CKPE, CKX-CKXE, CKX-CKXE-CKX-1, CKX-CKXE-CKXE-1, CMA, CompattaArgenta, Denise, Divina, Divina-AEP-1, Divina-AEP-2, Divina-AEP-3, Divina-AEP-4, Divina-AEP-J, Divina-SAE-1, Divina-SAE-2, Divina-SAE-3, Divina-SAE-4, Divina-SAE-J, Dora, Giada-1, Giada-2, Giada-Fridge-Cup-warmer-1, Gloria-AEP-1, Gloria-AEP-2... (Other models you can see in the webshop) | | |

fasteners

retaining rings

DIN 472

| | | | |
|---|--|-----------------|-------|
|  | | | |
| 1 | | | |
| GEV No. | 528099 | Ref. No. | 10005 |
| description | retaining ring bore ø 11mm thickness 1mm DIN 472 | | |
| For models: | Argenta, Argenta-AEP-1, Argenta-AEP-2, Argenta-AEP-3, Argenta-AEP-4, Argenta-AEP-J, Argenta-SAE-1, Argenta-SAE-2, Argenta-SAE-3, Argenta-SAE-4, Argenta-SAE-J, Brava, Brava-SME-1, Brava-SME-2, Brava-SME-3, Brava-SME-4, Brava-SMSA-1, Brava-SMSA-2, Brava-SMSA-3, Brava-SMSA-4, CK-CKE, CK-CKE-CK-1, CK-CKE-CKE-1, CKX-CKXE, CKX-CKXE-CKX-1, CKX-CKXE-CKXE-1, CompattaArgenta, Denise, Divina, Divina-AEP-1, Divina-AEP-2, Divina-AEP-3, Divina-AEP-4, Divina-AEP-J, Divina-SAE-1, Divina-SAE-2, Divina-SAE-3, Divina-SAE-4, Divina-SAE-J, Dora, Gloria-AEP-1, Gloria-AEP-2, Gloria-AEP-3, Gloria-AEP-4, Gloria-DISPLAY-LCL-2, Gloria-DISPLAY-LCL-3, Gloria-SAE-1, Gloria-SAE-2, Gloria-SAE-3, Gloria-SAE-4... (Other models you can see in the webshop) | | |

| | | | |
|---|--|-----------------|-------|
|  | | | |
| 1 | | | |
| GEV No. | 527257 | Ref. No. | 10002 |
| description | retaining ring bore ø 16mm thickness 1mm SS DIN 472 | | |
| For models: | Argenta, Argenta-AEP-1, Argenta-AEP-2, Argenta-AEP-3, Argenta-AEP-4, Argenta-AEP-J, Argenta-SAE-1, Argenta-SAE-2, Argenta-SAE-3, Argenta-SAE-4, Argenta-SAE-J, Brava, Brava-SME-1, Brava-SME-2, Brava-SME-3, Brava-SME-4, Brava-SMSA-1, Brava-SMSA-2, Brava-SMSA-3, Brava-SMSA-4, CompattaArgenta, Denise, Divina, Divina-AEP-1, Divina-AEP-2, Divina-AEP-3, Divina-AEP-4, Divina-AEP-J, Divina-SAE-1, Divina-SAE-2, Divina-SAE-3, Divina-SAE-4, Divina-SAE-J, Dora, Gloria-AEP-1, Gloria-AEP-2, Gloria-AEP-3, Gloria-AEP-4, Gloria-DISPLAY-LCL-2, Gloria-DISPLAY-LCL-3, Gloria-SAE-1, Gloria-SAE-2, Gloria-SAE-3, Gloria-SAE-4, Rapallo-AEP-1, Rapallo-AEP-2, Rapallo-AEP-3, Rapallo-AEP-4, Rapallo-AL-1, Rapallo-AL-2... (Other models you can see in the webshop) | | |

| | | | |
|---|--|-----------------|-------|
| <p>DIN 6799</p>  | | | |
| 1 | | | |
| GEV No. | 516198 | Ref. No. | 10001 |
| description | retaining ring E D1 ø 6mm D2 ø 12mm SS DIN 6799 thickness 0.7mm for shaft ø 7-9mm | | |
| For models: | Argenta, Argenta-AEP-1, Argenta-AEP-2, Argenta-AEP-3, Argenta-AEP-4, Argenta-AEP-J, Argenta-SAE-1, Argenta-SAE-2, Argenta-SAE-3, Argenta-SAE-4, Argenta-SAE-J, Brava, Brava-SME-1, Brava-SME-2, Brava-SME-3, Brava-SME-4, Brava-SMSA-1, Brava-SMSA-2, Brava-SMSA-3, Brava-SMSA-4, CK, CK-CKE, CK-CKE-CK-1, CK-CKE-CKE-1, CKE, CKP, CKPE, CKX-CKXE, CKX-CKXE-CKX-1, CKX-CKXE-CKXE-1, CMA, Coffee-grinder-R-1, CompattaArgenta, Denise, Divina, Divina-AEP-1, Divina-AEP-2, Divina-AEP-3, Divina-AEP-4, Divina-AEP-J, Divina-SAE-1, Divina-SAE-2, Divina-SAE-3, Divina-SAE-4, Divina-SAE-J, Dora, Giada-1, Giada-2, Giada-Fridge-Cup-warmer-1, Gloria-AEP-1... (Other models you can see in the webshop) | | |

| | | | |
|---|---|-----------------|-------|
|  | | | |
| 1 | | | |
| GEV No. | 529268 | Ref. No. | 10003 |
| description | retaining ring E D1 ø 9mm D2 ø 18mm stainless steel DIN 6799 thickness 1.1mm for shaft ø 10-14mm | | |
| For models: | Argenta, Brava, Denise, Divina, Dora, Rapallo-AL-1, Rapallo-AL-2, Rapallo-AL-3, Rapallo-AL-4, Vania | | |

roll pins

| | | | |
|--|--|-----------------|-------|
|  | | | |
| 1 | | | |
| GEV No. | 690968 | Ref. No. | 10701 |
| description | roll pin ø 5mm L 20mm | | |
| For models: | Argenta, Argenta-AEP-1, Argenta-AEP-2, Argenta-AEP-3, Argenta-AEP-4, Argenta-AEP-J, Argenta-SAE-1, Argenta-SAE-2, Argenta-SAE-3, Argenta-SAE-4, Argenta-SAE-J, Brava, Brava-SME-1, Brava-SME-2, Brava-SME-3, Brava-SME-4, Brava-SMSA-1, Brava-SMSA-2, Brava-SMSA-3, Brava-SMSA-4, CompattaArgenta, Denise, Divina, Divina-AEP-1, Divina-AEP-2, Divina-AEP-3, Divina-AEP-4, Divina-AEP-J, Divina-SAE-1, Divina-SAE-2, Divina-SAE-3, Divina-SAE-4, Divina-SAE-J, Dora, Gloria-AEP-1, Gloria-AEP-2, Gloria-AEP-3, Gloria-AEP-4, Gloria-DISPLAY-LCL-2, Gloria-DISPLAY-LCL-3, Gloria-SAE-1, Gloria-SAE-2, Gloria-SAE-3, Gloria-SAE-4, Rapallo-AEP-1, Rapallo-AEP-2, Rapallo-AEP-3, Rapallo-AEP-4, Rapallo-AL-1, Rapallo-AL-2... (Other models you can see in the webshop) | | |

screw caps



1

| | | | |
|--------------------|---|-----------------|-------|
| GEV No. | 520706 | Ref. No. | 25780 |
| description | screw cap thread 1/4" WS 17 | | |
| For models: | Argenta, Argenta-AEP-1, Argenta-AEP-2, Argenta-AEP-3, Argenta-AEP-4, Argenta-AEP-J, Argenta-SAE-1, Argenta-SAE-2, Argenta-SAE-3, Argenta-SAE-4, Argenta-SAE-J, Brava, Brava-SME-1, Brava-SME-2, Brava-SME-3, Brava-SME-4, Brava-SMSA-1, Brava-SMSA-2, Brava-SMSA-3, Brava-SMSA-4, CompattaArgenta, Denise, Divina, Divina-AEP-1, Divina-AEP-2, Divina-AEP-3, Divina-AEP-4, Divina-AEP-J, Divina-SAE-1, Divina-SAE-2, Divina-SAE-3, Divina-SAE-4, Divina-SAE-J, Dora, Gloria-AEP-1, Gloria-AEP-2, Gloria-AEP-3, Gloria-AEP-4, Gloria-DISPLAY-LCL-2, Gloria-DISPLAY-LCL-3, Gloria-SAE-1, Gloria-SAE-2, Gloria-SAE-3, Gloria-SAE-4, Rapallo-AEP-1, Rapallo-AEP-2, Rapallo-AEP-3, Rapallo-AEP-4, Rapallo-AL-1, Rapallo-AL-2...(Other models you can see in the webshop) | | |



1

| | | | |
|--------------------|---|-----------------|-------|
| GEV No. | 520707 | Ref. No. | 25785 |
| description | screw cap thread 3/8" thread L 8mm brass WS 21 head thickness 6mm | | |
| For models: | Argenta-AEP-1, Argenta-AEP-2, Argenta-AEP-3, Argenta-AEP-4, Argenta-AEP-J, Argenta-SAE-1, Argenta-SAE-2, Argenta-SAE-3, Argenta-SAE-4, Argenta-SAE-J, Brava, Brava-SME-1, Brava-SME-2, Brava-SME-3, Brava-SME-4, Brava-SMSA-1, Brava-SMSA-2, Brava-SMSA-3, Brava-SMSA-4, CMA, Divina, Divina-AEP-1, Divina-AEP-2, Divina-AEP-3, Divina-AEP-4, Divina-AEP-J, Divina-SAE-1, Divina-SAE-2, Divina-SAE-3, Divina-SAE-4, Divina-SAE-J, Dora, Giada-1, Giada-2, Giada-Fridge-Cup-warmer-1, Gloria-AEP-1, Gloria-AEP-2, Gloria-AEP-3, Gloria-AEP-4, Gloria-DISPLAY-LCL-2, Gloria-DISPLAY-LCL-3, Gloria-SAE-1, Gloria-SAE-2, Gloria-SAE-3, Gloria-SAE-4, Rapallo-AEP-1, Rapallo-AEP-2, Rapallo-AEP-3, Rapallo-AEP-4, Rapallo-AL-1...(Other models you can see in the webshop) | | |



1

| | | | |
|--------------------|---|-----------------|-------|
| GEV No. | 520702 | Ref. No. | 25782 |
| description | end cap thread 1/4" brass WS 16 | | |
| For models: | Argenta, Argenta-AEP-1, Argenta-AEP-2, Argenta-AEP-3, Argenta-AEP-4, Argenta-AEP-J, Argenta-SAE-1, Argenta-SAE-2, Argenta-SAE-3, Argenta-SAE-4, Argenta-SAE-J, Brava, Brava-SME-1, Brava-SME-2, Brava-SME-3, Brava-SME-4, Brava-SMSA-1, Brava-SMSA-2, Brava-SMSA-3, Brava-SMSA-4, CMA, CompattaArgenta, Denise, Divina, Divina-AEP-1, Divina-AEP-2, Divina-AEP-3, Divina-AEP-4, Divina-AEP-J, Divina-SAE-1, Divina-SAE-2, Divina-SAE-3, Divina-SAE-4, Divina-SAE-J, Dora, Giada-1, Giada-2, Gloria-AEP-1, Gloria-AEP-2, Gloria-AEP-3, Gloria-AEP-4, Gloria-DISPLAY-LCL-2, Gloria-DISPLAY-LCL-3, Gloria-SAE-1, Gloria-SAE-2, Gloria-SAE-3, Gloria-SAE-4, Rapallo-AEP-1, Rapallo-AEP-2, Rapallo-AEP-3...(Other models you can see in the webshop) | | |

consumables

fuses

fine fuses



1

| | | | |
|--------------------|--|-----------------|-------|
| GEV No. | 358532 | Ref. No. | 19101 |
| description | fine fuse size ø5x20mm 2A fast-acting rated 250V Qty 10 pcs | | |
| For models: | Argenta-AEP-1, Argenta-AEP-2, Argenta-AEP-3, Argenta-AEP-4, Argenta-AEP-J, Argenta-SAE-1, Argenta-SAE-2, Argenta-SAE-3, Argenta-SAE-4, Argenta-SAE-J, Brava-SME-1, Brava-SME-2, Brava-SME-3, Brava-SME-4, Brava-SMSA-1, Brava-SMSA-2, Brava-SMSA-3, Brava-SMSA-4, Divina-AEP-1, Divina-AEP-2, Divina-AEP-3, Divina-AEP-4, Divina-AEP-J, Divina-SAE-1, Divina-SAE-2, Divina-SAE-3, Divina-SAE-4, Divina-SAE-J, Giada-1, Giada-2, Gloria-AEP-1, Gloria-AEP-2, Gloria-AEP-3, Gloria-AEP-4, Gloria-DISPLAY-LCL-2, Gloria-DISPLAY-LCL-3, Gloria-SAE-1, Gloria-SAE-2, Gloria-SAE-3, Gloria-SAE-4, Rapallo-AEP-1, Rapallo-AEP-2, Rapallo-AEP-3, Rapallo-AEP-4, Rapallo-AL-1, Rapallo-AL-2, Rapallo-AL-3, Rapallo-AL-4, Sara-1GR-1, Sara-2GR-2...(Other models you can see in the webshop) | | |



1

| | | | |
|--------------------|--|-----------------|-------|
| GEV No. | 358597 | Ref. No. | 19106 |
| description | fine fuse size ø5x20mm 0.5A slow-acting rated 250V Qty 10 pcs | | |
| For models: | Argenta-AEP-1, Argenta-AEP-2, Argenta-AEP-3, Argenta-AEP-4, Argenta-AEP-J, Argenta-SAE-1, Argenta-SAE-2, Argenta-SAE-3, Argenta-SAE-4, Argenta-SAE-J, Brava-SME-1, Brava-SME-2, Brava-SME-3, Brava-SME-4, Brava-SMSA-1, Brava-SMSA-2, Brava-SMSA-3, Brava-SMSA-4, Divina-AEP-1, Divina-AEP-2, Divina-AEP-3, Divina-AEP-4, Divina-AEP-J, Divina-SAE-1, Divina-SAE-2, Divina-SAE-3, Divina-SAE-4, Divina-SAE-J, Giada-1, Giada-2, Gloria-AEP-1, Gloria-AEP-2, Gloria-AEP-3, Gloria-AEP-4, Gloria-DISPLAY-LCL-2, Gloria-DISPLAY-LCL-3, Gloria-SAE-1, Gloria-SAE-2, Gloria-SAE-3, Gloria-SAE-4, Rapallo-AEP-1, Rapallo-AEP-2, Rapallo-AEP-3, Rapallo-AEP-4, Rapallo-AL-1, Rapallo-AL-2, Rapallo-AL-3, Rapallo-AL-4, Sara-1GR-1, Sara-2GR-2...(Other models you can see in the webshop) | | |





1

| | | | |
|--------------------|--|-----------------|-------|
| GEV No. | 358608 | Ref. No. | 19104 |
| description | fine fuse size ø5x20mm 10A slow-acting rated 250V Qty 10 pcs | | |
| For models: | Argenta-AEP-1, Argenta-AEP-2, Argenta-AEP-3, Argenta-AEP-4, Argenta-AEP-J, Argenta-SAE-1, Argenta-SAE-2, Argenta-SAE-3, Argenta-SAE-4, Argenta-SAE-J, Brava-SME-1, Brava-SME-2, Brava-SME-3, Brava-SME-4, Brava-SMSA-1, Brava-SMSA-2, Brava-SMSA-3, Brava-SMSA-4, Divina-AEP-1, Divina-AEP-2, Divina-AEP-3, Divina-AEP-4, Divina-AEP-J, Divina-SAE-1, Divina-SAE-2, Divina-SAE-3, Divina-SAE-4, Divina-SAE-J, Dora, Giada-1, Giada-2, Gloria-AEP-1, Gloria-AEP-2, Gloria-AEP-3, Gloria-AEP-4, Gloria-DISPLAY-LCL-2, Gloria-DISPLAY-LCL-3, Gloria-SAE-1, Gloria-SAE-2, Gloria-SAE-3, Gloria-SAE-4, Rapallo-AEP-1, Rapallo-AEP-2, Rapallo-AEP-3, Rapallo-AEP-4, Rapallo-AL-1, Rapallo-AL-2, Rapallo-AL-3, Rapallo-AL-4, Sara-1GR-1...(Other models you can see in the webshop) | | |

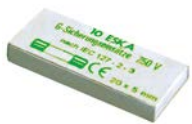

| | | | |
|---|---|-----------------|-------|
|  | | | |
| 1 | | | |
| GEV No. | 358605 | Ref. No. | 19100 |
| description | fine fuse size ø5x20mm 3.15A slow-acting rated 250V Qty 10 pcs | | |
| For models: | CMA, Sara-1GR-1, Sara-2GR-2, Sibilla-AEP-1, Sibilla-AEP-2, Sibilla-AEP-3, Sibilla-DISPLAY-2, Sibilla-DISPLAY-3, Sibilla-SAE-1, Sibilla-SAE-2, Sibilla-SAE-3 | | |

| | | | |
|---|---|-----------------|-------|
|  | | | |
| 1 | | | |
| GEV No. | 358607 | Ref. No. | 19103 |
| description | fine fuse size ø5x20mm 6.3A slow-acting rated 250V Qty 10 pcs | | |
| For models: | CompattaArgenta, Giada-1, Giada-2, Sara-1GR-1, Sara-2GR-2 | | |

| fine fuse holders | | | |
|---|--|-----------------|-------|
|  | | | |
| 1 | | | |
| GEV No. | 358008 | Ref. No. | 19121 |
| description | fuse holder for coffee machine suitable fuse ø5x20mm 1-pole 10A rated 250V L 49mm W 19mm H 35mm connection screw | | |
| For models: | CompattaArgenta, Giada-1, Giada-2, Sara-1GR-1, Sara-2GR-2 | | |

| | | | |
|---|--------|--|--|
| A | | | |
| automatic softeners | 79 | | |
| B | | | |
| bi-metal thermostats | 6, 6 | | |
| booster pumps II | 29 | | |
| C | | | |
| cables | 33 | | |
| condensators & interference suppression filters | 31 | | |
| connection cables | 33 | | |
| consumables | 86 | | |
| contactors | 13 | | |
| control thermostats | 7 | | |
| countersunk screws | 82 | | |
| cylinder head bolts | 82 | | |
| D | | | |
| dosing pumps | 77 | | |
| double nipples | 78 | | |
| E | | | |
| electric accessories | 33 | | |
| electrodes | 27 | | |
| F | | | |
| fasteners | 85 | | |
| fastening material | 82 | | |
| fine fuses | 86 | | |
| fittings | 78 | | |
| flow meters | 28 | | |
| fuses | 32, 86 | | |
| H | | | |
| heating cartridges | 6 | | |
| heating elements | 3 | | |
| heating elements for coffee machine | 3 | | |
| hexagonal nuts | 83 | | |
| hexagonal screws | 82 | | |
| hoses | 78 | | |
| hoses wire reinforced | 78 | | |
| I | | | |
| ignition cables | 33 | | |
| indicator lights | 12 | | |
| indicator lights (complete) | 12 | | |
| industrial hoses | 78 | | |
| K | | | |
| key lock switches | 10 | | |
| L | | | |
| lamps | 12 | | |
| LED | 12 | | |
| M | | | |
| magnetic switches | 12 | | |
| mechanical timers | 13 | | |
| microswitches | 9 | | |
| milk foamers | 75 | | |
| motors | 28 | | |
| N | | | |
| nuts | 83 | | |
| O | | | |
| operating capacitors | 31 | | |
| O-rings | 68 | | |
| P | | | |
| pressure switches | 27 | | |
| probes | 15 | | |
| pumps | 29 | | |
| pumps for milk foamers | 31 | | |
| push/momentary push switches | 8 | | |
| R | | | |
| reducers | 79 | | |
| relays | 13 | | |
| retaining rings | 85 | | |
| ribbon cables | 33 | | |
| rocker/momentary rocker switches | 7 | | |
| rod thermostats | 7 | | |
| roll pins | 85 | | |
| rotary switches | 10 | | |
| S | | | |
| safety bi-metal thermostats | 6 | | |
| safety rod thermostats | 7 | | |
| safety thermostats | 6 | | |
| screw caps | 86 | | |
| screws | 82 | | |
| sealing washers | 71 | | |
| solenoid valves | 24 | | |
| solid state relays | 13 | | |
| spring rings | 84 | | |
| stainless steel flexi hoses | 78 | | |
| supply hoses | 78 | | |
| switches and momentary switches | 7 | | |
| system switches (ROLD) | 9 | | |
| T | | | |
| thermostats | 6 | | |

| | |
|-----------------|----|
| threaded rods | 83 |
| timers | 13 |
| toggle switches | 9 |

U

| | |
|-----------------|----|
| universal hoses | 78 |
|-----------------|----|

V

| | |
|-----------------|----|
| vibration pumps | 30 |
|-----------------|----|

W

| | |
|------------------------|----|
| washers | 84 |
| water cycle components | 82 |
| water filters | 80 |
| water meters | 82 |
| water softeners | 79 |