



GAS COMPONENTS



ELECTRIC COMPONENTS



WATER TECHNOLOGY



MECHANICAL COMPONENTS



TOOLS

Spare parts suitable for

ARTSERF

Find the complete and up-to-date range of products in our GEV Webshop



Manufacturer catalogue

The most important spare parts and accessories arranged clearly for every manufacturer

- ✓ Complete product range and all appliance data always up to date in the GEV Webshop
- ✓ Alphabetical Index at the end of the catalogue

GEV Webshop

www.gev-online.co.uk

www.gev-online.com



- 🔍 Add to Favourites
- 🔍 Sign In with email address and usual password
- 🔍 Easy-order – place several items in your basket at the same time
- 🔍 Quick Item search – no login needed



thermostats

refrigeration thermostats

universal without housing



GEV No.	390534	Ref. No.	3410050
description	thermostat temperature range -35 up to +35°C probe ø6x110mm capillary pipe 1800mm PRODIGY		
accessories for	390534		
	GEV No.	110305	Ref. No. —
	knob thermostat t.max. 35°C temperature range -35 up to +35°C ø 45mm shaft ø 6x4.6mm shaft flat inclined rotation 270° white		

switches and momentary switches

rocker/momentary rocker switches

30x22mm

labelled



GEV No.	300125	Ref. No.	3410060
description	rocker switch mounting measurements 30x22mm green 2NO 230V 16A 0-1 connection male faston 6.3mm ambient temperature max. 125/55°C protection IP65 with cover cap		
accessories for	300125		
	GEV No.	301036	Ref. No. —
	protective cover internal size 30x22mm for rocker switch mounting measurementsmm		

electronic controllers

DIXELL

refrigeration controllers

built-in version













GEV No.	379996	Ref. No.	34400001 3520030
description	electronic controller DIXELL XR20CX-5N0C0 mounting measurements 71x29mm 230V voltage AC NTC/PTC relay outputs 1 CO-8A(3) NTC/PTC DI yes protection IP54 -50 up to +150°C display 3½ digits		
spare parts for	379996		
	GEV No.	379995	Ref. No. —
	electronic controller DIXELL mounting measurements 71x29mm 230V voltage AC type XR20C sensor 1 NTC/PTC		
accessories for	379996		
	GEV No.	378194	Ref. No. —
	temperature probe NTC 10kOhm cable PVC probe -20 up to +80°C cable -10 up to 100°C probe ø7x24.5mm cable length 1.5m without screw connection 2-wire		
	GEV No.	378551	Ref. No. —
	adapter for reducer mounting measurements 71x29mm		
	GEV No.	379052	Ref. No. —
	temperature probe PTC 1kOhm cable silicone probe -50 up to +150°C cable -50 up to +180°C probe ø6x40mm cable length 1.5m without screw connection 2-wire		
	GEV No.	379053	Ref. No. —
	temperature probe PTC 1kOhm cable PVC probe -50 up to +150°C cable -10 up to 100°C probe ø6x30mm cable length 3m without screw connection 2-wire		
	GEV No.	379057	Ref. No. —
	temperature probe NTC 10kOhm cable PVC probe -20 up to +80°C cable -10 up to 100°C probe ø6x25mm cable length 3m 2-wire		
	GEV No.	379064	Ref. No. —
	temperature probe PTC 1kOhm cable silicone probe -50 up to +150°C cable -50 up to +180°C probe ø6x40mm cable length 3m without screw connection 2-wire		
	GEV No.	379160	Ref. No. —
	temperature probe NTC 10kOhm cable thermoplastic probe -40 up to +110°C cable -40 up to +110°C probe ø6x14mm cable length 1.5m without screw connection 2-wire		
	GEV No.	379161	Ref. No. —
	temperature probe NTC 10kOhm cable thermoplastic probe -40 up to +110°C cable -40 up to +110°C probe ø6x14mm cable length 3m without screw connection 2-wire		
	GEV No.	379343	Ref. No. —
	temperature probe NTC 10kOhm cable silicone probe -40 up to +110°C cable -50 up to +180°C probe ø6x40mm cable length 3m 2-wire		
	GEV No.	379458	Ref. No. —
	temperature probe NTC 10kOhm cable silicone probe -40 up to +110°C cable -50 up to +180°C probe ø6x40mm cable length 1.5m without screw connection 2-wire		

Table continues overleaf

accessories for	379996			
	GEV No.	379782	Ref. No.	—
	temperature probe PTC 1kOhm cable thermoplastic probe -50 up to +150°C cable -40 up to +110°C probe ø6x14mm cable length 3m 2-wire resistor 1kOhm			
	GEV No.	402818	Ref. No.	—
	programming key 4K for electronic controller DIXELL			

cooling aggregates

GEV No.	379304***	Ref. No.	123456	
description				
For models:				
spare parts for	605100			
	GEV No.	601277	Ref. No.	3340440 RICAMBIO1
	fan 220-240V 50/60Hz fan wheel ø 22.5mm mounting distance 26.5mm			
	GEV No.	605003	Ref. No.	3340450
	compressor coolant R404a/R507 type NB6144GK 230V 50Hz MBP fully hermetic 10.3kg cylinder capacity 4.52cm ³ CSIR H 187mm 226W 288W 301W 375W 459W 553W 658W test method ASHRAE			

compressors

EMBRACO / ASPERA

R404a/R507

MBP monophase

Medium evaporation temperature above -20°C



GEV No.	605003	Ref. No.	3340450	
description	compressor coolant R404a/R507 type NB6144GK 230V 50Hz MBP fully hermetic 10.3kg cylinder capacity 4.52cm ³ CSIR H 187mm 226W 288W 301W 375W 459W 553W 658W test method ASHRAE			
spare parts for	605003			
	GEV No.	601022	Ref. No.	—
	fan motor 10W 230V 50-60Hz L1 44mm L2 54mm L3 85mm W 84mm cable length 500mm 1300rpm YZF10-20-18/26 5 mounting options bearing slide bearing			
	GEV No.	601071	Ref. No.	—
	fan wheel sucking ø 230mm fan wheel mounting 25.4mm blade angle 25° W 37mm aluminium			
	GEV No.	605003	Ref. No.	3340450
	compressor coolant R404a/R507 type NB6144GK 230V 50Hz MBP fully hermetic 10.3kg cylinder capacity 4.52cm ³ CSIR H 187mm 226W 288W 301W 375W 459W 553W 658W test method ASHRAE			

fans

refrigeration fans

cooling motors (complete)



GEV No.	601277	Ref. No.	3340440 RICAMBIO1	
description	fan 220-240V 50/60Hz fan wheel ø 22.5mm mounting distance 26.5mm			
spare parts for	601277			
	GEV No.	601071	Ref. No.	—
	fan wheel sucking ø 230mm fan wheel mounting 25.4mm blade angle 25° W 37mm aluminium			
	GEV No.	601427	Ref. No.	—
	fan motor ELCO 10W 230V 50/60Hz bearing slide bearing L1 49mm L2 59mm L3 86.5mm W 83mm connection cable 500mm 1300/1550rpm 5 mounting options VNT10-20/028			
	GEV No.	601514	Ref. No.	—
	guard H 30mm mounting distance 225mm W 240mm evaporator fan			

cross flow fans

EMMEVI - FERGAS

with moulded coils



GEV No.	601110	Ref. No.	3420010	
description	cross flow fan TGO 60/1-180/20 roller ø 60mm roller length 180mm laminated core thickness 20mm motor position left 230V/50Hz 28W refrigeration bearing rubber connection male faston 6.3mm -30 up to +100°C 230V cable length 1800mm			



equipment-specific units

for fridges

drawers

drawers



GEV No.	690948	Ref. No.	2252140
description	bracket for bottles \varnothing 6mm L 440mm		

handles and hand wheels

handle rails

ART-SERF



GEV No.	690951	Ref. No.	2440450
description	handle rail		

handle rails



GEV No.	690951	Ref. No.	2440450
description	handle rail		

locks

edgemount latches

handle latches

RAHRBACH

6188 ERGO series

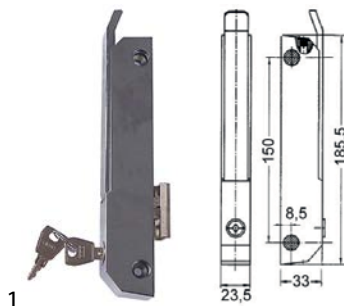

GEV No.	700548	Ref. No.	3310010
----------------	--------	-----------------	---------

description handle latch

spare parts for 700548



GEV No.	690016	Ref. No.	—
description	handle latch L 185mm mounting distance 150mm chrome-plated lockable refrigeration units 6188		

spare parts for 700548



GEV No.	690110	Ref. No.	—
description	base plate H 1mm L 38mm W 11mm mounting distance 26mm plastic		



GEV No.	690111	Ref. No.	—
description	base plate H 2mm L 38mm W 11mm mounting distance 26mm plastic		



GEV No.	700082	Ref. No.	—
description	door catch L 38mm W 18mm mounting distance 26mm		

drawer latches

RAHRBACH

6190 ERGO series



GEV No.	700549	Ref. No.	3310020
----------------	--------	-----------------	---------

description drawer latch complete handle length 556mm

spare parts for 700549



GEV No.	690019	Ref. No.	—
description	drawer latch L 185mm mounting distance 150mm non lockable refrigeration units 6190		



GEV No.	690020	Ref. No.	—
description	drawer latch L 185mm mounting distance 150mm lockable refrigeration units 6190		



GEV No.	690021	Ref. No.	—
----------------	--------	-----------------	---

handle rod H 21mm L 1000mm W 9mm



GEV No.	690110	Ref. No.	—
description	base plate H 1mm L 38mm W 11mm mounting distance 26mm plastic		



GEV No.	690111	Ref. No.	—
description	base plate H 2mm L 38mm W 11mm mounting distance 26mm plastic		



GEV No.	690947	Ref. No.	—
description	base plate H 5mm L 38mm W 11mm mounting distance 26mm plastic		



GEV No.	700082	Ref. No.	—
----------------	--------	-----------------	---

door catch L 38mm W 18mm mounting distance 26mm

snap locks

producer-specific

ART-SERF



GEV No. 690952 **Ref. No.** 3310440

description snap lock



GEV No. 692475 **Ref. No.** 3320010+3320020

description snap lock L 82mm W 17mm mounting distance 22.5mm H 34.5mm

hinges

door bearing



GEV No. 690945 **Ref. No.** 2140350

description hinge mounting pos. upper left with bolt



GEV No. 690946 **Ref. No.** 2140370

description hinge bearing mounting pos. bottom left with bolt



GEV No. 690944 **Ref. No.** 2140360
62100451

description hinge bearing mounting pos. bottom right with bolt



GEV No. 690950 **Ref. No.** 2140390

description hinge bearing mounting pos. upper left/bottom right with bolt



GEV No. 690943 **Ref. No.** 2140340

description hinge bearing mounting pos. upper right with bolt



GEV No. 690949 **Ref. No.** 2140380

description hinge bearing mounting pos. upper right/bottom left with bolt

pullouts

drawer slides

universal

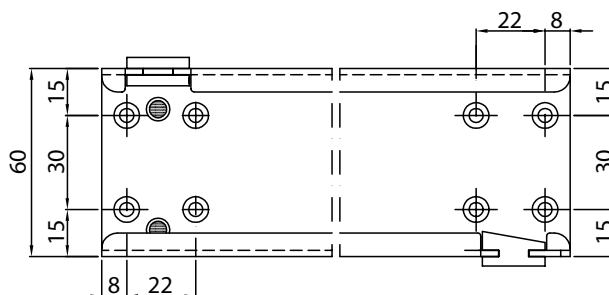

GEV No. 690753¹ **Ref. No.** 3310040

description telescopic slide pair L 550mm pull-out length 610mm total length 1160mm Qty 1 pair capacity 50kg H 60mm SS telescopic

spare parts for 690753

GEV No. 690750 **Ref. No.** —
description stop for telescopic rail L 20mm plastic H 12mm D 9mm

GEV No. 696333 **Ref. No.** —
description stop for telescopic rail L 20mm plastic H 15mm D 8mm

¹multiple slide (60mm more than nominal length)

gaskets

refrigeration gaskets

plug-in gaskets

profile 9048

We offer custom-made gaskets for this profile

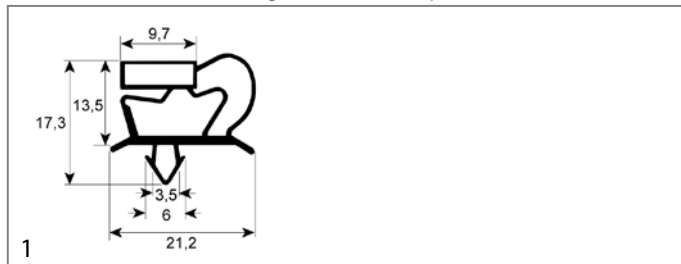

GEV No.	900529	Ref. No.	2321020
description	refrigeration gasket profile 9048 W 510mm L 890mm plug size		

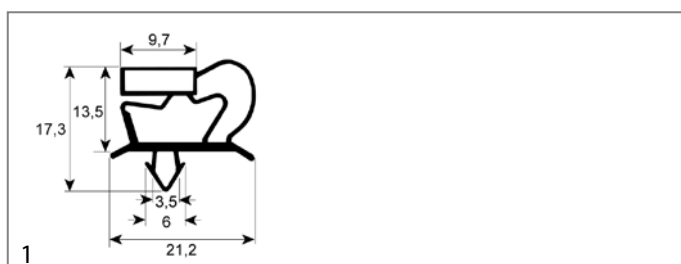

GEV No.	900530	Ref. No.	2321000
description	refrigeration gasket profile 9048 W 895mm L 915mm plug size		

profile 9048-B

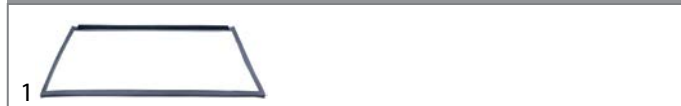

GEV No.	900531 ¹	Ref. No.	2321030
description	refrigeration gasket profile 9048 W 510mm L 890mm plug size with plastic rail		

spare parts for	900531			
	GEV No.	900529	Ref. No.	2321020
	refrigeration gasket profile 9048 W 510mm L 890mm plug size			

¹with plastic rail



GEV No.	900532 ¹	Ref. No.	2321010
description	refrigeration gasket profile 9048 W 895mm L 915mm plug size with plastic rail		

spare parts for	900532			
	GEV No.	900530	Ref. No.	2321000
	refrigeration gasket profile 9048 W 895mm L 915mm plug size			

¹with plastic rail

screw-in gaskets

profile 9663

We offer custom-made gaskets for this profile

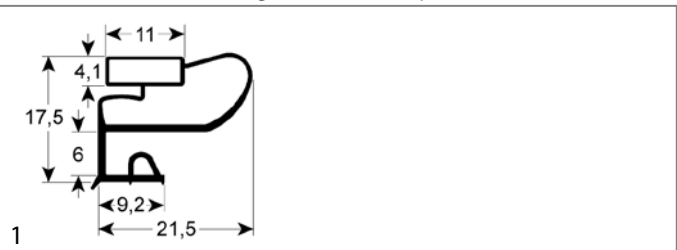

GEV No.	902295	Ref. No.	N/A
description	refrigeration gasket profile 9663 Wmm L 2500mm		

profile 9030

We offer custom-made gaskets for this profile

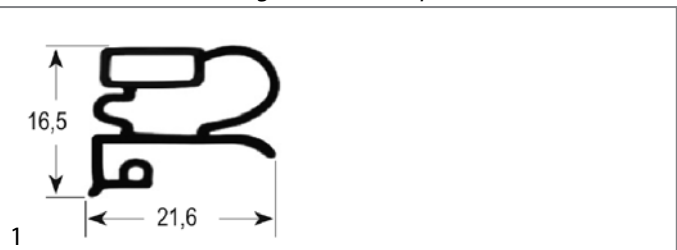

GEV No.	900527	Ref. No.	2320320
description	refrigeration gasket profile 9030 W 245mm L 500mm external size		

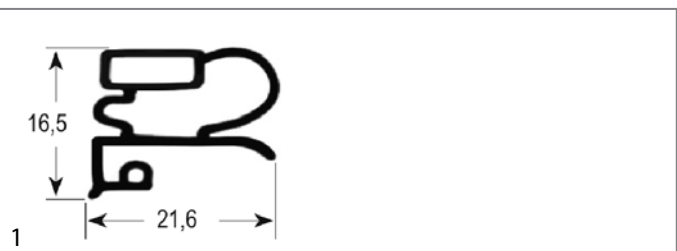

GEV No.	900558	Ref. No.	2320340 44310012
description	refrigeration gasket profile 9030 W 335mm L 505mm external size		

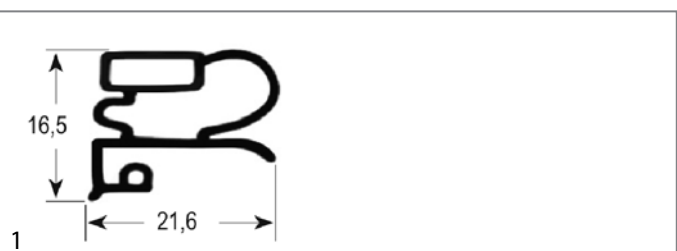

GEV No.	900528	Ref. No.	2320330
description	refrigeration gasket profile 9030 W 375mm L 500mm external size		

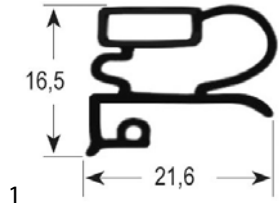

GEV No.	900559	Ref. No.	2320350 44310013
description	refrigeration gasket profile 9030 W 415mm L 500mm external size		

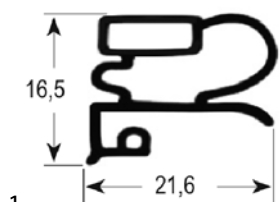

GEV No.	900526	Ref. No.	2320310 44310009
description	refrigeration gasket profile 9030 W 505mm L 780mm external size		

evaporators

for fridges

producer-specific





GEV No.	750151	Ref. No.	27260011 3340510
description	evaporator L 330mm W 90mm H 210mm		







drain systems and wash basins

drain fittings

universal









GEV No.	515042	Ref. No.	3210110 3210150	
description	drain fitting size 1 1/2" usable heightmm overall height 32mm ED ø 69mm chrome-plated brass			
accessories for	515042			
	GEV No.	515051	Ref. No.	—
	standpipe size 1 1/2" usable height 170mm overall height 185mm ED ø 40mm SS			

accessories for	515042			
	GEV No.	515052	Ref. No.	—
	standpipe size 1 1/2" usable height 220mm overall height 235mm ED ø 40mm SS			
	GEV No.	515053	Ref. No.	3210110 3210150
	standpipe size 1 1/2" usable height 260mm overall height 275mm ED ø 40mm SS			
	GEV No.	515054	Ref. No.	—
	standpipe size 1 1/2" usable height 310mm overall height 325mm ED ø 40mm SS			
	GEV No.	515062	Ref. No.	—
	standpipe size 1 1/2" usable height 190mm overall height 200mm ED ø 46mm chrome-plated brass with filter			
	GEV No.	515063	Ref. No.	—
	standpipe size 1 1/2" usable height 230mm overall height 240mm ED ø 46mm chrome-plated brass with filter			
	GEV No.	515064	Ref. No.	—
	standpipe size 1 1/2" usable height 280mm overall height 290mm ED ø 46mm chrome-plated brass with filter			

standpipes

1 1/4"



GEV No.	515042	Ref. No.	3210110 3210150	
description	drain fitting size 1 1/2" usable heightmm overall height 32mm ED ø 69mm chrome-plated brass			
accessories for	515042			
	GEV No.	515051	Ref. No.	—
	standpipe size 1 1/2" usable height 170mm overall height 185mm ED ø 40mm SS			
	GEV No.	515052	Ref. No.	—
	standpipe size 1 1/2" usable height 220mm overall height 235mm ED ø 40mm SS			
	GEV No.	515053	Ref. No.	3210110 3210150
	standpipe size 1 1/2" usable height 260mm overall height 275mm ED ø 40mm SS			
	GEV No.	515054	Ref. No.	—
	standpipe size 1 1/2" usable height 310mm overall height 325mm ED ø 40mm SS			
	GEV No.	515062	Ref. No.	—
	standpipe size 1 1/2" usable height 190mm overall height 200mm ED ø 46mm chrome-plated brass with filter			
	GEV No.	515063	Ref. No.	—
	standpipe size 1 1/2" usable height 230mm overall height 240mm ED ø 46mm chrome-plated brass with filter			
	GEV No.	515064	Ref. No.	—
	standpipe size 1 1/2" usable height 280mm overall height 290mm ED ø 46mm chrome-plated brass with filter			



1 1/2"			
1			
GEV No.	515042	Ref. No.	3210110 3210150
description	drain fitting size 1 1/2" usable heightmm overall height 32mm ED ø 69mm chrome-plated brass		
accessories for	515042		
	GEV No.	515051	Ref. No. —
	standpipe size 1 1/2" usable height 170mm overall height 185mm ED ø 40mm SS		
	GEV No.	515052	Ref. No. —
	standpipe size 1 1/2" usable height 220mm overall height 235mm ED ø 40mm SS		
	GEV No.	515053	Ref. No. 3210110 3210150
	standpipe size 1 1/2" usable height 260mm overall height 275mm ED ø 40mm SS		
	GEV No.	515054	Ref. No. —
	standpipe size 1 1/2" usable height 310mm overall height 325mm ED ø 40mm SS		
	GEV No.	515062	Ref. No. —
	standpipe size 1 1/2" usable height 190mm overall height 200mm ED ø 46mm chrome-plated brass with filter		
	GEV No.	515063	Ref. No. —
	standpipe size 1 1/2" usable height 230mm overall height 240mm ED ø 46mm chrome-plated brass with filter		
	GEV No.	515064	Ref. No. —
	standpipe size 1 1/2" usable height 280mm overall height 290mm ED ø 46mm chrome-plated brass with filter		

1			
GEV No.	515053	Ref. No.	3210110 3210150
description	standpipe size 1 1/2" usable height 260mm overall height 275mm ED ø 40mm SS		
accessories for	515053		
	GEV No.	515042	Ref. No. 3210110 3210150
	drain fitting size 1 1/2" usable heightmm overall height 32mm ED ø 69mm chrome-plated brass		









1			
GEV No.	515042	Ref. No.	3210110 3210150
description	drain fitting size 1 1/2" usable heightmm overall height 32mm ED ø 69mm chrome-plated brass		
accessories for	515042		
	GEV No.	515051	Ref. No. —
	standpipe size 1 1/2" usable height 170mm overall height 185mm ED ø 40mm SS		
	GEV No.	515052	Ref. No. —
	standpipe size 1 1/2" usable height 220mm overall height 235mm ED ø 40mm SS		
	GEV No.	515053	Ref. No. 3210110 3210150
	standpipe size 1 1/2" usable height 260mm overall height 275mm ED ø 40mm SS		
	GEV No.	515054	Ref. No. —
	standpipe size 1 1/2" usable height 310mm overall height 325mm ED ø 40mm SS		
	GEV No.	515062	Ref. No. —
	standpipe size 1 1/2" usable height 190mm overall height 200mm ED ø 46mm chrome-plated brass with filter		
	GEV No.	515063	Ref. No. —
	standpipe size 1 1/2" usable height 230mm overall height 240mm ED ø 46mm chrome-plated brass with filter		
	GEV No.	515064	Ref. No. —
	standpipe size 1 1/2" usable height 280mm overall height 290mm ED ø 46mm chrome-plated brass with filter		

1			
GEV No.	515042	Ref. No.	3210110 3210150
description	drain fitting size 1 1/2" usable heightmm overall height 32mm ED ø 69mm chrome-plated brass		
accessories for	515042		
	GEV No.	515051	Ref. No. —
	standpipe size 1 1/2" usable height 170mm overall height 185mm ED ø 40mm SS		
	GEV No.	515052	Ref. No. —
	standpipe size 1 1/2" usable height 220mm overall height 235mm ED ø 40mm SS		
	GEV No.	515053	Ref. No. 3210110 3210150
	standpipe size 1 1/2" usable height 260mm overall height 275mm ED ø 40mm SS		
	GEV No.	515054	Ref. No. —
	standpipe size 1 1/2" usable height 310mm overall height 325mm ED ø 40mm SS		
	GEV No.	515062	Ref. No. —
	standpipe size 1 1/2" usable height 190mm overall height 200mm ED ø 46mm chrome-plated brass with filter		
	GEV No.	515063	Ref. No. —
	standpipe size 1 1/2" usable height 230mm overall height 240mm ED ø 46mm chrome-plated brass with filter		

Table continues overleaf



accessories for	515042		
	GEV No.	515064	Ref. No. —
	standpipe size 1½" usable height 280mm overall height 290mm ED ø 46mm chrome-plated brass with filter		

			
1			
GEV No.	515042	Ref. No.	3210110 3210150
description	drain fitting size 1½" usable heightmm overall height 32mm ED ø 69mm chrome-plated brass		
accessories for	515042		
	GEV No.	515051	Ref. No. —
	standpipe size 1½" usable height 170mm overall height 185mm ED ø 40mm SS		
	GEV No.	515052	Ref. No. —
	standpipe size 1½" usable height 220mm overall height 235mm ED ø 40mm SS		
	GEV No.	515053	Ref. No. 3210110 3210150
	standpipe size 1½" usable height 260mm overall height 275mm ED ø 40mm SS		
	GEV No.	515054	Ref. No. —
	standpipe size 1½" usable height 310mm overall height 325mm ED ø 40mm SS		
	GEV No.	515062	Ref. No. —
	standpipe size 1½" usable height 190mm overall height 200mm ED ø 46mm chrome-plated brass with filter		
	GEV No.	515063	Ref. No. —
	standpipe size 1½" usable height 230mm overall height 240mm ED ø 46mm chrome-plated brass with filter		
	GEV No.	515064	Ref. No. —
	standpipe size 1½" usable height 280mm overall height 290mm ED ø 46mm chrome-plated brass with filter		

C

compressors	4
cooling aggregates	4
cross flow fans	4

D

drain fittings	8
drain systems and wash basins	8
drawer latches	5

E

edgemount latches	5
electronic controllers	3
evaporators	8

F

fans	4
------	---

H

handle latches	5
----------------	---

P

plug-in gaskets	7
-----------------	---

R

refrigeration fans	4
refrigeration gaskets	7
refrigeration thermostats	3
rocker/momentary rocker switches	3

S

screw-in gaskets	7
snap locks	6
standpipes	8
switches and momentary switches	3

T

thermostats	3
-------------	---