



GAS COMPONENTS



ELECTRIC COMPONENTS



WATER TECHNOLOGY



MECHANICAL COMPONENTS



TOOLS

Spare parts suitable for

ANGELO-PO

Find the complete and up-to-date range of products in our GEV Webshop



Manufacturer catalogue

The most important spare parts and accessories arranged clearly for every manufacturer

- ✓ Complete product range and all appliance data always up to date in the GEV Webshop
- ✓ Alphabetical Index at the end of the catalogue

GEV Webshop

www.gev-online.co.uk

www.gev-online.com



- 🔍 Add to Favourites
- 🔍 Sign In with email address and usual password
- 🔍 Easy-order – place several items in your basket at the same time
- 🔍 Quick Item search – no login needed



heating elements

heating elements for ovens

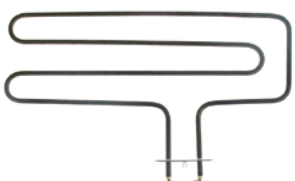

1

GEV No.	418596	Ref. No.	32G1590 32G1591
description	heating element 2600W 230V L 265mm W 510mm L1 93mm W2 62mm flange length 100mm flange width 22mm hole distance 86mm hole ø 5mm		
For models:	1G1FA0E, 1G1FA0EV, 1G1PE1E, 1G1PE1EV, 1G1PE2E, 1G1PE2EV, 2G1PE1E, 2G1PE1EV, 2G1PE2E, 2G1PE2EV, 31GE, 31TCE, 32TCE		

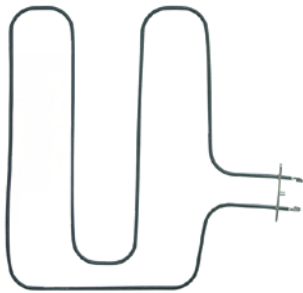

1

GEV No.	416677	Ref. No.	32G0151 32G1350 32G1351
description	heating element 2600W 400V L 460mm W 505mm L1 115mm L2 340mm W1 150mm W2 60mm flange length 100mm flange width 22mm hole distance 86mm hole ø 5mm tube ø 6.3mm connection male faston 6.3mm heating circuits 1 rectangular flange oven		
For models:	31GE, 31TCE, 32TCE		

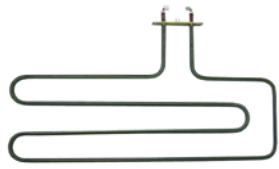

1

GEV No.	415673	Ref. No.	32G1621 32G1630
description	heating element 2600W 415V L 251mm W 510mm L1 89mm L2 162mm W1 287mm W2 63mm flange length 100mm flange width 22mm hole distance 86mm hole ø 5mm tube ø 8.7mm connection length 31mm connection male faston 6.3mm heating circuits 1 rectangular flange dry heating element oven		
For models:	1G1FA0E, 1G1FA0EV, 1G1PE1E, 1G1PE1EV, 1G1PE2E, 1G1PE2EV, 2G1FA0E, 2G1PE1E, 2G1PE1EV, 2G1PE2E, 2G1PE2EV, 31GE, 31TCE, 32TCE		

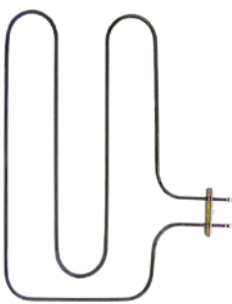

1

GEV No.	415169	Ref. No.	32G0950 32G0951 32G1601
description	heating element 2700W 380V L 450mm W 590mm L1 115mm L2 335mm W1 370mm W2 60mm flange length 100mm flange width 22mm hole distance 86mm hole ø 5mm tube ø 6.5mm connection male faston 6.3mm heating circuits 1 rectangular flange dry heating element		
For models:	08WFA4E, 08WFAAE, 10WTPGE, 12WFA6E, 12WFAAE, 191FAAE, 191FAE, 191FAG, 191PE4E, 1A1PE4E, 1A1PEFTE, 1A1FBE, 1D1PE4E, 1D1FBE, 6043590, 71E, 71GE, 71GEGG, FS30E		

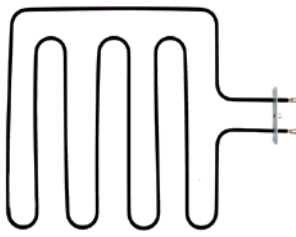

1

GEV No.	418641	Ref. No.	32G3250
description	heating element 2700W 400V heating circuits 1 L 465mm W 385mm L1 100mm L2 365mm W1 162mm W2 61mm flange length 100mm flange width 22mm hole distance 86mm hole ø 5mm tube ø 6.5mm connection male faston 6.3mm connection length 45mm mounting pos. upper rectangular flange dry heating element		
For models:	1G1FA0E, 1G1FA0EV, 1G1PE1E, 1G1PE1EV, 1G1PE2E, 1G1PE2EV, 2G1FA0E, 2G1PE1E, 2G1PE1EV, 2G1PE2E, 2G1PE2EV		

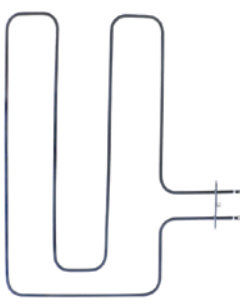

1

GEV No.	418837	Ref. No.	32G1220
description	heating element 2940W 230V L 455mm W 590mm L1 115mm L2 340mm W1 370mm W2 60mm flange length 100mm flange width 22mm hole distance 86mm hole ø 5mm tube ø 6.3mm connection length 55mm heating circuits 1 oven		
For models:	71E, FS30E		

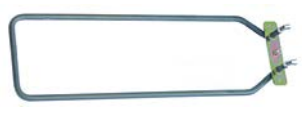

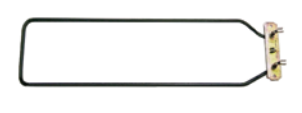

GEV No.	416676	Ref. No.	32G0160
description	heating element 800W 230V heating circuits 1 L 405mm W 122mm H 16mm L1 42mm L2 363mm W1 30mm W2 62mm flange length 100mm flange width 22mm hole distance 86mm hole ø M4mm tube ø 8.5mm connection male faston 6.3mm rectangular flange dry heating element		



GEV No.	415171	Ref. No.	32G0080
description	heating element 900W 230V heating circuits 1 L 430mm W 122mm H 28mm L1 55mm L2 375mm W1 30mm W2 62mm flange length 100mm flange width 22mm hole distance 86mm hole ø 4mm tube ø 6.3mm connection male faston 6.3mm rectangular flange dry heating element		

heating elements for bain maries



GEV No.	416683	Ref. No.	32G2220
description	heating element 1000W 230V heating circuits 1 L 480mm W 35mm flange length 70mm flange width 22mm hole distance 56mm connection length 28mm connection M4 tube ø 8.5mm rectangular flange hole ø 5.5mm dry heating element		
For models:	04WBMEV, 090BM1E, 0A0BME, 0B0BME, 0D0BME, 190BM2E, 1A0BME, 1D0BME, 6040110, 6042680		



GEV No.	416682	Ref. No.	32G0280
description	heating element 1450W 230V L 378mm W 252mm connection male faston 6.3mm tube ø 8.5mm 2 hole fixing thread 1/4" dry heating element water bath mounting distance 245mm		
For models:	030EBM, 031EBM, 0G0BME, 1G0BME		







GEV No.	418688	Ref. No.	32G1730
description	heating element 1500W 230V L 470mm W 305mm tube ø 8.5mm thread 1/4" bain marie mounting distance 297mm		
For models:	ACBM, ACBM218, ANBM, ANBM218, ANBM75, SE14VB, SE21VB, SI14VB, SI21VB, SL14CVB, SL14NVB, SL21CVB, SL21NVB, SL7NVB, TBM, TBM218		

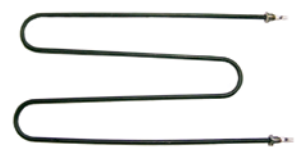

GEV No.	415173	Ref. No.	32G0070 32G0071
description	heating element 1600W 230V L 585mm W 200mm connection M6 tube ø 8.5mm 2 hole fixing thread M14x1.5 immersion heater mounting distance 184mm		
For models:	070BME, 071BME, 090BME, 091BME		
accessories for	415173		
	GEV No.	510417	Ref. No. —
	flat gasket fibre ED ø 20mm ID ø 14mm thickness 2mm Qty 1 pcs		
	GEV No.	520228	Ref. No. —
	tooth lock washer ID ø 15.3mm ED ø 24mm steel Qty 1 pcs for thread M14		
	GEV No.	520230	Ref. No. —
	nut thread M14x1.5 H 5mm WS 19 zinc-coated steel Qty 1 pcs		
	GEV No.	521101	Ref. No. —
	nut thread M14x1.5 H 5mm WS 19 SS Qty 1 pcs		
	GEV No.	550262	Ref. No. —
	flat gasket copper ED ø 20mm ID ø 14mm thickness 2mm		



GEV No.	415181	Ref. No.	32G1250
description	heating element 2000W 230V heating circuits 1 L 458mm W 208mm connection male faston 6.3mm tube ø 8.5mm 2 hole fixing thread M14x1 immersion heater mounting distance 200mm		
For models:	030BME, 031BME		
accessories for	415181		
	GEV No.	510417	Ref. No. —
	flat gasket fibre ED ø 20mm ID ø 14mm thickness 2mm Qty 1 pcs		
	GEV No.	520228	Ref. No. —
	tooth lock washer ID ø 15.3mm ED ø 24mm steel Qty 1 pcs for thread M14		
	GEV No.	521133	Ref. No. —
	nut thread M14x1.5 H 6mm WS 19 zinc-coated steel Qty 1 pcs		
	GEV No.	550261	Ref. No. —
	nut thread M14x1 H 4mm WS 19 SS Qty 1 pcs		
	GEV No.	550262	Ref. No. —
	flat gasket copper ED ø 20mm ID ø 14mm thickness 2mm		

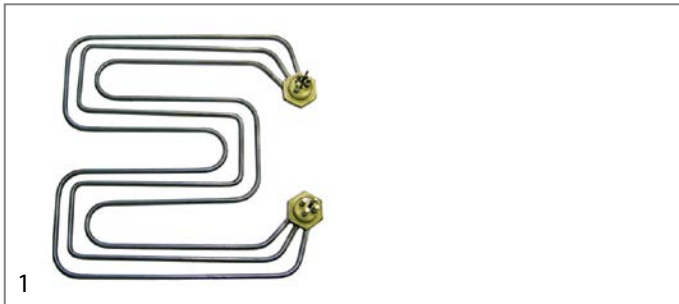

GEV No.	415175	Ref. No.	32G0650
description	heating element 4800W 220V heating circuits 3 L 410mm W 417mm connection M3 tube ø 8.5mm flange with thread thread 1¼" immersion heater H1 10mm H 19mm		
accessories for	415175		
	GEV No.	510405	Ref. No. N/A
	flat gasket fibre ED ø 56mm ID ø 42mm thickness 2mm for thread 1¼" Qty 1 pcs		
	GEV No.	520232	Ref. No. —
	nut thread 1¼" H 5mm nickel-plated brass WS 47 Qty 1 pcs		
	GEV No.	527169	Ref. No. —
	hexagonal nut thread M3 H 2.8mm WS 5.5 brass Qty 1 pcs		
	GEV No.	528021	Ref. No. —
	flat gasket PTFE ED ø 53mm ID ø 42.5mm thickness 3mm Qty 1 pcs equiv. no. 12001/02286 suitable for Astoria/Aurora/Brasilia/Wega		
	GEV No.	560110	Ref. No. —
	plain washer ID ø 3.2mm ED ø 7mm thickness 0.5mm SS Qty 20 pcs DIN 125A for thread M3		
	GEV No.	560130	Ref. No. —
	hexagonal nut thread M3 H 2.4mm WS 5.5 SS DIN/ISO DIN 934 / ISO 4032/8673 Qty 20 pcs		



GEV No.	415172	Ref. No.	32G0090
description	heating element 800W 230V L 405mm W 50mm connection male faston 6.3mm tube ø 8.5mm 2 hole fixing thread M12x1 dry heating element mounting distance 42mm		
For models:	0G0BME-VERS.032008, 1G0BME-VERS.032008		
spare parts for	415172		
	GEV No.	510417	Ref. No. —
	flat gasket fibre ED ø 20mm ID ø 14mm thickness 2mm Qty 1 pcs		
accessories for	415172		
	GEV No.	520229	Ref. No. —
	nut thread M12x1 H 4mm WS 16 zinc-coated steel Qty 1 pcs		
	GEV No.	521110	Ref. No. —
	flat gasket fibre ED ø 20mm ID ø 13mm thickness 2mm Qty 1 pcs		

heating elements for fryers

side connection

miscellaneous

heating elements



GEV No.	419049	Ref. No.	32G2610
description	heating element 7200W 230V L 300mm W 155mm		
For models:	04WFR3ED, 08WFR4ED, 091FR3E, 091FR3ED, 0A1FR3E, 0A1FR3ED, 0D1FR3E, 0D1FR3ED, 0G0FR3E, 0G0FR3ED, 191FR4E, 191FR4ED, 1A1FR4E, 1A1FR4ED, 1D1FR4E, 1D1FR4ED, 1G0FR4E, 6043840, 6043970		
accessories for	419049		
	GEV No.	510219	Ref. No. 60A0980
	O-ring set Qty 2 pcs		

off-center connection

miscellaneous



GEV No.	416589	Ref. No.	32G2400
description	heating element 18000W 400V heating circuits 3 mounting pos. left L 395mm W 270mm H 32mm flange length 20mm flange ø 53.5mm thermostat sleeves ø 7mm length thermostat sleeves 315mm number of thermostat sleeves 1 thermostat sleeve clinging L1 15mm L2 380mm W1 34mm W2 41mm tube ø 8.5mm cable length 2000mm rotation flange immersion heater fryer connection length 110mm		
For models:	091FR1E, 091FR1EA, 091FR1ED, 0A1FR1E, 0A1FR1ED, 0D1FR1E, 0D1FR1ED, 191FR2E, 191FR2ED, 1A1FR2E, 1A1FR2ED, 1D1FR2ED		
accessories for	416589		
	GEV No.	510219	Ref. No. 60A0980
	O-ring set Qty 2 pcs		
	GEV No.	550494	Ref. No. 3152150 3152151
	O-ring Viton thickness 3.53mm ID ø 47.22mm Qty 1 pcs		



2 hole fixing

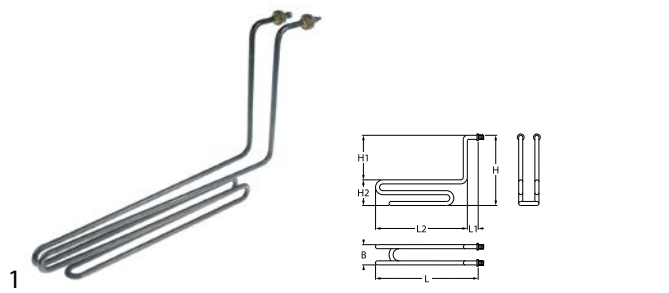

GEV No.	418597	Ref. No.	32G0060
description	heating element 2500W 230V heating circuits 1 L 460mm W 33mm H 275mm L1 45mm L2 415mm H1 220mm H2 55mm thread 1/4" tube ø 8.5mm windings 3		

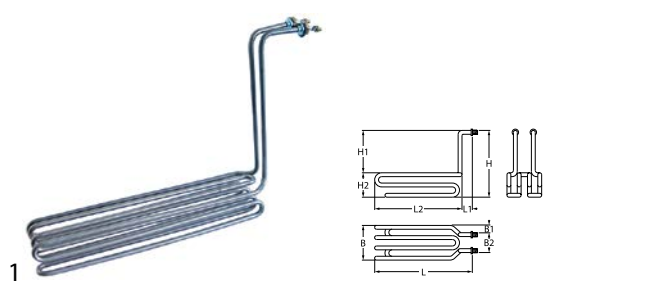

GEV No.	416588	Ref. No.	32G0100 32G1181
description	heating element 4700W 400V heating circuits 1 L 480mm W 90mm H 230mm L1 60mm L2 420mm W1 40mm W2 25mm H1 415mm H2 65mm thread 1/4" mounting distance 35mm tube ø 8.5mm 2 hole fixing connection M6 fryer windings 6		

For models: 70FE, 70FE1, 70FE1B, 71FE, 71FE2, 71FE2B

accessories for 416588

	GEV No.	560113	Ref. No.	3121480
	plain washer ID ø 6.4mm ED ø 12mm thickness 1.6mm SS Qty 20 pcs DIN 125A for thread M6			

	GEV No.	560133	Ref. No.	—
	hexagonal nut thread M6 H 5mm WS 10 SS DIN/ISO DIN 934 / ISO 4032/8673 Qty 20 pcs			

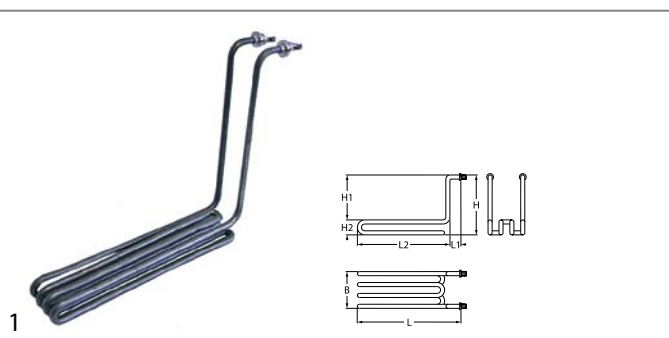

GEV No.	415180	Ref. No.	32G1241
description	heating element 2050W 230V heating circuits 1 L 305mm W 53mm H 245mm L1 30mm L2 275mm H1 210mm H2 35mm thread 1/4" mounting distance 22mm tube ø 8.5mm 2 hole fixing connection male faston 6.3mm fryer heaters windings 4		

For models: 030FE1, 030FE1B, 091FE28, 091FE28B, 30FES2, 30FES2B, 70FES2, 70FES2B

accessories for 415180

	GEV No.	361182	Ref. No.	3117580
	nut thread 1/4" H 5mm nickel-plated brass WS 17 Qty 1 pcs			

	GEV No.	510417	Ref. No.	—
	flat gasket fibre ED ø 20mm ID ø 14mm thickness 2mm Qty 1 pcs			

accessories for 415180	GEV No.	520228	Ref. No.	—
	tooth lock washer ID ø 15.3mm ED ø 24mm steel Qty 1 pcs for thread M14			
GEV No.	550262	Ref. No.	—	
	flat gasket copper ED ø 20mm ID ø 14mm thickness 2mm			

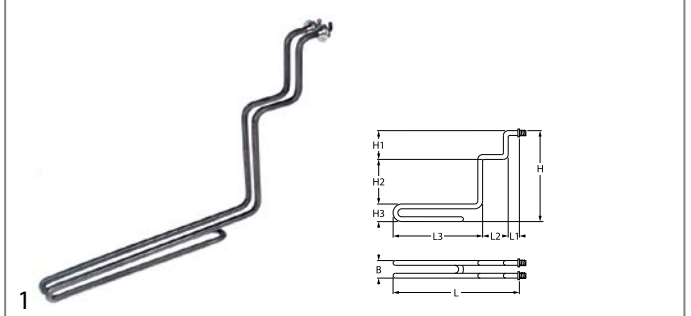

GEV No.	418760	Ref. No.	32G0130
description	heating element 1750W 230V L 415mm W 35mm H 260mm 2 hole fixing connection 6.3x0.8 heating circuits 1 L1 30mm L2 70mm L3 315mm H1 30mm H2 135mm H3 24mm tube ø 8.5mm thread M13 mounting distance 23mm connection length 7.5mm		

heating elements for griddles



GEV No.	416678	Ref. No.	32G1040
description	heating element 1700W 400V heating circuits 1 L 445mm W 75mm H 83mm tube ø 8.8mm connection male faston 6.3mm connection length 23mm griddle connection distance 66mm dry heating element		

For models: 031FTE04, 031FTE06



GEV No.	415179	Ref. No.	32G1260 32G1262
description	heating element 1750W 230V heating circuits 1 L 445mm W 82mm H 50mm tube ø 8.5mm connection M4 griddle connection distance 80mm dry heating element		

For models: 030FTE, 030FTE04, 031FTE, 031FTE04, 031FTE06



GEV No.	418481	Ref. No.	32G2371
description	heating element 2200W 230V heating circuits 1 L 615mm W 83.5mm H 89mm tube ø 8.5mm connection male faston 6.3mm connection length 21mm connection distance 75mm dry heating element		
For models:	090FT1E, 090FT2E, 090FT4E, 090FT5E, 090FT7E, 091FT1E, 091FT2E, 091FT4E, 091FT5E, 091FT7E, 0A0FT1E, 0A0FT2E, 0A0FT4E, 0A0FT5E, 0D0FT1E, 0D0FT2E, 0D0FT4E, 0D0FT5E, 190FT15E, 190FT1E, 190FT2E, 190FT3E, 190FT42E, 190FT4E, 190FT5E, 190FT6E, 190FT72E, 190FT7E, 191FT1E, 191FT2E, 191FT3E, 191FT4E, 191FT6E, 191FT7E, 1A0FT1E, 1A0FT2E, 1A0FT3E, 1A0FT4E, 1A0FT6E, 1A1PEFT6, 1D0FT1E, 1D0FT2E, 1D0FT3E, 1D0FT4E, 1D0FT6E		

GEV No.	416680	Ref. No.	32G2370
description	heating element 2200W 230V heating circuits 1 L 615mm W 86mm H 92mm tube ø 8.5mm connection male faston 6.3mm griddle connection distance 84mm dry heating element		
For models:	0A0FT1E, 0A0FT2E, 0A0FT4E, 0A0FT5E, 0D0FT1E, 0D0FT2E, 0D0FT4E, 0D0FT5E, 1A0FT1E, 1A0FT2E, 1A0FT3E, 1A0FT4E, 1A0FT6E, 1D0FT1E, 1D0FT2E, 1D0FT3E, 1D0FT4E, 1D0FT6E		



GEV No.	416679	Ref. No.	32G1870
description	heating element 2200W 400V heating circuits 1 L 572mm W 81mm H 85mm tube ø 8.5mm connection male faston 6.3mm griddle connection distance 75mm dry heating element		
For models:	070FTE04, 070FTE05, 071FTE04, 071FTE06, 090FTE04, 090FTE05, 091FTE04, 091FTE06		

heating elements for refrigeration

heating elements for defrosting

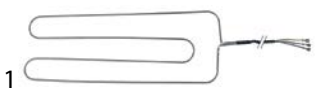

GEV No.	418600	Ref. No.	32G1021
description	heating element 160W 220V L 540mm W 170mm tube ø 4.5mm defrosting		
For models:	K16APGPZ, K16XPZAP, SA16AGB, SA16GB		



GEV No.	418609	Ref. No.	32G0350
description	heating element 2x110W 2x115V L 620mm cable length 2000mm tube ø 8.5mm defrosting		
For models:	65NB, 6BEABA, 6BEABB, 6BEABM, 6BEABZ, 6BEBBA, 6BEBBB, 6BEBBM, 6BEBBZ, 6BECBA, 6BECBB, 6BECBM, 6BECBZ, 6BMABA, 6BMABB, 6BMABM, 6BMABZ, 6MBBBA, 6MBBBB, 6MBBBM, 6MBBBZ, 6BMCBA, 6BMCBB, 6BMCBM, 6BMCBZ, 6RA, 6RA2, 6RA2A, 6RA2M, 6RA2Z, 6RA4, 6RA4A, 6RA4M, 6RA4Z, 6RAA, 6RAM, 6RAZ, 6RB, 6RB11, 6RB11A, 6RB11M, 6RB11Z, 6RB2, 6RB2A, 6RB2M, 6RB2Z, 6RB4, 6RB4A, 6RB4M, 6RB4Z...(Other models you can see in the webshop)		

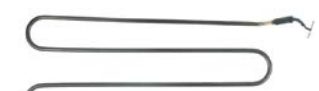

GEV No.	418594	Ref. No.	32G1970
description	heating element 400W 220V L 480mm W 140mm H 80mm cable length 1000mm tube ø 8.5mm defrosting		
For models:	S60B, S60B-2, S60BE, S60BX, S60BX-2		

heating elements for tilting bratt pan



GEV No.	416595	Ref. No.	32G1920 32G1921
description	heating element 1500W 230V L 415mm W 82mm H 50mm connection M4 dry heating element heating circuits 1 tube ø 8.5mm connection distance 65mm		
For models:	31RE		



GEV No.	416596	Ref. No.	32G0251
description	heating element 1750W 230V L 500mm W 81mm H 50mm connection M4 dry heating element heating circuits 1 tube ø 8.5mm L1 18mm W1 10mm W2 47mm connection distance 73mm		
For models:	71ARE, 91ARE		





GEV No.	416597	Ref. No.	32G2481
description	heating element 2000W 230V L 530mm W 93mm H 70mm connection M4 dry heating element heating circuits 1 tube ø 8.5mm connection distance 83mm		
For models:	191BR1E, 191BR2E, 191BR2EA, 1A1BR1E, 1A1BR2E, 1A1BR2EA, 1D1BR1E, 1D1BR2E, 1D1BR2EA, 291BR1E, 291BR2E, 291BR2EA, 2A1BR1E, 2A1BR2E, 2A1BR2EA, 2D1BR1E, 2D1BR2E, 2D1BR2EA		

heating elements for pasta cookers











GEV No.	415020	Ref. No.	32G0230 32G0380
description	heating element 4500W 230V mounting ø 57.5mm heating circuits 3 L 355mm W 35mm H 47mm number of thermostat sleeves 1 thermostat sleeves ø 7mm length thermostat sleeves 295mm thermostat sleeve upper tube ø 8.5mm hole distance 70mm hole ø 10mm connection length 25mm connection male faston 6.3mm 3 hole flange immersion heater		
For models:	0G1CP1EC, F60P, F60PR, F60T, L100, L40S, L60, L80		





GEV No.	418602	Ref. No.	32G3270	
description	heating element 4500W 400V heating circuits 3 L 315mm W 36mm H 48mm thermostat sleeves ø 7.5mm length thermostat sleeves 285mm hole distance 72mm mounting ø 57.5mm number of thermostat sleeves 1 thermostat sleeve eccentric, non clinging			
For models:	0G1CP1E, 0G1CP1EC, 0G1CP1E-VERS.2004, 1G1PI1E, 6043850, 6043980			
accessories for	418602			
	GEV No.	510409	Ref. No.	3150430 3151960 37Q5260
O-ring EPDM thickness 5.34mm ID ø 56.52mm Qty 1 pcs				





			
GEV No.	415182	Ref. No.	32G1300 32G1301 32G1930
description	heating element 4540W 230V heating circuits 3 L 323mm W 36mm H 48mm round flange connection M4 tube ø 8.5mm thermostat sleeves ø 7.5mm length thermostat sleeves 300mm mounting ø 57.5mm number of thermostat sleeves 1 thermostat sleeve eccentric, clinging pasta cooker		
For models:	30CPSE, 70CPE, 90CPE		
spare parts for	415182		
	GEV No.	510409	Ref. No. 3150430 3151960 37Q5260
	O-ring EPDM thickness 5.34mm ID ø 56.52mm Qty 1 pcs		
accessories for	415182		
	GEV No.	521103	Ref. No. N/A
	nut thread M4 H 3mm WS 7 brass Qty 20 pcs		
	GEV No.	521104	Ref. No. —
	washer ID ø 4.3mm ED ø 8mm thickness 0.5mm brass Qty 20 pcs for thread M4		
	GEV No.	550002	Ref. No. 3113780
	tension strap H 10mm L 21mm W 10mm hole ø 6.5mm for heating element		
	GEV No.	560111	Ref. No. —
	plain washer ID ø 4.3mm ED ø 9mm thickness 0.8mm SS Qty 20 pcs DIN 125A for thread M4		
	GEV No.	560131	Ref. No. —
	hexagonal nut thread M4 H 3.2mm WS 7 SS DIN/ISO DIN 934 / ISO 4032/8673 Qty 20 pcs		

			
GEV No.	416681	Ref. No.	32G2310
description	heating element 6000W 400V heating circuits 3 L 485mm W 37mm H 40mm 3 hole flange connection M4 tube ø 8.5mm thermostat sleeves ø 7mm length thermostat sleeves 445mm hole distance 70mm mounting ø 57.5mm hole ø 10mm number of thermostat sleeves 1 connection length 30mm thermostat sleeve upper pasta cooker		
For models:	04WCP1EM, 091CP1E, 0A1CP1E, 0D1CP1E, 6040090, 6040310		
spare parts for	416681		
	GEV No.	510409	Ref. No. 3150430 3151960 37Q5260
	O-ring EPDM thickness 5.34mm ID ø 56.52mm Qty 1 pcs		

heating elements for chargrills

			
GEV No.	415148	Ref. No.	32G0140
description	heating element 750W 230V L 519mm W 35mm H 105mm 2 hole fixing mounting distance 26mm connection male faston 6.3mm L1 30mm L2 489mm tube ø 8.5mm dry heating element thread 1/4"		
accessories for	415148		
	GEV No.	361182	Ref. No. 3117580
	nut thread 1/4" H 5mm nickel-plated brass WS 17 Qty 1 pcs		

accessories for	415148		
	GEV No.	510417	Ref. No. —
	flat gasket fibre ED ø 20mm ID ø 14mm thickness 2mm Qty 1 pcs		
	GEV No.	520228	Ref. No. —
	tooth lock washer ID ø 15.3mm ED ø 24mm steel Qty 1 pcs for thread M14		
	GEV No.	550262	Ref. No. —
	flat gasket copper ED ø 20mm ID ø 14mm thickness 2mm		

heating elements for salamanders/toast-

			
GEV No.	415758	Ref. No.	32G1441 32G1580
description	heating element 1300W 230V heating circuits 1 L 238mm W 132mm H 72mm connection distance 124mm tube ø 8.5mm cable length 900mm dry heating element connection length 20mm		
For models:	60SME		

heating elements for heating bridges

			
GEV No.	418202	Ref. No.	3003800
description	heating element 500W 220V heating circuits 1 L 485mm Wmm lug length 40mm lug width 18mm connection M5 tube ø 6.3mm rectangular flange hole ø M4mm dry heating element		

heating cables

connection on both sides

with male fastons

			
GEV No.	418761	Ref. No.	32G2420
description	heating cable 25W 230V L 5000mm ø 4mm		
For models:	40CP-OPR01, 40CPX-OPR01, AF1B, AF1B-OPR01, AF1N, AF1N-OPR01, AF2B, AF2B-OPR01, AF2N, AF2N-OPR01, CX120, CX120B, CX120NN, CX130B, CX140, CX140B, CX140BN, CX140BR, CX140CP, CX140NN, CX140PV, CX140R, CX150B, CX150BN, CX150BR, CX150CP, CX150R, CX55, CX55B, CX60B, CX65, CX652, CX65B, CX65BR, CX65NB, CX65NCP, CX65NN, CX65PV, CX65R, CX70B, CX70BR, CX70NB, CX70NN, CX70R, FG2B, FSD1B, FSD1N, FSD2B, FSD2N, FSD2N2...(Other models you can see in the webshop)		

			
GEV No.	420382	Ref. No.	32G3290
description	heating cable 31W 230V L 5000mm for blast chiller connection male faston		
For models:	DS31, DS31A, DS31C, DS31M, DS51, DS51A, DS51C, DS51M, IS51, IS51A, IS51AR, IS51C, IS51CR, IS51M, IS51MR, IS51R, IS51W, IS51WA, IS51WC, IS51WM, SM03LT7, SM03LT7A, SM03LT7M, SM1L7, SM1L7A, SM1L7FCV, SM1L7M, SM1LT7, SM1LT7A, SM1LT7M		

GEV No.	420383	Ref. No.	32G2280
description	heating cable 45W 230V L 6000mm for blast chiller connection male faston		
For models:	IS101L, IS101LR, IS101LW, IS101S, IS101SR, IS101SW, SM2L, SM2LR, SM2LW, SM2S, SM2SR, SM2SW		



GEV No.	420384	Ref. No.	32G3500
description	heating cable 53W 230V L 6800mm for blast chiller connection male faston		
For models:	IS102S, IS102SR, IS102SR-0NR01, IS102SW, IS72S, IS72SR, IS72SW		



GEV No.	418755	Ref. No.	32G1820
description	heating cable 80W 220V \varnothing 3mm connection male faston 6.3mm cable length 5250mm		
For models:	135BN, 135BNX, 135CPX, 135NN, 135NNX, 40CP, 40CPX, 55B, 65, 65B, 65BA, 65BX, 65BX-2, 65BXE, 65BXR, 65NB, 65NBX, 65PVX, 65X, 65X-2, 65XR, SP120BN, SP120NN, SP135BN, SP135CP, SP135NN, SP55, SP55B, SP65, SP65B, SP65NB		

connection on both sides (metal braided)





GEV No.	419170	Ref. No.	32G0240
description	heating cable 100W 230V L1 (unheated) 600mm L2 (heated) 6600mm \varnothing 4mm Qty 1		
For models:	6BEA11A, 6BEA11B, 6BEA11M, 6BEA11Z, 6BEA2A, 6BEA2B, 6BEA2M, 6BEA2Z, 6BEA3A, 6BEA3B, 6BEA3M, 6BEA3Z, 6BEA4, 6BEA4B, 6BEA4M, 6BEA4Z, 6BEA5, 6BEA5B, 6BEA5M, 6BEA5Z, 6BEA6, 6BEA6B, 6BEA6M, 6BEA6Z, 6BEA7, 6BEA7B, 6BEA7M, 6BEA7Z, 6BEA8, 6BEA8B, 6BEA8M, 6BEA8Z, 6BEA9, 6BEA9B, 6BEA9M, 6BEA9Z, 6BEA10, 6BEA10B, 6BEA10M, 6BEA10Z, 6BEA11, 6BEA11B, 6BEA11M, 6BEA11Z, 6BEA12, 6BEA12B, 6BEA12M, 6BEA12Z, 6BEA13, 6BEA13B, 6BEA13M, 6BEA13Z, 6BEA14, 6BEA14B, 6BEA14M, 6BEA14Z, 6BEA15, 6BEA15B, 6BEA15M, 6BEA15Z, 6BEA16, 6BEA16B, 6BEA16M, 6BEA16Z, 6BEA17, 6BEA17B, 6BEA17M, 6BEA17Z, 6BEA18, 6BEA18B, 6BEA18M, 6BEA18Z, 6BEA19, 6BEA19B, 6BEA19M, 6BEA19Z, 6BEA20, 6BEA20B, 6BEA20M, 6BEA20Z, 6BEA21, 6BEA21B, 6BEA21M, 6BEA21Z, 6BEA22, 6BEA22B, 6BEA22M, 6BEA22Z, 6BEA23, 6BEA23B, 6BEA23M, 6BEA23Z, 6BEA24, 6BEA24B, 6BEA24M, 6BEA24Z, 6BEA25, 6BEA25B, 6BEA25M, 6BEA25Z, 6BEA26, 6BEA26B, 6BEA26M, 6BEA26Z, 6BEA27, 6BEA27B, 6BEA27M, 6BEA27Z, 6BEA28, 6BEA28B, 6BEA28M, 6BEA28Z, 6BEA29, 6BEA29B, 6BEA29M, 6BEA29Z, 6BEA30, 6BEA30B, 6BEA30M, 6BEA30Z, 6BEB11M, 6BEB11Z, 6BEB22A, 6BEB22B, 6BEB22M, 6BEB22Z, 6BEB23, 6BEB23B, 6BEB23M, 6BEB23Z, 6BEB24, 6BEB24B, 6BEB24M, 6BEB24Z, 6BEB25, 6BEB25B, 6BEB25M, 6BEB25Z, 6BEB26, 6BEB26B, 6BEB26M, 6BEB26Z, 6BEB27, 6BEB27B, 6BEB27M, 6BEB27Z, 6BEB28, 6BEB28B, 6BEB28M, 6BEB28Z, 6BEB29, 6BEB29B, 6BEB29M, 6BEB29Z, 6BEB30, 6BEB30B, 6BEB30M, 6BEB30Z, 6BEB31, 6BEB31B, 6BEB31M, 6BEB31Z, 6BEB32, 6BEB32B, 6BEB32M, 6BEB32Z, 6BEB33, 6BEB33B, 6BEB33M, 6BEB33Z, 6BEB34, 6BEB34B, 6BEB34M, 6BEB34Z, 6BEB35, 6BEB35B, 6BEB35M, 6BEB35Z, 6BEB36, 6BEB36B, 6BEB36M, 6BEB36Z, 6BEB37, 6BEB37B, 6BEB37M, 6BEB37Z, 6BEB38, 6BEB38B, 6BEB38M, 6BEB38Z, 6BEB39, 6BEB39B, 6BEB39M, 6BEB39Z, 6BEB40, 6BEB40B, 6BEB40M, 6BEB40Z, 6BEB41, 6BEB41B, 6BEB41M, 6BEB41Z, 6BEB42, 6BEB42B, 6BEB42M, 6BEB42Z, 6BEB43, 6BEB43B, 6BEB43M, 6BEB43Z, 6BEB44, 6BEB44B, 6BEB44M, 6BEB44Z, 6BEB45, 6BEB45B, 6BEB45M, 6BEB45Z, 6BEB46, 6BEB46B, 6BEB46M, 6BEB46Z, 6BEB47, 6BEB47B, 6BEB47M, 6BEB47Z, 6BEB48, 6BEB48B, 6BEB48M, 6BEB48Z, 6BEB49, 6BEB49B, 6BEB49M, 6BEB49Z, 6BEB50, 6BEB50B, 6BEB50M, 6BEB50Z, 6BEB51, 6BEB51B, 6BEB51M, 6BEB51Z, 6BEB52, 6BEB52B, 6BEB52M, 6BEB52Z, 6BEB53, 6BEB53B, 6BEB53M, 6BEB53Z, 6BEB54, 6BEB54B, 6BEB54M, 6BEB54Z, 6BEB55, 6BEB55B, 6BEB55M, 6BEB55Z, 6BEB56, 6BEB56B, 6BEB56M, 6BEB56Z, 6BEB57, 6BEB57B, 6BEB57M, 6BEB57Z, 6BEB58, 6BEB58B, 6BEB58M, 6BEB58Z, 6BEB59, 6BEB59B, 6BEB59M, 6BEB59Z, 6BEB60, 6BEB60B, 6BEB60M, 6BEB60Z, 6BEB61, 6BEB61B, 6BEB61M, 6BEB61Z, 6BEB62, 6BEB62B, 6BEB62M, 6BEB62Z, 6BEB63, 6BEB63B, 6BEB63M, 6BEB63Z, 6BEB64, 6BEB64B, 6BEB64M, 6BEB64Z, 6BEB65, 6BEB65B, 6BEB65M, 6BEB65Z, 6BEB66, 6BEB66B, 6BEB66M, 6BEB66Z, 6BEB67, 6BEB67B, 6BEB67M, 6BEB67Z, 6BEB68, 6BEB68B, 6BEB68M, 6BEB68Z, 6BEB69, 6BEB69B, 6BEB69M, 6BEB69Z, 6BEB70, 6BEB70B, 6BEB70M, 6BEB70Z, 6BEB71, 6BEB71B, 6BEB71M, 6BEB71Z, 6BEB72, 6BEB72B, 6BEB72M, 6BEB72Z, 6BEB73, 6BEB73B, 6BEB73M, 6BEB73Z, 6BEB74, 6BEB74B, 6BEB74M, 6BEB74Z, 6BEB75, 6BEB75B, 6BEB75M, 6BEB75Z, 6BEB76, 6BEB76B, 6BEB76M, 6BEB76Z, 6BEB77, 6BEB77B, 6BEB77M, 6BEB77Z, 6BEB78, 6BEB78B, 6BEB78M, 6BEB78Z, 6BEB79, 6BEB79B, 6BEB79M, 6BEB79Z, 6BEB80, 6BEB80B, 6BEB80M, 6BEB80Z, 6BEB81, 6BEB81B, 6BEB81M, 6BEB81Z, 6BEB82, 6BEB82B, 6BEB82M, 6BEB82Z, 6BEB83, 6BEB83B, 6BEB83M, 6BEB83Z, 6BEB84, 6BEB84B, 6BEB84M, 6BEB84Z, 6BEB85, 6BEB85B, 6BEB85M, 6BEB85Z, 6BEB86, 6BEB86B, 6BEB86M, 6BEB86Z, 6BEB87, 6BEB87B, 6BEB87M, 6BEB87Z, 6BEB88, 6BEB88B, 6BEB88M, 6BEB88Z, 6BEB89, 6BEB89B, 6BEB89M, 6BEB89Z, 6BEB90, 6BEB90B, 6BEB90M, 6BEB90Z, 6BEB91, 6BEB91B, 6BEB91M, 6BEB91Z, 6BEB92, 6BEB92B, 6BEB92M, 6BEB92Z, 6BEB93, 6BEB93B, 6BEB93M, 6BEB93Z, 6BEB94, 6BEB94B, 6BEB94M, 6BEB94Z, 6BEB95, 6BEB95B, 6BEB95M, 6BEB95Z, 6BEB96, 6BEB96B, 6BEB96M, 6BEB96Z, 6BEB97, 6BEB97B, 6BEB97M, 6BEB97Z, 6BEB98, 6BEB98B, 6BEB98M, 6BEB98Z, 6BEB99, 6BEB99B, 6BEB99M, 6BEB99Z, 6BEB100, 6BEB100B, 6BEB100M, 6BEB100Z, 6BEC11A, 6BEC11B...(Other models you can see in the webshop)		



GEV No.	419109	Ref. No.	32G1810
description	heating cable 150W 220V L1 (unheated) 2x1000mm L2 (heated) 5000mm \varnothing 3.5mm L 7000mm connection male faston 6.3mm		
For models:	120B, 135, 135-4, 135B, 135BA, 135BX, 135BXE, 135BXR, 135PVX, 135X, 135X-3, 135X-4, 135XR, ISP202R, ISR201R, ISR202R, SP120, SP120B, SP135, SP135B		

heating cartridges



GEV No.	418892	Ref. No.	32G3310
description	heating cartridge 300W 230V \varnothing 12mm L 240mm thread 3/8" cable length 2000mm immersion heater		
For models:	AF1N, AF1N-0PR01, AF2N, AF2N-0PR01, CX120, CX120NN, CX130, CX130NN, CX140, CX140BN, CX140BR, CX140CP, CX140NN, CX140PV, CX140R, CX150, CX150BN, CX150BR, CX150CP, CX150NN, CX150PV, CX150R, CX55, CX60, CX65, CX652, CX65BR, CX65NB, CX65NCP, CX65NN, CX65PV, CX65R, CX70, CX702, CX70BR, CX70NB, CX70NN, CX70PV, CX70R, FSD1N, FSD2N, FSD2N2, FSDR1B-0PR01, FSDR1N-0PR01, FSDR2B-0PR01, FSDR2B2-0PR01, FSDR2N, FSDR2N-0PR01, FSDR2N2-0PR01, FSE2N...(Other models you can see in the webshop)		
accessories for	418892		
		GEV No.	511472
		Ref. No.	—
			nut thread 3/8" H 4mm brass WS 21 Qty 1 pcs
		GEV No.	518393
		Ref. No.	—
			flat gasket FIBER ED \varnothing 24mm ID \varnothing 17mm thickness 2mm Qty 1 pcs



GEV No.	417747	Ref. No.	3134541
description	heating cartridge 150W 230V \varnothing 10mm L 165mm connection female faston 6.3mm cable length 520mm		

heater battery



GEV No.	415122	Ref. No.	32G1990
description	heater battery mounting distance 185mm W 40mm H 35mm 2000W 230V temperature restriction 105°C heating circuits 2 connection cable cable length 340mm L 197mm for cross flow fan		

coil heating elements



GEV No.	419164	Ref. No.	32G2200
description	heating element 1500W 230V L 345mm W 95mm thread 3/8" connection M6 connection length 46mm dishwasher dry heating element heating circuits 1 2 hole fixing		
For models:	TA9C, TA9C-VERS.2006		

immersion heating elements

3 hole flange ø38.5mm

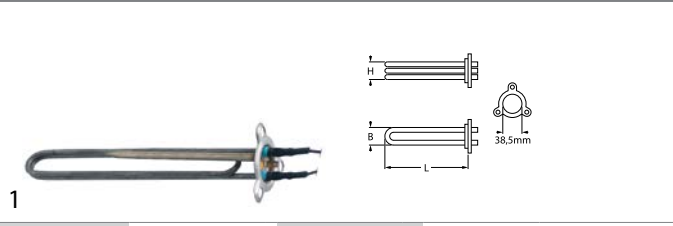

GEV No.	416277	Ref. No.	3030200
----------------	--------	-----------------	---------

description heating element 2800W 230V mounting ø 38.5mm heating circuits 1 L 302mm W 37mm H 28mm number of thermostat sleeves 1 thermostat sleeves ø 7mm length thermostat sleeves 199mm thermostat sleeve not clinging tube ø 6.4mm hole distance 57mm hole ø 10mm cable length 114mm 3 hole flange connection 26 immersion heater

accessories for 416277

	GEV No.	532577	Ref. No.	—
O-ring EPDM thickness 5.34mm ID ø 40.65mm Qty 1 pcs				

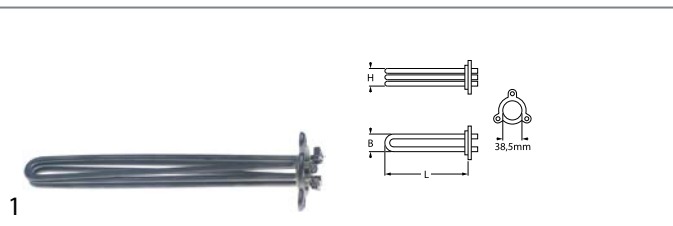

GEV No.	420037	Ref. No.	3104990
----------------	--------	-----------------	---------

description heating element 4000W 230V mounting ø 38.5mm heating circuits 3 L 300mm W 33mm H 27mm tube ø 6.4mm hole distance 57mm hole ø 10mm connection male faston 6.3mm vertical

For models: KD40, KD40PS, KD40-VERS.112009

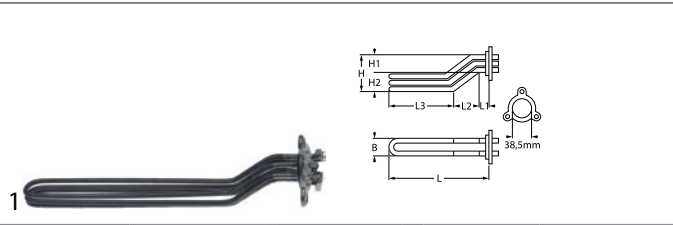

GEV No.	420061	Ref. No.	3075840
----------------	--------	-----------------	---------

description heating element 3500W 230V heating circuits 3 L 366mm W 35mm H 60mm L1 30mm L2 56mm L3 280mm H1 36mm H2 24mm hole distance 57mm hole ø 10mm tube ø 6.2mm connection male faston 6.3mm

For models: LF50EM

accessories for 420061

	GEV No.	532577	Ref. No.	—
O-ring EPDM thickness 5.34mm ID ø 40.65mm Qty 1 pcs				

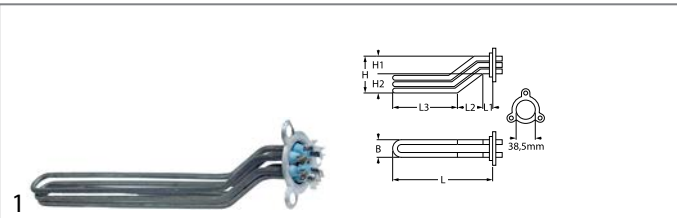

GEV No.	416267	Ref. No.	32G2140
----------------	--------	-----------------	---------

description heating element 4500W 230V mounting ø 38.5mm heating circuits 3 L 358mm W 32mm H 58mm L1 36mm L2 72mm L3 250mm H1 28mm H2 30mm hole distance 57mm hole ø 10mm tube ø 6.3mm connection male faston 6.3mm immersion heater 3 hole flange

For models: CS243D, CS243D-VERS.2006, CS243S, CS243VD, CS243VS, CS370AD, CS370AD-VERS.2006, CS370AS, CS370AS-VERS.2006, CS370AVD, CS370AVS, CS370D, CS370D-VERS.2006, CS370S, CS370S-VERS.2006, CS370VD, CS370VS, CS466AD, CS466AD-VERS.2006, CS466AS, CS466AS-VERS.2006, CS466AVD, CS466AVS, CS466D, CS466D-VERS.2006, CS466S, CS466S-VERS.2006, CS466VD, CS466VS, LF50E, LF50EMPS, LF50EM-VERS.122012, LF50E-VERS.122012, LF50E-VERS.2007, N303D, N303S, N303VD, N303VS, N354D, N354S, N354VD, N354VS, N506D, N506S, N506VD, N506VS, N607D, N607S, N607VD, N607VS

accessories for 416267

	GEV No.	532577	Ref. No.	—
O-ring EPDM thickness 5.34mm ID ø 40.65mm Qty 1 pcs				

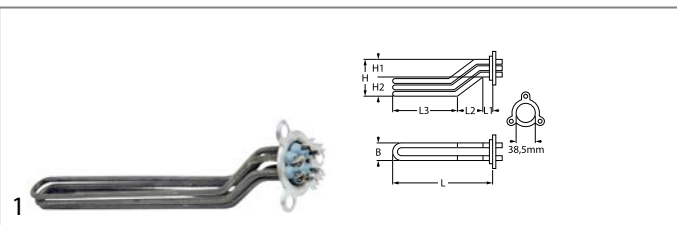

GEV No.	416268	Ref. No.	32G2180
----------------	--------	-----------------	---------

description heating element 6000W 230V mounting ø 38.5mm heating circuits 3 L 360mm W 34mm H 55mm L1 35mm L2 70mm L3 255mm H1 27mm H2 28mm hole distance 57mm hole ø 10mm tube ø 6.3mm connection male faston 6.3mm immersion heater 3 hole flange

spare parts for 416268

	GEV No.	532577	Ref. No.	—
O-ring EPDM thickness 5.34mm ID ø 40.65mm Qty 1 pcs				



3 hole flange ø 38.5mm

GEV No.	416269	Ref. No.	32G2170
description	heating element 8000W 230V mounting ø 38.5mm heating circuits 3 L 545mm W 32mm H 60mm L1 38mm L2 55mm L3 447mm H1 27mm H2 33mm hole distance 57mm hole ø 10mm tube ø 6.3mm connection male faston 6.3mm immersion heater 3 hole flange		
For models:	C165D, C165S, C165VD, C165VS, C207D, C207D-VERS.2006, C207S, C207S-VERS.2006, C207VD, C207VS, C304AD, C304AD-VERS.2006, C304AS, C304AS-VERS.2006, C304AVD, C304AVS, C304D, C304D-VERS.2006, C304S, C304S-VERS.2006, C304VD, C304VS, C92D-VERS.2006, C92S-VERS.2006, CS243D, CS243D-VERS.2006, CS243S, CS243S-VERS.2006, CS243VD, CS243VS, CS370AD, CS370AD-VERS.2006, CS370AS, CS370AS-VERS.2006, CS370AVD, CS370AVS, CS370D, CS370D-VERS.2006, CS370S, CS370S-VERS.2006, CS370VD, CS370VS, CS466AD, CS466AD-VERS.2006, CS466AS, CS466AS-VERS.2006, CS466AVD, CS466AVS, CS466D, CS466D-VERS.2006... (Other models you can see in the webshop)		
accessories for	416269		
	GEV No.	532577	Ref. No. —
	O-ring EPDM thickness 5.34mm ID ø 40.65mm Qty 1 pcs		

3 hole flange ø 47.5mm

GEV No.	415013	Ref. No.	32G0390 32G0790
description	heating element 2400W 230V mounting ø 47.5mm heating circuits 1 L 215mm W 40mm H 35mm number of thermostat sleeves 1 thermostat sleeves ø 6.5mm length thermostat sleeves 190mm thermostat sleeve eccentric, non clinging tube ø 6.5mm hole distance 64mm hole ø 8x10mm connection male faston 6.3mm 3 hole flange immersion heater		
For models:	L40, L45		
accessories for	415013		
	GEV No.	510408	Ref. No. 3152650
	O-ring EPDM thickness 5.34mm ID ø 47mm Qty 1 pcs		
	GEV No.	510562	Ref. No. —
	O-ring silicone thickness 5.34mm ID ø 47mm Qty 1 pcs		

3 hole flange ø 57.5mm

GEV No.	418249	Ref. No.	32G2150
description	heating element 10000W 230V mounting ø 57.5mm heating circuits 3 L 512mm W 50mm H 33mm number of thermostat sleeves 1 thermostat sleeves ø 8.5mm length thermostat sleeves 458mm thermostat sleeve eccentric, clinging tube ø 6.3mm hole distance 70mm hole ø 9mm connection length 30mm connection M4 3 hole flange immersion heater		
For models:	C304AD, C304AD-VERS.2006, C304AS, C304AS-VERS.2006, C304D, C304D-VERS.2006, C304S, C304S-VERS.2006, CS243D, CS243S, CS243VD, CS243VS, CS370AD, CS370AD-VERS.2006, CS370AS, CS370AS-VERS.2006, CS370AVD, CS370AVS, CS370D, CS370D-VERS.2006, CS370S, CS370S-VERS.2006, CS370VD, CS370VS, CS466AD, CS466AD-VERS.2006, CS466AS, CS466AS-VERS.2006, CS466AVD, CS466AVS, CS466D, CS466D-VERS.2006, LC130-VERS.2001		

3 hole flange ø 57.5mm

GEV No.	415023	Ref. No.	32G0840
description	heating element 12500W 230V mounting ø 57.5mm heating circuits 3 L 630mm W 36mm H 48mm number of thermostat sleeves 1 thermostat sleeves ø 7mm length thermostat sleeves 295mm thermostat sleeve eccentric, non clinging tube ø 8.5mm hole distance 76mm hole ø 8x10mm connection M5 3 hole flange immersion heater		
spare parts for	415023		
	GEV No.	510409	Ref. No. 3150430 3151960 37Q5260
	O-ring EPDM thickness 5.34mm ID ø 56.52mm Qty 1 pcs		

3 hole flange ø 57.5mm

GEV No.	419138	Ref. No.	32G2000 32G2340 32G2840
description	heating element 14000W 230V mounting ø 57.5mm heating circuits 3 L 515mm W 37mm H 50mm number of thermostat sleeves 1 thermostat sleeves ø 7.5mm length thermostat sleeves 450mm thermostat sleeve upper tube ø 10mm hole distance 72mm hole ø 8x10mm connection length 30mm connection M5 3 hole flange immersion heater		
For models:	C165D, C165S, C207D, C207D-VERS.2006, C207S, C207S-VERS.2006, C92D-VERS.2006, C92S-VERS.2006, CS243D-VERS.2006, CS243S-VERS.2006, LP124, LP124S-VERS.052006, LP124-VERS.052006		
accessories for	419138		
	GEV No.	510409	Ref. No. 3150430 3151960 37Q5260
	O-ring EPDM thickness 5.34mm ID ø 56.52mm Qty 1 pcs		

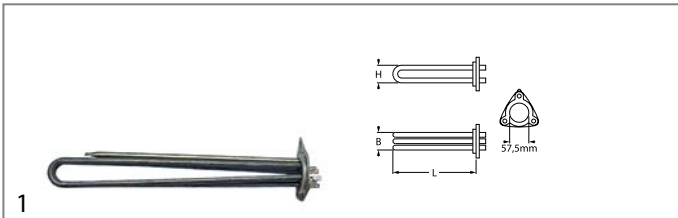

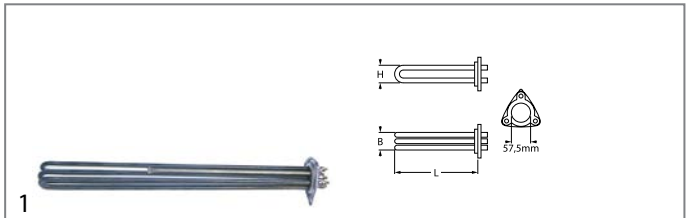

GEV No.	415020	Ref. No.	32G0230 32G0380
description	heating element 4500W 230V mounting \varnothing 57.5mm heating circuits 3 L 355mm W 35mm H 47mm number of thermostat sleeves 1 thermostat sleeves \varnothing 7mm length thermostat sleeves 295mm thermostat sleeve upper tube \varnothing 8.5mm hole distance 70mm hole \varnothing 10mm connection length 25mm connection male faston 6.3mm 3 hole flange immersion heater		
For models:	OG1CP1EC, F60P, F60PR, F60T, L100, L40S, L60, L80		

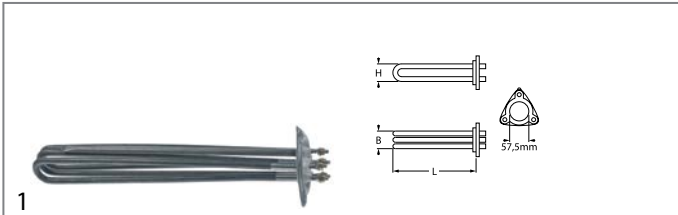

GEV No.	415022	Ref. No.	32G0850 32G2100 32G2720	
description	heating element 9000W 230/400V mounting \varnothing 57.5mm heating circuits 3 L 475mm W 36mm H 43mm number of thermostat sleeves 1 thermostat sleeves \varnothing 7mm length thermostat sleeves 300mm thermostat sleeve eccentric, non clinging tube \varnothing 10mm hole distance 73mm hole \varnothing 10mm connection length 30mm connection M5 3 hole flange immersion heater			
spare parts for	415022			
	GEV No.	510409	Ref. No.	3150430 3151960 37Q5260
O-ring EPDM thickness 5.34mm ID \varnothing 56.52mm Qty 1 pcs				



GEV No.	415021	Ref. No.	32G0400 32G0420 32G0520 32G0920	
description	heating element 6000W 230V mounting \varnothing 57.5mm heating circuits 3 L 343mm W 37mm H 50mm number of thermostat sleeves 1 thermostat sleeves \varnothing 7mm length thermostat sleeves 294mm thermostat sleeve not clinging tube \varnothing 8.5mm hole distance 72mm hole \varnothing 8mm connection M5 3 hole flange			
For models:	F60P, F60PR, F60T, F80P, F80PR, L100, L45, L60, L80			
spare parts for	415021			
	GEV No.	510409	Ref. No.	3150430 3151960 37Q5260
O-ring EPDM thickness 5.34mm ID \varnothing 56.52mm Qty 1 pcs				
accessories for	415021			
	GEV No.	550002	Ref. No.	3113780
tension strap H 10mm L 21mm W 10mm hole \varnothing 6.5mm for heating element				

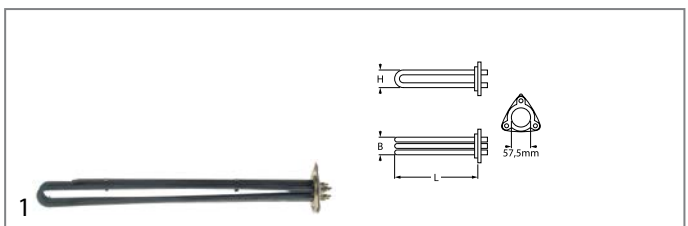



GEV No.	418586	Ref. No.	32G2720
description	heating element 9000W 230V mounting \varnothing 57.5mm heating circuits 3 L 515mm W 37mm H 46mm number of thermostat sleeves 1 thermostat sleeves \varnothing 7mm length thermostat sleeves 440mm thermostat sleeve eccentric, clinging hole distance 73mm		
For models:	CS370AD-VERS.2006, CS370AS-VERS.2006, CS370D-VERS.2006, CS370S-VERS.2006, CS466AD-VERS.2006, CS466AS-VERS.2006, CS466D-VERS.2006, CS466S-VERS.2006, LC130, LP84, LP84S-VERS.052006, LP84-VERS.052006, N303D, N303S, N354D, N354S, N506S, N607D, N607S, N760D, N760S, N886D, N886S		

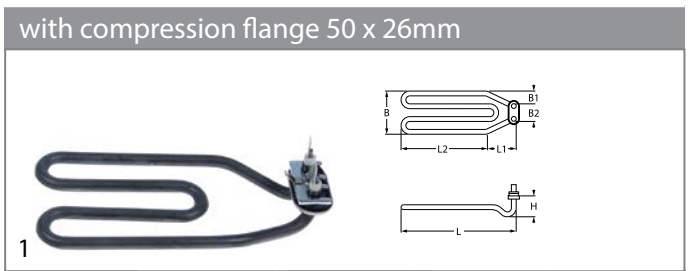

GEV No.	418585	Ref. No.	32G2580
description	heating element 6000W 400V mounting \varnothing 57.5mm heating circuits 3 L 324mm W 42mm H 30mm number of thermostat sleeves 1 thermostat sleeves \varnothing 7mm length thermostat sleeves 280mm thermostat sleeve eccentric, clinging tube \varnothing 8.5mm hole distance 74mm hole \varnothing 8/10mm connection length 10mm connection M4 3 hole flange immersion heater		
For models:	LC100, LC100-VERS.2001, LC80, LF50, LP84S-VERS.052006, LP84-VERS.052006		

with compression flange 50 x 26mm



GEV No.	416209	Ref. No.	32G2070	
description	heating element 2000W 230V heating circuits 1 compression flange flange 50x26mm L 180mm W 90mm H 24mm L1 55mm L2 125mm W1 28mm W2 35mm connection male faston 6.3mm tube \varnothing 8.5mm connection length 28mm immersion heater			
For models:	LF50EM, LF50EMPS, LF50EMPS-VERS.122012, LF50EM-VERS.122012, LF50E-VERS.122012, LF50E-VERS.2007, LP70			
accessories for	416209			
	GEV No.	510387	Ref. No.	—
gasket L 46mm W 22mm \varnothing mm EPDM for heating element for flange 50x26mm				



with compression flange 62 x 26mm



GEV No.	415268	Ref. No.	3030180
description	heating element 1850-2020W 230-240V heating circuits 1 expansion flange flange 62x26mm L 245mm W 40mm H 25mm tube ø 6.5mm connection male faston 6.3mm immersion heater		



GEV No.	415270	Ref. No.	32g3360
description	heating element 2700W 230V heating circuits 1 compression flange flange 62x26mm L 335mm W 43mm H 25mm tube ø 6.3mm connection male faston 6.3mm immersion heater		
For models:	KD100, KD100A, KD100PSD, KD60, KD60E, KD60EAT, KD60M, KD60MA, KD60ME, KD60MPS, KD60MPSA, KD60PS, KD60PSD, KD6E-ATSD, KD85, KD85A, KD85E, KD85EA, KD85EAT, KD85EATS, KD85EPS, KD85EPSA, KD85PS, KD85PSA, KN1100, KN1100SD, KN11PSDD, KN50, KN50M, KN50MPS, KN50PS, KN50PSD, KN50PSDD, KN80, KN800, KN800PSD, KN80PS, LP70		

with expansion flange 70 x 18mm









GEV No.	418588	Ref. No.	32G0120
description	heating element 1000W 220V heating circuits 1 flange 70x18mm L 175mm W 83mm H 55mm connection male faston 6.3mm tube ø 8.3mm		



GEV No.	418598	Ref. No.	32G0190
description	heating element 1500W 220V heating circuits 1 flange 70x18mm L 175mm W 83mm H 55mm connection male faston 6.3mm immersion heater tube ø 8.5mm		

with round flange ø47.5mm



GEV No.	415249	Ref. No.	32G0480
description	heating element 1500W 220V heating circuits 1 mounting ø 47.5mm L 220mm W 36mm H 49mm round flange connection male faston 6.3mm immersion heater tube ø 6.5mm connection length 18mm thermostat sleeves ø 7.5mm number of thermostat sleeves 1 length thermostat sleeves 181mm thermostat sleeve not clinging		
spare parts for	415249		
	GEV No.	510408	Ref. No. 3152650
	O-ring EPDM thickness 5.34mm ID ø 47mm Qty 1 pcs		
accessories for	415249		
	GEV No.	510562	Ref. No. —
	O-ring silicone thickness 5.34mm ID ø 47mm Qty 1 pcs		
	GEV No.	520235	Ref. No. —
	3 hole flange hole distance 70.5mm perforation ø 6.5mm ID ø 53.5mm		
	GEV No.	520236	Ref. No. —
	flange for heating element ID ø 50mm ED ø 90mm hole ø 6.5mm 3 holes		
	GEV No.	550002	Ref. No. 3113780
	tension strap H 10mm L 21mm W 10mm hole ø 6.5mm for heating element		
	GEV No.	550362	Ref. No. —
	blind flange ø 64mm mounting ø 47.5mm		









GEV No.	415043	Ref. No.	32g0540
description	heating element 2500W 230V heating circuits 1 mounting ø 47.5mm L 225mm W 41mm H 36mm round flange connection male faston 6.3mm immersion heater tube ø 6.5mm connection length 17mm thermostat sleeves ø 7mm number of thermostat sleeves 1 length thermostat sleeves 210mm thermostat sleeve eccentric, non clinging		
For models:	LT10R, LT20F, LT25F		
spare parts for	415043		
	GEV No.	510408	Ref. No. 3152650
	O-ring EPDM thickness 5.34mm ID ø 47mm Qty 1 pcs		
accessories for	415043		
	GEV No.	510408	Ref. No. 3152650
	O-ring EPDM thickness 5.34mm ID ø 47mm Qty 1 pcs		
	GEV No.	510562	Ref. No. —
	O-ring silicone thickness 5.34mm ID ø 47mm Qty 1 pcs		
	GEV No.	520235	Ref. No. —
	3 hole flange hole distance 70.5mm perforation ø 6.5mm ID ø 53.5mm		
	GEV No.	520236	Ref. No. —
	flange for heating element ID ø 50mm ED ø 90mm hole ø 6.5mm 3 holes		
	GEV No.	550002	Ref. No. 3113780
	tension strap H 10mm L 21mm W 10mm hole ø 6.5mm for heating element		



Table continues overleaf







accessories for	415043		
	GEV No.	550362	Ref. No. —
	blind flange ø 64mm mounting ø 47.5mm		

1			
GEV No.	415269	Ref. No.	32G3400
description	heating element 2700W 230V heating circuits 3 mounting ø 47.5mm L 257mm W 28mm H 45mm round flange connection male faston 6.3mm immersion heater tube ø 6.3mm H1 11mm H2 34mm connection length 28mm		
For models:	KD100, KD100A, KD100PSD, KD130, KD130A, KD130E, KD130EAT, LP151		
accessories for	415269		
	GEV No.	510408	Ref. No. 3152650
	O-ring EPDM thickness 5.34mm ID ø 47mm Qty 1 pcs		
	GEV No.	510562	Ref. No. —
	O-ring silicone thickness 5.34mm ID ø 47mm Qty 1 pcs		
	GEV No.	520235	Ref. No. —
	3 hole flange hole distance 70.5mm perforation ø 6.5mm ID ø 53.5mm		
	GEV No.	520236	Ref. No. —
	flange for heating element ID ø 50mm ED ø 90mm hole ø 6.5mm 3 holes		
	GEV No.	550002	Ref. No. 3113780
	tension strap H 10mm L 21mm W 10mm hole ø 6.5mm for heating element		
	GEV No.	550362	Ref. No. —
	blind flange ø 64mm mounting ø 47.5mm		







1			
GEV No.	415263	Ref. No.	32G3390
description	heating element 4500W 230V heating circuits 3 mounting ø 47.5mm L 375mm W 38mm H 46mm round flange connection male faston 6.3mm immersion heater tube ø 6.3mm thermostat sleeves ø 7mm number of thermostat sleeves 1 length thermostat sleeves 240mm thermostat sleeve not clinging		
accessories for	415263		
	GEV No.	510408	Ref. No. 3152650
	O-ring EPDM thickness 5.34mm ID ø 47mm Qty 1 pcs		
	GEV No.	520235	Ref. No. —
	3 hole flange hole distance 70.5mm perforation ø 6.5mm ID ø 53.5mm		
	GEV No.	520236	Ref. No. —
	flange for heating element ID ø 50mm ED ø 90mm hole ø 6.5mm 3 holes		
	GEV No.	521012	Ref. No. —
	gasket graphite ED ø 15mm ID ø 5mm thickness 1.2mm Qty 1 pcs		
	GEV No.	550002	Ref. No. 3113780
	tension strap H 10mm L 21mm W 10mm hole ø 6.5mm for heating element		
	GEV No.	550362	Ref. No. —
	blind flange ø 64mm mounting ø 47.5mm		



with round flange ø57.5mm			
1			
GEV No.	415019	Ref. No.	32G0220
description	heating element 3000W 230V heating circuits 3 mounting ø 57.5mm L 338mm W 37mm H 41mm round flange connection male faston 6.3mm immersion heater tube ø 8.5mm connection length 27mm thermostat sleeves ø 7mm number of thermostat sleeves 1 length thermostat sleeves 300mm thermostat sleeve not clinging with 3 hole flange & O-ring		
accessories for	415019		
	GEV No.	550002	Ref. No. 3113780
	tension strap H 10mm L 21mm W 10mm hole ø 6.5mm for heating element		



1			
GEV No.	416598	Ref. No.	32G1931
description	heating element 4540W 400V heating circuits 3 L 312mm W 55mm H 48mm tube ø 8.5mm thermostat sleeves ø 7mm length thermostat sleeves 290mm number of thermostat sleeves 1 connection M4 immersion heater round flange mounting ø 57.5mm		
For models:	31PIE6		
accessories for	416598		
	GEV No.	550002	Ref. No. 3113780
	tension strap H 10mm L 21mm W 10mm hole ø 6.5mm for heating element		



1			
GEV No.	415264	Ref. No.	3037760
description	heating element 6000W 230V heating circuits 3 mounting ø 57.5mm L 480mm W 33mm H 42mm round flange connection M5 immersion heater tube ø 8.5mm connection length 19mm thermostat sleeves ø 7.5mm number of thermostat sleeves 1 length thermostat sleeves 268mm thermostat sleeve not clinging		
For models:	KD85, KD85A, KD85E, KD85EA, KD85EAT, KD85EATS, KD85EPS, KD85EPSA, KD85PS, KD85PSA, KN1100, KN1100SD, KN11PSDD, KN800, KN800PSD, LP151, LP202, LP202HC, LP302, LP302HC, N100D, N100S, N100VD, N100VS, N38D, N38S, N42D, N42S, N42VD, N42VS, N50D, N50S, N50VD, N50VS, N66D, N66S, N66VD, N66VS, N70D, N70S, N70VD, N70VS, N85D, N85S, N85VD, N85VS		
spare parts for	415264		
	GEV No.	510409	Ref. No. 3150430 3151960 37Q5260
	O-ring EPDM thickness 5.34mm ID ø 56.52mm Qty 1 pcs		
accessories for	415264		
	GEV No.	550002	Ref. No. 3113780
	tension strap H 10mm L 21mm W 10mm hole ø 6.5mm for heating element		









			
GEV No.	415183	Ref. No.	32G0770
description	heating element 7000W 220V heating circuits 3 L 415mm W 41mm H 70mm tube ø 8.5mm connection M4 immersion heater round flange L1 265mm L2 150mm H1 25mm H2 55mm mounting ø 57.5mm		
accessories for	415183		
	GEV No.	521103	Ref. No. N/A
	nut thread M4 H 3mm WS 7 brass Qty 20 pcs		
	GEV No.	521104	Ref. No. —
	washer ID ø 4.3mm ED ø 8mm thickness 0.5mm brass Qty 20 pcs for thread M4		
	GEV No.	550002	Ref. No. 3113780
	tension strap H 10mm L 21mm W 10mm hole ø 6.5mm for heating element		
	GEV No.	560111	Ref. No. —
	plain washer ID ø 4.3mm ED ø 9mm thickness 0.8mm SS Qty 20 pcs DIN 125A for thread M4		
	GEV No.	560131	Ref. No. —
	hexagonal nut thread M4 H 3.2mm WS 7 SS DIN/ISO DIN 934 / ISO 4032/8673 Qty 20 pcs		

			
GEV No.	416599	Ref. No.	32G1031 32G1160
description	heating element 7000W 240V heating circuits 3 L 405mm W 42mm H 70mm tube ø 8.5mm thermostat sleeves ø 7mm length thermostat sleeves 51mm number of thermostat sleeves 1 thermostat sleeve eccentric sensor screw connection M9x1 connection M4 immersion heater round flange kettle L1 250mm L2 155mm H1 30mm H2 40mm mounting ø 57.5mm		
For models:	71PIE15, 71PIE15A, 91PIE15, 91PIE15A		
accessories for	416599		
	GEV No.	550002	Ref. No. 3113780
	tension strap H 10mm L 21mm W 10mm hole ø 6.5mm for heating element		



			
GEV No.	416600	Ref. No.	32G2330
description	heating element 7000W 400V heating circuits 3 L 415mm W 41mm H 84mm tube ø 8.5mm thermostat sleeves ø 6.5mm length thermostat sleeves 51mm number of thermostat sleeves 1 thermostat sleeve not clinging connection M4 connection length 12mm immersion heater round flange kettle L1 265mm L2 150mm H1 32mm H2 52mm mounting ø 57.5mm		
For models:	191PI2E, 191PI2EA, 1A1PI2E, 1A1PI2EA, 1D1PI2E, 1D1PI2EA		
accessories for	416600		
	GEV No.	550002	Ref. No. 3113780
	tension strap H 10mm L 21mm W 10mm hole ø 6.5mm for heating element		

			
GEV No.	415265	Ref. No.	32G3410
description	heating element 9000W 230V heating circuits 3 mounting ø 57.5mm L 470mm W 35mm H 41mm round flange connection M5 immersion heater tube ø 8.5mm connection length upper centre not clinging-mm thermostat sleeves ø 7.5mm number of thermostat sleeves 1 length thermostat sleeves 295mm		
For models:	KD100, KD100A, KD100PSD, KD130, KD130A, KD130E, KD130EAT, LP202, LP202HC, LP302, LP302HC, LP402, LP402HC, LP402V, LPG300, N100D, N100S, N100VD, N100VS, N38D, N38S, N42D, N42S, N42VD, N42VS, N50D, N50S, N50VD, N50VS, N66D, N66S, N66VD, N66VS, N70D, N70S, N70VD, N70VS, N85D, N85S, N85VD, N85VS		
spare parts for	415265		
	GEV No.	510409	Ref. No. 3150430 3151960 37Q5260
	O-ring EPDM thickness 5.34mm ID ø 56.52mm Qty 1 pcs		
accessories for	415265		
	GEV No.	550002	Ref. No. 3113780
	tension strap H 10mm L 21mm W 10mm hole ø 6.5mm for heating element		



			
GEV No.	415011	Ref. No.	32g0500
description	heating element 3000W 230V heating circuits 1 thread 1¼" L 285mm W 24mm H 20mm tube ø 6.5mm connection M4 immersion heater connection length 26mm flange with thread WS 54		
accessories for	415011		
	GEV No.	510405	Ref. No. N/A
	flat gasket fibre ED ø 56mm ID ø 42mm thickness 2mm for thread 1¼" Qty 1 pcs		
	GEV No.	520232	Ref. No. —
	nut thread 1¼" H 5mm nickel-plated brass WS 47 Qty 1 pcs		
	GEV No.	528021	Ref. No. —
	flat gasket PTFE ED ø 53mm ID ø 42.5mm thickness 3mm Qty 1 pcs equiv. no. 12001/02286 suitable for Astoria/Aurora/Brasilia/Wega		



			
GEV No.	417167	Ref. No.	32G0170
description	heating element 4500W 230V heating circuits 3 thread 2" L 300mm W 37mm H 37mm tube ø 8.5mm connection M4 immersion heater connection length 65mm		
spare parts for	417167		
	GEV No.	510407	Ref. No. —
	flat gasket fibre ED ø 78mm ID ø 60mm thickness 2mm for heating element for thread 2" Qty 1 pcs		





			
GEV No.	416261	Ref. No.	32G2590
description	heating element 3000W 230V heating circuits 1 L 358mm W 32mm H 34mm H2 37mm thread M10x1 mounting distance 26mm tube ø 6.5mm connection male faston 6.3mm 2 hole fixing immersion heater		
For models:	LC100, LC100-VERS.2001, LC130, LC130-VERS.2001, LC80, LF50, LF50E		
accessories for	416261		
		GEV No. 510416	Ref. No. —
	flat gasket fibre ED ø 19mm ID ø 10.5mm thickness 1.5mm for thread M10 Qty 1 pcs		
		GEV No. 510893	Ref. No. —
	O-ring EPDM thickness 2.62mm ID ø 9.92mm Qty 1 pcs		
		GEV No. 520231	Ref. No. —
	nut thread M10x1 H 6mm WS 14 zinc-coated steel Qty 1 pcs		
		GEV No. 521129	Ref. No. —
	nut thread M10 H 6mm SS WS 17 Qty 1 pcs DIN/ISO DIN 439		

heating elements for convection

			
GEV No.	418102	Ref. No.	32G1701
description	heating element 16400W 230V heating circuits 3 ID ø 441mm ED ø 458mm L 492mm H 143mm L1 34mm W1 104mm H1 128mm H2 115mm flange length 142mm flange width 25mm hole distance 63mm connection M6x1 tube ø 8.5mm convection heating element hole ø 6mm rectangular flange		
For models:	BX101E, BX101E-VERS.122013, FC101E, FC101E, FCV101E, FCV101EDM, FCV101EDM-UL, FCV101EDS, FCV101EDS-UL, FCV101E-UL, FCV141E, FCV141EDM, FCV141EDS, FCV72EDM-UL, FCV72EDS-UL, FCV72E-UL, FM1011E1, FM1011E1-VERS.2006, FM1011E2, FM1011E2-VERS.2006, FM1011E3, FM1011E3-VERS.2006, FM2011E2-VERS.2006, FM2011E3-VERS.2006, FM721E1, FM721E1-VERS.2006, FM721E2, FM721E2-VERS.2006, FM721E3, FM721E3-VERS.2006, FX101E1, FX101E1R, FX101E2, FX101E2C, FX101E2R, FX101E3, FX101E3C, FX101E3R, FX10E2CR, FX10E3CR, FX201E2, FX201E2P, FX201E3, FX201E3P		
accessories for	418102		
		GEV No. 699165	Ref. No. 3332550
	gasket L 142mm W 25mm D1 ø 6.5mm D2 ø 12mm hole distance 17mm 9 holes graphite thickness 2mm		



			
GEV No.	418103	Ref. No.	32G1711
description	heating element 24000W 400V heating circuits 3 ID ø 518mm ED ø 535mm L 590mm H 143mm L1 38mm W1 104mm H1 120mm H2 23mm flange length 142mm flange width 25mm hole distance 125mm connection M6 tube ø 8.5mm convection heating element hole ø 6mm rectangular flange		
For models:	FC1221E, FC241E, FCV241E, FCV241EDM, FCV241EDS, FCV401EDM, FM1221E1, FM1221E1-VERS.2006, FM1221E2, FM1221E2-VERS.2006, FM1221E3, FM1221E3-VERS.2006, FM2021E1, FM2021E2, FM2021E2-VERS.2006, FM2021E3, FM2021E3-VERS.2006		
accessories for	418103		
		GEV No. 699165	Ref. No. 3332550
	gasket L 142mm W 25mm D1 ø 6.5mm D2 ø 12mm hole distance 17mm 9 holes graphite thickness 2mm		

			
GEV No.	419175	Ref. No.	32G1550
description	heating element 2400W 230V heating circuits 1 ID ø 190mm ED ø 210mm 2 hole fixing connection M4 tube ø 8.5mm thread 1/4" heated cabinet		
For models:	A12A1E, A12B1E, A12B2E, A12M1E, A12Z1E, A12Z2E, A14A1E, A14B1E, A14B2E, A14M1E, A14Z1E, A14Z2E, A16A1E, A16B1E, A16B2E, A16M1E, A16Z1E, A16Z2E, A18A1E, A18B1E, A18B2E, A18M1E, A18Z1E, A18Z2E, A20A1E, A20B1E, A20B2E, A20M1E, A20Z1E, A20Z2E, ACBM, ACBM218, ACPN, ACPN218, AJ12AE, AJ12ME, AJ14AE, AJ14ME, AJ16AE, AJ16ME, SL14CPN, SL14CVB, SL21CPN, SL21CVB		

			
GEV No.	418099	Ref. No.	32G0430
description	heating element 2800W 230V heating circuits 1 ID ø 217mm ED ø 230mm L 249mm H 72mm L1 11mm W1 68mm H1 11mm H2 41mm flange length 142mm flange width 25mm hole distance 63mm connection male faston 6.3mm connection length 73mm tube ø 6.3mm convection heating element hole ø 6mm rectangular flange		
For models:	FCV3EM		





			
1			
GEV No.	418100	Ref. No.	32G1940
description	heating element 4150W 230V heating circuits 3 ID ø 214mm ED ø 226mm L 248mm H 70mm L1 15mm W1 103mm H1 5mm H2 65mm flange length 142mm flange width 25mm hole distance 62mm connection male faston 6.3mm tube ø 6.3mm convection heating element hole ø 6mm rectangular flange		
For models:	FCV4E, FCV4EDS, FCV4EM, FM423E1, FM423E2		

			
1			
GEV No.	418101	Ref. No.	32G1691
description	heating element 8700W 230V heating circuits 3 ID ø 317mm ED ø 333mm L 375mm H 100mm L1 42mm W1 105mm H1 82mm H2 18mm flange length 142mm flange width 25mm hole distance 63mm connection M6 connection length 26mm tube ø 8.5mm convection heating element hole ø 6mm rectangular flange		
For models:	FC611E, FC61E, FCV61E, FCV61EDM, FCV61EDM-UL, FCV61EDS, FCV61EDS-UL, FCV61E-UL, FM611E1, FM611E1-VERS.2006, FM611E2, FM611E2-VERS.2006, FM611E3, FM611E3-VERS.2006		
accessories for	418101		
		GEV No.	699165
		Ref. No.	3332550
	gasket L 142mm W 25mm D1 ø 6.5mm D2 ø 12mm hole distance 17mm 9 holes graphite thickness 2mm		

			
1			
GEV No.	419261	Ref. No.	3116030
description	heating element 9500/10400W 230/240V heating circuits 3 ID ø 320mm ED ø 337mm L 380mm H 148mm L1 40mm W1 105mm H1 20mm H2 120mm flange length 142mm flange width 25mm hole distance 18mm connection M6x1 connection length 85mm tube ø 8.5mm convection heating element flange combi-steamer		
For models:	BX61E, BX61E-VERS.122013, FX61E1, FX61E1R, FX61E2, FX61E2C, FX61E2CR, FX61E2CR-VERS.032014, FX61E2C-VERS.032014, FX61E2R, FX61E2R-VERS.032014, FX61E2-VERS.032014, FX61E3, FX61E3C, FX61E3CR, FX61E3CR-VERS.022014, FX61E3C-VERS.022014, FX61E3R, FX61E3R-VERS.022014, FX61E3-VERS.022014		

			
1			
GEV No.	415737	Ref. No.	32G1280
description	heating element 2500W 230V heating circuits 1 L 655mm W 120mm L1 30mm L2 625mm W2 90mm flange length 70mm flange width 22mm hole distance 56mm connection length 100mm connection M4 tube ø 6.3mm hole ø 5.5mm W1 30mm rectangular flange convection heating element windings 2		

			
1			
GEV No.	419222	Ref. No.	3115001
description	heating element 27000/29000W 400/415V L 590mm W 545mm H 140mm heating circuits 3 cable lengthmm		
For models:	BX122E, BX122E-VERS.122013, FX122E1, FX122E2, FX122E2C, FX122E2T, FX122E2T-VERS.032014, FX122E3, FX122E3C, FX122E3T, FX122E3T-VERS.022014, FX12E3CT, FX12E3CT-VERS.022014, FX202E2, FX202E2-VERS.032014, FX202E3, FX202E3-VERS.022014		

			
1			
GEV No.	415736	Ref. No.	32G1360
description	heating element 3500W 230V heating circuits 1 L 655mm W 125mm L1 30mm L2 625mm W2 88mm flange length 70mm flange width 22mm hole distance 56mm connection length 97mm connection M4 tube ø 6.25mm hole ø 5mm W1 30mm rectangular flange convection heating element windings 2 mounting distance 58mm		

radiation heaters

1-circuit

			
1			
GEV No.	490025	Ref. No.	3080080
description	radiation heater ø 200mm 1700W 230V heating circuits 1 energy regulation with temperature signalization with heating coil connections 2+2 connection type male faston 6.3mm EGO		
For models:	OG0PEVTR, 1G0PEVTR, 6VTR, 6VTR2		



2-circuit



1

GEV No.	490139	Ref. No.	3080070
description	radiation heater ø 250mm 2500W 230V heating circuits 2 energy regulation with temperature signalization partial power 1000W with ribbon heater connections 3+2 connection type male faston 6.3mm EGO		



1

GEV No.	490071 ¹	Ref. No.	32G1210 32G1211
description	hot plate dimensions 300x300mm 4000W 230V with spill ring connection 4 screw clamps protector yes square		
For models:	070E, 071E, 08WPE4V, 090E, 090PE4, 091E, 190PE4, 71E		

¹incl. protector

hot plates

square & rectangular

with radiused edge



1

GEV No.	490068 ¹	Ref. No.	32G2860
description	hot plate dimensions 220x220mm 2600W 400V with spill ring connection 4 screw clamps protector yes square		
For models:	0G0PE2, 0G1PE2, 1G0PE2, 1G1PE2, 1G1PE2E, 1G1PE2EV, 2G0PE2, 2G1PE2E, 2G1PE2EV		

¹incl. protector



1

GEV No.	490074 ¹	Ref. No.	32G0940 32G1080
description	hot plate dimensions 300x300mm 4000W 400V with spill ring connection 4 screw clamps protector yes square		
For models:	04WPE4V, 070E, 071E, 08WPE4V, 090E, 090PE4, 091E, 0A0PE4, 0D0PE4, 190PE4, 191PE4E, 1A0PE4, 1A1PE4E, 1A1PEFTE, 1D0PE4, 1D1PE4E, 71E		

¹incl. protector



1

GEV No.	490056 ¹	Ref. No.	32G1201
description	hot plate dimensions 300x300mm 3000W 230V with spill ring connection 4 screw clamps protector yes square		
For models:	070E, 071E, 090E, 091E, 71E		

¹incl. protector

round

with radiused edge

for domestic and commercial kitchens



1

GEV No.	490016	Ref. No.	32G0030
description	hot plate ø 180mm 2000W 230V connection 4 screw clamps with 8mm spill ring		
For models:	030E, 031E, 0G0PE1, 1G0PE1, 1G1PE1E, 1G1PE1EV, 2G0PE1, 2G1PE1E, 2G1PE1EV, 31TCE, 32TCE		



1



GEV No.	490017	Ref. No.	32G0290 32G1320
description	hot plate ø 180mm 2000W 400V connection 4 screw clamps with 8mm spill ring		
For models:	030E, 031E, 0G0PE1, 1G0PE1, 1G1PE1E, 1G1PE1EV, 2G0PE1, 2G1PE1E, 2G1PE1EV, 31TCE, 32TCE		



1

GEV No.	490073	Ref. No.	32G0930 32G1090
description	hot plate dimensions 300x300mm 3000W 400V with spill ring connection 4 screw clamps protector no square		
For models:	070E, 071E, 090E, 091E, 71E		



			
1			
GEV No.	490020	Ref. No.	32G0020
description	hot plate ø 220mm 2600W 230V connection 4 screw clamps with 8mm spill ring		
For models:	030E, 031E, 0G0PE1, 1G0PE1, 1G1PE1E, 1G1PE1EV, 2G0PE1, 2G1PE1E, 2G1PE1EV, 31TCE, 32TCE		
accessories for	490020		
		GEV No.	550796
		Ref. No.	—
	fixing plate for hot plate ø220mm		

			
1			
GEV No.	490021	Ref. No.	32G0300 32G1330
description	hot plate ø 220mm 2600W 400V connection 4 screw clamps with 8mm spill ring		
For models:	030E, 031E, 0G0PE1, 1G0PE1, 1G1PE1E, 1G1PE1EV, 2G0PE1, 2G1PE1E, 2G1PE1EV, 31TCE, 32TCE		

energy regulators

EGO

1-circuit



			
1			
GEV No.	380015	Ref. No.	32Z0170 32Z0171
description	energy regulator 230V 13A single-circuit turn direction right shaft ø 6x4.6mm shaft L 23mm mounting thread M4 power release 6-100% no. 50.57021.010		
For models:	06WBR3E, 08WGREV, 090SPE, 0G0SPE, 0G1BR3E, 190GRE, 191BR1E, 191BR2E, 191BR2EA, 1A1BR1E, 1A1BR2E, 1A1BR2EA, 1D1BR1E, 1D1BR2E, 1D1BR2EA, 1G0GRE, 1G1BR3E, 291BR1E, 291BR2E, 291BR2EA, 291PI3E, 2A1BR1E, 2A1BR2E, 2A1BR2EA, 2A1PI3E, 2D1BR1E, 2D1BR2E, 2D1BR2EA, FC1011E, FC1011G, FC1221E, FC1221G, FC611E, FC611G, FMS, FMSX		

2-circuit

			
1			
GEV No.	380027	Ref. No.	3008300
description	energy regulator EGO 230V 13A dual circuit turn direction right shaft ø 6x4.6mm shaft L 23mm mounting thread M4 power release 6-70% no. 50.55021.100		
For models:	04WVT3RV, 090VTR, 0G0PEVTR, 190VTR, 1G0PEVTR, 6042520, 6042530, 6043590, 6VTR2		

accessories

knobs



			
1			
GEV No.	110117	Ref. No.	36M0750
description	knob energy regulator 1-3 t.max.°C ø 60mm shaft ø 6x4.6mm shaft flat upper black		
spare parts for	110117		
		GEV No.	112495
		Ref. No.	—
	knob spring L 10.5mm W 8.5mm Qty 1 pcs		

thermostats

bi-metal thermostats

safety bi-metal thermostats

			
1			
GEV No.	390480	Ref. No.	32V7250
description	bi-metal safety thermostat hole distance 23.8mm switch-off temp. 105°C 1NC 1-pole 16A connection F6.3 2 hole fixing		

			
1			
GEV No.	390233	Ref. No.	32V7250 32Z8270
description	bi-metal safety thermostat hole distance 24mm switch-off temp. 110°C 1NC 1-pole 16A connection F6.3 2 hole fixing without holder		
accessories for	390233		
		GEV No.	504736
		Ref. No.	—
	bracket for contact thermostat		
		GEV No.	550388
		Ref. No.	—
	bracket for contact thermostat mounting distance 24.5mm mounting ø 3.8		

bi-metal thermostats

			
1			
GEV No.	375927	Ref. No.	3093940
description	bi-metal thermostat hole distance 23.5mm switch-off temp. 50°C 1NO 10A connection F6.3		
For models:	04WPEBV, 08WPEBV, 08WTPEV, 090PEB, 091FR7G, 091PEB, 190PEB, 190TPE, 191PEB, 191TPE, 6BM, 6BR, 6CP, 6FR, 6FTL, 6FTR, 6PC, 6VTR		



			
1			
GEV No.	390439	Ref. No.	3008880
description	bi-metal thermostat hole distance 23.5mm switch-off temp. 70°C 1NC 10A 250V connection F6.3		
For models:	04WPE4V, 08WPE4V, 090PE4, 091FR1I, 091FR7G, 190PE4, 191FR2I, 191FR4ED, 191PE4E, 6BM, 6BR, 6CP, 6FR, 6FTL, 6FTR, 6PC, 6VTR		

control and safety thermostats

EGO

control thermostats

51._ series



1			
GEV No.	390033	Ref. No.	32Z0410
description	thermostat t.max. 93°C temperature range 30-93°C 1-pole 1NO 15A probe ø 20/23.5mm probe L 11mm capillary pipe 900mm capillary pipe isolated 800mm gland nut shaft ø 6x4.6mm shaft L 25mm shaft position upper rotation 270° outer switch 2NO probe material SS with knob probe		
For models:	030BME, 030EBM, 031BME, 031EBM, 0G0BME, 1G0BME, A12A1E, A12B1E, A12B2E, A12M1E, A12Z1E, A12Z2E, A14A1E, A14B1E, A14B2E, A14M1E, A14Z1E, A14Z2E, A16A1E, A16B1E, A16B2E, A16M1E, A16Z1E, A16Z2E, A18A1E, A18B1E, A18B2E, A18M1E, A18Z1E, A18Z2E, A20A1E, A20B1E, A20B2E, A20M1E, A20Z1E, A20Z2E, ACBM, ACBM218, ACPN, ACPN218, AJ12AE, AJ12ME, AJ14AE, AJ14ME, AJ16AE, AJ16ME, AJ18AE, AJ18ME, AJ20AE, AJ20ME...(Other models you can see in the webshop)		
accessories for	390033		
	GEV No.	510167	Ref. No. 3150270 315Q270
	gasket for thermostat ED ø 41mm ID ø 18mm Qty ANGELO PO/ ZANUSSI pcs equiv. no. 3150270/66717		

55.10/19_ series



1			
GEV No.	375345	Ref. No.	32Z9380
description	thermostat t.max. 150°C temperature range fixed 150°C 1-pole 1NO 16A probe ø 6mm probe L 74mm capillary pipe 900mm capillary pipe isolated 900mm gland nut shaft Lmm shaft position° shaft position		
For models:	04WBMEV, 090BM1E, 0A0BME, 0B0BME, 0D0BME, 6040110, 6042680		



1			
GEV No.	375844	Ref. No.	32Z2940
description	thermostat t.max. 182°C temperature range 100-180°C 1-pole 1NO 16A probe ø 11mm probe L 28mm capillary pipe 850mm capillary pipe isolated 800mm gland nut shaft ø 6x4.6mm shaft L 23mm shaft position upper rotation 270° screw-in probe probe thread M14x1		

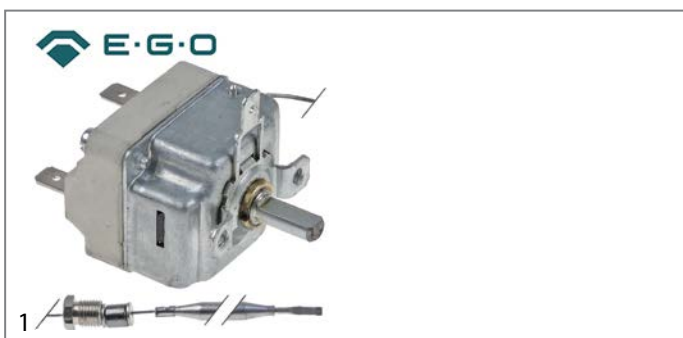

1			
GEV No.	375395	Ref. No.	32V4540
description	thermostat t.max. 182°C temperature range 95-180°C 1-pole 1NO 16A probe ø 6mm probe L 133mm capillary pipe 870mm capillary pipe isolated 520mm gland nut M9x1 shaft ø 6x4.6mm shaft L 13mm shaft position upper rotation 270° 250V		
For models:	0M0FR1E, 1M0FR2E		



1			
GEV No.	375922	Ref. No.	3168460
description	thermostat t.max. 185°C temperature range 101-185°C 1-pole 1NO 16A probe ø 6mm probe L 133mm capillary pipe 870mm capillary pipe isolated 520mm gland nut M10x1 shaft ø 6x4.6mm shaft L 23mm shaft position upper		
For models:	091FR1I, 091FR1I-VERS.032012, 191FR2I, 191FR2I-VERS.032012		





GEV No.	375631	Ref. No.	32Z5820
description	thermostat t.max. 249°C temperature range 55-249°C 1-pole 1NO 16A probe ø 3.1mm probe L 226mm capillary pipe 1270mm capillary pipe isolated 850mm gland nut 3/8"-M8x1 shaft ø 6x4.6mm shaft L 23mm shaft position upper rotation 318°		
For models:	FC101, FC1011E, FC1011G, FC101E, FC1221E, FC1221G, FC241, FC241E, FC241G, FC61, FC611E, FC611G, FC61E, FCV101, FCV101-CSA, FCV101E, FCV101E-UL, FCV141, FCV141-CSA, FCV141E, FCV241, FCV241E, FCV241E-UL, FCV241G, FCV241G-CSA, FCV3EM, FCV4EM, FCV61, FCV61-CSA, FCV61E, FCV61E-UL, FCV72E-UL		



GEV No.	375643	Ref. No.	32Z2371
description	thermostat t.max. 330°C temperature range fixed 330°C 1-pole 1NC 16A probe ø 3mm probe L 219mm capillary pipe 900mm capillary pipe isolated 900mm gland nut		
For models:	030EBM, 031EBM, 0G0BME, 0G0BME-VERS.032008, 1G0BME, 1G0BME-VERS.032008		



GEV No.	390068	Ref. No.	32Z0610
description	thermostat t.max. 269°C temperature range 55-269°C 1-pole 1CO 16A probe ø 3.1mm probe L 219mm capillary pipe 1280mm capillary pipe isolated 1270mm gland nut shaft ø 6x4.6mm shaft L 23mm shaft position upper° rotation 318°		



GEV No.	390037	Ref. No.	32Z0180
description	thermostat t.max. 54°C temperature range fixed 54°C 1-pole 1NC 16A probe ø 20/23.5mm probe L 11mm capillary pipe 900mm capillary pipe isolated 850mm gland nut		



GEV No.	375437	Ref. No.	32Z0210
description	thermostat t.max. 324°C temperature range 66-324°C 1-pole 1NO 16A probe ø 4mm probe L 124mm capillary pipe 1470mm capillary pipe isolatedmm gland nut shaft ø 6x4.6mm shaft L 23mm shaft position upper rotation 270°		



GEV No.	375845	Ref. No.	32Z2160
description	thermostat t.max. 54°C temperature range fixed 54°C 1-pole CO probe ø 20/23.5mm probe L 11mm capillary pipe 1600mm capillary pipe isolatedmm gland nut with knob probe		



GEV No.	375215	Ref. No.	32Z2430
description	thermostat t.max. 65°C temperature range fixed 65°C 1-pole 1CO 16A probe ø 6mm probe L 130mm capillary pipe 900mm capillary pipe isolated 900mm gland nut shaft Lmm shaft position		
For models:	F60PR, F60T, F80P, F80PR, L100, L40, L40S, L60, L80		



GEV No.	390040	Ref. No.	32V0200
description	thermostat t.max. 90°C temperature range 30-90°C 1-pole 1CO 16A probe ø 6mm probe L 130mm capillary pipe 2040mm capillary pipe isolated 1940mm gland nut shaft ø 6x4.6mm shaft L 23mm shaft position upper rotation 270° probe material SS		
For models:	F60P, F60PR, F60T, F80P, F80PR, L45		



GEV No.	390003	Ref. No.	32Z0450
description	thermostat t.max. 90°C temperature range 30-90°C 1-pole 1CO 16A probe ø 15mm probe L 22.5mm capillary pipe 1700mm capillary pipe isolatedmm gland nut shaft ø 6x4.6mm shaft L 16mm shaft position upper° shaft position rotation 270° with knob probe		
accessories for	390003		
	GEV No.	Ref. No.	—
	gasket for thermostat ED ø 27mm ID ø 11mm thickness 8.5mm		



GEV No.	390032	Ref. No.	32Z0160 32Z5880
description	thermostat t.max. 90°C temperature range 30-90°C 1-pole 1CO 16A probe ø 6mm probe L 130mm capillary pipe 2500mm capillary pipe isolatedmm gland nut M10x1 shaft ø 6x4.6mm shaft L 23mm shaft position upper rotation 270° probe material SS		
For models:	FC101, FC1011E, FC1011G, FC101E, FC1221E, FC1221G, FC241, FC241E, FC241G, FC61, FC611E, FC611G, FC61E, FCV101, FCV101-CSA, FCV101E, FCV101E-UL, FCV141, FCV141-CSA, FCV141E, FCV241, FCV241E, FCV241E-UL, FCV241G, FCV3EM, FCV401DM, FCV401EDM, FCV401EDM-UL, FCV4EM, FCV61, FCV61-CSA, FCV61E, FCV61E-UL, FCV72E-UL, L100, L40, L40S, L60, L80		



GEV No.	375632	Ref. No.	32Z5880
description	thermostat t.max. 90°C temperature range 30-90°C 1-pole 1CO 16A probe ø 6mm probe L 130mm capillary pipe 1300mm capillary pipe isolated 850mm gland nut M10x1 shaft ø 6x4.6mm shaft L 23mm shaft position upper rotation 270°		

55.34_ series



GEV No.	375343	Ref. No.	32Z9210
description	thermostat t.max. 160°C temperature range fixed 160°C 3-pole 3NC 16A probe ø 6mm probe L 74mm capillary pipe 900mm capillary pipe isolated 900mm gland nut		
For models:	190BM2E, 1A0BME, 1D0BME		



GEV No.	375038	Ref. No.	32Z2560
description	thermostat t.max. 300°C temperature range 50-300°C 3-pole 3NO 16A probe ø 6mm probe L 79mm capillary pipe 1740mm capillary pipe isolated 800mm gland nut shaft ø 6x4.6mm shaft L 23mm shaft position upper rotation 270°		
For models:	191FAAE, 191FAE, 191PE4E, 1A1PE4E, 1A1PEFTE, 1A1FBE, 1D1PE4E, 1D1FBE, 71E, 71GE, 71GEGG, FS30E		
accessories for	375038		
	GEV No.	110123	Ref. No. —
	knob thermostat t.max. 300°C ø 50mm shaft ø 6x4.6mm shaft flat upper black temperature range 50-300°C rotation 270°		



GEV No.	375991	Ref. No.	3110640
description	thermostat t.max. 560°C temperature range fixed 560°C 3-pole 3NC 16A probe ø 3.9mm probe L 225mm capillary pipe 1150mm capillary pipe isolated 600mm gland nut		
For models:	04WPBEV, 08WPBEV, 08WTPBEV, 090PEB, 091PEB, 190PEB, 190TPE, 191PEB, 191TPE, 6042610, 6042630, 6044340, 6044350		



GEV No.	375411	Ref. No.	32z0130
description	thermostat t.max. 93°C temperature range 30-93°C 3-pole 3NO 16A probe ø 6mm probe L 129mm capillary pipe 1480mm capillary pipe isolated 1100mm gland nut M10x1 shaft ø 6x4.6mm shaft L 23mm shaft position upper rotation 270°		





GEV No.	375836	Ref. No.	3001550
description	thermostat t.max. 95°C temperature range fixed 95°C 3-pole 1CO/2NC 16A probe ø 3.1mm probe L 226mm capillary pipe 880mm capillary pipe isolated 880mm gland nut		
For models:	08WGREV, 190GRE, 1G0GRE, 1G1PE1E, 1G1PE1EV, 1G1PE2E, 1G1PE2EV, 2G1PE1E, 2G1PE1EV, 2G1PE2E, 2G1PE2EV		

safety thermostats

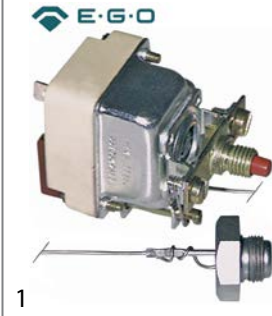
55.10/19_ series



GEV No.	375166	Ref. No.	31Z7990 32Z3340 32Z8000
description	safety thermostat switch-off temp. 230°C 1-pole 0.5A probe ø 11mm probe L 16.5mm capillary pipe 850mm capillary pipe isolated 850mm gland nut probe screw-in probe probe thread M14x1		
For models:	30F, 30FS, 70F, 71F		
accessories for	375166		
	GEV No.	521133	Ref. No. —
	nut thread M14x1.5 H 6mm WS 19 zinc-coated steel Qty 1 pcs		
	GEV No.	532520	Ref. No. 3150390
	O-ring silicone thickness 2.62mm ID ø 15.08mm Qty 1 pcs		
	GEV No.	550261	Ref. No. —
	nut thread M14x1 H 4mm WS 19 SS Qty 1 pcs		

55.32_ series



GEV No.	375308	Ref. No.	32Z9620 32Z9621
description	safety thermostat switch-off temp. 135°C 3-pole 0.5A probe ø 11mm probe L 27.5mm capillary pipe 1000mm capillary pipe isolated 960mm gland nut probe screw-in probe probe thread M14x1		
For models:	191PI1G, 191PI1GA, 191PI2G, 191PI2GA, 1A1PI1G, 1A1PI1GA, 1D1PI1G, 1D1PI1GA, 1G1PI1G, 291PD3G, 291PI3G, 31PI6, 71PI10, 71PI10A, 91PI10, 91PI10A		



GEV No.	375208	Ref. No.	32V398
description	safety thermostat switch-off temp. 139°C 3-pole 2x20/1x0.5A probe ø 6mm probe L 77mm capillary pipe 890mm capillary pipe isolated mm gland nut M9x1 probe SS		

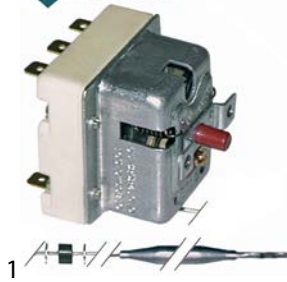

GEV No.	375209	Ref. No.	32V3980 32Z2011
description	safety thermostat switch-off temp. 140°C 3-pole 20A probe ø 6mm probe L 89mm capillary pipe 900mm capillary pipe isolated 900mm gland nut probe SS		
For models:	191CP1GA, 1A1CP1GA, 1A1PI2G, 1A1PI2GA, 1D1CP1GA, 1D1PI2G, 1D1PI2GA, 291PD3G, 291PI3G, 2A1PD3G, 2A1PI3G, 2D1PI3G, F60P, F60PR, F60T, F80P, F80PR, L100, L40, L40S, L45, L60, L80		

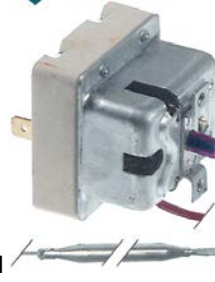

GEV No.	375622	Ref. No.	32V0320
description	safety thermostat switch-off temp. 147°C 1-pole 20A probe ø 6mm probe L 89mm capillary pipe 900mm capillary pipe isolated 800mm gland nut probe		
For models:	291PI3E, 2A1PI3E, MCF20E, MCF40E		

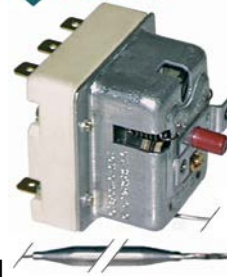

GEV No.	390166	Ref. No.	32Z2710
description	safety thermostat switch-off temp. 150°C 3-pole 20A probe ø 6mm probe L 87mm capillary pipe 1490mm capillary pipe isolated 1250mm gland nut M9x1 probe SS		
For models:	04WCP1EM, 0A1CP1E, 0D1CP1E, 0G1CP1E, 191PI2E, 191PI2EA, 1A1PI2E, 1A1PI2EA, 1D1PI2E, 1D1PI2EA, 1G1PI1E, 30CPSE, 31PIE6, 70CPE, 71PIE15, 71PIE15A, 90CPE, 91PIE15, 91PIE15A		





GEV No.	375528	Ref. No.	32V0460
description	safety thermostat switch-off temp. 200°C 1-pole 0.5A probe ø 6mm probe L 79mm capillary pipe 900mm capillary pipe isolated 900mm gland nut probe SS		
For models:	090BM1G, 0A0BMG, 0D0BMG, 190BM2G, 1A0BMG, 1D0BMG		





GEV No.	375290	Ref. No.	32Z3631
description	safety thermostat switch-off temp. 240°C 3-pole 20A probe ø 6mm probe L 87mm capillary pipe 2000mm capillary pipe isolated 1800mm gland nut probe SS		
For models:	030FE, 030FE1, 030FE1B, 091FE28, 091FE28B, 30FES, 30FES2, 30FES2B, 70FE, 70FE1, 70FE1B, 70FES, 70FES2, 70FES2B, 71FE, 71FE2, 71FE2B		

GEV No.	391040	Ref. No.	32V6561
description	safety thermostat switch-off temp. 270°C 3-pole 3NC 16A probe ø 6mm probe L 79mm capillary pipe 2050mm capillary pipe isolated 1700mm probe no to be sold in France probe material SS		
For models:	04WFR3ED, 08WFR4ED, 091FR1E, 091FR1EA, 091FR1ED, 091FR1EX, 091FR3E, 091FR3ED, 091FR7G, 091FR7GS, 091FR7G-VERS.052012, 091FR7GX, 0A1FR1E, 0A1FR1ED, 0A1FR3E, 0A1FR3ED, 0D1FR1E, 0D1FR1ED, 0D1FR3E, 0D1FR3ED, 0G0FR3E, 0G0FR3ED, 191FR2E, 191FR2ED, 191FR4E, 191FR4ED, 1A1FR2E, 1A1FR2ED, 1A1FR4E, 1A1FR4ED, 1D1FR2ED, 1D1FR4E, 1D1FR4ED, 1G0FR4E, 6043840, 6043970		



GEV No.	375841	Ref. No.	32V4630 32Z0200 32Z7980
description	safety thermostat switch-off temp. 248°C 3-pole probe ø 6mm probe L 87mm capillary pipe 1500mm capillary pipe isolatedmm gland nut probe SS		
For models:	0M0FR1E, 1M0FR2E		



GEV No.	375840	Ref. No.	32V6560
description	safety thermostat switch-off temp. 270°C 3-pole 3NC 20A probe ø 6mm probe L 79mm capillary pipe 2000mm capillary pipe isolatedmm gland nut probe SS		
For models:	04WFR3ED, 08WFR4ED, 091FR1E, 091FR1ED, 091FR3E, 091FR3ED, 0A1FR1E, 0A1FR1ED, 0A1FR3E, 0A1FR3ED, 0D1FR1E, 0D1FR1ED, 0D1FR3E, 0D1FR3ED, 0G0FR3E, 0G0FR3ED, 191FR2E, 191FR2ED, 191FR4E, 191FR4ED, 1A1FR2E, 1A1FR2ED, 1A1FR4E, 1A1FR4ED, 1D1FR2ED, 1D1FR4E, 1D1FR4ED, 1G0FR4E		



GEV No.	375292	Ref. No.	32V0970
description	safety thermostat switch-off temp. 253°C 3-pole 20A probe ø 6mm probe L 79mm capillary pipe 2000mm capillary pipe isolated 1800mm gland nut probe		
For models:	0A1FR1E, 0A1FR1ED, 0D1FR1E, 0D1FR1ED, 1A1FR2E, 1A1FR2ED, 1D1FR2ED		



GEV No.	375286	Ref. No.	32Z5381 32Z5610
description	safety thermostat switch-off temp. 285°C 1-pole 0.5A probe ø 4mm probe L 120mm capillary pipe 1500mm capillary pipe isolated 1500mm gland nut probe		
For models:	06WFR3GD, 091FR1G, 091FR1GD, 091FR3G, 091FR3GD, 0A1FR1G, 0A1FR1GD, 0A1FR1GD-VERS.2004, 0A1FR1G-VERS.2004, 0A1FR3G, 0A1FR3GD, 0B1FR1G, 0B1FR1GD, 0D1FR1G, 0D1FR1GD, 0D1FR1GD-VERS.2004, 0D1FR1G-VERS.2004, 0D1FR3G, 0D1FR3GD, 0G1FR3G, 0G1FR3GD, 10WFR4GD, 191FR2G, 191FR2GD, 191FR4G, 191FR4GD, 1A1FR2G, 1A1FR2GD, 1A1FR2GD-VERS.2004, 1A1FR2G-VERS.2004, 1A1FR4G, 1A1FR4GD, 1D1FR2G, 1D1FR2GD, 1D1FR2GD-VERS.2004, 1D1FR2G-VERS.2004, 1D1FR4G, 1D1FR4GD, 1G1FR4G, 1G1FR4GD, 30F1, 30F1B, 30FS2, 30FS2B, 70F1, 70F1B, 71F2, 71F2B, 90F110B, 91F210...(Other models you can see in the webshop)		



GEV No.	375943	Ref. No.	32Z5612
description	safety thermostat switch-off temp. 299°C 1-pole 20A probe ø 4mm probe L 123mm capillary pipe 1500mm capillary pipe isolated 1400mm gland nut probe		
For models:	06WFR3GD, 091FR1G, 091FR1GD, 091FR1I, 091FR1IA, 091FR1ID, 091FR1ID-VERS.052012, 091FR1I-VERS.032012, 091FR3G, 091FR3GD, 0A1FR1G, 0A1FR1GD, 0A1FR1GD-VERS.2004, 0A1FR1G-VERS.2004, 0A1FR3G, 0A1FR3GD, 0B1FR1G, 0B1FR1GD, 0D1FR1G, 0D1FR1GD, 0D1FR1GD-VERS.2004, 0D1FR1G-VERS.2004, 0D1FR3G, 0D1FR3GD, 0G1FR3G, 0G1FR3GD, 10WFR4GD, 191FR2G, 191FR2GD, 191FR2I, 191FR2ID, 191FR2ID-VERS.092012, 191FR2I-VERS.032012, 191FR4G, 191FR4GD, 1A1FR2G, 1A1FR2GD, 1A1FR2GD-VERS.2004, 1A1FR2G-VERS.2004, 1A1FR4G, 1A1FR4GD, 1D1FR2G, 1D1FR2GD, 1D1FR2GD-VERS.2004, 1D1FR2G-VERS.2004, 1D1FR4G, 1D1FR4GD, 1G1FR4G, 1G1FR4GD, 30F1...(Other models you can see in the webshop)		



GEV No.	375307	Ref. No.	32Z9201 32Z9202
description	safety thermostat switch-off temp. 365°C 3-pole 20A probe ø 4mm probe L 120mm capillary pipe 1300mm capillary pipe isolated 1250mm gland nut probe SS		
For models:	031FTE04, 031FTE06, 06WBR3E, 06WFT1EV, 06WFT2EV, 06WFT3EV, 06WFT4EV, 06WFT6EV, 06WFT7EV, 070FTE04, 070FTE05, 071FTE04, 071FTE06, 08WFA4E, 08WFAAE, 08WFT1EV, 08WFT2EV, 08WFT3EV, 08WFT4EV, 08WFT6EV, 08WFT7EV, 090FT1E, 090FT2E, 090FT4E, 090FT5E, 090FT7E, 090FTE04, 090FTE05, 091FT1E, 091FT2E, 091FT4E, 091FT5E, 091FT7E, 091FTE04, 091FTE06, 0A0FT1E, 0A0FT2E, 0A0FT4E, 0A0FT5E, 0D0FT1E, 0D0FT2E, 0D0FT4E, 0D0FT5E, 0G0FT1E, 0G0FT2E, 0G0FT4E, 0G0FT5E, 0G0FT7E, 0G1BR3E, 0G1FT2E...(Other models you can see in the webshop)		



GEV No.	375220	Ref. No.	32Z6790
description	safety thermostat switch-off temp. 330°C 3-pole 20A probe ø 11mm probe L 18.5mm capillary pipe 900mm capillary pipe isolated 900mm gland nut probe screw-in probe probe thread M14x1		
For models:	FCV4E, FCV4EDS		

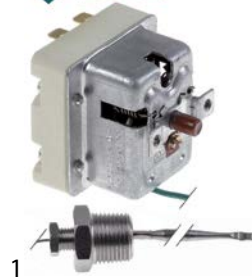

GEV No.	375474	Ref. No.	3111950 32Z5511
description	safety thermostat t.max. 340°C switch-off temp. 340°C 2-pole 1NC/1CO 1x20/1x0.5A probe ø 4mm probe L 120mm capillary pipe 1300mm capillary pipe isolated 900mm gland nut probe		
For models:	FC101, FC1011E, FC1011G, FC101E, FC1221E, FC1221G, FC241, FC241E, FC241G, FC61, FC611E, FC611G, FC61E, FCV101, FCV101DM, FCV101DS, FCV101E, FCV101EDM, FCV101EDS, FCV141, FCV141DM, FCV141DS, FCV141E, FCV141EDM, FCV141EDS, FCV241, FCV241DM, FCV241DS, FCV241E, FCV241EDM, FCV241EDS, FCV241G, FCV241G-CSA, FCV241GDM, FCV241GDS, FCV3EM, FCV401DM, FCV401EDM, FCV4EM, FCV61, FCV61DM, FCV61DS, FCV61E, FCV61EDM, FCV61EDS, FM1011E1, FM1011E1-VERS.2006, FM1011E2, FM1011E2-VERS.2006, FM1011E3...(Other models you can see in the webshop)		



GEV No.	375344	Ref. No.	32Z1400
description	safety thermostat switch-off temp. 360°C 1-pole 0.5A probe ø 4mm probe L 120mm capillary pipe 1500mm capillary pipe isolated 1500mm gland nut probe		
For models:	031FT04, 031FT06, 070FT04, 070FT05, 071FT04, 071FT06, 08WFT-4GV, 08WFT6GV, 090FT04, 090FT05, 090FT4G, 090FT5G, 091FT04, 091FT06, 0A0FT1G, 0A0FT2G, 0A0FT4G, 0A0FT5G, 0B0FT1G, 0B0FT2G, 0B0FT4G, 0B0FT5G, 0D0FT1G, 0D0FT2G, 0D0FT4G, 0D0FT5G, 0G0FT4G, 0G0FT4G-VERS.032008, 0G0FT5G, 0G0FT5G-VERS.032008, 0G1BR3G, 190FT15G, 190FT42G, 190FT4G, 190FT6G, 1A0FT1G, 1A0FT2G, 1A0FT3G, 1A0FT4G, 1A0FT6G, 1B0FT4G, 1B0FT6G, 1D0FT1G, 1D0FT2G, 1D0FT3G, 1D0FT4G, 1D0FT6G, 1G0FT4G, 1G0FT4G-VERS.032008, 1G0FT6G...(Other models you can see in the webshop)		



E-G-O



GEV No.	375438	Ref. No.	3014260 3014261
description	thermostat switch-off temp. 156°C 3-pole 20A probe ø 6mm probe L 87mm capillary pipe 1490mm capillary pipe isolated 1350mm gland nut shaft ø 6x4.6mm probe		
For models:	04WCP1EM, 091CP1E, 0A1CP1E, 0D1CP1E, 0G1CP1E, 0G1CP1EC, 0G1CP1E-VERS.2004, 10CP1EA, 12CP1EA, 18CP2EA, 6040090, 6040310, 6043250, 6043470, 6043850, 6043980, PIER06HD, PIER15HD		

55.10/19_ series

E-G-O



GEV No.	375288	Ref. No.	32Z6630
description	thermostat capillary pipe isolatedmm gland nut shaft ø 6x4.6mm screw-in probe		
For models:	030FE1B, 091FE28B, 091FR1G, 091FR3G, 0A1FR1G, 0A1FR1G-VERS.2004, 0A1FR3G, 0A1FR3GD, 0B1FR1G, 0D1FR1G, 0D1FR1G-VERS.2004, 0D1FR3G, 0D1FR3GD, 0G1FR3G, 191FR2G, 191FR4G, 1A1FR2G, 1A1FR2G-VERS.2004, 1A1FR4G, 1A1FR4GD, 1D1FR2G, 1D1FR2G-VERS.2004, 1D1FR4G, 1D1FR4GD, 1G1FR4G, 30F1B, 30FES2B, 30FS2B, 70F1B, 70FE1B, 70FES2, 70FES2B, 71F2B, 71FE2B, 90F110B, 91F210B, 91F223B		

control thermostats with operation switch

51._ series





E-G-O



GEV No.	375346	Ref. No.	32Z9270
description	thermostat t.max. 110°C temperature range 30-110°C 1-pole 1NO 15A probe ø 6mm probe L 130mm capillary pipe 900mm capillary pipe isolated 900mm shaft ø 6x4.6mm shaft L 23mm shaft position upper rotation 318° outer switch 2NO		

E-G-O



GEV No.	375289	Ref. No.	32Z2480
description	thermostat t.max. 180°C temperature range 100-180°C 1-pole 1NO 16A probe ø 11mm probe L 10mm capillary pipe 850mm capillary pipe isolated 850mm gland nut outer switch 2NO probe thread M14x1		
For models:	030FE, 30FES, 70FE, 70FES, 71FE		
spare parts for	375289		
	GEV No.	300200	Ref. No. —
	operation switch 2 operating positions 2NO 16A sequence 0-1 shaft ø 6x4.6mm shaft L 23mm connection male faston 6.3mm operation switch ceramic		
	GEV No.	550060	Ref. No. —
	connecting bow long for thermostat Qty 1 pcs		
accessories for	375289		
	GEV No.	361182	Ref. No. 3117580
	nut thread 1/4" H 5mm nickel-plated brass WS 17 Qty 1 pcs		
	GEV No.	532520	Ref. No. 3150390
	O-ring silicone thickness 2.62mm ID ø 15.08mm Qty 1 pcs		

E-G-O









GEV No.	390069	Ref. No.	32Z0500
description	thermostat t.max. 265°C temperature range 45-265°C 1-pole 1NO 15A probe ø 3mm probe L 219mm capillary pipe 900mm capillary pipe isolatedmm shaft ø 6x4.6mm shaft L 23mm shaft position upper rotation 270° outer switch 2NO		



			
GEV No.	390765	Ref. No.	32Z5970
description	thermostat t.max. 110°C temperature range 30-110°C 3-pole 3NO 16A probe ø 6mm probe L 131mm capillary pipe 1160mm gland nut shaft ø 6x4.6mm shaft L 23mm shaft position upper rotation 310°		
For models:	ACBM, ACBM218, ANBM, ANBM218, ANBM75, SE14VB, SE21VB, SI14VB, SI21VB, SL14CVB, SL14NVB, SL21CVB, SL21NVB, SL7NVB, TBM, TBM218		

			
GEV No.	375269	Ref. No.	32Z3790
description	thermostat t.max. 300°C temperature range 100-300°C 3-pole 3NO 16A probe ø 6mm probe L 75mm capillary pipe 1150mm capillary pipe isolated 1150mm gland nut shaft L 23mm rotation 270° outer switch 4NO		
For models:	030FTE, 030FTEr, 031FTE, 031FTEr, 031FTErL		

			
GEV No.	375274	Ref. No.	32Z7400
description	thermostat t.max. 260°C temperature range 100-260°C 3-pole 3NO 16A probe ø 6mm probe L 75mm capillary pipe 1150mm capillary pipe isolated 1150mm gland nut rotation 270°		
For models:	031FTE04, 031FTE06, 06WFT1EV, 06WFT2EV, 06WFT3EV, 06WFT4EV, 06WFT6EV, 06WFT7EV, 070FTE04, 070FTE05, 071FTE04, 071FTE06, 08WFT1EV, 08WFT2EV, 08WFT3EV, 08WFT4EV, 08WFT6EV, 08WFT7EV, 090FT1E, 090FT2E, 090FT4E, 090FT5E, 090FT7E, 090FTE04, 090FTE05, 091FT1E, 091FT2E, 091FT4E, 091FT5E, 091FT7E, 091FTE04, 091FTE06, 0A0FT1E, 0A0FT2E, 0A0FT4E, 0A0FT5E, 0D0FT1E, 0D0FT2E, 0D0FT4E, 0D0FT5E, 0G0FT1E, 0G0FT2E, 0G0FT4E, 0G0FT5E, 0G0FT7E, 0G1FT2E, 0G1FT4E, 0G1FT5E, 0G1FT7E, 190FT15E...(Other models you can see in the webshop)		
spare parts for	375274		
	GEV No.	300200	Ref. No. —
	operation switch 2 operating positions 2NO 16A sequence 0-1 shaft ø 6x4.6mm shaft L 23mm connection male faston 6.3mm operation switch ceramic		
	GEV No.	375813	Ref. No. —
	thermostat t.max. 260°C temperature range 100-260°C 3-pole 3NO 16A probe ø 6mm probe L 75mm capillary pipe 1150mm capillary pipe isolated 1150mm gland nut shaft ø 6x4.6mm shaft L 23mm shaft position upper rotation 270°		
	GEV No.	550060	Ref. No. —
	connecting bow long for thermostat Qty 1 pcs		

spare parts for 375269			
	GEV No.	300080	Ref. No. —
	cam switch 2 operating positions 4NO 16A sequence 0-1 shaft ø 6x4.6mm shaft L 23mm connection screw operation switch ceramic ambient temperature max. 150°C		
	GEV No.	375453	Ref. No. —
	thermostat t.max. 308°C temperature range 100-300°C 3-pole 3NO 16A probe ø 6mm probe L 75mm capillary pipe 1150mm capillary pipe isolatedmm gland nut shaft ø 6x4.6mm shaft L 23mm rotation 270° probe material SS		

			
GEV No.	375299	Ref. No.	32V0660 32V0661
description	thermostat t.max. 330°C temperature range 60-330°C 2-pole 2NO 16A probe ø 4mm probe L 128mm capillary pipe 1500mm capillary pipe isolated 1450mm gland nut shaft ø 6x4.6mm shaft L 23mm shaft position upper rotation 270° outer switch 2NO		
For models:	191BR1E, 191BR1G, 191BR1GA, 191BR2E, 191BR2EA, 191BR2G, 191BR2GA, 1A1BR1E, 1A1BR1G, 1A1BR1GA, 1A1BR2E, 1A1BR2EA, 1A1BR2G, 1A1BR2GA, 1D1BR1E, 1D1BR1G, 1D1BR1GA, 1D1BR2E, 1D1BR2EA, 1D1BR2G, 1D1BR2GA, 291BR1E, 291BR1G, 291BR1GA, 291BR2E, 291BR2EA, 291BR2G, 291BR2GA, 2A1BR1E, 2A1BR1G, 2A1BR1GA, 2A1BR2E, 2A1BR2EA, 2A1BR2G, 2A1BR2GA, 2D1BR1E, 2D1BR1G, 2D1BR1GA, 2D1BR2E, 2D1BR2EA, 2D1BR2G, 2D1BR2GA		
spare parts for	375299		
	GEV No.	300200	Ref. No. —
	operation switch 2 operating positions 2NO 16A sequence 0-1 shaft ø 6x4.6mm shaft L 23mm connection male faston 6.3mm operation switch ceramic		
	GEV No.	550060	Ref. No. —
	connecting bow long for thermostat Qty 1 pcs		



IMIT / TEMPOMATIC / ARTHERMO

control thermostats



GEV No.	390193	Ref. No.	32V1920
description	thermostat t.max. 56°C temperature range 0-90°C 1-pole 1CO 16A probe ø 6.5mm probe L 95mm capillary pipe 1500mm capillary pipe isolated 1500mm gland nut shaft ømm shaft Lmm shaft position rotation 270° probe material copper		
For models:	LC100, LC100-VERS.2001, LC130, LC130-VERS.2001, LC80		



GEV No.	390421	Ref. No.	32Z7200
description	thermostat t.max. 85°C temperature range 0-90°C 1-pole 1CO 16A probe ø 6.5mm probe L 95mm capillary pipe 1500mm capillary pipe isolated 1450mm gland nut shaft ømm shaft Lmm shaft position rotation 270° probe material copper		
For models:	LT10R, LT20F, LT25F		



GEV No.	390310	Ref. No.	32V2630
description	thermostat t.max. 85°C temperature range fixed 55°C 1-pole 1CO 16A probe ø 9.5mm probe L 37mm capillary pipe 600mm capillary pipe isolated 540mm gland nut shaft ømm shaft Lmm shaft position rotation° screw-in probe probe thread 3/8" probe material SS		
For models:	LF50, LF50E, LF50EM, LF50EMPS, LF50E-VERS.2007		

accessories for	390310			
	GEV No.	506024	Ref. No.	—
	nut thread 3/8" H 6mm SS WS 22 Qty 1 pcs			
	GEV No.	529349	Ref. No.	—
	flat gasket FIBER ED ø 22mm ID ø 16.5mm thickness 2mm for thread 3/8" Qty 1 pcs			



GEV No.	390006	Ref. No.	32V1910 32Z8840
description	thermostat t.max. 86°C temperature range 0-86°C 1-pole 1CO 16A probe ø 6.5mm probe L 95mm capillary pipe 1500mm capillary pipe isolatedmm gland nut shaft ø 6x4.6mm shaft L 19mm rotation 270°		
For models:	C207D-VERS.2006, C207S-VERS.2006, C207VD-VERS.2006, C207VS-VERS.2006, C304AD-VERS.2006, C304AS-VERS.2006, C304AVD-VERS.2006, C304AVS-VERS.2006, C304D-VERS.2006, C304S-VERS.2006, C304VD-VERS.2006, C304VS-VERS.2006, C92D-VERS.2006, C92S-VERS.2006, C92VD-VERS.2006, C92VS-VERS.2006, CS243D-VERS.2006, CS243S-VERS.2006, CS243VD-VERS.2006, CS243VS-VERS.2006, CS370AD-VERS.2006, CS370AS-VERS.2006, CS370AVD-VERS.2006, CS370AVS-VERS.2006, CS370D-VERS.2006, CS370S-VERS.2006, CS370VD-VERS.2006, CS370VS-VERS.2006, CS466AD-VERS.2006, CS466AS-VERS.2006, CS466AVD-VERS.2006, CS466AVS-VERS.2006, CS466D-VERS.2006, CS466S-VERS.2006, CS466VD-VERS.2006, CS466VS-VERS.2006, LC100, LC100-VERS.2001, LC130, LC130-VERS.2001, LC80, LF50		

accessories for	390006		
------------------------	--------	--	--

	GEV No.	110100	Ref. No.	36M2830
	knob thermostat t.max. 90°C 0-90°C ø 42mm shaft ø 6x4.6mm shaft flat -135° black			

	GEV No.	110105	Ref. No.	—
	rosette knob ø 42mm ø 56mm zero mark			



GEV No.	390704	Ref. No.	32Z8840
description	thermostat t.max. 86°C temperature range 0-86°C 1-pole 1CO 16A probe ø 6.5mm probe L 98mm capillary pipe 1020mm capillary pipe isolated 950mm gland nut shaft ø 6x4.6mm shaft L 19mm shaft position +135° rotation 270° probe material copper 250V		
For models:	C165D, C165S, C165VD, C165VS, C207D, C207S, C207VD, C207VS, C304AD, C304AD-VERS.2006, C304AS, C304AS-VERS.2006, C304AVD, C304AVD-VERS.2006, C304AVS, C304AVS-VERS.2006, C304D, C304D-VERS.2006, C304S, C304S-VERS.2006, C304VD, C304VD-VERS.2006, C304VS, C304VS-VERS.2006, CS243D, CS243D-VERS.2006, CS243S, CS243S-VERS.2006, CS243VD, CS243VD-VERS.2006, CS243VS, CS243VS-VERS.2006, CS370AD, CS370AD-VERS.2006, CS370AS, CS370AS-VERS.2006, CS370AVD, CS370AVD-VERS.2006, CS370AVS, CS370AVS-VERS.2006, CS370D, CS370D-VERS.2006, CS370S, CS370S-VERS.2006, CS370VD, CS370VD-VERS.2006, CS370VS, CS370VS-VERS.2006, CS466AD, CS466AD-VERS.2006...(Other models you can see in the webshop)		

GEV No.	390460	Ref. No.	32V7240
description	thermostat t.max. 90°C temperature range 30-90°C 1-pole 1CO 16A probe ø 6.5mm probe L 95mm capillary pipe 2000mm capillary pipe isolated 1950mm gland nut shaft ømm shaft Lmm shaft position rotation 270° probe material copper		

safety thermostats



GEV No.	390023	Ref. No.	32Z8530 32Z8830
description	safety thermostat switch-off temp. 90-110°C 1-pole 16A probe ø 6.5mm probe L 90mm capillary pipe 1000mm capillary pipe isolated-mm gland nut probe		
For models:	C165D, C165S, C207D, C207D-VERS.2006, C207S, C207S-VERS.2006, C207VD-VERS.2006, C207VS-VERS.2006, C304AD, C304AD-VERS.2006, C304AS, C304AS-VERS.2006, C304AVD-VERS.2006, C304A-VS-VERS.2006, C304D, C304D-VERS.2006, C304S, C304S-VERS.2006, C304VD-VERS.2006, C304VS-VERS.2006, C92D-VERS.2006, C92S-VERS.2006, C92VD-VERS.2006, C92VS-VERS.2006, CS243D, CS243S, CS243VD, CS243VS, CS370AD, CS370AS, CS370AVD, CS370AVS, CS370D, CS370S, CS370VD, CS370VS, CS466AD, CS466AS, CS466AVD, CS466AVS, CS466D, CS466S, CS466VD, CS466VS, LC100, LC100-VERS.2001, LC130, LC130-VERS.2001, LC80, LF50...(Other models you can see in the webshop)		

PRODIGY / FIRT

control thermostats



GEV No.	390723	Ref. No.	32Z0190
description	thermostat PRODIGY temperature range -35 up to +35°C probe ø 6mm probe L 110mm capillary pipe 1500mm type TR/711-N		
accessories for	390723		
	GEV No.	110305	Ref. No. —
	knob thermostat t.max. 35°C temperature range -35 up to +35°C ø 45mm shaft ø 6x4.6mm shaft flat inclined rotation 270° white		

RANCO

safety thermostats

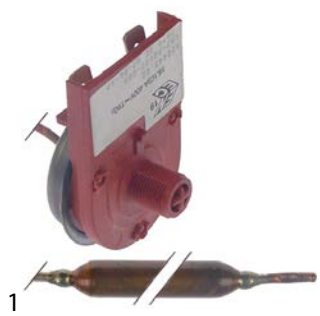

GEV No.	375832	Ref. No.	3040550
description	safety thermostat t.max. 70°C temperature range 0-70°C 1-pole 1NO 16A probe ø 8mm probe L 60mm capillary pipe 870mm capillary pipe isolatedmm gland nut shaft ømm shaft Lmm shaft position rotation° probe material copper switch-off temp. 70°C		
For models:	PG22C, PG23C, PG23CW, PG24CW, PG30C, PG31CW, PG42C, PG43CW, PG60C, PG61CW, PG80C, PG80C-VERS.200911, PG81CW, PG81CW-VERS.200911, PGC132, PGC134W, PGC210, PGC212W		

various

control thermostats



GEV No.	375287	Ref. No.	6300359
description	thermostat t.max. 190°C temperature range 160-190°C probe ø 16mm probe L 93mm probe thread 1/2"		
For models:	030FE1, 30F1, 30FES2, 30FS2, 70F1, 70FE1, 70FES2, 71F2, 71FE2, 91F210		

control thermostats with operation switch



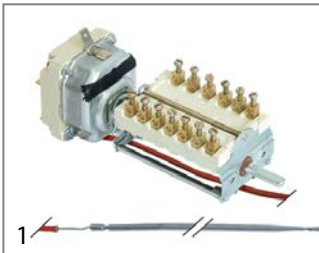

GEV No.	375951	Ref. No.	6300738
description	thermostat t.max. 187°C 1-pole 1NO probe ø 6mm probe L 132mm capillary pipe 900mm capillary pipe isolated 480mm shaft ø 4.5x6mm shaft L 23mm outer switch 42.02900.000 with thermowell		
For models:	030FE1B, 091FE28B, 091FR1G, 091FR3G, 0A1FR1G, 0A1FR1G-VERS.2004, 0A1FR3G, 0A1FR3GD, 0B1FR1G, 0D1FR1G, 0D1FR1G-VERS.2004, 0D1FR3G, 0D1FR3GD, 0G1FR3G, 191FR2G, 191FR4G, 1A1FR2G, 1A1FR2G-VERS.2004, 1A1FR4G, 1A1FR4GD, 1D1FR2G, 1D1FR2G-VERS.2004, 1D1FR4G, 1D1FR4GD, 1G1FR4G, 30F1B, 30FES2B, 30FS2B, 70F1B, 70FE1B, 70FES2, 70FES2B, 71F2B, 71FE2B, 90F110B, 91F210B, 91F223B		
spare parts for	375951		
	GEV No.	301115	Ref. No. 3168540
	cam switch 2 operating positions 2NO sequence 0-1 16A shaft ø 6x4.6mm shaft L 23mm connection male faston 6.3mm		
	GEV No.	375922	Ref. No. 3168460
	thermostat t.max. 185°C temperature range 101-185°C 1-pole 1NO 16A probe ø 6mm probe L 133mm capillary pipe 870mm capillary pipe isolated 520mm gland nut M10x1 shaft ø 6x4.6mm shaft L 23mm shaft position upper		

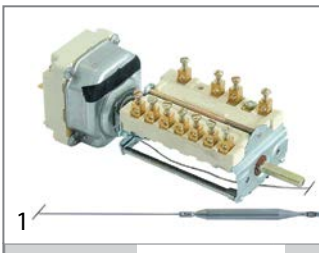

GEV No.	375267	Ref. No.	32Z3550 32Z3551
description	thermostat t.max. 290°C temperature range 50-290°C 3-pole 3NO probe ø 3mm probe L 219mm capillary pipe 1200mm capillary pipe isolated 1200mm shaft position lower rotation 270°		
For models:	1G1FA0E, 1G1FA0EV, 1G1PE1E, 1G1PE1EV, 1G1PE2E, 1G1PE2EV, 2G1FA0E, 2G1PE1E, 2G1PE1EV, 2G1PE2E, 2G1PE2EV, 31GE, 31TCE, 32TCE		



GEV No.	375265	Ref. No.	32W0030
description	thermostat t.max. 300°C temperature range 50-300°C 3-pole 3NO 16A probe ø 6mm probe L 79mm capillary pipe 1740mm capillary pipe isolated 800mm shaft ø 6x4.6mm rotation 270°		
spare parts for	375265		
	GEV No.	375038	Ref. No. 32Z2560
	thermostat t.max. 300°C temperature range 50-300°C 3-pole 3NO 16A probe ø 6mm probe L 79mm capillary pipe 1740mm capillary pipe isolated 800mm gland nut shaft ø 6x4.6mm shaft L 23mm shaft position upper rotation 270°		
	GEV No.	550059	Ref. No. —
	connecting bow short for switch Qty 1 pcs		

safety thermostats

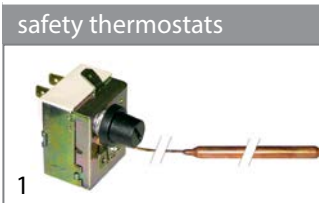

GEV No.	390194	Ref. No.	32V7260
description	safety thermostat switch-off temp. 90-110°C 1-pole 16A probe ø 6.5mm probe L 87mm capillary pipe 1500mm capillary pipe isolated 1497mm connection male faston 6.3mm adjustable		

refrigeration thermostats

universal without housing



GEV No.	390534	Ref. No.	32Z1090 32Z2590 32Z6310 32Z7110
description	thermostat temperature range -35 up to +35°C probe ø6x110mm capillary pipe 1800mm PRODIGY		
For models:	120, 120B, 120NN, 120PV, 135, 135-4, 135B, 135BA, 135BN, 135BNX, 135BX, 135BXE, 135BXR, 135CPX, 135NN, 135NNX, 135PVX, 135X, 135X-3, 135X-4, 135XR, 40CP, 40CPX, 55, 55B, 55PV, 65, 65B, 65BA, 65BX, 65BX-2, 65BXE, 65BXR, 65NB, 65NBX, 65NN, 65NNX, 65PVX, 65X, 65X-2, 65XR, 6BMA11A, 6BMA11B, 6BMA11M, 6BMA2A, 6BMA2B, 6BMA2M, 6BMA3A, 6BMA3B, 6BMA3M...(Other models you can see in the webshop)		
accessories for	390534		
	GEV No.	110305	Ref. No. —
	knob thermostat t.max. 35°C temperature range -35 up to +35°C ø 45mm shaft ø 6x4.6mm shaft flat inclined rotation 270° white		

RANCO

K22 series



GEV No.	390202	Ref. No.	32Z7450
description	thermostat RANCO type K22L2025 probe ømm probe Lmm capillary pipe 1500mm temperature range +1°C up to +11°C		
For models:	PGA20, PGA30, PGA40, PGA60, PGA80, PGW20, PGW30, PGW40, PGW60, PGW80		



GEV No.	390207	Ref. No.	32Z3890
description	thermostat RANCO type K22L2030 probe ø 2mm probe Lmm capillary pipe 2000mm temperature range -13 up to -4°C		
For models:	PGA20, PGA30, PGA40, PGA60, PGA80, PGW20, PGW30, PGW40, PGW60, PGW80		



RANCO



1

GEV No.	390209	Ref. No.	32V2280 32V4360
description	thermostat RANCO type K22L1020 probe ø 9mm probe L 40mm capillary pipe 2000mm temperature range -20.5 up to -1.5°C		
For models:	PG22C, PG23C, PG23CW, PG24CW, PG30C, PG31CW		

RANCO



1

GEV No.	390254	Ref. No.	32V4270
description	thermostat RANCO type K50P1135 probe ømm probe Lmm capillary pipe 2500mm T cold 1.5°C		

RANCO



1

GEV No.	390737	Ref. No.	32V4400
description	thermostat RANCO type K22-L1074 probe ø 9mm probe L 42mm capillary pipe 1450mm temperature range -19 up to -1°C		
For models:	PG42C, PG43CW, PG60C, PG61CW, PG80C, PG80C-VERS.200911, PG81CW, PG81CW-VERS.200911, PGC132, PGC132-VERS.200911, PGC134W, PGC134W-VERS.200911, PGC210, PGC210-VERS.200911, PGC212W, PGC212W-VERS.200911		

RANCO



1

GEV No.	390581	Ref. No.	3111590
description	thermostat RANCO type K50-S3595 probe ø 2mm probe Lmm capillary pipe 2000mm		
For models:	PG23C, PG24CW, PG30C, PG31CW		

K50 series

RANCO



1

GEV No.	390208	Ref. No.	3034730
description	thermostat RANCO type K50L3006 probe ømm probe Lmm capillary pipe 2000mm temperature range +1.5 up to +4°C		
For models:	PG22C, PG23C, PG23CW, PG24CW, PG30C, PG31CW, PG42C, PG43CW, PG60C, PG61CW, PG80C, PG80C-VERS.200911, PG81CW, PG81CW-VERS.200911, PGC132, PGC132-VERS.200911, PGC134W, PGC134W-VERS.200911, PGC210, PGC210-VERS.200911, PGC212W, PGC212W-VERS.200911		

K52 series

RANCO

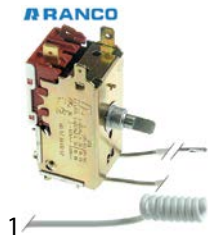

1

GEV No.	390214	Ref. No.	32Z0920
description	thermostat RANCO type K52L4512 probe ø 11mm probe L 30mm capillary pipe 2100mm temperature range -6.4 up to +3.2°C		
For models:	40, 40EV, 40EVP, 40PL, 40PV, 40X, 40XPV		

RANCO



1

GEV No.	390278	Ref. No.	32Z6360
description	thermostat RANCO type K50L3207 probe ømm probe Lmm capillary pipe 1500mm temperature range -10 up to -2°C		
For models:	BRPR, BRPR218, BRPR21C, BRPRV, BRVR, BRVR218, BRVR21C, BRVRV, TPR, TPR218, TPR21C, TPRV, TVR, TVR218, TVR21C, TVRV		

K55 series

RANCO



1

GEV No.	390252	Ref. No.	32Z7580
description	thermostat RANCO type K55L5070 capillary pipe 2500mm temperature range -22 up to -7°C		
For models:	40B, S125B, S125B-4, S125BX, S125BX-4, S60B, S60B-2, S60BX, S60BX-2		

K60 series

RANCO



GEV No.	390598	Ref. No.	32Z4730
description	thermostat RANCO type K60-L2045 probe ø 2mm probe Lmm capillary pipe 2000mm		

accessories

probe clips

clamps

for thermostat



GEV No.	691171	Ref. No.	35T3540
description	probe clip for probe ø 9mm Qty 1 pcs L 30mm W 20mm		
For models:	030FE, 030FE1, 030FE1B, 031FT04, 031FT06, 031FTE04, 031FTE06, 06WBR3E, 06WFT1EV, 06WFT2EV, 06WFT3EV, 06WFT4EV, 06WFT6EV, 06WFT7EV, 070FTE04, 070FTE05, 071FTE04, 071FTE06, 090FT1G, 090FT2G, 090FT4G, 090FT5G, 090FT7G, 090FTE04, 090FTE05, 091FE28, 091FE28B, 091FTE04, 091FTE06, 0A0FT1E, 0A0FT1G, 0A0FT2E, 0A0FT2G, 0A0FT4E, 0A0FT4G, 0A0FT5E, 0A0FT5G, 0B0FT1G, 0B0FT2G, 0B0FT4G, 0B0FT5G, 0D0FT1E, 0D0FT1G, 0D0FT2E, 0D0FT2G, 0D0FT4E, 0D0FT4G, 0D0FT5E, 0D0FT5G, 0G0FT1E...(Other models you can see in the webshop)		



GEV No.	691170	Ref. No.	35S0540
description	probe clip for probe ø 9mm Qty 1 pcs L 38mm W 20mm		
For models:	030FE, 030FE1, 030FE1B, 091FE28, 091FE28B, 0G1BR3E, 1G1BR3E, 30FES, 70FE, 70FES, 71FE		

miscellaneous



GEV No.	691175	Ref. No.	35S5040
description	probe clip for probe ø 4mm for pipe ø 9mm		
For models:	030FE1, 030FE1B, 091FE28, 091FE28B, 30FES2, 30FES2B, 70FES2, 70FES2B		

gland nut accessories

ducts



GEV No.	560623	Ref. No.	3003400
description	gland duct ET M16 IT M10x1 WS 19 L 18mm		
For models:	FM1011E2-VERS.2006, FM1011E3, FM1011E3-VERS.2006, FM1011G2-VERS.2006, FM1011G3, FM1011G3-VERS.2006, FM1221E2-VERS.2006, FM1221E3, FM1221E3-VERS.2006, FM1221G2-VERS.2006, FM1221G3, FM1221G3-VERS.2006, FM2011E2-VERS.2006, FM2011E3-VERS.2006, FM2011G2-VERS.2006, FM2011G3-VERS.2006, FM2021E2-VERS.2006, FM2021E3, FM2021E3-VERS.2006, FM2021G2-VERS.2006, FM2021G3, FM2021G3-VERS.2006, FM423E2, FM611E2-VERS.2006, FM611E3, FM611E3-VERS.2006, FM611G2-VERS.2006, FM611G3, FM611G3-VERS.2006, FM721E2-VERS.2006, FM721E3, FM721E3-VERS.2006, FM721G2-VERS.2006, FM721G3, FM721G3-VERS.2006, FX101E2, FX101E2C, FX101E2C-VERS.032014, FX101E2R, FX101E2R-VERS.032014, FX101E2-VERS.032014, FX101E3, FX101E3C, FX101E3C-VERS.022014, FX101E3R, FX101E3R-VERS.022014, FX101E3-VERS.022014, FX101G2, FX101G2C, FX101G2C-VERS.032014...(Other models you can see in the webshop)		

miscellaneous



GEV No.	691191	Ref. No.	36D6970
description	connecting piece for thermostat		
For models:	030FE1, 30F1, 30FES2, 30FS2		



GEV No.	691154	Ref. No.	37Q3270
description	cover cap temperature limiter		
For models:	04WCP1EM, 04WFR3ED, 06WFR3GD, 08WFA4E, 08WFAAE, 08WFR4ED, 08WFT1EV, 08WFT2EV, 08WFT3EV, 08WFT4EV, 08WFT6EV, 08WFT7EV, 091CP1E, 091FR1E, 091FR1EA, 091FR1ED, 091FR1G, 091FR1GD, 091FR3E, 091FR3ED, 091FR3G, 091FR3GD, 091FT1E, 091FT2E, 091FT4E, 091FT5E, 091FT7E, 0A1CP1E, 0A1FR1E, 0A1FR1ED, 0A1FR1G, 0A1FR1GD, 0A1FR1GD-VERS.2004, 0A1FR1G-VERS.2004, 0A1FR3G, 0A1FR3GD, 0B1FR1G, 0B1FR1GD, 0D1CP1E, 0D1FR1E, 0D1FR1ED, 0D1FR1G, 0D1FR1GD, 0D1FR1GD-VERS.2004, 0D1FR1G-VERS.2004, 0D1FR3G, 0D1FR3GD, 0G1BR3E, 0G1CP1E, 0G1CP1EC...(Other models you can see in the webshop)		



switches and momentary switches

rocker/momentary rocker switches

25.5x25mm



GEV No.	345280 ¹	Ref. No.	32W6010
description	rocker switch mounting measurements 25.5x25mm green 2CO 250V 16A illuminated connection male faston 6.3mm ambient temperature max. 85°C protection IP40		

¹illuminated



GEV No.	345278 ¹	Ref. No.	32W0990 32W3970
description	rocker switch mounting measurements 25.5x25mm green 2NO 250V 16A illuminated 0-1 connection male faston 6.3mm protection IP40		
For models:	3G6SA, 3G6SA2, 3G6SA4, 40-OPR01, 40B-OPR01, 40BX-OPR01, 40CP-OPR01, 40CPX-OPR01, 40EV-OPR01, 40PV-OPR01, 40X-OPR01, 4G6SB, 4G6SB2, 4G6SB4, 4G6SB6, 6BR15V, 6BR15VC, 6BR19V, 6BR19VC, 6ERA-OPR01, 6ERA2-OPR01, 6ERA2A-OPR01, 6ERA2M-OPR01, 6ERAA-OPR01, 6ERAB-OPR01, 6ERABA-OPR01, 6ERABM-OPR01, 6ERAM-OPR01, 6ERB-OPR01, 6ERB2-OPR01, 6ERB2A-OPR01, 6ERB2M-OPR01, 6ERB4-OPR01, 6ERB4A-OPR01, 6ERB4M-OPR01, 6ERBA-OPR01, 6ERBB-OPR01, 6ERBBA-OPR01, 6ERBBM-OPR01, 6ERBM-OPR01, 6ERC-OPR01, 6ERC2-OPR01, 6ERC2A-OPR01, 6ERC2M-OPR01, 6ERC4-OPR01, 6ERC4A-OPR01, 6ERC4M-OPR01, 6ERCA-OPR01, 6ERCB-OPR01, 6ERCBM-OPR01... (Other models you can see in the webshop)		

¹illuminated

30x22mm

labelled



GEV No.	300125	Ref. No.	32W0860 32W2331 32W2990
description	rocker switch mounting measurements 30x22mm green 2NO 230V 16A 0-1 connection male faston 6.3mm ambient temperature max. 125/55°C protection IP65 with cover cap		
For models:	120, 120B, 120NN, 120PV, 135, 135-4, 135A, 135B, 135BA, 135BN, 135BNX, 135BX, 135BXE, 135BXR, 135CPX, 135NN, 135NNX, 135PVX, 135X, 135X-3, 135X-4, 135XE, 135XR, 40, 40B, 40CP, 40CPX, 40EV, 40EVP, 40PL, 40PV, 40X, 40XPV, 55, 55B, 55PV, 65, 65A, 65B, 65BA, 65BX, 65BX-2, 65BXE, 65BXR, 65NB, 65NBX, 65NN, 65NNX, 65PVX, 65X... (Other models you can see in the webshop)		
accessories for	300125		
	GEV No.	301036	Ref. No. —
	protective cover internal size 30x22mm for rocker switch mounting measurementsmm		

GEV No.	301164	Ref. No.	32W0631
description	rocker switch mounting measurements 30x22mm green 2NO 250V 16A illuminated connection male faston 6.3mm ambient temperature max. 85°C protection IP65 with cover cap		
For models:	1G1FA0EV, 1G1FA0GV, 1G1PE1EV, 1G1PE2EV, 2091SCP, 2G1FA0GV, 2G1PE1EV, 2G1PE2EV, 31GE, 31TC, 31TCE, 32TC, 32TCE, FX101E1, FX101E1R, FX101E2, FX101E2C, FX101E2R, FX101E3, FX101E3C, FX101E3C-VERS.022014, FX101E3R, FX101G1, FX101G1R, FX101G2, FX101G2C, FX101G2R, FX101G3, FX101G3C, FX101G3C-VERS.022014, FX101G3R, FX10E2CR, FX10E3CR, FX10E3CR-VERS.022014, FX10G2CR, FX10G3CR, FX10G3CR-VERS.022014, FX122E1, FX122E2, FX122E2C, FX122E3, FX122E3C, FX122G1, FX122G2, FX122G2C, FX122G3, FX122G3C, FX12E3CT, FX12E3CT-VERS.022014, FX12G3CT... (Other models you can see in the webshop)		
accessories for	301164		
	GEV No.	301036	Ref. No. —
	protective cover internal size 30x22mm for rocker switch mounting measurementsmm		

GEV No.	345275	Ref. No.	32W3190
description	rocker switch mounting measurements 30x22mm white 1CO/indicator light 230V 16A 1-2 connection male faston 6.3mm ambient temperature max. 125/55°C protection IP65 with cover cap		
For models:	120, 120NN, 120PV, 135, 135-4, 135BN, 135BNX, 135CPX, 135NN, 135NNX, 135PVX, 135X, 135X-3, 135X-4, 135XR, 55, 55PV, 65, 65NB, 65NBX, 65NN, 65NNX, 65PVX, 65X, 65X-2, 65XR, 6BMA11A, 6BMA11B, 6BMA11M, 6BMA11Z, 6BMA2A, 6BMA2B, 6BMA2M, 6BMA2Z, 6BMA3A, 6BMA3B, 6BMA3M, 6BMA3Z, 6BMAA, 6BMAB, 6BMAM, 6BMAZ, 6BMB11A, 6BMB11B, 6BMB11M, 6BMB11Z, 6BMB22A, 6BMB22B, 6BMB22M, 6BMB22Z... (Other models you can see in the webshop)		

push/momentary push switches

19x13mm



GEV No.	347431	Ref. No.	3126050
description	momentary push switch mounting measurements 19x13mm red 1NO 250V 16A connection male faston 6.3mm ambient temperature max. 105/55°C protection IP40		
For models:	090FAA, 091FR11, 091FR11-VERS.032012, 091FR7G, 091FR7G-VERS.052012, 10CP1GA, 12CP1GA, 18CP2GA, 190FAA, 191FR21, 191FR21-VERS.032012		





			
1			
GEV No.	301054	Ref. No.	3062550 6300676
description	momentary push switch mounting measurements 19x13mm red 1NO 250V 16A connection male faston 6.3mm ambient temperature max. 105/55°C protection IP65 with cover cap		
For models:	090BM1G, 090FAVA, 090FT1G, 090FT2G, 090FT4G, 090FT5G, 090FT7G, 090GRG, 091CP1G, 190BM2G, 190FAB, 190FT15G, 190FT1G, 190FT2G, 190FT3G, 190FT42G, 190FT4G, 190FT6G, 190FT72G, 190FT7G, 190GRG, 190TP0, 191CP1G, 191CP1GA, 191CP2G, 191FAAG, 191FABG, 191FADG, 191FAG, 191PD1G, 191PD2G, 191PI1G, 191PI1GA, 191PI2G, 191PI2GA, 191TPG, 291FAG, 291FAGF, 291PD3G, 291PI3G, 291TPCG, 391FAG, G1FAGS, G1FAGST		

			
2			
GEV No.	301713	Ref. No.	6300674
description	push switch mounting measurements 19x13mm blue 1NO 250V 16A connection male faston 6.3mm ambient temperature max. 85°C protection IP65 with cover cap		
For models:	191BR1E, 191BR1G, 191BR1GA, 191BR2E, 191BR2EA, 191BR2G, 191BR2GA, 291BR1E, 291BR1G, 291BR1GA, 291BR2E, 291BR2EA, 291BR2G, 291BR2GA		

28.5x28.5mm

			
1			
GEV No.	346916	Ref. No.	32V2050
description	momentary push switch mounting measurements 28.5x28.5mm grey 1NO 250V 16A connection male faston 6.3mm ambient temperature max. 125/55°C protection IP40		
For models:	LF50, LF50E, LF50EM, LF50E-VERS.2007		

			
1			
GEV No.	346915	Ref. No.	32V2030
description	push switch mounting measurements 28.5x28.5mm grey 1CO 250V 16A connection male faston 6.3mm ambient temperature max. 125/55°C protection IP40		
For models:	LF50, LF50E, LF50EM, LF50E-VERS.2007		

			
1			
GEV No.	346914	Ref. No.	32V2040
description	push switch mounting measurements 28.5x28.5mm weak 2CO 250V 16A connection male faston 6.3mm ambient temperature max. 150°C protection IP40		
For models:	LF50, LF50E, LF50EM, LF50E-VERS.2007		

			
1			
GEV No.	345587	Ref. No.	32V2050
description	momentary push switch mounting measurements 28.5x28.5mm yellow 1NO 250V 16A connection male faston 6.3mm ambient temperature max. 125°C protection IP40		

			
1			
GEV No.	345589	Ref. No.	32V2030 32V2070
description	push switch mounting measurements 28.5x28.5mm yellow 2CO 250V 16A connection male faston 6.3mm ambient temperature max. 85/125°C protection IP40		

ø22mm

			
1			
GEV No.	699002	Ref. No.	32W2030
description	momentary push switch mounting ø 22mm black/white 1NO/1NC/indicator light 230V 6A 0-1 connection screw ambient temperature max. 70°C protection IP40		
For models:	TG12, TG12X, TG12XE		

ø25mm

			
1			
GEV No.	301322	Ref. No.	3203760
description	push switch mounting ø 25mm silver 1NO/1NC 250V 5A stainless steel connection male faston 2.8mm		
For models:	B151H, B151M, FX201E2, FX201E2P, FX201E2P-VERS.032014, FX201E2-VERS.032014, FX201E3, FX201E3P, FX201E3P-VERS.022014, FX201E3-VERS.022014, FX201G2, FX201G2P, FX201G2P-VERS.032014, FX201G2-VERS.032014, FX201G3P, FX201G3-VERS.022014, FX202E2, FX202E2-VERS.032014, FX202E3, FX202E3-230V-3-50Hz-60Hz, FX202E3-230V-3-50Hz-60Hz-VERS.022014, FX202E3-VERS.022014, FX202G2, FX202G2-VERS.032014, FX202G3, FX202G3-VERS.022014		

2 hole fixing

			
1			
GEV No.	346906	Ref. No.	32W0280
description	switch combination 2CO/2CO/2NO		



			
1			
GEV No.	346905	Ref. No.	32W0830
description	switch combination 2CO/2CO/2NO 250V 16A connection male faston 6.3mm ambient temperature max. 85°C protection IP40		

miscellaneous

			
1			
GEV No.	346910	Ref. No.	32W0410
description	momentary push switch green 1NO/1NC/indicator light 600V 10A connection screw ambient temperature max. 85°C protection IP40		

			
1			
GEV No.	346911	Ref. No.	32W1430
description	momentary push switch green 2NO 300V 3A connection screw ambient temperature max. 125/55°C protection IP40		

			
1			
GEV No.	348228	Ref. No.	32W4140
description	push switch mounting ø 12mm black 2NO/1NC 250V 16A connection male faston 6.3mm		
For models:	KD100, KD100A, KD100PSD, KD85, KD85A, KD85PS, KD85PSA, KN1100, KN1100SD, KN11PSDD, KN35, KN37, KN37PS, KN800, KN800PSD		

accessories

push buttons

			
1			
GEV No.	346912	Ref. No.	32W1420
description	push button black		

microswitches

lever actuated

			
1			
GEV No.	345254	Ref. No.	32W1320
description	microswitch with lever 250V 16A 1CO connection male faston 6.3mm ambient temperature max. 120°C mounting distance 22mm actuating force: 60g lever length 58mm		

			
1			
GEV No.	345257	Ref. No.	32W4240
description	microswitch with lever 250V 16A 1CO connection male faston 6.3mm L 29mm L1 33mm ambient temperature max. 120°C mounting distance 22mm actuating force: 130g lever length 31.5mm		

			
1			
GEV No.	345255	Ref. No.	32W1320
description	microswitch with lever 250V 16A 1CO connection male faston 6.3mm L 35mm L1 28mm ambient temperature max. 125°C mounting distance 22mm actuating force: 136g lever length 27mm		
For models:	120, 120B, 120NN, 120PV, 135, 135-4, 135A, 135B, 135BA, 135BN, 135BNX, 135BX, 135BXE, 135BXR, 135CPX, 135NN, 135NNX, 135PVX, 135X, 135X-3, 135X-4, 135XE, 135XR, 40, 40CP, 40CPX, 40PV, 40X, 40XPV, 55, 55B, 55PV, 65, 65A, 65B, 65BA, 65BX, 65BX-2, 65BXE, 65BXR, 65NB, 65NBX, 65NN, 65NNX, 65PVX, 65X, 65X-2, 65XE, 65XR, S125... (Other models you can see in the webshop)		

			
1			
GEV No.	345459	Ref. No.	32W1180
description	microswitch with lever 250V 15A 1NC connection male faston 6.3mm ambient temperature max. 85°C mounting distance 15-25mm ROLD lever length 66mm series RM		

			
1			
GEV No.	346909	Ref. No.	32W0010
description	microswitch with lever 250V 16A 1CO connection male faston 6.3mm ambient temperature max. 125°C mounting distance 13mm lever length 50mm		

			
1			
GEV No.	346907	Ref. No.	32W0020
description	microswitch with lever 250V 16A 1CO connection male faston ambient temperature max. 85°C		

			
1			
GEV No.	346904	Ref. No.	32W3700
description	microswitch with lever 250V 16A 1NO connection male faston ambient temperature max. male faston 6.3mm°C		
For models:	0M0FR1E, 1M0FR2E		



pin-plunger actuated

M10



1

GEV No.	347216	Ref. No.	32W1660 32W3340
description	microswitch with plunger thread M10x0.75 thread L 14mm 250V 10A 1CO connection male faston 6.3mm stroke 7.5mm mounting distance 22mm L 28mm ambient temperature max. 125°C type NR6K5 actuating force: 260g		
For models:	030FE, 030FE1, 030FE1B, 04WFR3ED, 08WFR4ED, 091FE28, 091FE28B, 091FR3E, 091FR3ED, 0A1FR3E, 0A1FR3ED, 0D1FR3E, 0D1FR3ED, 0G0FR3E, 0G0FR3ED, 10CP1EA, 10CP1GA, 10CP1IA, 12CP1EA, 12CP1GA, 12CP1IA, 18CP2EA, 18CP2GA, 18CP2IA, 191BR1E, 191BR1G, 191BR2E, 191BR2G, 191FR4E, 191FR4ED, 1A1FR4E, 1A1FR4ED, 1D1FR4E, 1D1FR4ED, 1G0FR4E, 291BR1E, 291BR1G, 291BR2E, 291BR2G, 30FES, 30FES2, 30FES2B, 6043840, 6043970, 70FE, 70FE1, 70FE1B, 70FES, 70FES2, 70FES2B...(Other models you can see in the webshop)		

M12



1

GEV No.	345350	Ref. No.	32W3020
description	microswitch with plunger mounting distance 22mm thread M12x0.75 thread L 16mm 250V 16A 1CO connection male faston 6.3mm stroke 4mm ambient temperature max. 125°C type EF83161.3 actuating force: 66g		
For models:	FC101, FC101E, FC241, FC241E, FC241G, FC61, FC61E, FCV101, FCV101DM, FCV101DS, FCV101E, FCV101EDM, FCV101EDS, FCV141, FCV141DM, FCV141DS, FCV141E, FCV141EDM, FCV141EDS, FCV241, FCV241DM, FCV241DS, FCV241E, FCV241EDM, FCV241EDS, FCV241G, FCV241GDM, FCV241GDS, FCV401DM, FCV401EDM, FCV61, FCV61DM, FCV61DS, FCV61E, FCV61EDM, FCV61EDS		
accessories for	345350		
	GEV No.	345351	Ref. No. —
	nut thread M12x0.75 H 1.6mm WS 14 chrome-plated brass Qty 1 pcs		



1

GEV No.	345360	Ref. No.	32W1410
description	microswitch with plunger mounting distance 25.4mm thread M12x1 thread L 15mm 250V 10A 1CO connection screw stroke 5mm ambient temperature max. 125°C type Highly D5000 actuating force: 200g		
For models:	65NN, SP65NN		



1

GEV No.	345679	Ref. No.	32W0960
description	microswitch with plunger mounting distance 25mm thread M12x1 thread L 9mm 250V 5A 1CO connection male faston 6.3mm stroke 5mm ambient temperature max. 125°C type MF12 actuating force: 680g		
For models:	31RE, 71AR		

with push button

switches with snap-fit



1

GEV No.	347027	Ref. No.	32W3770
description	microswitch with push button 250V 1A 1CO connection male faston 2.8mm L 26x12mm ambient temperature max. 85°C type XKA-304B1AAJ11 actuating force: 50g		
For models:	CX120, CX120B, CX120NN, CX130, CX130B, CX130NN, CX140, CX140B, CX140BN, CX140BR, CX140CP, CX140NN, CX140PV, CX140R, CX150, CX150B, CX150BN, CX150BR, CX150CP, CX150NN, CX150PV, CX150R, CX55, CX55B, CX60, CX60B, CX65, CX652, CX65B, CX65BR, CX65NB, CX65NCP, CX65NN, CX65PV, CX65R, CX70, CX702, CX70B, CX70BR, CX70NB, CX70NN, CX70PV, CX70R, FG2B, FSD1B, FSD1N, FSD2B, FSD2N, FSD2N2, FSDR2B...(Other models you can see in the webshop)		



1

GEV No.	348008	Ref. No.	3096020
description	microswitch with push button 250V 2.5A 1NO/1NC connection male faston 2.8mm/6.3mm L 27mm L1 22mm ambient temperature max. 104°C actuating force: 180g		

roller actuated

roller 0°





1

GEV No.	345639	Ref. No.	32W1040
description	microswitch with roller plunger 230V 16A 1CO connection solder/screw connection L1 49mm ambient temperature max. 125°C thread L 14mm thread M10 mounting distance 25mm actuating force: 300g type MS15-1		





roller 90°			
			
1			
GEV No.	347096	Ref. No.	32W4130
description	microswitch with roller plunger 250V 20A 1CO connection screw L1 49mm ambient temperature max. 125°C thread L 14.5mm thread M12x1 mounting distance 25mm actuating force: 370g type Z15G1318		
For models:	KD100, KD100A, KD100PSD, KD130, KD130A, KD130E, KD130EAT, KN1100, KN1100SD, KN11PSDD, KN800, KN800PSD		

non-standard			
			
1			
GEV No.	346183	Ref. No.	33Q5620 6300496
description	microswitch connection male faston		
For models:	FC101, FC101E, FC241, FC241E, FC241G, FC61, FC61E, FCV101, FCV101DM, FCV101DS, FCV101E, FCV101EDM, FCV101EDS, FCV141, FCV141DM, FCV141DM-CSA, FCV141DS, FCV141E, FCV141EDM, FCV141EDS, FCV241, FCV241DM, FCV241DS, FCV241E, FCV241EDM, FCV241EDS, FCV241G, FCV241GDM, FCV241GDS, FCV401DM, FCV401EDM, FCV61, FCV61DM, FCV61DS, FCV61E, FCV61EDM, FCV61EDS		

accessories			
			
1			
GEV No.	691143	Ref. No.	36D8360
description	bolt for microswitch		
For models:	FC101, FC101E, FC241, FC61, FC61E, FCV101, FCV101-CSA, FCV101DM, FCV101DM-CSA, FCV101DS, FCV101DS-CSA, FCV101E, FCV101EDM, FCV101EDM-CSA, FCV101EDS, FCV101EDS-CSA, FCV101E-UL, FCV141, FCV141-CSA, FCV141DM, FCV141DM-CSA, FCV141DS, FCV141DS-CSA, FCV141E, FCV141EDM, FCV141EDS, FCV241, FCV241DM, FCV241DS, FCV401DM, FCV401DM-CSA, FCV401EDM, FCV401EDM-CSA, FCV61, FCV61-CSA, FCV61DM, FCV61DM-CSA, FCV61DS, FCV61DS-CSA, FCV61E, FCV61EDM, FCV61EDM-CSA, FCV61EDS, FCV61EDS-CSA, FCV61E-UL, FCV72EDM-UL, FCV72EDS-UL, FCV72E-UL		

			
1			
GEV No.	691140	Ref. No.	33Q5610
description	bush for microswitch thread M16x1.5		
For models:	FC101, FC101E, FC241, FC241E, FC241G, FC61, FC61E, FCV101, FCV101-CSA, FCV101DM, FCV101DM-CSA, FCV101DS, FCV101DS-CSA, FCV101E, FCV101EDM, FCV101EDM-CSA, FCV101EDS, FCV101EDS-CSA, FCV101E-UL, FCV141, FCV141-CSA, FCV141DM, FCV141DM-CSA, FCV141DS, FCV141DS-CSA, FCV141E, FCV141EDM, FCV141EDS, FCV241, FCV241DM, FCV241DS, FCV241E, FCV241EDM, FCV241EDM-CSA, FCV241EDS, FCV241EDS-CSA, FCV241E-UL, FCV241G, FCV241GDM, FCV241GDM-CSA, FCV241GDS, FCV241GDS-CSA, FCV401DM, FCV401DM-CSA, FCV401EDM, FCV401EDM-CSA, FCV61, FCV61-CSA, FCV61DM...(Other models you can see in the webshop)		

			
1			
GEV No.	691139	Ref. No.	33Q4120 33Q5610
description	connecting piece for microswitch		
For models:	FC101, FC101E, FC241E, FC241G, FC61, FC61E, FCV101, FCV101-CSA, FCV101DM, FCV101DM-CSA, FCV101DS, FCV101DS-CSA, FCV101E, FCV101EDM, FCV101EDM-CSA, FCV101EDS, FCV101EDS-CSA, FCV101E-UL, FCV141, FCV141-CSA, FCV141DM, FCV141DS, FCV141DS-CSA, FCV141E, FCV141EDM, FCV141EDS, FCV241E, FCV241EDM, FCV241EDM-CSA, FCV241EDS, FCV241EDS-CSA, FCV241E-UL, FCV241G, FCV241GDM, FCV241GDM-CSA, FCV241GDS, FCV241GDS-CSA, FCV401DM, FCV401DM-CSA, FCV401EDM, FCV401EDM-CSA, FCV61, FCV61-CSA, FCV61DM, FCV61DM-CSA, FCV61DS, FCV61DS-CSA, FCV61E, FCV61EDM...(Other models you can see in the webshop)		

			
1			
GEV No.	516249	Ref. No.	36G1720
description	hexagonal screw thread M5 WS 8		
For models:	LT10R, LT20F, LT25F		

			
1			
GEV No.	691138	Ref. No.	35Q2360
description	housing for microswitch		
For models:	FC101, FC101E, FC241, FC241E, FC241G, FC61, FC61E, FCV101, FCV101-CSA, FCV101DM, FCV101DM-CSA, FCV101DS, FCV101DS-CSA, FCV101E, FCV101EDM, FCV101EDM-CSA, FCV101EDS, FCV101EDS-CSA, FCV101E-UL, FCV141, FCV141-CSA, FCV141DM, FCV141DM-CSA, FCV141DS, FCV141DS-CSA, FCV141E, FCV141EDM, FCV141EDS, FCV241, FCV241DM, FCV241DS, FCV241E, FCV241EDM, FCV241EDM-CSA, FCV241EDS, FCV241EDS-CSA, FCV241E-UL, FCV241G, FCV241GDM, FCV241GDM-CSA, FCV241GDS, FCV241GDS-CSA, FCV401DM, FCV401DM-CSA, FCV401EDM, FCV401EDM-CSA, FCV61, FCV61-CSA, FCV61DM, FCV61DM-CSA...(Other models you can see in the webshop)		

			
1			
GEV No.	691142	Ref. No.	36G6040 36G6041
description	pin for microswitch		
For models:	FC101, FC101E, FC241, FC241E, FC241G, FC61, FC61E, FCV101, FCV101-CSA, FCV101DM, FCV101DM-CSA, FCV101DS, FCV101DS-CSA, FCV101E, FCV101EDM, FCV101EDM-CSA, FCV101EDS, FCV101EDS-CSA, FCV101E-UL, FCV141, FCV141-CSA, FCV141DM, FCV141DM-CSA, FCV141DS, FCV141DS-CSA, FCV141E, FCV141EDM, FCV141EDS, FCV241, FCV241DM, FCV241DS, FCV241E, FCV241EDM, FCV241EDM-CSA, FCV241EDS, FCV241EDS-CSA, FCV241E-UL, FCV241G, FCV241GDM, FCV241GDM-CSA, FCV241GDS, FCV241GDS-CSA, FCV401DM, FCV401DM-CSA, FCV401EDM, FCV401EDM-CSA, FCV61, FCV61-CSA, FCV61DM...(Other models you can see in the webshop)		



			
GEV No.	691141	Ref. No.	36G7140
description	spring for microswitch		
For models:	1A1BR1E, 1A1BR1G, 1A1BR1GA, 1A1BR2E, 1A1BR2EA, 1A1BR2G, 1A1BR2GA, 1D1BR1E, 1D1BR1G, 1D1BR1GA, 1D1BR2E, 1D1BR2EA, 1D1BR2G, 1D1BR2GA, 2A1BR1G, 2A1BR1GA, 2A1BR2G, 2A1BR2GA, 2D1BR1G, 2D1BR1GA, 2D1BR2G, 2D1BR2GA, FC101, FC101E, FC241, FC241E, FC241G, FC61, FC61E, FCV101, FCV101-CSA, FCV101DM, FCV101DM-CSA, FCV101DS, FCV101DS-CSA, FCV101E, FCV101EDM, FCV101EDM-UL, FCV101EDS, FCV101EDS-UL, FCV101E-UL, FCV141, FCV141-CSA, FCV141DM, FCV141DM-CSA, FCV141DS, FCV141DS-CSA, FCV141E, FCV141EDM, FCV141EDS...(Other models you can see in the webshop)		

position switches

PIZZATO

FR series

			
GEV No.	345337	Ref. No.	32W3251
description	position switch plastic 1NO/1NC 400V 3A L 83mm W 31mm H 31mm protection IP67 actuating force: 900g screw connection PG11 mounting distance 20mm		
For models:	091FR1E, 091FR1EA, 091FR1ED, 091FR1EX, 0A1FR1E, 0A1FR1ED, 0D1FR1E, 0D1FR1ED, 191BR1GA, 191BR2EA, 191BR2GA, 191FR2E, 191FR2ED, 1A1BR1E, 1A1BR1G, 1A1BR1GA, 1A1BR2E, 1A1BR2EA, 1A1BR2G, 1A1BR2GA, 1A1FR2E, 1A1FR2ED, 1D1BR1E, 1D1BR1G, 1D1BR1GA, 1D1BR2E, 1D1BR2EA, 1D1BR2G, 1D1BR2GA, 1D1FR2ED, 1G1BR1E, 291BR1GA, 291BR2EA, 291BR2GA, 2A1BR1E, 2A1BR1G, 2A1BR1GA, 2A1BR2E, 2A1BR2EA, 2A1BR2G, 2A1BR2GA, 2D1BR1E, 2D1BR1G, 2D1BR1GA, 2D1BR2E, 2D1BR2EA, 2D1BR2G, 2D1BR2GA, 71ARE, 71RA...(Other models you can see in the webshop)		

system switches (ROLD)

			
GEV No.	345130	Ref. No.	3040850
description	momentary switch unit 1NO 250V 16A connection male faston 6.3mm		

			
GEV No.	347193	Ref. No.	3040850
description	momentary switch unit 1NO 250V 16A connection male faston 6.3mm		

			
GEV No.	346817	Ref. No.	32W1630
description	push button ø 23mm white		
For models:	LT25F		

			
GEV No.	346221	Ref. No.	32W4260
description	push button size 23x23mm green ON-OFF with lens		
For models:	KD100, KD100A, KD100PSD, KD130, KD130A, KD37, KD37PS, KD37-VERS.112009, KD40, KD40LUX, KD40PS, KD40-VERS.112009, KD60, KD60M, KD60MA, KD60MPS, KD60MPSA, KD60PS, KD60PSD, KD85, KD85A, KD85PS, KD85PSA, KN1100, KN1100SD, KN11PSDD, KN35, KN37, KN37PS, KN40, KN40PS, KN40PSD, KN50, KN50M, KN50MPS, KN50PS, KN50PSD, KN50PSDD, KN80, KN800, KN800PSD, KN80PS, N100D, N100S, N100VD, N100VS, N38D, N38S, N38VD, N38VS...(Other models you can see in the webshop)		

			
GEV No.	346222	Ref. No.	3063320
description	push button size 23x23mm green START		
For models:	KD37, KD37PS, KD37-VERS.112009, KD40, KD40LUX, KD40PS, KD40-VERS.112009, KD60, KD60M, KD60MA, KD60MPS, KD60MPSA, KD60PS, KD60PSD, KD85, KD85A, KN35, KN37, KN37PS, KN40, KN40PS, KN40PSD, KN50, KN50M, KN50MPS, KN50PS, KN50PSD, KN50PSDD, KN80, KN80PS		

			
GEV No.	346251	Ref. No.	33Q6440
description	rotary disc orange/green disc ø 20.6mm		
For models:	KD100, KD100A, KD100PSD, KD130, KD130A, KD37, KD37PS, KD37-VERS.112009, KD40, KD40LUX, KD40PS, KD40-VERS.112009, KD60, KD60M, KD60MA, KD60MPS, KD60MPSA, KD60PS, KD60PSD, KD85, KD85A, KD85PS, KD85PSA, KN1100, KN1100SD, KN11PSDD, KN35, KN37, KN37PS, KN40, KN40PS, KN40PSD, KN50, KN50M, KN50MPS, KN50PS, KN50PSD, KN50PSDD, KN80, KN800, KN800PSD, KN80PS, N100D, N100S, N100VD, N100VS, N38D, N38S, N38VD, N38VS...(Other models you can see in the webshop)		

1

GEV No.	345720	Ref. No.	32W4150
description	switch 2NO 250V 16A connection male faston 6.3mm		
For models:	KD100, KD100A, KD100PSD, KD130, KD130A, KD37, KD37PS, KD37-VERS.112009, KD40, KD40LUX, KD40PS, KD40-VERS.112009, KD60, KD60M, KD60MA, KD60MPS, KD60MP5A, KD60PS, KD60PSD, KD85, KD85A, KD85PS, KD85PSA, KN1100, KN1100SD, KN11PSDD, KN35, KN37, KN37PS, KN40, KN40PS, KN40PSD, KN50, KN50M, KN50MPS, KN50PS, KN50PSD, KN50PSDD, KN80, KN800, KN800PSD, KN80PS, N100D, N100S, N100VD, N100VS, N38D, N38S, N38VD, N38VS...(Other models you can see in the webshop)		



1

GEV No.	300088	Ref. No.	32W3830
description	cam switch 2 operating positions 4NO sequence 0-1 16A shaft ø 6x4.6mm shaft L 23mm connection male faston 6.3mm ceramic		
For models:	0M0BR1E, 0M0FR1E, 0M0FT1E, 0M0FT2E, 0M0FT4E, 0M0FT5E, 0M0GR1E, 0M0GR2E, 1M0FR2E, 1M0FT1E, 1M0FT2E, 1M0FT3E, 1M0FT4E, 1M0FT5E, 1M0FT6E, 2M0FT1E, 2M0FT2E, 2M0FT3E, 2M0FT4E, 2M0FT5E, 2M0FT6E		

float switches



1

GEV No.	403292	Ref. No.	6300787
description	float switch 1NO ø 12mm mounting ø 8mm 24V 0.2A plug cable length 880mm 1-pole		
For models:	FX101E3, FX101E3C, FX101E3C-VERS.022014, FX101E3R, FX101E3R-VERS.022014, FX101E3-VERS.022014, FX101G3, FX101G3C, FX101G3C-VERS.022014, FX101G3R, FX101G3R-VERS.022014, FX101G3-VERS.022014, FX10E3CR, FX10E3CR-VERS.022014, FX10G3CR, FX10G3CR-VERS.022014, FX122E3, FX122E3C, FX122E3T, FX122E3T-VERS.022014, FX122G3, FX122G3C, FX122G3T, FX122G3T-VERS.022014, FX12E3CT, FX12E3CT-VERS.022014, FX12G3CT, FX12G3CT-VERS.022014, FX201E3, FX201E3P, FX201E3P-VERS.022014, FX201E3-VERS.022014, FX201G3P, FX201G3-VERS.022014, FX202E3, FX202E3-230V-3-50Hz-60Hz, FX202E3-230V-3-50Hz-60Hz-VERS.022014, FX202E3-VERS.022014, FX202G3, FX202G3-VERS.022014, FX61E3, FX61E3C, FX61E3CR, FX61E3CR-VERS.022014, FX61E3C-VERS.022014, FX61E3R, FX61E3R-VERS.022014, FX61E3-VERS.022014, FX61G3, FX61G3C...(Other models you can see in the webshop)		



1

GEV No.	300020	Ref. No.	32W0490 32W3610
description	cam switch 4 operating positions 2NO sequence 0-1-0-1 16A shaft ø 6x4.6mm shaft L 23mm connection screw ceramic		
For models:	04WFR3ED, 06WFR3GD, 08WFR4ED, 091FR1ED, 091FR1GD, 091FR3ED, 091FR3GD, 0A1FR1ED, 0A1FR1GD, 0A1FR1GD-VERS.2004, 0B1FR1GD, 0D1FR1ED, 0D1FR1GD, 0D1FR1GD-VERS.2004, 0G0FR3ED, 0G1FR3GD, 10WFR4GD, 191FR2ED, 191FR2GD, 191FR4ED, 191FR4GD, 1A1FR2ED, 1A1FR2GD, 1A1FR2GD-VERS.2004, 1A1PI2G, 1A1PI2GA, 1D1FR2ED, 1D1FR2GD, 1D1FR2GD-VERS.2004, 1D1PI2G, 1D1PI2GA, 1G1FR4GD, 291PI3G, 2A1PI3G, 2D1PI3G, FC101, FC101E, FC241, FC241E, FC241G, FC61, FC61E, L100, L80		
accessories for	300020		
		GEV No.	110135 Ref. No. —
			rosette knob up to ø 52mm
		GEV No.	110231 Ref. No. —
			knob switch 0-1-0-1 t.max.°C ø 50mm shaft ø 6x4.6mm shaft flat upper black

cam switches

on/off



1

GEV No.	301115	Ref. No.	3168540
description	cam switch 2 operating positions 2NO sequence 0-1 16A shaft ø 6x4.6mm shaft L 23mm connection male faston 6.3mm		
For models:	091FR1I, 091FR1I-VERS.032012, 191FR2I, 191FR2I-VERS.032012, 6043840, 6043970		

5-position



1

GEV No.	300147	Ref. No.	32W0510
description	cam switch 5 operating positions 1NO/2CO sequence 0-1-2-3-4 16A shaft ø 6x4.6mm shaft L 23mm connection screw 5-position		

1

GEV No.	300149	Ref. No.	32W1050
description	cam switch 5 operating positions 2NO/2CO sequence 0-1-2-3-4 32A shaft ø 6x4.6mm shaft L 23mm connection screw 5-position ceramic		
For models:	04WPE4V, 070E, 071E, 08WPE4V, 090E, 090PE4, 091E, 0A0PE4, OD0PE4, 190PE4, 191PE4E, 1A0PE4, 1A1PE4E, 1A1PEFTE, 1D0PE4, 1D1PE4E, 30CPSE, 70CPE, 71E, 71PIE15, 71PIE15A, 90CPE, 91PIE15, 91PIE15A		



1

GEV No.	300105	Ref. No.	32W3260
description	cam switch 5 operating positions 3NO/1CO sequence 0-1-2-3-4 32A shaft ø 6x4.6mm shaft L 23mm connection screw 5-position ceramic		
For models:	0A1CP1E, 0D1CP1E, 0G1CP1E, 0G1CP1E-VERS.2004, 191PI2E, 191PI2EA, 1A1PI2E, 1A1PI2EA, 1D1PI2E, 1D1PI2EA, 1G1PI1E, 31PIE6		



1

GEV No.	300133	Ref. No.	32w0520
description	cam switch 5-position sequence 0-1-2-3-4 shaft ø 6x4.6mm connection screw clamp 3-pole		



7-position



1

GEV No.	300025	Ref. No.	32W0760 32W1840
description	cam switch 7 operating positions 1NO/2CO sequence 0-1-2-3-4-5-6 16A shaft ø 6x4.6mm shaft L 23mm connection screw 7-position ceramic		
For models:	030E, 031E, 0G0PE1, 0G0PE2, 0G1PE2, 1G0PE1, 1G0PE2, 1G1PE1E, 1G1PE1EV, 1G1PE2, 1G1PE2E, 1G1PE2EV, 2G0PE1, 2G0PE2, 2G1PE1E, 2G1PE1EV, 2G1PE2E, 2G1PE2EV, 31TCE, 32TCE		
accessories for	300025		
	GEV No.	112172	Ref. No. —
	knob universal ø 70mm black without adaptor/dial plate		

accessories for 300025

	GEV No.	112213	Ref. No.	—
	knob dial plate silver switch 7-position t.max.°C ED ø 63mm ID ø 45.5mm			
	GEV No.	112311	Ref. No.	—
	knob adapter shaft ø 6x4.6mm L 0mm with spring			



1

GEV No.	300106	Ref. No.	32W2920
description	cam switch 7 operating positions 1NO/2CO sequence 0-1-2-3-4-5-6 32A shaft ø 6x4.6mm shaft L 23mm connection screw 7-position shaft flat upper		
For models:	60SME		

3 operating positions

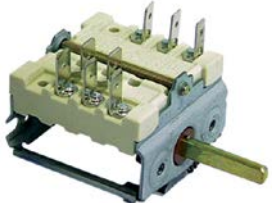

1

GEV No.	345171	Ref. No.	3041660
description	cam switch 3 operating positions 3NO sequence 0-1-2 16A shaft ø 6x4.6mm shaft L 26mm connection male faston 6.3mm ceramic		
For models:	FC1011E, FC1011G, FC1221E, FC1221G, FC611E, FC611G		
accessories for	345171		
	GEV No.	112340	Ref. No. —
	knob switch zero mark t.max.°C temperature range°C ø 40mm shaft ø 6x4.6mm shaft flat left black		

4 operating positions



1

GEV No.	345996	Ref. No.	32W1440
description	cam switch		
For models:	191FAAE, 191FAE, 191PE4E, 1A1PE4E, 1A1PEFTE, 1A1FBE, 1D1PE4E, 1D1FBE, 71E, 71GE, 71GEGG, FS30E		

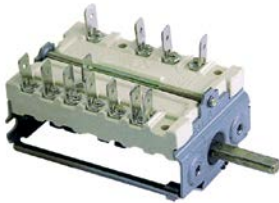
1

GEV No.	300010	Ref. No.	32Z0540
description	cam switch 4 operating positions 2NO/2CO sequence 0-1-2-3 16A shaft ø 6x4.6mm shaft L 23mm connection male faston 6.3mm ceramic		

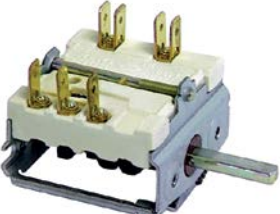

1

GEV No.	300122	Ref. No.	32W0980
description	operation switch sequence 0-1-2-3 shaft ø 6x4.6mm connection male faston 2-pole		
For models:	F60P, F60PR, F60T, F80P, F80PR, L100, L40, L40S, L45, L60, L80		



1

GEV No.	301144	Ref. No.	3162280
description	cam switch 4 operating positions 6NO sequence 0-1-2-3 16A shaft ø 6x4.6mm shaft L 23mm connection male faston 6.3mm plastic		
For models:	04WCP1EM, 06WCP1GM, 091CP1E, 091CP1G, 0G1CP1EC, 0G1CP1E-VERS.2004, 0G1CP1G-VERS.2004, 191CP1G, 191CP2G, 1G1CP1G-VERS.2004, 1G1CP2G-VERS.2004, 6040090, 6040310, 6043850, 6043980		

rotary switches

BRETER

rotary switches



1

GEV No.	346917	Ref. No.	32W2420
description	rotary switch 2 0-1 sets of contacts 4 400V 20A shaft ø 5x5mm shaft square with knob connection screw		

operation switches

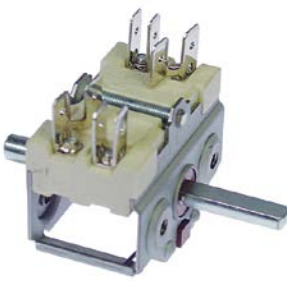

1

GEV No.	301153	Ref. No.	32W2550
description	cam switch 2 operating positions 2NO 16A sequence 0-1 shaft ø 6x4.6mm shaft L 23mm connection male faston 6.3mm ceramic		
For models:	030FE1, 091FE28, 30F1, 30FES2, 30FS2, 70F1, 70FE, 70FE1, 70FES2, 71F2, 71FE2, 91F210		

LOVATO



1

GEV No.	346178	Ref. No.	32W1200
description	rotary switch 2 0-1 sets of contacts 2 type GN209479U 690V 20A shaft ø 6x6mm shaft L 23.5mm shaft square connection screw		

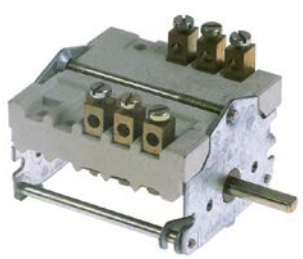

1

GEV No.	300215	Ref. No.	32W0080
description	cam switch 2 operating positions sequence 0-1 3-pole ambient temperature max. 318°C		



magnetic switches

37x16mm

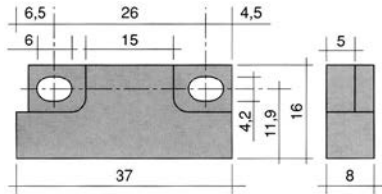

GEV No.	345600	Ref. No.	32V5740 32W2160
description	magnetic switch L 37mm W 16mm 1NO 250V 0.2A P max. 50W connection cable cable length 960mm		
For models:	BX101E, BX101E-VERS.122013, BX101G, BX101G-VERS.122013, BX122E, BX122E-VERS.122013, BX122G, BX122G-VERS.122013, BX61E, BX61E-VERS.122013, BX61G, BX61G-VERS.122013, BX82E, BX82E-VERS.122013, BX82G, BX82G-VERS.122013, FM1011E1, FM1011E1-VERS.2006, FM1011E2, FM1011E2-VERS.2006, FM1011E3, FM1011E3-VERS.2006, FM1011G1, FM1011G1-VERS.2006, FM1011G2, FM1011G2-VERS.2006, FM1011G3, FM1011G3-VERS.2006, FM1221E1, FM1221E1-VERS.2006, FM1221E2, FM1221E2-VERS.2006, FM1221E3, FM1221E3-VERS.2006, FM1221G1, FM1221G1-VERS.2006, FM1221G2, FM1221G2-VERS.2006, FM1221G3, FM1221G3-VERS.2006, FM2011E2-VERS.2006, FM2011E3-VERS.2006, FM2011G2-VERS.2006, FM2011G3-VERS.2006, FM2021E1, FM2021E2, FM2021E2-VERS.2006, FM2021E3, FM2021E3-VERS.2006, FM2021G1...(Other models you can see in the webshop)		
accessories for	345600		
	GEV No.	519049	Ref. No. 3023650 32W0870 32W1680
	magnet ømm L 63mm H 10.7mm W 18.8mm hole distance 52mm M2 hole ø2mm		

51x16mm



GEV No.	348168	Ref. No.	3022950
description	magnetic switch L 51mm W 16mm 1NO 240V 2A P max. 12W cable length 350mm		
For models:	DK112, DK351M, DK352, DK552, DP10, DP25		

65x20mm

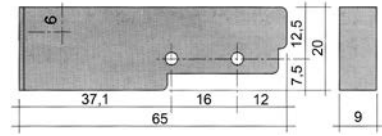



GEV No.	345116	Ref. No.	32W1210
description	magnetic switch L 65mm W 20mm 1NO 250V 0.4A P max. 100W connection cable cable length 3000mm		
accessories for	345116		
	GEV No.	345399	Ref. No. —
	magnet ø 3.3mm L 40mm H 8mm W 13mm hole distance 30mm M3		

M10x0.75

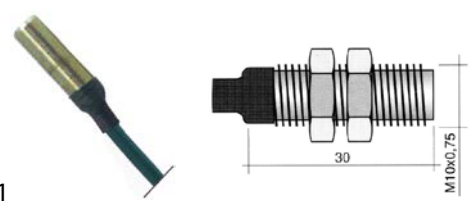

GEV No.	348024	Ref. No.	32W1890 32W3460
description	magnetic switch 1NO 250V 1A P max. 10W connection Faston 6.3mm cable length 2000mm		





GEV No.	345632	Ref. No.	32W3200 32W3240 32Z8650
description	magnetic switch thread M10x0.75 1NO 250V 0.5A P max. 50W connection cable cable length 2000mm type 102		
For models:	C165D, C165S, C165VD, C165VS, C207D, C207D-VERS.2006, C207S, C207S-VERS.2006, C207VD, C207VD-VERS.2006, C207VS, C207VS-VERS.2006, C304AD, C304AD-VERS.2006, C304AS, C304AS-VERS.2006, C304AVD, C304AVD-VERS.2006, C304AVS, C304AVS-VERS.2006, C304D, C304D-VERS.2006, C304S, C304S-VERS.2006, C304VD, C304VD-VERS.2006, C304VS, C304VS-VERS.2006, C92D-VERS.2006, C92S-VERS.2006, C92VD-VERS.2006, C92VS-VERS.2006, CS243D, CS243D-VERS.2006, CS243S, CS243S-VERS.2006, CS243VD, CS243VD-VERS.2006, CS243VS, CS243VS-VERS.2006, CS370AD, CS370AD-VERS.2006, CS370AS, CS370AS-VERS.2006, CS370AVD, CS370AVD-VERS.2006, CS370AVS, CS370AVS-VERS.2006, CS370D, CS370D-VERS.2006...(Other models you can see in the webshop)		
accessories for	345632		
	GEV No.	100779	Ref. No. —
	nut thread M10x0.75 H 3mm WS 14 SS Qty 2 pcs		





accessories

magnets

			
1			
GEV No.	691178	Ref. No.	3008810 3112370
description	magnet ø 22mm Lmm H 7mm Wmm ED ø 22mm M5		
For models:	FC1011E, FC1011G, FC1221E, FC1221G, FC611E, FC611G, FM1011E1, FM1011E1-VERS.2006, FM1011E2, FM1011E2-VERS.2006, FM1011E3, FM1011E3-VERS.2006, FM1011G1, FM1011G1-VERS.2006, FM1011G2, FM1011G2-VERS.2006, FM1011G3, FM1011G3-VERS.2006, FM1221E1, FM1221E1-VERS.2006, FM1221E2, FM1221E2-VERS.2006, FM1221E3, FM1221E3-VERS.2006, FM1221G1, FM1221G1-VERS.2006, FM1221G2, FM1221G2-VERS.2006, FM1221G3, FM1221G3-VERS.2006, FM2011E2-VERS.2006, FM2011E3-VERS.2006, FM2011G2-VERS.2006, FM2011G3-VERS.2006, FM2021E1, FM2021E2, FM2021E2-VERS.2006, FM2021E3, FM2021E3-VERS.2006, FM2021G1, FM2021G2, FM2021G2-VERS.2006, FM2021G3, FM2021G3-VERS.2006, FM611E1, FM611E1-VERS.2006, FM611E2, FM611E2-VERS.2006, FM611E3, FM611E3-VERS.2006... (Other models you can see in the webshop)		

			
1			
GEV No.	345336	Ref. No.	3210010
description	magnet ø 4.8mm L 63mm H 11mm W 18.8mm hole distance 51mm M4		
For models:	LP151, LP202, LP202HC, LP302, LP302HC, LP402, LP402HC, LP402V, LPG300		

			
1			
GEV No.	345398	Ref. No.	32V0080
description	magnet ømm L 36mm H 8mm W 13mm hole distance 20mm M3 hole ø 3mm		

			
1			
GEV No.	519049	Ref. No.	3023650 32W0870 32W1680
description	magnet ømm L 63mm H 10.7mm W 18.8mm hole distance 52mm M2 hole ø 2mm		
For models:	C165D, C165S, C165VD, C165VS, C207D, C207D-VERS.2006, C207S, C207S-VERS.2006, C207VD, C207VD-VERS.2006, C207VS, C207VS-VERS.2006, C304AD, C304AD-VERS.2006, C304AS, C304AS-VERS.2006, C304AVD, C304AVD-VERS.2006, C304AVS, C304AVS-VERS.2006, C304D, C304D-VERS.2006, C304S, C304S-VERS.2006, C304VD, C304VD-VERS.2006, C304VS, C304VS-VERS.2006, C92D-VERS.2006, C92S-VERS.2006, C92VD-VERS.2006, C92VS-VERS.2006, CS243D, CS243D-VERS.2006, CS243S, CS243S-VERS.2006, CS243VD, CS243VD-VERS.2006, CS243VS, CS243VS-VERS.2006, CS370AD, CS370AD-VERS.2006, CS370AS, CS370AS-VERS.2006, CS370AVD, CS370AVD-VERS.2006, CS370AVS, CS370AVS-VERS.2006, CS370D, CS370D-VERS.2006... (Other models you can see in the webshop)		
accessories for	519049		
	GEV No.	560095	Ref. No. —
	 sheet metal screws ø 2.9mm L 9.5mm SS Qty 20 pcs DIN 7981/ISO 7049 head ø 5.6mm oval head		

control equipment

BRETER

switches (complete)

			
1			
GEV No.	345718	Ref. No.	32W1640
description	momentary push switch black 1NC/1NO		
For models:	71AR, 71ARE, 71RA, 91AR, 91ARE, 91RA		

			
1			
GEV No.	345717	Ref. No.	32W1650
description	momentary push switch green 1NC/1NO		
For models:	71AR, 71ARE, 71RA, 91AR, 91ARE, 91RA		



ELFIN

switches (complete)



1

GEV No.	347947	Ref. No.	32Z8470
description	rotary selector mounting measurements \varnothing 22mm 2NO/2NC sequence 0-1-2 black		
For models:	C207D, C207S, C207VD, C207VS, C304AD, C304AS, C304AVD, C304AVS, C304D, C304S, C304VD, C304VS, CS243D, CS243S, CS243VD, CS243VS, CS370AD, CS370AS, CS370AVD, CS370AVS, CS370D, CS370S, CS370VD, CS370VS, CS466AD, CS466AS, CS466AVD, CS466AVS, CS466D, CS466S, CS466VD, CS466VS, N303D, N303S, N303VD, N303VS, N354D, N354S, N354VD, N354VS, N506D, N506S, N506VD, N506VS, N607D, N607S, N607VD, N607VS, N760D, N760S...(Other models you can see in the webshop)		

LOVATO



1

GEV No.	301171	Ref. No.	32W3330
description	contact block LAVATO 8 LM2T-C10 1NC max 690V 10A		
For models:	10CP1EA, 10CP1GA, 10CP1IA, 12CP1EA, 12CP1GA, 12CP1IA, 18CP2EA, 18CP2GA, 18CP2IA, 191BR1GA, 191BR2EA, 191BR2GA, 1A1BR1GA, 1A1BR2EA, 1A1BR2GA, 1D1BR1GA, 1D1BR2EA, 1D1BR2GA, 2091SCP, 291BR1GA, 291BR2EA, 291BR2GA, 2A1BR1GA, 2A1BR2EA, 2A1BR2GA, 2D1BR1GA, 2D1BR2EA, 2D1BR2GA, BRE21HD, BRE31HD, PIER06HD, PIER10HD, PIER15HD		



1

GEV No.	301170	Ref. No.	32W3320
description	contact block LAVATO 8 LM2T-C10 1NO max 690V 10A		
For models:	10CP1EA, 10CP1GA, 10CP1IA, 12CP1EA, 12CP1GA, 12CP1IA, 18CP2EA, 18CP2GA, 18CP2IA, 191BR1GA, 191BR2EA, 191BR2GA, 1A1BR1GA, 1A1BR2EA, 1A1BR2GA, 1D1BR1GA, 1D1BR2EA, 1D1BR2GA, 291BR1GA, 291BR2EA, 291BR2GA, 2A1BR1GA, 2A1BR2EA, 2A1BR2GA, 2D1BR1GA, 2D1BR2EA, 2D1BR2GA, BRE21HD, BRE31HD, PIER06HD, PIER10HD, PIER15HD		

plastic series

switch block brackets



1

GEV No.	301169	Ref. No.	32W3310
description	contact block holder		
For models:	10CP1EA, 10CP1GA, 10CP1IA, 12CP1EA, 12CP1GA, 12CP1IA, 18CP2EA, 18CP2GA, 18CP2IA, 191BR1GA, 191BR2EA, 191BR2GA, 1A1BR1GA, 1A1BR2EA, 1A1BR2GA, 1D1BR1GA, 1D1BR2EA, 1D1BR2GA, 291BR1GA, 291BR2EA, 291BR2GA, 2A1BR1GA, 2A1BR2EA, 2A1BR2GA, 2D1BR1GA, 2D1BR2EA, 2D1BR2GA, BRE21HD, BRE31HD, PIER06HD, PIER10HD, PIER15HD		

metal series

push buttons



1

GEV No.	301197	Ref. No.	37Q4030 37Q7600
description	protective cover transparent ED \varnothing 34mm H 16mm for push-button		
For models:	10CP1EA, 10CP1GA, 10CP1IA, 12CP1EA, 12CP1GA, 12CP1IA, 18CP2EA, 18CP2GA, 18CP2IA, 191BR1GA, 191BR2EA, 191BR2GA, 1A1BR1GA, 1A1BR2EA, 1A1BR2GA, 1D1BR1GA, 1D1BR2EA, 1D1BR2GA, 291BR1GA, 291BR2EA, 291BR2GA, 2A1BR1GA, 2A1BR2EA, 2A1BR2GA, 2D1BR1GA, 2D1BR2EA, 2D1BR2GA, 71AR, 71ARE, 71RA, 91AR, 91ARE, 91RA, BRE21HD, BRE31HD, PIER06HD, PIER10HD, PIER15HD		



1

GEV No.	301196	Ref. No.	32W3300
description	push button mounting measurements \varnothing 22mm black arrow		
For models:	10CP1EA, 10CP1GA, 10CP1IA, 12CP1EA, 12CP1GA, 12CP1IA, 18CP2EA, 18CP2GA, 18CP2IA, 191BR1GA, 191BR2EA, 191BR2GA, 1A1BR1GA, 1A1BR2EA, 1A1BR2GA, 1D1BR1GA, 1D1BR2EA, 1D1BR2GA, 291BR1GA, 291BR2EA, 291BR2GA, 2A1BR1GA, 2A1BR2EA, 2A1BR2GA, 2D1BR1GA, 2D1BR2EA, 2D1BR2GA, BRE21HD, BRE31HD, PIER06HD, PIER10HD, PIER15HD		



TELEMECANIQUE (EFA)

XA2 series

switches (complete)



GEV No.	345592	Ref. No.	32W2150
description	rotary selector mounting measurements ø22mm 1NC/1NO complete sequence 0-1-2		
For models:	LC100, LC100-VERS.2001, LC130, LC130-VERS.2001, LC80		



GEV No.	345591	Ref. No.	32Z8670
description	rotary selector mounting measurements ø22mm complete		
For models:	C165D, C165S, C165VD, C165VS, C207D, C207S, C207VD, C207VS, C304AD, C304AS, C304AVD, C304AVS, C304D, C304S, C304VD, C304VS, CS243D, CS243S, CS243VD, CS243VS, CS370AD, CS370AS, CS370AVD, CS370AVS, CS370D, CS370S, CS370VD, CS370VS, CS466AD, CS466AS, CS466AVD, CS466AVS, CS466D, CS466S, CS466VD, CS466VS, LC100, LC100-VERS.2001, LC130, LC130-VERS.2001, LC80, LP124, LP124S-VERS.052006, LP124V, LP124V-VERS.052006, LP124VS-VERS.052006, LP124V-VERS.052006, LP84, LP84S-VERS.052006, LP84V...(Other models you can see in the webshop)		

miscellaneous



GEV No.	349001	Ref. No.	32W1700
description	indicator lamp mounting measurements ø22mm yellow		
For models:	C165D, C165S, C165VD, C165VS, C207D, C207S, C207VD, C207VS, C304AD, C304AS, C304AVD, C304AVS, C304D, C304S, C304VD, C304VS, CS243D, CS243S, CS243VD, CS243VS, CS370AD, CS370AS, CS370AVD, CS370AVS, CS370D, CS370S, CS370VD, CS370VS, CS466AD, CS466AS, CS466AVD, CS466AVS, CS466D, CS466S, CS466VD, CS466VS, LP124, LP124V, LP84, LP84V		

encoders and potentiometers



GEV No.	402322	Ref. No.	3051070
description	encoder		
For models:	BX101E, BX101G, BX122E, BX122G, BX61E, BX61G, BX82E, BX82G, FM1011E1-VERS.2006, FM1011E2-VERS.2006, FM1011E3-VERS.2006, FM1011G1-VERS.2006, FM1011G2-VERS.2006, FM1011G3-VERS.2006, FM1221E1-VERS.2006, FM1221E2-VERS.2006, FM1221E3-VERS.2006, FM1221G1-VERS.2006, FM1221G2-VERS.2006, FM1221G3-VERS.2006, FM2011E2-VERS.2006, FM2011E3-VERS.2006, FM2011G2-VERS.2006, FM2011G3-VERS.2006, FM2021E2-VERS.2006, FM2021E3-VERS.2006, FM2021G2-VERS.2006, FM2021G3-VERS.2006, FM423E1, FM423E2, FM611E1-VERS.2006, FM611E2-VERS.2006, FM611E3-VERS.2006, FM611G1-VERS.2006, FM611G2-VERS.2006, FM611G3-VERS.2006, FM721E1-VERS.2006, FM721E2-VERS.2006, FM721E3-VERS.2006, FM721G1-VERS.2006, FM721G2-VERS.2006, FM721G3-VERS.2006		



GEV No.	300272	Ref. No.	3104220 6300966
description	encoder shaft ø 6x4.6mm for combi-steamer		
For models:	BX101E-VERS.122013, BX101G-VERS.122013, BX122E-VERS.122013, BX122G-VERS.122013, BX61E-VERS.122013, BX61G-VERS.122013, BX82E-VERS.122013, BX82G-VERS.122013, FX101E1, FX101E1R, FX101E2, FX101E2C, FX101E2C-VERS.032014, FX101E2R, FX101E2R-VERS.032014, FX101E2-VERS.032014, FX101E3, FX101E3C, FX101E3C-VERS.022014, FX101E3R, FX101E3R-VERS.022014, FX101E3-VERS.022014, FX101G1, FX101G1R, FX101G2, FX101G2C, FX101G2C-VERS.032014, FX101G2R, FX101G2R-VERS.032014, FX101G2-VERS.032014, FX101G3, FX101G3C, FX101G3C-VERS.022014, FX101G3R, FX101G3R-VERS.022014, FX101G3-VERS.022014, FX10E2CR, FX10E2CR-VERS.032014, FX10E3CR, FX10E3CR-VERS.022014, FX10G2CR, FX10G2CR-VERS.032014, FX10G3CR, FX10G3CR-VERS.022014, FX122E1, FX122E2, FX122E2C, FX122E2T, FX122E2T-VERS.032014, FX122E3...(Other models you can see in the webshop)		



GEV No.	300230	Ref. No.	32V5580
description	potentiometer		
For models:	FM1011E1, FM1011E2, FM1011E3, FM1011G1, FM1011G2, FM1011G3, FM1221E1, FM1221E2, FM1221E3, FM1221G1, FM1221G2, FM1221G3, FM2021E1, FM2021E2, FM2021E3, FM2021G1, FM2021G2, FM2021G3, FM611E1, FM611E2, FM611E3, FM611G1, FM611G2, FM611G3, FM721E1, FM721E2, FM721E3, FM721G1, FM721G2, FM721G3, FS611		



lamps

indicator lights

indicator lights 2-piece (lens and indicator lamp)

indicator lamps for socket type SRZ / SDK / SDY / SFK



GEV No.	359130	Ref. No.	32W4220
description	indicator lamp 230V clear connection male faston 6.3mm ø 8mm		
For models:	KD100, KD100A, KD100PSD, KD37, KD37PS, KD37-VERS.112009, KD40, KD40LUX, KD40PS, KD40-VERS.112009, KD60, KD60M, KD60MA, KD60MPS, KD60MPSA, KD60PS, KD60PSD, KD85, KD85A, KD85PS, KD85PSA, KN1100, KN1100SD, KN11PSDD, KN35, KN37, KN37PS, KN40, KN40PS, KN40PSD, KN50, KN50M, KN50MPS, KN50PS, KN50PSD, KN50PSDD, KN80, KN800, KN800PSD, KN80PS		

indicator lights (complete)

ø 6mm



GEV No.	359004	Ref. No.	32W0101
description	indicator light ø 6mm 230V green cable length 400mm temp.-resist. 106°C		
For models:	FC101, FC1011E, FC1011G, FC101E, FC1221E, FC1221G, FC241, FC241E, FC241G, FC61, FC611E, FC611G, FC61E, FMS, FMSX		



GEV No.	359009	Ref. No.	32W0450
description	indicator light ø 6mm 230V red cable length 400mm with series resistor		
For models:	FC101, FC1011E, FC1011G, FC101E, FC1221E, FC1221G, FC241, FC241E, FC241G, FC61, FC611E, FC611G, FC61E		



GEV No.	359005	Ref. No.	32W2250
description	indicator light ø 6mm 230V yellow cable length 400mm		
For models:	FC101, FC1011E, FC1011G, FC101E, FC1221E, FC1221G, FC241, FC241E, FC241G, FC61, FC611E, FC611G, FC61E, FMS, FMSX		

ø 9mm



GEV No.	345597	Ref. No.	32W2140
description	indicator light ø 9mm 400V green connection male faston 6.3mm temp.-resist. 85°C		
For models:	LC100, LC100-VERS.2001, LC130, LC130-VERS.2001, LC80, LF50, LF50E, LF50EM, LF50EMPS, LF50E-VERS.2007		



GEV No.	345598	Ref. No.	32W2130
description	indicator light ø 9mm 400V yellow connection male faston 6.3mm temp.-resist. 85°C		
For models:	LC100, LC100-VERS.2001, LC130, LC130-VERS.2001, LC80, LF50, LF50E, LF50EM, LF50EMPS, LF50E-VERS.2007		

ø10mm

with screw socket



GEV No.	359995	Ref. No.	32W3280
description	indicator light ø 10mm 230V clear connection male faston 6.3mm		
For models:	P5		



GEV No.	359378	Ref. No.	3106710 32W1330 32W1331
description	indicator light ø 10mm 230V green connection male faston 6.3mm socket screw base		
For models:	030BME, 030E, 030EBM, 030FE, 030FE1, 030FE1B, 030FTE, 030FTER, 031BME, 031E, 031EBM, 031FTE, 031FTER, 031FTERL, 04WB-MEV, 04WCP1EM, 04WFR3ED, 04WPE4V, 04WVT3RV, 06WBR3E, 06WCP1GM, 06WFR3GD, 06WFT1EV, 06WFT2EV, 06WFT3EV, 06WFT4EV, 06WFT6EV, 06WFT7EV, 070BME, 070E, 070FTE, 070FTER, 071BME, 071E, 071FTE, 071FTER, 071FTERL, 08WCP1GM, 08WFA4E, 08WFAAE, 08WFR4ED, 08WFT1EV, 08WFT2EV, 08WFT3EV, 08WFT4EV, 08WFT6EV, 08WFT7EV, 08WGREV, 08WPE4V, 090BM1E...(Other models you can see in the webshop)		





GEV No.	359380	Ref. No.	32W1340
description	indicator light ø 10mm 230V red connection male faston 6.3mm socket screw base		





GEV No.	359379	Ref. No.	3106730 32W0790 32W0791
description	indicator light ø 10mm 230V yellow connection male faston 6.3mm socket screw base		
For models:	030BME, 030EBM, 030FE, 030FE1, 030FE1B, 030FTE, 030FTER, 031BME, 031EBM, 031FTE, 031FTER, 031FTERL, 04WBMEV, 04WCP1EM, 04WFR3ED, 06WBR3E, 06WFR3GD, 06WFT1EV, 06WFT2EV, 06WFT3EV, 06WFT4EV, 06WFT6EV, 06WFT7EV, 070BME, 070FTE, 070FTER, 071BME, 071FTE, 071FTER, 071FTERL, 08WFA4E, 08WFAAE, 08WFR4ED, 08WFT1EV, 08WFT2EV, 08WFT3EV, 08WFT4EV, 08WFT6EV, 08WFT7EV, 090BM1E, 090BME, 090FT1E, 090FT2E, 090FT4E, 090FT5E, 090FT7E, 090FTE, 090FTER, 091BME, 091CP1E...(Other models you can see in the webshop)		





			
1			
GEV No.	359527	Ref. No.	32W1562
description	indicator light ø 10mm 400V green connection male faston 6.3mm socket screw base		
For models:	031FTE04, 031FTE06, 070E, 070FTE04, 070FTE05, 071E, 071FTE04, 071FTE06, 08WFAAE, 090E, 090FTE04, 090FTE05, 091E, 091FTE04, 091FTE06, 0A0FT1E, 0A0FT2E, 0A0FT4E, 0A0FT5E, 0A0PE4, 0A1CP1E, 0D0FT1E, 0D0FT2E, 0D0FT4E, 0D0FT5E, 0D0PE4, 0D1CP1E, 0G0FT1E, 0G0FT2E, 0G0FT4E, 0G0FT5E, 0G0PE1, 0G0PE2, 0G1CP1E, 10WTPGE, 12WFAAA, 12WFAAE, 190BM2E, 191PI2E, 191PI2EA, 1A0BME, 1A0FT1E, 1A0FT2E, 1A0FT3E, 1A0FT4E, 1A0FT6E, 1A0PE4, 1A1PE4E, 1A1PEFTE, 1A1PI2E...(Other models you can see in the webshop)		

			
1			
GEV No.	360483	Ref. No.	6300652
description	indicator light ø 10mm 230V green connection male faston 6.3mm cable length 90mm with series resistor for 230V ordinary operation socket screw base		
For models:	031FTE04, 031FTE06, 070E, 070FTE04, 070FTE05, 071E, 071FTE04, 071FTE06, 090E, 090FTE04, 090FTE05, 091E, 091FTE04, 091FTE06, 0A0FT1E, 0A0FT2E, 0A0FT4E, 0A0FT5E, 0A0PE4, 0A1CP1E, 0D0FT1E, 0D0FT2E, 0D0FT4E, 0D0FT5E, 0D0PE4, 0D1CP1E, 0G0FT1E, 0G0FT2E, 0G0FT4E, 0G0FT5E, 0G0FT7E, 0G0PE1, 0G0PE2, 0G1CP1E, 0G1PE2, 10WTPGE, 12WFAAA, 190BM2E, 191PI2E, 191PI2EA, 1A0BME, 1A0FT1E, 1A0FT2E, 1A0FT3E, 1A0FT4E, 1A0FT6E, 1A0PE4, 1A1PE4E, 1A1PEFTE, 1A1PI2E...(Other models you can see in the webshop)		

			
1			
GEV No.	346881	Ref. No.	3106720 32W1341 6300653
description	indicator light ø 10mm 230V red connection male faston 6.3mm		

			
1			
GEV No.	346883	Ref. No.	3106730 32W1551 6300651
description	indicator light ø 10mm 230V yellow connection male faston 6.3mm		
For models:	031FTE04, 031FTE06, 070FTE04, 070FTE05, 071FTE04, 071FTE06, 090FTE04, 090FTE05, 091FTE04, 091FTE06, 0A0FT1E, 0A0FT2E, 0A0FT4E, 0A0FT5E, 0D0FT1E, 0D0FT2E, 0D0FT4E, 0D0FT5E, 0G0FT1E, 0G0FT2E, 0G0FT4E, 0G0FT5E, 0G0FT7E, 10WTPGE, 12WFAAA, 190BM2E, 1A0BME, 1A0FT1E, 1A0FT2E, 1A0FT3E, 1A0FT4E, 1A0FT6E, 1A1PE4E, 1A1PEFTE, 1A1FBE, 1D0BME, 1D0FT1E, 1D0FT2E, 1D0FT3E, 1D0FT4E, 1D0FT6E, 1D1PE4E, 1D1FBE, 1G0FT1E, 1G0FT2E, 1G0FT3E, 1G0FT4E, 1G0FT7E, 1G1FA0E, 1G1FA0EV...(Other models you can see in the webshop)		

			
1			
GEV No.	359889	Ref. No.	32W2080
description	indicator light ø 10mm 230V red connection cable		
For models:	AFC30MS, AFC30S, AFC35, AFT30MS, AFT30S, AFT30VMS, AFT30VS, AFT33MS, AFT33S, AFT35, AFT35VS		

with plug-in socket			
			
1			
GEV No.	359019	Ref. No.	32W1560 32W1561
description	indicator light ø 10mm green 400V connection male faston 6.3mm Qty 1 pcs		
For models:	031FTE04, 031FTE06, 070E, 070FTE04, 070FTE05, 071E, 071FTE04, 071FTE06, 08WFAAE, 090E, 090FTE04, 090FTE05, 091E, 091FTE04, 091FTE06, 0A0FT1E, 0A0FT2E, 0A0FT4E, 0A0FT5E, 0A0PE4, 0A1CP1E, 0D0FT1E, 0D0FT2E, 0D0FT4E, 0D0FT5E, 0D0PE4, 0D1CP1E, 0G0FT1E, 0G0FT2E, 0G0FT4E, 0G0FT5E, 0G0PE1, 0G0PE2, 0G1CP1E, 10WTPGE, 12WFAAA, 12WFAAE, 1A0BME, 1A0FT1E, 1A0FT2E, 1A0FT3E, 1A0FT4E, 1A0FT6E, 1A0PE4, 1A1PE4E, 1A1PEFTE, 1A1PI2E, 1A1PI2EA, 1A1FBE, 1D0BME...(Other models you can see in the webshop)		

			
1			
GEV No.	359020	Ref. No.	32W1550 32W1551
description	indicator light ø 10mm red 400V connection male faston 6.3mm Qty 1 pcs		
For models:	0A1CP1E, 0D1CP1E, 0G1CP1E, 191PI2E, 191PI2EA, 1A1PI2E, 1A1PI2EA, 1D1PI2E, 1D1PI2EA, 1G1PI1E		

			
1			
GEV No.	359140	Ref. No.	32W0790
description	indicator light ø 10mm yellow 230V connection male faston 6.3mm Qty 1 pcs		

			
1			
GEV No.	359334	Ref. No.	32W2440
description	indicator light ø 10mm yellow 24V connection male faston 6.3mm Qty 1 pcs		

			
1			
GEV No.	359034	Ref. No.	32W2240 32W2241
description	indicator light ø 10mm yellow 400V connection male faston 6.3mm Qty 1 pcs		
For models:	031FTE04, 031FTE06, 070FTE04, 070FTE05, 071FTE04, 071FTE06, 08WFAAE, 090FTE04, 090FTE05, 091FTE04, 091FTE06, 0A0FT1E, 0A0FT2E, 0A0FT4E, 0A0FT5E, 0D0FT1E, 0D0FT2E, 0D0FT4E, 0D0FT5E, 0G0FT1E, 0G0FT2E, 0G0FT4E, 0G0FT5E, 10WTPGE, 12WFAAA, 12WFAAE, 190BM2E, 1A0BME, 1A0FT1E, 1A0FT2E, 1A0FT3E, 1A0FT4E, 1A0FT6E, 1A1PE4E, 1A1PEFTE, 1A1FBE, 1D0BME, 1D0FT1E, 1D0FT2E, 1D0FT3E, 1D0FT4E, 1D0FT6E, 1D1PE4E, 1D1FBE, 1G0FT1E, 1G0FT2E, 1G0FT3E, 1G0FT4E, 1G1FA0E, 1G1FA0EV...(Other models you can see in the webshop)		

ø12mm

with screw socket



1

GEV No.	359023	Ref. No.	32W1380
description	indicator light ø 12mm 24V green connection male faston 6.3mm		

28.5x28.5mm

lamps (complete)



1

GEV No.	359355	Ref. No.	32W1250
description	indicator light mounting measurements 28.5x28.5mm 230V blue		



1

GEV No.	359352	Ref. No.	32W1220
description	indicator light mounting measurements 28.5x28.5mm 230V clear		



1

GEV No.	359353	Ref. No.	32W1230
description	indicator light mounting measurements 28.5x28.5mm 230V green		



1

GEV No.	359356	Ref. No.	N/A
description	indicator light mounting measurements 28.5x28.5mm 230V red		

30x11mm



1

GEV No.	359158	Ref. No.	32W0550
description	indicator light mounting measurements 30x11mm 230V red connection male faston 6.3mm temp.-resist. 125°C		

30x22mm



1

GEV No.	359155	Ref. No.	32W0680
description	indicator light mounting measurements 30x22mm 230V red connection male faston 6.3mm temp.-resist. 125°C type RL2		



1

GEV No.	359156	Ref. No.	32W0270 32W0640
description	indicator light mounting measurements 30x22mm 230V yellow connection male faston 6.3mm temp.-resist. 125/55°C type RL2		

33x10mm



1

GEV No.	359451	Ref. No.	32W0720
description	indicator light mounting measurements 33.1x10.3mm 400V yellow connection male faston 6.3mm		

34x10mm



1

GEV No.	359899	Ref. No.	32W0650
description	indicator light mounting measurements 34x10mm 380V red connection male faston 6.3mm temp.-resist. 120°C		

screw-on/push-on fit

light bulbs

for ovens



1

GEV No.	359610	Ref. No.	32W0780
description	light bulb t.max. 300°C socket E14 15W 230V ø 22mm L 47mm lens L 20mm for oven lamp type Philips		



PHILIPS



1

GEV No.	359612	Ref. No.	32W0210
description	light bulb t.max. 300°C socket E14 25W 230V ø 25mm L 56mm lens L 30mm for oven lamp type Philips		
For models:	FC101, FC1011E, FC1011G, FC101E, FC1221E, FC1221G, FC241, FC241E, FC241G, FC61, FC611E, FC611G, FC61E, FCV101, FCV101-CSA, FCV101DM, FCV101DM-CSA, FCV101DS, FCV101DS-CSA, FCV101E, FCV101EDM, FCV101EDM-UL, FCV101EDS, FCV101EDS-UL, FCV101E-UL, FCV141, FCV141-CSA, FCV141DM, FCV141DM-CSA, FCV141DS, FCV141DS-CSA, FCV141E, FCV141EDM, FCV141EDS, FCV241, FCV241DM, FCV241DS, FCV241E, FCV241EDM, FCV241EDM-UL, FCV241EDS, FCV241EDS-UL, FCV241E-UL, FCV241G, FCV241G-CSA, FCV241GDM, FCV241GDM-CSA, FCV241GDS, FCV241GDS-CSA, FCV3EM...(Other models you can see in the webshop)		

fridge lamps

PHILIPS



1

GEV No.	359595	Ref. No.	32W3790
description	light bulb socket E14 15W 230-240V ø 25mm L 56mm lens L 30mm Qty 1 pcs		
For models:	AF1B, AF1B-OPR01, AF1N, AF1N-OPR01, AF2B, AF2B-OPR01, AF2N, AF2N-OPR01, AGL6B, CX120, CX120B, CX120NN, CX130, CX130B, CX130NN, CX140, CX140B, CX140BN, CX140BR, CX140CP, CX140NN, CX140R, CX150, CX150B, CX150BN, CX150BR, CX150CP, CX150NN, CX150R, CX55, CX55B, CX60, CX60B, CX65, CX652, CX65B, CX65BR, CX65NB, CX65NCP, CX65NN, CX65R, CX70, CX702, CX70B, CX70BR, CX70NB, CX70NN, CX70R, FG2B, FSD1B...(Other models you can see in the webshop)		



1

GEV No.	359614	Ref. No.	32W2350
description	light bulb t.max. 300°C socket E27 230V 40W ø 45mm L 71mm lens L 44mm Qty 1 pcs		



oven lamps

universal oven lamps

mounting diameter 35.5mm



1

GEV No.	357162	Ref. No.	3008760	
description	oven lamp mounting ø 35.5mm 12V 20W socket G4 temp.-resist. 300°C connection cable 450mm hard glas			
spare parts for	357162			
	GEV No.	359599	Ref. No.	3019710 3030660
	halogen lamp socket G4 12V 20W temp.-resist. 500°C			
	GEV No.	359762	Ref. No.	—
	lamp socket socket G4 mounting ø 35.5mm connection cable 450mm			
	GEV No.	359942	Ref. No.	—
	oven lamp glass thr.ø 33.5mm ø 41mm hard glas temp.-resist. 350°C			

halogen lamp

for socket G4 / G6.35 / G9

OSRAM







1

GEV No.	357193	Ref. No.	3030661
description	halogen lamp socket G4 12V 20W temp.-resist. 300°C OSRAM HALOSTAR OVEN		
For models:	BX101E, BX101E-VERS.122013, BX101G, BX101G-VERS.122013, BX122E, BX122E-VERS.122013, BX122G, BX122G-VERS.122013, BX61E, BX61E-VERS.122013, BX61G, BX61G-VERS.122013, BX82E, BX82E-VERS.122013, BX82G, BX82G-VERS.122013, FM1011E1, FM1011E2, FM1011E3, FM1011G1, FM1011G2, FM1011G3, FM1221E1, FM1221E2, FM1221E3, FM1221G1, FM1221G2, FM1221G3, FM611E2, FM611E3, FM611G1, FM611G2, FM611G3, FM721E1, FM721E2, FM721E3, FM721G1, FM721G2, FM721G3, FX101E1, FX101E1R, FX101E2, FX101E2C, FX101E2C-VERS.032014, FX101E2R, FX101E2R-VERS.032014, FX101E2-VERS.032014, FX101E3, FX101E3C, FX101E3C-VERS.022014...(Other models you can see in the webshop)		





1





GEV No.	360759	Ref. No.	3019720	
description	oven lamp mounting ø 35.5mm 12V 20W socket G4 temp.-resist. 350°C connection cable 450mm hard glas			
For models:	FPZ14E, FPZ16E, FPZ24E, FPZ2635E, FPZ26E, FPZ4G, FPZ6G			
spare parts for	360759			
	GEV No.	357192	Ref. No.	—
	halogen lamp socket G4 12V 20W temp.-resist.°C OSRAM HALOSTAR STARLITE			
	GEV No.	357264	Ref. No.	—
	lamp socket socket G4 mounting ø 35.5mm connection cable 450mm			
	GEV No.	359033	Ref. No.	3019730
	oven lamp glass thr.ø 33.5mm H 36mm ø 41mm hard glas temp.-resist. 350°C			



1



GEV No.	359599	Ref. No.	3019710 3030660
description	halogen lamp socket G4 12V 20W temp.-resist. 500°C		
For models:	BX101E, BX101E-VERS.122013, BX101G, BX101G-VERS.122013, BX122E, BX122E-VERS.122013, BX122G, BX122G-VERS.122013, BX61E, BX61E-VERS.122013, BX61G, BX61G-VERS.122013, BX82E, BX82E-VERS.122013, BX82G, BX82G-VERS.122013, FM1011E1, FM1011E2, FM1011E3, FM1011G1, FM1011G2, FM1011G3, FM1221E1, FM1221E2, FM1221E3, FM1221G1, FM1221G2, FM1221G3, FM611E2, FM611E3, FM611G1, FM611G2, FM611G3, FM721E1, FM721E2, FM721E3, FM721G1, FM721G2, FM721G3, FPZ14E, FPZ16E, FPZ24E, FPZ2635E, FPZ26E, FPZ4G, FPZ6G, FX101E1, FX101E1R, FX101E2, FX101E2C...(Other models you can see in the webshop)		

			
1			
GEV No.	359718	Ref. No.	32W0740
description	oven lamp mounting ø 35.5mm 230V 15W socket E14 temp.-resist. 300°C connection male faston 6.3mm hard glas		
spare parts for	359718		
	GEV No.	359701	Ref. No. 32W0746 32W2561
	lamp socket socket E14 220-230V mounting ø 35.5mm connection male faston 6.3mm 15W		
	GEV No.	359740	Ref. No. —
	light bulb t.max. 300°C socket E14 15W 230V ø 22mm L 48mm lens L 20mm for oven lamp IMPORT		

			
1			
GEV No.	359701	Ref. No.	32W0746 32W2561
description	lamp socket socket E14 220-230V mounting ø 35.5mm connection male faston 6.3mm 15W		
For models:	FC101, FC101E, FC241, FC241E, FC241G, FC61, FC61E, FCV101, FCV101-CSA, FCV101DM, FCV101DM-CSA, FCV101DS, FCV101DS-CSA, FCV101E, FCV101EDM, FCV101EDM-UL, FCV101EDS, FCV101EDS-UL, FCV101E-UL, FCV141, FCV141-CSA, FCV141DM, FCV141DM-CSA, FCV141DS, FCV141DS-CSA, FCV141E, FCV141EDM, FCV141EDS, FCV241, FCV241DM, FCV241DS, FCV241E, FCV241EDM, FCV241EDM-UL, FCV241EDS, FCV241E-UL, FCV241G, FCV241GDM, FCV241GDM-CSA, FCV241GDS, FCV241GDS-CSA, FCV401DM, FCV401DM-CSA, FCV401EDM, FCV401EDM-UL, FCV61, FCV61-CSA, FCV61DM, FCV61DM-CSA, FCV61DS...(Other models you can see in the webshop)		
accessories for	359701		
	GEV No.	359705	Ref. No. 32W3080
	oven lamp glass thr.ø 33.5mm ø 52mm hard glas temp.-resist. 350°C		
	GEV No.	359709	Ref. No. —
	oven lamp glass thr.ø 33.5mm ø 42mm hard glas temp.-resist. 350°C		
	GEV No.	359721	Ref. No. —
	gasket silicone ED ø 48mm ID ø 39.5mm thickness 5mm Qty 1 pcs		
	GEV No.	359942	Ref. No. —
	oven lamp glass thr.ø 33.5mm ø 41mm hard glas temp.-resist. 350°C		

			
1			
GEV No.	359033	Ref. No.	3019730
description	oven lamp glass thr.ø 33.5mm H 36mm ø 41mm hard glas temp.-resist. 350°C		
For models:	FPZ14E, FPZ16E, FPZ24E, FPZ2635E, FPZ26E, FPZ4G, FPZ6G		

			
1			
GEV No.	359705	Ref. No.	32W3080
description	oven lamp glass thr.ø 33.5mm ø 52mm hard glas temp.-resist. 350°C		
accessories for	359705		
	GEV No.	359610	Ref. No. 32W0780
	light bulb t.max. 300°C socket E14 15W 230V ø 22mm L 47mm lens L 20mm for oven lamp type Philips		
	GEV No.	359700	Ref. No. —
	gasket for pizza oven fibre glass ID ø 32.5mm ED ø 55mm thickness 5mm		
	GEV No.	359721	Ref. No. —
	gasket silicone ED ø 48mm ID ø 39.5mm thickness 5mm Qty 1 pcs		
	GEV No.	359837	Ref. No. —
	gasket ID ø 33mm ED ø 46mm thickness 1mm graphite		
	GEV No.	359838	Ref. No. —
	gasket ID ø 33mm ED ø 45mm		

			
1			
GEV No.	359661	Ref. No.	32X3080
description	oven lamp glass thread 32.1 ø 58mm hard glas temp.-resist. 350°C		
accessories for	359661		
	GEV No.	359700	Ref. No. —
	gasket for pizza oven fibre glass ID ø 32.5mm ED ø 55mm thickness 5mm		

55x70mm			
			
1			
GEV No.	358147	Ref. No.	3036970
description	gasket L 75mm W 65mm thickness 1mm for oven lamp		
For models:	FC1011E, FC1011G, FC1221E, FC1221G, FC611E, FC611G, FCV3EM, FCV4E, FCV4EDS, FCV4EM, FM1011E1, FM1011E1-VERS.2006, FM1011E2, FM1011E2-VERS.2006, FM1011E3, FM1011E3-VERS.2006, FM1011G1, FM1011G1-VERS.2006, FM1011G2, FM1011G2-VERS.2006, FM1011G3, FM1011G3-VERS.2006, FM1221E1, FM1221E1-VERS.2006, FM1221E2, FM1221E2-VERS.2006, FM1221E3, FM1221E3-VERS.2006, FM1221G1, FM1221G1-VERS.2006, FM1221G2, FM1221G2-VERS.2006, FM1221G3, FM1221G3-VERS.2006, FM2011E2-VERS.2006, FM2011E3-VERS.2006, FM2011G2-VERS.2006, FM2011G3-VERS.2006, FM2021E1, FM2021E2, FM2021E2-VERS.2006, FM2021E3-VERS.2006, FM2021G1, FM2021G2, FM2021G2-VERS.2006, FM2021G3, FM2021G3-VERS.2006, FM423E1, FM423E2, FM611E1...(Other models you can see in the webshop)		









			
1			
GEV No.	359299	Ref. No.	37Q4100 37Q4106
description	gasket L 91mm W 77mm hole ø 3mm for oven lamp		
For models:	FCV3EM, FCV4E, FCV4EDS, FCV4EM		

			
1			
GEV No.	359296	Ref. No.	37M9910 37M9911
description	lamp glass L 74mm W 58mm thickness 3mm		
For models:	FCV3EM, FCV4E, FCV4EDS, FCV4EM		

producer-specific oven lamps			
ANGELO PO			
			
1			
GEV No.	359339	Ref. No.	37Q7840
description	gasket ID ø 65mm ED ø 80mm thickness 1mm		
For models:	FC101, FC101E, FC241, FC241E, FC241G, FC61, FC61E, FCV101, FCV101-CSA, FCV101DM, FCV101DM-CSA, FCV101DS, FCV101DS-CSA, FCV101E, FCV101EDM, FCV101EDM-UL, FCV101EDS, FCV101EDS-UL, FCV101E-UL, FCV141, FCV141-CSA, FCV141DM, FCV141DM-CSA, FCV141DS, FCV141DS-CSA, FCV141E, FCV141EDM, FCV141EDS, FCV241, FCV241DM, FCV241DS, FCV241E, FCV241EDM, FCV241EDM-UL, FCV241EDS, FCV241EDS-UL, FCV241E-UL, FCV241G, FCV241G-CSA, FCV241GDM, FCV241GDM-CSA, FCV241GDS, FCV241GDS-CSA, FCV401DM, FCV401DM-CSA, FCV401EDM, FCV401EDM-UL, FCV4E, FCV4EDS, FCV61...(Other models you can see in the webshop)		

			
1			
GEV No.	359340	Ref. No.	3036650 37M6210
description	glass panel round ø 78mm thickness 3mm		
For models:	031FT04, 031FT06, 070FT04, 070FT05, 071FT04, 071FT06, 090FT04, 090FT05, 091FT04, 091FT06, 0A0FT1G, 0A0FT2G, 0A0FT4G, 0A0FT5G, 0D0FT1G, 0D0FT2G, 0D0FT4G, 0D0FT5G, 1A0FT1G, 1A0FT2G, 1A0FT3G, 1A0FT4G, 1A0FT6G, 1D0FT1G, 1D0FT2G, 1D0FT3G, 1D0FT4G, 1D0FT6G, FC101, FC101E, FC241, FC241E, FC241G, FC61, FC61E, FCV101, FCV101-CSA, FCV101DM, FCV101DM-CSA, FCV101DS, FCV101DS-CSA, FCV101E, FCV101EDM, FCV101EDM-UL, FCV101EDS, FCV101EDS-UL, FCV101E-UL, FCV141, FCV141-CSA, FCV141DM...(Other models you can see in the webshop)		



			
1			
GEV No.	359701	Ref. No.	32W0746 32W2561
description	lamp socket socket E14 220-230V mounting ø 35.5mm connection male faston 6.3mm 15W		
For models:	FC101, FC101E, FC241, FC241E, FC241G, FC61, FC61E, FCV101, FCV101-CSA, FCV101DM, FCV101DM-CSA, FCV101DS, FCV101DS-CSA, FCV101E, FCV101EDM, FCV101EDM-UL, FCV101EDS, FCV101EDS-UL, FCV101E-UL, FCV141, FCV141-CSA, FCV141DM, FCV141DM-CSA, FCV141DS, FCV141DS-CSA, FCV141E, FCV141EDM, FCV141EDS, FCV241, FCV241DM, FCV241DS, FCV241E, FCV241EDM, FCV241EDM-UL, FCV241EDS, FCV241E-UL, FCV241G, FCV241GDM, FCV241GDM-CSA, FCV241GDS, FCV241GDS-CSA, FCV401DM, FCV401DM-CSA, FCV401EDM, FCV401EDM-UL, FCV61, FCV61-CSA, FCV61DM, FCV61DM-CSA, FCV61DS...(Other models you can see in the webshop)		
accessories for	359701		
	GEV No.	Ref. No.	32W3080
		oven lamp glass thr.ø 33.5mm ø 52mm hard glas temp.-resist. 350°C	
	GEV No.	Ref. No.	—
		oven lamp glass thr.ø 33.5mm ø 42mm hard glas temp.-resist. 350°C	
	GEV No.	Ref. No.	—
		gasket silicone ED ø 48mm ID ø 39.5mm thickness 5mm Qty 1 pcs	
	GEV No.	Ref. No.	—
		oven lamp glass thr.ø 33.5mm ø 41mm hard glas temp.-resist. 350°C	

			
1			
GEV No.	357179	Ref. No.	3159800 3278370 35E3360
description	frame for oven lamp L 97mm W 97mm thickness 6mm mounting distance 78mm ø 55mm		
For models:	BX101E, BX101E-VERS.122013, BX101G, BX101G-VERS.122013, BX122E, BX122E-VERS.122013, BX122G, BX122G-VERS.122013, BX61E, BX61E-VERS.122013, BX61G, BX61G-VERS.122013, BX82E, BX82E-VERS.122013, BX82G, BX82G-VERS.122013, FC101E, FC101G, FC1221E, FC1221G, FC61E, FC61G, FCV3EM, FCV4E, FCV4EDS, FCV4EM, FM1011E1, FM1011E1-VERS.2006, FM1011E2, FM1011E2-VERS.2006, FM1011E3, FM1011E3-VERS.2006, FM1011G1, FM1011G1-VERS.2006, FM1011G2, FM1011G2-VERS.2006, FM1011G3, FM1011G3-VERS.2006, FM1221E1, FM1221E1-VERS.2006, FM1221E2, FM1221E2-VERS.2006, FM1221E3, FM1221E3-VERS.2006, FM1221G1, FM1221G1-VERS.2006, FM1221G2, FM1221G2-VERS.2006, FM1221G3, FM1221G3-VERS.2006...(Other models you can see in the webshop)		







			
1			
GEV No.	551336	Ref. No.	36E3170
description	gasket for lamp L 92mm W 92mm thickness 2.3mm		
For models:	BX101E, BX101E-VERS.122013, BX101G, BX101G-VERS.122013, BX122E, BX122E-VERS.122013, BX122G, BX122G-VERS.122013, BX61E, BX61E-VERS.122013, BX61G, BX61G-VERS.122013, BX82E, BX82E-VERS.122013, BX82G, BX82G-VERS.122013, FC1011E, FC1011G, FC1221E, FC1221G, FC611E, FC611G, FCV3EM, FCV4E, FCV4EDS, FCV4EM, FM1011E1, FM1011E1-VERS.2006, FM1011E2, FM1011E2-VERS.2006, FM1011E3, FM1011E3-VERS.2006, FM1011G1, FM1011G1-VERS.2006, FM1011G2, FM1011G2-VERS.2006, FM1011G3, FM1011G3-VERS.2006, FM1221E1, FM1221E1-VERS.2006, FM1221E2, FM1221E2-VERS.2006, FM1221E3, FM1221E3-VERS.2006, FM1221G1, FM1221G1-VERS.2006, FM1221G2, FM1221G2-VERS.2006, FM1221G3, FM1221G3-VERS.2006...(Other models you can see in the webshop)		

			
2			
GEV No.	357180	Ref. No.	3036960 3036961 3036962 3036963
description	lamp glass L 73.6mm W 64mm thickness 4mm		
For models:	BX101E, BX101E-VERS.122013, BX101G, BX101G-VERS.122013, BX122E, BX122E-VERS.122013, BX122G, BX122G-VERS.122013, BX61E, BX61E-VERS.122013, BX61G, BX61G-VERS.122013, BX82E, BX82E-VERS.122013, BX82G, BX82G-VERS.122013, FC1011E, FC1011G, FC1221E, FC1221G, FC611E, FC611G, FCV3EM, FCV4E, FCV4EDS, FCV4EM, FM1011E1, FM1011E1-VERS.2006, FM1011E2, FM1011E2-VERS.2006, FM1011E3, FM1011E3-VERS.2006, FM1011G1, FM1011G1-VERS.2006, FM1011G2, FM1011G2-VERS.2006, FM1011G3, FM1011G3-VERS.2006, FM1221E1, FM1221E1-VERS.2006, FM1221E2, FM1221E2-VERS.2006, FM1221E3, FM1221E3-VERS.2006, FM1221G1, FM1221G1-VERS.2006, FM1221G2, FM1221G2-VERS.2006, FM1221G3, FM1221G3-VERS.2006...(Other models you can see in the webshop)		

			
1			
GEV No.	359295	Ref. No.	32V5570
description	lamp socket for halogen lamp 12V 20W socket G4 mounting measurements 55 x 70mm cable length 135mm		
For models:	BX101E, BX101E-VERS.122013, BX101G, BX101G-VERS.122013, BX122E, BX122E-VERS.122013, BX122G, BX122G-VERS.122013, BX61E, BX61E-VERS.122013, BX61G, BX61G-VERS.122013, BX82E, BX82E-VERS.122013, BX82G, BX82G-VERS.122013, FM1011E1, FM1011E1-VERS.2006, FM1011E2, FM1011E2-VERS.2006, FM1011E3, FM1011E3-VERS.2006, FM1011G1, FM1011G1-VERS.2006, FM1011G2, FM1011G2-VERS.2006, FM1011G3, FM1011G3-VERS.2006, FM1221E1, FM1221E1-VERS.2006, FM1221E2, FM1221E2-VERS.2006, FM1221E3, FM1221E3-VERS.2006, FM1221G1, FM1221G1-VERS.2006, FM1221G2, FM1221G2-VERS.2006, FM1221G3, FM1221G3-VERS.2006, FM2011E2-VERS.2006, FM2011E3-VERS.2006, FM2011G2-VERS.2006, FM2011G3-VERS.2006, FM2021E1, FM2021E2, FM2021E2-VERS.2006, FM2021E3, FM2021E3-VERS.2006, FM2021G1...(Other models you can see in the webshop)		
spare parts for	359295		
	GEV No.	359599	Ref. No. 3019710 3030660
	halogen lamp socket G4 12V 20W temp.-resist. 500°C		
accessories for	359295		
	GEV No.	359296	Ref. No. 37M9910 37M9911
	lamp glass L 74mm W 58mm thickness 3mm		

accessories for	359295		
	GEV No.	551336	Ref. No. 36E3170
	gasket for lamp L 92mm W 92mm thickness 2.3mm		

			
1			
GEV No.	357262	Ref. No.	3097180
description	lamp socket socket E14 mounting measurements 55x70mm connection male faston 6.3mm Qty 1 pcs		
For models:	FC1011E, FC1011G, FC1221E, FC1221G, FC611E, FC611G, FCV3EM, FCV4E, FCV4EDS, FCV4EM, FM423E1, FM423E2		
accessories for	357262		
	GEV No.	357179	Ref. No. 3159800 3278370 35E3360
	frame for oven lamp L 97mm W 97mm thickness 6mm mounting distance 78mm ø 55mm		
	GEV No.	357180	Ref. No. 3036960 3036961 3036962 3036963
	lamp glass L 73.6mm W 64mm thickness 4mm		
	GEV No.	358147	Ref. No. 3036970
	gasket L 75mm W 65mm thickness 1mm for oven lamp		
	GEV No.	551336	Ref. No. 36E3170
	gasket for lamp L 92mm W 92mm thickness 2.3mm		

lamps

light bulbs

			
1			
GEV No.	359610	Ref. No.	32W0780
description	light bulb t.max. 300°C socket E14 15W 230V ø 22mm L 47mm lens L 20mm for oven lamp type Philips		

			
1			
GEV No.	359612	Ref. No.	32W0210
description	light bulb t.max. 300°C socket E14 25W 230V ø 25mm L 56mm lens L 30mm for oven lamp type Philips		
For models:	FC101, FC101E, FC101G, FC101E, FC1221E, FC1221G, FC241, FC241E, FC241G, FC61, FC61E, FC61G, FC61E, FC61E, FCV101, FCV101-CSA, FCV101DM, FCV101DM-CSA, FCV101DS, FCV101DS-CSA, FCV101E, FCV101EDM, FCV101EDM-UL, FCV101EDS, FCV101EDS-UL, FCV101E-UL, FCV141, FCV141-CSA, FCV141DM, FCV141DM-CSA, FCV141DS, FCV141DS-CSA, FCV141E, FCV141EDM, FCV141EDS, FCV241, FCV241DM, FCV241DS, FCV241E, FCV241EDM, FCV241EDM-UL, FCV241EDS, FCV241EDS-UL, FCV241E-UL, FCV241G, FCV241G-CSA, FCV241GDM, FCV241GDM-CSA, FCV241GDS, FCV241GDS-CSA, FCV3EM...(Other models you can see in the webshop)		



			
1			
GEV No.	359614	Ref. No.	32W2350
description	light bulb t.max. 300°C socket E27 230V 40W ø 45mm L 71mm lens L 44mm Qty 1 pcs		

halogen lamps

for socket G4 / G6.35 / G9

			
1			
GEV No.	357193	Ref. No.	3030661
description	halogen lamp socket G4 12V 20W temp.-resist. 300°C OSRAM HALOSTAR OVEN		
For models:	BX101E, BX101E-VERS.122013, BX101G, BX101G-VERS.122013, BX122E, BX122E-VERS.122013, BX122G, BX122G-VERS.122013, BX61E, BX61E-VERS.122013, BX61G, BX61G-VERS.122013, BX82E, BX82E-VERS.122013, BX82G, BX82G-VERS.122013, FM1011E1, FM1011E2, FM1011E3, FM1011G1, FM1011G2, FM1011G3, FM1221E1, FM1221E2, FM1221E3, FM1221G1, FM1221G2, FM1221G3, FM611E2, FM611E3, FM611G1, FM611G2, FM611G3, FM721E1, FM721E2, FM721E3, FM721G1, FM721G2, FM721G3, FX101E1, FX101E1R, FX101E2, FX101E2C, FX101E2C-VERS.032014, FX101E2R, FX101E2R-VERS.032014, FX101E2-VERS.032014, FX101E3, FX101E3C, FX101E3C-VERS.022014...(Other models you can see in the webshop)		

			
1			
GEV No.	359599	Ref. No.	3019710 3030660
description	halogen lamp socket G4 12V 20W temp.-resist. 500°C		
For models:	BX101E, BX101E-VERS.122013, BX101G, BX101G-VERS.122013, BX122E, BX122E-VERS.122013, BX122G, BX122G-VERS.122013, BX61E, BX61E-VERS.122013, BX61G, BX61G-VERS.122013, BX82E, BX82E-VERS.122013, BX82G, BX82G-VERS.122013, FM1011E1, FM1011E2, FM1011E3, FM1011G1, FM1011G2, FM1011G3, FM1221E1, FM1221E2, FM1221E3, FM1221G1, FM1221G2, FM1221G3, FM611E2, FM611E3, FM611G1, FM611G2, FM611G3, FM721E1, FM721E2, FM721E3, FM721G1, FM721G2, FM721G3, FPZ14E, FPZ16E, FPZ24E, FPZ2635E, FPZ26E, FPZ4G, FPZ6G, FX101E1, FX101E1R, FX101E2, FX101E2C...(Other models you can see in the webshop)		

lamp accessories

gaskets

			
1			
GEV No.	511436	Ref. No.	37Q7370
description	gasket for lamp		
For models:	135, 135-4, 135B, 135BN, 135BNX, 135BX, 135BXR, 135CPX, 135NN, 135NNX, 135X, 135X-3, 135X-4, 135XR, 65, 65B, 65BX, 65BX-2, 65BXR, 65NB, 65NBX, 65NN, 65NNX, 65X, 65X-2, 65XR, SP120, SP120B, SP120BN, SP120NN, SP135, SP135B, SP135BN, SP135CP, SP135NN, SP55, SP55B, SP65, SP65B, SP65NB, SP65NN		

timers

programme timers

			
1			
GEV No.	360380	Ref. No.	32Z0391
description	timer BIGATTI engines 1 chambers 1 operation time 3s 230V shaft ø 6x4.6mm shaft L 18mm manuf. no. 4023/3s. / 32Z0391 motor type 82354039		

			
1			
GEV No.	360382	Ref. No.	32Z5730
description	timer BIGATTI engines 1 chambers 1 operation time 6h 230V manuf. no. SA001 / 32Z5730 motor type 82394530		

			
1			
GEV No.	360645	Ref. No.	3289260
description	timer CDC 11901F engines 1 chambers 1 operation time 20S 230V 50/60Hz shaft ø 6x4mm shaft L 25mm manuf. no. 11901F1CEE000.0000		
For models:	FX201G3P, FX201G3-VERS.022014		



1

GEV No.	360389	Ref. No.	32V7290
description	timer CDC 4904F engines 1 chambers 4 operation time 5min 230V shaft \emptyset mm shaft Lmm manif. no. 4904F3 / 10300122 motor type M48L ATS		
For models:	KD100, KD100A, KD100PSD, KD130, KD130A		
spare parts for	360389		
	GEV No.	360083	Ref. No. —
	motor CDC pinion \emptyset 4.9mm teeth 10 230V turn direction left motor \emptyset 47mm H 19.3mm motor type M48L ATS for timer		



1

GEV No.	360379	Ref. No.	32Z4760
description	timer CDC 9003F engines 1 chambers 3 operation time 240s 230V shaft \emptyset 6x4.6mm shaft L 20mm manif. no. 9003F1 / 32Z4760 motor type M48R ATS		
spare parts for	360379		
	GEV No.	360118	Ref. No. —
	motor CDC pinion \emptyset 4.9mm teeth 10 230V voltage AC 50/60Hz turn direction right motor \emptyset 47mm H 19.3mm motor type M48R ATS for timer cable length 260mm 1.9/2.5W		

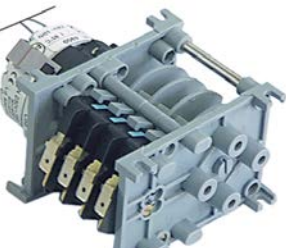

1

GEV No.	360196	Ref. No.	32Z0780
description	timer CDC 4904F engines 1 chambers 4 operation time 60s 230V manif. no. 4904F3 / 3322060 motor type M48L BTN		





1

GEV No.	360381	Ref. No.	32Z5840
description	timer CDC engines 1 chambers 2 operation time 2h 230V shaft \emptyset 6x4.6mm shaft L 19mm manif. no. 4900/32Z5840		



1

GEV No.	360215	Ref. No.	32V1940
description	timer CDC 7805DV engines 2 chambers 5 operation time 6s / 3min 230V shaft \emptyset mm shaft Lmm motor type M37RN/M37LN		
For models:	LC130, LC130-VERS.2001		
spare parts for	360215		
	GEV No.	360119	Ref. No. —
	motor CDC pinion \emptyset 5.4mm teeth 12 230V turn direction right motor \emptyset 37mm motor type M37RN for timer		
	GEV No.	360131	Ref. No. —
	motor CDC pinion \emptyset 5.4mm teeth 12 230V turn direction left motor \emptyset 37mm motor type M37LN for timer		



1

GEV No.	360386	Ref. No.	32Z0310
description	timer CRONEL engines 1 chambers 2 operation time 180s 230V shaft \emptyset 6x4.6mm shaft L 18mm manif. no. D9404 motor type 82340		



1

GEV No.	360077	Ref. No.	3030290
description	timer CROUZET engines 1 chambers 2 operation time 120s 230V shaft \emptyset mm shaft Lmm manif. no. 627/5261 motor type 82340		





1

GEV No.	360289	Ref. No.	3030290
description	timer CROUZET engines 1 chambers 2 operation time 120s 230V shaft ømm shaft Lmm manuf. no. 627/5309 motor type 600		
For models:	KD37, KD40		



1

GEV No.	360334	Ref. No.	32Z9630
description	timer FIBER P04 engines 1 chambers 2 operation time 120min 230V shaft ø 6x4.6mm shaft L 20mm manuf. no. P045J02W401 motor type M51BJ0R6400 impulse electric		
For models:	FCV3EM, FCV4EM		
spare parts for	360334		
	GEV No.	360673	Ref. No. —
	motor kit pinion ø 6.8mm teeth 15 230V voltage AC 50/60Hz turn direction clockwise motor ø 48mm H 18.5mm motor type UDS-40NE1RNZ165 cable length 150mm with holder		





1

GEV No.	360436	Ref. No.	32V5780
description	timer FIBER P24 engines 1 chambers 1 operation time 20s 230V shaft ø 4x6.4mm shaft L 25mm manuf. no. P245J01C118 motor type M51BJ0R0000		
For models:	BX101E, BX101E-VERS.122013, BX101G, BX101G-VERS.122013, BX122E, BX122E-VERS.122013, BX122G, BX122G-VERS.122013, BX61E, BX61E-VERS.122013, BX61G, BX61G-VERS.122013, BX82E, BX82E-VERS.122013, BX82G, BX82G-VERS.122013, FM1011E1, FM1011E1-VERS.2006, FM1011E2, FM1011E2-VERS.2006, FM1011E3, FM1011E3-VERS.2006, FM1011G1, FM1011G1-VERS.2006, FM1011G2, FM1011G2-VERS.2006, FM1011G3, FM1011G3-VERS.2006, FM1221E1, FM1221E1-VERS.2006, FM1221E2, FM1221E2-VERS.2006, FM1221E3, FM1221E3-VERS.2006, FM1221G1, FM1221G1-VERS.2006, FM1221G2, FM1221G2-VERS.2006, FM1221G3, FM1221G3-VERS.2006, FM2011E2-VERS.2006, FM2011E3-VERS.2006, FM2011G2-VERS.2006, FM2011G3-VERS.2006, FM2021E1, FM2021E2, FM2021E2-VERS.2006, FM2021E3, FM2021E3-VERS.2006, FM2021G1...(Other models you can see in the webshop)		





1

GEV No.	360435	Ref. No.	32V7300
description	timer FIBER P25 engines 1 chambers 4 operation time 6min 230V 50Hz shaft ømm shaft Lmm motor type M51BJ0L6400		
spare parts for	360435		
	GEV No.	360674	Ref. No. —
	motor kit pinion ø 6.8mm teeth 15 230V voltage AC 50/60Hz turn direction counterclockwise motor ø 48mm H 18.5mm motor type UDS40NE1RNZ165 cable length 150mm with holder		





1

GEV No.	360234	Ref. No.	32V2060
description	timer FIBER P25 engines 2 chambers 4 operation time 6s / 3min 230V shaft ømm shaft Lmm manuf. no. P255J04JBC7 motor type M51B-J0R6400 / M51BJ0L6400		
For models:	LF50, LF50E, LF50EM		
spare parts for	360234		
	GEV No.	360673	Ref. No. —
	motor kit pinion ø 6.8mm teeth 15 230V voltage AC 50/60Hz turn direction clockwise motor ø 48mm H 18.5mm motor type UDS-40NE1RNZ165 cable length 150mm with holder		
	GEV No.	360674	Ref. No. —
	motor kit pinion ø 6.8mm teeth 15 230V voltage AC 50/60Hz turn direction counterclockwise motor ø 48mm H 18.5mm motor type UDS40NE1RNZ165 cable length 150mm with holder		



1

GEV No.	360245	Ref. No.	32Z2020
description	timer FIBER P25 engines 2 chambers 5 operation time 180s / 6min 230V shaft ømm shaft Lmm manuf. no. P255J05JZE6 motor type M51BJ0R6400 / M51BJ0L6400		
For models:	L40, L40S, L45, L60		
spare parts for	360245		
	GEV No.	360673	Ref. No. —
	motor kit pinion ø 6.8mm teeth 15 230V voltage AC 50/60Hz turn direction clockwise motor ø 48mm H 18.5mm motor type UDS-40NE1RNZ165 cable length 150mm with holder		
	GEV No.	360674	Ref. No. —
	motor kit pinion ø 6.8mm teeth 15 230V voltage AC 50/60Hz turn direction counterclockwise motor ø 48mm H 18.5mm motor type UDS40NE1RNZ165 cable length 150mm with holder		





1

GEV No.	360392	Ref. No.	3175700
description	timer FIBER P25 engines 2 chambers 5 operation time 60s / 3min 230V shaft ømm shaft Lmm		





1

GEV No.	360232	Ref. No.	32V0530
description	timer FIBER P25 engines 2 chambers 5 operation time 6s / 9min 24V shaft ømm shaft Lmm manuf. no. P255205KEF0 motor type M51B20R6400 / M51B20L6400 voltage AC		
spare parts for	360232		
	GEV No.	360675	Ref. No. —
	motor kit pinion ø 6.8mm teeth 15 24V voltage AC 50/60Hz turn direction clockwise motor ø 48mm H 18.5mm motor type UDS-40NE1RNZ165 cable length 150mm with holder		
	GEV No.	360676	Ref. No. —
	motor kit pinion ø 6.8mm teeth 15 24V voltage AC 50/60Hz turn direction counterclockwise motor ø 48mm H 18.5mm motor type UDS40NE1RNZ165 cable length 150mm with holder		



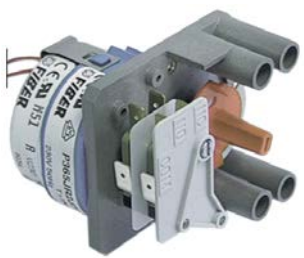

1

GEV No.	360246	Ref. No.	32Z8110
description	timer FIBER P25 engines 2 chambers 5 operation time 80s / 5min 230V shaft ømm shaft Lmm manuf. no. P255J05KRH3 motor type M51BJ0R6400 / M51BJ0L6400 run-time 80/300s		
For models:	F80P, F80PR, L80		
spare parts for	360246		
	GEV No.	360673	Ref. No. —
	motor kit pinion ø 6.8mm teeth 15 230V voltage AC 50/60Hz turn direction clockwise motor ø 48mm H 18.5mm motor type UDS-40NE1RNZ165 cable length 150mm with holder		
	GEV No.	360674	Ref. No. —
	motor kit pinion ø 6.8mm teeth 15 230V voltage AC 50/60Hz turn direction counterclockwise motor ø 48mm H 18.5mm motor type UDS40NE1RNZ165 cable length 150mm with holder		



1

GEV No.	360051	Ref. No.	32Z3840
description	timer FIBER P36 engines 1 chambers 2 operation time 15min 230V shaft ømm shaft Lmm manuf. no. P365JR2J717 motor type M51B-J0R6400		
For models:	PGA20, PGA30, PGA40, PGA60, PGA80, PGW20, PGW30, PGW40, PGW60, PGW80		
spare parts for	360051		
	GEV No.	360673	Ref. No. —
	motor kit pinion ø 6.8mm teeth 15 230V voltage AC 50/60Hz turn direction clockwise motor ø 48mm H 18.5mm motor type UDS-40NE1RNZ165 cable length 150mm with holder		



1

GEV No.	360369	Ref. No.	32Z5720
description	timer FIBER P37 engines 1 chambers 3 operation time 120s 230V shaft ømm shaft Lmm manuf. no. P375J03H340 motor type M51B-J0L***		
For models:	LT10R, LT20F, LT25F		
spare parts for	360369		
	GEV No.	360674	Ref. No. —
	motor kit pinion ø 6.8mm teeth 15 230V voltage AC 50/60Hz turn direction counterclockwise motor ø 48mm H 18.5mm motor type UDS40NE1RNZ165 cable length 150mm with holder		

mechanical timers





1

GEV No.	350003	Ref. No.	32Z0420 32Z2200
description	timer M2 with bell 2-pole operation time 120min impulse mechanical 2NO at 250V 16A permanent position no shaft ø 6x4.6mm shaft 6x4.6mm shaft L 23mm mounting distance 28mm connection lateral		
For models:	FC101, FC1011E, FC1011G, FC101E, FC1221E, FC1221G, FC241, FC241E, FC241G, FC61, FC611E, FC611G, FC61E		
accessories for	350003		
	GEV No.	110366	Ref. No. —
	knob switch zero mark t.max. °C°C ø 44mm shaft ø 6x4.6mm shaft flat upper black		

Table continues overleaf



accessories for	350003		
	GEV No.	111199	Ref. No. —
	dial plate graduation 120min permanent position no rotation 0-330° ø 60mm timers knob ø 45mm		

			
	1		
GEV No.	360447	Ref. No.	32Z5540
description	timer T203 1-pole operation time 5min impulse mechanical 1NO at 250V 16(3)A permanent position no shaft ø 4x4.6mm shaft 6x4.6mm shaft L 16mm mounting distance 30mm connection rear ambient temperature max. 55°C		

defrost timers

BIGATTI

			
	1		
GEV No.	360058	Ref. No.	32Z7100
description	defrost timer type SB3.82 defrosting interval 1-12x in 24h defrosting time 2-54min fan delay 0-15min 230V defr. funct. 1-12x per 24h		
For models:	40CP, 40CPX, 65NN, 65NNX, 6BMA11A, 6BMA11B, 6BMA11M, 6BMA2A, 6BMA2B, 6BMA2M, 6BMA3A, 6BMA3B, 6BMA3M, 6BMAA, 6BMAB, 6BMAM, 6BMB11A, 6BMB11B, 6BMB11M, 6BMB22A, 6BMB22B, 6BMB22M, 6BMB2A, 6BMB2B, 6BMB2M, 6BMB3A, 6BMB3B, 6BMB3M, 6BMB4A, 6BMB4B, 6BMB4M, 6BMBA, 6BMBB, 6BMBM, 6BMC11A, 6BMC11B, 6BMC11M, 6BMC22A, 6BMC22B, 6BMC22M, 6BMC2A, 6BMC2B, 6BMC2M, 6BMC33A, 6BMC33B, 6BMC33M, 6BMC3A, 6BMC3B, 6BMC3M, 6BMC4A...(Other models you can see in the webshop)		

CDC

			
	1		
GEV No.	360521	Ref. No.	32Z2420 32Z2421
description	defrost timer CDC type 11901F defrosting interval 4x per 24h defrosting time 12min fan delaymin 230V 50-60Hz defr. funct. every 6h		
For models:	120, 120NN, 120PV, 135, 135-4, 135BN, 135BNX, 135CPX, 135NN, 135NNX, 135PVX, 135X, 135X-3, 135X-4, 55, 55PV, 65, 65NN, 65NNX, 65PVX, 65X, 65X-2, SP65NN		

			
	1		
GEV No.	360384	Ref. No.	32Z5731
description	defrost timer CDC type 11901F defrosting interval 4x per 24h fan delaymin 230V		
For models:	135A, 135XE, 65A, 65XE, S125, S125-4, S125E, S125X, S125X-4, S60, S60-2, S60E, S60X, S60X-2, SA87		

miscellaneous			
			
	1		
GEV No.	360383	Ref. No.	32Z2452
description	defrost timer		

alarm devices

alarm units			
			
	1		
GEV No.	350056	Ref. No.	32Z5860
description	alarm device 220-240VAC ømm H 25mm wall-mounted version mounting distancemm 83dB protection IPx0		
For models:	FCV101, FCV101E, FCV141, FCV141E, FCV241, FCV241E, FCV241G, FCV241G-CSA, FCV3EM, FCV4EM, FCV61, FCV61E		



contactors

GENERAL ELECTRIC (AEG)

power contactors



1

GEV No.	380262	Ref. No.	3100910 32V7170 32Z2080 32Z2083
description	power contactor resistive load 32A 230VAC (AC3/400V) 17A/7.5kW main contacts 3NO auxiliary contacts 1NC connection screw connection type AEG LS7K01A type GE CL02A 301 H 85mm		
For models:	030FE, 030FE1, 030FE1B, 04WFR3ED, 08WFR4ED, 091FE28, 091FE28B, 091FR3E, 091FR3ED, 0A1FR3E, 0A1FR3ED, 0D1FR3E, 0D1FR3ED, 0G0FR3E, 0G0FR3ED, 191FR4E, 191FR4ED, 1A1FR4E, 1A1FR4ED, 1D1FR4E, 1D1FR4ED, 1G0FR4E, 1G1BR1E, 30FES, 30FES2, 30FES2B, 31RE, 6043840, 6043970, 70FES, 70FES2, 70FES2B, 71AR, 71ARE, 91AR, FC101, FC101E, FC241E, FC241G, FC61, FC611E, FC61E, FCV101, FCV101DM, FCV101DS, FCV101E, FCV101EDM, FCV101EDS, FCV141, FCV141DM...(Other models you can see in the webshop)		



2

GEV No.	380265	Ref. No.	32Z2091
description	power contactor resistive load 60A 230VAC (AC3/400V) 32A/16kW main contacts 3NO auxiliary contacts 1NO connection screw connection type AEG LS15K 00A type GE CL04A 310 H 98mm L 87mm W 55mm		
For models:	04WCP1EM, 091CP1E, 091FR1E, 091FR1ED, 0A1FR1E, 0A1FR1ED, 0D1FR1E, 0D1FR1ED, 0G1BR3E, 191BR1E, 191BR2E, 191BR2EA, 191FR2E, 191FR2ED, 1A1BR1E, 1A1BR2E, 1A1BR2EA, 1A1FR2E, 1A1FR2ED, 1D1BR1E, 1D1BR2E, 1D1BR2EA, 1D1FR2ED, 1G1BR3E, 291BR1E, 291BR2E, 291BR2EA, 2A1BR1E, 2A1BR2E, 2A1BR2EA, 2D1BR1E, 2D1BR2E, 2D1BR2EA, 70FE1, 70FE1B, 71ARE, 71FE2, 71FE2B, 91ARE		

ISKRA (FANAL)

power contactors



1

GEV No.	380415	Ref. No.	32Z4471
description	power contactor resistive load 16A 230VAC (AC3/400V) 8.5A/5.5kW main contacts 3NO auxiliary contacts 1NC connection male faston 6.3mm type Fanal DSL7 01 type ISKRA K07MF 01		



1

GEV No.	380212	Ref. No.	32V0980
description	power contactor resistive load 20A 230VAC (AC3/400V) 8.5A/5.5kW main contacts 3NO auxiliary contacts 1NC connection screw connection type Fanal K07M 01 type ISKRA DSL7 01		

LOVATO

power contactors



1

GEV No.	380711	Ref. No.	32Z3512 32Z4471
description	power contactor resistive load 20A 230VAC (AC3/400V) 9A/4kW main contacts 3NO auxiliary contacts 1NC connection male faston type 11BGF0901A230		
For models:	070FTE, 070FTE, 071BME, 071FTE, 071FTE, 071FTE, 071FTE, 090FTE, 090FTE, 091BME, 091FTE, 091FTE, 091FTE, 71ARE, 91ARE, FC1011E, FC1221E, FC241E, FCV141E, FCV141EDM, FCV141EDS, FCV241E, FCV241EDM, FCV241EDS, FCV401EDM, FCV61E, FM1011E1, FM1011E1-VERS.2006, FM1011E2, FM1011E2-VERS.2006, FM1011E3, FM1011E3-VERS.2006, FM1221E1, FM1221E1-VERS.2006, FM1221E2, FM1221E2-VERS.2006, FM1221E3, FM1221E3-VERS.2006, FM2011E2-VERS.2006, FM2011E3-VERS.2006, FM2021E1, FM2021E2, FM2021E2-VERS.2006, FM2021E3, FM2021E3-VERS.2006, FM611E3, FM721E1, FM721E1-VERS.2006, FM721E2, FM721E2-VERS.2006, FM721E3...		





1

GEV No.	380704	Ref. No.	32V6550
description	power contactor resistive load 20A 230VAC (AC3/400V) 9A/4kW main contacts 3NO auxiliary contacts 1NC connection screw connection type 11BG0901A230		
For models:	08WGREV, 190GRE, 191BR2EA, 1A1BR2EA, 1D1BR2EA, 1G0GRE, 291BR1GA, 291BR2EA, 291BR2GA, 2A1BR1GA, 2A1BR2EA, 2A1BR2GA, 2D1BR1GA, 2D1BR2GA, FC1011E, FC1011G, FC1221E, FC1221G, FC611E, FC611G, FCV3EM, FM1011E3, FM1011E3-VERS.2006, FM1011G3, FM1011G3-VERS.2006, FM1221E3, FM1221E3-VERS.2006, FM1221G3, FM1221G3-VERS.2006, FM2021E3, FM2021G3, FM423E1, FM423E2, FM611E3, FM611E3-VERS.2006, FM611G3, FM611G3-VERS.2006, FM721E3, FM721E3-VERS.2006, FM721G3, FM721G3-VERS.2006, FX101E3, FX101E3C, FX101E3C-VERS.022014, FX101E3R, FX101E3R-VERS.022014, FX101E3-VERS.022014, FX101G3, FX101G3C, FX101G3C-VERS.022014...(Other models you can see in the webshop)		



1

GEV No.	380705	Ref. No.	32V1880
description	power contactor resistive load 20A 230VAC (AC3/400V) 9A/4kW main contacts 3NO auxiliary contacts 1NO connection screw connection type 11BG0910A230		
accessories for	380705		
	GEV No.	Ref. No.	—
	380057		
	auxiliary contact contacts 1NO/1NC AC1 10A for contactors BG series connection screw type BGX1011		



1

GEV No.	380083	Ref. No.	3100940 32V5290
description	power contactor resistive load 25A 230VAC (AC3/400V) 9A/4.2kW main contacts 3NO auxiliary contacts 1NC connection screw connection type BF0901A230		
For models:	04WBMEV, 06WFT1EV, 06WFT2EV, 06WFT3EV, 06WFT4EV, 06WFT6EV, 06WFT7EV, 08WFT1EV, 08WFT2EV, 08WFT3EV, 08WFT4EV, 08WFT6EV, 08WFT7EV, 091FT1E, 091FT2E, 091FT4E, 091FT5E, 091FT7E, 0G1CP1EC, 0G1FT2E, 0G1FT4E, 0G1FT5E, 0G1FT7E, 191FT1E, 191FT2E, 191FT3E, 191FT4E, 191FT6E, 191FT7E, 1G1FT2E, 1G1FT4E, 1G1FT5E, 1G1FT6E, 1G1FT7E, BX101E, BX101E-VERS.122013, BX101G, BX101G-VERS.122013, BX122E, BX122E-VERS.122013, BX122G, BX122G-VERS.122013, BX61E, BX61E-VERS.122013, BX61G, BX61G-VERS.122013, BX82E, BX82E-VERS.122013, BX82G, BX82G-VERS.122013...(Other models you can see in the webshop)		



1

GEV No.	380782	Ref. No.	32Z2090
description	power contactor resistive load 40A 230VAC (AC3/400V) 12.5kW main contacts 3NO connection screw connection		



1

GEV No.	380721	Ref. No.	3110890
description	power contactor resistive load 45A 230VAC (AC3/400V) 26A/13kW main contacts 3NO auxiliary contacts connection screw connection type BF2600A230		
For models:	091CP1E, 091FR1E, 091FR1EA, 091FR1ED, 091FR1EX, 0A1FR1E, 0A1FR1ED, 0D1FR1E, 0D1FR1ED, 191BR1E, 191BR2E, 191BR2EA, 191FR2E, 191FR2ED, 1A1FR2E, 1A1FR2ED, 1D1FR2ED, 291BR1E, 291BR2E, 291BR2EA, FX122E3, FX122E3C, FX122E3T, FX122E3T-VERS.022014, FX12E3CT, FX12E3CT-VERS.022014, FX201E3, FX201E3P, FX201E3P-VERS.022014, FX201E3-VERS.022014, FX202E3, FX202E3-VERS.022014		

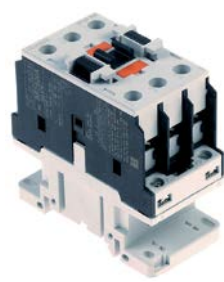

1

GEV No.	380722	Ref. No.	3100930 32Z3511
description	power contactor resistive load 56A 230VAC (AC3/400V) 32A/16kW main contacts 3NO auxiliary contacts connection screw connection type BF3200A230		
For models:	091FR1ED, 10CP1EA, 12CP1EA, 18CP2EA, BRE21HD, BRE31HD, BX101E, BX101E-VERS.122013, BX122E, BX122E-VERS.122013, BX61E, BX61E-VERS.122013, BX82E, BX82E-VERS.122013, FC1011E, FC101E, FC1221E, FC241E, FCV101E, FCV101EDM, FCV101EDS, FCV141E, FCV141EDM, FCV141EDS, FCV241E, FCV241EDM, FCV241EDS, FCV401EDM, FCV61E, FM1011E1, FM1011E1-VERS.2006, FM1011E2, FM1011E2-VERS.2006, FM1011E3, FM1011E3-VERS.2006, FM1221E1, FM1221E1-VERS.2006, FM1221E2, FM1221E2-VERS.2006, FM1221E3, FM1221E3-VERS.2006, FM2011E2-VERS.2006, FM2011E3-VERS.2006, FM2021E1, FM2021E2, FM2021E2-VERS.2006, FM2021E3, FM2021E3-VERS.2006, FM611E3, FM721E1...(Other models you can see in the webshop)		



MOELLER/EATON

power contactors



GEV No.	380171	Ref. No.	32Z4840
description	power contactor resistive load 20A 230VAC (AC3/400V) 9A/4kW main contacts 3NO auxiliary contacts 1NO connection screw connection type DILEM 10		
For models:	LCV, P10, P102, P10M, P20, P202, P5, Q3, Q3M, Q5, Q52, Q5M, Q8, Q82, TV1, TV1M, TV2L		

SIEMENS

power contactors



GEV No.	380646	Ref. No.	32Z9250
description	power contactor resistive load 40A 230VAC (AC3/400V) 17A/7.5kW main contacts 3NO auxiliary contacts connection screw connection type 3RT10-25-1AL20		
For models:	ART1L7, ART1L7A, ART1L7M, ART1LD, ART1LD7, ART1LD7A, ART1LD7M, ART1LDA, ART2LD, ART2SD, ART3SD, B1101S, B151H, B151M, BF101L, BF101S, BF51H, BF51M, D12Q1M, D12Q2, D12Q2M, DS51, DS51A, DS51C, DS51M, FS611, GR135BT, GR140TN4, GR65BT, GR65TN4, IA101L, IA101S, IA51, IA51A, IA51C, IA51M, IA72S, IS101L, IS101LW, IS101S, IS101SR, IS101SW, IS102S, IS102SR-0NR01, IS102SW, IS51, IS51A, IS51AR, IS51C, IS51CR...(Other models you can see in the webshop)		

TELEMECANIQUE (Schneider Electric)

power contactors



GEV No.	380617	Ref. No.	32Z8680
description	power contactor resistive load 25A 24VAC (AC3/400V) 9A/4kW main contacts 3NO auxiliary contacts 1NO/1NC connection screw connection type LC1D09B7		
For models:	C165D, C165S, C165VD, C165VS, C207D, C207S, C207VD, C207VS, C304AD, C304AS, C304AVD, C304AVS, C304D, C304S, C304VD, C304VS, CS243D, CS243S, CS243VD, CS243VS, CS370AD, CS370AS, CS370AVD, CS370AVS, CS370D, CS370S, CS370VD, CS370VS, CS466AD, CS466AS, CS466AVD, CS466AVS, CS466D, CS466S, CS466VD, CS466VS, N303D, N303S, N303VD, N303VS, N354D, N354S, N354VD, N354VS, N506D, N506S, N506VD, N506VS, N607D, N607S...(Other models you can see in the webshop)		

relays

power relays

with flange mounting



GEV No.	380817	Ref. No.	32Z7930
description	power relays Italiana Relè 230VAC 16A 2NO connection male faston 6.3mm screw mounting manuf. no. B1-2-230AC		
For models:	LT25F		

with bracket mounting

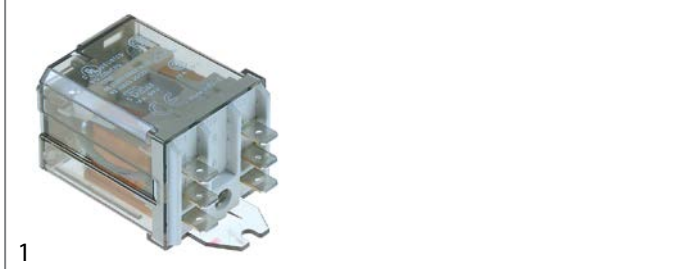

GEV No.	380815	Ref. No.	32V0540
description	power relays 230VAC 16A 2NO connection male faston 6.3mm flange dimensions 36x38x68mm		
For models:	LC100, LC100-VERS.2001, LC130, LC130-VERS.2001, LC80, LF50, LF50E		

1

GEV No.	380139	Ref. No.	32V2950 32V7100 32Z2000
description	power relays FINDER 230VAC 16A 2CO connection F6.3 bracket mounting dimensions 68x38.2x35.8mm manuf. no. 62.82.8.230.0000		
For models:	F60P, F60PR, F60T, F80P, F80PR, KD100, KD100A, KD100PSD, KD37, KD40, KD85, KD85A, KD85PS, KD85PSA, KN35, KN37, KN37PS, KN40, KN40PS, KN40PSD, KN50, KN50M, KN50MPS, KN50PS, KN50PSD, KN50PSDD, KN80, KN80PS, L100, L40, L40S, L45, L60, L80, LC100, LC100-VERS.2001, LC130, LC130-VERS.2001, LC80, LP151		



1

GEV No.	380403	Ref. No.	32V2940
description	power relays FINDER 230VAC 16A 3CO connection F6.3 bracket mounting manuf. no. 62.83.8.230.0500		
For models:	LF50EM, LP124, LP124V, LP84V		



1



GEV No.	380185	Ref. No.	32V3720
description	power relays Italiana Relè 230VAC 30A 1NO connection F6.3 bracket mounting dimensions 36.5x32.2x51.8mm manuf. no. A10-230AC-FA		

plug-in/print relays

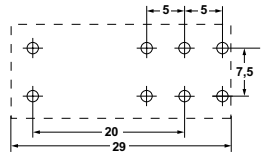

1



GEV No.	380333	Ref. No.	32V6630
description	print relay 230VAC 2CO at 250V 8A connection pins raster size 5mm FINDER manuf. no. 40.52.8.230.0000 95.65/95.75		
For models:	191BR2EA, FM1221G1, FM1221G2, FM1221G3, FM2011G2-VERS.2006, FM2011G3-VERS.2006, FM2021G1, FM2021G2, FM2021G2-VERS.2006, FM2021G3, FM2021G3-VERS.2006		
accessories for	380333		
	GEV No.	380340	Ref. No. —
	relay socket dimensions 62x36x15mm 250V voltage AC 10A Italiana Relè manuf. no. ZMEM/5		
	GEV No.	380505	Ref. No. —
	relay socket 2CO 40.52 dimensions 81.9x15.5x75mm 250V voltage AC 10A FINDER manuf. no. 95.95.3		
	GEV No.	381181	Ref. No. —
	relay socket 2-pole 40.51/40.52/40.61 connection screw clamp dimensions 15.8x78.6mm 250V voltage AC 10A FINDER manuf. no. 95.75		

transformers

open transformers

with clamp terminal



1

GEV No.	403905	Ref. No.	3117170
description	transformer primary 230V/50-60Hz secondary 12V 50VA connection screw connection type T1ULF		
For models:	10CP1EA, 10CP1GA, 10CP1IA, 12CP1EA, 12CP1GA, 12CP1IA, 18CP2EA, 18CP2GA, 18CP2IA, FX101E1, FX101E1R, FX101E2, FX101E2C, FX101E2C-VERS.032014, FX101E2R, FX101E2R-VERS.032014, FX101E2-VERS.032014, FX101E3, FX101E3C, FX101E3C-VERS.022014, FX101E3R, FX101E3R-VERS.022014, FX101E3-VERS.022014, FX101G1, FX101G1R, FX101G2, FX101G2C, FX101G2C-VERS.032014, FX101G2R, FX101G2R-VERS.032014, FX101G2-VERS.032014, FX101G3, FX101G3C, FX101G3C-VERS.022014, FX101G3R, FX101G3R-VERS.022014, FX101G3-VERS.022014, FX10E2CR, FX10E2CR-VERS.032014, FX10E3CR, FX10E3CR-VERS.022014, FX10G2CR, FX10G2CR-VERS.032014, FX10G3CR, FX10G3CR-VERS.022014, FX122E1, FX122E2, FX122E2C, FX122E2T, FX122E2T-VERS.032014...(Other models you can see in the webshop)		



with plug connection



GEV No.	400956	Ref. No.	32V5770
description	transformer primary 230VAC secondary 12VAC 20VA connection male faston 6.3mm 50/60Hz type T602012/E temperature restriction 150°C ambient temperature max. 80°C		
For models:	B1101S, B151H, B151M, BF101L, BF101S, BF51H, BF51M, BX101E, BX101E-VERS.122013, BX101G, BX101G-VERS.122013, BX61E, BX61E-VERS.122013, BX61G, BX61G-VERS.122013, BX82E, BX82E-VERS.122013, BX82G, BX82G-VERS.122013, FM1011E1, FM1011E1-VERS.2006, FM1011E2, FM1011E2-VERS.2006, FM1011E3, FM1011E3-VERS.2006, FM1011G1, FM1011G1-VERS.2006, FM1011G2, FM1011G2-VERS.2006, FM1011G3, FM1011G3-VERS.2006, FM611E1, FM611E1-VERS.2006, FM611E2, FM611E2-VERS.2006, FM611E3, FM611E3-VERS.2006, FM611G1, FM611G1-VERS.2006, FM611G2, FM611G2-VERS.2006, FM611G3, FM611G3-VERS.2006, FM721E1, FM721E1-VERS.2006, FM721E2, FM721E2-VERS.2006, FM721E3, FM721E3-VERS.2006, FM721G1...(Other models you can see in the webshop)		

encapsulated transformers

PMA



GEV No.	379054	Ref. No.	32Z3470
description	transformer primary 230VAC secondary 12VAC 3VA secondary 0.25A H 40mm L 45mm W 50mm connection screw 50/60Hz type 153/M		
For models:	120, 120B, 120PV, 135, 135-4, 135B, 135BA, 135BN, 135BNX, 135BX, 135BXE, 135BXR, 135CPX, 135PVX, 135X, 135X-3, 135X-4, 135XR, 40CP, 40CPX, 55, 55B, 55PV, 65, 65B, 65BA, 65BX, 65BX-2, 65BXE, 65BXR, 65NB, 65NBX, 65PVX, 65X, 65X-2, 65XR, 6BMA11A, 6BMA11B, 6BMA11M, 6BMA11Z, 6BMA2A, 6BMA2B, 6BMA2M, 6BMA2Z, 6BMA3A, 6BMA3B, 6BMA3M, 6BMA3Z, 6BMAA, 6BMAB...(Other models you can see in the webshop)		

electronic controllers

ELIWELL

refrigeration controllers

built-in version



GEV No.	379114	Ref. No.	32Z3460
description	electronic controller ELIWELL type EWPC961 mounting measurements 71x29mm		



GEV No.	379102	Ref. No.	32Z3660
description	electronic controller ELIWELL type EWPC970 mounting measurements 71x29mm 12V relay outputs 8A		



GEV No.	379614	Ref. No.	32V7580
description	electronic controller ELIWELL type ID961 mounting measurements 71x29mm 230V voltage AC NTC/PTC front measurements 33x75mm protection IP65 1x NTC probe inclusive -50 up to +150°C display 3½ digit LCD 1999 Digits		
For models:	MX120, MX130, MX130NN, MX140, MX150, MX150NN, MX60, MX70		
accessories for	379614		

GEV No.	378194	Ref. No.	32V6000
description	temperature probe NTC 10kOhm cable PVC probe -20 up to +80°C cable -10 up to 100°C probe ø7x24.5mm cable length 1.5m without screw connection 2-wire		
GEV No.	379052	Ref. No.	—
description	temperature probe PTC 1kOhm cable silicone probe -50 up to +150°C cable -50 up to +180°C probe ø6x40mm cable length 1.5m without screw connection 2-wire		
GEV No.	379053	Ref. No.	—
description	temperature probe PTC 1kOhm cable PVC probe -50 up to +150°C cable -10 up to 100°C probe ø6x30mm cable length 3m without screw connection 2-wire		
GEV No.	379057	Ref. No.	—
description	temperature probe NTC 10kOhm cable PVC probe -20 up to +80°C cable -10 up to 100°C probe ø6x25mm cable length 3m 2-wire		
GEV No.	379064	Ref. No.	8223470
description	temperature probe PTC 1kOhm cable silicone probe -50 up to +150°C cable -50 up to +180°C probe ø6x40mm cable length 3m without screw connection 2-wire		

Table continues overleaf



accessories for		379614	
GEV No.	379142	Ref. No.	—
	temperature probe PTC 1kOhm cable PVC probe -50 up to +150°C cable -10 up to 100°C probe ø6x30mm cable length 1.5m without screw connection 2-wire		
GEV No.	379160	Ref. No.	—
	temperature probe NTC 10kOhm cable thermoplastic probe -40 up to +110°C cable -40 up to +110°C probe ø6x14mm cable length 1.5m without screw connection 2-wire		
GEV No.	379161	Ref. No.	32V6010
	temperature probe NTC 10kOhm cable thermoplastic probe -40 up to +110°C cable -40 up to +110°C probe ø6x14mm cable length 3m without screw connection 2-wire		
GEV No.	379343	Ref. No.	32V3730
	temperature probe NTC 10kOhm cable silicone probe -40 up to +110°C cable -50 up to +180°C probe ø6x40mm cable length 3m 2-wire		
GEV No.	379458	Ref. No.	—
	temperature probe NTC 10kOhm cable silicone probe -40 up to +110°C cable -50 up to +180°C probe ø6x40mm cable length 1.5m without screw connection 2-wire		
GEV No.	379781	Ref. No.	—
	temperature probe PTC 1kOhm cable thermoplastic probe -50 up to +150°C cable -40 up to +110°C probe ø6x14mm cable length 1.5m without screw connection 2-wire		
GEV No.	379782	Ref. No.	—
	temperature probe PTC 1kOhm cable thermoplastic probe -50 up to +150°C cable -40 up to +110°C probe ø6x14mm cable length 3m 2-wire resistor 1kOhm		

EVCO - EVERY CONTROL

universal controllers

built-in version

1			
GEV No.	379632	Ref. No.	32V0421
description	electronic controller EVERY CONTROL mounting measurements 135x66mm built-in depth 67mm 230V voltage AC with accessories -50 up to +100°C type ECS805P220D306 front measurements 142x70mm		
For models:	ART2LD, ART2SD, ART3SD		

1			
GEV No.	379616	Ref. No.	32V5020
description	electronic controller EVERY CONTROL mounting measurements 71x29mm 12V voltage AC TC-K protection IP65 0-999°C type FK400A front measurements 33x75mm		
For models:	FPZ4G, FPZ6G		

refrigeration controllers

built-in version

1			
GEV No.	379232	Ref. No.	32V6500
description	electronic controller		
For models:	CX70R		

1			
GEV No.	381388	Ref. No.	32V2090
description	electronic controller ANGELO PO conversion kit mounting measurements 71x29mm 230V voltage AC NTC front measurements 33x75mm protection IP65 1x NTC probe inclusive -40 up to +99°C		
For models:	6SMA, 6SMA2, 6SMA2A, 6SMA2B, 6SMA2M, 6SMA2Z, 6SMA4Z, 6SMAA, 6SMAB, 6SMAM, 6SMAZ, 6SMB, 6SMB2, 6SMB2A, 6SMB2B, 6SMB2M, 6SMB2Z, 6SMB4, 6SMB4A, 6SMB4B, 6SMB4M, 6SMB4Z, 6SMB6Z, 6SMB6A, 6SMB6B, 6SMB6M, 6SMB6Z, 6SMC, 6SMC2, 6SMC2A, 6SMC2B, 6SMC2M, 6SMC2Z, 6SMC4, 6SMC4A, 6SMC4B, 6SMC4M, 6SMC4Z, 6SMC6, 6SMC6A, 6SMC6B, 6SMC6M, 6SMC6Z, 6SMC8Z, 6SMCA, 6SMCB, 6SMCM, 6SMCZ, PE1633, PE1633V...(Other models you can see in the webshop)		

1			
GEV No.	379613	Ref. No.	32V2980
description	electronic controller ANGELO PO mounting measurements 71x29mm 12V voltage AC NTC front measurements 33x75mm protection IP65 2xNTC probe inclusive -40 up to +110°C		
For models:	135B, 135BN, 135BNX, 135BX, 135BXR, 65B, 65BX, 65BX-2, 65BXR, 65NB, 65NBX, SP65NB		



GEV No.	379609	Ref. No.	32V6060
description	electronic controller ANGELO PO mounting measurements 71x29mm 12V voltage AC NTC relay outputs 1 relay front measurements 33x75mm protection IP65 2xNTC probe inclusive -40 up to +99°C compressor relay 16A		
For models:	CX130B, CX60B, FX150B, FX70B, MX120B, MX140B, MX55B, MX65B, S1200B, S1200B4, S1200BE, S600B, S600B2, S600BE		



GEV No.	379608	Ref. No.	32V6080
description	electronic controller EVERY CONTROL mounting measurements 71x29mm 12V voltage AC NTC relay outputs 1 relay front measurements 33x75mm protection IP65 2xNTC probe inclusive -40 up to +99°C compressor relay 16A		
For models:	CX130B, CX150B, CX150BN, CX150BR, CX60B, CX70B, CX70BR		



GEV No.	378187	Ref. No.	32V6050
description	electronic controller EVERY CONTROL mounting measurements 71x29mm 230V voltage AC NTC/PTC relay outputs 1 CO -50 up to +150°C display 3½ digits		
For models:	CX130, CX130NN, CX60, FX150, FX150NN, FX70		

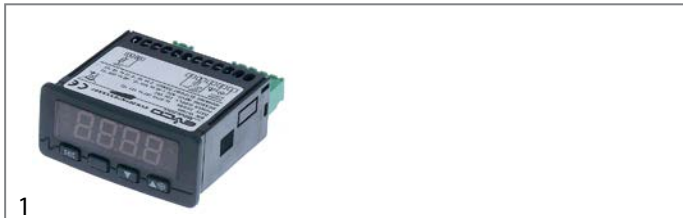

GEV No.	378192	Ref. No.	32V6900
description	electronic controller EVERY CONTROL type EVK201 mounting measurements 71x29mm 230V voltage AC NTC relay outputs 1 relay 1CO NTC defr. funct. no -50 up to +150°C display 3½ digits compressor relay 10A		
For models:	6SMA, 6SMA2, 6SMA2A, 6SMA2B, 6SMA2M, 6SMA2Z, 6SMA4Z, 6SMAA, 6SMAB, 6SMAM, 6SMAZ, 6SMB, 6SMB2, 6SMB2A, 6SMB2B, 6SMB2M, 6SMB2Z, 6SMB4, 6SMB4A, 6SMB4B, 6SMB4M, 6SMB4Z, 6SMB6Z, 6SMBA, 6SMBB, 6SMBM, 6SMBZ, 6SMC, 6SMC2, 6SMC2A, 6SMC2B, 6SMC2M, 6SMC2Z, 6SMC4, 6SMC4A, 6SMC4B, 6SMC4M, 6SMC4Z, 6SMC6, 6SMC6A, 6SMC6B, 6SMC6M, 6SMC6Z, 6SMC8Z, 6SMCA, 6SMCB, 6SMCM, 6SMCZ, PE1633, PE1633V...(Other models you can see in the webshop)		



GEV No.	378126	Ref. No.	3087950 3107290 3120900 32V6920 32V7490 32V7820 32V8590
description	electronic controller EVERY CONTROL type EVK201N7 mounting measurements 71x29mm 230V voltage AC NTC/PTC relay outputs 1 CO-16A(5) NTC/PTC front measurements 33x75mm built-in depth 59mm protection IP65 -40 up to +105°C display 3½ digits		
For models:	3G6SA, 3G6SA2, 3G6SA4, 4G6SB, 4G6SB2, 4G6SB4, 4G6SB6, 6BR15V, 6BR15VC, 6BR19V, 6BR19VC, 6MA, 6MA2, 6MA2A, 6MA2M, 6MAA, 6MAM, 6MB, 6MB11, 6MB11A, 6MB11M, 6MB2, 6MB2A, 6MB2M, 6MB4, 6MB4A, 6MB4M, 6MBA, 6MBM, 6MC, 6MC11, 6MC11A, 6MC11M, 6MC2, 6MC2A, 6MC2M, 6MC4, 6MC4A, 6MC4M, 6MCA, 6MCM, 6MJA, 6MJA2, 6MJA2A, 6MJA2M, 6MJAA, 6MJAM, 6MJB, 6MJB2, 6MJB2A...(Other models you can see in the webshop)		
accessories for	378126		

GEV No.	379053	Ref. No.	—
description	temperature probe PTC 1kOhm cable PVC probe -50 up to +150°C cable -10 up to 100°C probe ø6x30mm cable length 3m without screw connection 2-wire		
GEV No.	379064	Ref. No.	8223470
description	temperature probe PTC 1kOhm cable silicone probe -50 up to +150°C cable -50 up to +180°C probe ø6x40mm cable length 3m without screw connection 2-wire		
GEV No.	379161	Ref. No.	32V6010
description	temperature probe NTC 10kOhm cable thermoplastic probe -40 up to +110°C cable -40 up to +110°C probe ø6x14mm cable length 3m without screw connection 2-wire		
GEV No.	379782	Ref. No.	—
description	temperature probe PTC 1kOhm cable thermoplastic probe -50 up to +150°C cable -40 up to +110°C probe ø6x14mm cable length 3m 2-wire resistor 1kOhm		

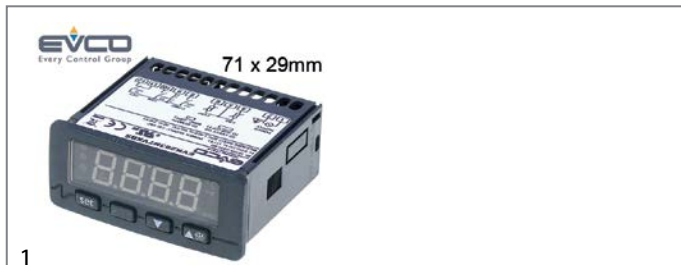

GEV No.	378154	Ref. No.	3048060 3096600 3106300 3107300 3119780
description	electronic controller EVERY CONTROL type EVK203N7VXBS mounting measurements 71x29mm 230V voltage AC NTC/PTC relay outputs 3 NO-16A(5) CO-8A(4) NO-8A(4) NTC/PTC NTC/PTC DI front measurementsmm built-in depth 59mm protection IP65 yes -50 up to +150°C display 3½ digits		
For models:	6ERA-OPR01, 6ERA2-OPR01, 6ERA2A-OPR01, 6ERA2M-OPR01, 6ERAA-OPR01, 6ERAM-OPR01, 6ERB-OPR01, 6ERB2-OPR01, 6ERB2A-OPR01, 6ERB2M-OPR01, 6ERB4-OPR01, 6ERB4A-OPR01, 6ERB4M-OPR01, 6ERBA-OPR01, 6ERBM-OPR01, 6ERC-OPR01, 6ERC2-OPR01, 6ERC2A-OPR01, 6ERC2M-OPR01, 6ERC4-OPR01, 6ERC4A-OPR01, 6ERC4M-OPR01, 6ERCA-OPR01, 6ERCM-OPR01, BS11, BS11A, BS11M, BS16, BS16A, BS16M, BS21, BS21A, BS21M, BSR11, BSR11A, BSR11M, BSR16, BSR16A, BSR16M, BSR21, BSR21A, BSR21M, MD130, MD130BN, MD130NN, MD150, MD150A, MD150BN, MD150NCP, MD150NN...(Other models you can see in the webshop)		
accessories for	378154		
	GEV No.	379053	Ref. No. —
	temperature probe PTC 1kOhm cable PVC probe -50 up to +150°C cable -10 up to 100°C probe ø6x30mm cable length 3m without screw connection 2-wire		
	GEV No.	379064	Ref. No. 8223470
	temperature probe PTC 1kOhm cable silicone probe -50 up to +150°C cable -50 up to +180°C probe ø6x40mm cable length 3m without screw connection 2-wire		
	GEV No.	379161	Ref. No. 32V6010
	temperature probe NTC 10kOhm cable thermoplastic probe -40 up to +110°C cable -40 up to +110°C probe ø6x14mm cable length 3m without screw connection 2-wire		
	GEV No.	379782	Ref. No. —
	temperature probe PTC 1kOhm cable thermoplastic probe -50 up to +150°C cable -40 up to +110°C probe ø6x14mm cable length 3m 2-wire resistor 1kOhm		



GEV No.	378189	Ref. No.	32V6290 32V6300
description	electronic controller EVERY CONTROL type EVK213 mounting measurements 71x29mm 12V voltage AC/DC NTC/PTC relay outputs 3 relays -40 up to +105°C display 3½ digits DEF Relay 8A fan relay 8A compressor relay 16A		
For models:	CX150CP, CX70NB		



GEV No.	378188	Ref. No.	32V6070 32V6270
description	electronic controller EVERY CONTROL type FK203B mounting measurements 71x29mm 12V voltage AC/DC NTC relay outputs 3 relays -40 up to +99°C DEF Relay 8A fan relay 8A compressor relay 10A		
For models:	CX130, CX130NN, CX150, CX150BN, CX150CP, CX150NN, CX150PV, CX150R, CX60, CX70, CX702, CX70PV		



GEV No.	378190	Ref. No.	32V6280
description	electronic controller EVERY CONTROL type FK203B mounting measurements 71x29mm 12V voltage AC/DC NTC relay outputs 3 relays -40 up to +99°C DEF Relay 8A fan relay 8A compressor relay 10A		
For models:	CX70NB, CX70NN		



GEV No.	378191	Ref. No.	32V6260
description	electronic controller EVERY CONTROL type FK203B mounting measurements 71x29mm 12V voltage AC/DC NTC relay outputs 3 relays -40 up to +99°C DEF Relay 8A fan relay 8A compressor relay 10A		



GEV No.	378193	Ref. No.	32V2920
description	electronic controller EVERY CONTROL type FK206A mounting measurements 71x29mm 12V voltage AC/DC NTC -40 up to +99°C		
For models:	6JA, 6JA2, 6JA2A, 6JA2M, 6JAA, 6JAM, 6JB, 6JB2, 6JB2A, 6JB2M, 6JB4A, 6JB4M, 6JBA, 6JBM		



1

GEV No.	379615	Ref. No.	32V7490
description	electronic controller mounting measurements 71x29mm 230V voltage AC NTC relay outputs 1 relay front measurements 33x75mm protection IP65 1x NTC probe inclusive -40 up to +99°C compressor relay 16A		
For models:	40, 40-OPR01, 40PV, 40PV-OPR01, 40X, 40X-OPR01, 40XPV		

electronic thermometers

built-in version



1

GEV No.	379900	Ref. No.	32Z8250
description	thermometer EVERY CONTROL type TM103T N4 mounting measurements 58x25.5mm 24V voltage AC -40 up to +110°C measuring input NTC display 2½ digit front measurements 31x64mm protection IP54 accuracy 1%		
For models:	C165D, C165S, C165VD, C165VS, C207D, C207D-VERS.2006, C207S, C207S-VERS.2006, C207VD, C207VD-VERS.2006, C207VS, C207VS-VERS.2006, C304AD, C304AD-VERS.2006, C304AS, C304AS-VERS.2006, C304AVD, C304AVD-VERS.2006, C304AVS, C304AVS-VERS.2006, C304D, C304D-VERS.2006, C304S, C304S-VERS.2006, C304VD, C304VD-VERS.2006, C304VS, C304VS-VERS.2006, C92D-VERS.2006, C92S-VERS.2006, C92VD-VERS.2006, C92VS-VERS.2006, CS243D, CS243D-VERS.2006, CS243S, CS243S-VERS.2006, CS243VD, CS243VD-VERS.2006, CS243VS, CS243VS-VERS.2006, CS370AD, CS370AD-VERS.2006, CS370AS, CS370AS-VERS.2006, CS370AVD, CS370AVD-VERS.2006, CS370AVS, CS370AVS-VERS.2006, CS370D, CS370D-VERS.2006...(Other models you can see in the webshop)		

accessories



1

GEV No.	378197	Ref. No.	32V7460
description	printer EVERY CONTROL PM100AX9S201 mounting measurements 90x90mm		
For models:	ISP202R, ISR201R, ISR202R, SM14SR, SM7SR		

SHANGFANG

accessories



1

GEV No.	379054	Ref. No.	32Z3470
description	transformer primary 230VAC secondary 12VAC 3VA secondary 0.25A H 40mm L 45mm W 50mm connection screw 50/60Hz type 153/M		
For models:	120, 120B, 120PV, 135, 135-4, 135B, 135BA, 135BN, 135BNX, 135BX, 135BXE, 135BXR, 135CPX, 135PVX, 135X, 135X-3, 135X-4, 135XR, 40CP, 40CPX, 55, 55B, 55PV, 65, 65B, 65BA, 65BX, 65BX-2, 65BXE, 65BXR, 65NB, 65NBX, 65PVX, 65X, 65X-2, 65XR, 6BMA11A, 6BMA11B, 6BMA11M, 6BMA11Z, 6BMA2A, 6BMA2B, 6BMA2M, 6BMA2Z, 6BMA3A, 6BMA3B, 6BMA3M, 6BMA3Z, 6BMAA, 6BMAB...(Other models you can see in the webshop)		

probes

universal probes

temperature probes



1

GEV No.	378194	Ref. No.	32V6000
description	temperature probe NTC 10kOhm cable PVC probe -20 up to +80°C cable -10 up to 100°C probe ø7x24.5mm cable length 1.5m without screw connection 2-wire		
For models:	6MA, 6MA2, 6MA2A, 6MA2M, 6MAA, 6MAM, 6MB, 6MB11, 6MB11A, 6MB11M, 6MB2, 6MB2A, 6MB2M, 6MB4, 6MB4A, 6MB4M, 6MBA, 6MBM, 6MC, 6MC11, 6MC11A, 6MC11M, 6MC2, 6MC2A, 6MC2M, 6MC4, 6MC4A, 6MC4M, 6MCA, 6MCM, 6MJA, 6MJA2, 6MJA2A, 6MJA2M, 6MJAA, 6MJAM, 6MJB, 6MJB2, 6MJB2A, 6MJB2M, 6MJB4, 6MJB4A, 6MJB4M, 6MJBA, 6MJBM, BP41P, BP41X, BP53G, BP53V, BP53X...(Other models you can see in the webshop)		



GEV No.	379343	Ref. No.	32V3730
description	temperature probe NTC 10kOhm cable silicone probe -40 up to +110°C cable -50 up to +180°C probe ø6x40mm cable length 3m 2-wire		
For models:	6EA, 6EA11, 6EA11A, 6EA11M, 6EA13, 6EA13A, 6EA13M, 6EA2, 6EA2A, 6EA2M, 6EAA, 6EAB, 6EABA, 6EABM, 6EAM, 6EB, 6EB11, 6EB11A, 6EB11M, 6EB13, 6EB13A, 6EB13M, 6EB2, 6EB22, 6EB22A, 6EB22M, 6EB2A, 6EB2M, 6EB4, 6EB4A, 6EB4M, 6EBA, 6EBB, 6EBBA, 6EBBM, 6EBM, 6EC, 6EC11, 6EC11A, 6EC11M, 6EC13, 6EC13A, 6EC13M, 6EC2, 6EC22, 6EC22A, 6EC22M, 6EC2A, 6EC2M, 6EC4...(Other models you can see in the webshop)		

GEV No.	379161	Ref. No.	32V6010
description	temperature probe NTC 10kOhm cable thermoplastic probe -40 up to +110°C cable -40 up to +110°C probe ø6x14mm cable length 3m without screw connection 2-wire		
For models:	3G6SA, 3G6SA2, 3G6SA4, 40-OPR01, 40B-OPR01, 40BX-OPR01, 40CP, 40CP-OPR01, 40CPX, 40CPX-OPR01, 40EV-OPR01, 40PV-OPR01, 40X-OPR01, 4G6SB, 4G6SB2, 4G6SB4, 4G6SB6, 6BR15V, 6BR15VC, 6BR19V, 6BR19VC, 6EA, 6EA11, 6EA11A, 6EA11M, 6EA13, 6EA13A, 6EA13M, 6EA2, 6EA2A, 6EA2M, 6EAA, 6EAB, 6EABA, 6EABM, 6EAM, 6EB, 6EB11, 6EB11A, 6EB11M, 6EB13, 6EB13A, 6EB13M, 6EB2, 6EB22, 6EB22A, 6EB22M, 6EB2A, 6EB2M, 6EB4...(Other models you can see in the webshop)		

GEV No.	379064	Ref. No.	8223470
description	temperature probe PTC 1kOhm cable silicone probe -50 up to +150°C cable -50 up to +180°C probe ø6x40mm cable length 3m without screw connection 2-wire		

GEV No.	379487	Ref. No.	32V0150
description	temperature probe PTC cable silicone probe -50 up to +150°C cable -50 up to +180°C probe ø6x30mm cable length 2.5m without screw connection 2-wire		
For models:	6BEA11A, 6BEA11B, 6BEA11M, 6BEA2A, 6BEA2B, 6BEA2M, 6BEA3A, 6BEA3B, 6BEA3M, 6BEAA, 6BEAB, 6BEABA, 6BEABB, 6BEABM, 6BEAM, 6BEB11A, 6BEB11B, 6BEB11M, 6BEB22A, 6BEB22B, 6BEB22M, 6BEB2A, 6BEB2B, 6BEB2M, 6BEB3A, 6BEB3B, 6BEB3M, 6BEB4A, 6BEB4B, 6BEB4M, 6BEBA, 6BEBB, 6BEBA, 6BEBA, 6BEBA, 6BEBA, 6BEC11A, 6BEC11B, 6BEC11M, 6BEC22A, 6BEC22B, 6BEC22M, 6BEC2A, 6BEC2B, 6BEC2M, 6BEC33A, 6BEC33B, 6BEC33M, 6BEC3A, 6BEC3B...(Other models you can see in the webshop)		

GEV No.	379932	Ref. No.	32Z6041
description	temperature probe Pt100 cable silicone probe -100 up to 450°C cable -50 up to +180°C connection 3-wire thread M10x1 probe ø3x130mm cable length 1.5m		
For models:	FCV101DM, FCV101DM-CSA, FCV101DS, FCV101DS-CSA, FCV101EDM, FCV101EDM-UL, FCV101EDS, FCV101EDS-UL, FCV141DM, FCV141DM-CSA, FCV141DS, FCV141DS-CSA, FCV141EDM, FCV141EDS, FCV241DM, FCV241DS, FCV241EDM, FCV241EDM-UL, FCV241EDS, FCV241EDS-UL, FCV241GDM, FCV241GDM-CSA, FCV241GDS, FCV241GDS-CSA, FCV401DM, FCV401DM-CSA, FCV401EDM, FCV401EDM-UL, FCV61DM, FCV61DM-CSA, FCV61DS, FCV61DS-CSA, FCV61EDM, FCV61EDM-UL, FCV61EDS, FCV61EDS-UL, FCV72EDM-UL, FCV72EDS-UL		

GEV No.	379934	Ref. No.	32Z6191
description	temperature probe Pt100 cable silicone probe -100 up to 450°C cable -50 up to +180°C connection 3-wire thread M10x1 probe ø3x65mm cable length 0.65m		
For models:	FCV101, FCV101-CSA, FCV101DM, FCV101DM-CSA, FCV101DS, FCV101DS-CSA, FCV101E, FCV101EDM, FCV101EDM-UL, FCV101EDS, FCV101EDS-UL, FCV101E-UL, FCV141, FCV141-CSA, FCV141DM, FCV141DM-CSA, FCV141DS, FCV141DS-CSA, FCV141E, FCV141EDM, FCV141EDS, FCV241, FCV241DM, FCV241DS, FCV241E, FCV241EDM, FCV241EDM-UL, FCV241EDS, FCV241EDS-UL, FCV241E-UL, FCV241G, FCV241G-CSA, FCV241GDM, FCV241GDM-CSA, FCV241GDS, FCV241GDS-CSA, FCV3EM, FCV401DM, FCV401DM-CSA, FCV401EDM, FCV401EDM-UL, FCV4E, FCV4EDS, FCV4EM, FCV61, FCV61-CSA, FCV61DM, FCV61DM-CSA, FCV61DS, FCV61DS-CSA...(Other models you can see in the webshop)		

GEV No.	379892	Ref. No.	32Z7410
description	temperature probe Pt100 cable Vetrotex probe -200 up to +600°C cable -50 up to +350°C connection 2-wire thread probe ø6x80mm cable length 1.5m		

GEV No.	379931	Ref. No.	32Z6780
description	temperature probe Pt100 cable Vetrotex probe -200 up to +600°C cable -50 up to +350°C connection 3-wire thread M10x1 probe ø4x85mm cable length 0.8m		
For models:	FCV4E, FCV4EDS		

producer-specific probes

probes

GEV No.	379652	Ref. No.	32Z3310
description	temperature probe Pt100 cable glass fibre probe -200 up to +600°C cable -50 up to +350°C connection 2-wire thread 1/4" probe ø6x40mm cable length 1.4m		



GEV No.	379331	Ref. No.	32V5750
description	temperature probe Pt1000 cable PTFE probe -70 up to +500°C cable -40 up to +250°C connection 2-wire thread M10x1 probe ø3x60mm cable length 0.7m		
For models:	091FR1EX, 091FR1IA, 091FR1ID, 091FR1ID-VERS.052012, 10CP1EA, 10CP1GA, 10CP1IA, 12CP1EA, 12CP1GA, 12CP1IA, 18CP2EA, 18CP2GA, 18CP2IA, 191FR2ED, 191FR2ID, 191FR2ID-VERS.092012, BX101E, BX101E-VERS.122013, BX101G, BX101G-VERS.122013, BX122E, BX122E-VERS.122013, BX122G, BX122G-VERS.122013, BX61E, BX61E-VERS.122013, BX61G, BX61G-VERS.122013, BX82E, BX82E-VERS.122013, BX82G, BX82G-VERS.122013, FM1011E1, FM1011E1-VERS.2006, FM1011E2, FM1011E2-VERS.2006, FM1011E3, FM1011E3-VERS.2006, FM1011G1, FM1011G1-VERS.2006, FM1011G2, FM1011G2-VERS.2006, FM1011G3, FM1011G3-VERS.2006, FM1221E1, FM1221E1-VERS.2006, FM1221E2, FM1221E2-VERS.2006, FM1221E3, FM1221E3-VERS.2006...(Other models you can see in the webshop)		

GEV No.	378647	Ref. No.	32V5760
description	temperature probe Pt1000 cable Vetrotex probe -70 up to +500°C cable -50 up to +350°C connection 2-wire thread M10x1 probe ø3x100mm cable length 1m		
For models:	091FR1EA, 091FR1ED, 091FR7GS, 091FR7GX, 191FR2ED, FM1011E1, FM1011E1-VERS.2006, FM1011E2, FM1011E2-VERS.2006, FM1011E3, FM1011E3-VERS.2006, FM1011G1, FM1011G1-VERS.2006, FM1011G2, FM1011G2-VERS.2006, FM1011G3, FM1011G3-VERS.2006, FM1221E1, FM1221E1-VERS.2006, FM1221E2, FM1221E2-VERS.2006, FM1221E3, FM1221E3-VERS.2006, FM1221G1, FM1221G1-VERS.2006, FM1221G2, FM1221G2-VERS.2006, FM1221G3, FM1221G3-VERS.2006, FM2011E2-VERS.2006, FM2011E3-VERS.2006, FM2011G2-VERS.2006, FM2011G3-VERS.2006, FM2021E1, FM2021E2, FM2021E2-VERS.2006, FM2021E3, FM2021E3-VERS.2006, FM2021G1, FM2021G2, FM2021G2-VERS.2006, FM2021G3, FM2021G3-VERS.2006, FM611E1, FM611E1-VERS.2006, FM611E2, FM611E2-VERS.2006, FM611E3, FM611E3-VERS.2006, FM611G1...(Other models you can see in the webshop)		

GEV No.	379789	Ref. No.	3104950
description	temperature probe thermocouple J (Fe-CuNi) cable glass fibre probe -50 up to +750°C cable -50 up to +350°C connection male faston 2.8mm thread probe ø4x40mm cable length 1m		
For models:	04WPBEV, 08WPBEV, 08WTPVEV, 090PEB, 091PEB, 190PEB, 190TPE, 191PEB, 191TPE		

GEV No.	379910	Ref. No.	32V0030
description	temperature probe thermocouple J (Fe-CuNi) cable silicone probe -50 up to +1150°C cable -50 up to +180°C connection male faston 2.8mm thread M10x1 probe ø4/6x72mm cable length 0.6m		
For models:	04WFR3ED, 06WFR3GD, 091FR1ED, 091FR1GD, 091FR3ED, 091FR3GD, 0A1FR1ED, 0A1FR1GD, 0A1FR1GD-VERS.2004, 0A1FR3ED, 0A1FR3GD, 0B1FR1GD, 0D1FR1ED, 0D1FR1GD, 0D1FR1GD-VERS.2004, 0D1FR3ED, 0D1FR3GD, 0G0FR3ED, 0G1FR3GD, 10WFR4GD, 191FR2ED, 191FR2G, 191FR2GD, 191FR4ED, 191FR4GD, 1A1FR2ED, 1A1FR2GD, 1A1FR2GD-VERS.2004, 1A1FR4ED, 1A1FR4GD, 1D1FR2ED, 1D1FR2GD, 1D1FR2GD-VERS.2004, 1D1FR4ED, 1D1FR4GD, 1G1FR4GD, 6FR		

core probes

GEV No.	378550	Ref. No.	32V8360
description	core temperature probe NTC 10kOhm cable silicone probe -40 up to +120°C cable -50 up to +180°C connection 2-wire probe ø4.5x100mm thread cable length 3.8m handle ø 16mm handle length 120mm		
For models:	DS31, DS31A, DS31C, DS31M, DS351H, DS51, DS51A, DS51C, DS51M		

GEV No.	379933	Ref. No.	32Z1982 32Z1983
description	core temperature probe Pt100 cable PTFE probe -40 up to +250°C cable -40 up to +250°C connection 3-wire probe ø2.5x100mm thread cable length 2.75m handle ø 15mm handle length 90mm		
For models:	FCV101DM, FCV101DM-CSA, FCV101DS, FCV101DS-CSA, FCV101EDM, FCV101EDM-UL, FCV101EDS, FCV101EDS-UL, FCV141DM, FCV141DM-CSA, FCV141DS, FCV141DS-CSA, FCV141EDM, FCV141EDS, FCV241DM, FCV241DS, FCV241EDM, FCV241EDM-UL, FCV241EDS, FCV241EDS-UL, FCV241GDM, FCV241GDS, FCV241GDS-CSA, FCV401DM, FCV401DM-CSA, FCV401EDM, FCV401EDM-UL, FCV4EDS, FCV61DM, FCV61DM-CSA, FCV61DS, FCV61DS-CSA, FCV61EDM, FCV61EDM-UL, FCV61EDS, FCV61EDS-UL, FCV72EDM-UL, FCV72EDS-UL		

GEV No.	379891	Ref. No.	32Z6830
description	core temperature probe Pt100 cable silicone probe -40 up to +120°C cable -50 up to +180°C connection 3-wire probe ø3.5-5.5x100mm thread cable length 1.85m handle ø 12mm handle length 100mm		

GEV No.	378402 ¹	Ref. No.	32V7960
description	core temperature probe Pt100 cable silicone probe -40 up to +120°C cable -50 up to +180°C connection 5-wire probe ø5x175mm thread cable length 3.5m handle ø 16mm handle length 125mm		
For models:	FS611, IA101L, IA101S, IA51, IA51A, IA51C, IA51M, IA72S, IS101L, IS101LR, IS101LW, IS101S, IS101SR, IS101SW, IS102S, IS102SR, IS102SR-ONR01, IS102SW, IS51, IS51A, IS51AR, IS51C, IS51CR, IS51H, IS51HW, IS51M, IS51MR, IS51R, ISS1W, IS51WA, IS51WC, IS51WM, IS72S, IS72SR, IS72SW, ISFEB, ISFEB-OPR01, ISFEN, ISFEN-OPR01, ISP202R, ISR201R, ISR202R		

¹multipoint probe





			
GEV No.	379890	Ref. No.	32Z6010
description	core temperature probe Pt100 cable SS corrugated hose probe -40 up to +250°C cable -40 up to +250°C connection 2-wire probe ø4x-100mm thread M16x1.5 cable length 1.6m handle ø 8.5mm handle length 100mm		

			
GEV No.	403452	Ref. No.	6300643
description	core temperature probe Pt1000 cable PTFE probe -40 up to +250°C cable -40 up to +250°C connection 2-wire probe ø3x100mm thread cable length 3.2m handle ø 13mm handle length 60mm		
For models:	FM1011E2-VERS.2006, FM1011G2-VERS.2006, FM1221E2-VERS.2006, FM1221G2-VERS.2006, FM2011E2-VERS.2006, FM2011G2-VERS.2006, FM611E2-VERS.2006, FM611G2-VERS.2006, FM721E2-VERS.2006, FM721G2-VERS.2006		

			
GEV No.	401966	Ref. No.	6300644
description	core temperature probe Pt1000 cable PTFE probe -40 up to +250°C cable -40 up to +250°C connection 3-wire probe ø3x100mm thread cable length 1.5m handle ø 13mm handle length 75mm		
For models:	FM1011E3-VERS.2006, FM1011G3-VERS.2006, FM1221E3-VERS.2006, FM1221G3-VERS.2006, FM2011E3-VERS.2006, FM2011G3-VERS.2006, FM2021E3-VERS.2006, FM2021G3-VERS.2006, FM611E3-VERS.2006, FM611G3-VERS.2006, FM721E3-VERS.2006, FM721G3-VERS.2006		

			
GEV No.	378264	Ref. No.	3159510 3159511 3200361
description	core temperature probe Pt1000 cable PTFE probe -40 up to +250°C cable -40 up to +250°C connection 5-wire probe ø3x100mm thread cable length 2.7m handle ø 13mm handle length 75mm		
For models:	FM1011E3, FM1011G3, FM1221E3, FM1221G3, FM2021E3, FM2021G3, FM611E3, FM611G3, FM721E3, FM721G3		

			
GEV No.	379588	Ref. No.	3139610 32V5940
description	core temperature probe Pt1000 cable thermoplastic probe -40 up to +250°C cable -40 up to +110°C connection 2-wire probe ø3x110mm thread cable length 3.1m handle ø 13mm handle length 70mm		
For models:	FM1011E2, FM1011G2, FM1221E2, FM1221G2, FM2021E2, FM2021G2, FM423E2, FM611E2, FM611G2, FM721E2, FM721G2, FX101E2, FX101E2C, FX101E2C-VERS.032014, FX101E2R, FX101E2R-VERS.032014, FX101E2-VERS.032014, FX101G2, FX101G2C, FX101G2C-VERS.032014, FX101G2R, FX101G2R-VERS.032014, FX101G2-VERS.032014, FX10E2CR, FX10E2CR-VERS.032014, FX10G2CR, FX10G2CR-VERS.032014, FX122E2, FX122E2C, FX122E2T, FX122E2T-VERS.032014, FX122G2, FX122G2C, FX122G2T, FX122G2T-VERS.032014, FX201E2, FX201E2P, FX201E2P-VERS.032014, FX201E2-VERS.032014, FX201G2, FX201G2P, FX201G2P-VERS.032014, FX201G2-VERS.032014, FX202E2, FX202E2-VERS.032014, FX202G2, FX202G2-VERS.032014, FX61E2, FX61E2C, FX61E2CR...(Other models you can see in the webshop)		

			
GEV No.	381511	Ref. No.	72378
description	core temperature probe Pt1000 connection 6-wire probe ø3.2x-100mm cable length 3.1m handle ø 13mm handle length 70mm combi-steamer		

			
GEV No.	378186	Ref. No.	32V0010 32V0441 32V8600
description	core temperature probe PTC 1kOhm cable silicone probe -40 up to +120°C cable -50 up to +180°C connection 2-wire probe ø4x90mm thread cable length 3.8m handle ø 15mm handle length 120mm L1 175mm L2 190mm		
For models:	ART1LD, ART1LD7, ART1LD7A, ART1LD7M, ART1LDA, ART2LD, ART2SD, ART3SD, SM14SR, SM1L, SM1L7, SM1L7A, SM1L7FCV, SM1L7M, SM1LA, SM1LAR, SM1LAT, SM1LAW, SM1LR, SM1LT, SM1LT7, SM1LT7A, SM1LT7M, SM1LW, SM2L, SM2LR, SM2LW, SM2S, SM2SR, SM2SW, SM3S, SM3SR, SM4SR, SM7SR		

accessories

screw connections

			
GEV No.	401967	Ref. No.	3004870
description	screw connection for core temperature probe		
For models:	FM1011E2, FM1011E2-VERS.2006, FM1011E3, FM1011E3-VERS.2006, FM1011G2, FM1011G2-VERS.2006, FM1011G3, FM1011G3-VERS.2006, FM1221E2, FM1221E2-VERS.2006, FM1221E3, FM1221E3-VERS.2006, FM1221G2, FM1221G2-VERS.2006, FM1221G3, FM1221G3-VERS.2006, FM2011E2-VERS.2006, FM2011E3-VERS.2006, FM2011G2-VERS.2006, FM2011G3-VERS.2006, FM2021E2, FM2021E2-VERS.2006, FM2021E3, FM2021E3-VERS.2006, FM2021G2, FM2021G2-VERS.2006, FM2021G3, FM2021G3-VERS.2006, FM611E2, FM611E2-VERS.2006, FM611E3, FM611E3-VERS.2006, FM611G2, FM611G2-VERS.2006, FM611G3, FM611G3-VERS.2006, FM721E2, FM721E2-VERS.2006, FM721E3, FM721E3-VERS.2006, FM721G2, FM721G2-VERS.2006, FM721G3, FM721G3-VERS.2006, FX101E2, FX101E2C, FX101E3, FX101E3C, FX101E3R, FX101G2...(Other models you can see in the webshop)		

miscellaneous

			
GEV No.	519385	Ref. No.	3150220
description	gasket for core temperature probe ED ø 8mm ID ø 4mm thickness 5mm		
For models:	FCV101DM, FCV101DM-CSA, FCV101DS, FCV101DS-CSA, FCV101EDM, FCV101EDM-UL, FCV101EDS, FCV101EDS-UL, FCV141DM, FCV141DM-CSA, FCV141DS, FCV141DS-CSA, FCV141EDM, FCV141EDS, FCV241DM, FCV241DS, FCV241EDM, FCV241EDM-UL, FCV241EDS, FCV241EDS-UL, FCV241GDM, FCV241GDM-CSA, FCV241GDS, FCV241GDS-CSA, FCV401DM, FCV401DM-CSA, FCV401EDM, FCV401EDM-UL, FCV4EDS, FCV61DM, FCV61DM-CSA, FCV61DS, FCV61DS-CSA, FCV61EDM, FCV61EDM-UL, FCV61EDS, FCV61EDS-UL, FCV72EDM-UL, FCV72EDS-UL, FM1011E2, FM1011E3, FM1011G2, FM1011G3, FM1221E2, FM1221E3, FM1221G2, FM1221G3, FM2021E2, FM2021E3, FM2021G2...(Other models you can see in the webshop)		

			
1			
GEV No.	691159	Ref. No.	35Q6360
description	protective plate for probe		
For models:	FC101, FC101E, FC241, FC241E, FC241G, FC61, FC61E, FCV101, FCV101-CSA, FCV101DM, FCV101DM-CSA, FCV101DS, FCV101DS-CSA, FCV101E, FCV101EDM, FCV101EDM-UL, FCV101EDS, FCV101EDS-UL, FCV101E-UL, FCV141, FCV141-CSA, FCV141DM, FCV141DM-CSA, FCV141DS, FCV141DS-CSA, FCV141E, FCV141EDM, FCV141EDS, FCV241, FCV241DM, FCV241DS, FCV241E, FCV241EDM, FCV241EDM-UL, FCV241EDS, FCV241EDS-UL, FCV241E-UL, FCV241G, FCV241G-CSA, FCV241GDM, FCV241GDM-CSA, FCV241GDS, FCV241GDS-CSA, FCV401DM, FCV401DM-CSA, FCV401EDM, FCV401EDM-UL, FCV4E, FCV4EDS, FCV61...(Other models you can see in the webshop)		

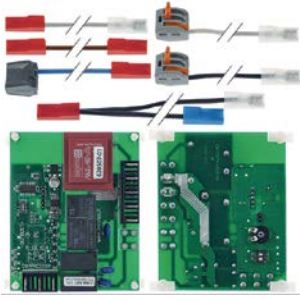
			
1			
GEV No.	403687	Ref. No.	3034260 32V4350
description	electronic timer for ice maker Simag mounting measurements 90x70mm 230		
For models:	PG22C, PG23C, PG23CW, PG24CW, PG30C, PG31CW, PG42C, PG43CW, PG60C, PG61CW, PG80C, PG81CW, PGC132, PGC134W, PGC210, PGC212W		

electronics

PCBs

			
1			
GEV No.	400677	Ref. No.	32V0780
description	control PCB fryer 091FR1 ED		
For models:	04WFR3ED, 06WFR3GD, 08WFR4ED, 091FR1ED, 091FR1GD, 091FR3ED, 091FR3GD, 0A1FR1ED, 0A1FR1GD, 0A1FR1GD-VERS.2004, 0A1FR3ED, 0A1FR3GD, 0B1FR1GD, 0D1FR1ED, 0D1FR1GD, 0D1FR1GD-VERS.2004, 0D1FR3ED, 0D1FR3GD, 0G0FR3ED, 0G1FR3GD, 10WFR4GD, 191FR2ED, 191FR2GD, 191FR4ED, 191FR4GD, 1A1FR2ED, 1A1FR2GD, 1A1FR2GD-VERS.2004, 1A1FR4ED, 1A1FR4GD, 1D1FR2ED, 1D1FR2GD, 1D1FR2GD-VERS.2004, 1D1FR4ED, 1D1FR4GD, 1G1FR4GD		

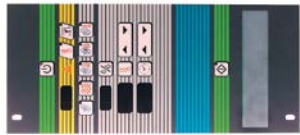
			
1			
GEV No.	401183	Ref. No.	32Z6621 32Z6622
description	keypad PCB		
For models:	FCV4E		

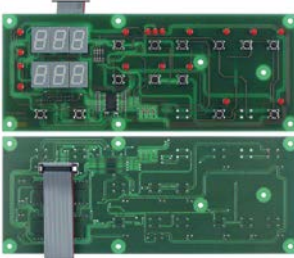
			
1			
GEV No.	403729	Ref. No.	32V3060
description	control PCB L 203mm W 80mm		
For models:	SM2L, SM2LR, SM2LW, SM2S, SM2SR, SM2SW, SM3S, SM3SR, SM4SR, SM7SR		

			
1			
GEV No.	401184	Ref. No.	32Z1081 32Z1082
description	keypad PCB		
For models:	FCV4EDS		

			
1			
GEV No.	401748	Ref. No.	3049200
description	keypad PCB		
For models:	IS101LR, IS101SR, IS102SR, IS102SR-ONR01, IS51AR, IS51CR, IS51MR, IS51R, IS72SR		

1

GEV No.	401750	Ref. No.	32Z8940
description	keypad PCB		
For models:	SM2L, SM2LR, SM2LW, SM2S, SM2SR, SM2SW, SM3S, SM3SR, SM4SR		



1

GEV No.	401749	Ref. No.	32Z9640
description	PCB		
For models:	SM1L, SM1LA, SM1LAR, SM1LAW, SM1LR, SM1LW, SM2L, SM2LR, SM2LW, SM2S, SM2SR, SM2SW, SM3S, SM3SR, SM4SR		



1

GEV No.	401751	Ref. No.	32Z8240
description	keypad PCB		
For models:	SM1L, SM1LA, SM1LAR, SM1LAW, SM1LR, SM1LW		



1

GEV No.	402866	Ref. No.	32V5360 32V5361
description	PCB combi-steamer FM1011 suitable for ANGELO PO		
For models:	FM1011E1, FM1011E1-VERS.2006, FM1011E2, FM1011E2-VERS.2006, FM1011E3, FM1011G1, FM1011G1-VERS.2006, FM1011G2, FM1011G2-VERS.2006, FM1011G3, FM1221E1, FM1221E1-VERS.2006, FM1221E2, FM1221E2-VERS.2006, FM1221E3, FM1221G1, FM1221G1-VERS.2006, FM1221G2, FM1221G2-VERS.2006, FM1221G3, FM2011E2-VERS.2006, FM2011G2-VERS.2006, FM2021E1, FM2021E2, FM2021E2-VERS.2006, FM2021G1, FM2021G2, FM2021G2-VERS.2006, FM611E1, FM611E1-VERS.2006, FM611E2, FM611E2-VERS.2006, FM611E3, FM611G1, FM611G1-VERS.2006, FM611G2, FM611G2-VERS.2006, FM611G3, FM721E1, FM721E1-VERS.2006, FM721E2, FM721E2-VERS.2006, FM721G1, FM721G1-VERS.2006, FM721G2, FM721G2-VERS.2006		





1

GEV No.	402867	Ref. No.	3018770 3018771
description	keypad PCB combi-steamer FM1011 L 275mm W 100mm suitable for ANGELO PO buttons 12		
For models:	FM1011E1, FM1011E2, FM1011E3, FM1011G1, FM1011G2, FM1011G3, FM1221E1, FM1221E2, FM1221E3, FM1221G1, FM1221G2, FM1221G3, FM2021E1, FM2021E2, FM2021E3, FM2021G1, FM2021G2, FM2021G3, FM611E1, FM611E2, FM611E3, FM611G1, FM611G2, FM611G3, FM721E1, FM721E2, FM721E3, FM721G1, FM721G2, FM721G3		



1

GEV No.	402675	Ref. No.	3104130
description	PCB dishwasher KD60 L 185mm W 30mm buttons 4		
For models:	KD40EPSD, KD40LEPS, KD40LUXE, KD60E, KD60EAT, KD60ME, KD85E, KD85EA, KD85EAT, KD85EPS, KD85EPSA, LP70		
accessories for	402675		
	GEV No.	400066	Ref. No. 3099170
	ribbon cable 10-pole L 1000mm plug type FC-10P raster size 2.54mm		



1

GEV No.	401218	Ref. No.	32Z6210 32Z6211
description	PCB		
For models:	FCV101, FCV101E, FCV141, FCV141E, FCV241, FCV241E, FCV241G, FCV3EM, FCV4EM, FCV61, FCV61E		



1

GEV No.	401029	Ref. No.	3026600 3114850
description	PCB dishwasher LF 50 L 122mm W 80mm Qty 1 pcs		
For models:	LF50EM, LF50EMPS, LF50E-VERS.2007		

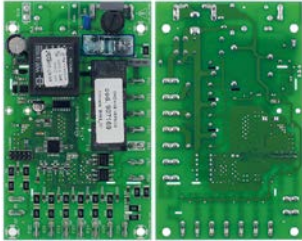

1

GEV No.	403255	Ref. No.	3207870
description	PCB dishwasher N700/NE1300/S026/S030 L 135mm W 82mm		
For models:	LF50EM, LF50EMPS, LF50EMPS-VERS.122012, LF50EM-VERS.122012, LF50E-VERS.122012, LF50E-VERS.2007		



1

GEV No.	404028	Ref. No.	6300751
description	PCB for combi-steamer ANGELO PO L 140mm W 100mm		
For models:	BX101G, BX101G-VERS.122013, BX122G, BX122G-VERS.122013, BX61G, BX61G-VERS.122013, BX82G, BX82G-VERS.122013, FX101G1, FX101G1R, FX101G2, FX101G2C, FX101G2C-VERS.032014, FX101G2R, FX101G2R-VERS.032014, FX101G2-VERS.032014, FX101G3, FX101G3C, FX101G3C-VERS.022014, FX101G3R, FX101G3R-VERS.022014, FX101G3-VERS.022014, FX10G2CR, FX10G2CR-VERS.032014, FX10G3CR, FX10G3CR-VERS.022014, FX122G1, FX122G2, FX122G2C, FX122G2T, FX122G2T-VERS.032014, FX122G3, FX122G3C, FX122G3T, FX122G3T-VERS.022014, FX12G3CT, FX12G3CT-VERS.022014, FX201G2, FX201G2P, FX201G2P-VERS.032014, FX201G2-VERS.032014, FX201G3P, FX201G3-VERS.022014, FX202G2, FX202G2-VERS.032014, FX202G3, FX202G3-VERS.022014, FX61G1, FX61G1R, FX61G2...(Other models you can see in the webshop)		



1

GEV No.	400678	Ref. No.	32Z9090
description	PCB fryer 091FR1 ED 230V		
For models:	04WFR3ED, 06WFR3GD, 08WFR4ED, 091FR1ED, 091FR1GD, 091FR3ED, 091FR3GD, 0A1FR1ED, 0A1FR1GD, 0A1FR1GD-VERS.2004, 0A1FR3ED, 0A1FR3GD, 0B1FR1GD, 0D1FR1ED, 0D1FR1GD, 0D1FR1GD-VERS.2004, 0D1FR3ED, 0D1FR3GD, 0G0FR3ED, 0G1FR3GD, 10WFR4GD, 191FR2ED, 191FR2GD, 191FR4ED, 191FR4GD, 1A1FR2ED, 1A1FR2GD, 1A1FR2GD-VERS.2004, 1A1FR4ED, 1A1FR4GD, 1D1FR2ED, 1D1FR2GD, 1D1FR2GD-VERS.2004, 1D1FR4ED, 1D1FR4GD, 1G1FR4GD		





1

GEV No.	402978	Ref. No.	3184480
description	PCB L 73mm W 73mm timer		
For models:	PG22C, PG23C, PG23CW, PG24CW, PG30C, PG31CW, PG42C, PG43CW, PG60C, PG61CW		



1

GEV No.	400955	Ref. No.	3019810	
description	PCB slicer 230/400V			
For models:	STV			
accessories for	400955			
	GEV No.	401357	Ref. No.	—
	momentary push switch mounting measurements ø22mm 1NO/1NC/indicator light 400V 4A indicator lamp 24V 0-1 connection screw ambient temperature max. 125/55°C protection IP40			
	GEV No.	401709	Ref. No.	—
	protective cover external size 57x32mm internal size 47x22mm matt finish rubber H 27.5mm			



1

GEV No.	403575	Ref. No.	32Z7090
description	PCB slicer L 128mm W 43mm 230-400V		
For models:	AFC30MS, AFC30S, AFC35, AFT30S, AFT30VMS, AFT30VS, AFT33S, AFT35, AFT35VS		



1

GEV No.	400954	Ref. No.	3069870
description	PCB slicer/cutter 50/60Hz 230V		
For models:	SC9VV, STV		

1

GEV No.	401747	Ref. No.	32V8030
description	power PCB for blast chiller SERIE IM suitable for SAGI		
For models:	FS611, IS101L, IS101LW, IS101S, IS101SW, IS102S, IS102SR, IS102SW, IS51, IS51A, IS51C, IS51H, IS51HW, IS51M, IS51W, IS51WA, IS51WC, IS51WM, IS72S, IS72SW, ISFEB, ISFEB-OPR01, ISFEN, ISFEN-OPR01		

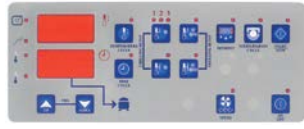

1

GEV No.	378403	Ref. No.	37N0480
description	front foil blast freezer SAGI		
For models:	SM2L, SM2LR, SM2LW, SM2S, SM2SR, SM2SW, SM3S, SM3SR, SM4SR, SM7SR		

keypads

front foils



1

GEV No.	401180	Ref. No.	37M4201
description	front foil		
For models:	FC101, FC101E, FC241, FC241E, FC241G, FC61, FC61E		

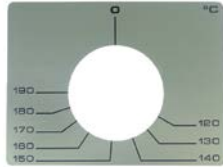

1

GEV No.	401639	Ref. No.	37M5670
description	front foil L 115mm W 87mm		



1

GEV No.	401181	Ref. No.	37M9220
description	front foil		
For models:	FCV3EM, FCV4EM		

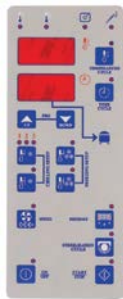

1

GEV No.	401956	Ref. No.	37N0470
description	keypad foil		
For models:	SM14SR, SM1L, SM1L7, SM1L7A, SM1L7FCV, SM1L7M, SM1LA, SM1LAR, SM1LAW, SM1LR, SM1LW		



1

GEV No.	401182	Ref. No.	37M5641
description	front foil		
For models:	FCV101, FCV101E, FCV141, FCV141E, FCV241, FCV241E, FCV241G, FCV61, FCV61E		



1

GEV No.	400676	Ref. No.	37M8560
description	keypad foil for fryer L 97mm W 60mm		
For models:	04WFR3ED, 06WFR3GD, 08WFR4ED, 091FR1ED, 091FR1GD, 091FR3ED, 091FR3GD, 0A1FR1ED, 0A1FR1GD, 0A1FR1GD-VERS.2004, 0A1FR3ED, 0A1FR3GD, 0B1FR1GD, 0D1FR1ED, 0D1FR1GD, 0D1FR1GD-VERS.2004, 0D1FR3ED, 0D1FR3GD, 0G0FR3ED, 0G1FR3GD, 10WFR4GD, 191FR2ED, 191FR2GD, 191FR4ED, 191FR4GD, 1A1FR2ED, 1A1FR2GD, 1A1FR2GD-VERS.2004, 1A1FR4ED, 1A1FR4GD, 1D1FR2ED, 1D1FR2GD, 1D1FR2GD-VERS.2004, 1D1FR4ED, 1D1FR4GD, 1G1FR4GD		



1

GEV No.	511927	Ref. No.	37M1610
description	keypad foil for potato peeler device silver L 175mm W 61mm buttons 3		
For models:	P10, P10M, P20		



solenoid valves

solenoid valves (water)



GEV No.	401752	Ref. No.	37M7330
description	keypad foil SAGI suitable for for ice maker L 200mm W 60mm buttons 8		
For models:	SM1L, SM1LA, SM1LAR, SM1LAW, SM1LR, SM1LW		



GEV No.	403029	Ref. No.	37N5560
description	keypad foil suitable for ANGELO PO L 210mm buttons 6		
For models:	DS31, DS31A, DS31C, DS31M, DS51, DS51A, DS51C, DS51M, IA101L, IA101S, IA51, IA51A, IA51C, IA51M, IA72S, IS101L, IS101LR, IS101LW, IS101S, IS101SR, IS101SW, IS102S, IS102SR, IS102SW, IS51, IS51A, IS51AR, IS51C, IS51CR, IS51H, IS51HW, IS51M, IS51MR, IS51R, IS51W, IS51WA, IS51WC, IS51WM, IS72S, IS72SR, IS72SW, ISP202R, ISR201R, ISR202R		

membrane keypads



GEV No.	402027	Ref. No.	37M7340
description	membrane keypad for blast freezer buttons 8 suitable for SAGI L 200mm W 60mm		
For models:	SM2L, SM2LR, SM2LW, SM2S, SM2SR, SM2SW, SM3S, SM3SR, SM4SR		

keypad units



GEV No.	403002	Ref. No.	3018180
description	keypad unit slicer buttons 2 MIRRA/SAN-DANIELE/YORK L 120mm W 48mm		
For models:	SC4, SC6, SC9VV, STV		
accessories for	403002		
	GEV No.	403004	Ref. No. —
gasket for keypad housing L 122mm W 52mm			

ELBI

straight



GEV No.	374053	Ref. No.	3032680
description	solenoid valve single straight 230VAC inlet 3/4" outlet 11.5mm t.max. 60°C ELBI plastic flow regulating valve outlet orange		
For models:	BX101E, BX101E-VERS.122013, BX101G, BX101G-VERS.122013, BX122E, BX122E-VERS.122013, BX122G, BX122G-VERS.122013, BX61E, BX61E-VERS.122013, BX61G, BX61G-VERS.122013, BX82E, BX82E-VERS.122013, BX82G, BX82G-VERS.122013, FM1011E1, FM1011E1-VERS.2006, FM1011E2, FM1011E2-VERS.2006, FM1011E3, FM1011E3-VERS.2006, FM1011G1, FM1011G1-VERS.2006, FM1011G2, FM1011G2-VERS.2006, FM1011G3, FM1011G3-VERS.2006, FM1221E1, FM1221E1-VERS.2006, FM1221E2, FM1221E2-VERS.2006, FM1221E3, FM1221E3-VERS.2006, FM1221G1, FM1221G1-VERS.2006, FM1221G2, FM1221G2-VERS.2006, FM1221G3, FM1221G3-VERS.2006, FM2021E1, FM2021E2, FM2021G1, FM2021G2, FM423E2, FM611E1, FM611E1-VERS.2006, FM611E2, FM611E2-VERS.2006, FM611E3...(Other models you can see in the webshop)		

spare parts for	374053		
	GEV No.	370467	Ref. No. N/A
solenoid valve filter suitable for ELBI			























GEV No.	370431	Ref. No.	33D2780
description	solenoid valve single straight 230VAC inlet 3/4" outlet 11.5mm input/min output 2l/min DN10 t.max. 90°C ELBI plastic		
For models:	PGC132, PGC132-VERS.200911, PGC134W, PGC134W-VERS.200911, PGC210, PGC210-VERS.200911, PGC212W, PGC212W-VERS.200911		



MÜLLER

medium temperature: 90°C
duty cycle: 100%

 <p>1</p>			
GEV No.	370158	Ref. No.	33D1710 33D2410
description	solenoid valve double straight 230VAC inlet 3/4" outlet 11.5mm DN10 t.max. 90°C duty cycle 100% MÜLLER		
For models:	FC101, FC101E, FC241E, FC241G, FC61, FC61E, FCV101, FCV101-CSA, FCV101DM, FCV101DM-CSA, FCV101DS, FCV101DS-CSA, FCV101E, FCV101EDM, FCV101EDM-UL, FCV101EDS, FCV101EDS-UL, FCV101E-UL, FCV141, FCV141-CSA, FCV141DM, FCV141DM-CSA, FCV141DS, FCV141DS-CSA, FCV141E, FCV141EDM, FCV141EDS, FCV241E, FCV241EDM, FCV241EDM-UL, FCV241EDS, FCV241EDS-UL, FCV241E-UL, FCV241G, FCV241G-CSA, FCV241GDM, FCV241GDM-CSA, FCV241GDS, FCV241GDS-CSA, FCV401DM, FCV401DM-CSA, FCV401EDM, FCV401EDM-UL, FCV61, FCV61-CSA, FCV61DM, FCV61DM-CSA, FCV61DS, FCV61DS-CSA, FCV61E...(Other models you can see in the webshop)		
spare parts for	370158		
	GEV No.	370195	Ref. No. —
	solenoid valve body double straight inlet 3/4" outlet 11.5mm DN10 t.max. 90°C duty cycle 100% MÜLLER 230V		
	GEV No.	371002	Ref. No. —
	solenoid valve holder MÜLLER flange support		
	GEV No.	371009	Ref. No. —
	compression spring for solenoid coil		
	GEV No.	371011	Ref. No. —
	spare parts kit membrane with long star star hight 8mm MÜLLER		
	GEV No.	371017	Ref. No. —
	solenoid coil MÜLLER 230VAC connection male faston 6.3mm		
	GEV No.	371122	Ref. No. —
	solenoid valve filter ø 19mm H 10mm suitable for MÜLLER		
accessories for	370158		
	GEV No.	371010	Ref. No. —
	solenoid coil 230VAC connection with cable cable length 2000mm		
	GEV No.	371037	Ref. No. —
	solenoid coil 24VAC 50/60Hz connection male faston 6.3mm		
	GEV No.	371038	Ref. No. —
	solenoid coil 230VAC connection appliance plug		

 <p>1</p>			
GEV No.	370117	Ref. No.	33D2460
description	solenoid valve single straight 230VAC inlet 3/4" outlet 11.5mm DN10 t.max. 90°C duty cycle 100% MÜLLER		
For models:	FM1011E3, FM1011G3, FM1221E1, FM1221E2, FM1221E3, FM1221G1, FM1221G2, FM1221G3, FM611E3, FM611G3, FM721E1, FM721E2, FM721E3, FM721G1, FM721G2, FM721G3		
spare parts for	370117		
	GEV No.	370133	Ref. No. —
	solenoid valve body single straight inlet 3/4" outlet 11.5mm DN10 t.max. 90°C duty cycle 100% MÜLLER 230V		
	GEV No.	371002	Ref. No. —
	solenoid valve holder MÜLLER flange support		
	GEV No.	371009	Ref. No. —
	compression spring for solenoid coil		
	GEV No.	371011	Ref. No. —
	spare parts kit membrane with long star star hight 8mm MÜLLER		
	GEV No.	371017	Ref. No. —
	solenoid coil MÜLLER 230VAC connection male faston 6.3mm		
	GEV No.	371122	Ref. No. —
	solenoid valve filter ø 19mm H 10mm suitable for MÜLLER		
	GEV No.	501161	Ref. No. —
	tap head for solenoid valve holder for solenoid coils		
accessories for	370117		
	GEV No.	371010	Ref. No. —
	solenoid coil 230VAC connection with cable cable length 2000mm		
	GEV No.	371037	Ref. No. —
	solenoid coil 24VAC 50/60Hz connection male faston 6.3mm		
	GEV No.	371038	Ref. No. —
	solenoid coil 230VAC connection appliance plug		

ROBERTSHAW/INVENSYS

medium temperature: 90°C 90°C 60°C
 ambient temperature: 60°C 25°C 60°C
 duty cycle: 40% 100% 100%

spare parts and accessories

reducers

outlet side



GEV No.	371255	Ref. No.	N/A
description	reducer type EATON (INVENSYS) flow rate 5l/min pressure range 0 up to 10bar tolerance ±15/25% black		

RPE



GEV No.	374017	Ref. No.	33D2310 33D3260
description	solenoid valve single straight 230VAC inlet 3/4" outlet 10mm input 6l/min DN10 RPE polyamide flow regulating valve inlet white membranes NBR pressure range 0.2-10bar		



GEV No.	374015	Ref. No.	33D3280
description	solenoid valve single angled 230VAC inlet 3/4" outlet 10mm input 10-12l/min DN10 RPE flow regulating valve inlet white		
For models:	KD100, KD100A, KD100PSD, KD130, KD130A, KD130E, KD130EAT, KD85, KD85A, KD85PS, KD85PSA, KN1100, KN1100SD, KN11PSDD, KN800, KN800PSD, LP151		





TP















GEV No.	370021	Ref. No.	33D1640 33D1641 33D3250
description	solenoid valve double straight 230VAC inlet 3/4" outlet 11.5mm DN10 TP flow regulating valve inlet white		
For models:	FC101, FC101E, FC241, FC241E, FC241G, FC61, FC61E, FCV101, FCV101DM, FCV101DS, FCV101E, FCV101EDM, FCV101EDS, FCV141, FCV141DM, FCV141DS, FCV141E, FCV141EDM, FCV141EDS, FCV241, FCV241DM, FCV241DS, FCV241E, FCV241EDM, FCV241EDS, FCV241G, FCV241GDM, FCV241GDS, FCV3EM, FCV401DM, FCV401EDM, FCV4E, FCV4EDS, FCV4EM, FCV61, FCV61DM, FCV61DS, FCV61E, FCV61EDM, FCV61EDS, FM423E1, KD37, KD37PS, KD37-VERS.112009, KD40, KD40EPSD, KD40LEPS, KD40LSPS, KD40LUX, KD40LUXE...(Other models you can see in the webshop)		
accessories for	370021		
	GEV No.	371220	Ref. No. —
		reducer TP flow rate 3l/min red tolerance ±15%	
	GEV No.	371221	Ref. No. —
		reducer TP flow rate 5.5l/min yellow tolerance ±15%	
	GEV No.	371222	Ref. No. —
		reducer TP flow rate 6l/min grey tolerance ±15%	
	GEV No.	371223	Ref. No. —
		reducer TP flow rate 10l/min white tolerance ±15%	
	GEV No.	371224	Ref. No. —
		reducer TP flow rate 12l/min bronze tolerance ±15%	
	GEV No.	371225	Ref. No. —
		reducer TP flow rate 16l/min light brown tolerance ±15%	
	GEV No.	371226	Ref. No. —
		reducer TP flow rate 20l/min red tolerance ±15%	
	GEV No.	371230	Ref. No. —
		reducer TP flow rate 0.25l/min red tolerance ±25%	
	GEV No.	371231	Ref. No. —
		reducer TP flow rate 0.35l/min violet tolerance ±25%	
	GEV No.	371232	Ref. No. —
		reducer TP flow rate 0.5l/min orange tolerance ±25%	
	GEV No.	371233	Ref. No. —
		reducer TP flow rate 0.8l/min white tolerance ±25%	
	GEV No.	371234	Ref. No. —
		reducer TP flow rate 1l/min light blue tolerance ±25%	
	GEV No.	371235	Ref. No. —
		reducer TP flow rate 1.2l/min brown tolerance ±25%	

Table continues overleaf



accessories for		370021	
GEV No.	Ref. No.	GEV No.	Ref. No.
	371236	—	—
reducer TP flow rate 1.5l/min light brown tolerance ±25%			
	371237	—	—
reducer TP flow rate 2.5l/min yellow tolerance ±25%			
	371238	—	—
reducer TP flow rate 3.4l/min dark green tolerance ±25%			
	371239	—	—
reducer TP flow rate 5l/min black tolerance ±25%			
	371240	—	—
reducer TP flow rate 8l/min blue tolerance ±20%			

  1			
GEV No.	Ref. No.	GEV No.	Ref. No.
370017	33D1370 33D2310	—	—
description solenoid valve single straight 230VAC inlet 3/4" outlet 11.5mm DN10 TP p max 10bar			
spare parts for		370017	
	371013	—	—
solenoid coil TP 230VAC 50/60Hz			
accessories for		370017	
	371220	—	—
reducer TP flow rate 3l/min red tolerance ±15%			
	371221	—	—
reducer TP flow rate 5.5l/min yellow tolerance ±15%			
	371222	—	—
reducer TP flow rate 6l/min grey tolerance ±15%			
	371223	—	—
reducer TP flow rate 10l/min white tolerance ±15%			
	371224	—	—
reducer TP flow rate 12l/min bronze tolerance ±15%			
	371225	—	—
reducer TP flow rate 16l/min light brown tolerance ±15%			
	371226	—	—
reducer TP flow rate 20l/min red tolerance ±15%			
	371230	—	—
reducer TP flow rate 0.25l/min red tolerance ±25%			
	371231	—	—
reducer TP flow rate 0.35l/min violet tolerance ±25%			

accessories for		370017	
GEV No.	Ref. No.	GEV No.	Ref. No.
	371232	—	—
reducer TP flow rate 0.5l/min orange tolerance ±25%			
	371233	—	—
reducer TP flow rate 0.8l/min white tolerance ±25%			
	371234	—	—
reducer TP flow rate 1l/min light blue tolerance ±25%			
	371235	—	—
reducer TP flow rate 1.2l/min brown tolerance ±25%			
	371236	—	—
reducer TP flow rate 1.5l/min light brown tolerance ±25%			
	371237	—	—
reducer TP flow rate 2.5l/min yellow tolerance ±25%			
	371238	—	—
reducer TP flow rate 3.4l/min dark green tolerance ±25%			
	371239	—	—
reducer TP flow rate 5l/min black tolerance ±25%			
	371240	—	—
reducer TP flow rate 8l/min blue tolerance ±20%			





































  1			
GEV No.	Ref. No.	GEV No.	Ref. No.
370019	33D0290	—	—
description solenoid valve double angled 230VAC inlet 3/4" outlet 11.5mm DN10 TP plastic			
spare parts for		370019	
	371013	—	—
solenoid coil TP 230VAC 50/60Hz			
accessories for		370019	
	371220	—	—
reducer TP flow rate 3l/min red tolerance ±15%			
	371221	—	—
reducer TP flow rate 5.5l/min yellow tolerance ±15%			
	371222	—	—
reducer TP flow rate 6l/min grey tolerance ±15%			
	371223	—	—
reducer TP flow rate 10l/min white tolerance ±15%			
	371224	—	—
reducer TP flow rate 12l/min bronze tolerance ±15%			

Table continues overleaf

accessories for		370019		
	GEV No.	371225	Ref. No.	—
reducer TP flow rate 16l/min light brown tolerance ±15%				
	GEV No.	371226	Ref. No.	—
reducer TP flow rate 20l/min red tolerance ±15%				
	GEV No.	371230	Ref. No.	—
reducer TP flow rate 0.25l/min red tolerance ±25%				
	GEV No.	371231	Ref. No.	—
reducer TP flow rate 0.35l/min violet tolerance ±25%				
	GEV No.	371232	Ref. No.	—
reducer TP flow rate 0.5l/min orange tolerance ±25%				
	GEV No.	371233	Ref. No.	—
reducer TP flow rate 0.8l/min white tolerance ±25%				
	GEV No.	371234	Ref. No.	—
reducer TP flow rate 1l/min light blue tolerance ±25%				
	GEV No.	371235	Ref. No.	—
reducer TP flow rate 1.2l/min brown tolerance ±25%				
	GEV No.	371236	Ref. No.	—
reducer TP flow rate 1.5l/min light brown tolerance ±25%				
	GEV No.	371237	Ref. No.	—
reducer TP flow rate 2.5l/min yellow tolerance ±25%				
	GEV No.	371238	Ref. No.	—
reducer TP flow rate 3.4l/min dark green tolerance ±25%				
	GEV No.	371239	Ref. No.	—
reducer TP flow rate 5l/min black tolerance ±25%				
	GEV No.	371240	Ref. No.	—
reducer TP flow rate 8l/min blue tolerance ±20%				

  1				
GEV No.	370015	Ref. No.	33D1370 33D1371	
description	solenoid valve single angled 230VAC inlet 3/4" outlet 11.5mm DN10 TP			
accessories for		370015		
	GEV No.	371220	Ref. No.	—
reducer TP flow rate 3l/min red tolerance ±15%				
	GEV No.	371221	Ref. No.	—
reducer TP flow rate 5.5l/min yellow tolerance ±15%				
	GEV No.	371222	Ref. No.	—
reducer TP flow rate 6l/min grey tolerance ±15%				

accessories for		370015		
	GEV No.	371223	Ref. No.	—
reducer TP flow rate 10l/min white tolerance ±15%				
	GEV No.	371224	Ref. No.	—
reducer TP flow rate 12l/min bronze tolerance ±15%				
	GEV No.	371225	Ref. No.	—
reducer TP flow rate 16l/min light brown tolerance ±15%				
	GEV No.	371226	Ref. No.	—
reducer TP flow rate 20l/min red tolerance ±15%				
	GEV No.	371230	Ref. No.	—
reducer TP flow rate 0.25l/min red tolerance ±25%				
	GEV No.	371231	Ref. No.	—
reducer TP flow rate 0.35l/min violet tolerance ±25%				
	GEV No.	371232	Ref. No.	—
reducer TP flow rate 0.5l/min orange tolerance ±25%				
	GEV No.	371233	Ref. No.	—
reducer TP flow rate 0.8l/min white tolerance ±25%				
	GEV No.	371234	Ref. No.	—
reducer TP flow rate 1l/min light blue tolerance ±25%				
	GEV No.	371235	Ref. No.	—
reducer TP flow rate 1.2l/min brown tolerance ±25%				
	GEV No.	371236	Ref. No.	—
reducer TP flow rate 1.5l/min light brown tolerance ±25%				
	GEV No.	371237	Ref. No.	—
reducer TP flow rate 2.5l/min yellow tolerance ±25%				
	GEV No.	371238	Ref. No.	—
reducer TP flow rate 3.4l/min dark green tolerance ±25%				
	GEV No.	371239	Ref. No.	—
reducer TP flow rate 5l/min black tolerance ±25%				
	GEV No.	371240	Ref. No.	—
reducer TP flow rate 8l/min blue tolerance ±20%				



 1				
GEV No.	370031	Ref. No.	N/A	
description	solenoid valve single angled 24VAC inlet 3/4" outlet 14mm DN10 TP			
spare parts for		370031		
	GEV No.	371035	Ref. No.	—
solenoid coil 24VAC				

Table continues overleaf



accessories for		370031		
GEV No.	371220	Ref. No.	—	
	reducer TP flow rate 3l/min red tolerance ±15%			
	371221	Ref. No.	—	
reducer TP flow rate 5.5l/min yellow tolerance ±15%				
	371222	Ref. No.	—	
reducer TP flow rate 6l/min grey tolerance ±15%				
	371223	Ref. No.	—	
reducer TP flow rate 10l/min white tolerance ±15%				
	371224	Ref. No.	—	
reducer TP flow rate 12l/min bronze tolerance ±15%				
	371225	Ref. No.	—	
reducer TP flow rate 16l/min light brown tolerance ±15%				
	371226	Ref. No.	—	
reducer TP flow rate 20l/min red tolerance ±15%				
	371230	Ref. No.	—	
reducer TP flow rate 0.25l/min red tolerance ±25%				
	371231	Ref. No.	—	
reducer TP flow rate 0.35l/min violet tolerance ±25%				
	371232	Ref. No.	—	
reducer TP flow rate 0.5l/min orange tolerance ±25%				
	371233	Ref. No.	—	
reducer TP flow rate 0.8l/min white tolerance ±25%				
	371234	Ref. No.	—	
reducer TP flow rate 1l/min light blue tolerance ±25%				
	371235	Ref. No.	—	
reducer TP flow rate 1.2l/min brown tolerance ±25%				
	371236	Ref. No.	—	
reducer TP flow rate 1.5l/min light brown tolerance ±25%				
	371237	Ref. No.	—	
reducer TP flow rate 2.5l/min yellow tolerance ±25%				
	371238	Ref. No.	—	
reducer TP flow rate 3.4l/min dark green tolerance ±25%				
	371239	Ref. No.	—	
reducer TP flow rate 5l/min black tolerance ±25%				
	371240	Ref. No.	—	
reducer TP flow rate 8l/min blue tolerance ±20%				

solenoid valves with reducers

			
1			
GEV No.	370648	Ref. No.	3032670
description	solenoid valve double straight 220-240VAC inlet 3/4" input 10l/min DN10 TP outlet 11.5mm output A 3.4l/min flow regulating valve outlet A green		
For models:	10CP1EA, 10CP1GA, 10CP1IA, 12CP1EA, 12CP1GA, 12CP1IA, 18CP2EA, 18CP2GA, 18CP2IA, FC1011E, FC1011G, FC1221E, FC1221G, FC611E, FC611G, FM1011E2-VERS.2006, FM1011E3, FM1011E3-VERS.2006, FM1011G2-VERS.2006, FM1011G3, FM1011G3-VERS.2006, FM1221E2-VERS.2006, FM1221E3, FM1221E3-VERS.2006, FM1221G2-VERS.2006, FM1221G3, FM1221G3-VERS.2006, FM2011E2-VERS.2006, FM2011E3-VERS.2006, FM2011G2-VERS.2006, FM2011G3-VERS.2006, FM2021E1, FM2021E2, FM2021E2-VERS.2006, FM2021E3, FM2021E3-VERS.2006, FM2021G1, FM2021G2, FM2021G2-VERS.2006, FM2021G3, FM2021G3-VERS.2006, FM423E2, FM611E2-VERS.2006, FM611E3, FM611E3-VERS.2006, FM611G2-VERS.2006, FM611G3, FM611G3-VERS.2006, FM721E1-VERS.2006, FM721E2-VERS.2006...(Other models you can see in the webshop)		

metal



ASCO



spare parts and accessories

power sockets





			
1			
GEV No.	371093	Ref. No.	32A2330
description	power socket plug type compact cable length 1100mm small		
For models:	0A1FR1G, 0A1FR1GD, 0A1FR1GD-VERS.2004, 0A1FR1G-VERS.2004, 0B1FR1G, 0B1FR1GD, 0D1FR1G, 0D1FR1GD, 0D1FR1GD-VERS.2004, 0D1FR1G-VERS.2004, 1A1BR1G, 1A1BR1GA, 1A1BR2G, 1A1BR2GA, 1A1FR2G, 1A1FR2GD, 1A1FR2GD-VERS.2004, 1A1FR2G-VERS.2004, 1D1BR1G, 1D1BR1GA, 1D1BR2G, 1D1BR2GA, 1D1FR2G, 1D1FR2GD, 1D1FR2GD-VERS.2004, 1D1FR2G-VERS.2004, 2A1BR1G, 2A1BR1GA, 2A1BR2G, 2A1BR2GA, 2D1BR1G, 2D1BR1GA, 2D1BR2G, 2D1BR2GA		



SIRAI			
2-way			
L140-B series			
			
1			
GEV No.	370320	Ref. No.	33D1060
description	solenoid valve brass 2-ways 24VAC inlet 1/2" outlet 1/2" connection 1/2" L 41mm DN 10mm slide-on receptacle compact -10 up to +90°C SIRAI type series L140-B coil type Z610A membranes NBR (water) p max 12bar p min 0.35bar		
For models:	C165D, C165S, C207D, C207D-VERS.2006, C207S, C207S-VERS.2006, C207VD, C207VD-VERS.2006, C207VS, C207VS-VERS.2006, C304AD, C304AD-VERS.2006, C304AS, C304AS-VERS.2006, C304AVD, C304AVD-VERS.2006, C304AVS, C304AVS-VERS.2006, C304D, C304D-VERS.2006, C304S, C304S-VERS.2006, C304VD, C304VD-VERS.2006, C304VS, C304VS-VERS.2006, C92D-VERS.2006, C92S-VERS.2006, C92VD-VERS.2006, C92VS-VERS.2006, CS243D, CS243D-VERS.2006, CS243S, CS243S-VERS.2006, CS243VD, CS243VD-VERS.2006, CS243VS, CS243VS-VERS.2006, CS370AD, CS370AD-VERS.2006, CS370AS, CS370AS-VERS.2006, CS370AVD, CS370AVD-VERS.2006, CS370AVS, CS370AVS-VERS.2006, CS370D, CS370D-VERS.2006, CS370S, CS370S-VERS.2006...(Other models you can see in the webshop)		
spare parts for	370320		
	GEV No.	371070	Ref. No. N/A
	solenoid coil 24VAC 10VA SIRAI coil type Z610A seat ø 10mm		
accessories for	370320		
	GEV No.	371091	Ref. No. N/A
	power socket plug type DIN 43650B cable lengthmm small		

L180-B series			
			
1			
GEV No.	370391	Ref. No.	33D1050
description	solenoid valve 2-ways 24VAC connection 3/4" L 79mm DN 18mm -10 up to +90°C coil type Z610A membranes NBR (water) p max 12bar p min 0.35bar		
For models:	C165D, C165S, C207D, C207D-VERS.2006, C207S, C207S-VERS.2006, C207VD-VERS.2006, C207VS-VERS.2006, C304AD, C304AD-VERS.2006, C304AS, C304AS-VERS.2006, C304AVD-VERS.2006, C304AVS-VERS.2006, C304D, C304D-VERS.2006, C304S, C304S-VERS.2006, C304VD-VERS.2006, C304VS-VERS.2006, C92D-VERS.2006, C92S-VERS.2006, C92VD-VERS.2006, C92VS-VERS.2006, CS243D, CS243D-VERS.2006, CS243S, CS243S-VERS.2006, CS243VD, CS243VD-VERS.2006, CS243VS, CS243VS-VERS.2006, CS370AD, CS370AD-VERS.2006, CS370AS, CS370AS-VERS.2006, CS370AVD, CS370AVD-VERS.2006, CS370AVS, CS370AVS-VERS.2006, CS370D, CS370D-VERS.2006, CS370S, CS370S-VERS.2006, CS370VD, CS370VD-VERS.2006, CS370VS, CS370VS-VERS.2006, CS466AD, CS466AD-VERS.2006...(Other models you can see in the webshop)		
accessories for	370391		
	GEV No.	371091	Ref. No. N/A
	power socket plug type DIN 43650B cable lengthmm small		



			
1			
GEV No.	370329	Ref. No.	N/A
description	solenoid valve 2-ways 24VAC inlet 1/2" outlet 1/2" connection 1/2" L 66mm DN 13.5mm slide-on receptacle compact -10 up to +90°C SIRAI type series L180-B coil type Z610A membranes NBR (water) p max 12bar p min 0.35bar		
spare parts for	370329		
	GEV No.	371070	Ref. No. N/A
	solenoid coil 24VAC 10VA SIRAI coil type Z610A seat ø 10mm		
	GEV No.	371171	Ref. No. N/A
	membrane series L180-B membrane type NBR (water)		
accessories for	370329		
	GEV No.	371091	Ref. No. N/A
	power socket plug type DIN 43650B cable lengthmm small		



			
1			
GEV No.	370047	Ref. No.	33D0070 33D1460
description	solenoid valve brass 2-ways 230VAC inlet 1/2" outlet 1/2" connection 1/2" L 66mm DN 13.5mm slide-on receptacle compact -10 up to +90°C SIRAI type series L180-B coil type Z610A membranes NBR (water) p max 12bar p min 0.35bar 50/60Hz		
spare parts for	370047		
	GEV No.	371085	Ref. No. —
	solenoid coil 230VAC 4VA SIRAI coil type ZB10A seat ø 10mm 50/60Hz		
	GEV No.	371171	Ref. No. N/A
	membrane series L180-B membrane type NBR (water)		
accessories for	370047		
	GEV No.	371091	Ref. No. N/A
	power socket plug type DIN 43650B cable lengthmm small		





solenoid valves steam (water)			
2-way			
L145-R series			
 <p>1</p>			
GEV No.	370085	Ref. No.	33D1420
description	solenoid valve 230VAC connection 1" L 105mm DN 18.5mm slide-on receptacle DIN -60 up to +170°C SIRAI type series L145-R coil type Z534A membranes PTFE (steam) p max 8bar p min 0.4bar		
spare parts for	370085		
	GEV No.	371067	Ref. No. N/A
solenoid coil 230VAC 14VA SIRAI coil type Z534A seat ø 12mm			
	GEV No.	371166	Ref. No. —
membrane connection 1" series L145-R membrane type PTFE			
accessories for	370085		
	GEV No.	371090	Ref. No. N/A
power socket plug type DIN 43650A screw			

 <p>1</p>			
GEV No.	370318	Ref. No.	33D0570
description	solenoid valve 2-ways 24VAC inlet 1/2" outlet 1/2" connection 1/2" L 66mm DN 10mm slide-on receptacle compact -60 up to +170°C SIRAI type series L145-R coil type Z614A membranes PTFE (steam) p max 8bar p min 0.4bar		
spare parts for	370318		
	GEV No.	371158	Ref. No. N/A
solenoid coil 24VAC 10VA SIRAI coil type Z614A seat ø 10mm			
	GEV No.	371164	Ref. No. N/A
membrane connection 3/8"-1/2" series L145-R membrane type PTFE			
accessories for	370318		
	GEV No.	371091	Ref. No. N/A
power socket plug type DIN 43650B cable lengthmm small			

L153-D series			
 <p>1</p>			
GEV No.	370326	Ref. No.	33D0560
description	solenoid valve 2-ways 230VAC connection 1" L 105mm DN 22mm slide-on receptacle DIN -10 up to 140°C SIRAI type series L153-D coil type Z914A membranes EPDM (steam/water) p max 8bar p min 0.1bar		
spare parts for	370326		
	GEV No.	371161	Ref. No. N/A
solenoid coil 230VAC 27VA SIRAI coil type Z923A seat ø 16mm 50Hz			

spare parts and accessories			
solenoid coils			
 <p>1</p>			
GEV No.	371071	Ref. No.	32Z5470
description	solenoid coil 230VAC 10VA SIRAI coil type Z610A seat ø 10mm H 33mm L 33mm W 25mm 50/60Hz		
accessories for	371071		
	GEV No.	371091	Ref. No. N/A
power socket plug type DIN 43650B cable lengthmm small			

 <p>1</p>			
GEV No.	371067	Ref. No.	N/A
description	solenoid coil 230VAC 14VA SIRAI coil type Z534A seat ø 12mm		

 <p>1</p>			
GEV No.	371161	Ref. No.	N/A
description	solenoid coil 230VAC 27VA SIRAI coil type Z923A seat ø 16mm 50Hz		





1

GEV No.	371070	Ref. No.	N/A
description	solenoid coil 24VAC 10VA SIRAI coil type Z610A seat ø 10mm		
accessories for	371070		
	GEV No.	371091	Ref. No. N/A
	power socket plug type DIN 43650B cable lengthmm small		



1

GEV No.	371158	Ref. No.	N/A
description	solenoid coil 24VAC 10VA SIRAI coil type Z614A seat ø 10mm		
accessories for	371158		
	GEV No.	371091	Ref. No. N/A
	power socket plug type DIN 43650B cable lengthmm small		



1

GEV No.	371099	Ref. No.	N/A
description	solenoid coil 24VDC 5.5VA SIRAI coil type ZB10A seat ø 10mm		
accessories for	371099		
	GEV No.	371091	Ref. No. N/A
	power socket plug type DIN 43650B cable lengthmm small		

membranes



1

GEV No.	371163	Ref. No.	N/A
description	membrane connection 1/2" series L140-B membrane type NBR (water)		



1

GEV No.	371172	Ref. No.	N/A
description	membrane connection 3/4" series L180-B membrane type NBR (water)		



1

GEV No.	371164	Ref. No.	N/A
description	membrane connection 3/8"-1/2" series L145-R membrane type PTFE		



1

GEV No.	371170	Ref. No.	N/A
description	membrane series L180-B membrane type NBR (water)		



1

GEV No.	371171	Ref. No.	N/A
description	membrane series L180-B membrane type NBR (water)		

solenoid valves (gas)

BRAHMA

solenoid valves



1

GEV No.	101948 ¹	Ref. No.	33A1650
description	solenoid valve 230VAC DN 15mm connection 1/2" L 72mm BRAHMA coil type 18811003 p max 0.5bar reg. no. 63AQ0626		
For models:	1A1PI2G, 1A1PI2GA, 1D1PI2G, 1D1PI2GA, 291PI3G, 2A1PI3G, 2D1PI3G		
spare parts for	101948		
	GEV No.	101968	Ref. No. —
	solenoid valve 230VAC 20VA seat ø 17mm coil type 13902001 BRAHMA		

¹aluminium housing

spare parts and accessories

solenoid coils



1

GEV No.	106242	Ref. No.	32V3640
description	solenoid coil 230VAC 20VA seat ø 17mm		
For models:	1A1PI2G, 1A1PI2GA, 1D1PI2G, 1D1PI2GA, 291PI3G, 2A1PI3G, 2D1PI3G		



1 electric components

solenoid valves (refrigeration)

CASTEL

spare parts and accessories



1			
GEV No.	371090	Ref. No.	N/A
description	power socket plug type DIN 43650A screw		

PARKER

valves



1			
GEV No.	370611	Ref. No.	33A0510
description	solenoid valve 2-way 230V 1.9 tube ø 6mm coil type ZB09 50/60Hz		
For models:	120, 120NN, 120PV, 135, 135-4, 135BN, 135BNX, 135CPX, 135NN, 135NNX, 135PVX, 135X, 135X-3, 135X-4, 40CP, 40CPX, 55, 55PV, 65, 65NB, 65NBX, 65NN, 65NNX, 65PVX, 65X, 65X-2, 6BEA11A, 6BEA11B, 6BEA11M, 6BEA11Z, 6BEA2A, 6BEA2B, 6BEA2M, 6BEA2Z, 6BEA3A, 6BEA3B, 6BEA3M, 6BEA3Z, 6BEA4, 6BEA4B, 6BEA4M, 6BEA4Z, 6BEA5A, 6BEA5B, 6BEA5M, 6BEA5Z, 6BEB11A, 6BEB11B, 6BEB11M, 6BEB11Z, 6BEB22A, 6BEB22B, 6BEB22M, 6BEB22Z...(Other models you can see in the webshop)		

Solenoid valve - accessories

filters



1			
GEV No.	370467	Ref. No.	N/A
description	solenoid valve filter suitable for ELBI		



1			
GEV No.	371091	Ref. No.	N/A
description	power socket plug type DIN 43650B cable lengthmm small		

pressure switches

for warewashing

ø 58mm with male faston 6.3mm

with connection horizontal



1			
GEV No.	541192	Ref. No.	32Z7190
description	pressure control		
For models:	LT10R, LT20F, LT25F		



1			
GEV No.	541011	Ref. No.	32Z4690
description	pressure control pressure range 110/70mbar connection 6mm ø 58mm pressure connection horizontal warewashing		





1			
GEV No.	541331	Ref. No.	32Z0860
description	pressure control pressure range 225/70mbar connection 6mm ø 58mm pressure connection horizontal warewashing		
For models:	L100, L80, LCV		





1			
GEV No.	541314	Ref. No.	32V7060
description	pressure control pressure range 46/26mbar connection 6mm ø 58mm pressure connection horizontal warewashing pressure connection ø 6mm		
For models:	KD100, KD100A, KD100PSD, KD130A, KD130E, KD130EAT, KD37, KD37PS, KD37-VERS.112009, KD40, KD40EPSD, KD40LEPS, KD40LSPS, KD40LUX, KD40LUXE, KD40PS, KD40-VERS.112009, KD60, KD60E, KD60EAT, KD60M, KD60MA, KD60ME, KD60MPS, KD60MPSA, KD60PS, KD60PSD, KD6EATSD, KD85A, KD85EA, KD85EAT, KD85EATS, KD85EPSA, KD85PSA, KN1100, KN1100SD, KN11PSDD, KN35, KN37, KN37PS, KN40, KN40PS, KN40PSD, KN50, KN50M, KN50MPS, KN50PS, KN50PSD, KN50PSDD, KN80...(Other models you can see in the webshop)		

			
1			
GEV No.	541010	Ref. No.	32Z4700
description	pressure control pressure range 50/30mbar connection 6mm ø 58mm pressure connection horizontal warewashing		

			
1			
GEV No.	541194	Ref. No.	32Z2170
description	pressure control pressure range 50/32mbar connection male faston 6.3mm ø 58mm pressure connection horizontal warewashing pressure connection ø 6mm		

			
1			
GEV No.	541140	Ref. No.	32V7060 32Z2170
description	pressure control pressure range 55/30mbar connection 6mm ø 58mm pressure connection horizontal warewashing		

			
1			
GEV No.	541012	Ref. No.	32Z0280
description	pressure control pressure range 68/40mbar connection 6mm ø 58mm pressure connection horizontal warewashing pressure connection ø 6mm		

			
1			
GEV No.	541330	Ref. No.	32Z4740 32Z4741
description	pressure control pressure range 70/30mbar connection 6mm ø 58mm pressure connection horizontal warewashing pressure connection ø 6mm		
For models:	F60P, F60PR, F60T, F80P, F80PR, L40, L40S, L45, L60, LCV		

			
1			
GEV No.	541311	Ref. No.	32Z0070
description	pressure control pressure range 76/38mbar connection 6mm ø 58mm pressure connection horizontal warewashing pressure connection ø 6mm		

			
1			
GEV No.	541312	Ref. No.	32V7080
description	pressure control pressure range 86/59mbar connection 6mm ø 58mm pressure connection horizontal warewashing pressure connection ø 6mm		
For models:	KD100, KD100A, KD100PSD, KD40EPSD, KD40LEPS, KD40LUXE, LP151		

			
1			
GEV No.	541168	Ref. No.	32V1870 32Z8880
description	pressure control pressure range 90/35mbar connection 6mm ø 58mm pressure connection horizontal warewashing pressure connection ø 6mm		
For models:	C165D, C165S, C165VD, C165VS, C207D, C207S, C207VD, C207VD-VERS.2006, C207VS, C207VS-VERS.2006, C304AD, C304AS, C304AVD, C304AVD-VERS.2006, C304AVS, C304AVS-VERS.2006, C304D, C304S, C304VD, C304VD-VERS.2006, C304VS, C304VS-VERS.2006, C92VD-VERS.2006, C92VS-VERS.2006, LC100, LC100-VERS.2001, LC130, LC130-VERS.2001, LC80, N303S, N303VD, N303VS, N354D, N354VD, N354VS, N506D, N506VD, N506VS, N607D, N607VD, N607VS, N760S, N760VD, N760VS, N886D, N886VD, N886VS		

			
1			
GEV No.	541017	Ref. No.	32Z8930
description	pressure control with mounting strap pressure range 40/20mbar connection 6mm ø 58mm pressure connection horizontal warewashing		
For models:	CS243S, CS243VS, CS370AS, CS370AVS, CS370S, CS370VS, CS466AS, CS466AVS, CS466VS, LF50, LF50E, LF50EM, LF50E-VERS.2007, N303D, N303S, N303VD, N303VS, N354D, N354S, N354VD, N354VS, N506D, N506S, N506VD, N506VS, N607D, N607S, N607VD, N607VS, N760D, N760S, N760VD, N760VS, N886D, N886S, N886VD, N886VS		

1

GEV No.	541199	Ref. No.	6300569
description	pressure control pressure range 0.2-3.0mbar ø 74mm pressure connection ø 6.3mm		
For models:	FC1011G, FC1221G, FC611G, FM1011G1, FM1011G1-VERS.2006, FM1011G2, FM1011G2-VERS.2006, FM1011G3, FM1011G3-VERS.2006, FM1221G1, FM1221G1-VERS.2006, FM1221G2, FM1221G2-VERS.2006, FM1221G3, FM1221G3-VERS.2006, FM2011G2-VERS.2006, FM2011G3-VERS.2006, FM2021G1, FM2021G2, FM2021G2-VERS.2006, FM2021G3, FM2021G3-VERS.2006, FM611G1, FM611G1-VERS.2006, FM611G2, FM611G2-VERS.2006, FM611G3, FM611G3-VERS.2006, FM721G1, FM721G1-VERS.2006, FM721G2, FM721G2-VERS.2006, FM721G3, FM721G3-VERS.2006		



1

GEV No.	541575	Ref. No.	3004460 3004461
description	pressure control ø 45.5mm pressure range 400/200mbar 1CO pressure connection vertical convection oven connection male faston 6.3mm suitable for ANGELO PO 250V p max 1bar 6A pressure connection 1/8"		
For models:	FM1011E3, FM1011E3-VERS.2006, FM1011G3, FM1011G3-VERS.2006, FM1221E3, FM1221E3-VERS.2006, FM1221G3, FM1221G3-VERS.2006, FM2011E3-VERS.2006, FM2011G3-VERS.2006, FM2021E3, FM2021E3-VERS.2006, FM2021G3, FM2021G3-VERS.2006, FM611E3, FM611E3-VERS.2006, FM611G3, FM611G3-VERS.2006, FM721E3, FM721E3-VERS.2006, FM721G3, FM721G3-VERS.2006		

ø 79mm with coded plug



1

GEV No.	541332	Ref. No.	32Z2840
description	pressure control 2 pressure ranges pressure range 70/40 90/70mbar connection coded plug ø 78mm pressure connection horizontal warewashing pressure connection ø 6mm at 250V 16A		
For models:	F60PR, F60T, F80P, F80PR		

for pasta cookers



1

GEV No.	541980	Ref. No.	6300988
description	conversion kit for drain pump pressure range 300/245 385/300bar 0G1CP1G		

for combi-steamers



1

GEV No.	541806	Ref. No.	3041830 32Z5870 32Z5871 32Z5872
description	pressure control ø 38mm pressure range 0.2-3.0bar connection 1/8" 250V 10A GP600 pressure connection 1/8"		
For models:	BX101E, BX101E-VERS.122013, BX101G, BX101G-VERS.122013, BX122E, BX122E-VERS.122013, BX122G, BX122G-VERS.122013, BX61E, BX61E-VERS.122013, BX61G, BX61G-VERS.122013, BX82E, BX82E-VERS.122013, BX82G, BX82G-VERS.122013, FCV101, FCV101-CSA, FCV101DM, FCV101DM-CSA, FCV101DS, FCV101DS-CSA, FCV101E, FCV101EDM, FCV101EDM-UL, FCV101EDS, FCV101EDS-UL, FCV101E-UL, FCV141, FCV141-CSA, FCV141DM, FCV141DM-CSA, FCV141DS, FCV141DS-CSA, FCV141E, FCV141EDM, FCV141EDS, FCV241, FCV241DM, FCV241DS, FCV241E, FCV241EDM, FCV241EDM-UL, FCV241EDS, FCV241EDS-UL, FCV241E-UL, FCV241G, FCV241G-CSA, FCV241GDM, FCV241GDM-CSA...(Other models you can see in the webshop)		
accessories for	541806		
	GEV No.	541814	Ref. No. —
	protection cap for pressure switch EPDM XP600		



1

GEV No.	542229	Ref. No.	3160100 3253760
description	pressure control pressure range 350/265mbar connection 5.5		
For models:	04WCP1EM, 06WCP1GM, 08WCP1GM, 091CP1E, 091CP1G, 191CP1G, 191CP2G, 1G1CP1G-VERS.2004, 6040090, 6040310		



1

GEV No.	541482	Ref. No.	3017600
description	pressure control pressure range 385/325mbar connection 6mm		
For models:	04WCP1EM, 06WCP1GM, 08WCP1GM, 091CP1E, 091CP1G, 0G1CP1EC, 0G1CP1E-VERS.2004, 0G1CP1G-VERS.2004, 191CP1G, 191CP2G, 1G1CP1G-VERS.2004, 1G1CP2G-VERS.2004		



for boiling pans



1

GEV No.	541510	Ref. No.	32V1790
description	pressure control EGO		
For models:	1A1PI2G, 1A1PI2GA, 1D1PI2G, 1D1PI2GA, 291PI3E, 291PI3G, 2A1PI3E, 2A1PI3G, 2D1PI3G, MCF20E, MCF20V, MCF40E, MCF40V		

for refrigeration

RANCO

G60 series



1

GEV No.	541195	Ref. No.	32Z6350
description	pressure control RANCO G60H1129401		
For models:	120NN, 65NB, 65NBX, 65NN, 65NNX, SP65NB, SP65NN		

compressors

ACC/ZEL

R134A

HMBP monophase

High/Medium evaporation temperature above -20/-15 °C

1

GEV No.	605007	Ref. No.	34D6390
description	compressor coolant R134a type GL60TB 220-240V 50Hz HMBP fully hermetic 9.5kg 1/5HP power input 437W cylinder capacity 5.7cm ³ CSIR H 175.5mm 95W 128W 170W 222W 284W 355W 437W 528W test method ASHRAE ambient temperature max. 43°C		
For models:	40CP, 40CPX, 65A, 65XE, 6FMA11A, 6FMA11B, 6FMA11M, 6FMA11Z, 6FMA2A, 6FMA2B, 6FMA2M, 6FMA2Z, 6FMA4A, 6FMA4B, 6FMA4M, 6FMA4Z, 6FMAA, 6FMAB, 6FMAM, 6FMAZ, 6TRA, 6TRA2, 6TRA2A, 6TRA2M, 6TRA2Z, 6TRA4, 6TRA4A, 6TRA4M, 6TRA4Z, 6TRAA, 6TRAM, 6TRAZ, CX140CP, CX150CP, CX65NB, CX65NCP, CX65NN, CX70NB, CX70NN, FM1A, FM1A-11, FM1A-2, FM1A-4, S60, S60-2, S60E, S60X, S60X-2, SA87		



1

GEV No.	605008	Ref. No.	34D6500
description	compressor coolant R134a type GL80TB 220-240V 50Hz HMBP fully hermetic 9.5kg 1/5HP power input 554W cylinder capacity 7.6cm ³ CSIR H 175.5mm 165W 215W 290W 390W 500W 615W 727W 840W test method ASHRAE ambient temperature max. 43°C		
For models:	55, 55PV, 6JB, 6JB2, 6JB2A, 6JB2M, 6JB4A, 6JB4M, 6JBA, 6JBM, 6SMB, 6SMB2, 6SMB2A, 6SMB2B, 6SMB2M, 6SMB2Z, 6SMB4, 6SMB4A, 6SMB4B, 6SMB4M, 6SMB4Z, 6SMB6Z, 6SMB6A, 6SMB6B, 6SMB6M, 6SMBZ, PE1633, PE1633V, PZ20, PZ2033A, PZ2033B, PZ2037A, PZ2037B		



1

GEV No.	605009	Ref. No.	34D6510
description	compressor coolant R134a type GL90TB 220-240V 50Hz HMBP fully hermetic 10.8kg 1/4HP power input 293W cylinder capacity 8.8cm ³ CSIR H 175.5mm 143W 194W 259W 339W 432W 539W 661W 796W test method ASHRAE		
For models:	6FMB11A, 6FMB11B, 6FMB11M, 6FMB11Z, 6FMB2A, 6FMB2B, 6FMB2M, 6FMB2Z, 6FMB4A, 6FMB4B, 6FMB4M, 6FMB4Z, 6FMB6A, 6FMB6B, 6FMB6M, 6FMB6Z, 6FMC11A, 6FMC11B, 6FMC11M, 6FMC11Z, 6FMC2A, 6FMC2B, 6FMC2M, 6FMC2Z, 6FMC4A, 6FMC4B, 6FMC4M, 6FMC4Z, 6FMC6A, 6FMC6B, 6FMC6M, 6FMC6Z, 6TRB, 6TRB11, 6TRB11A, 6TRB11M, 6TRB11Z, 6TRB2, 6TRB2A, 6TRB2M, 6TRB2Z, 6TRB4, 6TRB4A, 6TRB4M, 6TRB4Z, 6TRB6, 6TRB6A, 6TRB6M, 6TRB6Z, 6TRBA...(Other models you can see in the webshop)		



1

GEV No.	605010	Ref. No.	34D6520 34D6760
description	compressor coolant R134a type GP12TB 220-240V 50Hz HMBP fully hermetic 11.2kg 3/8HP power input 661W cylinder capacity 12cm ³ CSIR H 203.6mmW 143W 194W 259W 339W 432W 539W 661W 796W test method ASHRAE ambient temperature max. 43°C		
For models:	120, 120NN, 120PV, 135, 135-4, 135A, 135NN, 135NNX, 135PVX, 135X, 135X-3, 135X-4, 135XE, 65NN, 65NNX, 65PVX, 6SMC, 6SMC2, 6SMC2A, 6SMC2B, 6SMC2M, 6SMC2Z, 6SMC4, 6SMC4A, 6SMC4B, 6SMC4M, 6SMC4Z, 6SMC6, 6SMC6A, 6SMC6B, 6SMC6M, 6SMC6Z, 6SMC8Z, 6SMC4, 6SMCB, 6SMCM, 6SMCZ, 6TRC, 6TRC11, 6TRC11A, 6TRC11M, 6TRC11Z, 6TRC2, 6TRC2A, 6TRC2M, 6TRC2Z, 6TRC4, 6TRC4A, 6TRC4M, 6TRC4Z...(Other models you can see in the webshop)		

CUBIGEL

accessories

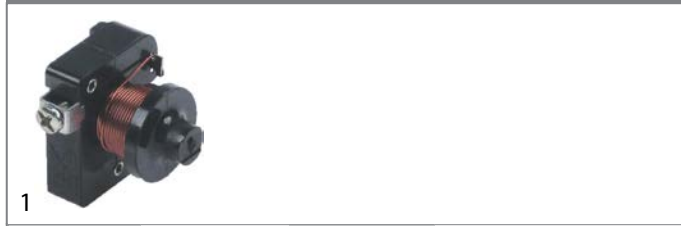

1

GEV No.	380091	Ref. No.	32Z6920
description	start relay MTRP0027 120/240V voltage AC 8A 1NO		
For models:	135CPX, 55, 55PV, 6BEA11A, 6BEA11B, 6BEA11M, 6BEA2A, 6BEA2B, 6BEA2M, 6BEA3A, 6BEA3B, 6BEA3M, 6BEA4, 6BEA4B, 6BEA4M, 6BEB11A, 6BEB11B, 6BEB11M, 6BEB22A, 6BEB22B, 6BEB22M, 6BEB2A, 6BEB2B, 6BEB2M, 6BEB3A, 6BEB3B, 6BEB3M, 6BEB4A, 6BEB4B, 6BEB4M, 6BEBA, 6BEBA, 6BEBM, 6BMA11A, 6BMA11B, 6BMA11M, 6BMA2A, 6BMA2B, 6BMA2M, 6BMA3A, 6BMA3B, 6BMA3M, 6BMAA, 6BMAB, 6BMAM, 6FMA11A, 6FMA11B, 6FMA11M, 6FMA2A, 6FMA2B...(Other models you can see in the webshop)		

EMBRACO / ASPERA

R134A
HBP monophase
High evaporation temperature above -15°C



1

GEV No.	605209	Ref. No.	34D5490
description	compressor coolant R134a type NEK6187Z-A 220-240V 50Hz HBP 11kg 1/3HP cylinder capacity 10cm ³ CSIR H 200mmWWW 365W 482W 624W 791W 983W 1201W test method EN 12900 ambient temperature max. 55°C		
For models:	6BEC11A, 6BEC11B, 6BEC11M, 6BEC11Z, 6BEC22A, 6BEC22B, 6BEC22M, 6BEC22Z, 6BEC2A, 6BEC2B, 6BEC2M, 6BEC2Z, 6BEC33A, 6BEC33B, 6BEC33M, 6BEC33Z, 6BEC3A, 6BEC3B, 6BEC3M, 6BEC3Z, 6BEC4A, 6BEC4B, 6BEC4M, 6BEC4Z, 6BEC6A, 6BEC6B, 6BEC6M, 6BEC6Z, 6BECA, 6BECB, 6BECM, 6BECZ, 6BMB11A, 6BMB11B, 6BMB11M, 6BMB11Z, 6BMB22A, 6BMB22B, 6BMB22M, 6BMB22Z, 6BMB2A, 6BMB2B, 6BMB2M, 6BMB2Z, 6BMB3A, 6BMB3B, 6BMB3M, 6BMB3Z, 6BMB4A, 6BMB4B...(Other models you can see in the webshop)		

accessories

starting relays

klixons



1

GEV No.	380094	Ref. No.	32Z1050
description	start relay 120/240V voltage AC 8A 1NO 1NO 1-pole		

overload protector (klixon)



1

GEV No.	390597	Ref. No.	32Z1030
description	overload protector for engine protective circuit breaker MRP77A-MN_3001 with cable t.max. 150°C reset automatic		





			
1			
GEV No.	390599	Ref. No.	32Z6930
description	overload protector for engine protective curcuit breaker T0318/22 with cable t.max. 150°C reset automatic		
For models:	135CPX, 55, 55PV, 6BEA11A, 6BEA11B, 6BEA11M, 6BEA2A, 6BEA2B, 6BEA2M, 6BEA3A, 6BEA3B, 6BEA3M, 6BEA4A, 6BEA4B, 6BEA4M, 6BEB11A, 6BEB11B, 6BEB11M, 6BEB22A, 6BEB22B, 6BEB22M, 6BEB2A, 6BEB2B, 6BEB2M, 6BEB3A, 6BEB3B, 6BEB3M, 6BEB4A, 6BEB4B, 6BEB4M, 6BEBA, 6BEBB, 6BEBM, 6BMA11A, 6BMA11B, 6BMA11M, 6BMA2A, 6BMA2B, 6BMA2M, 6BMA3A, 6BMA3B, 6BMA3M, 6BMAA, 6BMAB, 6BMAM, 6FMA11A, 6FMA11B, 6FMA11M, 6FMA2A, 6FMA2B...(Other models you can see in the webshop)		

evaporation and condensing trays

condensing trays heated

universal

heating cartridges

			
1			
GEV No.	418892	Ref. No.	32G3310
description	heating cartridge 300W 230V ø 12mm L 240mm thread 3/8" cable length 2000mm immersion heater		
For models:	AF1N, AF1N-0PR01, AF2N, AF2N-0PR01, CX120, CX120NN, CX130, CX130NN, CX140, CX140BN, CX140BR, CX140CP, CX140NN, CX140PV, CX140R, CX150, CX150BN, CX150BR, CX150CP, CX150NN, CX150PV, CX150R, CX55, CX60, CX65, CX652, CX65BR, CX65NB, CX65NCP, CX65NN, CX65PV, CX65R, CX70, CX702, CX70BR, CX70NB, CX70NN, CX70PV, CX70R, FSD1N, FSD2N, FSD2N2, FSDR1B-0PR01, FSDR1N-0PR01, FSDR2B-0PR01, FSDR2B2-0PR01, FSDR2N, FSDR2N-0PR01, FSDR2N2-0PR01, FSE2N...(Other models you can see in the webshop)		
accessories for	418892		
	GEV No.	511472	Ref. No. —
	nut thread 3/8" H 4mm brass WS 21 Qty 1 pcs		
	GEV No.	518393	Ref. No. —
	flat gasket FIBER ED ø 24mm ID ø 17mm thickness 2mm Qty 1 pcs		

fans

axial fans

ebm-papst

			
1			
GEV No.	601082 ¹	Ref. No.	3076620
description	axial fan L 92mm W 92mm H 25mm 230VAC 50/60Hz 9/11W bearing ball bearing manuf. no. 3956 metal connection male faston 2.8mm ebm-papst fan wheel ø 85mm temp.-resist. 80°C		
For models:	04WPEBV, 08WPEBV, 08WTPEV, 090PEB, 091FR1EX, 091FR1IA, 091FR7G, 091FR7GS, 091FR7GX, 190PEB, 190TPE, 6BM, 6BR, 6CP, 6FR, 6FTL, 6FTR, 6PC, 6VTR, 6VTR2		
accessories for	601082		
	GEV No.	691103	Ref. No. —
	guard ø 90mm mounting distance 83mm for axial fan 92mm		

¹with ball bearings

import

			
1			
GEV No.	601604 ¹	Ref. No.	32M7130 32V5790
description	axial fan L 119mm W 119mm H 38mm 230VAC 50/60Hz 17/15W bearing slide bearing manuf. no. AA1282HS-AT connection cable 300mm fan wheel ø 110mm temp.-resist. 70°C input current 0.1A airflow 130m ³ /h 2600rpm		

¹with slide bearings

			
1			
GEV No.	601055 ¹	Ref. No.	3113740 3205930
description	axial fan L 92mm W 92mm H 25mm 230VAC 50/60Hz 14.5/14W bearing ball bearing connection male faston 2.8mm metal ADDA fan wheel ø 85mm temp.-resist. 70°C		
For models:	08WPBEV, 08WTPEV, 090PEB, 091FR11, 091FR11D, 091PEB, 10CP1EA, 10CP1IA, 12CP1EA, 12CP1IA, 18CP2EA, 18CP2IA, 190PEB, 190TPE, 191FR2I, 191FR2ID, 191PEB, 191TPE, 2091SCP, FX101E1, FX101E1R, FX101E2, FX101E2C, FX101E2C-VERS.032014, FX101E2R, FX101E2R-VERS.032014, FX101E2-VERS.032014, FX101E3, FX101E3C, FX101E3C-VERS.022014, FX101E3R, FX101E3R-VERS.022014, FX101E3-VERS.022014, FX101G1, FX101G1R, FX101G2, FX101G2C, FX101G2C-VERS.032014, FX101G2R, FX101G2R-VERS.032014, FX101G2-VERS.032014, FX101G3, FX101G3C, FX101G3C-VERS.022014, FX101G3R, FX101G3R-VERS.022014, FX101G3-VERS.022014, FX10E2CR, FX10E2CR-VERS.032014, FX10E3CR...(Other models you can see in the webshop)		
accessories for	601055		
	GEV No.	550898	Ref. No. —
	connecting cable cable length 2000mm connection F 2.8 connection distance 7.9mm for axial flow fan		
	GEV No.	691103	Ref. No. —
	guard ø 90mm mounting distance 83mm for axial fan 92mm		

¹with ball bearings



refrigeration fans

refrigeration motors universal

ELCO

N series - multi fit



			
1			
GEV No.	601427	Ref. No.	32M4041 32M6870
description	fan motor ELCO 10W 230V 50/60Hz bearing slide bearing L1 49mm L2 59mm L3 86.5mm W 83mm connection cable 500mm 1300/1550rpm 5 mounting options VNT10-20/028		
For models:	120, 120B, 120NN, 120PV, 135, 135-4, 135A, 135B, 135BA, 135BN, 135BNX, 135BX, 135BXE, 135BXR, 135CPX, 135NN, 135NNX, 135PVX, 135X, 135X-3, 135X-4, 135XE, 135XR, 3G6SA, 3G6SA2, 3G6SA4, 40B, 40CP, 40CPX, 4G6SB, 4G6SB2, 4G6SB4, 4G6SB6, 55, 55B, 55PV, 65, 65A, 65B, 65BA, 65BX, 65BX-2, 65BXE, 65BXR, 65NB, 65NBX, 65NN, 65NNX, 65PVX, 65X...(Other models you can see in the webshop)		
spare parts for	601427		
	GEV No.	560140	Ref. No. —
	hexagonal nut thread M4 H 4.8mm SS WS 7 Qty 20 pcs DIN/ISO DIN 985 self-locking		

spare parts for	601427		
	GEV No.	560332	Ref. No. —
	plain washer ID ø 4.3mm ED ø 9mm thickness 0.8mm SS Qty 1 pcs		
	GEV No.	560340	Ref. No. —
	hexagonal nut thread M4 H 3.2mm WS 7 SS DIN/ISO DIN 934 / ISO 4032/8673 Qty 1 pcs		
	GEV No.	601413	Ref. No. —
	fixing plate suitable for fanwheel ED ø 32mm shaft ø 7 mounting distance 26mm		

			
1			
GEV No.	601430	Ref. No.	32M4351
description	fan motor ELCO 5W 230V 50/60Hz bearing slide bearing L1 48mm L2 52mm L3 79.5mm W 83mm connection cable 500mm 1300/1550rpm 5 mounting options VNT5-13/027		
spare parts for	601430		
	GEV No.	560140	Ref. No. —
	hexagonal nut thread M4 H 4.8mm SS WS 7 Qty 20 pcs DIN/ISO DIN 985 self-locking		
	GEV No.	560332	Ref. No. —
	plain washer ID ø 4.3mm ED ø 9mm thickness 0.8mm SS Qty 1 pcs		
	GEV No.	560340	Ref. No. —
	hexagonal nut thread M4 H 3.2mm WS 7 SS DIN/ISO DIN 934 / ISO 4032/8673 Qty 1 pcs		
	GEV No.	601413	Ref. No. —
	fixing plate suitable for fanwheel ED ø 32mm shaft ø 7 mounting distance 26mm		

N series - standard



GEV No.	601708 ¹	Ref. No.	32M7020
description	fan motor ELCO 10W 230V 50/60Hz bearing slide bearing L3 82.5mm W 66mm connection Plug In cable lengthmm 1300/1550rpm VN10-20/1124		
For models:	3G6SA, 3G6SA2, 3G6SA4, 40B, 40B-OPR01, 40BX-OPR01, 40CP-OPR01, 40CPX-OPR01, 4G6SB, 4G6SB2, 4G6SB4, 4G6SB6, 6BR15V, 6BR15VC, 6BR19V, 6BR19VC, 6EA, 6EA11, 6EA11A, 6EA11M, 6EA13, 6EA13A, 6EA13M, 6EA2, 6EA2A, 6EA2M, 6EAA, 6EAB, 6EABA, 6EABM, 6EAM, 6EB, 6EB11, 6EB11A, 6EB11M, 6EB13, 6EB13A, 6EB13M, 6EB2, 6EB22, 6EB22A, 6EB22M, 6EB2A, 6EB2M, 6EB4, 6EB4A, 6EB4M, 6EBA, 6EBM, 6EC...(Other models you can see in the webshop)		
spare parts for	601708		
		GEV No.	601413
		Ref. No.	—
	fixing plate suitable for fanwheel ED ø 32mm shaft ø 7 mounting distance 26mm		
accessories for	601708		
		GEV No.	601892
		Ref. No.	—
	connector cable ELCO cable length 1500mm 0.75mm ² protection IP42 for Plug-In		

¹with coded connector

RE series



GEV No.	602051	Ref. No.	32M7240
description	fan motor 18/62W 230V 50/60Hz 2600rpm		
For models:	AGL6B, B151H, BF51H, FSD2B-OPR01, FSD2B2-OPR01, FSDR2B-OPR01, FSDR2B2-OPR01, FSE2B-OPR01, FSE2B2-OPR01, FSER2B-OPR01, FSER2B2-OPR01, IS51H, XS51H		

BT series - capacitor motors



GEV No.	601820 ¹	Ref. No.	32M4701
description	fan motor 35W 230V 50/60Hz L2 89mm L3 110mm W 82mm cable length 2150mm 1300/1550rpm ELCO incl. capacitor capacitor 2.5µF		
For models:	ART2LD, ART2SD, DS51, DS51A, DS51C, DS51M, GR135BT, GR1A, GR2A, IA101L, IA101S, IS101L, IS101S, IS51, IS51A, IS51C, IS51M, ISFEB, ISFEB-OPR01, ISFEN, ISFEN-OPR01, SM1L, SM1L7, SM1L7A, SM1L7FCV, SM1L7M, SM1LA, SM1LAM, SM1LAT, SM1LM, SM1LT, SM1LT7, SM1LT7A, SM1LT7M, SM2L, SM2S, SM3S		

¹incl. capacitor

IMPORT

multi fit fan motors



GEV No.	601022	Ref. No.	32M0220 32M1060 32M4371
description	fan motor 10W 230V 50-60Hz L1 44mm L2 54mm L3 85mm W 84mm cable length 500mm 1300rpm YZF10-20-18/26 5 mounting options bearing slide bearing		
For models:	120, 120B, 120NN, 120PV, 135, 135BN, 135NN, 55, 55B, 55PV, 65, 65B, 65NB, 65NN, 6BEABA, 6BEABB, 6BEABM, 6BEABZ, BRPR, BRPR218, BRVR, BRVR218, PGA20, PGA30, PGA40, PGA60, PGA80, PGW20, PGW30, PGW40, PGW60, PGW80, S125X, S60B, S60BX, S60X, SA87, SP120, SP120B, SP120BN, SP120NN, SP135, SP135BN, SP135CP, SP135NN, SP55, SP55B, SP65, SP65B, SP65NB...(Other models you can see in the webshop)		



GEV No.	601020	Ref. No.	32M4350
description	fan motor 5W 230V 50-60Hz L1 44mm L2 48mm L3 79mm W 84mm cable length 500mm 1300rpm YZF5-13-18/26 5 mounting options bearing slide bearing		
For models:	135BN, 135NN, 40CP, 40CPX, 65, 65NB, 65NN, S125B, S125BX, S125X, S60B, S60X, SP120BN, SP120NN, SP135BN, SP135CP, SP135NN, SP55, SP55B, SP65, SP65NB, SP65NN		



accessories

fan wheels

aluminium

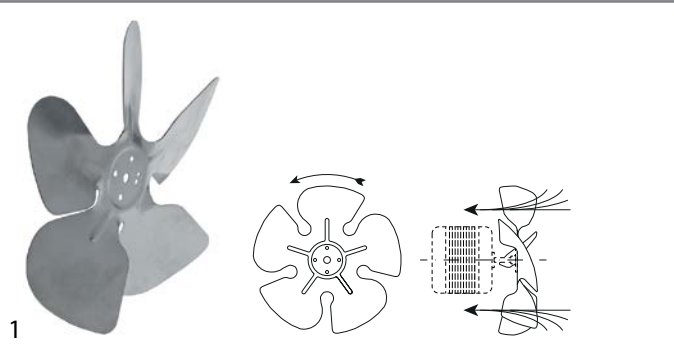

GEV No.	601070	Ref. No.	32M3280
description	fan wheel sucking ø 200mm fan wheel mounting 25.4mm blade angle 28° W 38mm aluminium		
For models:	135BN, 135BNX, 135CPX, 135NN, 135NNX, 3G6SA, 3G6SA2, 3G6SA4, 40B-OPR01, 40BX-OPR01, 40CP, 40CP-OPR01, 40CPX, 40CPX-OPR01, 4G6SB, 4G6SB2, 4G6SB4, 4G6SB6, 55B, 65, 65A, 65NB, 65NBX, 65NN, 65NNX, 65PVX, 65X, 65X-2, 65XE, 65XR, 6BR15V, 6BR15VC, 6BR19V, 6BR19VC, 6EA, 6EA11, 6EA11A, 6EA11M, 6EA13, 6EA13A, 6EA13M, 6EA2, 6EA2A, 6EA2M, 6EAA, 6EAM, 6JA, 6JA2, 6JA2A, 6JA2M...(Other models you can see in the webshop)		

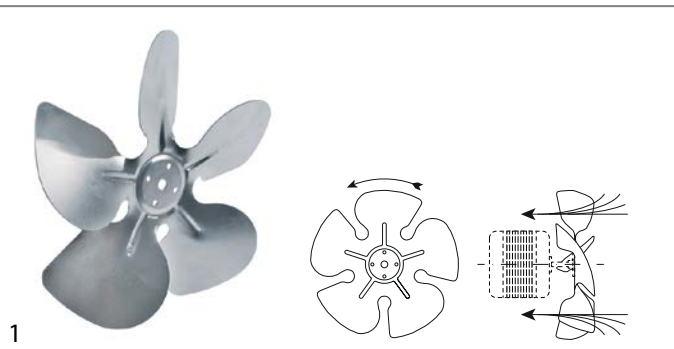

GEV No.	601282	Ref. No.	32M1550
description	fan wheel sucking ø 200mm fan wheel mounting 25.4mm blade angle 34° W 44mm aluminium		
For models:	135BN, 135BNX, 65B, 65BA, 65BX, 65BX-2, 65BXE, 65BXR, ART1L, ART1L7, ART1L7A, ART1L7M, ART1LA, CX120B, CX130, CX130B, CX130NN, CX60, CX60B, DA51, DA51A, DA51M, FX150, FX150B, FX150NN, FX70, FX70B, GD150B, ISFEB-OPR01, ISFEN-OPR01, MD130, MD130B, MD130BN, MD130NN, MD150, MD1504, MD150B, MD150B4, MD150BB, MD150BN, MD150BPV, MD150BR, MD150NCP, MD150NN, MD150PV, MD150R, MD60, MD60B, MD70, MD702...(Other models you can see in the webshop)		

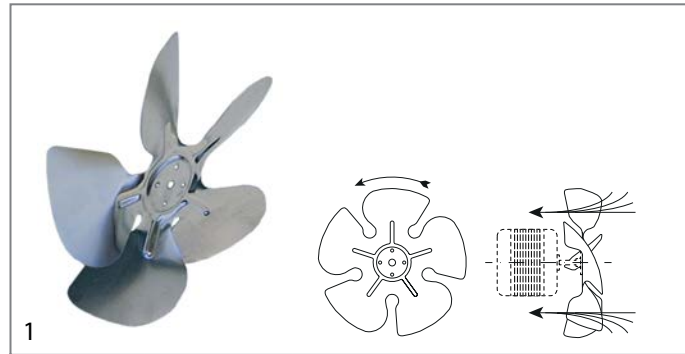

GEV No.	601072	Ref. No.	32M1080
description	fan wheel sucking ø 250mm fan wheel mounting 25.4mm blade angle 25° W 50mm aluminium		
For models:	120, 120B, 120NN, 120PV, 135, 135-4, 135A, 135B, 135BA, 135BN, 135BNX, 135BX, 135BXE, 135BXR, 135NN, 135NNX, 135PVX, 135X, 135X-3, 135X-4, 135XE, 135XR, 65B, 65BX, 65BX-2, 65NB, 65NBX, 65NN, 65NNX, 65PVX, AF1N, AF1N-OPR01, CX120, CX120NN, CX130, CX130B, CX140, CX140BN, CX140CP, CX140NN, CX140PV, CX150, CX150BN, CX150CP, CX150PV, CX55, CX55B, CX60B, CX65, CX652...(Other models you can see in the webshop)		

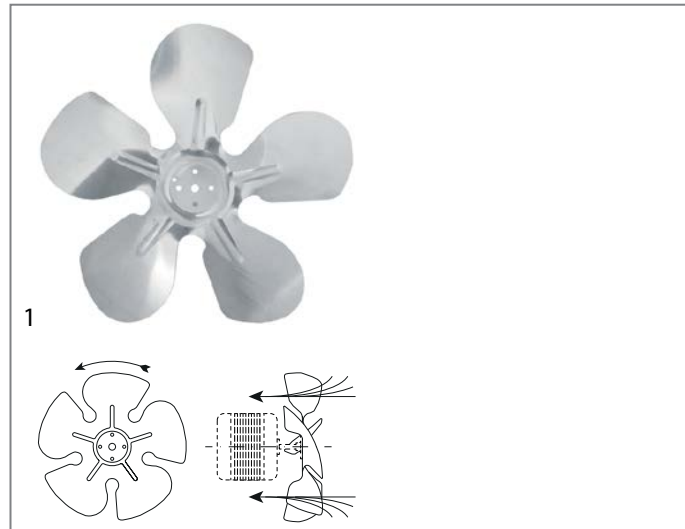



GEV No.	601387	Ref. No.	32M2260
description	fan wheel sucking ø 254mm fan wheel mounting 25.4mm blade angle 34° W 50mm aluminium		
For models:	135B, 135BX, AF2B, AF2B-OPR01, ART1LD, ART1LDA, BRPR, BRPR218, BRPR21C, BRPRV, BRVR, BRVR218, BRVR21C, BRVRV, CX120B, CX130B, CX140B, CX150B, D12Q1M, D12Q2, D12Q2M, FG2B, FSD2B, FSE2B, FSE2B2, GD150B, ISFEB, ISFEB-OPR01, ISFEN, ISFEN-OPR01, MD130B, MD150B, MD150B4, MD150BPV, MDE150B, MX120B, MX140B, PD130B, PD150B, PDG150B, S125B, S125B-4, S125BX, S125BX-4, SE14PRV, SE14PRW, SE14VRV, SE14VRW, SI14PRV, SI14PRW...(Other models you can see in the webshop)		

cold air circulating fans (complete)

ebm-papst

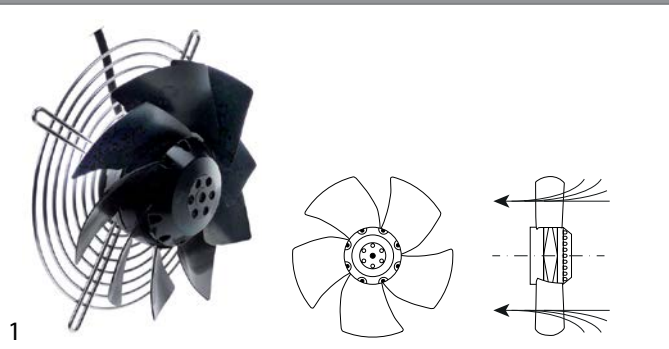
A2E series



GEV No.	601663 ¹	Ref. No.	32M6610
description	fan A2E200-AI38-10 fan wheel ø 200mm blades 9 230V 50/60Hz 64W 2600rpm cable length 450mm ebm-papst sucking suitable capacitor 1.5µF with protective grid		
For models:	ART1L, ART1L7, ART1L7A, ART1L7M, ART1LA, ART2LD, ART2SD, ART3SD, DA51, DA51A, DA51M, DS31, DS31A, DS31C, DS31M, DS351H, SM03LT7, SM03LT7A, SM03LT7M		
spare parts for	601663		
	GEV No.	365171	Ref. No. —
	capacitor capacity 1.5µF 400V tolerance 5% 50/60Hz ambient temperature max. -40 up to +85°C ø 25mm L 50mm M8 plastic connection cable 250mm MLR25PRL		
	GEV No.	601958	Ref. No. —
	guard ø 210mm for fan hole distance 258mm		

¹incl. capacitor and guard

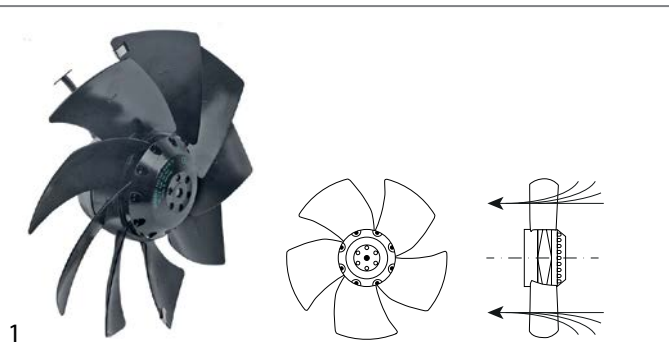

GEV No.	601964	Ref. No.	32M4720 32M6850
description	fan A2E250AM06-12 fan wheel ø 250mm blades 9 230V 50/60Hz 115/150W ø 250mm 2450rpm cable length 1400mm sucking suitable capacitor 3µF		
For models:	ART1LD, ART1LD7, ART1LD7A, ART1LD7M, ART1LDA, DS51, DS51A, DS51C, DS51M, IA101L, IA101S, IA51, IA51A, IA51C, IA51M, IA72S, IS101L, IS101LR, IS101LW, IS101S, IS101SR, IS101SW, IS51, IS51A, IS51AR, IS51C, IS51CR, IS51H, IS51HW, IS51M, IS51MR, IS51R, IS51W, IS51WA, IS51WC, IS51WM, IS72S, IS72SR, IS72SW, ISFEB, ISFEB-0PR01, ISFEN, ISFEN-0PR01, SM1LAM, SM1LAT, SM1LM, SM1LT, SM1LT7, SM1LT7A, SM1LT7M...(Other models you can see in the webshop)		
spare parts for	601964		
	GEV No.	365137	Ref. No. —
	capacitor capacity 3µF 450V tolerance 5% 50/60Hz ambient temperature max. -25 to +85°C ø 25mm L 56mm M8 plastic connection cable 250mm 416.17.77GF protection		

miscellaneous



GEV No.	601810	Ref. No.	32M6220
description	fan 230V 50Hz ø 278mm suitable capacitor 4µF ECOFIT type 2VRE35 H 90mm fan wheel ø 250mm cable length 2000mm		
For models:	SM1L, SM1L7, SM1L7A, SM1L7FCV, SM1L7M, SM1LA, SM1LAR, SM1LAW, SM1LR, SM1LW, SM2L, SM2LR, SM2LW, SM2S, SM2SR, SM2SW, SM3S, SM3SR		

cross flow fans

COPREL

with standard coil



GEV No.	601032	Ref. No.	32M2090
description	cross flow fan COPREL TFL(FN) roller ø 60mm roller length 180mm laminated core thickness 15mm motor position left 230V/50Hz 19W bearing rubber connection male faston 6.3mm coil type airflow 107m ³ /h -10 up to +60°C refrigeration		



GEV No.	601452	Ref. No.	32M0050 32M0521 32M5920
description	cross flow fan TFL 180 roller ø 60mm roller length 180mm laminated core thickness 20mm motor position left 230V/50Hz 19W universal bearing silicone connection male faston 6.3mm airflow 100m ³ /h -30 up to +100°C 230V 50Hz		
For models:	120, 120NN, 120PV, 135CPX, 3G6SA, 3G6SA2, 3G6SA4, 40, 40-0PR01, 40PL, 40PV, 40PV-0PR01, 40X, 40X-0PR01, 40XPV, 4G6SB, 4G6SB2, 4G6SB4, 4G6SB6, 55, 55PV, 6BEA11A, 6BEA11B, 6BEA11M, 6BEA11Z, 6BEA2A, 6BEA2B, 6BEA2M, 6BEA2Z, 6BEA3A, 6BEA3B, 6BEA3M, 6BEA3Z, 6BEAA, 6BEAB, 6BEAM, 6BEAZ, 6BEB11A, 6BEB11B, 6BEB11M, 6BEB11Z, 6BEB22A, 6BEB22B, 6BEB22M, 6BEB22Z, 6BEB2A, 6BEB2B, 6BEB2M, 6BEB2Z, 6BEB3A...(Other models you can see in the webshop)		

double fans



GEV No.	601026	Ref. No.	32M1220 32M2210
description	cross flow fan COPREL TFD(FD) roller ø 60mm roller length 2x180mm laminated core thickness 35mm motor position centre 230V/50-60Hz 42W refrigeration bearing rubber connection male faston 6.3mm coil type airflow 255m ³ /h -10 up to +60°C		

accessories for cross flow fans

heater battery



GEV No.	415122	Ref. No.	32G1990
description	heater battery mounting distance 185mm W 40mm H 35mm 2000W 230V temperature restriction 105°C heating circuits 2 connection cable cable length 340mm L 197mm for cross flow fan		

hot air motors



GEV No.	550688	Ref. No.	31S1490 31S1490
description	bushing for fan motor		
For models:	FC101, FC101E, FC241, FC241E, FC241G, FC61, FC61E, FCV101, FCV101-CSA, FCV101DM, FCV101DM-CSA, FCV101DS, FCV101DS-CSA, FCV101E, FCV101EDM, FCV101EDM-UL, FCV101EDS, FCV101EDS-UL, FCV101E-UL, FCV141, FCV141-CSA, FCV141DM, FCV141DM-CSA, FCV141DS, FCV141DS-CSA, FCV141E, FCV141EDM, FCV141EDS, FCV241, FCV241DM, FCV241DS, FCV241E, FCV241EDM, FCV241EDM-UL, FCV241EDS, FCV241EDS-UL, FCV241E-UL, FCV241G, FCV241G-CSA, FCV241GDM, FCV241GDM-CSA, FCV241GDS, FCV241GDS-CSA, FCV401DM, FCV401DM-CSA, FCV401EDM, FCV401EDM-UL, FCV61, FCV61-CSA, FCV61DM...(Other models you can see in the webshop)		

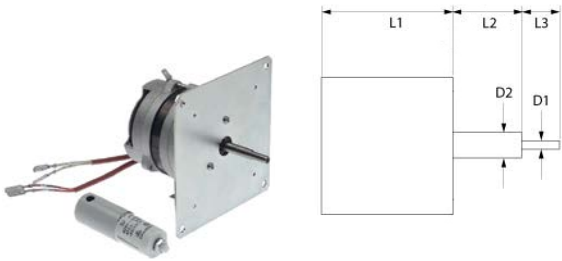

GEV No.	601104	Ref. No.	32M4301
description	fan motor 220-240V 1 phase 50/60Hz 0.045/0.0765kW 2800/3400rpm speeds 1 L1 97mm L2 41mm L3 19mm D1 ø 8mm D2 ø 10mm 0.35A suitable capacitor 2µF/400V power input 45W at 50Hz 2800/3400rpm		
For models:	1G1FA0EV, 1G1FA0GV, 1G1PE1EV, 1G1PE2EV, 2G1FA0GV, 2G1PE1EV, 2G1PE2EV, 31GE, 31TC, 31TCE, 32TC, 32TCE		

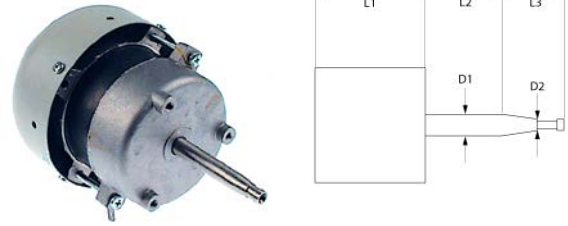

GEV No.	601210	Ref. No.	32M4260
description	fan motor 220-240V 1 phase 50Hz 0.075kW 2800rpm speeds 1 L1 120mm L2 38mm L3 36mm D1 ø 12mm D2 ø 8mm M5R IT 0.55A suitable capacitor 2.5µF/400V at 50Hz 2800rpm type 1074		
For models:	FCV3EM, FCV4E, FCV4EDS, FCV4EM, FM423E1, FM423E2		

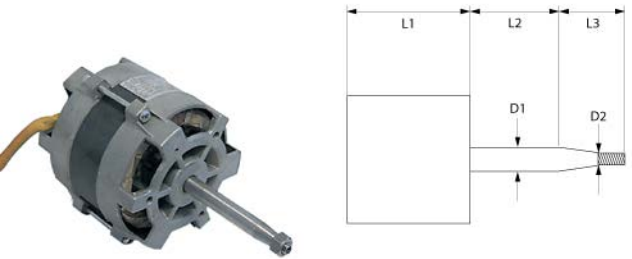

GEV No.	601043	Ref. No.	32M1500
description	fan motor 220-240V 1 phase 50Hz 0.37/0.07kW 0.1/0.5HP 1400/2700rpm speeds 2 L1 123mm L2 107mm L3 15mm D1 ø 15mm D2 ø 12mm M10L ET 2/0.7A suitable capacitor 20µF/250V at 50Hz 1400/2700rpm type 1057		
accessories for	601043		
GEV No.	365019	Ref. No.	—
description	operating capacitor capacity 20µF 400V tolerance 5% 50/60Hz ambient temperature max. -25 to +85°C ø 39.5mm L 70mm M8 plastic connection male faston 6.3mm 16.10.25. protection		

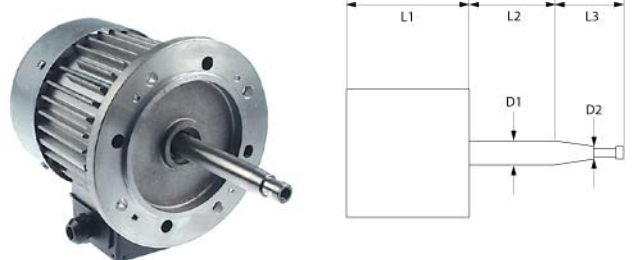

GEV No.	601211	Ref. No.	32M3820
description	fan motor 230/400-415V 3 phase 50/60Hz 0.25kW 1400/1600rpm speeds 1 L1 175mm L2 70mm L3 27mm D1 ø 17mm D2 ø 12mm M8R IT 1.4/0.8A at 50Hz 1400rpm at 60Hz 1600rpm type 1046.4530		
For models:	FC101, FC101E, FC241, FC241E, FC241G, FC61, FC61E, FCV101, FCV101DS, FCV101E, FCV101EDS, FCV141, FCV141DS, FCV141E, FCV141EDS, FCV241, FCV241DS, FCV241E, FCV241EDS, FCV241G, FCV241GDS, FCV61, FCV61DS, FCV61E, FCV61EDS		
accessories for	601211		
GEV No.	550690	Ref. No.	31S0900
description	shaft sealing for fan motor		

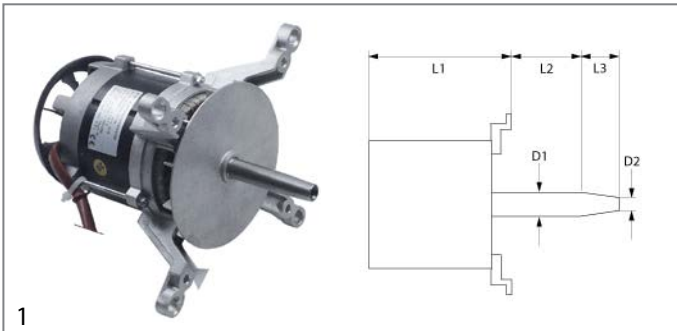

GEV No.	601713	Ref. No.	32M6722
description	fan motor 230/400V 1 phase 50/60Hz 0.55kW 0.75HP 1400rpm speeds 1 L1 200mm L2 53mm L3 32mm D1 ø 18mm D2 ø 15mm M10x1 suitable capacitor 31.5µF Cos(φ) 0.72 at 50Hz 1400rpm at 60Hz 1700rpm type 3065A4051		
For models:	FC1011E, FC1011G, FC1221E, FC1221G, FC611E, FC611G, FM1011E1, FM1011E1-VERS.2006, FM1011E2, FM1011E2-VERS.2006, FM1011E3, FM1011G1, FM1011G1-VERS.2006, FM1011G2, FM1011G2-VERS.2006, FM1011G3, FM1221E1, FM1221E1-VERS.2006, FM1221E2, FM1221E2-VERS.2006, FM1221E3, FM1221G1, FM1221G2, FM1221G3, FM2011E2-VERS.2006, FM2011G2-VERS.2006, FM2021E1, FM2021E2, FM2021E2-VERS.2006, FM2021E3, FM2021G1, FM2021G2, FM2021G3, FM611E1, FM611E1-VERS.2006, FM611E2, FM611E2-VERS.2006, FM611E3, FM611G1, FM611G1-VERS.2006, FM611G2, FM611G2-VERS.2006, FM611G3, FM721E1, FM721E1-VERS.2006, FM721E2, FM721E2-VERS.2006, FM721E3, FM721G1, FM721G1-VERS.2006...(Other models you can see in the webshop)		



GEV No.	602175	Ref. No.	3103750
description	fan motor 230/400V 3 phase 50/60Hz 0.7kW 1400/1700rpm L1 150mm L2 80mm L3 32mm D1 ø 18mm D2 ø 15mm M8 suitable capacitor 3µF400V type 3042P4050		
For models:	BX101E, BX101E-VERS.122013, BX101G, BX101G-VERS.122013, BX61E, BX61E-VERS.122013, BX61G, BX61G-VERS.122013, BX82E, BX82E-VERS.122013, BX82G, BX82G-VERS.122013, FX101E1, FX101E1R, FX101E2, FX101E2C, FX101E2C-VERS.032014, FX101E2R, FX101E2R-VERS.032014, FX101E2-VERS.032014, FX101E3, FX101E3C, FX101E3C-VERS.022014, FX101E3R, FX101E3R-VERS.022014, FX101E3-VERS.022014, FX101G3, FX101G3C, FX101G3C-VERS.022014, FX101G3R, FX101G3R-VERS.022014, FX101G3-VERS.022014, FX10E2CR, FX10E2CR-VERS.032014, FX10E3CR, FX10E3CR-VERS.022014, FX10G3CR, FX10G3CR-VERS.022014, FX201E2, FX201E2P, FX201E2P-VERS.032014, FX201E2-VERS.032014, FX201E3, FX201E3P, FX201E3P-VERS.022014, FX201E3-VERS.022014, FX201G2P, FX201G2P-VERS.032014, FX201G3P, FX201G3-VERS.022014...(Other models you can see in the webshop)		

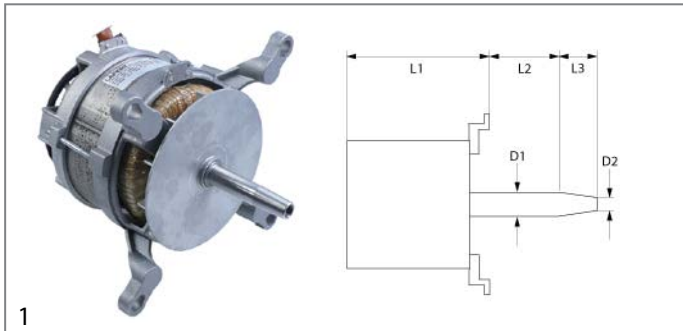

GEV No.	601598	Ref. No.	3001182
description	fan motor 230V 1 phase 50Hz 0.22/0.55kW 960/1430rpm speeds 2 L1 175mm L2 52mm L3 32mm D1 ø 15mm D2 ø 18mm M10R IT 1.7/3.7A suitable capacitor 36/25 Cos(φ) 0.96 at 50Hz 960/1430rpm type LM/ FB 100L		
For models:	FM1011G1, FM1011G2, FM1011G3, FM1011G3-VERS.2006, FM2011G3-VERS.2006, FM611G1, FM611G2, FM611G3, FM611G3-VERS.2006, FM721G1, FM721G2, FM721G3, FM721G3-VERS.2006		

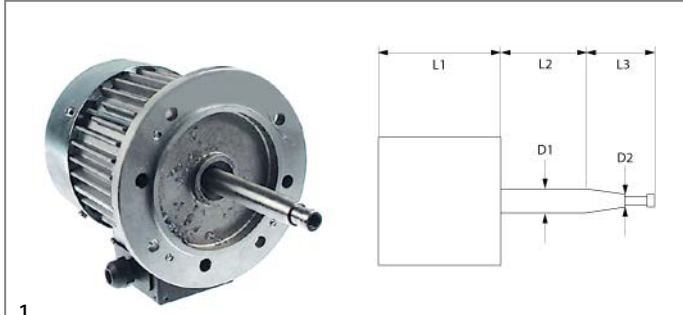

GEV No.	601212	Ref. No.	32M3880
description	fan motor 380-400-415V 3 phase 50Hz 0.04/0.33HP 700/1400rpm speeds 2 L1 180mm L2 70mm L3 27mm D1 ø 17mm D2 ø 12mm M8R IT 0.4/0.9A at 50Hz 700/1400rpm type 1046/4-8		
For models:	FCV101DM, FCV101EDM, FCV141DM, FCV141EDM, FCV241DM, FCV241EDM, FCV241GDM, FCV401EDM, FCV61DM, FCV61EDM		



GEV No.	602173	Ref. No.	32M6760 32M6761
description	fan wheel blades 12 D1 ø 365mm D2 ø 14mm D3 ø 18mm H1 140mm H2 23mm		
For models:	FC1221E, FC1221G, FM1221E1, FM1221E1-VERS.2006, FM1221E2, FM1221E2-VERS.2006, FM1221E3, FM1221E3-VERS.2006, FM1221G1, FM1221G1-VERS.2006, FM1221G2, FM1221G2-VERS.2006, FM1221G3, FM1221G3-VERS.2006, FM2021E1, FM2021E2, FM2021E2-VERS.2006, FM2021E3, FM2021E3-VERS.2006, FM2021G1, FM2021G2, FM2021G2-VERS.2006, FM2021G3, FM2021G3-VERS.2006		

1

GEV No.	601109	Ref. No.	32M0370
description	fan wheel D1 ø 160mm H1 35mm blades 12 D2 ø 8mm D3 ø 8mm H2 15mm		
For models:	1G1FA0EV, 1G1FA0GV, 1G1PE1EV, 1G1PE2EV, 2G1FA0GV, 2G1PE1EV, 2G1PE2EV, 31GE, 31TC, 31TCE, 32TC, 32TCE		



1

GEV No.	514449	Ref. No.	32M6741
description	fan wheel D1 ø 283mm H1 140mm blades 8 D2 ø 15mm D3 ø 18mm		
For models:	FC611E, FC611G, FM611E1, FM611E1-VERS.2006, FM611E2, FM611E2-VERS.2006, FM611E3, FM611E3-VERS.2006, FM611G1, FM611G1-VERS.2006, FM611G2, FM611G2-VERS.2006, FM611G3, FM611G3-VERS.2006		



1

GEV No.	601221	Ref. No.	32M4270 32M4271
description	fan wheel D1 ø 180mm H1 60mm blades 12 D2 ø 9mm D3 ø 12.5mm H2 35mm		
For models:	FCV3EM, FCV4E, FCV4EDS, FCV4EM, FM423E1, FM423E2		



1

GEV No.	601208	Ref. No.	32M2561
description	fan wheel D1 ø 335mm H1 135mm blades 12 D2 ø 12mm D3 ø 18mm H2 56mm		
For models:	FC101, FC101E, FCV101, FCV101-CSA, FCV101DM, FCV101DM-CSA, FCV101DS, FCV101DS-CSA, FCV101E, FCV101EDM, FCV101EDM-UL, FCV101EDS, FCV101EDS-UL, FCV101E-UL, FCV141, FCV141-CSA, FCV141DM, FCV141DM-CSA, FCV141DS, FCV141DS-CSA, FCV141E, FCV141EDM, FCV141EDS, FCV72EDM-UL, FCV72EDS-UL, FCV72E-UL		



1

GEV No.	601060	Ref. No.	32M1570
description	fan wheel D1 ø 180mm H1 60mm blades 16 D2 ø 11mm D3 ø 16mm H2 30mm		



1

GEV No.	601209	Ref. No.	32M3992
description	fan wheel D1 ø 400mm H1 135mm blades 20 D2 ø 12mm D3 ø 18mm H2 54mm		
For models:	FC241E, FC241G, FCV241E, FCV241EDM, FCV241EDM-UL, FCV241EDS, FCV241EDS-UL, FCV241E-UL, FCV241G, FCV241G-CSA, FCV241GDM, FCV241GDM-CSA, FCV241GDS, FCV241GDS-CSA, FCV401EDM, FCV401EDM-UL		





1

GEV No.	601207	Ref. No.	32M3811 32M3812
description	fan wheel D1 ø 280mm H1 135mm blades 12 D2 ø 12mm D3 ø 18mm H2 55mm		
For models:	FC61, FC61E, FCV61, FCV61-CSA, FCV61DM, FCV61DM-CSA, FCV61DS, FCV61DS-CSA, FCV61E, FCV61EDM, FCV61EDM-UL, FCV61EDS, FCV61EDS-UL, FCV61E-UL		





			
1			
GEV No.	550687	Ref. No.	33Q6320
description	flange for fan motor		
For models:	FCV3EM, FCV4E, FCV4EDS, FCV4EM		

			
1			
GEV No.	552005	Ref. No.	36E3160
description	flange for fan motor ED ϕ 56mm int. ϕ 1 38mm int. ϕ 2 20mm thickness 8mm brass		
For models:	BX101E, BX101E-VERS.122013, BX101G, BX101G-VERS.122013, BX122E, BX122E-VERS.122013, BX122G, BX122G-VERS.122013, BX61E, BX61E-VERS.122013, BX61G, BX61G-VERS.122013, BX82E, BX82E-VERS.122013, BX82G, BX82G-VERS.122013, FC1011E, FC1011G, FC1221E, FC1221G, FC611E, FC611G, FM1011E1, FM1011E1-VERS.2006, FM1011E2, FM1011E2-VERS.2006, FM1011E3, FM1011E3-VERS.2006, FM1011G1, FM1011G1-VERS.2006, FM1011G2, FM1011G2-VERS.2006, FM1011G3, FM1011G3-VERS.2006, FM1221E1, FM1221E1-VERS.2006, FM1221E2, FM1221E2-VERS.2006, FM1221E3, FM1221E3-VERS.2006, FM1221G1, FM1221G1-VERS.2006, FM1221G2, FM1221G2-VERS.2006, FM1221G3, FM1221G3-VERS.2006, FM2011E2-VERS.2006, FM2011E3-VERS.2006, FM2011G2-VERS.2006, FM2011G3-VERS.2006...(Other models you can see in the webshop)		

			
1			
GEV No.	552006	Ref. No.	33Q5381
description	flange for fan motor ED ϕ 57.5mm int. ϕ 1 35mm int. ϕ 2 23mm thickness 2mm		
For models:	FC101, FC101E, FC241, FC241E, FC241G, FC61, FC61E, FCV101, FCV101-CSA, FCV101DM, FCV101DM-CSA, FCV101DS, FCV101DS-CSA, FCV101E, FCV101EDM, FCV101EDM-UL, FCV101EDS, FCV101EDS-UL, FCV101E-UL, FCV141, FCV141-CSA, FCV141DM, FCV141DM-CSA, FCV141DS, FCV141DS-CSA, FCV141E, FCV141EDM, FCV141EDS, FCV241, FCV241DM, FCV241DS, FCV241E, FCV241EDM, FCV241EDM-UL, FCV241EDS, FCV241EDS-UL, FCV241E-UL, FCV241G, FCV241G-CSA, FCV241GDM, FCV241GDM-CSA, FCV241GDS, FCV241GDS-CSA, FCV401DM, FCV401DM-CSA, FCV401EDM, FCV401EDM-UL, FCV61, FCV61-CSA, FCV61DM...(Other models you can see in the webshop)		

			
1			
GEV No.	697866	Ref. No.	33Q5690
description	flange for fan motor ED ϕ 58mm int. ϕ 1 38.8mm int. ϕ 2 19/23mm brass		
For models:	FC101, FC101E, FC241, FC241E, FC241G, FC61, FC61E, FCV101, FCV101-CSA, FCV101DM, FCV101DM-CSA, FCV101DS, FCV101DS-CSA, FCV101E, FCV101EDM, FCV101EDM-UL, FCV101EDS, FCV101EDS-UL, FCV101E-UL, FCV141, FCV141-CSA, FCV141DM, FCV141DM-CSA, FCV141DS, FCV141DS-CSA, FCV141E, FCV141EDM, FCV141EDS, FCV241, FCV241DM, FCV241DS, FCV241E, FCV241EDM, FCV241EDM-UL, FCV241EDS, FCV241EDS-UL, FCV241E-UL, FCV241G, FCV241G-CSA, FCV241GDM, FCV241GDM-CSA, FCV241GDS, FCV241GDS-CSA, FCV401DM, FCV401DM-CSA, FCV401EDM, FCV401EDM-UL, FCV61, FCV61-CSA, FCV61DM...(Other models you can see in the webshop)		

			
1			
GEV No.	550686	Ref. No.	37Q0250
description	gasket for fan motor ID ϕ 12mm ED ϕ 58mm thickness 1mm with 3 screw holes		
For models:	BX101E, BX101E-VERS.122013, BX101G, BX101G-VERS.122013, BX122E, BX122E-VERS.122013, BX122G, BX122G-VERS.122013, BX61E, BX61E-VERS.122013, BX61G, BX61G-VERS.122013, BX82E, BX82E-VERS.122013, BX82G, BX82G-VERS.122013, FC1011E, FC1011G, FC1221E, FC1221G, FC611E, FC611G, FCV3EM, FCV4E, FCV4EDS, FCV4EM, FM1011E1, FM1011E1-VERS.2006, FM1011E2, FM1011E2-VERS.2006, FM1011E3, FM1011E3-VERS.2006, FM1011G1, FM1011G1-VERS.2006, FM1011G2, FM1011G2-VERS.2006, FM1011G3, FM1011G3-VERS.2006, FM1221E1, FM1221E1-VERS.2006, FM1221E2, FM1221E2-VERS.2006, FM1221E3, FM1221E3-VERS.2006, FM1221G1, FM1221G1-VERS.2006, FM1221G2, FM1221G2-VERS.2006, FM1221G3, FM1221G3-VERS.2006...(Other models you can see in the webshop)		

			
1			
GEV No.	550689	Ref. No.	37Q3011
description	gasket for fan motor ID ϕ 40mm ED ϕ 58mm thickness 1mm with 3 screw holes		
For models:	FC101, FC101E, FC241, FC241E, FC241G, FC61, FC61E, FCV101, FCV101-CSA, FCV101DM, FCV101DM-CSA, FCV101DS, FCV101DS-CSA, FCV101E, FCV101EDM, FCV101EDM-UL, FCV101EDS, FCV101EDS-UL, FCV101E-UL, FCV141, FCV141-CSA, FCV141DM, FCV141DM-CSA, FCV141DS, FCV141DS-CSA, FCV141E, FCV141EDM, FCV141EDS, FCV241, FCV241DM, FCV241DS, FCV241E, FCV241EDM, FCV241EDM-UL, FCV241EDS, FCV241EDS-UL, FCV241E-UL, FCV241G, FCV241G-CSA, FCV241GDM, FCV241GDM-CSA, FCV241GDS, FCV241GDS-CSA, FCV3EM, FCV401DM, FCV401DM-CSA, FCV401EDM, FCV401EDM-UL, FCV4E, FCV4EDS...(Other models you can see in the webshop)		

			
1			
GEV No.	550690	Ref. No.	3150900
description	shaft sealing for fan motor		
For models:	FC101, FC101E, FC241, FC241E, FC241G, FC61, FC61E, FCV101, FCV101-CSA, FCV101DM, FCV101DM-CSA, FCV101DS, FCV101DS-CSA, FCV101E, FCV101EDM, FCV101EDM-UL, FCV101EDS, FCV101EDS-UL, FCV101E-UL, FCV141, FCV141-CSA, FCV141DM, FCV141DM-CSA, FCV141DS, FCV141DS-CSA, FCV141E, FCV141EDM, FCV141EDS, FCV241, FCV241DM, FCV241DS, FCV241E, FCV241EDM, FCV241EDM-UL, FCV241EDS, FCV241EDS-UL, FCV241E-UL, FCV241G, FCV241G-CSA, FCV241GDM, FCV241GDM-CSA, FCV241GDS, FCV241GDS-CSA, FCV401DM, FCV401DM-CSA, FCV401EDM, FCV401EDM-UL, FCV61, FCV61-CSA, FCV61DM...(Other models you can see in the webshop)		



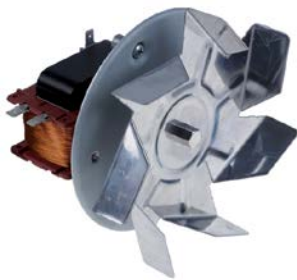

hot air fans

miscellaneous

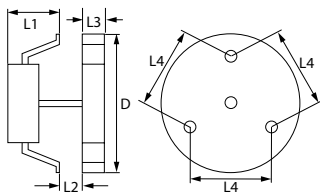

1



GEV No.	601011	Ref. No.	32M0360 32M2320 32M2420 32M5690
description	hot air fan 220-240V 40W 50/60Hz L1 65mm L2 15mm L3 25mm L4 87mm fan wheel ø 150mm FIME type C25R8023CLH		
For models:	A12A1E, A12B1E, A12B2E, A12M1E, A12Z1E, A12Z2E, A14A1E, A14B1E, A14B2E, A14M1E, A14Z1E, A14Z2E, A16A1E, A16B1E, A16B2E, A16M1E, A16Z1E, A16Z2E, A18A1E, A18B1E, A18B2E, A18M1E, A18Z1E, A18Z2E, A20A1E, A20B1E, A20B2E, A20M1E, A20Z1E, A20Z2E, ACBM, ACBM218, ACPN, ACPN218, AJ12AE, AJ12ME, AJ14AE, AJ14ME, AJ16AE, AJ16ME, AJ18AE, AJ18ME, AJ20AE, AJ20ME, SL14CPN, SL14CVB, SL21CPN, SL21CVB		
accessories for	601011		
	GEV No.	550879	Ref. No. —
	insulation ø 130mm thickness 3mm hole ø 20mm for hot air fan		
	GEV No.	601260	Ref. No. —
	nut thread M6L IT for hot air fan		

accessories

fan wheels for hot air fans



1

GEV No.	601710	Ref. No.	32M2510
description	fan wheel ø 225mm shaft intake ø 7mm aluminium blades 5		
For models:	120, 120NN, 135A, 135BN, 135BNX, 135CPX, 135XE, 40B, 40CP, 40CPX, 55B, 65, 65A, 65BA, 65BXE, 65NB, 65NBX, 65NN, 65NNX, 65PVX, 65X, 65X-2, 65XE, 6BEA11A, 6BEA11B, 6BEA11M, 6BEA11Z, 6BEA2A, 6BEA2B, 6BEA2M, 6BEA2Z, 6BEA3A, 6BEA3B, 6BEA3M, 6BEA3Z, 6BEAA, 6BEAB, 6BEABA, 6BEABB, 6BEABM, 6BEABZ, 6BEAM, 6BEAZ, 6BEB11A, 6BEB11B, 6BEB11M, 6BEB11Z, 6BEB22A, 6BEB22B, 6BEB22M...(Other models you can see in the webshop)		

radial fans



1

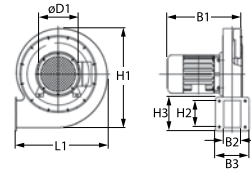

GEV No.	601870	Ref. No.	32V6840
description	radial fan 230/240V voltage AC 50/60Hz H1 180mm L1 175mm D1 ø 75mm W1 80mm W2 50mm H2 50mm W3 83mm H3 83mm		
For models:	FC1221G, FM1221G1, FM1221G1-VERS.2006, FM1221G2, FM1221G2-VERS.2006, FM1221G3, FM1221G3-VERS.2006, FM2021G1, FM2021G2, FM2021G2-VERS.2006, FM2021G3, FM2021G3-VERS.2006		



1

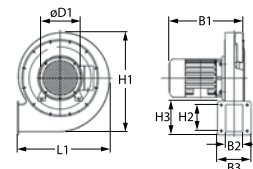

GEV No.	601599	Ref. No.	32V5830
description	radial fan 230V voltage AC 50Hz 60W H1 175mm L1 205mm D1 ø 109mm W1 135mm W2 58mm H2 58mm convection oven		
For models:	FC1011G, FC611G, FM1011G1, FM1011G1-VERS.2006, FM1011G2, FM1011G2-VERS.2006, FM1011G3, FM1011G3-VERS.2006, FM2011G2-VERS.2006, FM2011G3-VERS.2006, FM611G1, FM611G1-VERS.2006, FM611G2, FM611G2-VERS.2006, FM611G3, FM611G3-VERS.2006, FM721G1, FM721G1-VERS.2006, FM721G2, FM721G2-VERS.2006, FM721G3, FM721G3-VERS.2006		

accessories universal



1

GEV No.	801197	Ref. No.	3018670 6003060
description	puller for fan wheel seat ø 27-33mm thread M16x1.5 WS 17		
For models:	FM1011E1, FM1011E2, FM1011E3, FM1011G1, FM1011G2, FM1011G3, FM1221E1, FM1221E2, FM1221E3, FM1221G1, FM1221G2, FM1221G3, FM611E1, FM611E2, FM611E3, FM611G1, FM611G2, FM611G3		
spare parts for	801197		
	GEV No.	801198	Ref. No. 3019160
	screw for puller thread M16x1.5 L 63mm WS 17		



pumps

wash and rinse pumps

ALBA (C&A)

pumps



1



1

GEV No.	500181	Ref. No.	32M2940
description	pump inlet ø 45mm outlet ø 40mm type C7675 230V 50Hz 1 phase 0.29kW 0.4HP L 175mm rotation direction right capacitor 10µF ALBA PUMPS (C&A)		
For models:	LT20F, LT25F		
spare parts for	500181		
	GEV No.	365015	Ref. No. —
	operating capacitor capacity 10µF 400V tolerance 5%Hz ambient temperature max. -25 to +85°C ø 35.5mm L 59mm M8 plastic connection male faston 6.3mm protection		
	GEV No.	509018	Ref. No. —
	O-ring EPDM thickness 3.53mm ID ø 107.5mm Qty 1 pcs		
	GEV No.	509028	Ref. No. —
	impellor ø 87mm H 21mm rotation direction right thread M7L shaft ø 12mm		
	GEV No.	510693	Ref. No. 3036790 3152080
	mechanical shaft seal for shaft ø 12mm slide ring ext. ø 24mm slide ring H 15.5mm slide ring int. ø 11mm counter ring mounting ø 24mm height counter ring 8mm counter ring int. ø 13.5mm		
	GEV No.	521528	Ref. No. 36G8080
	pump cover ALBA PUMPS (C&A) inlet ø 45mm outlet ø 40mm turn direction right ø 129mm ID ø 105mm inner height 19mm		





GEV No.	500180	Ref. No.	32M2950
description	pump inlet ø 28mm outlet ø 28mm type C7670 230V 50Hz 1 phase 0.11kW 0.15HP L 190mm rotation direction right capacitor 6.3µF ALBA PUMPS (C&A)		
For models:	LT10R		
spare parts for	500180		
	GEV No.	365012	Ref. No. —
	operating capacitor capacity 6.3µF 450V tolerance 5% 50Hz ambient temperature max. -25 to +85°C ø 30mm L 61mm M8 plastic connection male faston 6.3mm protection		
	GEV No.	510692	Ref. No. —
	mechanical shaft seal for shaft ø 11mm slide ring ext. ø 24mm slide ring H 13mm counter ring mounting ø 26mm height counter ring 8mm counter ring int. ø 14mm		
	GEV No.	521222	Ref. No. —
	impellor ø 72mm H 19mm thread M7L shaft ø 11mm shaft length 29mm blades 3		
	GEV No.	521518	Ref. No. —
	pump cover ALBA PUMPS (C&A) inlet ø 28mm outlet ø 28mm turn direction right ø 93mm ID ø 76mm inner height 31mm		
	GEV No.	532490	Ref. No. —
	O-ring EPDM thickness 2.62mm ID ø 72.69mm Qty 1 pcs		

FIR

pumps





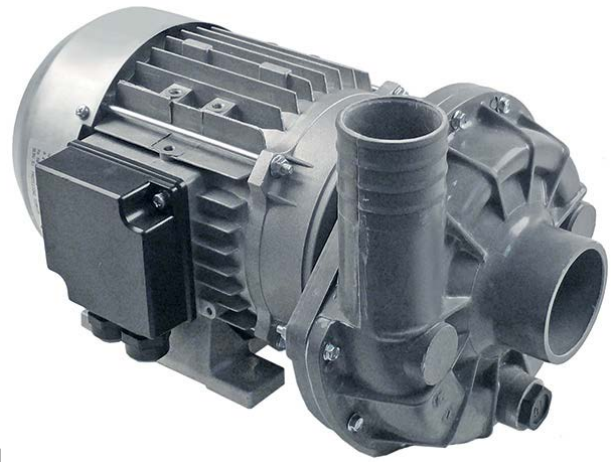

1

GEV No.	500010	Ref. No.	32M2140
description	pump inlet ø 45mm outlet ø 40mm type 2292.1506 230V 50Hz 1 phase 0.55kW 0.75HP L 238mm rotation direction right capacitor 12.5µF FIR		
For models:	L40, L40S		
spare parts for	500010		
	GEV No.	365014	Ref. No. 32Z1310
	operating capacitor capacity 12.5µF 450V tolerance 5%Hz ambient temperature max. -25 to +85°C ø 35mm L 70mm M8 plastic connection male faston 6.3mm 45S.C3DS.12.5 protection		
	GEV No.	510600	Ref. No. 32G0260
	impellor ø 102mm H 29mm shaft intake ø 9/8mm rotation direction right blades 6		
	GEV No.	510692	Ref. No. —
	mechanical shaft seal for shaft ø 11mm slide ring ext. ø 24mm slide ring H 13mm counter ring mounting ø 26mm height counter ring 8mm counter ring int. ø 14mm		
	GEV No.	521023	Ref. No. —
	fanwheel cover ED ø 150mm H 70mm for wash pump		
	GEV No.	521506	Ref. No. —
	pump cover FIR inlet ø 45mm outlet ø 40mm turn direction right ø 160mm ID ø 125mm inner height 25mm		
	GEV No.	521702	Ref. No. —
	pump cover gasket thickness 3.5x4.5mm Qty 1 pcs		



1

GEV No.	500023	Ref. No.	32M3660
description	pump inlet ø 63mm outlet ø 47mm type 1225.2725 230/400V 50Hz 3 phase 1.1kW 1.5HP L 335mm rotation direction right FIR		
spare parts for	500023		
	GEV No.	510602	Ref. No. —
	impellor ø 110mm H 34mm rotation direction right thread M8L shaft ø 28mm seat ø 12.2mm blades 6		
	GEV No.	510693	Ref. No. 3036790 3152080
	mechanical shaft seal for shaft ø 12mm slide ring ext. ø 24mm slide ring H 15.5mm slide ring int. ø 11mm counter ring mounting ø 24mm height counter ring 8mm counter ring int. ø 13.5mm		
	GEV No.	521513	Ref. No. 36D8510
	pump cover FIR inlet ø 63mm outlet ø 47mm turn direction right ID ø 150mm inner height 32mm		
	GEV No.	524416	Ref. No. —
	pump cover gasket thickness 4x4mm Qty 1 pcs		







1

GEV No.	500742	Ref. No.	32M1590
description	pump inlet ø 63mm outlet ø 47mm type 1226.2602 230/400V 50Hz 3 phase 1.5kW 2HP L 333mm rotation direction left FIR		
For models:	L80		







1

GEV No.	500323	Ref. No.	32M1480
description	pump inlet ø 63mm outlet ø 47mm type 1227.2721 230/400V 50Hz 3 phase 2kW 2.7HP L 335mm rotation direction right FIR		
For models:	L100		
spare parts for	500323		
	GEV No.	510599	Ref. No. —
	impellor ø 123mm H 34mm M8L		
	GEV No.	510693	Ref. No. 3036790 3152080
	mechanical shaft seal for shaft ø 12mm slide ring ext. ø 24mm slide ring H 15.5mm slide ring int. ø 11mm counter ring mounting ø 24mm height counter ring 8mm counter ring int. ø 13.5mm		
	GEV No.	521513	Ref. No. 36D8510
	pump cover FIR inlet ø 63mm outlet ø 47mm turn direction right ID ø 150mm inner height 32mm		
	GEV No.	524416	Ref. No. —
	pump cover gasket thickness 4x4mm Qty 1 pcs		



1

GEV No.	500117	Ref. No.	32M0020
description	pump inlet ø 63mm outlet ø 47mm type 4225.22725 230/400V 50Hz 3 phase 1.4kW 2HP L 280mm rotation direction right FIR		
For models:	L80		
spare parts for	500117		
	GEV No.	510602	Ref. No. —
	impellor ø 110mm H 34mm rotation direction right thread M8L shaft ø 28mm seat ø 12.2mm blades 6		

spare parts for	500117		
	GEV No.	510693	Ref. No. 3036790 3152080
	mechanical shaft seal for shaft ø 12mm slide ring ext. ø 24mm slide ring H 15.5mm slide ring int. ø 11mm counter ring mounting ø 24mm height counter ring 8mm counter ring int. ø 13.5mm		
	GEV No.	521513	Ref. No. 36D8510
	pump cover FIR inlet ø 63mm outlet ø 47mm turn direction right ID ø 150mm inner height 32mm		
	GEV No.	524416	Ref. No. —
	pump cover gasket thickness 4x4mm Qty 1 pcs		

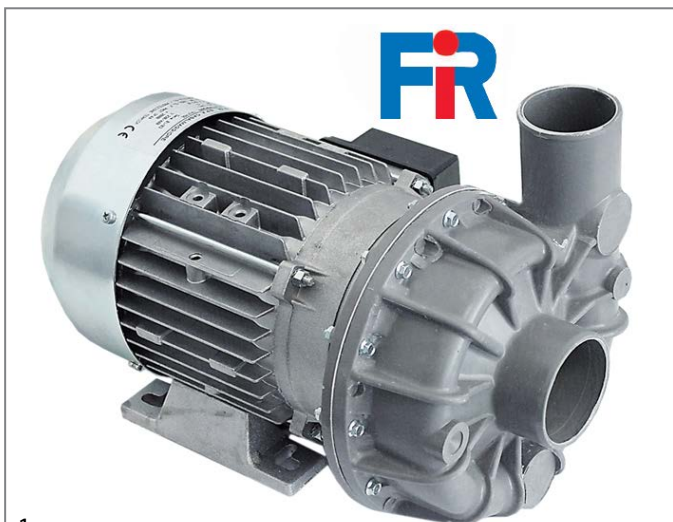

1

GEV No.	500111	Ref. No.	32M4820
description	pump inlet ø 63mm outlet ø 53mm type 1241.2500 230/400V 50Hz 3 phase 1.1kW 1.5HP L 330mm rotation direction left FIR		
For models:	C304AD, C304AD-VERS.2006, C304AS, C304AS-VERS.2006, C304AVD, C304AVD-VERS.2006, C304AVS, C304AVS-VERS.2006, C304D, C304D-VERS.2006, C304S, C304S-VERS.2006, C304VD, C304VD-VERS.2006, C304VS, C304VS-VERS.2006, CS243S-VERS.2006, CS370AD, CS370AD-VERS.2006, CS370AS, CS370AS-VERS.2006, CS370AVD, CS370AVD-VERS.2006, CS370AVS, CS370AVS-VERS.2006, CS370D, CS370D-VERS.2006, CS370S, CS370S-VERS.2006, CS370VD, CS370VD-VERS.2006, CS370VS, CS370VS-VERS.2006, CS466AD, CS466AD-VERS.2006, CS466AS, CS466AS-VERS.2006, CS466AVD, CS466AVD-VERS.2006, CS466AVS, CS466AVS-VERS.2006, CS466D, CS466D-VERS.2006, CS466S, CS466S-VERS.2006, CS466VD, CS466VD-VERS.2006, CS466VS, CS466VS-VERS.2006		
spare parts for	500111		
	GEV No.	510531	Ref. No. —
	pump cover FIR inlet ø 63mm outlet ø 53mm auxiliary pressure connection M16x1.5mm supporting pressure open turn direction left ø 185mm ID ø 150mm inner height 37mm		
	GEV No.	510612	Ref. No. —
	impellor ø 110mm H 34mm M8R		
	GEV No.	510693	Ref. No. 3036790 3152080
	mechanical shaft seal for shaft ø 12mm slide ring ext. ø 24mm slide ring H 15.5mm slide ring int. ø 11mm counter ring mounting ø 24mm height counter ring 8mm counter ring int. ø 13.5mm		
	GEV No.	524416	Ref. No. —
	pump cover gasket thickness 4x4mm Qty 1 pcs		



LGB



1

GEV No.	500094	Ref. No.	32M2920
description	pump inlet ø 28mm outlet ø 26mm type ZF131SX 230V 50Hz 1 phase 0.2kW 0.15HP L 195mm rotation direction left capacitor 6.3µF LGB		
For models:	F60PR, F60T, F80P, F80PR		
spare parts for	500094		
	GEV No.	365012	Ref. No. —
	operating capacitor capacity 6.3µF 450V tolerance 5% 50Hz ambient temperature max. -25 to +85°C ø 30mm L 61mm M8 plastic connection male faston 6.3mm protection		
	GEV No.	502266	Ref. No. —
	pump cover inlet ø 28mm outlet ø 26mm		
	GEV No.	510703	Ref. No. —
	mechanical shaft seal for shaft ø 13mm slide ring H 13mm height counter ring 5.5mm ED ø 26mm		
	GEV No.	521085	Ref. No. —
	impellor ø 72mm H 17mm thread M7L shaft ø 13mm shaft length 12mm blades 3		
	GEV No.	528800	Ref. No. —
	O-ring EPDM thickness 2.62mm ID ø 75.87mm Qty 1 pcs		



1

GEV No.	500508	Ref. No.	32M2910 32M4760
description	pump inlet ø 45mm outlet ø 38mm type ZF320VSX 230V 50Hz 1 phase 0.75kW 1HP L 230mm rotation direction right capacitor 12.5µF LGB		
For models:	F60P, F60PR, F60T, F80P, F80PR, L45		
spare parts for	500508		
	GEV No.	365014	Ref. No. 32Z1310
	operating capacitor capacity 12.5µF 450V tolerance 5%Hz ambient temperature max. -25 to +85°C ø 35mm L 70mm M8 plastic connection male faston 6.3mm 45S.C3DS.12.5 protection		
	GEV No.	510702	Ref. No. 3152680
	mechanical shaft seal height counter ring 5.5mm ID ø 12mm		
	GEV No.	521247	Ref. No. —
	impellor ø 90mm H 27mm rotation direction right thread M8L blades 6		
	GEV No.	521542	Ref. No. —
	pump cover LGB inlet ø 45mm outlet ø 40mm auxiliary pressure connection 13mm supporting pressure open ø 150mm ID ø 120mm inner high 25mm		
	GEV No.	521714	Ref. No. —
	pump cover gasket thickness 4x4mm Qty 1 pcs		



1

GEV No.	500984	Ref. No.	32M5770
description	pump inlet ø 45mm outlet ø 39mm type ZF270VSX 230V 50Hz 1 phase 0.4kW L 209mm rotation direction right capacitor 10µF LGB		
For models:	LF50, LF50E, LF50EM, LF50EMPS, LF50EMPS-VERS.122012, LF50EM-VERS.122012, LF50E-VERS.122012, LF50E-VERS.2007, LP70		



1

GEV No.	500377	Ref. No.	32M4830
description	pump inlet ø 61mm outlet ø 52mm type ZF800DX 230/400V 50Hz 3 phase 2kW 2.72HP L 330mm rotation direction left LGB		
For models:	C165D, C165S, C165VD, C165VS, C207D, C207D-VERS.2006, C207S, C207S-VERS.2006, C207VD, C207VD-VERS.2006, C207VS, C207VS-VERS.2006, C304AD, C304AD-VERS.2006, C304AS, C304AS-VERS.2006, C304AVD, C304AVD-VERS.2006, C304AVS, C304AVS-VERS.2006, C304D, C304D-VERS.2006, C304S, C304S-VERS.2006, C304VD, C304VD-VERS.2006, C304VS, C304VS-VERS.2006, C92D-VERS.2006, C92S-VERS.2006, C92VD-VERS.2006, C92VS-VERS.2006, CS243D, CS243D-VERS.2006, CS243S, CS243S-VERS.2006, CS243VD, CS243VD-VERS.2006, CS243VS, CS243VS-VERS.2006, CS370AD, CS370AD-VERS.2006, CS370AS, CS370AS-VERS.2006, CS370AVD, CS370AVD-VERS.2006, CS370AVS, CS370AVS-VERS.2006, CS370D, CS370D-VERS.2006...(Other models you can see in the webshop)		
spare parts for	500377		
	GEV No.	510551	Ref. No. 3FL1123
	pump cover gasket ID ø 158.3mm pump type 1214/1293/1225/2243/1226/1204/3473/1241 thickness 3.53mm EPDM Qty 1 pcs		
	GEV No.	510694	Ref. No. —
	mechanical shaft seal for shaft ø 13mm height counter ring 8mm ID ø 11.5mm H 16mm mounting ø 24/26mm int. ø 1 14mm		
	GEV No.	521276	Ref. No. —
	impellor ø 120mm H 39mm pump type ZF800DX shaft intake ø 12mm rotation direction left thread M8R pump for ZF800DX blades 6		
	GEV No.	521516	Ref. No. —
	pump cover LGB inlet ø 62mm outlet ø 52mm auxiliary pressure connection 12mm supporting pressure closed turn direction left ø 190mm ID ø 150mm inner height 40mm		











1

GEV No.	500376	Ref. No.	32M6180
description	pump inlet ø 62mm outlet ø 50mm type AM5225SX 230V 50Hz 1 phase 0.9kW 1.2HP L 300mm rotation direction right capacitor 16µF LGB		
For models:	LC80		
spare parts for	500376		
	GEV No.	365021	Ref. No. 32Z6080
	operating capacitor capacity 16µF 425V tolerance 5% 50/60Hz ambient temperature max. -25 to +85°C ø 35mm L 73mm single M8 plastic connection male faston 6.3mm 416.10.99 protection		
	GEV No.	510551	Ref. No. 3FL1123
	pump cover gasket ID ø 158.3mm pump type 1214/1293/1225/2243/1226/1204/3473/1241 thickness 3.53mm EPDM Qty 1 pcs		
	GEV No.	510694	Ref. No. —
	mechanical shaft seal for shaft ø 13mm height counter ring 8mm ID ø 11.5mm H 16mm mounting ø 24/26mm int. ø 1 14mm		
	GEV No.	512029	Ref. No. —
	impellor ø 103mm H 26mm thread M8L shaft ø 19mm shaft length 15mm seat ø 8.2mm		
	GEV No.	521536	Ref. No. —
	pump cover ALBA / LGB inlet ø 62mm outlet ø 50mm auxiliary pressure connection 12mm supporting pressure closed turn direction right ø 180mm ID ø 150mm inner height 38mm		



1

GEV No.	500379	Ref. No.	32M5740
description	pump inlet ø 62mm outlet ø 50mm type ZF650SX 230/400V 50Hz 3 phase 1.35kW 1.8HP L 335mm rotation direction right LGB		
For models:	LC100, N354D, N354S, N354VD, N354VS, N506D, N506S, N506VD, N506VS, N607D, N607S, N607VD, N607VS, N760D, N760S, N760VD, N760VS, N886D, N886S, N886VD, N886VS		
spare parts for	500379		
	GEV No.	510551	Ref. No. 3FL1123
	pump cover gasket ID ø 158.3mm pump type 1214/1293/1225/2243/1226/1204/3473/1241 thickness 3.53mm EPDM Qty 1 pcs		
	GEV No.	510694	Ref. No. —
	mechanical shaft seal for shaft ø 13mm height counter ring 8mm ID ø 11.5mm H 16mm mounting ø 24/26mm int. ø 1 14mm		
	GEV No.	521240	Ref. No. —
	impellor ø 110mm H 32mm rotation direction left thread M8L shaft ø 20mm shaft length 10mm seat ø 8.2mm blades 6		
	GEV No.	521536	Ref. No. —
	pump cover ALBA / LGB inlet ø 62mm outlet ø 50mm auxiliary pressure connection 12mm supporting pressure closed turn direction right ø 180mm ID ø 150mm inner height 38mm		

spare parts for	499257		
	GEV No.	509007	Ref. No. —
	impellor ø 85mm H 20mm rotation direction left thread M10R shaft ø 12mm shaft length 7.5mm blades 12		
	GEV No.	510693	Ref. No. 3036790 3152080
	mechanical shaft seal for shaft ø 12mm slide ring ext. ø 24mm slide ring H 15.5mm slide ring int. ø 11mm counter ring mounting ø 24mm height counter ring 8mm counter ring int. ø 13.5mm		
	GEV No.	521167	Ref. No. 3101190
	pump cover OLYMPIA inlet ø 1"mm outlet ø 30/30mm ID ø 94mm		
	GEV No.	521723	Ref. No. 3116490
	pump cover gasket EPDM thickness 2mm ID ø 90mm Qty 1 pcs		

OLYMPIA

pumps







1





GEV No.	499257	Ref. No.	3037780
description	pump inlet ø 1" IT outlet ø 30mm type L63.T45F_2V 230V 50Hz 1 phase 0.33kW L 230mm rotation direction left capacitor 8µF OLYMPIA		
For models:	KD40		
spare parts for	499257		
	GEV No.	365013	Ref. No. 3222490
	operating capacitor capacity 8µF 400V tolerance 5%Hz ambient temperature max. -25 to +85°C ø 31.5mm L 55mm M8 plastic connection male faston 6.3mm protection		







1

GEV No.	500958	Ref. No.	3034630
description	pump inlet ø 33mm outlet ø 30/28mm type T45 230V 50Hz 1 phase 0.33kW 0.45HP L 215mm rotation direction left capacitor 8µF OLYMPIA		
For models:	KD40, KD40LSPS, KD40LUX		
spare parts for	500958		
	GEV No.	365013	Ref. No. 3222490
	operating capacitor capacity 8µF 400V tolerance 5%Hz ambient temperature max. -25 to +85°C ø 31.5mm L 55mm M8 plastic connection male faston 6.3mm protection		
	GEV No.	510693	Ref. No. 3036790 3152080
	mechanical shaft seal for shaft ø 12mm slide ring ext. ø 24mm slide ring H 15.5mm slide ring int. ø 11mm counter ring mounting ø 24mm height counter ring 8mm counter ring int. ø 13.5mm		
	GEV No.	521257	Ref. No. —
	impellor ø 80mm H 12mm rotation direction left thread M10R shaft ø 12mm shaft length 7.5mm blades 6		
	GEV No.	521551	Ref. No. —
	pump cover OLYMPIA inlet ø 33mm outlet ø 30mm outlet 2 ø 28mm turn direction left ø 103mm ID ø 93mm inner height 30mm		
	GEV No.	521723	Ref. No. 3116490
	pump cover gasket EPDM thickness 2mm ID ø 90mm Qty 1 pcs		



1			
GEV No.	500529	Ref. No.	3234970
description	pump inlet \varnothing 60mm outlet \varnothing 48mm type T12 230V 50Hz 1 phase 0.88kW 1.2HP L 270mm rotation direction right capacitor 16 μ F auxiliary pressure connection 10mm supporting pressure open OLYMPIA		
For models:	KN80, KN800, KN800PSD, KN80PS		
spare parts for	500529		
	GEV No.	365021	Ref. No. 32Z6080
	operating capacitor capacity 16 μ F 425V tolerance 5% 50/60Hz ambient temperature max. -25 to +85°C \varnothing 35mm L 73mm single M8 plastic connection male faston 6.3mm 416.10.99 protection		
	GEV No.	510693	Ref. No. 3036790 3152080
	mechanical shaft seal for shaft \varnothing 12mm slide ring ext. \varnothing 24mm slide ring H 15.5mm slide ring int. \varnothing 11mm counter ring mounting \varnothing 24mm height counter ring 8mm counter ring int. \varnothing 13.5mm		
	GEV No.	521010	Ref. No. —
	impeller \varnothing 98mm H 12mm M10L blades 8		
	GEV No.	521559	Ref. No. —
	pump cover OLYMPIA inlet \varnothing 60mm outlet \varnothing 48mm outlet 2 \varnothing 31 auxiliary pressure connection 10mm supporting pressure open turn direction right \varnothing 170mm ID \varnothing 150mm inner height 22mm		
	GEV No.	521727	Ref. No. —
	pump cover gasket EPDM thickness 1.78mm ID \varnothing 145mm Qty 1 pcs		

booster pumps I

1			
GEV No.	500358	Ref. No.	3057760
description	pump inlet \varnothing 3/8" outlet \varnothing 3/8" type PS46 230V 50Hz 0.45kW \varnothing 100mm L 200mm capacitor 10 μ F LGB		
For models:	KD100A, KD130A, KD60MA, KD60MPSA, KD85A, KD85PSA, LP151, LP70		
spare parts for	500358		
	GEV No.	510713	Ref. No. —
	slide ring for shaft \varnothing 12mm ED \varnothing 24mm H 16mm		
	GEV No.	510723	Ref. No. —
	counter ring H 8mm ED \varnothing 26mm ID \varnothing 13.5mm for mechanical shaft seal		
	GEV No.	698400	Ref. No. —
	pump cover gasket pump type PS46 thickness 2mm ID \varnothing 66mm Qty 1 pcs		
accessories for	500358		
	GEV No.	365015	Ref. No. —
	operating capacitor capacity 10 μ F 400V tolerance 5% ambient temperature max. -25 to +85°C \varnothing 35.5mm L 59mm M8 plastic connection male faston 6.3mm protection		
	GEV No.	511279	Ref. No. —
	hose connector brass straight thread 3/8" hose \varnothing 12mm Qty 1 pcs		
	GEV No.	520202	Ref. No. —
	hose connector nickel-plated brass straight thread 3/8" hose \varnothing 12mm Qty 1 pcs		
	GEV No.	520677	Ref. No. —
	hose connector brass straight thread 3/8" hose \varnothing 13mm Qty 1 pcs		

drain pumps

GRE			
1			
GEV No.	500051	Ref. No.	32M4430
description	drain pump inlet \varnothing 22/30mm outlet \varnothing 22mm 100W 230V 50Hz GRE		
For models:	PGA20, PGA30, PGA40, PGA60, PGA80, PGW20, PGW30, PGW40, PGW60, PGW80		







1

GEV No.	500980	Ref. No.	32M5220
description	drain pump inlet ø 30mm outlet ø 21mm 100W 230V 50Hz GRE		
For models:	F60T, F80P		

miscellaneous



1

GEV No.	500201	Ref. No.	N/A
description	drain pump inlet ø 24mm outlet ø 22mm 230V 100W		

vibration pumps



1

GEV No.	520159	Ref. No.	3007950
description	hose connector nickel-plated brass straight thread 1/8" hose ø 6mm Qty 1 pcs WS 12 total length 32mm thread L 7.5mm grommet ø 6mm grommet length 19.5mm		
For models:	FM1011E3, FM1011G3, FM1221E3, FM1221G3, FM2021E3, FM2021G3, FM423E2, FM611E3, FM611G3, FM721E3, FM721G3		



1

GEV No.	500972	Ref. No.	32M7000 32M7001
description	vibration pump 230V 47W 50Hz inlet ø 7 outlet ø 1/8" IT CEME type E507		
For models:	FM1011E3, FM1011E3-VERS.2006, FM1011G3, FM1011G3-VERS.2006, FM1221E3, FM1221E3-VERS.2006, FM1221G3-VERS.2006, FM2011E3-VERS.2006, FM2011G3-VERS.2006, FM2021E3, FM2021E3-VERS.2006, FM2021G3, FM2021G3-VERS.2006, FM611E3, FM611E3-VERS.2006, FM611G3, FM611G3-VERS.2006, FM721E3, FM721E3-VERS.2006, FM721G3, FM721G3-VERS.2006		

pumps for ice machines



1

GEV No.	501420	Ref. No.	32M6430
description	pump GRE 100W 230V 50Hz inlet ø 25mm outlet ø 22mm L 150mm total length 230mm for ice-cube maker		
For models:	PG80C, PG81CW, PGC132, PGC132-VERS.200911, PGC134W, PGC134W-VERS.200911, PGC210, PGC210-VERS.200911, PGC212W, PGC212W-VERS.200911		
spare parts for	501420		
	GEV No.	695417	Ref. No. —
	insulation for pump		



1

GEV No.	500047	Ref. No.	32M6310
description	pump REBO type MH30F1 30W 230V 50Hz outlet ø 12.7mm L 135mm rotation direction left		
For models:	PG22C, PG23C, PG23CW, PG24CW, PG30C, PG31CW, PG42C, PG43CW, PG60C, PG61CW		

condensators & interference suppression filters

starting capacitors

starting capacitors



1

GEV No.	365095	Ref. No.	32V1490
description	starting capacitor 43µF 330V 50/60Hz duty cycle 3 60A1D-330043NXET ø 36mm L 80mm M8 plastic connection cable 350mm 04P.5523CM		
For models:	120, 120NN, 120PV, 135A, 135XE, 40, 40CP, 40CPX, 40EV, 40EVP, 40PV, 40X, 40XPV, 55, 55PV, 65A, 65XE, 6FMA11A, 6FMA11B, 6FMA11M, 6FMA11Z, 6FMA2A, 6FMA2B, 6FMA2M, 6FMA2Z, 6FMA4A, 6FMA4B, 6FMA4M, 6FMA4Z, 6FMAA, 6FMAB, 6FMAM, 6FMAZ, 6FMB11A, 6FMB11B, 6FMB11M, 6FMB11Z, 6FMB2A, 6FMB2B, 6FMB2M, 6FMB2Z, 6FMB4A, 6FMB4B, 6FMB4M, 6FMB4Z, 6FMBA, 6FMBB, 6FMBM, 6FMBZ, 6FMC11A...(Other models you can see in the webshop)		

operating capacitors

plastic



1			
GEV No.	365014	Ref. No.	32Z1310
description	operating capacitor capacity 12.5µF 450V tolerance 5%Hz ambient temperature max. -25 to +85°C ø 35mm L 70mm M8 plastic connection male faston 6.3mm 45S.C3DS.12.5 protection		
For models:	L40, L40S		



1			
GEV No.	365021	Ref. No.	32Z6080
description	operating capacitor capacity 16µF 425V tolerance 5% 50/60Hz ambient temperature max. -25 to +85°C ø 35mm L 73mm single M8 plastic connection male faston 6.3mm 416.10.99 protection		
For models:	FC101, FC241, FC61, FCV101, FCV101DS, FCV141, FCV141DS, FCV141DS-CSA, FCV241, FCV241DS, FCV61, FCV61DS		



1			
GEV No.	365224	Ref. No.	32V6440
description	operating capacitor capacity 25µF 420V tolerance 5% 50/60Hz ø 45mm L 75mm M8 plastic connection male faston 6.3mm		
For models:	FM1011G3, FM1011G3-VERS.2006, FM2011G3-VERS.2006, FM611G3, FM611G3-VERS.2006, FM721G3, FM721G3-VERS.2006, FX61G1, FX61G1R, FX61G2, FX61G2C, FX61G2CR, FX61G2R		



1			
GEV No.	365225	Ref. No.	32V5980
description	operating capacitor capacity 35µF 420V tolerance 5% 50/60Hz ambient temperature max. -25 to +85°C ø 45mm L 95mm M8 plastic connection male faston 6.3mm protection		
For models:	FC1011G, FC611G, FM1011G1-VERS.2006, FM1011G2-VERS.2006, FM1011G3-VERS.2006, FM1221G1, FM1221G1-VERS.2006, FM1221G2, FM1221G2-VERS.2006, FM1221G3-VERS.2006, FM2011G2-VERS.2006, FM2011G3-VERS.2006, FM2021G2-VERS.2006, FM2021G3-VERS.2006, FM611G1-VERS.2006, FM611G2-VERS.2006, FM611G3-VERS.2006, FX101G1, FX101G1R, FX101G2, FX101G2C, FX101G2R, FX10G2CR, FX82G1, FX82G2, FX82G2C		



1			
GEV No.	365022	Ref. No.	32V6540
description	operating capacitor capacity 40µF 400V tolerance 5%Hz ambient temperature max. -25 to +85°C ø 45mm L 95mm M8 plastic connection male faston 6.3mm protection		
For models:	BX101G, BX101G-VERS.122013, BX82G, BX82G-VERS.122013, FM1011G1, FM1011G2, FM1011G3, FM611G1, FM611G2, FM611G3, FM721G1, FM721G1-VERS.2006, FM721G2, FM721G2-VERS.2006, FM721G3, FM721G3-VERS.2006, FX101G1, FX101G1R, FX101G2, FX101G2C, FX101G2C-VERS.032014, FX101G2R, FX101G2R-VERS.032014, FX101G2-VERS.032014, FX10G2CR, FX10G2CR-VERS.032014, FX201G2, FX201G2P, FX201G2P-VERS.032014, FX201G2-VERS.032014, FX202G2, FX202G2-VERS.032014, FX82G1, FX82G2, FX82G2C, FX82G2T, FX82G2T-VERS.032014		



1			
GEV No.	365013	Ref. No.	32Z2490
description	operating capacitor capacity 8µF 400V tolerance 5%Hz ambient temperature max. -25 to +85°C ø 31.5mm L 55mm M8 plastic connection male faston 6.3mm protection		
For models:	71AR		

filters

interference suppression filters

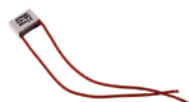

1			
GEV No.	365065	Ref. No.	32Z6100
description	interference suppression filter 100Ohm capacity 1µF		
For models:	FCV101DM, FCV101DS, FCV101EDM, FCV101EDS, FCV141DM, FCV141DS, FCV141EDM, FCV141EDS, FCV241DM, FCV241DS, FCV241EDM, FCV241EDS, FCV241GDM, FCV241GDS, FCV401DM, FCV401EDM, FCV4E, FCV4EDS, FCV61DM, FCV61DM-CSA, FCV61DS, FCV61EDM, FCV61EDM-UL, FCV61EDS		



fuses

fine fuses

1



GEV No.	358668	Ref. No.	3201540
description	fine fuse size ø5x20mm 0.5A fast-acting rated 250V Qty 10 pcs		
For models:	04WFR3ED, 08WFR4ED, 08WGREV, 091FR3ED, 0A1FR1ED, 0A1FR3ED, 0D1FR1ED, 0D1FR3ED, 0G0FR3ED, 10CP1EA, 10CP1GA, 10CP1IA, 12CP1EA, 12CP1GA, 12CP1IA, 18CP2EA, 18CP2GA, 18CP2IA, 191FR4ED, 1A1FR2ED, 1A1FR4ED, 1D1FR2ED, 1D1FR4ED, 71RA, 91RA, FC101, FC101E, FC1011G, FC101E, FC1221E, FC1221G, FC241, FC241E, FC241G, FC61, FC61E, FC611G, FC61E, FCV101, FCV101DM, FCV101DS, FCV101E, FCV101EDM, FCV101EDS, FCV141, FCV141DM, FCV141DS, FCV141E, FCV141EDM, FCV141EDS...(Other models you can see in the webshop)		

2



GEV No.	358671	Ref. No.	3200020
description	fine fuse size ø5x20mm 1A fast-acting rated 250V Qty 10 pcs		
For models:	06WBR3E, 0G1BR3E, 191BR1E, 191BR1GA, 191BR2E, 191BR2EA, 191BR2GA, 1A1BR1E, 1A1BR1GA, 1A1BR2E, 1A1BR2EA, 1A1BR2GA, 1D1BR1E, 1D1BR1GA, 1D1BR2E, 1D1BR2EA, 1D1BR2GA, 1G1BR3E, 291BR1E, 291BR1GA, 291BR2E, 291BR2EA, 291BR2GA, 2A1BR1E, 2A1BR1GA, 2A1BR2E, 2A1BR2EA, 2A1BR2GA, 2D1BR1E, 2D1BR1GA, 2D1BR2E, 2D1BR2EA, 2D1BR2GA, 71ARE, 91ARE, FCV401DM, FCV401EDM		

1



GEV No.	358031	Ref. No.	32V6210
description	fine fuse size ø10x38mm 10A rated 500V type Gg fast-acting Qty 1 pcs		
For models:	BX101E, BX101E-VERS.122013, BX122E, BX122E-VERS.122013, BX61E, BX61E-VERS.122013, BX82E, BX82E-VERS.122013, FC1011E, FC1221E, FC611E, FM1011E1, FM1011E1-VERS.2006, FM1011E2, FM1011E2-VERS.2006, FM1011E3, FM1011E3-VERS.2006, FM1221E1, FM1221E1-VERS.2006, FM1221E2, FM1221E2-VERS.2006, FM1221E3-VERS.2006, FM2011E2-VERS.2006, FM2011E3-VERS.2006, FM2021E1, FM2021E2, FM2021E2-VERS.2006, FM2021E3, FM2021E3-VERS.2006, FM611E1, FM611E1-VERS.2006, FM611E2, FM611E2-VERS.2006, FM611E3, FM611E3-VERS.2006, FM721E1, FM721E1-VERS.2006, FM721E2, FM721E2-VERS.2006, FM721E3, FM721E3-VERS.2006, FX101E1, FX101E1R, FX101E2, FX101E2C, FX101E2C-VERS.032014, FX101E2R, FX101E2R-VERS.032014, FX101E2-VERS.032014, FX101E3...(Other models you can see in the webshop)		

electric accessories

cables

earthing cables

1



GEV No.	100171	Ref. No.	32A2400 32A2401
description	earthing cable connection F2.8mm / lug M5 cable length 1200mm		
For models:	1A1FA1G, 1A1FA2G, 1A1FA4G, 1A1FA5G, 1A1FAAG, 1A1FABG, 1A1FAS2G, 1A1FASG, 1A1TP0G, 1A1TP0G-VERS.2002, 1B1FAS2G, 1B1FASG, 1D1FA1G, 1D1FA2G, 1D1FA4G, 1D1FA5G, 1D1FAAG, 1D1FABG, 1D1FAS2G, 1D1FASG, 1D1TP0G, 1D1TP0G-VERS.2002, 1G1BR1G, 2A1FA1G, 2A1FA4G, 2A1FAAG, 2A1FAS2G, 2A1FASG, 2A1TP3G, 2A1TP6G, 2A1TPCG, 2A1TPSG, 2D1FA1G, 2D1FA4G, 2D1FAAG, 2D1FAS2G, 2D1FASG, 2D1TP3G, 2D1TP6G, 2D1TPCG, 2D1TPSG, 3A1FA1G, 3A1FA4G, 3A1FAAG, 3A1FASG, 3D1FA1G, 3D1FA4G, 3D1FAAG, 3D1FASG, 60SM		

1



GEV No.	104684	Ref. No.	3113500
description	earthing cable connection F2.8mm / lug M5 cable length 350mm 1.5mm ²		
For models:	BX101G, BX101G-VERS.122013, BX122G, BX122G-VERS.122013, BX61G, BX61G-VERS.122013, BX82G, BX82G-VERS.122013, FC1011G, FC611G, FM1011G1, FM1011G1-VERS.2006, FM1011G2, FM1011G2-VERS.2006, FM1011G3, FM1011G3-VERS.2006, FM2011G2-VERS.2006, FM2011G3-VERS.2006, FM611G1, FM611G1-VERS.2006, FM611G2, FM611G2-VERS.2006, FM611G3, FM611G3-VERS.2006, FM721G1, FM721G1-VERS.2006, FM721G2, FM721G2-VERS.2006, FM721G3, FM721G3-VERS.2006, FX101G1, FX101G1R, FX101G2, FX101G2C, FX101G2C-VERS.032014, FX101G2R, FX101G2R-VERS.032014, FX101G2-VERS.032014, FX101G3, FX101G3C, FX101G3C-VERS.022014, FX101G3R, FX101G3R-VERS.022014, FX101G3-VERS.022014, FX10G2CR, FX10G2CR-VERS.032014, FX10G3CR, FX10G3CR-VERS.022014, FX122G1, FX122G2...(Other models you can see in the webshop)		

1



GEV No.	100173	Ref. No.	32A0441
description	earthing cable connection F2.8mm / lug M5 cable length 620mm		
For models:	031FT04, 031FT06, 070FT04, 070FT05, 071FT04, 071FT06, 090BM1G, 090FT04, 090FT05, 091FT04, 091FT06, 0A0FT1G, 0A0FT2G, 0A0FT4G, 0A0FT5G, 0A0GRG, 0B0FT1G, 0B0FT2G, 0B0FT4G, 0B0FT5G, 0D0FT1G, 0D0FT2G, 0D0FT4G, 0D0FT5G, 0D0GRG, 0G0FT1G, 0G0FT2G, 0G0FT4G, 0G0FT5G, 190BM2G, 1A0FT1G, 1A0FT2G, 1A0FT3G, 1A0FT4G, 1A0FT6G, 1A0GRG, 1B0FT1G, 1B0FT2G, 1B0FT3G, 1B0FT4G, 1B0FT6G, 1D0FT1G, 1D0FT2G, 1D0FT3G, 1D0FT4G, 1D0FT6G, 1D0GRG, 1G0FT1G, 1G0FT2G, 1G0FT3G...(Other models you can see in the webshop)		

1





GEV No.	100183	Ref. No.	32A2530
description	earthing cable connection F2.8mm / lug M5 cable length 900mm		
For models:	08WCP1GM, 0A0BMG, 0A0FAVA, 0A1CP1G, 0B1CP1G, 0D0BMG, 0D0FAVA, 0D1CP1G, 0G1CP1G, 10WTPGE, 10WTPGV, 1A0BMG, 1A0FA2, 1A0FA5, 1A0FAB, 1A0FAS2, 1A0TP0, 1A1CP1G, 1A1CP2G, 1A1FA2G, 1A1FA5G, 1A1FABG, 1A1FAS2G, 1A1FASG, 1A1PD1G, 1A1PD2G, 1A1PI1G, 1A1PI1GA, 1A1TP0G, 1A1TP0G-VERS.2002, 1B0FAS2, 1B0TP0, 1B1FAS2G, 1D0BMG, 1D0FA2, 1D0FA5, 1D0FAB, 1D0FAS2, 1D0TP0, 1D1CP1G, 1D1CP2G, 1D1FA2G, 1D1FA5G, 1D1FABG, 1D1FAS2G, 1D1PD1G, 1D1PD2G, 1D1PI1G, 1D1PI1GA, 1D1TP0G...(Other models you can see in the webshop)		

→ electric components



			
GEV No.	104798	Ref. No.	3113480
description	earthing cable connection F2.8mm/lug M6 cable length 600mm 1.5mm ²		
For models:	FM1221G1, FM1221G1-VERS.2006, FM1221G2, FM1221G2-VERS.2006, FM1221G3, FM1221G3-VERS.2006, FM2021G1, FM2021G2, FM2021G2-VERS.2006, FM2021G3, FM2021G3-VERS.2006, FM721G1, FM721G2, FM721G3		

ribbon cables			
group 1			
			
GEV No.	400066	Ref. No.	3099170
description	ribbon cable 10-pole L 1000mm plug type FC-10P raster size 2.54mm		
For models:	KD85E, KD85EA, KD85EAT, KD85EPS, KD85EPSA, LP70		

			
GEV No.	403293	Ref. No.	32A2290
description	ribbon cable 16-pole L 1500mm plug type 2 row coded plug: number of poles 16		
For models:	06WFR3GD, 08WFR4ED, 091FR1GD, 091FR3GD, 0A1FR1ED, 0A1FR1GD, 0A1FR1GD-VERS.2004, 0A1FR3GD, 0B1FR1GD, 0D1FR1ED, 0D1FR1GD, 0D1FR1GD-VERS.2004, 0D1FR3GD, 0G0FR3ED, 0G1FR3GD, 10WFR4GD, 191FR2GD, 191FR4GD, 1A1FR2ED, 1A1FR2GD, 1A1FR2GD-VERS.2004, 1D1FR2ED, 1D1FR2GD, 1D1FR2GD-VERS.2004, 1G1FR4GD		

connection cables			
			
GEV No.	579007	Ref. No.	3116170
description	data cable L 1000mm 8-pole for combi-steamer suitable for ANGELO PO plug type RJ45		
For models:	BX122G, BX122G-VERS.122013, BX82G, BX82G-VERS.122013, FX101E1, FX101E1R, FX101E2, FX101E2C, FX101E2C-VERS.032014, FX101E2R, FX101E2R-VERS.032014, FX101E2-VERS.032014, FX101E3, FX101E3C, FX101E3C-VERS.022014, FX101E3R, FX101E3R-VERS.022014, FX101E3-VERS.022014, FX101G1, FX101G1R, FX101G2, FX101G2C, FX101G2C-VERS.032014, FX101G2R, FX101G2R-VERS.032014, FX101G2-VERS.032014, FX101G3, FX101G3C, FX101G3C-VERS.022014, FX101G3R, FX101G3R-VERS.022014, FX101G3-VERS.022014, FX10E2CR, FX10E2CR-VERS.032014, FX10E3CR, FX10E3CR-VERS.022014, FX10G2CR, FX10G2CR-VERS.032014, FX10G3CR, FX10G3CR-VERS.022014, FX122E1, FX122E2, FX122E2C, FX122E2T, FX122E2T-VERS.032014, FX122E3, FX122E3C, FX122E3T, FX122E3T-VERS.022014, FX122G1...(Other models you can see in the webshop)		

terminals and connectors

insulated			
plug connectors			
			
GEV No.	550326	Ref. No.	32D0080
description	connection terminal 12-pole connection male faston 6.3mm temp.-resist. 140°C		
For models:	0A1FR3G, 0A1FR3GD, 0D1FR3G, 0D1FR3GD, 0G1FR3G, 0G1FR3GD, 191BR1G, 191BR1GA, 191BR2G, 191BR2GA, 1A1BR1G, 1A1BR1GA, 1A1BR2G, 1A1BR2GA, 1A1FR4G, 1A1FR4GD, 1D1BR1G, 1D1BR1GA, 1D1BR2G, 1D1BR2GA, 1D1FR4G, 1D1FR4GD, 1G1FR4G, 1G1FR4GD, 291BR1G, 291BR1GA, 291BR2G, 291BR2GA, 2A1BR1G, 2A1BR1GA, 2A1BR2G, 2A1BR2GA, 2D1BR1G, 2D1BR1GA, 2D1BR2G, 2D1BR2GA		

plug connectors

			
GEV No.	550952	Ref. No.	32D0420
description	connecting piece 2-pole		

			
GEV No.	550171	Ref. No.	32D0140
description	plug connector 10-pole STV 2/10		

terminals

porcelain clamps			
			
GEV No.	550112	Ref. No.	3000060
description	porcelain terminal block 2-pole 2.5mm ² max. 10A max 250V t.max. 200°C L 22mm W 17mm H 15mm mounting distancemm Qty 1 pcs		

terminal blocks



1			
GEV No.	550232	Ref. No.	32D1450
description	lustre terminal 12-pole cross section 2.5mm ² max. 32A max 450V temp.-resist. 150°C		
For models:	031FT04, 031FT06, 04WBMEV, 04WCP1EM, 04WFR3ED, 04WPE4V, 04WPEBV, 04WVT3RV, 06WBR3E, 06WFT1EV, 06WFT2EV, 06WFT3EV, 06WFT4EV, 06WFT6EV, 06WFT7EV, 070FT04, 070FT05, 071FT04, 071FT06, 08WFR4ED, 08WFT1EV, 08WFT2EV, 08WFT3EV, 08WFT4EV, 08WFT4GV, 08WFT6EV, 08WFT6GV, 08WFT7EV, 08WPE4V, 08WPEBV, 08WTPEV, 090BM1G, 090FT04, 090FT05, 090FT1G, 090FT2G, 090FT4G, 090FT5G, 090FT7G, 090GRG, 090PE4, 090VTR, 091CP1E, 091CP1G, 091FR1EA, 091FR1EX, 091FR3E, 091FR3ED, 091FT04, 091FT06...(Other models you can see in the webshop)		

connection terminals with screw/faston connections



1			
GEV No.	550278	Ref. No.	32D0171
description	power terminal block 3-pole max. 40A max 400V connection ø6mm ² / F6.3 temp.-resist. 150°C cross section 6mm ²		



1			
GEV No.	550349	Ref. No.	32D1800
description	power terminal block 4-pole max. 40A max 400V connection ø6mm ² / F6.3 temp.-resist. 150°C cross section 6mm ²		



1			
GEV No.	550411	Ref. No.	32D0250 32D0251
description	power terminal block 6-pole max. 40A max 450V connection ø6mm ² / F6.3 temp.-resist. 150°C cross section 6mm ²		

connection terminals with screw connection



1			
GEV No.	550507	Ref. No.	32D1800
description	power terminal block 4-pole max. 40A max 400V connection M6/M6 temp.-resist. 150°C		

connection terminals with strain relief



1			
GEV No.	550951	Ref. No.	32D0380
description	power terminal block 3-pole cross section 2.5mm ² with strain relief		
For models:	030BME, 030EBM, 031BME, 031EBM, 090FAA, 090FAVA, 090GRG, 0M0BME, 0M0SP1E, 190FAA, 190FAB, 190GRG, 190TP0, 191FAAG, 191FABG, 191FADG, 191FAG, 191PD2G, 191PI1G, 191PI1GA, 191PI2G, 191PI2GA, 191TPG, 1G1FA0GV, 1M0BME, 291FAG, 291TPCG, 2G1FA0GV, 30F1, 30F1B, 30F52, 30F52B, 31TC, 32TC, 391FAG, 70F1, 70F1B, 71F2, 71F2B, 91F223B, G1FAGS, G1FAGST		

plug-in terminal blocks



1			
GEV No.	550950	Ref. No.	32D0240
description	plug-in terminal block 16-pole max. 16A max 380V		

rail-mounted terminals

miscellaneous



1			
GEV No.	550947	Ref. No.	32D0470
description	rail-mounted terminal profile C		
For models:	030E, 030FE, 030FE1, 030FE1B, 030FTE, 030FTE, 031E, 031FTE, 031FTE, 031FTE, 070BME, 070E, 070FTE, 070FTE, 071BME, 071E, 071FTE, 071FTE, 071FTE, 090BME, 090E, 090FTE, 090FTE, 091BME, 091E, 091FE28, 091FE28B, 091FTE, 091FTE, 091FTE, 091FTE, 30CPSE, 30FES, 30FES2, 30FES2B, 31GE, 31PIE6, 31RE, 70CPE, 70FE, 70FE1, 70FE1B, 70FES, 70FES2, 70FES2B, 71PIE15, 71PIE15A, 90CPE, 91PIE15, 91PIE15A, FS30E		



1

GEV No.	550949	Ref. No.	32D0480
description	rail-mounted terminal yellow/green profile C		
For models:	030E, 030FE, 030FE1, 030FE1B, 030FTE, 030FTE1, 030FTE2, 030FTE3, 030FTE4, 030FTE5, 030FTE6, 030FTE7, 030FTE8, 030FTE9, 030FTE10, 030FTE11, 030FTE12, 030FTE13, 030FTE14, 030FTE15, 030FTE16, 030FTE17, 030FTE18, 030FTE19, 030FTE20, 030FTE21, 030FTE22, 030FTE23, 030FTE24, 030FTE25, 030FTE26, 030FTE27, 030FTE28, 030FTE29, 030FTE30, 030FTE31, 030FTE32, 030FTE33, 030FTE34, 030FTE35, 030FTE36, 030FTE37, 030FTE38, 030FTE39, 030FTE40, 030FTE41, 030FTE42, 030FTE43, 030FTE44, 030FTE45, 030FTE46, 030FTE47, 030FTE48, 030FTE49, 030FTE50, 030FTE51, 030FTE52, 030FTE53, 030FTE54, 030FTE55, 030FTE56, 030FTE57, 030FTE58, 030FTE59, 030FTE60, 030FTE61, 030FTE62, 030FTE63, 030FTE64, 030FTE65, 030FTE66, 030FTE67, 030FTE68, 030FTE69, 030FTE70, 030FTE71, 030FTE72, 030FTE73, 030FTE74, 030FTE75, 030FTE76, 030FTE77, 030FTE78, 030FTE79, 030FTE80, 030FTE81, 030FTE82, 030FTE83, 030FTE84, 030FTE85, 030FTE86, 030FTE87, 030FTE88, 030FTE89, 030FTE90, 030FTE91, 030FTE92, 030FTE93, 030FTE94, 030FTE95, 030FTE96, 030FTE97, 030FTE98, 030FTE99, 030FTE100		

accessories universal

terminal block end brackets



1

GEV No.	550948	Ref. No.	32D0490
description	isolation barrier profile C		
For models:	030E, 030FE, 030FE1, 030FE1B, 030FTE, 030FTE1, 030FTE2, 030FTE3, 030FTE4, 030FTE5, 030FTE6, 030FTE7, 030FTE8, 030FTE9, 030FTE10, 030FTE11, 030FTE12, 030FTE13, 030FTE14, 030FTE15, 030FTE16, 030FTE17, 030FTE18, 030FTE19, 030FTE20, 030FTE21, 030FTE22, 030FTE23, 030FTE24, 030FTE25, 030FTE26, 030FTE27, 030FTE28, 030FTE29, 030FTE30, 030FTE31, 030FTE32, 030FTE33, 030FTE34, 030FTE35, 030FTE36, 030FTE37, 030FTE38, 030FTE39, 030FTE40, 030FTE41, 030FTE42, 030FTE43, 030FTE44, 030FTE45, 030FTE46, 030FTE47, 030FTE48, 030FTE49, 030FTE50, 030FTE51, 030FTE52, 030FTE53, 030FTE54, 030FTE55, 030FTE56, 030FTE57, 030FTE58, 030FTE59, 030FTE60, 030FTE61, 030FTE62, 030FTE63, 030FTE64, 030FTE65, 030FTE66, 030FTE67, 030FTE68, 030FTE69, 030FTE70, 030FTE71, 030FTE72, 030FTE73, 030FTE74, 030FTE75, 030FTE76, 030FTE77, 030FTE78, 030FTE79, 030FTE80, 030FTE81, 030FTE82, 030FTE83, 030FTE84, 030FTE85, 030FTE86, 030FTE87, 030FTE88, 030FTE89, 030FTE90, 030FTE91, 030FTE92, 030FTE93, 030FTE94, 030FTE95, 030FTE96, 030FTE97, 030FTE98, 030FTE99, 030FTE100		



1

GEV No.	550946	Ref. No.	32D0060
description	terminal block end bracket profile C		
For models:	030E, 030FE, 030FE1, 030FE1B, 030FTE, 030FTE1, 030FTE2, 030FTE3, 030FTE4, 030FTE5, 030FTE6, 030FTE7, 030FTE8, 030FTE9, 030FTE10, 030FTE11, 030FTE12, 030FTE13, 030FTE14, 030FTE15, 030FTE16, 030FTE17, 030FTE18, 030FTE19, 030FTE20, 030FTE21, 030FTE22, 030FTE23, 030FTE24, 030FTE25, 030FTE26, 030FTE27, 030FTE28, 030FTE29, 030FTE30, 030FTE31, 030FTE32, 030FTE33, 030FTE34, 030FTE35, 030FTE36, 030FTE37, 030FTE38, 030FTE39, 030FTE40, 030FTE41, 030FTE42, 030FTE43, 030FTE44, 030FTE45, 030FTE46, 030FTE47, 030FTE48, 030FTE49, 030FTE50, 030FTE51, 030FTE52, 030FTE53, 030FTE54, 030FTE55, 030FTE56, 030FTE57, 030FTE58, 030FTE59, 030FTE60, 030FTE61, 030FTE62, 030FTE63, 030FTE64, 030FTE65, 030FTE66, 030FTE67, 030FTE68, 030FTE69, 030FTE70, 030FTE71, 030FTE72, 030FTE73, 030FTE74, 030FTE75, 030FTE76, 030FTE77, 030FTE78, 030FTE79, 030FTE80, 030FTE81, 030FTE82, 030FTE83, 030FTE84, 030FTE85, 030FTE86, 030FTE87, 030FTE88, 030FTE89, 030FTE90, 030FTE91, 030FTE92, 030FTE93, 030FTE94, 030FTE95, 030FTE96, 030FTE97, 030FTE98, 030FTE99, 030FTE100		

electronic components

miscellaneous



1

GEV No.	400958	Ref. No.	32Z5500
description	bounce control electronic L 80mm W 17mm H 45mm 180-260V input current 3A 50/60Hz		
For models:	030FE1, 091FE28, 30F1, 30FES2, 30FS2, 70F1, 70FE1, 70FES2, 71F2, 71FE2, 91F210		

gas taps

PEL

20S series







1

GEV No.	101068	Ref. No.	33A0070 6004730
description	gas tap PEL type 20S gas inlet M16x1.5 (tube ø 10mm) bypass nozzle ø 0.2mm gas outlet 1/4" (tube ø 6mm) thermocouple connection M8x1 pilot connection shaft ø 8x6.5mm shaft L 22/15mm shaft flat upper conversion kit tube ø 10mm		
spare parts for	101068		
	GEV No.	101060	Ref. No. 32Z1520
	magnet unit standard L 39mm D1 ø 15.4mm D2 ø 11mm suitable for PEL20-21/JUNKERS/EGA		
	GEV No.	101205	Ref. No. —
	gas tap front part shaft ø 8x6.5mm shaft L 22/15mm shaft flat upper/lower suitable for PEL20		
	GEV No.	101230	Ref. No. —
	thermocouple nut T1: M8x1 T2: M18x1 aluminium		
	GEV No.	101278	Ref. No. 36Q0080
	olive for pipe ø 10mm Qty 1 pcs		
	GEV No.	101300	Ref. No. 36Q0830
	union nut thread M16x1.5 tube ø 10mm		
accessories for	101068		
	GEV No.	110081	Ref. No. 36M0770
	knob ø 70mm shaft ø 8x6.5mm shaft flat universal		
	GEV No.	110083	Ref. No. —
	knob dial plate gas tap without ignition flame silver		







			
1			
GEV No.	103179	Ref. No.	33D3180
description	gas tap PEL type 20S gas inlet pipe flange ø21mm bypass nozzle ø 0mm gas outlet M16x1.5 (tube ø 10/8mm) thermocouple connection M9x1 pilot connection shaft ø 8x6.5mm shaft L 22/15mm shaft flat lower without ignition flame connection		
For models:	G1FAGS, G1FAGST		









accessories for	101095		
	GEV No.	101450	Ref. No. —
olive for pipe ø 8mm L 12.7mm Qty 1 pcs ED ø 10mm			
	GEV No.	101451	Ref. No. —
union nut thread M16x1.5 tube ø 8mm			
	GEV No.	110081	Ref. No. 36M0770
knob ø 70mm shaft ø 8x6.5mm shaft flat universal			
	GEV No.	112206	Ref. No. —
knob dial plate silver gas tap PEL21/22/23 t.max.°C ED ø 63mm ID ø 45.5mm			

21S series			
			
1			
GEV No.	101095	Ref. No.	33D1170
description	gas tap PEL type 21S gas inlet M16x1.5 (tube ø 10mm) bypass nozzle ø 0.35mm gas outlet M16x1.5 (tube ø 10/8mm) thermocouple connection M8x1 pilot connection M10x1 shaft ø 8x6.5mm shaft L 22/15mm shaft flat lower		
For models:	030, 031, 032, 31, 31GE, 31TC, 32, 32TC, 32TP, 32TPV, 32V, 60SM		
spare parts for	101095		
	GEV No.	100408	Ref. No. 33T3630
bypass nozzle type PEL20/21 bore ø 0.35mm thread M5x0.5			
	GEV No.	101060	Ref. No. 32Z1520
magnet unit standard L 39mm D1 ø 15.4mm D2 ø 11mm suitable for PEL20-21/JUNKERS/EGA			
	GEV No.	101206	Ref. No. —
gas tap front part shaft ø 8x6.5mm shaft L 22/15mm shaft flat upper/lower suitable for PEL21			
	GEV No.	101230	Ref. No. —
thermocouple nut T1: M8x1 T2: M18x1 aluminium			
accessories for	101095		
	GEV No.	100908	Ref. No. 36Q1000
union screw thread M10x1 for pipe ø 4mm Qty 1 pcs			
	GEV No.	100909	Ref. No. 36Q0060
union screw thread M10x1 for pipe ø 6mm Qty 1 pcs			
	GEV No.	101246	Ref. No. —
olive for pipe ø 4mm Qty 1 pcs			
	GEV No.	101278	Ref. No. 36Q0080
olive for pipe ø 10mm Qty 1 pcs			
	GEV No.	101286	Ref. No. 36Q0020
olive ID ø 6mm Qty 1 pcs			
	GEV No.	101300	Ref. No. 36Q0830
union nut thread M16x1.5 tube ø 10mm			

			
1			
GEV No.	109515	Ref. No.	3064310
description	gas tap PEL type 21S gas inlet pipe flange ø21mm bypass nozzle ø 0mm gas outlet M16x1.5 (tube ø 10/8mm) thermocouple connection M8x1 pilot connection M10x1 shaft ø 8x6.5mm shaft L 22/15mm shaft flat upper		
For models:	04WFAAV, 08WFA4E, 08WFA4G, 08WFAAE, 08WFAAG, 08WFAAV, 090FAA, 0G0FA0, 0G1CP1G-VERS.2004, 12WFA6E, 12WFA6G, 12WFAAA, 12WFAAE, 12WFAAG, 12WFAAN, 190FA, 190FAA, 190FAB, 190FAD, 191FAAE, 191FAAG, 191FABG, 191FADG, 191FAE, 191FAG, 1G0FA0, 1G0FA0B, 1G0GRG, 1G0TPO, 1G1CP1G-VERS.2004, 1G1CP2G-VERS.2004, 1G1FA0E, 1G1FA0EV, 1G1FA0G, 1G1FA0GV, 1G1FABG, 1G1FAPG, 1G1TP0G, 290FA, 291FAG, 291FAGF, 291TPCG, 2G0FA0, 2G0FA0A, 2G0FA0B, 2G1FA0E, 2G1FA0G, 2G1FA0GV, 2G1FABG, 2G1FACG...(Other models you can see in the webshop)		
spare parts for	109515		
	GEV No.	101060	Ref. No. 32Z1520
magnet unit standard L 39mm D1 ø 15.4mm D2 ø 11mm suitable for PEL20-21/JUNKERS/EGA			
	GEV No.	101206	Ref. No. —
gas tap front part shaft ø 8x6.5mm shaft L 22/15mm shaft flat upper/lower suitable for PEL21			
	GEV No.	101230	Ref. No. —
thermocouple nut T1: M8x1 T2: M18x1 aluminium			
accessories for	109515		
	GEV No.	100908	Ref. No. 36Q1000
union screw thread M10x1 for pipe ø 4mm Qty 1 pcs			
	GEV No.	100909	Ref. No. 36Q0060
union screw thread M10x1 for pipe ø 6mm Qty 1 pcs			
	GEV No.	101246	Ref. No. —
olive for pipe ø 4mm Qty 1 pcs			
	GEV No.	101278	Ref. No. 36Q0080
olive for pipe ø 10mm Qty 1 pcs			
	GEV No.	101286	Ref. No. 36Q0020
olive ID ø 6mm Qty 1 pcs			











Table continues overleaf

accessories for	109515		
	GEV No.	101300	Ref. No. 36Q0830
	union nut thread M16x1.5 tube ø 10mm		
	GEV No.	101450	Ref. No. —
	olive for pipe ø 8mm L 12.7mm Qty 1 pcs ED ø 10mm		
	GEV No.	101451	Ref. No. —
	union nut thread M16x1.5 tube ø 8mm		
	GEV No.	110078	Ref. No. —
	knob without symbol ø 70mm shaft ø 6x4.6mm shaft flat universal		
	GEV No.	112206	Ref. No. —
	knob dial plate silver gas tap PEL21/22/23 t.max.°C ED ø 63mm ID ø 45.5mm		

	1		
GEV No.	106231	Ref. No.	33D1930
description	gas tap PEL type 21S gas inlet pipe flange ø21mm bypass nozzle ø 1.05mm gas outlet M16x1.5 (tube ø 10/8mm) thermocouple connection M8x1 pilot connection M10x1 shaft ø 8x6.5mm shaft L 22/15mm shaft flat lower		
For models:	0A0FA1, 0A0FA4, 0A0FAA, 0D0FA1, 0D0FA4, 0D0FAA, 0G0FA0, 0G1CP1G, 0G1CP1G-VERS.2004, 1A0FA1, 1A0FA2, 1A0FA4, 1A0FA5, 1A0FAA, 1A0FAB, 1A1FA1G, 1A1FA2G, 1A1FA4G, 1A1FA5G, 1A1FAAG, 1A1FABG, 1D0FA1, 1D0FA2, 1D0FA4, 1D0FA5, 1D0FAA, 1D0FAB, 1D1FA1G, 1D1FA2G, 1D1FA4G, 1D1FA5G, 1D1FAAG, 1D1FABG, 1G0FA0, 1G0GRG, 1G0TP0, 1G1CP1G, 1G1CP1G-VERS.2004, 1G1CP2G, 1G1CP2G-VERS.2004, 1G1FA0E, 1G1FA0EV, 1G1FA0G, 1G1FA0GV, 1G1FAPG, 1G1TP0G, 2A0FA1, 2A0FA4, 2A0FAA, 2A1FA1G...(Other models you can see in the webshop)		
spare parts for	106231		
	GEV No.	100557	Ref. No. 33T3670
	bypass nozzle type PEL20/21 bore ø 1.05mm thread M5x0.5		
	GEV No.	101060	Ref. No. 32Z1520
	magnet unit standard L 39mm D1 ø 15.4mm D2 ø 11mm suitable for PEL20-21/JUNKERS/EGA		
	GEV No.	101230	Ref. No. —
	thermocouple nut T1: M8x1 T2: M18x1 aluminium		
	GEV No.	101880	Ref. No. —
	gasket Viton ED ø 14mm ID ø 9mm thickness 7.7mm Qty 1 pcs		
accessories for	106231		
	GEV No.	101277	Ref. No. 36Q1630
	olive ID ø 8mm Qty 1 pcs		
	GEV No.	101278	Ref. No. 36Q0080
	olive for pipe ø 10mm Qty 1 pcs		
	GEV No.	101300	Ref. No. 36Q0830
	union nut thread M16x1.5 tube ø 10mm		
	GEV No.	101451	Ref. No. —
	union nut thread M16x1.5 tube ø 8mm		





22N/O series			
	1		
GEV No.	106234	Ref. No.	33A0090
description	gas tap PEL type 22N/O gas inlet M20x1.5 (tube ø 12mm) bypass nozzle ø 0.35mm gas outlet M20x1.5 (flanged tube ø 12/10mm) thermocouple connection pilot connection M10x1 shaft ø 10x8mm shaft L 28/13mm shaft flat lower		
spare parts for	106234		
	GEV No.	100259	Ref. No. 33T1180
	bypass nozzle type PEL22 bore ø 0.35mm thread M6x0.5		
	GEV No.	101203	Ref. No. —
	gas tap front part shaft ø 9x10mm shaft L 28/13mm shaft flat upper/lower suitable for PEL22		
	GEV No.	101240	Ref. No. —
	gas connection thread M20x1.5 tube ø 12/10mm for PEL gas taps with gasket and screws horizontal		
	GEV No.	101331	Ref. No. —
	adapter suitable for PEL22 for flanged cable 10/12mm		
	GEV No.	101460	Ref. No. —
	O-ring ø 12.37mm D1 ø 2.62mm suitable for PEL22		
	GEV No.	101461	Ref. No. —
	screw kit suitable for PEL22 Qty 4 pcs		
accessories for	106234		
	GEV No.	100908	Ref. No. 36Q1000
	union screw thread M10x1 for pipe ø 4mm Qty 1 pcs		
	GEV No.	100909	Ref. No. 36Q0060
	union screw thread M10x1 for pipe ø 6mm Qty 1 pcs		
	GEV No.	101246	Ref. No. —
	olive for pipe ø 4mm Qty 1 pcs		
	GEV No.	101248	Ref. No. 36Q0030
	olive for pipe ø 12mm Qty 1 pcs suitable for PEL		
	GEV No.	101249	Ref. No. 36Q1700
	olive for pipe ø 10mm Qty 1 pcs		
	GEV No.	101250	Ref. No. 36Q0610
	union nut thread M20x1.5 for pipe ø 10mm		
	GEV No.	101251	Ref. No. 36Q0050
	union nut thread M20x1.5 for pipe ø 12mm		
	GEV No.	101286	Ref. No. 36Q0020
	olive ID ø 6mm Qty 1 pcs		



			
1			
GEV No.	106233	Ref. No.	33A1110
description	gas tap PEL type 22N/O gas inlet M20x1.5 (tube ø 12mm) bypass nozzle ø 0.35mm gas outlet M20x1.5 (tube ø 12/10mm) thermocouple connection pilot connection M10x1 shaft ø 10x8mm shaft L 28/13mm shaft flat lower		
spare parts for	106233		
	GEV No.	100259	Ref. No. 33T1180
	bypass nozzle type PEL22 bore ø 0.35mm thread M6x0.5		
	GEV No.	101203	Ref. No. —
	gas tap front part shaft ø 9x10mm shaft L 28/13mm shaft flat upper/lower suitable for PEL22		
	GEV No.	101240	Ref. No. —
	gas connection thread M20x1.5 tube ø 12/10mm for PEL gas taps with gasket and screws horizontal		
	GEV No.	101460	Ref. No. —
	O-ring ø 12.37mm D1 ø 2.62mm suitable for PEL22		
	GEV No.	101461	Ref. No. —
	screw kit suitable for PEL22 Qty 4 pcs		
accessories for	106233		
	GEV No.	100908	Ref. No. 36Q1000
	union screw thread M10x1 for pipe ø 4mm Qty 1 pcs		
	GEV No.	100909	Ref. No. 36Q0060
	union screw thread M10x1 for pipe ø 6mm Qty 1 pcs		
	GEV No.	101246	Ref. No. —
	olive for pipe ø 4mm Qty 1 pcs		
	GEV No.	101248	Ref. No. 36Q0030
	olive for pipe ø 12mm Qty 1 pcs suitable for PEL		
	GEV No.	101249	Ref. No. 36Q1700
	olive for pipe ø 10mm Qty 1 pcs		
	GEV No.	101250	Ref. No. 36Q0610
	union nut thread M20x1.5 for pipe ø 10mm		
	GEV No.	101251	Ref. No. 36Q0050
	union nut thread M20x1.5 for pipe ø 12mm		
	GEV No.	101286	Ref. No. 36Q0020
	olive ID ø 6mm Qty 1 pcs		

22S/O series			
			
1			
GEV No.	101085	Ref. No.	33A0100 33A1040
description	gas tap PEL type 22S/O gas inlet M20x1.5 (tube ø 12mm) bypass nozzle ø 0.35mm gas outlet M20x1.5 (flanged tube ø 12/10mm) thermocouple connection M8x1 pilot connection M10x1 shaft ø 10x9mm shaft L 28/13mm shaft flat upper		
For models:	031TP, 070D, 070DGG, 070FT, 070FTR, 0712D, 0712VA, 071D, 071DGG, 071FT, 071FTR, 071FTRL, 071TP, 072D, 072DGG, 090, 090FT, 090FTR, 090GG, 091, 091FT, 091FTR, 091FTRL, 091GG, 091TP, 092, 092GG, 092VA, 092VAGG, 30CPS, 31PD6, 31PI6, 31TP, 32TP, 32TPV, 70CP, 712D, 712VA, 71CP, 71CP2, 71D, 71DGG, 71GE, 71GEGG, 71PD10, 71PD15, 71PI10, 71PI10A, 71TP, 72D...(Other models you can see in the webshop)		
spare parts for	101085		
	GEV No.	100259	Ref. No. 33T1180
	bypass nozzle type PEL22 bore ø 0.35mm thread M6x0.5		
	GEV No.	101058	Ref. No. 32Z1460
	magnet unit L 39mm D1 ø 15.4mm D2 ø 13.5mm suitable for PEL22/EGA24197 standard		
	GEV No.	101203	Ref. No. —
	gas tap front part shaft ø 9x10mm shaft L 28/13mm shaft flat upper/lower suitable for PEL22		
	GEV No.	101230	Ref. No. —
	thermocouple nut T1: M8x1 T2: M18x1 aluminium		
	GEV No.	101240	Ref. No. —
	gas connection thread M20x1.5 tube ø 12/10mm for PEL gas taps with gasket and screws horizontal		
	GEV No.	101460	Ref. No. —
	O-ring ø 12.37mm D1 ø 2.62mm suitable for PEL22		
	GEV No.	101461	Ref. No. —
	screw kit suitable for PEL22 Qty 4 pcs		
accessories for	101085		
	GEV No.	100908	Ref. No. 36Q1000
	union screw thread M10x1 for pipe ø 4mm Qty 1 pcs		
	GEV No.	100909	Ref. No. 36Q0060
	union screw thread M10x1 for pipe ø 6mm Qty 1 pcs		
	GEV No.	101241	Ref. No. —
	gas connection thread M20x1.5 tube ø 12/10mm for PEL gas taps vertical		
	GEV No.	101246	Ref. No. —
	olive for pipe ø 4mm Qty 1 pcs		
	GEV No.	101248	Ref. No. 36Q0030
	olive for pipe ø 12mm Qty 1 pcs suitable for PEL		
	GEV No.	101249	Ref. No. 36Q1700
	olive for pipe ø 10mm Qty 1 pcs		



Table continues overleaf

accessories for		101085		
	GEV No.	101250	Ref. No.	36Q0610
	union nut thread M20x1.5 for pipe ø 10mm			
	GEV No.	101251	Ref. No.	36Q0050
	union nut thread M20x1.5 for pipe ø 12mm			
	GEV No.	101286	Ref. No.	36Q0020
	olive ID ø 6mm Qty 1 pcs			
	GEV No.	101331	Ref. No.	—
	adapter suitable for PEL22 for flanged cable 10/12mm			
	GEV No.	110140	Ref. No.	36M2390 36M5140
	knob switch zero mark ø 67mm shaft ø 10x9mm shaft flat upper black			

22S/V series



1

GEV No.	101457	Ref. No.	33A0580	
description	gas tap alternatives to JUNKERS type CH110 gas inlet M20x1.5 (tube ø 12mm) bypass nozzle ø 0.35mm gas outlet M20x1.5 (tube ø 12/10mm) thermocouple connection M8x1 pilot connection M10x1 shaft ø 10mm shaft L 25mm shaft flat with pipe outlet			
spare parts for	101457			
	GEV No.	100259	Ref. No.	33T1180
	bypass nozzle type PEL22 bore ø 0.35mm thread M6x0.5			
	GEV No.	100908	Ref. No.	36Q1000
	union screw thread M10x1 for pipe ø 4mm Qty 1 pcs			
	GEV No.	101058	Ref. No.	32Z1460
	magnet unit L 39mm D1 ø 15.4mm D2 ø 13.5mm suitable for PEL22/EGA24197 standard			
	GEV No.	101200	Ref. No.	—
	gas tap front part shaft ø 10mm shaft L 25mm shaft flat suitable for 22S/O			
	GEV No.	101230	Ref. No.	—
	thermocouple nut T1: M8x1 T2: M18x1 aluminium			
	GEV No.	101241	Ref. No.	—
	gas connection thread M20x1.5 tube ø 12/10mm for PEL gas taps vertical			
	GEV No.	101246	Ref. No.	—
	olive for pipe ø 4mm Qty 1 pcs			
	GEV No.	101460	Ref. No.	—
	O-ring ø 12.37mm D1 ø 2.62mm suitable for PEL22			
	GEV No.	101461	Ref. No.	—
	screw kit suitable for PEL22 Qty 4 pcs			

accessories for		101457		
	GEV No.	100945	Ref. No.	—
	roll pin ø 3.2mm L 10mm			
	GEV No.	101218	Ref. No.	—
	shaft extension JUNKERS			
	GEV No.	101219	Ref. No.	—
	shaft extension L 25mm JUNKERS			
	GEV No.	101231	Ref. No.	—
	thermocouple nut T1: M9x1 T2: M18x1			
	GEV No.	101248	Ref. No.	36Q0030
	olive for pipe ø 12mm Qty 1 pcs suitable for PEL			
	GEV No.	101249	Ref. No.	36Q1700
	olive for pipe ø 10mm Qty 1 pcs			
	GEV No.	101250	Ref. No.	36Q0610
	union nut thread M20x1.5 for pipe ø 10mm			
	GEV No.	101251	Ref. No.	36Q0050
	union nut thread M20x1.5 for pipe ø 12mm			
	GEV No.	101290	Ref. No.	—
	thermocouple nut T1: M10x1 T2: M18x1 suitable for PEL20/21			
	GEV No.	110064	Ref. No.	36M0660
	knob			
	GEV No.	110066	Ref. No.	—
	knob screw			
	GEV No.	550396	Ref. No.	—
	shaft extension L 25mm JUNKERS			



1









GEV No.	101661	Ref. No.	33D1990 33D1991	
description	gas tap PEL type 22S/V gas inlet pipe flange ø21mm bypass nozzle ø 0.35mm gas outlet M20x1.5 (tube ø 12/10mm) thermocouple connection M8x1 pilot connection M10x1 shaft ø 10x8.5mm shaft L 28/13mm shaft flat upper			
For models:	06WCP1GM, 08WCP1GM, 08WGRGV, 090FAVA, 090GRG, 091CP1G, 0A0FAS, 0A0FAVA, 0A0GRG, 0A1CP1G, 0B0FAS, 0B1CP1G, 0D0FAS, 0D0FAVA, 0D0GRG, 0D1CP1G, 10WTPGE, 10WTPGV, 190FAB, 190GRG, 190TPO, 191CP1G, 191CP2G, 191FABG, 191PD2G, 191PI1G, 191PI1GA, 191PI2G, 191PI2GA, 191TPG, 1A0FA2, 1A0FA5, 1A0FAB, 1A0FAS, 1A0FAS2, 1A0GRG, 1A0TPO, 1A1CP1G, 1A1CP2G, 1A1FA2G, 1A1FASG, 1A1FABG, 1A1FAS2G, 1A1FASG, 1A1PD1G, 1A1PD2G, 1A1PI1G, 1A1PI1GA, 1A1TPOG, 1A1TPOG-VERS.2002...(Other models you can see in the webshop)			
spare parts for	101661			
	GEV No.	100259	Ref. No.	33T1180
	bypass nozzle type PEL22 bore ø 0.35mm thread M6x0.5			

Table continues overleaf



spare parts for		101661	
	GEV No.	101058	Ref. No. 32Z1460
	magnet unit L 39mm D1 ø 15.4mm D2 ø 13.5mm suitable for PEL22/ EGA24197 standard		
	GEV No.	101203	Ref. No. —
	gas tap front part shaft ø 9x10mm shaft L 28/13mm shaft flat upper/ lower suitable for PEL22		
	GEV No.	101230	Ref. No. —
	thermocouple nut T1: M8x1 T2: M18x1 aluminium		
	GEV No.	101237	Ref. No. —
	flange thread M20x1.5 tube ø 21mm suitable for PEL22		
	GEV No.	101241	Ref. No. —
	gas connection thread M20x1.5 tube ø 12/10mm for PEL gas taps vertical		
	GEV No.	101460	Ref. No. —
	O-ring ø 12.37mm D1 ø 2.62mm suitable for PEL22		
	GEV No.	101461	Ref. No. —
	screw kit suitable for PEL22 Qty 4 pcs		
	GEV No.	101536	Ref. No. —
	gasket D1 ø 17mm D2 ø 11.5mm thickness 4.7mm		
accessories for		101661	
	GEV No.	100908	Ref. No. 36Q1000
	union screw thread M10x1 for pipe ø 4mm Qty 1 pcs		
	GEV No.	100909	Ref. No. 36Q0060
	union screw thread M10x1 for pipe ø 6mm Qty 1 pcs		
	GEV No.	101246	Ref. No. —
	olive for pipe ø 4mm Qty 1 pcs		
	GEV No.	101248	Ref. No. 36Q0030
	olive for pipe ø 12mm Qty 1 pcs suitable for PEL		
	GEV No.	101249	Ref. No. 36Q1700
	olive for pipe ø 10mm Qty 1 pcs		
	GEV No.	101250	Ref. No. 36Q0610
	union nut thread M20x1.5 for pipe ø 10mm		
	GEV No.	101251	Ref. No. 36Q0050
	union nut thread M20x1.5 for pipe ø 12mm		
	GEV No.	101286	Ref. No. 36Q0020
	olive ID ø 6mm Qty 1 pcs		

23S/O series

1

GEV No.	109107	Ref. No.	33A1530
description	gas tap PEL type 23S/O gas inlet M28x1.5 (tube ø 20mm) bypass nozzle ø 0mm gas outlet M24x1.5 (tube ø 16mm) thermocouple connection M9x1 pilot connection M10x1 shaft ø 10x8mm shaft L 35/19mm shaft flat upper		
For models:	191CP1GA, 1A1CP1GA, 1A1PI2G, 1A1PI2GA, 1D1CP1GA, 1D1PI2G, 1D1PI2GA, 291PD3G, 291PI3G, 2A1PD3G, 2A1PI3G, 2D1PI3G, MCF20, MCF40		

alternatives to JUNKERS

1

GEV No.	101457	Ref. No.	33A0580
description	gas tap alternatives to JUNKERS type CH110 gas inlet M20x1.5 (tube ø 12mm) bypass nozzle ø 0.35mm gas outlet M20x1.5 (tube ø 12/10mm) thermocouple connection M8x1 pilot connection M10x1 shaft ø 10mm shaft L 25mm shaft flat with pipe outlet		
spare parts for	101457		
	GEV No.	100259	Ref. No. 33T1180
	bypass nozzle type PEL22 bore ø 0.35mm thread M6x0.5		
	GEV No.	100908	Ref. No. 36Q1000
	union screw thread M10x1 for pipe ø 4mm Qty 1 pcs		
	GEV No.	101058	Ref. No. 32Z1460
	magnet unit L 39mm D1 ø 15.4mm D2 ø 13.5mm suitable for PEL22/ EGA24197 standard		
	GEV No.	101200	Ref. No. —
	gas tap front part shaft ø 10mm shaft L 25mm shaft flat suitable for 22S/O		
	GEV No.	101230	Ref. No. —
	thermocouple nut T1: M8x1 T2: M18x1 aluminium		
	GEV No.	101241	Ref. No. —
	gas connection thread M20x1.5 tube ø 12/10mm for PEL gas taps vertical		
	GEV No.	101246	Ref. No. —
	olive for pipe ø 4mm Qty 1 pcs		
	GEV No.	101460	Ref. No. —
	O-ring ø 12.37mm D1 ø 2.62mm suitable for PEL22		
	GEV No.	101461	Ref. No. —
	screw kit suitable for PEL22 Qty 4 pcs		

Table continues overleaf



accessories for		101457	
	GEV No.	100945	Ref. No. —
	roll pin ø 3.2mm L 10mm		
	GEV No.	101218	Ref. No. —
	shaft extension JUNKERS		
	GEV No.	101219	Ref. No. —
	shaft extension L 25mm JUNKERS		
	GEV No.	101231	Ref. No. —
	thermocouple nut T1: M9x1 T2: M18x1		
	GEV No.	101248	Ref. No. 36Q0030
	olive for pipe ø 12mm Qty 1 pcs suitable for PEL		
	GEV No.	101249	Ref. No. 36Q1700
	olive for pipe ø 10mm Qty 1 pcs		
	GEV No.	101250	Ref. No. 36Q0610
	union nut thread M20x1.5 for pipe ø 10mm		
	GEV No.	101251	Ref. No. 36Q0050
	union nut thread M20x1.5 for pipe ø 12mm		
	GEV No.	101290	Ref. No. —
	thermocouple nut T1: M10x1 T2: M18x1 suitable for PEL20/21		
	GEV No.	110064	Ref. No. 36M0660
	knob		
	GEV No.	110066	Ref. No. —
	knob screw		
	GEV No.	550396	Ref. No. —
	shaft extension L 25mm JUNKERS		

gas thermostats

SIT

630 Eurosit series

1			
GEV No.	107688	Ref. No.	3315970
description	gas thermostat 100-340°C gas inlet 3/8" gas outlet 3/8" thermocouple connection M9x1 pilot connection M10x1 probe ø 4mm probe L 72mm capillary pipe 1050mm		





1			
GEV No.	103310	Ref. No.	3041750
description	gas thermostat type 630 Eurosit series 110-190°C		
For models:	0G0FR5G, 0G1FR7G, 1G0FR6G, 1G1FR8G		

1			
GEV No.	101413	Ref. No.	33A0491 6300478
description	gas thermostat type 630 Eurosit series t.max. 100°C 30-100°C gas inlet 3/8" gas outlet 3/8" thermocouple connection M9x1 pilot connection M10x1 probe ø 5mm probe L 122mm capillary pipe 1050mm SIT		
For models:	0A0BMG, 0D0BMG, 1A0BMG, 1D0BMG		
accessories for	101413		
	GEV No.	100904	Ref. No. —
	locking screw M10x1 for pipe ø 4mm Qty 1 pcs		
	GEV No.	100905	Ref. No. —
	locking screw M10x1 for pipe ø 6mm Qty 1 pcs		
	GEV No.	101273	Ref. No. —
	olive for pipe ø 12mm L 9.5mm brass Qty 1 pcs suitable for universal		
	GEV No.	101276	Ref. No. 36Q0710
	union screw thread 3/8" tube ø 12mm Qty 1 pcs		
	GEV No.	101333	Ref. No. 36R0010
	plug thread 3/8" with O-ring		

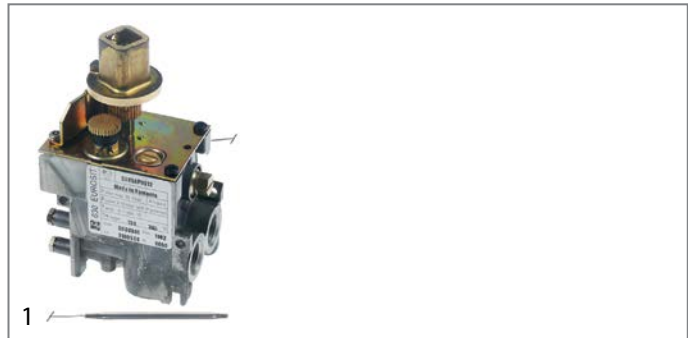











GEV No.	101915	Ref. No.	33A0941
description	gas thermostat type 630 Eurosit series t.max. 320°C 80-320°C gas inlet 3/8" gas outlet 3/8" thermocouple connection M9x1 pilot connection M10x1 probe ø 4mm probe L 72mm capillary pipe 1050mm SIT		
For models:	1A1FAS2G, 1A1FASG, 1A1TP0G, 1D1FAS2G, 1D1FASG, 1D1TP0G, 2A1FAS2G, 2A1FASG, 2A1TPSG, 2D1FAS2G, 2D1FASG, 2D1TPSG, 3A1FASG, 3D1FASG		
accessories for	101915		
	GEV No.	100825	Ref. No. 33Q3480
	gas tap spindle shaft ø 8x6.5mm shaft L 22/14mm suitable for EUROSIT		
	GEV No.	100904	Ref. No. —
	locking screw M10x1 for pipe ø 4mm Qty 1 pcs		
	GEV No.	100905	Ref. No. —
	locking screw M10x1 for pipe ø 6mm Qty 1 pcs		
	GEV No.	100949	Ref. No. 3152280
	gasket suitable for 630 Eurosit series		
	GEV No.	101273	Ref. No. —
	olive for pipe ø 12mm L 9.5mm brass Qty 1 pcs suitable for universal		
	GEV No.	101276	Ref. No. 36Q0710
	union screw thread 3/8" tube ø 12mm Qty 1 pcs		
	GEV No.	101333	Ref. No. 36R0010
	plug thread 3/8" with O-ring		
	GEV No.	101390	Ref. No. —
	gas tap spindle shaft ø 6x4.6mm shaft L 32/15mm gas tap with ignition flame suitable for ZANUSSI, MARENO for gas thermostat EUROSIT		
	GEV No.	101392	Ref. No. 33A0920
	adapter suitable for 630 Eurosit series		
	GEV No.	110357	Ref. No. —
	gas tap spindle shaft ø 8x6.5mm shaft L 36/12mm suitable for 630 Eurosit series		
	GEV No.	110358	Ref. No. —
	adapter shaft ø 10x8mm shaft L 29/18mm suitable for 630 Eurosit series		

















GEV No.	106164	Ref. No.	3041720 6018970
description	gas thermostat type 630 Eurosit series t.max. 340°C 100-340°C gas inlet 3/8" gas outlet 3/8" thermocouple connection M9x1 pilot connection M10x1 probe ø 4mm probe L 72mm capillary pipe 1050mm pressure regulator 13-18mbar ambient temperature max. 0-120°C		
For models:	08WFA4G, 08WFAAG, 08WFT1GV, 08WFT2GV, 08WFT3GV, 08WFT-7GV, 090FT1G, 090FT2G, 090FT4G, 090FT5G, 090FT7G, 0G0FT1G-VERS.032008, 0G0FT2G-VERS.032008, 0G0FT7G, 0G1BR3G, 12WFA6G, 12WFAAG, 190FT15G, 190FT1G, 190FT2G, 190FT3G, 190FT42G, 190FT4G, 190FT6G, 190FT72G, 190FT7G, 191FAAG, 191FABG, 191FADG, 191FAG, 191TPG, 1A1FA1G, 1A1FA2G, 1A1FA4G, 1A1FA5G, 1A1FAAG, 1A1FABG, 1A1TP0G-VERS.2002, 1B1FAS2G, 1B1FASG, 1D1FA1G, 1D1FA2G, 1D1FA4G, 1D1FA5G, 1D1FAAG, 1D1FABG, 1D1TP0G-VERS.2002, 1G0FT1G-VERS.032008, 1G0FT2G-VERS.032008, 1G0FT3G-VERS.032008...(Other models you can see in the webshop)		
accessories for	106164		
	GEV No.	100904	Ref. No. —
	locking screw M10x1 for pipe ø 4mm Qty 1 pcs		
	GEV No.	100905	Ref. No. —
	locking screw M10x1 for pipe ø 6mm Qty 1 pcs		
	GEV No.	101273	Ref. No. —
	olive for pipe ø 12mm L 9.5mm brass Qty 1 pcs suitable for universal		
	GEV No.	101276	Ref. No. 36Q0710
	union screw thread 3/8" tube ø 12mm Qty 1 pcs		
	GEV No.	101333	Ref. No. 36R0010
	plug thread 3/8" with O-ring		



GEV No.	101125	Ref. No.	33A0570 33A0571
description	gas thermostat type 630 Eurosit series t.max. 340°C 100-340°C gas inlet 3/8" gas outlet 3/8" thermocouple connection M9x1 pilot connection M10x1 probe ø 4mm probe L 72mm capillary pipe 1050mm SIT		
For models:	08WFAAG, 0G1BR3G, 12WFAAG, 1A1FA1G, 1A1FA2G, 1A1FA4G, 1A1FA5G, 1A1FAAG, 1A1FABG, 1A1TP0G-VERS.2002, 1B1FAS2G, 1B1FASG, 1D1FA1G, 1D1FA2G, 1D1FA4G, 1D1FA5G, 1D1FAAG, 1D1FABG, 1D1TP0G-VERS.2002, 1G1BR3G, 2A1FA1G, 2A1FA4G, 2A1FAAG, 2A1TP3G, 2A1TP6G, 2A1TPCG, 2D1FA1G, 2D1FA4G, 2D1FAAG, 2D1TP3G, 2D1TP6G, 2D1TPCG, 3A1FA1G, 3A1FA4G, 3A1FAAG, 3D1FA1G, 3D1FA4G, 3D1FAAG		
accessories for	101125		
	GEV No.	100825	Ref. No. 33Q3480
gas tap spindle shaft ø 8x6.5mm shaft L 22/14mm suitable for EUROSIT			
	GEV No.	100904	Ref. No. —
locking screw M10x1 for pipe ø 4mm Qty 1 pcs			
	GEV No.	100905	Ref. No. —
locking screw M10x1 for pipe ø 6mm Qty 1 pcs			
	GEV No.	100949	Ref. No. 3152280
gasket suitable for 630 Eurosit series			
	GEV No.	101273	Ref. No. —
olive for pipe ø 12mm L 9.5mm brass Qty 1 pcs suitable for universal			
	GEV No.	101276	Ref. No. 36Q0710
union screw thread 3/8" tube ø 12mm Qty 1 pcs			
	GEV No.	101333	Ref. No. 36R0010
plug thread 3/8" with O-ring			
	GEV No.	101390	Ref. No. —
gas tap spindle shaft ø 6x4.6mm shaft L 32/15mm gas tap with ignition flame suitable for ZANUSSI, MARENO for gas thermostat EUROSIT			
	GEV No.	101392	Ref. No. 33A0920
adapter suitable for 630 Eurosit series			
	GEV No.	110357	Ref. No. —
gas tap spindle shaft ø 8x6.5mm shaft L 36/12mm suitable for 630 Eurosit series			
	GEV No.	110358	Ref. No. —
adapter shaft ø 10x8mm shaft L 29/18mm suitable for 630 Eurosit series			



GEV No.	101971	Ref. No.	6300479
description	gas thermostat type 630 Eurosit series t.max. 340°C 100-340°C SIT		
spare parts for	101971		
	GEV No.	100825	Ref. No. 33Q3480
gas tap spindle shaft ø 8x6.5mm shaft L 22/14mm suitable for EUROSIT			
	GEV No.	101392	Ref. No. 33A0920
adapter suitable for 630 Eurosit series			
accessories for	101971		
	GEV No.	100825	Ref. No. 33Q3480
gas tap spindle shaft ø 8x6.5mm shaft L 22/14mm suitable for EUROSIT			
	GEV No.	100904	Ref. No. —
locking screw M10x1 for pipe ø 4mm Qty 1 pcs			
	GEV No.	100905	Ref. No. —
locking screw M10x1 for pipe ø 6mm Qty 1 pcs			
	GEV No.	100949	Ref. No. 3152280
gasket suitable for 630 Eurosit series			
	GEV No.	101273	Ref. No. —
olive for pipe ø 12mm L 9.5mm brass Qty 1 pcs suitable for universal			
	GEV No.	101276	Ref. No. 36Q0710
union screw thread 3/8" tube ø 12mm Qty 1 pcs			
	GEV No.	101333	Ref. No. 36R0010
plug thread 3/8" with O-ring			
	GEV No.	101390	Ref. No. —
gas tap spindle shaft ø 6x4.6mm shaft L 32/15mm gas tap with ignition flame suitable for ZANUSSI, MARENO for gas thermostat EUROSIT			
	GEV No.	101392	Ref. No. 33A0920
adapter suitable for 630 Eurosit series			
	GEV No.	110357	Ref. No. —
gas tap spindle shaft ø 8x6.5mm shaft L 36/12mm suitable for 630 Eurosit series			
	GEV No.	110358	Ref. No. —
adapter shaft ø 10x8mm shaft L 29/18mm suitable for 630 Eurosit series			

GEV No.	107846	Ref. No.	6300641
description	gas thermostat type EUROSIT 80-320°C gas inlet 3/8" gas outlet 3/8" thermocouple connection M9x1 pilot connection M10x1 probe L 72mm capillary pipe 980mm SIT		
For models:	1A1FAS2G, 1A1FASG, 1A1TP0G, 1D1FAS2G, 1D1FASG, 1D1TP0G, 2A1FAS2G, 2A1FASG, 2A1TPSG, 2D1FAS2G, 2D1FASG, 2D1TPSG, 3A1FASG, 3D1FASG		

710 Minisit series



GEV No.	106241	Ref. No.	6000380
description	gas thermostat SIT type MINISIT 710 t.max. 190°C 50-190°C pressure controller yes		
spare parts for	106241		
	GEV No.	101053	Ref. No. 32Z1490
	magnet unit T1: M9x1 T2: M24x1 L 45mm ø 17mm suitable for Minisit		
accessories for	106241		
	GEV No.	100809	Ref. No. —
	O-ring EPDM thickness 2mm ID ø 21mm Qty 1 pcs		
	GEV No.	100904	Ref. No. —
	locking screw M10x1 for pipe ø 4mm Qty 1 pcs		
	GEV No.	100905	Ref. No. —
	locking screw M10x1 for pipe ø 6mm Qty 1 pcs		
	GEV No.	101054	Ref. No. —
	magnet unit T1: M10x1 T2: M24x1 L 45mm ø 17mm suitable for Minisit		
	GEV No.	101136	Ref. No. —
	piezoelectric igniter suitable for Minisit with cover cap ømm connection F6.3x0.8		
	GEV No.	101137	Ref. No. —
	cover cap without piezoelectric igniter		
	GEV No.	101267	Ref. No. —
	reducer IT 3/8" ET 1/2" L 21mm		
	GEV No.	101268	Ref. No. —
	gas connection thread 3/8" angled with O-ring MINISIT 710		

accessories for	106241		
	GEV No.	101269	Ref. No. —
	gas connection thread 1/2" angled with O-ring MINISIT 710		
	GEV No.	101270	Ref. No. —
	screw connection IT 3/8" ET 3/8" L 28mm		
	GEV No.	101272	Ref. No. —
	screw connection IT 1/2" ET 3/8" L 57mm		
	GEV No.	101273	Ref. No. —
	olive for pipe ø 12mm L 9.5mm brass Qty 1 pcs suitable for universal		
	GEV No.	101274	Ref. No. —
	olive for pipe ø 16mm Qty 1 pcs		
	GEV No.	101275	Ref. No. —
	union screw thread 1/2" for pipe ø 16mm Qty 1 pcs		
	GEV No.	101276	Ref. No. 36Q0710
	union screw thread 3/8" tube ø 12mm Qty 1 pcs		
	GEV No.	110068	Ref. No. 36M0950
	knob suitable for Minisit ø 37mm		









GEV No.	106239	Ref. No.	33A1031
description	gas thermostat SIT type MINISIT 710 t.max. 340°C 100-340°C gas inlet 1/2" gas outlet 3/8" thermocouple connection M9x1 pilot connection M10x1 probe ø 4mm probe L 72mm capillary pipe 1050mm probe type type C1 pressure controller yes pressure regulator 3-18mbar gland nut		
For models:	031FT04, 031FT06, 070FT04, 070FT05, 071FT04, 071FT06, 090FT04, 090FT05, 091FT04, 091FT06, 1G1BR1G, 31R, 712D, 712VA, 71D, 71DGG, 71TP, 72D, 72DGG, 72TP, 72TPGG, 72VA, 72VAGG, 72VAS, 72VASGG, 73D, 73DGG, 73VA, 73VAD, 73VADGG, 73VAGG, FS30		
spare parts for	106239		
	GEV No.	101053	Ref. No. 32Z1490
	magnet unit T1: M9x1 T2: M24x1 L 45mm ø 17mm suitable for Minisit		
	GEV No.	102107	Ref. No. —
	probe 100-340°C probe ø 4mm probe L 72mm capillary pipe 1050mm t.max. 340°C oven/grill probe type type C1 suitable for MINISIT 710		
accessories for	106239		
	GEV No.	100809	Ref. No. —
	O-ring EPDM thickness 2mm ID ø 21mm Qty 1 pcs		
	GEV No.	100904	Ref. No. —
	locking screw M10x1 for pipe ø 4mm Qty 1 pcs		

Table continues overleaf

accessories for		106239		
	GEV No.	100905	Ref. No.	—
	locking screw M10x1 for pipe ø 6mm Qty 1 pcs			
	GEV No.	101137	Ref. No.	—
	cover cap without piezoelectric igniter			
	GEV No.	101267	Ref. No.	—
	reducer IT 3/8" ET 1/2" L 21mm			
	GEV No.	101268	Ref. No.	—
	gas connection thread 3/8" angled with O-ring MINISIT 710			
	GEV No.	101269	Ref. No.	—
	gas connection thread 1/2" angled with O-ring MINISIT 710			
	GEV No.	101270	Ref. No.	—
	screw connection IT 3/8" ET 3/8" L 28mm			
	GEV No.	101272	Ref. No.	—
	screw connection IT 1/2" ET 3/8" L 57mm			
	GEV No.	101273	Ref. No.	—
	olive for pipe ø 12mm L 9.5mm brass Qty 1 pcs suitable for universal			
	GEV No.	101274	Ref. No.	—
	olive for pipe ø 16mm Qty 1 pcs			
	GEV No.	101275	Ref. No.	—
	union screw thread 1/2" for pipe ø 16mm Qty 1 pcs			
	GEV No.	101276	Ref. No.	36Q0710
	union screw thread 3/8" tube ø 12mm Qty 1 pcs			
	GEV No.	110068	Ref. No.	36M0950
	knob suitable for Minisit ø 37mm			



GEV No.	106240	Ref. No.	33A1910 6000370	
description	gas thermostat SIT type MINISIT 710 t.max. 340°C 100-340°C pressure controller yes			
For models:	0M0FT1G, 0M0FT2G, 0M0FT4G, 0M0FT5G, 1M0FT1G, 1M0FT2G, 1M0FT3G, 1M0FT4G, 1M0FT5G, 1M0FT6G, 2M0FT1G, 2M0FT2G, 2M0FT3G, 2M0FT4G, 2M0FT5G, 2M0FT6G			
spare parts for	106240			
	GEV No.	100068	Ref. No.	—
	pilot burner 2 flames gas connection 6mm			
	GEV No.	100809	Ref. No.	—
	O-ring EPDM thickness 2mm ID ø 21mm Qty 1 pcs			





spare parts for		106240		
	GEV No.	100905	Ref. No.	—
	locking screw M10x1 for pipe ø 6mm Qty 1 pcs			
	GEV No.	101137	Ref. No.	—
	cover cap without piezoelectric igniter			
	GEV No.	101273	Ref. No.	—
	olive for pipe ø 12mm L 9.5mm brass Qty 1 pcs suitable for universal			
	GEV No.	101276	Ref. No.	36Q0710
	union screw thread 3/8" tube ø 12mm Qty 1 pcs			
	GEV No.	101505	Ref. No.	—
	gas connection thread 3/8" angled without O-ring MINISIT 710			
	GEV No.	101516	Ref. No.	—
	flat-headed bolt thread M4 thread L 16mm SS DIN 7985/ISO 7045 Qty 1 pcs			
	GEV No.	110068	Ref. No.	36M0950
	knob suitable for Minisit ø 37mm			











accessories for		106240		
	GEV No.	100904	Ref. No.	—
	locking screw M10x1 for pipe ø 4mm Qty 1 pcs			
	GEV No.	101267	Ref. No.	—
	reducer IT 3/8" ET 1/2" L 21mm			
	GEV No.	101268	Ref. No.	—
	gas connection thread 3/8" angled with O-ring MINISIT 710			
	GEV No.	101269	Ref. No.	—
	gas connection thread 1/2" angled with O-ring MINISIT 710			
	GEV No.	101270	Ref. No.	—
	screw connection IT 3/8" ET 3/8" L 28mm			
	GEV No.	101272	Ref. No.	—
	screw connection IT 1/2" ET 3/8" L 57mm			
	GEV No.	101273	Ref. No.	—
	olive for pipe ø 12mm L 9.5mm brass Qty 1 pcs suitable for universal			
	GEV No.	101274	Ref. No.	—
	olive for pipe ø 16mm Qty 1 pcs			
	GEV No.	101275	Ref. No.	—
	union screw thread 1/2" for pipe ø 16mm Qty 1 pcs			
	GEV No.	101276	Ref. No.	36Q0710
	union screw thread 3/8" tube ø 12mm Qty 1 pcs			



			
GEV No.	101910 ¹	Ref. No.	33A1130
description	gas thermostat SIT type MINISIT 710 t.max. 90°C 20-90°C gas inlet 1/2" gas outlet 3/8" thermocouple connection M9x1 pilot connection M10x1 probe ø 10.5mm probe L 19mm capillary pipe 1050mm probe type type F2 pressure controller yes pressure regulator 3-18mbar gland nut probe thread 1/4"		
For models:	070BM, 071BM, 090BM, 091BM		
spare parts for	101910		
	GEV No.	101053	Ref. No. 32Z1490
	magnet unit T1: M9x1 T2: M24x1 L 45mm ø 17mm suitable for Minisit		
	GEV No.	106223	Ref. No. —
	probe 20-90°C probe ø 11mm probe thread 1/4" probe L 19mm capillary pipe 1050mm t.max. 90°C bain marie probe type type F2		
accessories for	101910		
	GEV No.	100809	Ref. No. —
	O-ring EPDM thickness 2mm ID ø 21mm Qty 1 pcs		
	GEV No.	100904	Ref. No. —
	locking screw M10x1 for pipe ø 4mm Qty 1 pcs		
	GEV No.	100905	Ref. No. —
	locking screw M10x1 for pipe ø 6mm Qty 1 pcs		
	GEV No.	101054	Ref. No. —
	magnet unit T1: M10x1 T2: M24x1 L 45mm ø 17mm suitable for Minisit		
	GEV No.	101136	Ref. No. —
	piezoelectric igniter suitable for Minisit with cover cap ømm connection F6.3x0.8		
	GEV No.	101137	Ref. No. —
	cover cap without piezoelectric igniter		
	GEV No.	101267	Ref. No. —
	reducer IT 3/8" ET 1/2" L 21mm		
	GEV No.	101268	Ref. No. —
	gas connection thread 3/8" angled with O-ring MINISIT 710		
	GEV No.	101269	Ref. No. —
	gas connection thread 1/2" angled with O-ring MINISIT 710		
	GEV No.	101270	Ref. No. —
	screw connection IT 3/8" ET 3/8" L 28mm		
	GEV No.	101272	Ref. No. —
	screw connection IT 1/2" ET 3/8" L 57mm		
	GEV No.	101273	Ref. No. —
	olive for pipe ø 12mm L 9.5mm brass Qty 1 pcs suitable for universal		

¹probe thread 1/4"



accessories for	101910		
	GEV No.	101274	Ref. No. —
	olive for pipe ø 16mm Qty 1 pcs		
	GEV No.	101275	Ref. No. —
	union screw thread 1/2" for pipe ø 16mm Qty 1 pcs		
	GEV No.	101276	Ref. No. 36Q0710
	union screw thread 3/8" tube ø 12mm Qty 1 pcs		
	GEV No.	110068	Ref. No. 36M0950
	knob suitable for Minisit ø 37mm		



			
GEV No.	101114 ¹	Ref. No.	33A1370 6000480
description	gas thermostat with pressure controller SIT type MINISIT 710 t.max. 190°C 110-190°C gas inlet 1/2" gas outlet 3/8" thermocouple connection M9x1 pilot connection M10x1 probe ø 10.5mm probe L 26mm capillary pipe 1050mm probe type type F3 pressure controller yes pressure regulator 3-18mbar gland nut		
For models:	30F, 30FS, 70F, 71F		
spare parts for	101114		
	GEV No.	101053	Ref. No. 32Z1490
	magnet unit T1: M9x1 T2: M24x1 L 45mm ø 17mm suitable for Minisit		
	GEV No.	102104	Ref. No. —
	probe 110-190°C probe ø 11mm probe thread 1/4" probe L 26mm capillary pipe 1050mm t.max. 190°C fryer probe type type F3 suitable for MINISIT 710		
accessories for	101114		
	GEV No.	100809	Ref. No. —
	O-ring EPDM thickness 2mm ID ø 21mm Qty 1 pcs		
	GEV No.	100820	Ref. No. —
	gland duct ET M14x1.5 IT M10x0.75 probe ø max. 6.5mm WS 22		
	GEV No.	100904	Ref. No. —
	locking screw M10x1 for pipe ø 4mm Qty 1 pcs		
	GEV No.	100905	Ref. No. —
	locking screw M10x1 for pipe ø 6mm Qty 1 pcs		
	GEV No.	101054	Ref. No. —
	magnet unit T1: M10x1 T2: M24x1 L 45mm ø 17mm suitable for Minisit		
	GEV No.	101136	Ref. No. —
	piezoelectric igniter suitable for Minisit with cover cap ømm connection F6.3x0.8		
	GEV No.	101137	Ref. No. —
	cover cap without piezoelectric igniter		

¹probe thread 1/4"
Table continues overleaf

accessories for		101114	
	GEV No.	101267	Ref. No. —
reducer IT 3/8" ET 1/2" L 21mm			
	GEV No.	101268	Ref. No. —
gas connection thread 3/8" angled with O-ring MINISIT 710			
	GEV No.	101269	Ref. No. —
gas connection thread 1/2" angled with O-ring MINISIT 710			
	GEV No.	101270	Ref. No. —
screw connection IT 3/8" ET 3/8" L 28mm			
	GEV No.	101272	Ref. No. —
screw connection IT 1/2" ET 3/8" L 57mm			
	GEV No.	101273	Ref. No. —
olive for pipe ø 12mm L 9.5mm brass Qty 1 pcs suitable for universal			
	GEV No.	101274	Ref. No. —
olive for pipe ø 16mm Qty 1 pcs			
	GEV No.	101275	Ref. No. —
union screw thread 1/2" for pipe ø 16mm Qty 1 pcs			
	GEV No.	101276	Ref. No. 36Q0710
union screw thread 3/8" tube ø 12mm Qty 1 pcs			
	GEV No.	110068	Ref. No. 36M0950
knob suitable for Minisit ø 37mm			
	GEV No.	361182	Ref. No. 3117580
nut thread 1/4" H 5mm nickel-plated brass WS 17 Qty 1 pcs			
	GEV No.	532520	Ref. No. 3150390
O-ring silicone thickness 2.62mm ID ø 15.08mm Qty 1 pcs			



GEV No.	101432	Ref. No.	32Z0360 33A0800
description	gas thermostat with push button SIT type MINISIT 710 t.max. 90°C 30-90°C gas inlet 1/2" gas outlet 1/2" thermocouple connection M9x1 pilot connection M10x1 probe ø 8mm probe L 100mm capillary pipe 1050mm probe type type E2 pressure controller yes pressure regulator 3-18mbar gland nut		
spare parts for	101432		
	GEV No.	100809	Ref. No. —
O-ring EPDM thickness 2mm ID ø 21mm Qty 1 pcs			
	GEV No.	100905	Ref. No. —
locking screw M10x1 for pipe ø 6mm Qty 1 pcs			

spare parts for		101432	
	GEV No.	101053	Ref. No. 32Z1490
magnet unit T1: M9x1 T2: M24x1 L 45mm ø 17mm suitable for Minisit			
	GEV No.	101269	Ref. No. —
gas connection thread 1/2" angled with O-ring MINISIT 710			
	GEV No.	102117	Ref. No. —
probe 30-90°C probe ø 8mm probe L 100mm capillary pipe 1050mm t.max. 90°C bain marie probe type type E2 suitable for MINISIT 710			
	GEV No.	110068	Ref. No. 36M0950
knob suitable for Minisit ø 37mm			
accessories for	101432		
	GEV No.	100904	Ref. No. —
locking screw M10x1 for pipe ø 4mm Qty 1 pcs			
	GEV No.	101054	Ref. No. —
magnet unit T1: M10x1 T2: M24x1 L 45mm ø 17mm suitable for Minisit			
	GEV No.	101136	Ref. No. —
piezoelectric igniter suitable for Minisit with cover cap ømm connection F6.3x0.8			
	GEV No.	101137	Ref. No. —
cover cap without piezoelectric igniter			
	GEV No.	101267	Ref. No. —
reducer IT 3/8" ET 1/2" L 21mm			
	GEV No.	101268	Ref. No. —
gas connection thread 3/8" angled with O-ring MINISIT 710			
	GEV No.	101270	Ref. No. —
screw connection IT 3/8" ET 3/8" L 28mm			
	GEV No.	101272	Ref. No. —
screw connection IT 1/2" ET 3/8" L 57mm			
	GEV No.	101273	Ref. No. —
olive for pipe ø 12mm L 9.5mm brass Qty 1 pcs suitable for universal			
	GEV No.	101274	Ref. No. —
olive for pipe ø 16mm Qty 1 pcs			
	GEV No.	101275	Ref. No. —
union screw thread 1/2" for pipe ø 16mm Qty 1 pcs			
	GEV No.	101276	Ref. No. 36Q0710
union screw thread 3/8" tube ø 12mm Qty 1 pcs			



GEV No.	101131	Ref. No.	33A0300
description	gas thermostat without cap, button and angle SIT type MINISIT 710 t.max. 190°C 50-190°C gas inlet 1/2" gas outlet 3/8" thermocouple connection M9x1 pilot connection M10x1 probe ø 5mm probe L 98mm capillary pipe 1200mm probe type type A2 pressure controller no pressure regulator mbar gland nut		
For models:	B1101S, BF101L, BF101S, IS102S, IS102SR, IS102SR-0NR01, IS102SW, SM2L, SM2LW, SM2S, SM2SW, SM4SR, VS101L, XA72S, XS101L, XS101S, XS72S		
spare parts for	101131		
	GEV No.	101053	Ref. No. 32Z1490
	magnet unit T1: M9x1 T2: M24x1 L 45mm ø 17mm suitable for Minisit		
	GEV No.	102103	Ref. No. —
	probe 60-200°C probe ø 5mm probe L 98mm capillary pipe 1050mm t.max. 200°C fryer probe type type A2 suitable for MINISIT 710		
accessories for	101131		
	GEV No.	100809	Ref. No. —
	O-ring EPDM thickness 2mm ID ø 21mm Qty 1 pcs		
	GEV No.	100820	Ref. No. —
	gland duct ET M14x1.5 IT M10x0.75 probe ø max. 6.5mm WS 22		
	GEV No.	100904	Ref. No. —
	locking screw M10x1 for pipe ø 4mm Qty 1 pcs		
	GEV No.	100905	Ref. No. —
	locking screw M10x1 for pipe ø 6mm Qty 1 pcs		
	GEV No.	101054	Ref. No. —
	magnet unit T1: M10x1 T2: M24x1 L 45mm ø 17mm suitable for Minisit		
	GEV No.	101136	Ref. No. —
	piezoelectric igniter suitable for Minisit with cover cap ømm connection F6.3x0.8		
	GEV No.	101137	Ref. No. —
	cover cap without piezoelectric igniter		
	GEV No.	101267	Ref. No. —
	reducer IT 3/8" ET 1/2" L 21mm		
	GEV No.	101268	Ref. No. —
	gas connection thread 3/8" angled with O-ring MINISIT 710		
	GEV No.	101269	Ref. No. —
	gas connection thread 1/2" angled with O-ring MINISIT 710		
	GEV No.	101270	Ref. No. —
	screw connection IT 3/8" ET 3/8" L 28mm		
	GEV No.	101272	Ref. No. —
	screw connection IT 1/2" ET 3/8" L 57mm		

accessories for	101131		
	GEV No.	101273	Ref. No. —
	olive for pipe ø 12mm L 9.5mm brass Qty 1 pcs suitable for universal		
	GEV No.	101274	Ref. No. —
	olive for pipe ø 16mm Qty 1 pcs		
	GEV No.	101275	Ref. No. —
	union screw thread 1/2" for pipe ø 16mm Qty 1 pcs		
	GEV No.	101276	Ref. No. 36Q0710
	union screw thread 3/8" tube ø 12mm Qty 1 pcs		
	GEV No.	110068	Ref. No. 36M0950
	knob suitable for Minisit ø 37mm		

PEL

24ST series

GEV No.	106197	Ref. No.	33A1850
description	gas thermostat PEL type 24ST 120-280°C gas inlet pipe flange ø21mm bypass nozzle ø 0.35mm gas outlet M20x1.5 (tube ø 12/10mm) thermocouple connection M9x1 pilot connection M10x1 capillary pipe 1200mm probe ø 6mm probe L 120mm shaft ø 10x8mm shaft L 31/15mm shaft flat upper		
For models:	0A0FT4G, 0A0FT5G, 0B0FT1G, 0B0FT2G, 0B0FT4G, 0B0FT5G, 0D0FT4G, 0D0FT5G, 0G0FT4G, 0G0FT5G, 1A0FT4G, 1A0FT6G, 1B0FT4G, 1B0FT6G, 1D0FT4G, 1D0FT6G, 1G0FT4G, 1G0FT6G		
spare parts for	106197		
	GEV No.	100455	Ref. No. —
	bypass nozzle type PEL23/24 bore ø 0.35mm thread M8x0.5		
	GEV No.	101058	Ref. No. 32Z1460
	magnet unit L 39mm D1 ø 15.4mm D2 ø 13.5mm suitable for PEL22/ EGA24197 standard		
	GEV No.	106165	Ref. No. —
	gasket ø 27mm		
	GEV No.	106200	Ref. No. —
	nut thread M9x1 suitable for PEL 24/25S		
accessories for	106197		
	GEV No.	100908	Ref. No. 36Q1000
	union screw thread M10x1 for pipe ø 4mm Qty 1 pcs		
	GEV No.	100909	Ref. No. 36Q0060
	union screw thread M10x1 for pipe ø 6mm Qty 1 pcs		
	GEV No.	101246	Ref. No. —
	olive for pipe ø 4mm Qty 1 pcs		

Table continues overleaf

accessories for		106197		
GEV No.		101248	Ref. No.	36Q0030
	olive for pipe ø 12mm Qty 1 pcs suitable for PEL			
GEV No.		101249	Ref. No.	36Q1700
	olive for pipe ø 10mm Qty 1 pcs			
GEV No.		101250	Ref. No.	36Q0610
	union nut thread M20x1.5 for pipe ø 10mm			
GEV No.		101251	Ref. No.	36Q0050
	union nut thread M20x1.5 for pipe ø 12mm			
GEV No.		101286	Ref. No.	36Q0020
	olive ID ø 6mm Qty 1 pcs			
GEV No.		101331	Ref. No.	—
	adapter suitable for PEL22 for flanged cable 10/12mm			



GEV No.	106198	Ref. No.	33A1790	
description	gas thermostat PEL type 24ST 140-340°C gas inlet pipe flange ø21mm bypass nozzle ø 0mm gas outlet M20x1.5 (tube ø 12/10mm) thermocouple connection M8x1 pilot connection M10x1 capillary pipe 1200mm probe ø 6mm probe L 100mm shaft ø 10x9mm shaft L 27/17mm shaft flat upper			
For models:	0A0FT1G, 0A0FT2G, 0D0FT1G, 0D0FT2G, 0G0FT1G, 0G0FT2G, 1A0FT1G, 1A0FT2G, 1A0FT3G, 1B0FT1G, 1B0FT2G, 1B0FT3G, 1D0FT1G, 1D0FT2G, 1D0FT3G, 1G0FT1G, 1G0FT2G, 1G0FT3G			
spare parts for	106198			
	GEV No.	100455	Ref. No.	—
	bypass nozzle type PEL23/24 bore ø 0.35mm thread M8x0.5			
	GEV No.	101058	Ref. No.	32Z1460
	magnet unit L 39mm D1 ø 15.4mm D2 ø 13.5mm suitable for PEL22/EGA24197 standard			
	GEV No.	101536	Ref. No.	—
	gasket D1 ø 17mm D2 ø 11.5mm thickness 4.7mm			
	GEV No.	106199	Ref. No.	—
	nut thread M8x1			
accessories for	106198			
	GEV No.	100908	Ref. No.	36Q1000
	union screw thread M10x1 for pipe ø 4mm Qty 1 pcs			
	GEV No.	100909	Ref. No.	36Q0060
	union screw thread M10x1 for pipe ø 6mm Qty 1 pcs			
	GEV No.	101246	Ref. No.	—
	olive for pipe ø 4mm Qty 1 pcs			
	GEV No.	101248	Ref. No.	36Q0030
	olive for pipe ø 12mm Qty 1 pcs suitable for PEL			



accessories for		106198		
GEV No.		101249	Ref. No.	36Q1700
	olive for pipe ø 10mm Qty 1 pcs			
GEV No.		101250	Ref. No.	36Q0610
	union nut thread M20x1.5 for pipe ø 10mm			
GEV No.		101251	Ref. No.	36Q0050
	union nut thread M20x1.5 for pipe ø 12mm			
GEV No.		101286	Ref. No.	36Q0020
	olive ID ø 6mm Qty 1 pcs			
GEV No.		101331	Ref. No.	—
	adapter suitable for PEL22 for flanged cable 10/12mm			





GEV No.	101900	Ref. No.	33A2840	
description	gas thermostat PEL type 24ST up to 280°C gas inlet M20x1.5 (tube ø 12mm) bypass nozzle ø 0.8mm gas outlet M20x1.5 (tube ø 12/10mm) thermocouple connection M8x1 pilot connection M10x1 capillary pipe 1200mm probe ø 6mm probe L 120mm shaft ø 10x9mm shaft L 31/15mm shaft flat upper			
For models:	030FT, 030FTR, 031FT, 031FTR, 031FTRL, 31, 31TC, 31TP, 32, 32TC, 32TP, 32TPV, 32V			
spare parts for	101900			
	GEV No.	100497	Ref. No.	33T4060
	bypass nozzle type PEL23/24 bore ø 0.8mm thread M8x0.5			
	GEV No.	101058	Ref. No.	32Z1460
	magnet unit L 39mm D1 ø 15.4mm D2 ø 13.5mm suitable for PEL22/EGA24197 standard			
	GEV No.	106199	Ref. No.	—
	nut thread M8x1			
accessories for	101900			
	GEV No.	100908	Ref. No.	36Q1000
	union screw thread M10x1 for pipe ø 4mm Qty 1 pcs			
	GEV No.	100909	Ref. No.	36Q0060
	union screw thread M10x1 for pipe ø 6mm Qty 1 pcs			
	GEV No.	101246	Ref. No.	—
	olive for pipe ø 4mm Qty 1 pcs			
	GEV No.	101248	Ref. No.	36Q0030
	olive for pipe ø 12mm Qty 1 pcs suitable for PEL			
	GEV No.	101249	Ref. No.	36Q1700
	olive for pipe ø 10mm Qty 1 pcs			
	GEV No.	101250	Ref. No.	36Q0610
	union nut thread M20x1.5 for pipe ø 10mm			
	GEV No.	101251	Ref. No.	36Q0050
	union nut thread M20x1.5 for pipe ø 12mm			

Table continues overleaf



accessories for		101900		
	GEV No.	101286	Ref. No.	36Q0020
	olive ID ø 6mm Qty 1 pcs			
	GEV No.	110079	Ref. No.	—
	knob dial plate gas thermostat 1-8 silver			
	GEV No.	110080	Ref. No.	3FL1230
	knob ø 70mm shaft ø 10x8mm shaft flat universal			

accessories for		101161		
	GEV No.	101461	Ref. No.	—
	screw kit suitable for PEL22 Qty 4 pcs			
	GEV No.	110079	Ref. No.	—
	knob dial plate gas thermostat 1-8 silver			
	GEV No.	110080	Ref. No.	3FL1230
	knob ø 70mm shaft ø 10x8mm shaft flat universal			

24STS series				
				
GEV No.	101161	Ref. No.	33A0060 6003911	
description	gas thermostat PEL type 24STS 120-320°C gas inlet M20x1.5 (tube ø 12/10mm) bypass nozzle ø 0.35mm gas outlet M20x1.5 (tube ø 12/10mm) thermocouple connection M9x1 pilot connection M10x1 capillary pipe 1200mm probe ø 6mm probe L 100mm shaft ø 10x8mm shaft L 27/17mm shaft flat upper			
spare parts for	101161			
	GEV No.	101058	Ref. No.	32Z1460
	magnet unit L 39mm D1 ø 15.4mm D2 ø 13.5mm suitable for PEL22/EGA24197 standard			
accessories for	101161			
	GEV No.	101235	Ref. No.	—
	gas connection thread M20x1.5 tube ø 12/10mm for PEL gas taps horizontal			
	GEV No.	101236	Ref. No.	—
	gas connection thread M20x1.5 tube ø 12/10mm for PEL gas taps vertical			
	GEV No.	101240	Ref. No.	—
	gas connection thread M20x1.5 tube ø 12/10mm for PEL gas taps with gasket and screws horizontal			
	GEV No.	101241	Ref. No.	—
	gas connection thread M20x1.5 tube ø 12/10mm for PEL gas taps vertical			
	GEV No.	101248	Ref. No.	36Q0030
	olive for pipe ø 12mm Qty 1 pcs suitable for PEL			
	GEV No.	101249	Ref. No.	36Q1700
	olive for pipe ø 10mm Qty 1 pcs			
	GEV No.	101250	Ref. No.	36Q0610
	union nut thread M20x1.5 for pipe ø 10mm			
	GEV No.	101251	Ref. No.	36Q0050
	union nut thread M20x1.5 for pipe ø 12mm			
	GEV No.	101365	Ref. No.	—
	gas connection thread M20x1.5 tube ø 12mm for PEL gas taps horizontal			
	GEV No.	101460	Ref. No.	—
	O-ring ø 12.37mm D1 ø 2.62mm suitable for PEL22			

25ST series				
				
GEV No.	101565	Ref. No.	33A0660	
description	gas thermostat PEL type 25ST up to 280°C gas inlet pipe flange ø21mm bypass nozzle ø 0mm gas outlet M16x1.5 (tube ø 10/8mm) thermocouple connection M9x1 pilot connection M10x1 capillary pipe 1200mm probe ø 6mm probe L 122mm shaft ø 8x6.5mm shaft L 21/15mm shaft flat upper pipe input ø 9mm			
For models:	1G1FA0G, 1G1FA0GV, 1G1FABG, 1G1FAPG, 1G1TP0G, 2G1FA0G, 2G1FA0GV, 2G1FABG, 2G1FACG, 2G1FADG, 2G1FADGV, 2G1FAPG, 2G1TP3G, G1FAGS, G1FAGST			

gas valves and ignition boxes



gas control valves

HONEYWELL				
				
GEV No.	106004	Ref. No.	32V5810	
description	gas valve type VK4105C 220-240V 50/60Hz gas inlet flange 32x32mm gas outlet flange 32x32mm thermocouple connection pilot connection pressure range 15-60mbar max 60mbar operator type pressure controller type V5306E 1234 1 suitable for HONEYWELL flange 32x32mm			
For models:	FCV61DS-CSA			
accessories for	106004			
	GEV No.	102845	Ref. No.	—
	gas connection angled 1/2" flange 32x32mm hole distance 24x24mm Tandem			
	GEV No.	102846	Ref. No.	—
	gas connection straight 1/2" flange 32x32mm hole distance 24x24mm suitable for Tandem			



SIT
ELETTROSIT



1			
GEV No.	101993	Ref. No.	33A0590
description	gas valve SIT type ELETTROSIT 230V gas inlet 1/2" gas outlet 1/2" thermocouple connection M9x1 pilot connection M10x1 lateral equiv. no. 0.810.126		
For models:	30F1, 30F1B, 30FS2, 30FS2B, 70F1, 70F1B, 71AR, 71F2, 71F2B, 71RA, 90F110B, 91AR, 91F210, 91F210B, 91F223B, 91RA, FC101, FC61, FCV101, FCV101DM, FCV101DS, FCV241GDM, FCV241GDS, FCV401DM, FCV61, FCV61DM, FCV61DS		
spare parts for	101993		
	GEV No.	101312	Ref. No. 33A0020
	microswitch		
	GEV No.	101352	Ref. No. —
	solenoid coil 230V 50Hz suitable for ELETTROSIT		
accessories for	101993		
	GEV No.	100006	Ref. No. —
	piezoelectric igniter suitable for ELETTROSIT body plastic blowing connection ø2.4mm ø 14mm		
	GEV No.	100904	Ref. No. —
	locking screw M10x1 for pipe ø 4mm Qty 1 pcs		
	GEV No.	100905	Ref. No. —
	locking screw M10x1 for pipe ø 6mm Qty 1 pcs		
	GEV No.	101301	Ref. No. —
	gas connection thread 1/2" straight ELETTROSIT screw with O-ring		
	GEV No.	101303	Ref. No. —
	gas connection straight thread 3/4" ELETTROSIT		
	GEV No.	101309	Ref. No. —
	extension		
	GEV No.	103104	Ref. No. —
	ignition switch		
	GEV No.	541504	Ref. No. 33Q5880
	double nipple thread 1/2" - 1/2"		



1			
GEV No.	101127	Ref. No.	33A0530
description	gas valve SIT type ELETTROSIT 230V gas inlet 3/4" gas outlet 3/4" thermocouple connection M9x1 pilot connection M10x1 lateral equiv. no. 0.810.175		
For models:	FC241, FC241G, FCV141, FCV141DM, FCV141DS, FCV241, FCV241DM, FCV241DS, FCV241G		
spare parts for	101127		
	GEV No.	101312	Ref. No. 33A0020
	microswitch		
	GEV No.	101352	Ref. No. —
	solenoid coil 230V 50Hz suitable for ELETTROSIT		
accessories for	101127		
	GEV No.	100006	Ref. No. —
	piezoelectric igniter suitable for ELETTROSIT body plastic blowing connection ø2.4mm ø 14mm		
	GEV No.	100904	Ref. No. —
	locking screw M10x1 for pipe ø 4mm Qty 1 pcs		
	GEV No.	100905	Ref. No. —
	locking screw M10x1 for pipe ø 6mm Qty 1 pcs		
	GEV No.	101301	Ref. No. —
	gas connection thread 1/2" straight ELETTROSIT screw with O-ring		
	GEV No.	101303	Ref. No. —
	gas connection straight thread 3/4" ELETTROSIT		
	GEV No.	101309	Ref. No. —
	extension		





NOVASIT



1

GEV No.	101760	Ref. No.	33A1640
description	gas valve SIT series Novasit 820 220V 50Hz gas inlet 1/2" gas outlet 1/2" thermocouple connection M9x1 pilot connection M10x1 ignition pressure 3-5mbar pressure range 3-30mbar pressure regulator connection blind equiv. no. 0.820.060		
For models:	091FR1G, 091FR3G, 191FR2GD, 191FR4GD		
spare parts for	101760		
	GEV No.	101065	Ref. No. —
	magnet unit with cable L 44mm D1 ø 30mm D2 ø 20mm suitable for NOVASIT		
	GEV No.	101867	Ref. No. —
	solenoid coil 220V 60Hz		
accessories for	101760		
	GEV No.	100006	Ref. No. —
	piezoelectric igniter suitable for ELETTROSIT body plastic blowing connection ø2.4mm ø 14mm		
	GEV No.	100904	Ref. No. —
	locking screw M10x1 for pipe ø 4mm Qty 1 pcs		
	GEV No.	100905	Ref. No. —
	locking screw M10x1 for pipe ø 6mm Qty 1 pcs		
	GEV No.	101305	Ref. No. —
	gas connection straight 1/2" flange 45x45mm ELETTROSIT/V4400/4600/4605 suitable for SIT/HONEYWELL hole distance 36x36mm		
	GEV No.	101306	Ref. No. —
	gas connection angled flange 45x45mm hole distance 36x36mm 1/2" ELETTROSIT/V4400/4600/4605 screw with O-ring suitable for SIT/HONEYWELL		
	GEV No.	101307	Ref. No. —
	gas connection straight flange 45x45mm hole distance 36x36mm 3/4" ELETTROSIT/V4400/4600/4605 screw with O-ring suitable for SIT/HONEYWELL		
	GEV No.	101308	Ref. No. —
	gas connection angled flange 45x45mm hole distance 36x36mm 3/4" ELETTROSIT/V4400/4600/4605 screw with O-ring suitable for SIT/HONEYWELL		
	GEV No.	101312	Ref. No. 33A0020
	microswitch		
	GEV No.	101313	Ref. No. —
	solenoid coil 230V 50Hz		
	GEV No.	101314	Ref. No. —
	solenoid coil 24V 50Hz		
	GEV No.	101317	Ref. No. —
	plug with cable L 1000mm suitable for NOVASIT		

accessories for	101760		
	GEV No.	101318	Ref. No. —
	cover cap for solenoid coil suitable for NOVASIT		
	GEV No.	101503	Ref. No. —
	O-ring EPDM thickness 2mm ID ø 32mm Qty 1 pcs		

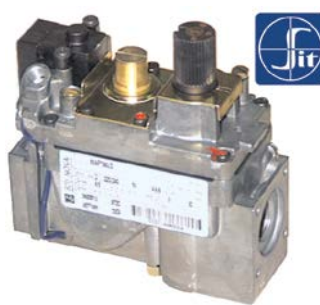

1











GEV No.	101162	Ref. No.	33A0460
description	gas valve SIT series Novasit 820 230V 50Hz gas inlet 1/2" gas outlet 1/2" thermocouple connection M9x1 pilot connection M10x1 ignition pressure 3-5mbar pressure range 3-30mbar pressure regulator connection blind equiv. no. 0.820.010		
For models:	06WFR3GD, 091FR1G, 091FR1GD, 091FR3G, 091FR3GD, 0A1FR1G, 0A1FR1GD, 0A1FR1GD-VERS.2004, 0A1FR1G-VERS.2004, 0A1FR3G, 0A1FR3GD, 0B1FR1G, 0B1FR1GD, 0D1FR1G, 0D1FR1GD, 0D1FR1GD-VERS.2004, 0D1FR1G-VERS.2004, 0D1FR3G, 0D1FR3GD, 0G1FR3G, 0G1FR3GD, 10WFR4GD, 191FR2G, 191FR2GD, 191FR4G, 191FR4GD, 1A1FR2G, 1A1FR2GD, 1A1FR2GD-VERS.2004, 1A1FR2G-VERS.2004, 1A1FR4G, 1A1FR4GD, 1D1FR2G, 1D1FR2GD, 1D1FR2GD-VERS.2004, 1D1FR2G-VERS.2004, 1D1FR4G, 1D1FR4GD, 1G1FR4G, 1G1FR4GD, FC101, FC241G, FC61, FCV101, FCV101DM, FCV101DS, FCV141, FCV141DM, FCV141DS, FCV241G...(Other models you can see in the webshop)		
spare parts for	101162		
	GEV No.	101065	Ref. No. —
	magnet unit with cable L 44mm D1 ø 30mm D2 ø 20mm suitable for NOVASIT		
	GEV No.	101313	Ref. No. —
	solenoid coil 230V 50Hz		
accessories for	101162		
	GEV No.	100006	Ref. No. —
	piezoelectric igniter suitable for ELETTROSIT body plastic blowing connection ø2.4mm ø 14mm		
	GEV No.	101305	Ref. No. —
	gas connection straight 1/2" flange 45x45mm ELETTROSIT/V4400/4600/4605 suitable for SIT/HONEYWELL hole distance 36x36mm		
	GEV No.	101306	Ref. No. —
	gas connection angled flange 45x45mm hole distance 36x36mm 1/2" ELETTROSIT/V4400/4600/4605 screw with O-ring suitable for SIT/HONEYWELL		
	GEV No.	101307	Ref. No. —
	gas connection straight flange 45x45mm hole distance 36x36mm 3/4" ELETTROSIT/V4400/4600/4605 screw with O-ring suitable for SIT/HONEYWELL		
	GEV No.	101308	Ref. No. —
	gas connection angled flange 45x45mm hole distance 36x36mm 3/4" ELETTROSIT/V4400/4600/4605 screw with O-ring suitable for SIT/HONEYWELL		
	GEV No.	101312	Ref. No. 33A0020
	microswitch		







Table continues overleaf







accessories for 101162				
	GEV No.	101314	Ref. No.	—
solenoid coil 24V 50Hz				
	GEV No.	101317	Ref. No.	—
plug with cable L 1000mm suitable for NOVASIT				
	GEV No.	101318	Ref. No.	—
cover cap for solenoid coil suitable for NOVASIT				



1

GEV No.	101688	Ref. No.	33A0930	
description	gas valve SIT series Novasit 824 230V 50Hz gas inlet 1/2" gas outlet 1/2" thermocouple connection M9x1 pilot connection M10x1 ignition pressurebar pressure range 2-50mbar pressure regulator connection equiv. no. 0.824.011			
For models:	191BR1G, 191BR1GA, 191BR2G, 191BR2GA, 1A1BR1G, 1A1BR1GA, 1A1BR2G, 1A1BR2GA, 1D1BR1G, 1D1BR1GA, 1D1BR2G, 1D1BR2GA, 291BR1G, 291BR1GA, 291BR2G, 291BR2GA, 2A1BR1G, 2A1BR1GA, 2A1BR2G, 2A1BR2GA, 2D1BR1G, 2D1BR1GA, 2D1BR2G, 2D1BR2GA			
spare parts for	101688			
	GEV No.	101065	Ref. No.	—
magnet unit with cable L 44mm D1 ø 30mm D2 ø 20mm suitable for NOVASIT				
	GEV No.	101313	Ref. No.	—
solenoid coil 230V 50Hz				
accessories for	101688			
	GEV No.	100006	Ref. No.	—
piezoelectric igniter suitable for ELETTROSIT body plastic blowing connection ø2.4mm ø 14mm				
	GEV No.	100904	Ref. No.	—
locking screw M10x1 for pipe ø 4mm Qty 1 pcs				
	GEV No.	100905	Ref. No.	—
locking screw M10x1 for pipe ø 6mm Qty 1 pcs				
	GEV No.	101305	Ref. No.	—
gas connection straight 1/2" flange 45x45mm ELETTROSIT/V4400/4600/4605 suitable for SIT/HONEYWELL hole distance 36x36mm				
	GEV No.	101306	Ref. No.	—
gas connection angled flange 45x45mm hole distance 36x36mm 1/2" ELETTROSIT/V4400/4600/4605 screw with O-ring suitable for SIT/HONEYWELL				
	GEV No.	101307	Ref. No.	—
gas connection straight flange 45x45mm hole distance 36x36mm 3/4" ELETTROSIT/V4400/4600/4605 screw with O-ring suitable for SIT/HONEYWELL				
	GEV No.	101308	Ref. No.	—
gas connection angled flange 45x45mm hole distance 36x36mm 3/4" ELETTROSIT/V4400/4600/4605 screw with O-ring suitable for SIT/HONEYWELL				

accessories for 101688				
	GEV No.	101312	Ref. No.	33A0020
microswitch				
	GEV No.	101314	Ref. No.	—
solenoid coil 24V 50Hz				
	GEV No.	101317	Ref. No.	—
plug with cable L 1000mm suitable for NOVASIT				
	GEV No.	101318	Ref. No.	—
cover cap for solenoid coil suitable for NOVASIT				
	GEV No.	101503	Ref. No.	—
O-ring EPDM thickness 2mm ID ø 32mm Qty 1 pcs				

SIGMA



1

GEV No.	107893	Ref. No.	3041070	
description	gas valve type 0840028 220V 60Hz gas inlet 3/4" gas outlet 3/4" pressure range 2-50mbar			
For models:	091FR11, 091FR11A, 091FR11D, 091FR11D-VERS.052012, 091FR11-VERS.032012, 091FR7G, 091FR7GS, 091FR7G-VERS.052012, 091FR7GX, 191FR21, 191FR21D, 191FR21D-VERS.092012, 191FR21-VERS.032012, FC1011G, FC1221G, FC611G, FM1011G1, FM1011G1-VERS.2006, FM1011G2, FM1011G2-VERS.2006, FM1011G3, FM1011G3-VERS.2006, FM2011G2-VERS.2006, FM2011G3-VERS.2006, FM2021G1, FM2021G2, FM2021G2-VERS.2006, FM2021G3, FM2021G3-VERS.2006, FM611G1, FM611G1-VERS.2006, FM611G2, FM611G2-VERS.2006, FM611G3, FM611G3-VERS.2006, FM721G1, FM721G1-VERS.2006, FM721G2, FM721G2-VERS.2006, FM721G3, FM721G3-VERS.2006			





1

GEV No.	107894	Ref. No.	6300749
description	gas valve type 0848083 230V 50Hz gas inlet 3/4" gas outlet 3/4" pressure range 0.5-12mbar incl reducer 1/2" - 3/4"		
For models:	BX101G, BX101G-VERS.122013, BX122G, BX122G-VERS.122013, BX61G, BX61G-VERS.122013, BX82G, BX82G-VERS.122013, FX101G1, FX101G1R, FX101G2, FX101G2C, FX101G2C-VERS.032014, FX101G2R, FX101G2R-VERS.032014, FX101G2-VERS.032014, FX101G3, FX101G3C, FX101G3C-VERS.022014, FX101G3R, FX101G3R-VERS.022014, FX101G3-VERS.022014, FX10G2CR, FX10G2CR-VERS.032014, FX10G3CR, FX10G3CR-VERS.022014, FX122G1, FX122G2, FX122G2C, FX122G2T, FX122G2T-VERS.032014, FX122G3, FX122G3C, FX122G3T, FX122G3T-VERS.022014, FX12G3CT, FX12G3CT-VERS.022014, FX201G2, FX201G2P, FX201G2P-VERS.032014, FX201G2-VERS.032014, FX201G3P, FX201G3-VERS.022014, FX202G2, FX202G2-VERS.032014, FX202G3, FX202G3-VERS.022014, FX61G1, FX61G1R, FX61G2...(Other models you can see in the webshop)		



1

GEV No.	107241	Ref. No.	32V5800
description	gas valve type Sigma 230V 50Hz gas inlet 3/4" gas outlet 3/4" pressure range 2-50mbar		
For models:	FC1011G, FC611G, FM1011G1, FM1011G1-VERS.2006, FM1011G2, FM1011G2-VERS.2006, FM1011G3, FM1011G3-VERS.2006, FM2011G2-VERS.2006, FM2011G3-VERS.2006, FM2021G1, FM2021G2, FM2021G2-VERS.2006, FM2021G3, FM2021G3-VERS.2006, FM611G1, FM611G1-VERS.2006, FM611G2, FM611G2-VERS.2006, FM611G3, FM611G3-VERS.2006, FM721G1, FM721G1-VERS.2006, FM721G2, FM721G2-VERS.2006, FM721G3, FM721G3-VERS.2006		
spare parts for	107241		
	GEV No.	106214	Ref. No. 3188170
	solenoid coil 230V 50Hz Sigma		
accessories for	107241		
	GEV No.	107222	Ref. No. —
	plug for solenoid valve 3-pole cable length 1070mm		



2

GEV No.	107547	Ref. No.	3011580
description	gas valve type Sigma 230V 50Hz gas inlet 3/4" ET gas outlet 3/4" ET pressure range 2-50mbar equiv. no. 0063AS4831		
For models:	091FR1I, 091FR1IA, 091FR1ID, 091FR1ID-VERS.052012, 091FR1I-VERS.032012, 091FR7G, 091FR7G, 091FR7G-VERS.052012, 091FR7GX, 191FR2I, 191FR2ID, 191FR2ID-VERS.092012, 191FR2I-VERS.032012, FC1221G, FM1221G1, FM1221G1-VERS.2006, FM1221G2, FM1221G2-VERS.2006, FM1221G3, FM1221G3-VERS.2006		
spare parts for	107547		
	GEV No.	106214	Ref. No. 3188170
	solenoid coil 230V 50Hz Sigma		
accessories for	107547		
	GEV No.	107222	Ref. No. —
	plug for solenoid valve 3-pole cable length 1070mm		

ignition boxes

BRAHMA



1

GEV No.	107545	Ref. No.	3128260
description	ignition box BRAHMA type ECM113 electrodes 3 waiting time 1.5s safety time 3s 100-240V 15VA 50-60Hz		
For models:	091FR1I, 091FR1IA, 091FR1ID, 091FR1ID-VERS.052012, 091FR1I-VERS.032012, 091FR7G, 091FR7G, 091FR7G-VERS.052012, 091FR7GX, 10CP11A, 12CP11A, 18CP21A, 191FR2I, 191FR2ID, 191FR2ID-VERS.092012, 191FR2I-VERS.032012		



miscellaneous



GEV No.	103221	Ref. No.	32V5850 32V5851
description	ignition box RV CONSTRUCTIONS ELECTRIQUES type 0526 waiting time 7s safety time 10s 230V 50/60Hz		
For models:	FC1011G, FC1221G, FC611G, FM1011G1, FM1011G1-VERS.2006, FM1011G2, FM1011G2-VERS.2006, FM1011G3, FM1011G3-VERS.2006, FM1221G1, FM1221G1-VERS.2006, FM1221G2, FM1221G2-VERS.2006, FM1221G3, FM1221G3-VERS.2006, FM2011G2-VERS.2006, FM2011G3-VERS.2006, FM2021G1, FM2021G2, FM2021G2-VERS.2006, FM2021G3, FM2021G3-VERS.2006, FM611G1, FM611G1-VERS.2006, FM611G2, FM611G2-VERS.2006, FM611G3, FM611G3-VERS.2006, FM721G1, FM721G1-VERS.2006, FM721G2, FM721G2-VERS.2006, FM721G3, FM721G3-VERS.2006		

safety valves

SIT
440 series



GEV No.	101101	Ref. No.	33A0430
description	gas valve pressure range 50mbar gas inlet 3/4" gas outlet 3/4" pilot connection M10x1 (tube ø 6mm) thermocouple connection M9x1 type SIT D3		
accessories for	101101		
	GEV No.	100904	Ref. No. —
	locking screw M10x1 for pipe ø 4mm Qty 1 pcs		
	GEV No.	100905	Ref. No. —
	locking screw M10x1 for pipe ø 6mm Qty 1 pcs		

gas solenoid valves

BRAHMA



GEV No.	101948 ¹	Ref. No.	33A1650
description	solenoid valve 230VAC DN 15mm connection 1/2" L 72mm BRAHMA coil type 18811003 p max 0.5bar reg. no. 63AQ0626		
For models:	1A1PI2G, 1A1PI2GA, 1D1PI2G, 1D1PI2GA, 291PI3G, 2A1PI3G, 2D1PI3G		
spare parts for	101948		
	GEV No.	101968	Ref. No. —
	solenoid valve 230VAC 20VA seat ø 17mm coil type 13902001 BRAHMA		

¹aluminium housing

ignition parts

pilot burners

SIT



100 series







GEV No.	106905	Ref. No.	33A0410 6000290
description	pilot burner SIT type 100 series 2 flames nozzle ø 0.2mm gas connection 6mm		
spare parts for	106905		
	GEV No.	100245	Ref. No. —
	pilot burner nozzle LPG code 20 bore ø 0.2mm Qty 1 pcs thread M8x0.75		
	GEV No.	100855	Ref. No. 33S0950
	pilot burner bracket triple		
	GEV No.	100885	Ref. No. 33A0970
	air mixing sleeve for pilot burner Qty 1 pcs		
	GEV No.	100916	Ref. No. —
	compression spring for pilot burner Qty 1 pcs		
	GEV No.	100917	Ref. No. —
	gasket for pilot burner Qty 1 pcs aluminium		

Table continues overleaf



spare parts for		106905	
	GEV No.	100918	Ref. No. —
	screw for pilot burner		
	GEV No.	107161	Ref. No. —
	pilot burner cap SIT 2 flames Hmm Lmm Qty 1 pcs		
	GEV No.	107701	Ref. No. —
	pilot burner bottom part SIT 100 series nozzle \varnothing 0.2mm		
accessories for		106905	
	GEV No.	100246	Ref. No. 33T0410
	pilot burner nozzle natural gas bore \varnothing 0.35mm Qty 1 pcs thread M8x0.75		
	GEV No.	100904	Ref. No. —
	locking screw M10x1 for pipe \varnothing 4mm Qty 1 pcs		
	GEV No.	100905	Ref. No. —
	locking screw M10x1 for pipe \varnothing 6mm Qty 1 pcs		
	GEV No.	102110	Ref. No. —
	pilot tube copper pipe \varnothing 4mm thickness 1mm L 3000mm		
	GEV No.	102111	Ref. No. —
	pilot tube copper pipe \varnothing 6mm thickness 1mm L 3000mm		
	GEV No.	107171	Ref. No. 33T0340
	pilot burner nozzle SIT natural/liquid gas bore \varnothing 0.25mm Qty 1 pcs		
	GEV No.	107700	Ref. No. 33A0960
	pilot burner bottom part SIT 100 series nozzle \varnothing 0.25mm		
	GEV No.	107702	Ref. No. 33A2900
	pilot burner bottom part SIT 100 series nozzle \varnothing 0.35mm		

 <p>1</p>			
GEV No.	106906	Ref. No.	6000350
description	pilot burner SIT type 100 series 3 flames nozzle \varnothing 0.2mm gas connection 6mm		
For models:	71AR, 91AR, FS30		
spare parts for		106906	
	GEV No.	100245	Ref. No. —
	pilot burner nozzle LPG code 20 bore \varnothing 0.2mm Qty 1 pcs thread M8x0.75		
	GEV No.	100855	Ref. No. 33S0950
	pilot burner bracket triple		
	GEV No.	100885	Ref. No. 33A0970
	air mixing sleeve for pilot burner Qty 1 pcs		
	GEV No.	100916	Ref. No. —
	compression spring for pilot burner Qty 1 pcs		

spare parts for		106906	
	GEV No.	100917	Ref. No. —
	gasket for pilot burner Qty 1 pcs aluminium		
	GEV No.	100918	Ref. No. —
	screw for pilot burner		
	GEV No.	107162	Ref. No. 33A1080 33A1081
	pilot burner cap SIT 3 flames Hmm Lmm Qty 1 pcs		
	GEV No.	107701	Ref. No. —
	pilot burner bottom part SIT 100 series nozzle \varnothing 0.2mm		
accessories for		106906	
	GEV No.	100245	Ref. No. —
	pilot burner nozzle LPG code 20 bore \varnothing 0.2mm Qty 1 pcs thread M8x0.75		
	GEV No.	100246	Ref. No. 33T0410
	pilot burner nozzle natural gas bore \varnothing 0.35mm Qty 1 pcs thread M8x0.75		
	GEV No.	100904	Ref. No. —
	locking screw M10x1 for pipe \varnothing 4mm Qty 1 pcs		
	GEV No.	100905	Ref. No. —
	locking screw M10x1 for pipe \varnothing 6mm Qty 1 pcs		
	GEV No.	102110	Ref. No. —
	pilot tube copper pipe \varnothing 4mm thickness 1mm L 3000mm		
	GEV No.	102111	Ref. No. —
	pilot tube copper pipe \varnothing 6mm thickness 1mm L 3000mm		
	GEV No.	107171	Ref. No. 33T0340
	pilot burner nozzle SIT natural/liquid gas bore \varnothing 0.25mm Qty 1 pcs		
	GEV No.	107700	Ref. No. 33A0960
	pilot burner bottom part SIT 100 series nozzle \varnothing 0.25mm		
	GEV No.	107702	Ref. No. 33A2900
	pilot burner bottom part SIT 100 series nozzle \varnothing 0.35mm		



accessories

pilot burner caps



1

GEV No.	100832	Ref. No.	33A1070
description	pilot burner cap 1 flame suitable for 100 series Hmm Lmm Qty 1 pcs		
For models:	030, 031, 032, 070D, 070DGG, 0712D, 0712VA, 071D, 071DGG, 072D, 072DGG, 090, 090GG, 091, 091GG, 092, 092GG, 092VA, 092VAGG, 0A0FAS, 0B0FAS, 0D0FAS, 1A0FAS, 1A0FAS2, 1A1FAS2G, 1A1FASG, 1B0FAS, 1B0FAS2, 1B1FAS2G, 1B1FASG, 1D0FAS, 1D0FAS2, 1D1FAS2G, 1D1FASG, 2A0FAS2, 2A1FAS2G, 2A1FASG, 2A1TPSG, 2D0FAS2, 2D1FAS2G, 2D1FASG, 2D1TPSG, 31, 31GE, 31TC, 32, 32TC, 32TP, 32TPV, 32V...(Other models you can see in the webshop)		



2

GEV No.	100835	Ref. No.	32Z2241
description	pilot burner cap 3 flames suitable for 100 series H 35mm L 48mm Qty 1 pcs W 52mm		
For models:	090BM1G, 0A0BMG, 0A1FR1G, 0A1FR1GD, 0B1FR1G, 0B1FR1GD, 0D0BMG, 0D1FR1G, 0D1FR1GD, 190BM2G, 1A0BMG, 1A1FR2G, 1A1FR2GD, 1D0BMG, 1D1FR2G, 1D1FR2GD, 30CPS, 30F, 30F1, 30F1B, 30FS, 30FS2, 30FS2B, 60SM, 70CP, 70F, 70F1, 70F1B, 71CP, 71CP2, 71F, 71F2, 71F2B, 90CP, 90F110B, 91CP, 91F210, 91F210B, 91F223B		



1

GEV No.	107162	Ref. No.	33A1080 33A1081
description	pilot burner cap SIT 3 flames Hmm Lmm Qty 1 pcs		
For models:	030FT, 030FTR, 031FT, 031FT04, 031FT06, 031FTR, 031FTRL, 031TP, 06WCP1GM, 06WFR3GD, 070BM, 070FT, 070FT04, 070FT05, 070FTR, 0712VA, 071BM, 071FT, 071FT04, 071FT06, 071FTR, 071FTRL, 071TP, 08WCP1GM, 08WFA4G, 08WFAAG, 08WFT1GV, 08WFT2GV, 08WFT3GV, 08WFT4GV, 08WFT6GV, 08WFT7GV, 090BM, 090FAVA, 090FT, 090FT04, 090FT05, 090FT1G, 090FT2G, 090FT4G, 090FT5G, 090FT7G, 090FTR, 091BM, 091CP1G, 091FR1G, 091FR1GD, 091FR3G, 091FR3GD, 091FT...(Other models you can see in the webshop)		



1

GEV No.	107166	Ref. No.	33A0380
description	pilot burner head SIT 1 flame Hmm Lmm Qty 1 pcs		

pilot burner bottom parts







1



GEV No.	100998	Ref. No.	33A0200
description	pilot burner bottom part nozzle ϕ 0.21mm suitable for 100 series		
For models:	030, 031, 032, 31, 31GE, 31TC, 32, 32TC, 32TP, 32TPV, 32V		













1

GEV No.	107700	Ref. No.	33A0960
description	pilot burner bottom part SIT 100 series nozzle ϕ 0.25mm		
For models:	031FT04, 031FT06, 06WFR3GD, 070FT04, 070FT05, 071FT04, 071FT06, 08WCP1GM, 08WFT1GV, 08WFT2GV, 08WFT3GV, 08WFT4GV, 08WFT6GV, 08WFT7GV, 090FT04, 090FT05, 091FT04, 091FT06, 0A0FAVA, 0A1FR3G, 0A1FR3GD, 0D0FAVA, 0D1FR3G, 0D1FR3GD, 0G0FT1G, 0G0FT2G, 0G0FT4G, 0G0FT5G, 0G1CP1G, 0G1FR3G, 0G1FR3GD, 10WFR4GD, 1A1FR4G, 1A1FR4GD, 1D1FR4G, 1D1FR4GD, 1G0FT1G, 1G0FT2G, 1G0FT3G, 1G0FT4G, 1G0FT6G, 1G0TP0, 1G1BR1G, 1G1CP1G, 1G1CP2G, 1G1FA0G, 1G1FABG, 1G1FAPG, 1G1FR4G, 1G1FR4GD...(Other models you can see in the webshop)		

spare parts for	107700			
	GEV No.	100916	Ref. No.	—
	compression spring for pilot burner Qty 1 pcs			
	GEV No.	100917	Ref. No.	—
	gasket for pilot burner Qty 1 pcs aluminium			
	GEV No.	100918	Ref. No.	—
	screw for pilot burner			
	GEV No.	102742	Ref. No.	—
	pilot burner nozzle LPG code 25 bore ϕ 0.25mm Qty 1 pcs			

accessories for	107700			
	GEV No.	100245	Ref. No.	—
	pilot burner nozzle LPG code 20 bore ϕ 0.2mm Qty 1 pcs thread M8x0.75			
	GEV No.	100246	Ref. No.	33T0410
	pilot burner nozzle natural gas bore ϕ 0.35mm Qty 1 pcs thread M8x0.75			
	GEV No.	100904	Ref. No.	—
	locking screw M10x1 for pipe ϕ 4mm Qty 1 pcs			
	GEV No.	100905	Ref. No.	—
	locking screw M10x1 for pipe ϕ 6mm Qty 1 pcs			
	GEV No.	102110	Ref. No.	—
	pilot tube copper pipe ϕ 4mm thickness 1mm L 3000mm			
	GEV No.	102111	Ref. No.	—
	pilot tube copper pipe ϕ 6mm thickness 1mm L 3000mm			







 <p>1</p>			
GEV No.	107702	Ref. No.	33A2900
description	pilot burner bottom part SIT 100 series nozzle \varnothing 0.35mm		
For models:	030FT, 030FTR, 031FT, 031FTR, 031FTRL, 031TP, 070BM, 070D, 070DGG, 070FT, 070FTR, 0712D, 0712VA, 071BM, 071D, 071DGG, 071FT, 071FTR, 071FTRL, 071TP, 072D, 072DGG, 090, 090BM, 090FT, 090FTR, 090GG, 091, 091BM, 091FT, 091FTR, 091FTRL, 091GG, 091TP, 092, 092GG, 092VA, 092VAGG, 0A0BMG, 0A0FAS, 0A0FT1G, 0A0FT2G, 0A0FT4G, 0A0FT5G, 0A1FR1G, 0A1FR1GD, 0D0BMG, 0D0FAS, 0D0FT1G, 0D0FT2G...(Other models you can see in the webshop)		
spare parts for	107702		
	GEV No.	100246	Ref. No. 33T0410
	pilot burner nozzle natural gas bore \varnothing 0.35mm Qty 1 pcs thread M8x0.75		
	GEV No.	100916	Ref. No. —
	compression spring for pilot burner Qty 1 pcs		
	GEV No.	100917	Ref. No. —
	gasket for pilot burner Qty 1 pcs aluminium		
	GEV No.	100918	Ref. No. —
	screw for pilot burner		
accessories for	107702		
	GEV No.	100245	Ref. No. —
	pilot burner nozzle LPG code 20 bore \varnothing 0.2mm Qty 1 pcs thread M8x0.75		
	GEV No.	100904	Ref. No. —
	locking screw M10x1 for pipe \varnothing 4mm Qty 1 pcs		
	GEV No.	100905	Ref. No. —
	locking screw M10x1 for pipe \varnothing 6mm Qty 1 pcs		
	GEV No.	102110	Ref. No. —
	pilot tube copper pipe \varnothing 4mm thickness 1mm L 3000mm		
	GEV No.	102111	Ref. No. —
	pilot tube copper pipe \varnothing 6mm thickness 1mm L 3000mm		
	GEV No.	102742	Ref. No. —
	pilot burner nozzle LPG code 25 bore \varnothing 0.25mm Qty 1 pcs		

 <p>1</p>			
GEV No.	100880	Ref. No.	33A0690
description	pilot burner bottom part SIT 100 series nozzle \varnothing 0.4mm		

pilot burner brackets			
universal			
 <p>1</p>			
GEV No.	100887	Ref. No.	33A0950
description	opposite support for pilot burner suitable for 100 series		
For models:	030, 030FT, 030FTR, 031, 031FT, 031FTR, 031FTRL, 031TP, 032, 06WCP1GM, 06WFR3GD, 070BM, 070D, 070DGG, 070FT, 070FT04, 070FT05, 070FTR, 0712D, 0712VA, 071BM, 071D, 071DGG, 071FT, 071FT04, 071FT06, 071FTR, 071FTRL, 071TP, 072D, 072DGG, 08WCP1GM, 08WFA4G, 08WFAAG, 08WFT1GV, 08WFT2GV, 08WFT3GV, 08WFT4GV, 08WFT6GV, 08WFT7GV, 090, 090BM, 090BM1G, 090FAVA, 090FT, 090FT04, 090FT05, 090FT1G...(Other models you can see in the webshop)		

 <p>1</p>			
GEV No.	100894	Ref. No.	33A1100
description	opposite support for pilot burner suitable for 100 series		

 <p>1</p>			
GEV No.	100886	Ref. No.	33A1000
description	pilot burner bracket suitable for 100 series 3-piece		
For models:	030FT, 030FTR, 031FT, 031FTR, 031FTRL, 070BM, 070FT, 070FTR, 0712VA, 071BM, 071FT, 071FTR, 071FTRL, 071TP, 08WFA4G, 08WFAAG, 08WFT1GV, 08WFT2GV, 08WFT3GV, 08WFT4GV, 08WFT6GV, 08WFT7GV, 090BM, 090FAVA, 090FT, 090FTR, 091BM, 091FT, 091FTR, 091FTRL, 091TP, 092VA, 092VAGG, 0A0FAVA, 0D0FAVA, 10WTPGE, 10WTPGV, 12WFA6G, 12WFAAG, 190FAB, 190TPO, 191BR1G, 191BR1GA, 191BR2G, 191BR2GA, 191FAAG, 191FABG, 191FADG, 191TPG, 1A0FA2...(Other models you can see in the webshop)		

 <p>1</p>			
GEV No.	100855	Ref. No.	33S0950
description	pilot burner bracket triple		
accessories for	100855		
	GEV No.	100855	Ref. No. 33S0950
	pilot burner bracket triple		
	GEV No.	100886	Ref. No. 33A1000
	pilot burner bracket suitable for 100 series 3-piece		
	GEV No.	100888	Ref. No. 33A0980
	screw bolt for pilot burner		





			
1			
GEV No.	100888	Ref. No.	33A0980
description	screw bolt for pilot burner		
For models:	030FT, 030FTR, 031FT, 031FTR, 031FTRL, 070BM, 070FT, 070FT04, 070FT05, 070FTR, 0712VA, 071BM, 071FT, 071FT04, 071FT06, 071FTR, 071FTRL, 071TP, 090BM, 090FT, 090FTR, 091BM, 091FT, 091FTR, 091FTRL, 091TP, 30F, 30FS, 31, 31PD6, 31PI6, 31R, 31TC, 31TP, 32, 32TC, 32TP, 32TPV, 32V, 60SM, 70F, 712D, 712VA, 71AR, 71D, 71DGG, 71F, 71PD10, 71PD15, 71PI10...(Other models you can see in the webshop)		

producer-specific

			
1			
GEV No.	100168	Ref. No.	35V9130
description	pilot burner bracket SIT type 100 series		
For models:	030, 031, 031TP, 032, 070D, 070DGG, 0712D, 0712VA, 071D, 071DGG, 072D, 072DGG, 090, 090GG, 091, 091GG, 092, 092GG, 092VA, 092VAGG, 0A0FAS, 0B0FAS, 0D0FAS, 1A0FAS, 1A0FAS2, 1A1FAS2G, 1A1FASG, 1B0FAS, 1B0FAS2, 1B1FAS2G, 1B1FASG, 1D0FAS, 1D0FAS2, 1D1FAS2G, 1D1FASG, 2A0FAS2, 2A1FAS2G, 2A1FASG, 2A1TPSG, 2D0FAS2, 2D1FAS2G, 2D1FASG, 2D1TPSG, 31, 31GE, 31TC, 31TP, 32, 32TC, 32TP...(Other models you can see in the webshop)		

			
1			
GEV No.	100169	Ref. No.	35S0690 35V9140
description	pilot burner bracket SIT type 100 series		
For models:	070D, 070DGG, 0712D, 0712VA, 071D, 071DGG, 072D, 072DGG, 090, 090GG, 091, 091GG, 092, 092GG, 092VA, 092VAGG, 0A0FAS, 0B0FAS, 0D0FAS, 1A0FAS, 1A0FAS2, 1A1FAS2G, 1A1FASG, 1B0FAS, 1B0FAS2, 1B1FAS2G, 1B1FASG, 1D0FAS, 1D0FAS2, 1D1FAS2G, 1D1FASG, 2A0FAS2, 2A1FAS2G, 2A1FASG, 2A1TPSG, 2D0FAS2, 2D1FAS2G, 2D1FASG, 2D1TPSG, 3A1FASG, 3D1FASG, 712D, 712VA, 71D, 71DGG, 71GE, 71GEGG, 72D, 72DGG, 72TP...(Other models you can see in the webshop)		

			
1			
GEV No.	100184	Ref. No.	35V2570
description	pilot burner bracket SIT type 100 series		
For models:	031FT04, 031FT06, 070FT04, 070FT05, 071FT04, 071FT06, 090FT04, 090FT05, 090FT1G, 090FT2G, 090FT4G, 090FT5G, 090FT7G, 091FT04, 091FT06, 0A0FT1G, 0A0FT2G, 0A0FT4G, 0A0FT5G, 0B0FT1G, 0B0FT2G, 0B0FT4G, 0B0FT5G, 0D0FT1G, 0D0FT2G, 0D0FT4G, 0D0FT5G, 0G0FT1G, 0G0FT1G-VERS.032008, 0G0FT2G, 0G0FT2G-VERS.032008, 0G0FT4G, 0G0FT4G-VERS.032008, 0G0FT5G, 0G0FT5G-VERS.032008, 0G0FT7G, 190FT15G, 190FT1G, 190FT2G, 190FT3G, 190FT42G, 190FT4G, 190FT6G, 190FT72G, 190FT7G, 1A0FT1G, 1A0FT2G, 1A0FT3G, 1A0FT4G, 1A0FT6G...(Other models you can see in the webshop)		

			
1			
GEV No.	100185	Ref. No.	35S5080
description	pilot burner bracket SIT type 100 series		
For models:	30CPS, 30F1, 30F1B, 30FS2, 30FS2B, 70CP, 70F1, 70F1B, 71CP, 71CP2, 71F2, 71F2B, 90CP, 90F110B, 91CP, 91F210, 91F210B, 91F223B		

			
1			
GEV No.	100188	Ref. No.	35R3540
description	pilot burner bracket SIT type 100 series		
For models:	0A1FR1G, 0A1FR1GD, 0B1FR1G, 0B1FR1GD, 0D1FR1G, 0D1FR1GD, 1A1FR2G, 1A1FR2GD, 1D1FR2G, 1D1FR2GD		

			
1			
GEV No.	100812	Ref. No.	35R0100
description	pilot burner bracket suitable for 100 series		
For models:	71PD10, 71PD15, 71PI10, 71PI10A, 91PI10, 91PI10A		

			
1			
GEV No.	100850	Ref. No.	35R1460
description	pilot burner bracket suitable for 100 series		
For models:	06WCP1GM, 08WCP1GM, 090BM1G, 091CP1G, 0A0BMG, 0D0BMG, 0G0FR5G, 0G1CP1G, 0G1CP1G-VERS.2004, 190BM2G, 191CP2G, 191PD2G, 191PI1G, 191PI1GA, 191PI2G, 191PI2GA, 1A0BMG, 1D0B-MG, 1G0FR6G, 1G0TP0, 1G1CP1G, 1G1CP1G-VERS.2004, 1G1CP2G, 1G1CP2G-VERS.2004, 1G1FA0G, 1G1FAPG, 1G1TP0G, 2G1FA0G, 2G1FADG, 2G1FADGV, 2G1FAPG, 2G1TP3G, G1FAGS, G1FAGST		

			
1			
GEV No.	102968	Ref. No.	35S0090
description	pilot burner bracket suitable for 100 series		



pilot burner nozzles			
			
GEV No.	100246	Ref. No.	33T0410
description	pilot burner nozzle natural gas bore ø 0.35mm Qty 1 pcs thread M8x0.75		

			
GEV No.	102972	Ref. No.	33T3130
description	pilot burner nozzle natural gas code 40 bore ø 0.4mm Qty 1 pcs		

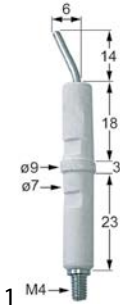
ignition electrodes			
			
GEV No.	100706	Ref. No.	32T0320
description	ignition electrode connection M4 Qty 1 pcs		
For models:	191CP1GA, 1A1CP1GA, 1A1PI2G, 1A1PI2GA, 1D1CP1GA, 1D1PI2G, 1D1PI2GA, 291PD3G, 291PI3G, 2A1PD3G, 2A1PI3G, 2D1PI3G		

			
GEV No.	100707	Ref. No.	3232960
description	ignition electrode D1 ø 7mm D2 ø 9mm connection ø2.4mm L1 14mm L2 6mm BL1 18mm BL2 3mm BL3 23mm to clip Qty 1 pcs		
For models:	06WCP1GM, 08WCP1GM, 08WFA4G, 08WFAAG, 090BM1G, 090FAVA, 090FT1G, 090FT2G, 090FT4G, 090FT5G, 090FT7G, 091CP1G, 091FR1G, 091FR1GD, 091FR3G, 091FR3GD, 0G0FT1G-VERS.032008, 0G0FT2G-VERS.032008, 0G0FT4G-VERS.032008, 0G0FT5G-VERS.032008, 0G0FT7G, 0G1CP1G-VERS.2004, 0G1FR3G, 0G1FR3GD, 0G1FR7G, 10WTPGE, 10WTPGV, 12WFA6G, 12WFAAG, 190BM2G, 190FAB, 190FT15G, 190FT1G, 190FT2G, 190FT3G, 190FT42G, 190FT4G, 190FT6G, 190FT72G, 190FT7G, 190TP0, 191BR1G, 191BR1GA, 191BR2G, 191BR2GA, 191CP2G, 191FAAG, 191FABG, 191FADG, 191FR2G...(Other models you can see in the webshop)		

miscellaneous			
			
GEV No.	100885	Ref. No.	33A0970
description	air mixing sleeve for pilot burner Qty 1 pcs		
For models:	030, 030FT, 030FTR, 031, 031FT, 031FT04, 031FT06, 031FTR, 031FTRL, 031TP, 032, 06WCP1GM, 06WFR3GD, 070BM, 070D, 070DGG, 070FT, 070FT04, 070FT05, 070FTR, 0712D, 0712VA, 071BM, 071D, 071DGG, 071FT, 071FT04, 071FT06, 071FTR, 071FTRL, 071TP, 072D, 072DGG, 08WCP1GM, 08WFA4G, 08WFAAG, 08WFT1GV, 08WFT2GV, 08WFT-3GV, 08WFT4GV, 08WFT6GV, 08WFT7GV, 090, 090BM, 090BM1G, 090FAVA, 090FT, 090FT04, 090FT05, 090FT1G...(Other models you can see in the webshop)		

























160 series			
			
GEV No.	100109	Ref. No.	33A1630
description	pilot burner SIT type 160 series 1 flame nozzle ømm gas connectionmm		
For models:	08WGRGV, 090GRG, 0A0GRG, 0D0GRG, 190GRG, 1A0GRG, 1D0GRG, 1G0GRG, 6042120-08WGRGV		
spare parts for	100109		
		GEV No.	100907
		Ref. No.	—
	screw connection thread M10x1 Qty 1 pcs type SEF 1 ømm for thermocouple		
accessories for	100109		
		GEV No.	100202
		Ref. No.	—
	pilot burner nozzle natural gas code 41 Qty 1 pcs nozzle ø 0.41mm		
		GEV No.	100203
		Ref. No.	—
	pilot burner nozzle LPG code 25 Qty 1 pcs nozzle ø 0.25mm		
		GEV No.	100701
		Ref. No.	32T0190
	ignition electrode connection M4 Qty 1 pcs		
		GEV No.	100801
		Ref. No.	—
	gasket for pilot burner Qty 1 pcs		
		GEV No.	100869
		Ref. No.	—
	pilot burner nozzle natural gas code 51 Qty 1 pcs suitable for 160 series nozzle ø 0.51mm		
		GEV No.	100906
		Ref. No.	36Q1050
	screw connection thread M10x1 for ignition electrode brass Qty 1 pcs WS 10		
		GEV No.	100908
		Ref. No.	36Q1000
	union screw thread M10x1 for pipe ø 4mm Qty 1 pcs		
		GEV No.	100909
		Ref. No.	36Q0060
	union screw thread M10x1 for pipe ø 6mm Qty 1 pcs		
		GEV No.	101282
		Ref. No.	—
	olive for pipe ø 4mm L 7.4mm Qty 1 pcs		
		GEV No.	101287
		Ref. No.	36Q0150
	olive for pipe ø 6mm Qty 1 pcs		















Table continues overleaf

















accessories for	100109			
	GEV No.	102110	Ref. No.	—
	pilot tube copper pipe ø 4mm thickness 1mm L 3000mm			
	GEV No.	102111	Ref. No.	—
	pilot tube copper pipe ø 6mm thickness 1mm L 3000mm			
	GEV No.	107650	Ref. No.	33T3310
	pilot burner nozzle SIT LPG code 30 Qty 1 pcs			

	1			
GEV No.	100053	Ref. No.	33A0750	
description	pilot burner SIT type 160 series 2 flames nozzle ømm gas connectionmm			
For models:	1A1PD1G, 1A1PD2G, 1A1PI1G, 1A1PI1GA, 1D1PD1G, 1D1PD2G, 1D1PI1G, 1D1PI1GA			
spare parts for	100053			
	GEV No.	100907	Ref. No.	—
	screw connection thread M10x1 Qty 1 pcs type SEF 1 ømm for thermocouple			
accessories for	100053			
	GEV No.	100202	Ref. No.	—
	pilot burner nozzle natural gas code 41 Qty 1 pcs nozzle ø 0.41mm			
	GEV No.	100203	Ref. No.	—
	pilot burner nozzle LPG code 25 Qty 1 pcs nozzle ø 0.25mm			
	GEV No.	100701	Ref. No.	32T0190
	ignition electrode connection M4 Qty 1 pcs			
	GEV No.	100801	Ref. No.	—
	gasket for pilot burner Qty 1 pcs			
	GEV No.	100869	Ref. No.	—
	pilot burner nozzle natural gas code 51 Qty 1 pcs suitable for 160 series nozzle ø 0.51mm			
	GEV No.	100906	Ref. No.	36Q1050
	screw connection thread M10x1 for ignition electrode brass Qty 1 pcs WS 10			
	GEV No.	100908	Ref. No.	36Q1000
	union screw thread M10x1 for pipe ø 4mm Qty 1 pcs			
	GEV No.	100909	Ref. No.	36Q0060
	union screw thread M10x1 for pipe ø 6mm Qty 1 pcs			
	GEV No.	101282	Ref. No.	—
	olive for pipe ø 4mm L 7.4mm Qty 1 pcs			
	GEV No.	101287	Ref. No.	36Q0150
	olive for pipe ø 6mm Qty 1 pcs			
	GEV No.	102110	Ref. No.	—
	pilot tube copper pipe ø 4mm thickness 1mm L 3000mm			
	GEV No.	102111	Ref. No.	—
	pilot tube copper pipe ø 6mm thickness 1mm L 3000mm			

accessories for	100053			
	GEV No.	107650	Ref. No.	33T3310
	pilot burner nozzle SIT LPG code 30 Qty 1 pcs			

	1			
GEV No.	100054	Ref. No.	33A0880	
description	pilot burner SIT type 160 series 2 flames nozzle ømm gas connectionmm			
For models:	0A1CP1G, 0B1CP1G, 0D1CP1G, 191CP1G, 1A1CP1G, 1A1CP2G, 1D1CP1G, 1D1CP2G			
spare parts for	100054			
	GEV No.	100907	Ref. No.	—
	screw connection thread M10x1 Qty 1 pcs type SEF 1 ømm for thermocouple			
accessories for	100054			
	GEV No.	100202	Ref. No.	—
	pilot burner nozzle natural gas code 41 Qty 1 pcs nozzle ø 0.41mm			
	GEV No.	100203	Ref. No.	—
	pilot burner nozzle LPG code 25 Qty 1 pcs nozzle ø 0.25mm			
	GEV No.	100701	Ref. No.	32T0190
	ignition electrode connection M4 Qty 1 pcs			
	GEV No.	100801	Ref. No.	—
	gasket for pilot burner Qty 1 pcs			
	GEV No.	100869	Ref. No.	—
	pilot burner nozzle natural gas code 51 Qty 1 pcs suitable for 160 series nozzle ø 0.51mm			
	GEV No.	100906	Ref. No.	36Q1050
	screw connection thread M10x1 for ignition electrode brass Qty 1 pcs WS 10			
	GEV No.	100908	Ref. No.	36Q1000
	union screw thread M10x1 for pipe ø 4mm Qty 1 pcs			
	GEV No.	100909	Ref. No.	36Q0060
	union screw thread M10x1 for pipe ø 6mm Qty 1 pcs			
	GEV No.	101282	Ref. No.	—
	olive for pipe ø 4mm L 7.4mm Qty 1 pcs			
	GEV No.	101287	Ref. No.	36Q0150
	olive for pipe ø 6mm Qty 1 pcs			
	GEV No.	102110	Ref. No.	—
	pilot tube copper pipe ø 4mm thickness 1mm L 3000mm			
	GEV No.	102111	Ref. No.	—
	pilot tube copper pipe ø 6mm thickness 1mm L 3000mm			
	GEV No.	107650	Ref. No.	33T3310
	pilot burner nozzle SIT LPG code 30 Qty 1 pcs			



JUNKERS				
CB 503 series				
pilot burners				
				
GEV No.	100058	Ref. No.	33A0470	
description	pilot burner JUNKERS type CB503006 natural gas nozzle no.26 gas connection 4mm			
spare parts for	100058			
	GEV No.	100224	Ref. No.	33T0560
	pilot burner nozzle natural gas gas pressure 25mbar code 26 Qty 1 pcs suitable for JUNKERS CB503_			
	GEV No.	101281	Ref. No.	—
	olive for pipe ø 4mm L 8.7mm Qty 1 pcs suitable for CB 502/503			
	GEV No.	101283	Ref. No.	—
	union screw thread M10x1 for pipe ø 4mm Qty 1 pcs			
accessories for	100058			
	GEV No.	100220	Ref. No.	33T0540
	pilot burner nozzle LPG gas pressure 50mbar code 2 Qty 1 pcs suitable for JUNKERS CB503_			
	GEV No.	100221	Ref. No.	—
	pilot burner nozzle LPG gas pressure 30mbar code 29 Qty 1 pcs suitable for JUNKERS CB50203_			
	GEV No.	100222	Ref. No.	—
	pilot burner nozzle LPG gas pressure 50mbar code 5 Qty 1 pcs suitable for JUNKERS CB50203_			
	GEV No.	100223	Ref. No.	—
	pilot burner nozzle natural gas gas pressure 20mbar code 3 Qty 1 pcs suitable for JUNKERS CB503_			
	GEV No.	100226	Ref. No.	—
	pilot burner nozzle LPG gas pressure 50mbar code 15 suitable for JUNKERS			
	GEV No.	100227	Ref. No.	—
	pilot burner nozzle natural gas gas pressure 25mbar code 6 Qty 1 pcs suitable for JUNKERS CB50203_			
	GEV No.	100228	Ref. No.	—
	pilot burner nozzle town gas gas pressure 8mbar code 4 Qty 1 pcs suitable for JUNKERS CB50203_			
	GEV No.	100909	Ref. No.	36Q0060
	union screw thread M10x1 for pipe ø 6mm Qty 1 pcs			
	GEV No.	101287	Ref. No.	36Q0150
	olive for pipe ø 6mm Qty 1 pcs			
	GEV No.	102110	Ref. No.	—
	pilot tube copper pipe ø 4mm thickness 1mm L 3000mm			
	GEV No.	102111	Ref. No.	—
	pilot tube copper pipe ø 6mm thickness 1mm L 3000mm			











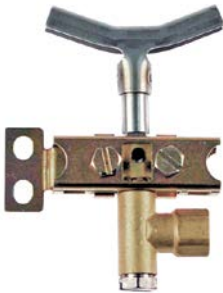



producer-specific pilot burners				
ANGELO PO				
Junior / Senior series				
				
GEV No.	100187	Ref. No.	6000280	
description	pilot burner SIT type 100 series 3 flames nozzle ø 0.25mm gas connectionmm			
For models:	30F, 30FS, 70F, 71F			
spare parts for	100187			
	GEV No.	100835	Ref. No.	32Z2241
	pilot burner cap 3 flames suitable for 100 series H 35mm L 48mm Qty 1 pcs W 52mm			
	GEV No.	100855	Ref. No.	33S0950
	pilot burner bracket triple			
	GEV No.	100882	Ref. No.	—
	pilot burner bottom part PRO-GAS 100 series nozzle ø 0.25mm			
	GEV No.	100885	Ref. No.	33A0970
	air mixing sleeve for pilot burner Qty 1 pcs			
	GEV No.	100916	Ref. No.	—
	compression spring for pilot burner Qty 1 pcs			
	GEV No.	100917	Ref. No.	—
	gasket for pilot burner Qty 1 pcs aluminium			
	GEV No.	100918	Ref. No.	—
	screw for pilot burner			
	GEV No.	102742	Ref. No.	—
	pilot burner nozzle LPG code 25 bore ø 0.25mm Qty 1 pcs			
accessories for	100187			
	GEV No.	100245	Ref. No.	—
	pilot burner nozzle LPG code 20 bore ø 0.2mm Qty 1 pcs thread M8x0.75			
	GEV No.	100246	Ref. No.	33T0410
	pilot burner nozzle natural gas bore ø 0.35mm Qty 1 pcs thread M8x0.75			
	GEV No.	100881	Ref. No.	—
	pilot burner bottom part PRO-GAS 100 series nozzle ø 0.2mm			
	GEV No.	100883	Ref. No.	—
	pilot burner bottom part PRO-GAS 100 series nozzle ø 0.35mm			
	GEV No.	100904	Ref. No.	—
	locking screw M10x1 for pipe ø 4mm Qty 1 pcs			

Table continues overleaf





accessories for	100187			
	GEV No.	100905	Ref. No.	—
	locking screw M10x1 for pipe ø 6mm Qty 1 pcs			





Combi / Major series



GEV No.	100065	Ref. No.	6000170	
description	pilot burner 1 flame gas connectionmm without nozzle			
spare parts for	100065			
	GEV No.	100831	Ref. No.	—
	pilot burner head Qty 1 pcs			
accessories for	100065			
	GEV No.	100240	Ref. No.	33T0240
	pilot burner nozzle LPG code 39 gas pressure 30mbar brass			
	GEV No.	100241	Ref. No.	33T0050
	pilot burner nozzle natural gas code 13 gas pressure 25mbar bore ø 0.4mm Qty 1 pcs brass			
	GEV No.	100909	Ref. No.	36Q0060
	union screw thread M10x1 for pipe ø 6mm Qty 1 pcs			
	GEV No.	101282	Ref. No.	—
	olive for pipe ø 4mm L 7.4mm Qty 1 pcs			
	GEV No.	101283	Ref. No.	—
	union screw thread M10x1 for pipe ø 4mm Qty 1 pcs			
	GEV No.	101288	Ref. No.	—
	olive for pipe ø 6mm L 6mm aluminium Qty 1 pcs ED ø 8.5mm			





GEV No.	101777	Ref. No.	34A0010	
description	pilot burner gas connectionmm without nozzle			
accessories for	101777			
	GEV No.	100240	Ref. No.	33T0240
	pilot burner nozzle LPG code 39 gas pressure 30mbar brass			
	GEV No.	100241	Ref. No.	33T0050
	pilot burner nozzle natural gas code 13 gas pressure 25mbar bore ø 0.4mm Qty 1 pcs brass			

accessories for	101777			
	GEV No.	100831	Ref. No.	—
	pilot burner head Qty 1 pcs			
	GEV No.	100909	Ref. No.	36Q0060
	union screw thread M10x1 for pipe ø 6mm Qty 1 pcs			
	GEV No.	101282	Ref. No.	—
	olive for pipe ø 4mm L 7.4mm Qty 1 pcs			
	GEV No.	101283	Ref. No.	—
	union screw thread M10x1 for pipe ø 4mm Qty 1 pcs			
	GEV No.	101288	Ref. No.	—
	olive for pipe ø 6mm L 6mm aluminium Qty 1 pcs ED ø 8.5mm			

new series



GEV No.	107541	Ref. No.	N/A	
description	pilot burner 2 flames gas connection 4/6mm without nozzle			
accessories for	107541			
	GEV No.	100240	Ref. No.	33T0240
	pilot burner nozzle LPG code 39 gas pressure 30mbar brass			
	GEV No.	100241	Ref. No.	33T0050
	pilot burner nozzle natural gas code 13 gas pressure 25mbar bore ø 0.4mm Qty 1 pcs brass			

miscellaneous



GEV No.	104299	Ref. No.	3060930	
description	pilot burner			
For models:	190FA, 190FAD, 191FADG, 191FAE, 191FAG, 290FA, 291FAG, 291FAGF, 391FAG			



electrodes

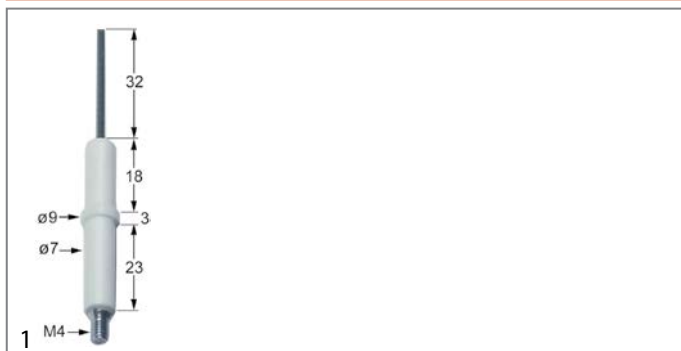

GEV No.	100701	Ref. No.	32T0190
description	ignition electrode connection M4 Qty 1 pcs		
For models:	08WGRGV, 090GRG, 0A0GRG, 0A1CP1G, 0B1CP1G, 0D0GRG, 0D1CP1G, 190GRG, 191CP1G, 1A0GRG, 1A1CP1G, 1A1CP2G, 1A1PD1G, 1A1PD2G, 1A1PI1G, 1A1PI1GA, 1D0GRG, 1D1CP1G, 1D1CP2G, 1D1PD1G, 1D1PD2G, 1D1PI1G, 1D1PI1GA, 1G0GRG, 6042120-08WGRGV		
accessories for	100701		
		GEV No.	100906
		Ref. No.	36Q1050
	screw connection thread M10x1 for ignition electrode brass Qty 1 pcs WS 10		

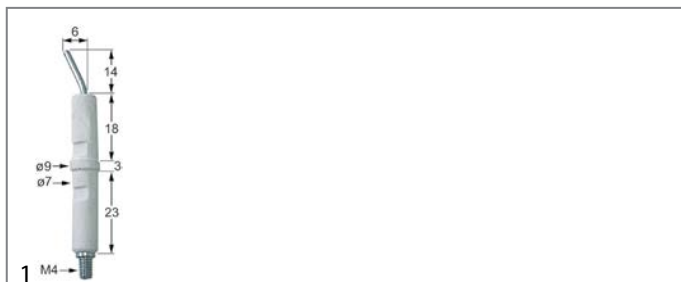

GEV No.	100706	Ref. No.	32T0320
description	ignition electrode connection M4 Qty 1 pcs		
For models:	191CP1GA, 1A1CP1GA, 1A1PI2G, 1A1PI2GA, 1D1CP1GA, 1D1PI2G, 1D1PI2GA, 291PD3G, 291PI3G, 2A1PD3G, 2A1PI3G, 2D1PI3G		

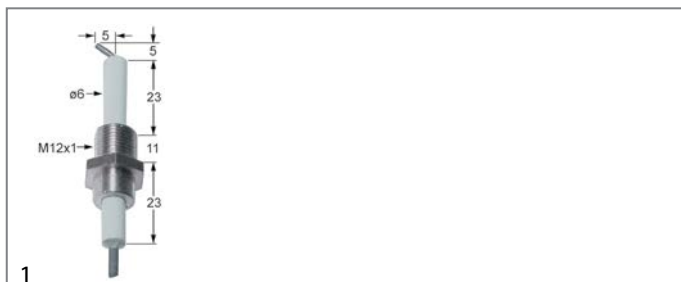

GEV No.	100712	Ref. No.	32T0080
description	ignition electrode D1 ø 6mm L1 5mm L2 5mm BL1 23mm BL2 11mm BL3 23mm connection F 2.8x0.8mm M12x1		

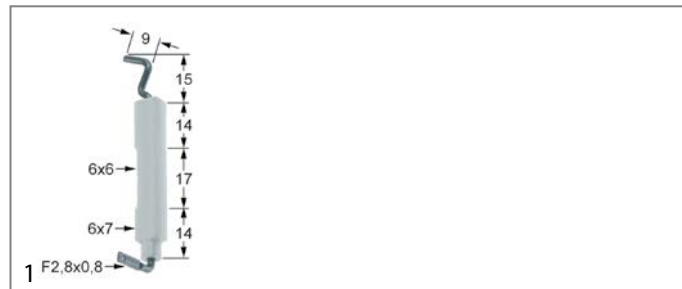

GEV No.	100736	Ref. No.	32T0141 32T0142
description	ignition electrode D1 ø 6x7mm connection F 2.8x0.8mm BL1 14mm BL2 16mm BL3 14mm		
For models:	030FT, 030FTR, 031FT, 031FT04, 031FT06, 031FTR, 031FTRL, 031TP, 06WCP1GM, 06WFR3GD, 070BM, 070FT, 070FT04, 070FT05, 070FTR, 0712VA, 071BM, 071FT, 071FT04, 071FT06, 071FTR, 071FTRL, 071TP, 08WCP1GM, 08WFAAG, 08WFT1GV, 08WFT2GV, 08WFT3GV, 08WFT4GV, 08WFT6GV, 08WFT7GV, 090BM, 090FAVA, 090FT, 090FT04, 090FT05, 090FT1G, 090FT2G, 090FT4G, 090FT5G, 090FT7G, 090FTR, 091BM, 091CP1G, 091FR1G, 091FR1GD, 091FR3G, 091FR3GD, 091FT, 091FT04...(Other models you can see in the webshop)		



GEV No.	100798	Ref. No.	32T0010 32T0060
description	ignition electrode D1 ø 6x7mm connection F 2.8x0.8mm D2 ø 6x6mm L1 15mm L2 10mm BL1 14mm BL2 17mm BL3 14mm to clip		
For models:	030FT, 030FTR, 031FT, 031FT04, 031FT06, 031FTR, 031FTRL, 031TP, 06WCP1GM, 06WFR3GD, 070BM, 070FT, 070FT04, 070FT05, 070FTR, 0712VA, 071BM, 071FT, 071FT04, 071FT06, 071FTR, 071FTRL, 071TP, 08WCP1GM, 08WFA4G, 08WFAAG, 08WFT1GV, 08WFT2GV, 08WFT3GV, 08WFT4GV, 08WFT6GV, 08WFT7GV, 090BM, 090BM1G, 090FAVA, 090FT, 090FT04, 090FT05, 090FT1G, 090FT2G, 090FT4G, 090FT5G, 090FT7G, 090FTR, 091BM, 091CP1G, 091FR1G, 091FR1GD, 091FR3G, 091FR3GD...(Other models you can see in the webshop)		

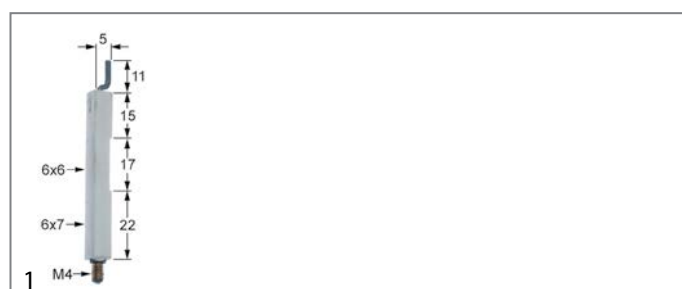

GEV No.	100708	Ref. No.	32T0140
description	ignition electrode D1 ø 6x7mm connection M4 D2 ø 6x6mm L1 11mm L2 5mm BL1 15mm BL2 16mm BL3 23mm		
For models:	71AR, 91AR, FS30		

1 gas components

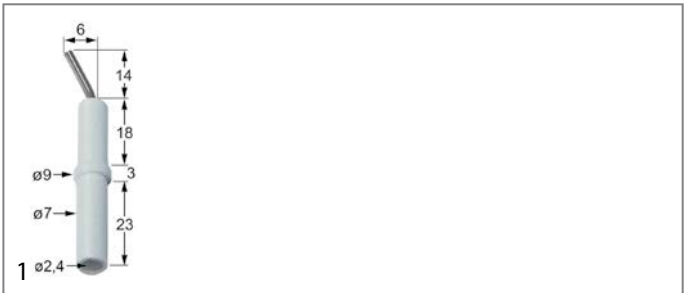

GEV No.	100707	Ref. No.	3232960
description	ignition electrode D1 ø 7mm D2 ø 9mm connection ø2.4mm L1 14mm L2 6mm BL1 18mm BL2 3mm BL3 23mm to clip Qty 1 pcs		
For models:	06WCP1GM, 08WCP1GM, 08WFA4G, 08WFAAG, 090BM1G, 090FAVA, 090FT1G, 090FT2G, 090FT4G, 090FT5G, 090FT7G, 091CP1G, 091FR1G, 091FR1GD, 091FR3G, 091FR3GD, 0G0FT1G-VERS.032008, 0G0FT2G-VERS.032008, 0G0FT4G-VERS.032008, 0G0FT5G-VERS.032008, 0G0FT7G, 0G1CP1G-VERS.2004, 0G1FR3G, 0G1FR3GD, 0G1FR7G, 10WTPGE, 10WTPGV, 12WFA6G, 12WFAAG, 190BM2G, 190FAB, 190FT15G, 190FT1G, 190FT2G, 190FT3G, 190FT42G, 190FT4G, 190FT6G, 190FT72G, 190FT7G, 190TP0, 191BR1G, 191BR1GA, 191BR2G, 191BR2GA, 191CP2G, 191FAAG, 191FABG, 191FADG, 191FR2G...(Other models you can see in the webshop)		

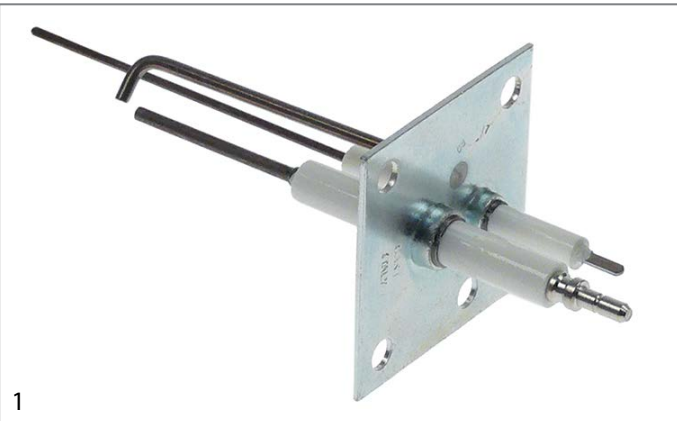

GEV No.	104800	Ref. No.	32V4670
description	ignition electrode flange length 55mm flange width 55mm D1 ø 9mm D2 ø 7mm L1 119mm L2 145mm BL1 60mm BL2 55mm		



GEV No.	106743	Ref. No.	6300568
description	ignition electrode flange length 55mm flange width 55mm D1 ø 9.3mm D2 ø 5.85mm L1 80mm BL1 80mm BL2 33.5mm BL3 29.5mm BL4 24.5mm with fixing flange with mounting material connection ø 4mm		
For models:	FC1221G, FM1221G1, FM1221G1-VERS.2006, FM1221G2, FM1221G2-VERS.2006, FM1221G3, FM1221G3-VERS.2006, FM2021G1, FM2021G2, FM2021G2-VERS.2006, FM2021G3, FM2021G3-VERS.2006, FM721G1, FM721G1-VERS.2006, FM721G2, FM721G2-VERS.2006, FM721G3, FM721G3-VERS.2006		



GEV No.	104683	Ref. No.	3106670 3106671
description	ignition electrode flange length 56mm flange width 22mm		
For models:	091FR11, 091FR11A, 091FR11D, 091FR11D-VERS.052012, 091FR11-VERS.032012, 091FR7G, 091FR7GX, 191FR21, 191FR21D, 191FR21D-VERS.092012, 191FR21-VERS.032012		



GEV No.	104801	Ref. No.	6300567
description	ignition electrode flange length 55mm flange width 55mm D1 ø 9mm D2 ø 7mm L1 118mm L2 145mm BL1 77mm BL2 65mm		
For models:	FC1011G, FC611G, FM1011G1, FM1011G1-VERS.2006, FM1011G2, FM1011G2-VERS.2006, FM1011G3, FM1011G3-VERS.2006, FM2011G2-VERS.2006, FM2011G3-VERS.2006, FM611G1, FM611G1-VERS.2006, FM611G2, FM611G2-VERS.2006, FM611G3, FM611G3-VERS.2006		



GEV No.	104799	Ref. No.	6300747
description	ignition electrode flange length 56mm flange width 22mm D1 ø 9x62mm D2 ø 9x62mm L1 130mm L2 140mm		
For models:	BX122G, BX122G-VERS.122013, BX82G, BX82G-VERS.122013, FX122G1, FX122G2, FX122G2C, FX122G2T, FX122G2T-VERS.032014, FX122G3, FX122G3C, FX122G3T, FX122G3T-VERS.022014, FX12G3CT, FX12G3CT-VERS.022014, FX202G2, FX202G2-VERS.032014, FX202G3, FX202G3-VERS.022014, FX82G1, FX82G2, FX82G2C, FX82G2T, FX82G2T-VERS.032014, FX82G3, FX82G3C, FX82G3CT, FX82G3CT-VERS.022014, FX82G3T, FX82G3T-VERS.022014		



1			
GEV No.	103287	Ref. No.	6300746
description	ignition electrode kit flange length 56mm flange width 22mm D1 ø 3mm D2 ø 9.5mm mounting distance 47mm		
For models:	BX101G, BX101G-VERS.122013, BX61G, BX61G-VERS.122013, FX101G1, FX101G1R, FX101G2, FX101G2C, FX101G2C-VERS.032014, FX101G2R, FX101G2R-VERS.032014, FX101G2-VERS.032014, FX101G3, FX101G3C, FX101G3C-VERS.022014, FX101G3R, FX101G3R-VERS.022014, FX101G3-VERS.022014, FX10G2CR, FX10G2CR-VERS.032014, FX10G3CR, FX10G3CR-VERS.022014, FX201G2, FX201G2P, FX201G2P-VERS.032014, FX201G2-VERS.032014, FX201G3P, FX201G3-VERS.022014, FX61G1, FX61G1R, FX61G2, FX61G2C, FX61G2CR, FX61G2CR-VERS.032014, FX61G2C-VERS.032014, FX61G2R, FX61G2R-VERS.032014, FX61G2-VERS.032014, FX61G3, FX61G3C, FX61G3CR, FX61G3CR-VERS.022014, FX61G3C-VERS.022014, FX61G3R, FX61G3R-VERS.022014, FX61G3-VERS.022014		

1			
GEV No.	100906	Ref. No.	36Q1050
description	screw connection thread M10x1 for ignition electrode brass Qty 1 pcs WS 10		
For models:	08WGRGV, 090GRG, 0A0GRG, 0A1CP1G, 0B1CP1G, 0D0GRG, 0D1CP1G, 190GRG, 191CP1G, 1A0GRG, 1A1CP1G, 1A1CP2G, 1A1PD1G, 1A1PD2G, 1A1PI1G, 1A1PI1GA, 1D0GRG, 1D1CP1G, 1D1CP2G, 1D1PD1G, 1D1PD2G, 1D1PI1G, 1D1PI1GA, 1G0GRG, 6042120-08WGRGV		

ignition cables

pre-assembled cables

1			
GEV No.	100190	Ref. No.	32A0061 32A0390
description	ignition cable cable length 1200mm connection F2.8mm / F2.8mm		
For models:	06WFR3GD, 071TP, 08WFAAG, 08WFT1GV, 08WFT2GV, 08WFT3GV, 08WFT4GV, 08WFT6GV, 08WFT7GV, 090FAVA, 091FR1G, 091FR1GD, 091FR3G, 091FR3GD, 091TP, 0A1FR1G, 0A1FR1GD, 0A1FR1GD-VERS.2004, 0A1FR1G-VERS.2004, 0A1FR3G, 0A1FR3GD, 0B1FR1G, 0B1FR1GD, 0D1FR1G, 0D1FR1GD, 0D1FR1GD-VERS.2004, 0D1FR1G-VERS.2004, 0D1FR3G, 0D1FR3GD, 0G1FR3G, 0G1FR3GD, 10WFR4GD, 12WFAAG, 190FAB, 191BR1G, 191BR1GA, 191BR2G, 191BR2GA, 191CP1GA, 191FABG, 191FR2G, 191FR2GD, 191FR4G, 191FR4GD, 1A1BR1G, 1A1BR1GA, 1A1BR2G, 1A1BR2GA, 1A1CP1GA, 1A1FR2G... (Other models you can see in the webshop)		

1			
GEV No.	100179	Ref. No.	32A2540
description	ignition cable cable length 1200mm connection F2.8mm / ø2.4mm		
For models:	08WGRGV, 090GRG, 0A0BMG, 0A0FAVA, 0D0BMG, 0D0FAVA, 0G0FR5G, 0G1CP1G, 0G1CP1G-VERS.2004, 0G1FR7G, 190GRG, 191CP1G, 1A0BMG, 1A0FA2, 1A0FA5, 1A0FAB, 1A0FAS2, 1A0TP0, 1A1FA2G, 1A1FA5G, 1A1FABG, 1A1FAS2G, 1A1FASG, 1A1TP0G, 1A1TP0G-VERS.2002, 1B0FAS2, 1B0TP0, 1B1FAS2G, 1D0BMG, 1D0FA2, 1D0FA5, 1D0FAB, 1D0FAS2, 1D0TP0, 1D1FA2G, 1D1FA5G, 1D1FABG, 1D1FAS2G, 1D1FASG, 1D1TP0G, 1D1TP0G-VERS.2002, 1G0FR6G, 1G1CP1G, 1G1CP1G-VERS.2004, 1G1CP2G, 1G1CP2G-VERS.2004, 1G1FR8G, 2A0FAS2, 2A1FAS2G, 2A1FASG...(Other models you can see in the webshop)		

1			
GEV No.	102163	Ref. No.	32A3080
description	ignition cable cable length 1500mm connection F2.8mm / ø2.4mm		
For models:	08WFA4G, 12WFA6G, 190TP0, 191FAAG, 191FADG, 191FAG, 191PD2G, 191PI1G, 191PI1GA, 191PI2G, 191PI2GA, 191TPG, 1G1FA0G, 1G1FAPG, 1G1TP0G, 291FAG, 291TPCG, 2A1PI3G, 2D1PI3G, 2G1FA0G, 2G1FADG, 2G1FADGV, 2G1FAPG, 2G1TP3G, 391FAG		

1			
GEV No.	100189	Ref. No.	3059160 32A1640
description	ignition cable cable length 150mm connection F2.8mm / lug M4		
For models:	090FT1G, 090FT2G, 090FT4G, 090FT5G, 090FT7G, 090GRG, 091CP1G, 091FR1G, 091FR1GD, 091FR3G, 091FR3GD, 0A1FR1G, 0A1FR1GD, 0A1FR1GD-VERS.2004, 0A1FR1G-VERS.2004, 0A1FR3G, 0A1FR3GD, 0B1FR1G, 0B1FR1GD, 0D1FR1G, 0D1FR1GD, 0D1FR1GD-VERS.2004, 0D1FR1G-VERS.2004, 0D1FR3G, 0D1FR3GD, 0G1FR3G, 0G1FR3GD, 10WTPGE, 191BR1G, 191BR1GA, 191BR2G, 191BR2GA, 1A1BR1G, 1A1BR1GA, 1A1BR2G, 1A1BR2GA, 1D1BR1G, 1D1BR1GA, 1D1BR2G, 1D1BR2GA, 1G1FR4G, 1G1FR4GD, 291BR1G, 291BR1GA, 291BR2G, 291BR2GA, 2A1BR1G, 2A1BR1GA, 2A1BR2G, 2A1BR2GA...(Other models you can see in the webshop)		

1			
GEV No.	103353	Ref. No.	3113510
description	ignition cable cable length 350mm connection F2.8/F6.3		
For models:	FC1011G, FC611G, FM1011G1, FM1011G1-VERS.2006, FM1011G2, FM1011G2-VERS.2006, FM1011G3, FM1011G3-VERS.2006, FM2011G2-VERS.2006, FM2011G3-VERS.2006, FM611G1, FM611G1-VERS.2006, FM611G2, FM611G2-VERS.2006, FM611G3, FM611G3-VERS.2006, FM721G1, FM721G1-VERS.2006, FM721G2, FM721G2-VERS.2006, FM721G3, FM721G3-VERS.2006		

1			
GEV No.	100036	Ref. No.	32A0040 32A0050
description	ignition cable cable length 500mm connection F2.8mm / F2.8mm		

1			
GEV No.	103352	Ref. No.	3113490
description	ignition cable cable length 550mm connection F2.8mm / F6.3mm		
For models:	FM1221G1, FM1221G1-VERS.2006, FM1221G2, FM1221G2-VERS.2006, FM1221G3, FM1221G3-VERS.2006, FM2021G1, FM2021G2, FM2021G2-VERS.2006, FM2021G3, FM2021G3-VERS.2006, FM721G1, FM721G2, FM721G3, FX201G2, FX201G2P, FX201G2P-VERS.032014, FX201G2-VERS.032014, FX201G3P, FX201G3-VERS.022014, FX202G2, FX202G2-VERS.032014, FX202G3, FX202G3-VERS.022014		





			
GEV No.	102159	Ref. No.	32A0140
description	ignition cable cable length 600mm connection F2.8mm / F2.8mm		

			
GEV No.	100197	Ref. No.	32A0430
description	ignition cable cable length 600mm connection F2.8mm / ø2.4mm		
For models:	031FT04, 031FT06, 070FT04, 070FT05, 071FT04, 071FT06, 090FT04, 090FT05, 091FT04, 091FT06, 0A0FT1G, 0A0FT2G, 0A0FT4G, 0A0FT5G, 0B0FT1G, 0B0FT2G, 0B0FT4G, 0B0FT5G, 0D0FT1G, 0D0FT2G, 0D0FT4G, 0D0FT5G, 0G0FT1G, 0G0FT1G-VERS.032008, 0G0FT2G, 0G0FT2G-VERS.032008, 0G0FT4G, 0G0FT4G-VERS.032008, 0G0FT5G, 0G0FT5G-VERS.032008, 1A0FT1G, 1A0FT2G, 1A0FT3G, 1A0FT4G, 1A0FT6G, 1B0FT1G, 1B0FT2G, 1B0FT3G, 1B0FT4G, 1B0FT6G, 1D0FT1G, 1D0FT2G, 1D0FT3G, 1D0FT4G, 1D0FT6G, 1G0FT1G, 1G0FT1G-VERS.032008, 1G0FT2G, 1G0FT2G-VERS.032008, 1G0FT3G...(Other models you can see in the webshop)		

			
GEV No.	100025	Ref. No.	32A0051
description	ignition cable cable length 600mm connection ø4mm / F6.3mm		

			
GEV No.	107550	Ref. No.	3211850
description	ignition cable cable length 700mm connection ø4mm / F2.8mm with earthing cable		
For models:	091FR11, 091FR11A, 091FR11D, 091FR11D-VERS.052012, 091FR11-VERS.032012, 191FR21, 191FR21D, 191FR21D-VERS.092012, 191FR21-VERS.032012		

			
GEV No.	100037	Ref. No.	32A0010 32A0060 32A0210
description	ignition cable cable length 900mm connection F2.8mm / F2.8mm		
For models:	030FT, 030FTR, 031FT, 031FTR, 031FTRL, 031TP, 070BM, 070FT, 070FTR, 0712VA, 071BM, 071FT, 071FTR, 071FTRL, 090BM, 090BM1G, 090FT, 090FTR, 091BM, 091FT, 091FTR, 091FTRL, 092VA, 092VAGG, 135PVX, 190BM2G, 1G0TP0, 1G1TP0G, 2G1TP3G, 30CPS, 30F, 30FS, 31TP, 32TP, 32TPV, 70CP, 70F, 712D, 712VA, 71CP2, 71D, 71DGG, 71F, 71TP, 72D, 72DGG, 72TP, 72TPGG, 72VA, 72VAGG...(Other models you can see in the webshop)		

			
GEV No.	103307	Ref. No.	32A2541
description	ignition cable cable length 900mm connection F2.8mm / ø2.4mm		
For models:	06WCP1GM, 08WCP1GM, 08WGRGV, 090FAA, 090FT1G, 090FT2G, 090FT4G, 090FT5G, 090FT7G, 090GRG, 091CP1G, 0A0BMG, 0A0FAVA, 0D0BMG, 0D0FAVA, 0G0FR5G, 0G1CP1G, 0G1CP1G-VERS.2004, 0G1FR7G, 10WTPGV, 190FAA, 190FT15G, 190FT1G, 190FT2G, 190FT3G, 190FT42G, 190FT4G, 190FT6G, 190FT72G, 190FT7G, 190GRG, 191CP1G, 191CP2G, 1A0BMG, 1A0FA2, 1A0FA5, 1A0FAB, 1A0FAS2, 1A0TP0, 1A1FA2G, 1A1FA5G, 1A1FABG, 1A1FAS2G, 1A1FASG, 1A1TP0G, 1A1TP0G-VERS.2002, 1B0FAS2, 1B0TP0, 1B1FAS2G, 1D0BMG...(Other models you can see in the webshop)		



			
GEV No.	100016	Ref. No.	32A2550
description	ignition cable cable length 900mm connection ø2.4mm / ø2.4mm		
For models:	0A1CP1G, 0B1CP1G, 0D1CP1G, 0G1CP1G-VERS.2004, 0G1FR7G, 1A1CP1G, 1A1CP2G, 1A1PD1G, 1A1PD2G, 1A1PI1G, 1A1PI1GA, 1D1CP1G, 1D1CP2G, 1D1PD1G, 1D1PD2G, 1D1PI1G, 1D1PI1GA, 1G0FR6G, 1G1CP1G-VERS.2004, 1G1CP2G-VERS.2004, 1G1FR8G, 1G1PD1G, 1G1PI1G		

various			
			
GEV No.	102986	Ref. No.	32A1600
description	ignition cable 1000Ohm		
For models:	FCV101DM, FCV101DS, FCV141DM, FCV141DS, FCV241DM, FCV241DS, FCV241GDM, FCV241GDS, FCV401DM, FCV61DM, FCV61DS		





piezoelectric igniters

mounting diameter 18mm

			
GEV No.	100002	Ref. No.	32T0130
description	piezoelectric igniter body metal rotary mounting ø 18mm connection F2.8x0.8		
For models:	030FT, 030FTR, 031FT, 031FTR, 031FTRL, 031TP, 070BM, 070FT, 070FTR, 0712VA, 071BM, 071FT, 071FTR, 071FTRL, 071TP, 090BM, 090FT, 090FTR, 091BM, 091FT, 091FTR, 091FTRL, 091TP, 092VA, 092VAGG, 30CPS, 30F, 30FS, 31, 31PD6, 31PI6, 31R, 31TC, 31TP, 32, 32TC, 32TP, 32TPV, 32V, 60SM, 70CP, 70F, 712D, 712VA, 71CP, 71CP2, 71D, 71DGG, 71F, 71PD10...(Other models you can see in the webshop)		

			
GEV No.	100012	Ref. No.	32T0150
description	piezoelectric igniter body plastic blowing mounting ø 18mm connection ø2.4mm		
For models:	031FT04, 031FT06, 070FT04, 070FT05, 071FT04, 071FT06, 090FT04, 090FT05, 091FT04, 091FT06, 0A0BMG, 0A0FT1G, 0A0FT2G, 0A0FT4G, 0A0FT5G, 0A0GRG, 0A1CP1G, 0B0FT1G, 0B0FT2G, 0B0FT4G, 0B0FT5G, 0B1CP1G, 0D0BMG, 0D0FT1G, 0D0FT2G, 0D0FT4G, 0D0FT5G, 0D0GRG, 0D1CP1G, 0G0FT1G, 0G0FT2G, 0G0FT4G, 0G0FT5G, 0G1CP1G, 0M0FA1, 0M0FR1G, 0M0FT1G, 0M0FT2G, 0M0FT4G, 0M0FT5G, 0M0GL1G, 0M0GL2G, 1A0BMG, 1A0FA2, 1A0FA5, 1A0FAS2, 1A0FT1G, 1A0FT2G, 1A0FT3G, 1A0FT4G...(Other models you can see in the webshop)		
spare parts for	100012		
	GEV No.	101339	Ref. No. 37Q2100
cover cap for piezoelectric igniter			





 <p>1</p>			
GEV No.	100009	Ref. No.	3005580 3166990
description	piezoelectric igniter body plastic blowing mounting ø 18mm connection ø2.4mm front measurements 26mm M18x1.5		
For models:	031FT04, 031FT06, 070FT04, 070FT05, 071FT04, 071FT06, 090FT04, 090FT05, 091FT04, 091FT06, 0A0BMG, 0A0FAVA, 0A0FT1G, 0A0FT2G, 0A0FT4G, 0A0FT5G, 0A0GRG, 0A1CP1G, 0B0FT1G, 0B0FT2G, 0B0FT4G, 0B0FT5G, 0B1CP1G, 0D0BMG, 0D0FAVA, 0D0FT1G, 0D0FT2G, 0D0FT4G, 0D0FT5G, 0D0GRG, 0D1CP1G, 0G0FR5G, 0G0FT1G, 0G0FT1G-VERS.032008, 0G0FT2G, 0G0FT2G-VERS.032008, 0G0FT4G, 0G0FT4G-VERS.032008, 0G0FT5G, 0G0FT5G-VERS.032008, 0G0FT7G, 0G1BR3G, 0G1CP1G, 0G1CP1G-VERS.2004, 0G1FR7G, 0M0FA1, 0M0FR1G, 0M0FT1G, 0M0FT2G, 0M0FT4G...(Other models you can see in the webshop)		
accessories for	100009		
		GEV No.	101339 Ref. No. 37Q2100
	cover cap for piezoelectric igniter		
		GEV No.	106869 Ref. No. —
	cover cap for piezoelectric igniter ID ø 22mm ED ø 35mm H 25mm		
		GEV No.	107931 Ref. No. —
	cover cap for piezoelectric igniter ID ø 21mm ED ø 36mm		

accessories			
 <p>1</p>			
GEV No.	101339	Ref. No.	37Q2100
description	cover cap for piezoelectric igniter		
For models:	0A0BMG, 0A0FAVA, 0A0FT1G, 0A0FT2G, 0A0FT4G, 0A0FT5G, 0A0GRG, 0A1CP1G, 0B0FT1G, 0B0FT2G, 0B0FT4G, 0B0FT5G, 0B1CP1G, 0D0BMG, 0D0FAVA, 0D0FT1G, 0D0FT2G, 0D0FT4G, 0D0FT5G, 0D0GRG, 0D1CP1G, 0G0FR5G, 0G0FT1G, 0G0FT1G-VERS.032008, 0G0FT2G, 0G0FT2G-VERS.032008, 0G0FT4G, 0G0FT4G-VERS.032008, 0G0FT5G, 0G0FT5G-VERS.032008, 0G0FT7G, 0G1BR3G, 0G1CP1G, 0G1CP1G-VERS.2004, 0G1FR7G, 191BR2EA, 1A0BMG, 1A0FA2, 1A0FA5, 1A0FAB, 1A0FAS2, 1A0FT1G, 1A0FT2G, 1A0FT3G, 1A0FT4G, 1A0FT6G, 1A0GRG, 1A0TP0, 1A1BR1E, 1A1BR2E...(Other models you can see in the webshop)		

 <p>1</p>			
GEV No.	101730	Ref. No.	3191100
description	disc ID ø 18mm ED ø 31mm H 2mm		
For models:	0A0BMG, 0A0FAVA, 0A0FT1G, 0A0FT2G, 0A0FT4G, 0A0FT5G, 0A0GRG, 0A1CP1G, 0B0FT1G, 0B0FT2G, 0B0FT4G, 0B0FT5G, 0B1CP1G, 0D0BMG, 0D0FAVA, 0D0FT1G, 0D0FT2G, 0D0FT4G, 0D0FT5G, 0D0GRG, 0D1CP1G, 0G0FR5G, 0G0FT1G, 0G0FT2G, 0G0FT4G, 0G0FT5G, 0G1BR3G, 0G1CP1G, 0G1CP1G-VERS.2004, 0G1FR7G, 1A0BMG, 1A0FA2, 1A0FA5, 1A0FAB, 1A0FAS2, 1A0FT1G, 1A0FT2G, 1A0FT3G, 1A0FT4G, 1A0FT6G, 1A0GRG, 1A0TP0, 1A1CP1G, 1A1CP2G, 1A1FA1G, 1A1FA2G, 1A1FA4G, 1A1FA5G, 1A1FAAG, 1A1FABG...(Other models you can see in the webshop)		

ignition units

 <p>1</p>			
GEV No.	102485	Ref. No.	32T0040 32T0041 32T0050 32T0210
description	ignition unit outputs 2 220-240VAC 0.6VA 50-60Hz		
For models:	04WFAAV, 06WCP1GM, 06WFR3GD, 08WCP1GM, 08WFT1GV, 08WFT2GV, 08WFT3GV, 08WFT4GV, 08WFT6GV, 08WFT7GV, 08WGRGV, 090BM1G, 090FAA, 090FAVA, 090FT1G, 090FT2G, 090FT4G, 090FT5G, 090FT7G, 090GRG, 091CP1G, 091FR1G, 091FR1GD, 091FR3G, 091FR3GD, 0A1FR1G, 0A1FR1GD, 0A1FR1GD-VERS.2004, 0A1FR1G-VERS.2004, 0A1FR3G, 0A1FR3GD, 0B1FR1G, 0B1FR1GD, 0D1FR1G, 0D1FR1GD, 0D1FR1GD-VERS.2004, 0D1FR1G-VERS.2004, 0D1FR3G, 0D1FR3GD, 0G1FR3G, 0G1FR3GD, 10CP1GA, 10WFR4GD, 10WTPGV, 12CP1GA, 12WFA6G, 18CP2GA, 190BM2G, 190FAB, 190FT15G...(Other models you can see in the webshop)		

 <p>1</p>			
GEV No.	103334	Ref. No.	3144130
description	ignition unit outputs 2 220-240VAC dimensions 83x42x32mm mounting distance 34mm inlet F2.8 outlet F2.8 type TSM 17VA 50/60Hz		
For models:	BX101G, BX101G-VERS.122013, BX122G, BX122G-VERS.122013, BX61G, BX61G-VERS.122013, BX82G, BX82G-VERS.122013, FX101G1R, FX101G2, FX101G2C, FX101G2C-VERS.032014, FX101G2R, FX101G2R-VERS.032014, FX101G2-VERS.032014, FX101G3, FX101G3C, FX101G3C-VERS.022014, FX101G3R, FX101G3R-VERS.022014, FX101G3-VERS.022014, FX10G2CR, FX10G2CR-VERS.032014, FX10G3CR, FX10G3CR-VERS.022014, FX122G1, FX122G2, FX122G2C, FX122G2T, FX122G2T-VERS.032014, FX122G3, FX122G3C, FX122G3T, FX122G3T-VERS.022014, FX12G3CT, FX12G3CT-VERS.022014, FX201G2, FX201G2P, FX201G2P-VERS.032014, FX201G2-VERS.032014, FX201G3P, FX201G3-VERS.022014, FX202G2, FX202G2-VERS.032014, FX202G3, FX202G3-VERS.022014, FX61G1, FX61G1R, FX61G2...(Other models you can see in the webshop)		

 <p>1</p>			
GEV No.	101002	Ref. No.	3107650
description	ignition unit outputs 2 230VAC dimensions 88x23x34mm mounting distance 73mm inlet F6.3x0.8 outlet F2.8x0.8 0.6VA 50/60Hz		
For models:	091FR1ID-VERS.052012, 091FR11-VERS.032012, 091FR7G, 091FR7G5, 091FR7G-VERS.052012, 091FR7GX, 10CP11A, 12CP11A, 18CP21A, 191FR2ID-VERS.092012, 191FR21-VERS.032012		

 <p>1</p>			
GEV No.	107548	Ref. No.	3134640
description	ignition unit outputs 4 220VAC dimensions 110x22x40mm mounting distance 100mm inlet F6.3x0.8 outlet F2.8x0.8 50-60Hz		
For models:	091FR11, 091FR11A, 091FR11D, 190FAA, 191FR21, 191FR21D		



1

GEV No.	102388	Ref. No.	32T0030
description	ignition unit outputs 4 230VAC dimensions 111x23x34mm mounting distance 100mm inlet F6.3x0.8 outlet F2.8x0.8 type WAC-T4 0.6VA 50/60Hz		

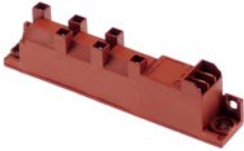

1

GEV No.	102389	Ref. No.	3015000
description	ignition unit outputs 6 230VAC dimensions 135x23x34mm mounting distance 123mm inlet F6.3x0.8 outlet F2.8x0.8 0.6VA 50/60Hz		
For models:	08WFA4E, 08WFA4G, 08WFAAE, 08WFAAG, 08WFAAV, 10WTPGE, 12WFA6E, 12WFA6G, 12WFAAA, 12WFAAE, 12WFAAG, 12WFAAN		



1

GEV No.	101004	Ref. No.	32T0070
description	ignition unit outputs 6 230VAC inlet F6.3x0.8 outlet F2.8x0.8 50Hz mounting \varnothing 88mm		



1

GEV No.	101005	Ref. No.	32T0020
description	ignition unit outputs 8 230VAC dimensions 92x68x33mm mounting distance 88mm inlet F6.3x0.8 outlet F2.8x0.8 type BK 40086-00 0.6VA 50-60Hz		

thermocouples

plug-in thermocouples

plug-in thermocouples standard

with barrel socket \varnothing 6mm

type Junkers with aluminised tip

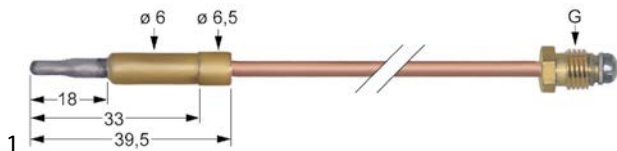

1

GEV No.	102229	Ref. No.	33A0360
description	thermocouple M10x1 L 1000mm plug connection \varnothing 6.0mm		

with barrel socket \varnothing 6(6.5)mm

thermocouples SIT

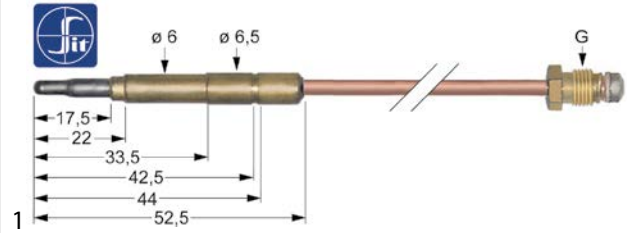

1

GEV No.	107621	Ref. No.	33A0370
description	thermocouple SIT M10x1 L 1500mm plug connection \varnothing 6.0(6.5)mm		

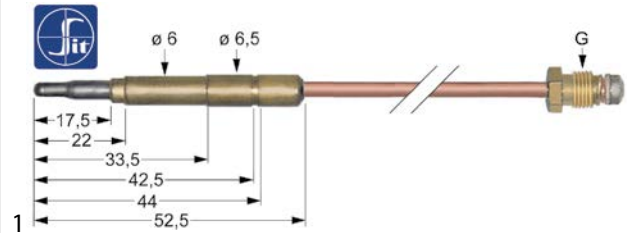

1

GEV No.	107605	Ref. No.	33A0520 33A0890
description	thermocouple SIT M8x1 L 1500mm plug connection \varnothing 6.0(6.5)mm		
For models:	071TP, 091TP, 1G1PD1G, 30CPS, 31, 31PD6, 31TC, 31TP, 32, 32TC, 32TP, 32TPV, 32V, 70CP, 71CP, 71CP2, 71PD10, 71PD15, 71TP, 72TP, 72TPGG, 90CP, 91CP		

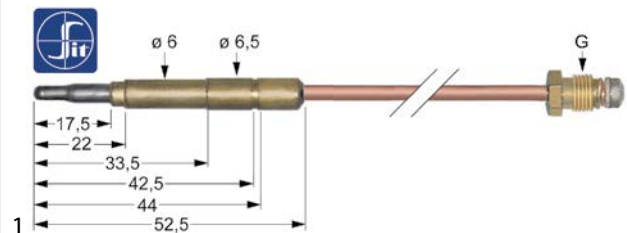

1

GEV No.	107600	Ref. No.	33A0390
description	thermocouple SIT M8x1 L 320mm plug connection \varnothing 6.0(6.5)mm		

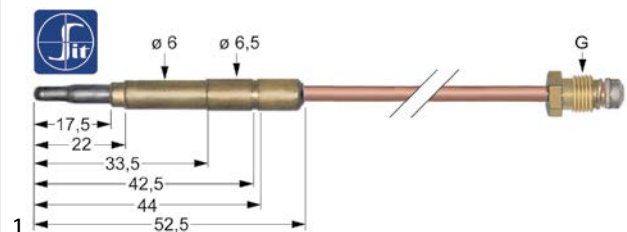

1

GEV No.	107601	Ref. No.	33A0400 33A1060
description	thermocouple SIT M8x1 L 600mm plug connection \varnothing 6.0(6.5)mm		
For models:	030, 030FT, 030FTR, 031, 031FT, 031FTR, 031FTRL, 031TP, 032, 070D, 070DGG, 070FT, 070FTR, 0712D, 0712VA, 071D, 071DGG, 071FT, 071FTR, 071FTRL, 072D, 072DGG, 090, 090FT, 090FTR, 090GG, 091, 091FT, 091FTR, 091FTRL, 091GG, 092, 092GG, 092VA, 092VAGG, 0A0FAS, 0B0FAS, 0D0FAS, 1A0FA2, 1A0FA5, 1A0FAB, 1A0FAS, 1A0FAS2, 1A1FA2G, 1A1FA5G, 1A1FABG, 1A1FAS2G, 1A1FASG, 1B0FAS, 1B0FAS2...(Other models you can see in the webshop)		

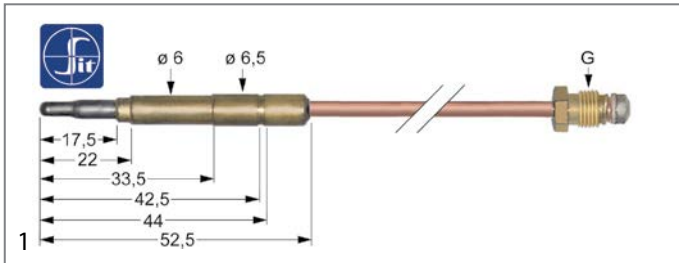

GEV No.	107612	Ref. No.	32A0310
description	thermocouple SIT M9x1 L 1000mm plug connection ø6.0(6.5)mm		

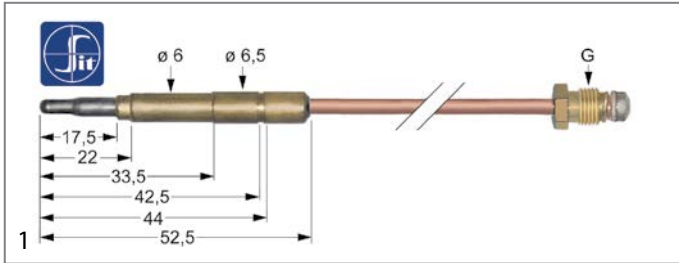

GEV No.	107614	Ref. No.	33A0320
description	thermocouple SIT M9x1 L 1500mm plug connection ø6.0(6.5)mm		

For models: 08WFA4G, 08WFAAG, 10WTPGE, 10WTPGV, 12WFA6G, 12WFAAG, 191FAAG, 191FABG, 191FADG, 191TPG, 1A1BR1G, 1A1BR1GA, 1A1BR2G, 1A1BR2GA, 1A1FA1G, 1A1FA2G, 1A1FA4G, 1A1FA5G, 1A1FAAG, 1A1FABG, 1A1TP0G-VERS.2002, 1B1FAS2G, 1B1FASG, 1D1BR1G, 1D1BR1GA, 1D1BR2G, 1D1BR2GA, 1D1FA1G, 1D1FA2G, 1D1FA4G, 1D1FA5G, 1D1FAAG, 1D1FABG, 1D1TP0G-VERS.2002, 1G1FA0G, 1G1FA0GV, 1G1FABG, 1G1FAPG, 1G1TP0G, 291FAG, 291TPCG, 2A1BR1G, 2A1BR1GA, 2A1BR2G, 2A1BR2GA, 2A1FA1G, 2A1FA4G, 2A1FAAG, 2A1TP3G, 2A1TP6G...(Other models you can see in the webshop)

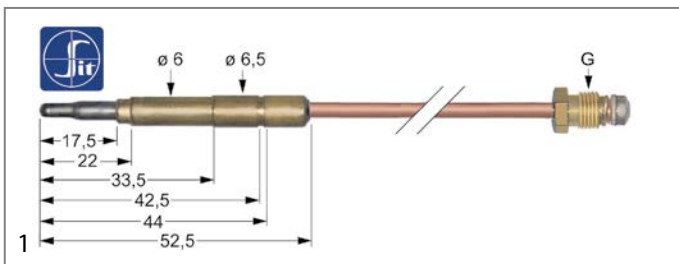

GEV No.	107609	Ref. No.	33A0310 33A0340
description	thermocouple SIT M9x1 L 600mm plug connection ø6.0(6.5)mm		

For models: GR4A-ONR01, SM1L, SM1LA, SM1LAW, SM1LW, SM2L, SM2LR, SM2LW, SM2S, SM2SR, SM2SW, SM3S, SM3SR

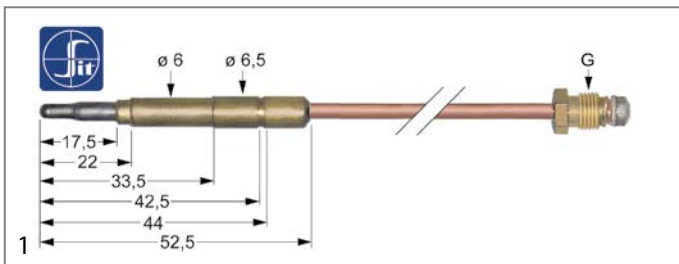

GEV No.	107611	Ref. No.	33A1140 33A1190
description	thermocouple SIT M9x1 L 850mm plug connection ø6.0(6.5)mm		

For models: 06WCP1GM, 070BM, 071BM, 08WCP1GM, 08WFT1GV, 08WFT2GV, 08WFT3GV, 08WFT7GV, 090BM, 091BM, 10WTPGE, 10WTPGV, 191BR1G, 191BR1GA, 191BR2G, 191BR2GA, 1A1FAS2G, 1A1FASG, 1A1PD1G, 1A1PD2G, 1A1PI1G, 1A1PI1GA, 1A1TP0G, 1D1FAS2G, 1D1FASG, 1D1PD1G, 1D1PD2G, 1D1PI1G, 1D1PI1GA, 1D1TP0G, 1G1BR1G, 291BR1G, 291BR1GA, 291BR2G, 291BR2GA, 2A1FAS2G, 2A1FASG, 2A1TPSG, 2D1FAS2G, 2D1FASG, 2D1TPSG, 31R, 3A1FASG, 3D1FASG, 6040560, 6042490, 6042500, 6043200, 712D, 712VA...(Other models you can see in the webshop)

threaded thermocouples (miscellaneous)

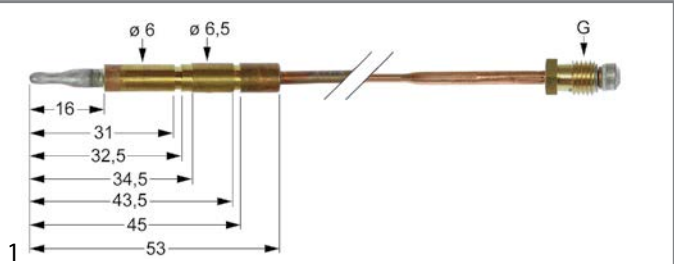

GEV No.	102998	Ref. No.	33A0680
description	thermocouple M8x1 L 600mm plug connection ø6.0mm		

For models: 030, 030FT, 030FTR, 031, 031FT, 031FTR, 031FTRL, 031TP, 032, 04WFAAV, 070D, 070DGG, 070FT, 070FTR, 0712D, 0712VA, 071D, 071DGG, 071FT, 071FTR, 071FTRL, 072D, 072DGG, 08WFA4E, 08WFA4G, 08WFAAE, 08WFAAG, 08WFAAV, 08WGRGV, 090, 090FAA, 090FAVA, 090FT, 090FT1G, 090FT2G, 090FT7G, 090FTR, 090GG, 090GRG, 091, 091CP1G, 091FT, 091FTR, 091FTRL, 091GG, 092, 092GG, 092VA, 092VAGG, 0A0FA1...(Other models you can see in the webshop)

plug-in thermocouples with interruption

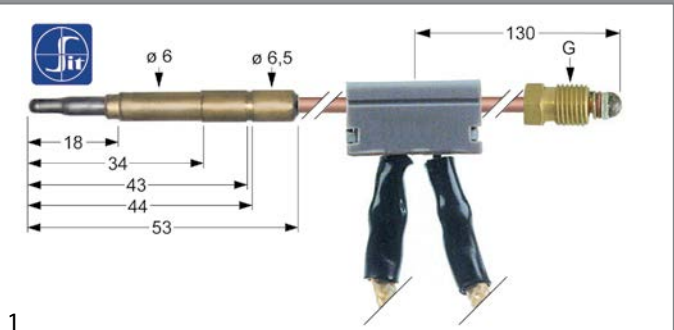

GEV No.	107863	Ref. No.	6021770
description	thermocouple SIT with interrupter M9x1 L 1000mm plug connection ø6.0(6.5)mm cable 820mm		

For models: 06WCP1GM, 06WFR3GD, 091CP1G, 091FR1G, 091FR1GD, 0G0FR5G, 0G1CP1G-VERS.2004, 0M0FR1G, 0M0FT4G, 0M0FT5G, 10CP1GA, 10WFR4GD, 12CP1GA, 18CP2GA, 191CP1G, 191CP2G, 191FR2G, 191FR2GD, 191PI1G, 191PI1GA, 191PI2G, 191PI2GA, 1A1FR2G, 1A1FR2GD, 1A1FR2GD-VERS.2004, 1A1FR2G-VERS.2004, 1A1FR4G, 1A1FR4GD, 1A1PI1G, 1A1PI1GA, 1D1FR2G, 1D1FR2GD, 1D1FR2GD-VERS.2004, 1D1FR2G-VERS.2004, 1D1FR4G, 1D1FR4GD, 1D1PI1G, 1D1PI1GA, 1G0FR6G, 1G1CP1G-VERS.2004, 1G1CP2G-VERS.2004, 1G1FR4G, 1G1FR4GD, 1G1PI1G, 1M0FR2G, 1M0FT4G, 1M0FT5G, 1M0FT6G, 291FAG, 2M0FT4G...(Other models you can see in the webshop)

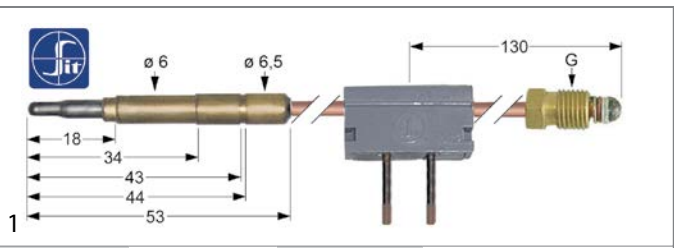

GEV No.	107164	Ref. No.	33A0900
description	thermocouple SIT with interrupter M9x1 L 1000mm plug connection ø6.0(6.5)mm soldering connection		

For models: 0M0FR1G, 0M0FT4G, 0M0FT5G, 191PI1G, 191PI1GA, 191PI2G, 191PI2GA, 1A1PI1G, 1A1PI1GA, 1D1PI1G, 1D1PI1GA, 1G1PI1G, 1M0FR2G, 1M0FT4G, 1M0FT5G, 1M0FT6G, 2M0FT4G, 2M0FT5G, 2M0FT6G, 30F, 30F1, 30F1B, 30FS, 30FS2, 30FS2B, 31PI6, 70F, 70F1, 70F1B, 71F, 71F2, 71F2B, 71PI10, 71PI10A, 90F110B, 91F210, 91F210B, 91F223B, 91PI10, 91PI10A, FC101, FC241, FC241G, FC61, FCV101, FCV101DM, FCV101DS, FCV141, FCV141DM, FCV141DS...(Other models you can see in the webshop)

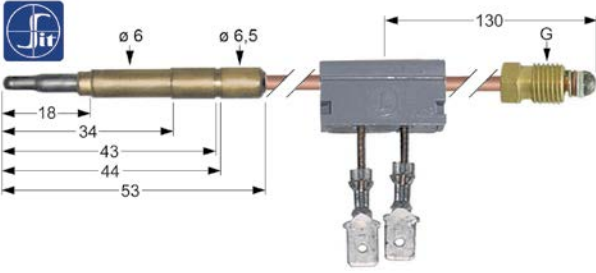

GEV No.	107177	Ref. No.	33A0140
description	thermocouple SIT with interrupter M9x1 L 600mm plug connection ø6.0mm F 6.3mm		
For models:	031FT04, 031FT06, 070FT04, 070FT05, 071FT04, 071FT06, 08WFT-4GV, 08WFT6GV, 090BM1G, 090FT04, 090FT05, 090FT4G, 090FT5G, 091FR3G, 091FR3GD, 091FT04, 091FT06, 0A0BMG, 0A0FT1G, 0A0FT2G, 0A0FT4G, 0A0FT5G, 0A1FR1G, 0A1FR1GD, 0A1FR1GD-VERS.2004, 0A1FR1G-VERS.2004, 0A1FR3G, 0A1FR3GD, 0B0FT1G, 0B0FT2G, 0B0FT4G, 0B0FT5G, 0B1FR1G, 0B1FR1GD, 0D0BMG, 0D0FT1G, 0D0FT2G, 0D0FT4G, 0D0FT5G, 0D1FR1G, 0D1FR1GD, 0D1FR1GD-VERS.2004, 0D1FR1G-VERS.2004, 0D1FR3G, 0D1FR3GD, 0G0FR5G, 0G0FT4G, 0G0FT5G, 0G1BR3G, 0G1FR3G...(Other models you can see in the webshop)		

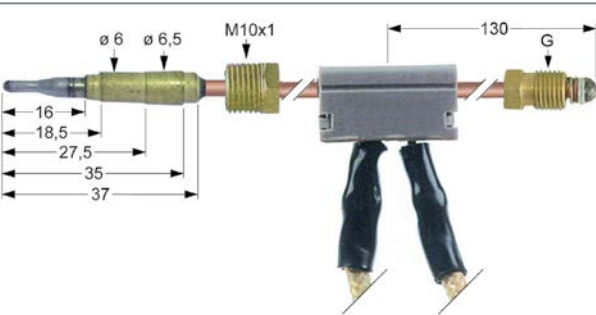

GEV No.	102252	Ref. No.	33A1410 6021780
description	thermocouple with interrupter M9x1 L 600mm plug connection ø6.0mm cable 650mm		
For models:	06WFR3GD, 090BM1G, 090FT4G, 090FT5G, 091FR1G, 091FR1GD, 091FR3G, 091FR3GD, 0A0BMG, 0A1FR1G, 0A1FR1GD, 0A1FR1GD-VERS.2004, 0A1FR1G-VERS.2004, 0B1FR1G, 0B1FR1GD, 0D0BMG, 0D1FR1G, 0D1FR1GD, 0D1FR1GD-VERS.2004, 0D1FR1G-VERS.2004, 0G0FT4G, 0G0FT4G-VERS.032008, 0G0FT5G, 0G0FT5G-VERS.032008, 0G1BR3G, 0G1FR3G, 0G1FR3GD, 0G1FR7G, 10WFR4GD, 190BM2G, 190FT15G, 190FT42G, 190FT4G, 190FT6G, 191FR2G, 191FR2GD, 191FR4G, 191FR4GD, 1A0BMG, 1A1FR2G, 1A1FR2GD, 1A1FR2GD-VERS.2004, 1A1FR2G-VERS.2004, 1A1FR4G, 1A1FR4GD, 1D0BMG, 1D1FR2G, 1D1FR2GD, 1D1FR2GD-VERS.2004, 1D1FR2G-VERS.2004...(Other models you can see in the webshop)		

extensions			
GEV No.	102013	Ref. No.	33A0130 33A1270
description	thermocouple extension thread M9x1 L 500mm		
For models:	031FT04, 031FT06, 1A1BR1G, 1A1BR1GA, 1A1BR2G, 1A1BR2GA, 1D1BR1G, 1D1BR1GA, 1D1BR2G, 1D1BR2GA, 2A1BR1G, 2A1BR1GA, 2A1BR2G, 2A1BR2GA, 2D1BR1G, 2D1BR1GA, 2D1BR2G, 2D1BR2GA		
accessories for	102013		
	GEV No.	101261	Ref. No. —
	thermocouple fitting thread M9x1 Qty 1 pcs		

accessories			
screws			
GEV No.	100920	Ref. No.	33Q2940
description	thermocouple fitting thread M8x1 / M9x1 Qty 1 pcs		
For models:	06WCP1GM, 08WCP1GM, 090FT1G, 090FT2G, 090FT7G, 091CP1G, 0A0FT4G, 0A0FT5G, 0B0FT1G, 0B0FT2G, 0B0FT4G, 0B0FT5G, 0D0FT4G, 0D0FT5G, 0G0FT4G, 0G0FT5G, 0G1CP1G-VERS.2004, 190FT1G, 190FT2G, 190FT3G, 190FT4G, 190FT6G, 190FT7G, 191CP1G, 191CP2G, 1A0FT4G, 1A0FT6G, 1A1PD2G, 1A1PI1G, 1A1PI1GA, 1B0FT4G, 1B0FT6G, 1D0FT4G, 1D0FT6G, 1D1PD2G, 1D1PI1G, 1D1PI1GA, 1G0FT4G, 1G0FT6G, 1G1CP1G-VERS.2004, 1G1CP2G-VERS.2004, 1G1PI1G, 31PI6, 71PI10, 71PI10A, 91PI10, 91PI10A, G1FAGS, G1FAGST		

miscellaneous			
GEV No.	100950	Ref. No.	35T0680
description	fastening angle Qty 1 pcs		

gas burners			
hob burners			
producer-specific hob burners			
ANGELO PO			
Alpha (1), Delta (2), Gamma series			

GEV No.	104792	Ref. No.	34A2040
description	burner cap ø 110mm		
For models:	0A0FA1, 0A0FA4, 0D0FA1, 0G0FA0, 1A0FA1, 1A0FA2, 1A1FA1G, 1A1FA2G, 1D0FA1, 1D0FA2, 1D1FA1G, 1D1FA2G, 1G0FA0, 1G1FA0E, 1G1FA0EV, 1G1FA0G, 1G1FA0GV, 1G1FAPG, 2A0FA1, 2A1FA1G, 2A1TP3G, 2D0FA1, 2D1FA1G, 2D1TP3G, 2G0FA0, 2G1FA0G, 2G1FAPG, 2G1TP3G, 3A1FA1G, 3D1FA1G, 6FA		

GEV No.	104790	Ref. No.	34A2060
description	burner cap ø 130mm 7.5kW		
For models:	0A0FA1, 0A0FA4, 0D0FA1, 0D0FA4, 1A0FA1, 1A0FA2, 1A0FA4, 1A0FA5, 1A1FA1G, 1A1FA2G, 1A1FA4G, 1A1FA5G, 1D0FA1, 1D0FA2, 1D0FA4, 1D0FA5, 1D1FA1G, 1D1FA2G, 1D1FA4G, 1D1FA5G, 2A0FA1, 2A0FA4, 2A1FA1G, 2A1FA4G, 2A1TP3G, 2A1TP6G, 2D0FA1, 2D0FA4, 2D1FA1G, 2D1FA4G, 2D1TP3G, 2D1TP6G, 3A1FA1G, 3A1FA4G, 3D1FA1G, 3D1FA4G		





			
1			
GEV No.	104756	Ref. No.	34A2030 34A2032
description	burner head for burner cap ø 110mm new edition		
For models:	0A0FA1, 0A0FA4, 0D0FA1, 0G0FA0, 1A0FA1, 1A0FA2, 1A1FA1G, 1A1FA2G, 1D0FA1, 1D0FA2, 1D1FA1G, 1D1FA2G, 1G0FA0, 1G1FA0E, 1G1FA0EV, 1G1FA0G, 1G1FA0GV, 1G1FAPG, 2A0FA1, 2A1FA1G, 2A1TP3G, 2D0FA1, 2D1FA1G, 2D1TP3G, 2G0FA0, 2G1FA0G, 2G1FADG, 2G1FADGV, 2G1FAPG, 2G1TP3G, 3A1FA1G, 3D1FA1G		

			
1			
GEV No.	104794	Ref. No.	34A2050 34A2051 34A2052
description	burner head for burner cap ø 130mm new edition		
For models:	0A0FA1, 0A0FA4, 0D0FA1, 0D0FA4, 1A0FA1, 1A0FA2, 1A0FA4, 1A0FA5, 1A1FA1G, 1A1FA2G, 1A1FA4G, 1A1FA5G, 1D0FA1, 1D0FA2, 1D0FA4, 1D0FA5, 1D1FA1G, 1D1FA2G, 1D1FA4G, 1D1FA5G, 2A0FA1, 2A0FA4, 2A1FA1G, 2A1FA4G, 2A1TP3G, 2A1TP6G, 2D0FA1, 2D0FA4, 2D1FA1G, 2D1FA4G, 2D1TP3G, 2D1TP6G, 3A1FA1G, 3A1FA4G, 3D1FA1G, 3D1FA4G		

			
1			
GEV No.	104059	Ref. No.	3311911 34A2070 34A2071
description	burner lower part for burner cap ø 80/110mm		
For models:	08WFA4E, 090FAA, 0A0FA1, 0A0FA4, 0D0FA1, 0D0FA4, 0G0FA0, 12WFA6E, 190FA, 190FAA, 190FAB, 190FAD, 191FAAE, 191FAAG, 191FABG, 191FADG, 191FAE, 191FAG, 1A0FA1, 1A0FA2, 1A0FA4, 1A0FA5, 1A1FA1G, 1A1FA2G, 1A1FA4G, 1A1FA5G, 1D0FA1, 1D0FA2, 1D0FA4, 1D0FA5, 1D1FA1G, 1D1FA2G, 1D1FA4G, 1D1FA5G, 1G0FA0, 1G0FA0B, 1G1FA0E, 1G1FA0EV, 1G1FA0G, 1G1FA0GV, 1G1FABG, 1G1FAPG, 290FA, 291FAG, 291FAGF, 291TPCG, 2A0FA1, 2A0FA4, 2A1FA1G, 2A1FA4G...(Other models you can see in the webshop)		

			
1			
GEV No.	104006	Ref. No.	34A2020
description	nozzle holder		
For models:	08WFA4E, 090FAA, 0A0FA1, 0A0FA4, 0D0FA1, 0D0FA4, 0G0FA0, 12WFA6E, 190FA, 190FAA, 190FAB, 190FAD, 191FAAE, 191FAAG, 191FABG, 191FADG, 191FAE, 191FAG, 1A0FA1, 1A0FA2, 1A0FA4, 1A0FA5, 1A1FA1G, 1A1FA2G, 1A1FA4G, 1A1FA5G, 1D0FA1, 1D0FA2, 1D0FA4, 1D0FA5, 1D1FA1G, 1D1FA2G, 1D1FA4G, 1D1FA5G, 1G0FA0, 1G0FA0B, 1G1FA0E, 1G1FA0EV, 1G1FA0G, 1G1FA0GV, 1G1FABG, 1G1FAPG, 290FA, 291FAG, 291FAGF, 291TPCG, 2A0FA1, 2A0FA4, 2A1FA1G, 2A1FA4G...(Other models you can see in the webshop)		

			
1			
GEV No.	532541	Ref. No.	3152040
description	O-ring silicone thickness 1.78mm ID ø 47.35mm Qty 1 pcs		
For models:	04WFAAV, 08WFA4E, 08WFA4G, 08WFAAE, 08WFAAG, 08WFAAV, 090FAA, 0A0FA1, 0A0FA4, 0A0FAA, 0D0FA1, 0D0FA4, 0D0FAA, 0G0FA0, 12WFA6E, 12WFA6G, 12WFAAA, 12WFAAE, 12WFAAG, 12WFAAN, 190FA, 190FAA, 190FAB, 190FAD, 191FAAE, 191FAAG, 191FABG, 191FADG, 191FAE, 191FAG, 1A0FA1, 1A0FA2, 1A0FA4, 1A0FA5, 1A0FAA, 1A0FAB, 1A1FA1G, 1A1FA2G, 1A1FA4G, 1A1FA5G, 1A1FAAG, 1A1FABG, 1D0FA1, 1D0FA2, 1D0FA4, 1D0FA5, 1D0FAA, 1D0FAB, 1D1FA1G, 1D1FA2G...(Other models you can see in the webshop)		

			
1			
GEV No.	104793	Ref. No.	34A2010
description	venturi ø 12mm		
For models:	0A0FA1, 0A0FA4, 0D0FA1, 0G0FA0, 1A0FA1, 1A0FA2, 1A1FA1G, 1A1FA2G, 1D0FA1, 1D0FA2, 1D1FA1G, 1D1FA2G, 1G0FA0, 1G0FA0B, 1G1FA0E, 1G1FA0EV, 1G1FA0G, 1G1FA0GV, 1G1FABG, 1G1FAPG, 2A0FA1, 2A1FA1G, 2A1TP3G, 2D0FA1, 2D1FA1G, 2D1TP3G, 2G0FA0, 2G0FA0B, 2G1FA0E, 2G1FA0G, 2G1FA0GV, 2G1FABG, 2G1FACG, 2G1FADG, 2G1FADGV, 2G1FAPG, 2G1TP3G, 3A1FA1G, 3D1FA1G, 6FA		

			
1			
GEV No.	104005	Ref. No.	34A2000
description	venturi ø 14.5mm		
For models:	08WFA4E, 090FAA, 0A0FA1, 0A0FA4, 0D0FA1, 0D0FA4, 12WFA6E, 190FA, 190FAA, 190FAB, 190FAD, 191FAAE, 191FAAG, 191FABG, 191FADG, 191FAE, 191FAG, 1A0FA1, 1A0FA2, 1A0FA4, 1A0FA5, 1A1FA1G, 1A1FA2G, 1A1FA4G, 1A1FA5G, 1D0FA1, 1D0FA2, 1D0FA4, 1D0FA5, 1D1FA1G, 1D1FA2G, 1D1FA4G, 1D1FA5G, 290FA, 291FAG, 291FAGF, 291TPCG, 2A0FA1, 2A0FA4, 2A1FA1G, 2A1FA4G, 2A1TP3G, 2A1TP6G, 2D0FA1, 2D0FA4, 2D1FA1G, 2D1FA4G, 2D1TP3G, 2D1TP6G, 391FAG...(Other models you can see in the webshop)		

Serie Alpha (2), Delta (3), Omega (2)

			
1			
GEV No.	104740	Ref. No.	3019390
description	burner cap ø 110mm 7kW		
For models:	04WFAAV, 08WFA4E, 08WFA4G, 08WFAAE, 08WFAAG, 08WFAAV, 090FAA, 0A0FAA, 0D0FAA, 0G0FA0, 12WFA6E, 12WFA6G, 12WFAAA, 12WFAAE, 12WFAAG, 12WFAAN, 190FA, 190FAA, 190FAB, 190FAD, 191FAAE, 191FAAG, 191FABG, 191FADG, 191FAE, 191FAG, 1A0FAA, 1A0FAB, 1A1FAAG, 1A1FABG, 1D0FAA, 1D0FAB, 1D1FAAG, 1D1FABG, 1G0FA0, 1G0FA0B, 1G1FA0E, 1G1FA0EV, 1G1FA0G, 1G1FA0GV, 1G1FABG, 1G1FAPG, 290FA, 291FAG, 291FAGF, 291TPCG, 2A0FAA, 2A1FAAG, 2A1TPCG, 2D0FAA...(Other models you can see in the webshop)		
accessories for	104740		
			
GEV No.	104739	Ref. No.	3019380
description	burner head for burner cap ø 110mm 7kW		
			
GEV No.	108142	Ref. No.	6013760 6013761 6013762
description	venturi for burner cap ø 110mm suitable for burner 7kW		





GEV No.	104081	Ref. No.	3019370
description	burner cap ø 130mm 10kW		
For models:	04WFAAV, 08WFA4E, 08WFA4G, 08WFAAE, 08WFAAG, 08WFAAV, 090FAA, 0A0FAA, 0D0FAA, 12WFA6E, 12WFA6G, 12WFAAA, 12WFAAE, 12WFAAG, 12WFAAN, 190FA, 190FAA, 190FAB, 191FAAE, 191FAAG, 191FABG, 191FAE, 191FAG, 1A0FAA, 1A0FAB, 1A1FAAG, 1A1FABG, 1D0FAA, 1D0FAB, 1D1FAAG, 1D1FABG, 290FA, 291FAG, 291FAGF, 291TPCG, 2A0FAA, 2A1FAAG, 2A1TPCG, 2D0FAA, 2D1FAAG, 2D1TPCG, 391FAG, 3A1FAAG, 3D1FAAG		



GEV No.	104298	Ref. No.	3057610
description	burner cap ø 80mm 4kW		
For models:	190FA, 190FAD, 191FADG, 191FAE, 191FAG, 1G0FA0, 1G1FA0E, 1G1FA0EV, 1G1FA0G, 1G1FA0GV, 290FA, 291FAG, 291FAGF, 2G0FA0, 2G0FA0A, 2G1FA0E, 2G1FA0G, 2G1FA0GV, 2G1FACG, 2G1FADG, 2G1FADGV, 391FAG, 6FA, 6FA1		

accessories for 104298

	GEV No.	104297	Ref. No.	3057600
burner head for burner cap ø 80mm 4kW				
	GEV No.	108141	Ref. No.	6020730 6020731
venturi for burner cap ø 80mm suitable for burner 4kW				





GEV No.	104739	Ref. No.	3019380	
description	burner head for burner cap ø 110mm 7kW			
For models:	04WFAAV, 08WFA4E, 08WFA4G, 08WFAAE, 08WFAAG, 08WFAAV, 090FAA, 0A0FAA, 0D0FAA, 0G0FA0, 12WFA6E, 12WFA6G, 12WFAAA, 12WFAAE, 12WFAAG, 12WFAAN, 190FA, 190FAA, 190FAB, 190FAD, 191FAAE, 191FAAG, 191FABG, 191FADG, 191FAE, 191FAG, 1A0FAA, 1A0FAB, 1A1FAAG, 1A1FABG, 1D0FAA, 1D0FAB, 1D1FAAG, 1D1FABG, 1G0FA0, 1G0FA0B, 1G1FA0E, 1G1FA0EV, 1G1FA0G, 1G1FA0GV, 1G1FABG, 1G1FAPG, 290FA, 291FAG, 291FAGF, 291TPCG, 2A0FAA, 2A1FAAG, 2A1TPCG, 2D0FAA...(Other models you can see in the webshop)			
accessories for	104739			
	GEV No.	104740	Ref. No.	3019390
burner cap ø 110mm 7kW				
	GEV No.	108142	Ref. No.	6013760 6013761 6013762
venturi for burner cap ø 110mm suitable for burner 7kW				



GEV No.	104097	Ref. No.	3019360	
description	burner head for burner cap ø 130mm 10kW			
For models:	04WFAAV, 08WFA4E, 08WFA4G, 08WFAAE, 08WFAAG, 08WFAAV, 090FAA, 0A0FAA, 0D0FAA, 12WFA6E, 12WFA6G, 12WFAAA, 12WFAAE, 12WFAAG, 12WFAAN, 190FA, 190FAA, 190FAB, 191FAAE, 191FAAG, 191FABG, 191FAE, 191FAG, 1A0FAA, 1A0FAB, 1A1FAAG, 1A1FABG, 1D0FAA, 1D0FAB, 1D1FAAG, 1D1FABG, 290FA, 291FAG, 291FAGF, 291TPCG, 2A0FAA, 2A1FAAG, 2A1TPCG, 2D0FAA, 2D1FAAG, 2D1TPCG, 391FAG, 3A1FAAG, 3D1FAAG			
accessories for	104097			
	GEV No.	104007	Ref. No.	6014830 6014831 6014832
burner lower part for burner cap ø 130mm complete with venturi and nozzle holder				



GEV No.	104297	Ref. No.	3057600	
description	burner head for burner cap ø 80mm 4kW			
For models:	190FA, 190FAD, 191FADG, 191FAE, 191FAG, 1G0FA0, 1G1FA0E, 1G1FA0EV, 1G1FA0G, 1G1FA0GV, 290FA, 291FAG, 291FAGF, 2G0FA0, 2G0FA0A, 2G1FA0E, 2G1FA0G, 2G1FA0GV, 2G1FACG, 2G1FADG, 2G1FADGV, 391FAG, 6FA, 6FA1			
accessories for	104297			
	GEV No.	104298	Ref. No.	3057610
burner cap ø 80mm 4kW				
	GEV No.	108141	Ref. No.	6020730 6020731
venturi for burner cap ø 80mm suitable for burner 4kW				







GEV No.	104007	Ref. No.	6014830 6014831 6014832	
description	burner lower part for burner cap ø 130mm complete with venturi and nozzle holder			
For models:	04WFAAV, 08WFA4E, 08WFA4G, 08WFAAE, 08WFAAG, 08WFAAV, 090FAA, 0A0FAA, 0D0FAA, 12WFA6E, 12WFA6G, 12WFAAA, 12WFAAE, 12WFAAG, 12WFAAN, 190FA, 190FAA, 190FAB, 191FAAE, 191FAAG, 191FABG, 191FAE, 191FAG, 1A0FAA, 1A0FAB, 1A1FAAG, 1A1FABG, 1D0FAA, 1D0FAB, 1D1FAAG, 1D1FABG, 290FA, 291FAG, 291FAGF, 291TPCG, 2A0FAA, 2A1FAAG, 2A1TPCG, 2D0FAA, 2D1FAAG, 2D1TPCG, 391FAG, 3A1FAAG, 3D1FAAG			
accessories for	104007			
	GEV No.	104097	Ref. No.	3019360
burner head for burner cap ø 130mm 10kW				







			
1			
GEV No.	104059	Ref. No.	3311911 34A2070 34A2071
description	burner lower part for burner cap ø 80/110mm		
For models:	08WFA4E, 090FAA, 0A0FA1, 0A0FA4, 0D0FA1, 0D0FA4, 0G0FA0, 12WFA6E, 190FA, 190FAA, 190FAB, 190FAD, 191FAAE, 191FAAG, 191FABG, 191FADG, 191FAE, 191FAG, 1A0FA1, 1A0FA2, 1A0FA4, 1A0FA5, 1A1FA1G, 1A1FA2G, 1A1FA4G, 1A1FA5G, 1D0FA1, 1D0FA2, 1D0FA4, 1D0FA5, 1D1FA1G, 1D1FA2G, 1D1FA4G, 1D1FA5G, 1G0FA0, 1G0FA0B, 1G1FA0E, 1G1FA0EV, 1G1FA0G, 1G1FA0GV, 1G1FABG, 1G1FAPG, 290FA, 291FAG, 291FAGF, 291TPCG, 2A0FA1, 2A0FA4, 2A1FA1G, 2A1FA4G...(Other models you can see in the webshop)		

			
1			
GEV No.	104006	Ref. No.	34A2020
description	nozzle holder		
For models:	08WFA4E, 090FAA, 0A0FA1, 0A0FA4, 0D0FA1, 0D0FA4, 0G0FA0, 12WFA6E, 190FA, 190FAA, 190FAB, 190FAD, 191FAAE, 191FAAG, 191FABG, 191FADG, 191FAE, 191FAG, 1A0FA1, 1A0FA2, 1A0FA4, 1A0FA5, 1A1FA1G, 1A1FA2G, 1A1FA4G, 1A1FA5G, 1D0FA1, 1D0FA2, 1D0FA4, 1D0FA5, 1D1FA1G, 1D1FA2G, 1D1FA4G, 1D1FA5G, 1G0FA0, 1G0FA0B, 1G1FA0E, 1G1FA0EV, 1G1FA0G, 1G1FA0GV, 1G1FABG, 1G1FAPG, 290FA, 291FAG, 291FAGF, 291TPCG, 2A0FA1, 2A0FA4, 2A1FA1G, 2A1FA4G...(Other models you can see in the webshop)		

			
1			
GEV No.	532541	Ref. No.	3152040
description	O-ring silicone thickness 1.78mm ID ø 47.35mm Qty 1 pcs		
For models:	04WFAAV, 08WFA4E, 08WFA4G, 08WFAAE, 08WFAAG, 08WFAAV, 090FAA, 0A0FA1, 0A0FA4, 0A0FAA, 0D0FA1, 0D0FA4, 0D0FAA, 0G0FA0, 12WFA6E, 12WFA6G, 12WFAAA, 12WFAAE, 12WFAAG, 12WFAAN, 190FA, 190FAA, 190FAB, 190FAD, 191FAAE, 191FAAG, 191FABG, 191FADG, 191FAE, 191FAG, 1A0FA1, 1A0FA2, 1A0FA4, 1A0FA5, 1A0FAA, 1A0FAB, 1A1FA1G, 1A1FA2G, 1A1FA4G, 1A1FA5G, 1A1FAAG, 1A1FABG, 1D0FA1, 1D0FA2, 1D0FA4, 1D0FA5, 1D0FAB, 1D1FA1G, 1D1FA2G...(Other models you can see in the webshop)		



			
1			
GEV No.	108142	Ref. No.	6013760 6013761 6013762
description	venturi for burner cap ø 110mm suitable for burner 7kW		
For models:	04WFAAV, 08WFA4E, 08WFA4G, 08WFAAE, 08WFAAG, 08WFAAV, 090FAA, 0A0FAA, 0D0FAA, 12WFA6E, 12WFA6G, 12WFAAA, 12WFAAE, 12WFAAG, 12WFAAN, 190FA, 190FAA, 190FAB, 190FAD, 191FAAE, 191FAAG, 191FABG, 191FADG, 191FAE, 191FAG, 1A0FAA, 1A0FAB, 1A1FAAG, 1A1FABG, 1D0FAA, 1D0FAB, 1D1FAAG, 1D1FABG, 290FA, 291FAG, 291FAGF, 291TPCG, 2A0FAA, 2A1FAAG, 2A1TPCG, 2D0FAA, 2D1FAAG, 2D1TPCG, 391FAG, 3A1FAAG, 3D1FAAG		
accessories for	108142		
	GEV No.	104739	Ref. No. 3019380
burner head for burner cap ø 110mm 7kW			
	GEV No.	104740	Ref. No. 3019390
burner cap ø 110mm 7kW			

			
1			
GEV No.	108141	Ref. No.	6020730 6020731
description	venturi for burner cap ø 80mm suitable for burner 4kW		
For models:	190FA, 190FAD, 191FADG, 191FAE, 191FAG, 1G0FA0, 1G1FA0E, 1G1FA0EV, 1G1FA0G, 1G1FA0GV, 290FA, 291FAG, 291FAGF, 2G0FA0, 2G0FA0A, 2G1FA0E, 2G1FA0G, 2G1FA0GV, 2G1FACG, 2G1FADG, 2G1FADGV, 391FAG		
accessories for	108141		
	GEV No.	104297	Ref. No. 3057600
burner head for burner cap ø 80mm 4kW			
	GEV No.	104298	Ref. No. 3057610
burner cap ø 80mm 4kW			



			
1			
GEV No.	104058	Ref. No.	3057620
description	venturi ø 11mm		
For models:	190FA, 190FAD, 191FADG, 191FAE, 191FAG, 1G0FA0, 1G1FA0E, 1G1FA0EV, 1G1FA0G, 1G1FA0GV, 290FA, 291FAG, 291FAGF, 2G0FA0, 2G0FA0A, 2G1FA0E, 2G1FA0G, 2G1FA0GV, 2G1FACG, 2G1FADG, 2G1FADGV, 391FAG, 6FA, 6FA1		

			
1			
GEV No.	104005	Ref. No.	34A2000
description	venturi ø 14.5mm		
For models:	08WFA4E, 090FAA, 0A0FA1, 0A0FA4, 0D0FA1, 0D0FA4, 12WFA6E, 190FA, 190FAA, 190FAB, 190FAD, 191FAAE, 191FAAG, 191FABG, 191FADG, 191FAE, 191FAG, 1A0FA1, 1A0FA2, 1A0FA4, 1A0FA5, 1A1FA1G, 1A1FA2G, 1A1FA4G, 1A1FA5G, 1D0FA1, 1D0FA2, 1D0FA4, 1D0FA5, 1D1FA1G, 1D1FA2G, 1D1FA4G, 1D1FA5G, 290FA, 291FAG, 291FAGF, 291TPCG, 2A0FA1, 2A0FA4, 2A1FA1G, 2A1FA4G, 2A1TP3G, 2A1TP6G, 2D0FA1, 2D0FA4, 2D1FA1G, 2D1FA4G, 2D1TP3G, 2D1TP6G, 391FAG...(Other models you can see in the webshop)		





Combi, Junior (1), Major series



			
1			
GEV No.	103014	Ref. No.	34A0050
description	burner cap ø 110mm		
accessories for	103014		
	GEV No.	104018	Ref. No. 36D0070
burner holder for burner cap ø 60/90/110mm with nozzle holder gas inlet M20x1.5			
	GEV No.	104026	Ref. No. 34A0090
burner head for burner cap ø 110mm			









			
1			
GEV No.	103015	Ref. No.	34A1130 34A1131 34A1133
description	burner cap ø 110mm		
For models:	030, 031, 032, 0712D, 071D, 071DGG, 072D, 072DGG, 091, 091GG, 092, 092GG, 092VA, 092VAGG, 1A0FAS, 1B0FAS, 1B1FASG, 1D0FAS, 1D1FASG, 2A0FAS2, 2A1FAS2G, 2D0FAS2, 2D1FAS2G, 2D1FASG, 31, 31GE, 31TC, 32, 32TC, 32TP, 32TPV, 32V, 3D1FASG, 712D, 71D, 71DGG, 71GE, 71GEGG, 72D, 72DGG, 72VA, 72VAGG, 72VAS, 72VASGG, 73D, 73DGG, 73VA, 73VAD, 73VADGG, 73VAGG		
accessories for	103015		
	GEV No.	104015	Ref. No. 34A1110
	burner head for burner cap ø 110mm		
	GEV No.	104018	Ref. No. 36D0070
	burner holder for burner cap ø 60/90/110mm with nozzle holder gas inlet M20x1.5		

			
1			
GEV No.	103056	Ref. No.	34A0540
description	burner cap ø 119mm with central hole		

			
1			
GEV No.	103016	Ref. No.	34A1140 34A1141
description	burner cap ø 140mm		
For models:	070D, 070DGG, 0712D, 0712VA, 071D, 071DGG, 072D, 072DGG, 090, 090GG, 091, 091GG, 092, 092GG, 092VA, 092VAGG, 0A0FAS, 0B0FAS, 0D0FAS, 1A0FAS, 1A0FAS2, 1A1FAS2G, 1A1FASG, 1B0FAS, 1B0FAS2, 1B1FAS2G, 1B1FASG, 1D0FAS, 1D0FAS2, 1D1FAS2G, 1D1FASG, 2A0FAS2, 2A1FAS2G, 2A1FASG, 2A1TPSG, 2D0FAS2, 2D1FAS2G, 2D1FASG, 2D1TPSG, 3A1FASG, 3D1FASG, 712D, 712VA, 71D, 71DGG, 71GE, 71GEGG, 72D, 72DGG, 72TP...(Other models you can see in the webshop)		
accessories for	103016		
	GEV No.	104016	Ref. No. 34A1090 34A6760
	burner head for burner cap ø 140mm		
	GEV No.	104019	Ref. No. 36D1230
	burner holder for burner cap ø 140mm gas inlet M20x1.5		
	GEV No.	104022	Ref. No. 34A1401
	burner head ø 139.5mm seat ø 122.8mm for burner cap ø 140mm int. ø 192.8mm int. ø 285.2mm		
	GEV No.	104023	Ref. No. 36D2771
	burner holder seat ø 35mm with nozzle holder		

			
1			
GEV No.	103010	Ref. No.	34A0070
description	burner cap ø 60mm		
accessories for	103010		
	GEV No.	104017	Ref. No. 36D0060
	burner holder with nozzle holder gas inlet 1/4"		
	GEV No.	104024	Ref. No. 34A0060
	burner head for burner cap ø 60mm		

			
1			
GEV No.	103011	Ref. No.	34A0750 34A1580
description	burner cap ø 60mm		
accessories for	103011		
	GEV No.	104013	Ref. No. 34A0570
	burner head for burner cap ø 60mm		
	GEV No.	104018	Ref. No. 36D0070
	burner holder for burner cap ø 60/90/110mm with nozzle holder gas inlet M20x1.5		

			
1			
GEV No.	103012	Ref. No.	34A0040
description	burner cap ø 90mm		
accessories for	103012		
	GEV No.	104018	Ref. No. 36D0070
	burner holder for burner cap ø 60/90/110mm with nozzle holder gas inlet M20x1.5		
	GEV No.	104025	Ref. No. 34A0080
	burner head for burner cap ø 90mm		







			
1			
GEV No.	103013	Ref. No.	34A0740 34A1120 34A1121 34A1123
description	burner cap ø 90mm		
For models:	030, 031, 032, 070D, 070DGG, 0712D, 0712VA, 071D, 071DGG, 072D, 072DGG, 090, 090GG, 091, 091GG, 092, 092GG, 092VA, 092VAGG, 0A0FAS, 0B0FAS, 0D0FAS, 1A0FAS, 1A0FAS2, 1A1FAS2G, 1A1FASG, 1B0FAS, 1B0FAS2, 1B1FAS2G, 1B1FASG, 1D0FAS, 1D0FAS2, 1D1FAS2G, 1D1FASG, 2A0FAS2, 2A1FAS2G, 2A1FASG, 2A1TPSG, 2D0FAS2, 2D1FAS2G, 2D1FASG, 2D1TPSG, 31, 31GE, 31TC, 32, 32TC, 32TP, 32TPV, 32V...(Other models you can see in the webshop)		
accessories for	103013		
	GEV No.	104014	Ref. No. 34A1100
	burner head for burner cap ø 90mm		
	GEV No.	104018	Ref. No. 36D0070
	burner holder for burner cap ø 60/90/110mm with nozzle holder gas inlet M20x1.5		



Table continues overleaf





accessories for 103013					
	<table border="1"> <tr> <th>GEV No.</th> <td>104020</td> <th>Ref. No.</th> <td>34A1380</td> </tr> </table> <p>burner head for burner cap ø 90mm</p>	GEV No.	104020	Ref. No.	34A1380
GEV No.	104020	Ref. No.	34A1380		
	<table border="1"> <tr> <th>GEV No.</th> <td>104023</td> <th>Ref. No.</th> <td>36D2771</td> </tr> </table> <p>burner holder seat ø 35mm with nozzle holder</p>	GEV No.	104023	Ref. No.	36D2771
GEV No.	104023	Ref. No.	36D2771		



			
1			
GEV No.	103055	Ref. No.	34A0530
description	burner cap ø 95mm with central hole		



			
1			
GEV No.	104015	Ref. No.	34A1110
description	burner head for burner cap ø 110mm		



											
1											
GEV No.	104026	Ref. No.	34A0090								
description	burner head for burner cap ø 110mm										
accessories for	104026										
	<table border="1"> <tr> <th>GEV No.</th> <td>103014</td> <th>Ref. No.</th> <td>34A0050</td> </tr> </table> <p>burner cap ø 110mm</p>	GEV No.	103014	Ref. No.	34A0050		<table border="1"> <tr> <th>GEV No.</th> <td>104018</td> <th>Ref. No.</th> <td>36D0070</td> </tr> </table> <p>burner holder for burner cap ø 60/90/110mm with nozzle holder gas inlet M20x1.5</p>	GEV No.	104018	Ref. No.	36D0070
GEV No.	103014	Ref. No.	34A0050								
GEV No.	104018	Ref. No.	36D0070								

			
1			
GEV No.	104016	Ref. No.	34A1090 34A6760
description	burner head for burner cap ø 140mm		

			
1			
GEV No.	104013	Ref. No.	34A0570
description	burner head for burner cap ø 60mm		

							
1							
GEV No.	104024	Ref. No.	34A0060				
description	burner head for burner cap ø 60mm						
accessories for	104024						
	<table border="1"> <tr> <th>GEV No.</th> <td>104018</td> <th>Ref. No.</th> <td>36D0070</td> </tr> </table> <p>burner holder for burner cap ø 60/90/110mm with nozzle holder gas inlet M20x1.5</p>	GEV No.	104018	Ref. No.	36D0070		
GEV No.	104018	Ref. No.	36D0070				

											
1											
GEV No.	104014	Ref. No.	34A1100								
description	burner head for burner cap ø 90mm										
accessories for	104014										
	<table border="1"> <tr> <th>GEV No.</th> <td>103013</td> <th>Ref. No.</th> <td>34A0740 34A1120 34A1121 34A1123</td> </tr> </table> <p>burner cap ø 90mm</p>	GEV No.	103013	Ref. No.	34A0740 34A1120 34A1121 34A1123		<table border="1"> <tr> <th>GEV No.</th> <td>104018</td> <th>Ref. No.</th> <td>36D0070</td> </tr> </table> <p>burner holder for burner cap ø 60/90/110mm with nozzle holder gas inlet M20x1.5</p>	GEV No.	104018	Ref. No.	36D0070
GEV No.	103013	Ref. No.	34A0740 34A1120 34A1121 34A1123								
GEV No.	104018	Ref. No.	36D0070								

											
1											
GEV No.	104025	Ref. No.	34A0080								
description	burner head for burner cap ø 90mm										
accessories for	104025										
	<table border="1"> <tr> <th>GEV No.</th> <td>103012</td> <th>Ref. No.</th> <td>34A0040</td> </tr> </table> <p>burner cap ø 90mm</p>	GEV No.	103012	Ref. No.	34A0040		<table border="1"> <tr> <th>GEV No.</th> <td>104018</td> <th>Ref. No.</th> <td>36D0070</td> </tr> </table> <p>burner holder for burner cap ø 60/90/110mm with nozzle holder gas inlet M20x1.5</p>	GEV No.	104018	Ref. No.	36D0070
GEV No.	103012	Ref. No.	34A0040								
GEV No.	104018	Ref. No.	36D0070								



							
1							
GEV No.	104019	Ref. No.	36D1230				
description	burner holder for burner cap ø 140mm gas inlet M20x1.5						
accessories for	104019						
	<table border="1"> <tr> <th>GEV No.</th> <td>103016</td> <th>Ref. No.</th> <td>34A1140 34A1141</td> </tr> </table> <p>burner cap ø 140mm</p>	GEV No.	103016	Ref. No.	34A1140 34A1141		
GEV No.	103016	Ref. No.	34A1140 34A1141				

Table continues overleaf

accessories for 104019				
	GEV No.	104016	Ref. No.	34A1090 34A6760
burner head for burner cap ø 140mm				





GEV No.	104018	Ref. No.	36D0070	
description	burner holder for burner cap ø 60/90/110mm with nozzle holder gas inlet M20x1.5			

accessories for 104018				
	GEV No.	103012	Ref. No.	34A0040
burner cap ø 90mm				

	GEV No.	103013	Ref. No.	34A0740 34A1120 34A1121 34A1123
burner cap ø 90mm				

	GEV No.	103014	Ref. No.	34A0050
burner cap ø 110mm				

	GEV No.	103015	Ref. No.	34A1130 34A1131 34A1133
burner cap ø 110mm				

	GEV No.	104014	Ref. No.	34A1100
burner head for burner cap ø 90mm				

	GEV No.	104025	Ref. No.	34A0080
burner head for burner cap ø 90mm				

	GEV No.	104026	Ref. No.	34A0090
burner head for burner cap ø 110mm				



GEV No.	104017	Ref. No.	36D0060	
description	burner holder with nozzle holder gas inlet 1/4"			

Delta, Junior (2), Omega, Senior series



GEV No.	103015	Ref. No.	34A1130 34A1131 34A1133	
description	burner cap ø 110mm			

For models: 030, 031, 032, 0712D, 071D, 071DGG, 072D, 072DGG, 091, 091GG, 092, 092GG, 092VA, 092VAGG, 1A0FAS, 1B0FAS, 1B1FASG, 1D0FAS, 1D1FASG, 2A0FAS2, 2A1FAS2G, 2D0FAS2, 2D1FAS2G, 2D1FASG, 31, 31GE, 31TC, 32, 32TC, 32TP, 32TPV, 32V, 3D1FASG, 712D, 71D, 71DGG, 71GE, 71GEGG, 72D, 72DGG, 72VA, 72VAGG, 72VAS, 72VASGG, 73D, 73DGG, 73VA, 73VAD, 73VADGG, 73VAGG

accessories for 103015				
	GEV No.	104015	Ref. No.	34A1110
burner head for burner cap ø 110mm				

	GEV No.	104018	Ref. No.	36D0070
burner holder for burner cap ø 60/90/110mm with nozzle holder gas inlet M20x1.5				





GEV No.	103016	Ref. No.	34A1140 34A1141	
description	burner cap ø 140mm			

For models: 070D, 070DGG, 0712D, 0712VA, 071D, 071DGG, 072D, 072DGG, 090, 090GG, 091, 091GG, 092, 092GG, 092VA, 092VAGG, 0A0FAS, 0B0FAS, 0D0FAS, 1A0FAS, 1A0FAS2, 1A1FAS2G, 1A1FASG, 1B0FAS, 1B0FAS2, 1B1FAS2G, 1B1FASG, 1D0FAS, 1D0FAS2, 1D1FAS2G, 1D1FASG, 2A0FAS2, 2A1FAS2G, 2A1FASG, 2A1TPSG, 2D0FAS2, 2D1FAS2G, 2D1FASG, 2D1TPSG, 3A1FASG, 3D1FASG, 712D, 712VA, 71D, 71DGG, 71GE, 71GEGG, 72D, 72DGG, 72TP...(Other models you can see in the webshop)

accessories for 103016				
	GEV No.	104016	Ref. No.	34A1090 34A6760
burner head for burner cap ø 140mm				

	GEV No.	104019	Ref. No.	36D1230
burner holder for burner cap ø 140mm gas inlet M20x1.5				

	GEV No.	104022	Ref. No.	34A1401
burner head ø 139.5mm seat ø 122.8mm for burner cap ø 140mm int. ø 1 92.8mm int. ø 2 85.2mm				

	GEV No.	104023	Ref. No.	36D2771
burner holder seat ø 35mm with nozzle holder				



GEV No.	103011	Ref. No.	34A0750 34A1580	
description	burner cap ø 60mm			





accessories for 103011				
	GEV No.	104013	Ref. No.	34A0570
burner head for burner cap ø 60mm				

Table continues overleaf



accessories for 103011					
	<table border="1"> <tr> <th>GEV No.</th> <td>104018</td> <th>Ref. No.</th> <td>36D0070</td> </tr> </table> <p>burner holder for burner cap ø 60/90/110mm with nozzle holder gas inlet M20x1.5</p>	GEV No.	104018	Ref. No.	36D0070
GEV No.	104018	Ref. No.	36D0070		

 <p>1</p>							
GEV No.	103013	Ref. No.	34A0740 34A1120 34A1121 34A1123				
description	burner cap ø 90mm						
For models:	030, 031, 032, 070D, 070DGG, 0712D, 0712VA, 071D, 071DGG, 072D, 072DGG, 090, 090GG, 091, 091GG, 092, 092GG, 092VA, 092VAGG, 0A0FAS, 0B0FAS, 0D0FAS, 1A0FAS, 1A0FAS2, 1A1FAS2G, 1A1FASG, 1B0FAS, 1B0FAS2, 1B1FAS2G, 1B1FASG, 1D0FAS, 1D0FAS2, 1D1FAS2G, 1D1FASG, 2A0FAS2, 2A1FAS2G, 2A1FASG, 2A1TPSG, 2D0FAS2, 2D1FAS2G, 2D1FASG, 2D1TPSG, 31, 31GE, 31TC, 32, 32TC, 32TP, 32TPV, 32V...(Other models you can see in the webshop)						
accessories for 103013							
	<table border="1"> <tr> <th>GEV No.</th> <td>104014</td> <th>Ref. No.</th> <td>34A1100</td> </tr> </table> <p>burner head for burner cap ø 90mm</p>	GEV No.	104014	Ref. No.	34A1100		
GEV No.	104014	Ref. No.	34A1100				
	<table border="1"> <tr> <th>GEV No.</th> <td>104018</td> <th>Ref. No.</th> <td>36D0070</td> </tr> </table> <p>burner holder for burner cap ø 60/90/110mm with nozzle holder gas inlet M20x1.5</p>	GEV No.	104018	Ref. No.	36D0070		
GEV No.	104018	Ref. No.	36D0070				
	<table border="1"> <tr> <th>GEV No.</th> <td>104020</td> <th>Ref. No.</th> <td>34A1380</td> </tr> </table> <p>burner head for burner cap ø 90mm</p>	GEV No.	104020	Ref. No.	34A1380		
GEV No.	104020	Ref. No.	34A1380				
	<table border="1"> <tr> <th>GEV No.</th> <td>104023</td> <th>Ref. No.</th> <td>36D2771</td> </tr> </table> <p>burner holder seat ø 35mm with nozzle holder</p>	GEV No.	104023	Ref. No.	36D2771		
GEV No.	104023	Ref. No.	36D2771				

 <p>1</p>							
GEV No.	104021	Ref. No.	34A1390 34A1391				
description	burner head for burner cap ø 110mm						
For models:	030, 031, 032, 0712D, 071D, 071DGG, 072D, 072DGG, 091, 091GG, 092, 092GG, 092VA, 092VAGG, 1A0FAS, 1B0FAS, 1B1FASG, 1D0FAS, 1D1FASG, 2A0FAS2, 2A1FAS2G, 2D0FAS2, 2D1FAS2G, 2D1FASG, 31, 31GE, 31TC, 32, 32TC, 32TP, 32TPV, 32V, 3D1FASG, 712D, 71D, 71DGG, 71GE, 71GEGG, 72D, 72DGG, 72VA, 72VAGG, 72VAS, 72VASGG, 73D, 73DGG, 73VA, 73VAD, 73VADGG, 73VAGG						
accessories for 104021							
	<table border="1"> <tr> <th>GEV No.</th> <td>103015</td> <th>Ref. No.</th> <td>34A1130 34A1131 34A1133</td> </tr> </table> <p>burner cap ø 110mm</p>	GEV No.	103015	Ref. No.	34A1130 34A1131 34A1133		
GEV No.	103015	Ref. No.	34A1130 34A1131 34A1133				
	<table border="1"> <tr> <th>GEV No.</th> <td>104023</td> <th>Ref. No.</th> <td>36D2771</td> </tr> </table> <p>burner holder seat ø 35mm with nozzle holder</p>	GEV No.	104023	Ref. No.	36D2771		
GEV No.	104023	Ref. No.	36D2771				

 <p>1</p>							
GEV No.	103053	Ref. No.	34A1570				
description	burner head for burner cap ø 60mm						
accessories for 103053							
	<table border="1"> <tr> <th>GEV No.</th> <td>103011</td> <th>Ref. No.</th> <td>34A0750 34A1580</td> </tr> </table> <p>burner cap ø 60mm</p>	GEV No.	103011	Ref. No.	34A0750 34A1580		
GEV No.	103011	Ref. No.	34A0750 34A1580				

 <p>1</p>							
GEV No.	104020	Ref. No.	34A1380				
description	burner head for burner cap ø 90mm						
For models:	030, 031, 032, 070D, 070DGG, 0712D, 0712VA, 071D, 071DGG, 072D, 072DGG, 090, 090GG, 091, 091GG, 092, 092GG, 092VA, 092VAGG, 0A0FAS, 0B0FAS, 0D0FAS, 1A0FAS, 1A0FAS2, 1A1FAS2G, 1A1FASG, 1B0FAS, 1B0FAS2, 1B1FAS2G, 1B1FASG, 1D0FAS, 1D0FAS2, 1D1FAS2G, 1D1FASG, 2A0FAS2, 2A1FAS2G, 2A1FASG, 2A1TPSG, 2D0FAS2, 2D1FAS2G, 2D1FASG, 2D1TPSG, 31, 31GE, 31TC, 32, 32TC, 32TP, 32TPV, 32V...(Other models you can see in the webshop)						
accessories for 104020							
	<table border="1"> <tr> <th>GEV No.</th> <td>103013</td> <th>Ref. No.</th> <td>34A0740 34A1120 34A1121 34A1123</td> </tr> </table> <p>burner cap ø 90mm</p>	GEV No.	103013	Ref. No.	34A0740 34A1120 34A1121 34A1123		
GEV No.	103013	Ref. No.	34A0740 34A1120 34A1121 34A1123				
	<table border="1"> <tr> <th>GEV No.</th> <td>104023</td> <th>Ref. No.</th> <td>36D2771</td> </tr> </table> <p>burner holder seat ø 35mm with nozzle holder</p>	GEV No.	104023	Ref. No.	36D2771		
GEV No.	104023	Ref. No.	36D2771				

			
1			
GEV No.	104022	Ref. No.	34A1401
description	burner head ø 139.5mm seat ø 122.8mm for burner cap ø 140mm int. ø 1 92.8mm int. ø 2 85.2mm		
For models:	070D, 070DGG, 0712D, 0712VA, 071D, 071DGG, 072D, 072DGG, 090, 090GG, 091, 091GG, 092, 092GG, 092VA, 092VAGG, 0A0FAS, 0B0FAS, 0D0FAS, 1A0FAS, 1A0FAS2, 1A1FAS2G, 1A1FASG, 1B0FAS, 1B0FAS2, 1B1FAS2G, 1B1FASG, 1D0FAS, 1D0FAS2, 1D1FAS2G, 1D1FASG, 2A0FAS2, 2A1FAS2G, 2A1FASG, 2A1TPSG, 2D0FAS2, 2D1FAS2G, 2D1FASG, 2D1TPSG, 3A1FASG, 3D1FASG, 712D, 712VA, 71D, 71DGG, 71GE, 71GEGG, 72D, 72DGG, 72TP...(Other models you can see in the webshop)		
accessories for	104022		
	GEV No.	103016	Ref. No. 34A1140 34A1141
	burner cap ø 140mm		
	GEV No.	104023	Ref. No. 36D2771
	burner holder seat ø 35mm with nozzle holder		

			
1			
GEV No.	104023	Ref. No.	36D2771
description	burner holder seat ø 35mm with nozzle holder		
For models:	030, 031, 032, 070D, 070DGG, 0712D, 0712VA, 071D, 071DGG, 072D, 072DGG, 090, 090GG, 091, 091GG, 092, 092GG, 092VA, 092VAGG, 0A0FAS, 0B0FAS, 0D0FAS, 1A0FAS, 1A0FAS2, 1A1FAS2G, 1A1FASG, 1B0FAS, 1B0FAS2, 1B1FAS2G, 1B1FASG, 1D0FAS, 1D0FAS2, 1D1FAS2G, 1D1FASG, 2A0FAS2, 2A1FAS2G, 2A1FASG, 2A1TPSG, 2D0FAS2, 2D1FAS2G, 2D1FASG, 2D1TPSG, 31, 31GE, 31TC, 32, 32TC, 32TP, 32TPV, 32V...(Other models you can see in the webshop)		
accessories for	104023		
	GEV No.	103013	Ref. No. 34A0740 34A1120 34A1121 34A1123
	burner cap ø 90mm		
	GEV No.	103015	Ref. No. 34A1130 34A1131 34A1133
	burner cap ø 110mm		
	GEV No.	103016	Ref. No. 34A1140 34A1141
	burner cap ø 140mm		
	GEV No.	104020	Ref. No. 34A1380
	burner head for burner cap ø 90mm		
	GEV No.	104021	Ref. No. 34A1390 34A1391
	burner head for burner cap ø 110mm		
	GEV No.	104022	Ref. No. 34A1401
	burner head ø 139.5mm seat ø 122.8mm for burner cap ø 140mm int. ø 1 92.8mm int. ø 2 85.2mm		

solid tops			
			
1			
GEV No.	105333	Ref. No.	34A0120
description	round burner ø 260mm for solid top		
For models:	071TP, 091TP, 71TP, 72TP, 72TPGG		

pan supports			
			
1			
GEV No.	210100	Ref. No.	36A0110
description	pan support W 312mm L 632mm		

			
1			
GEV No.	210101	Ref. No.	36A2600
description	pan support W 315mm L 315mm for 700		
For models:	030, 031, 032, 31, 31GE, 31TC, 32, 32TC, 32TP, 32TPV, 32V		

			
1			
GEV No.	210247	Ref. No.	36A4970 36A4971
description	pan support W 345mm L 585mm		
For models:	0G0FA0, 1G0FA0, 1G0FA0B, 1G1FA0E, 1G1FA0EV, 1G1FA0G, 1G1FA0GV, 1G1FABG, 1G1FAPG, 2G0FA0, 2G0FA0A, 2G0FA0B, 2G1FA0E, 2G1FA0G, 2G1FA0GV, 2G1FABG, 2G1FACG, 2G1FADG, 2G1FADGV, 2G1FAPG, 2G1TP3G		



1

GEV No.	210261	Ref. No.	36A2001 36A2002 6029680
description	pan support W 365mm L 395mm H 75mm		
For models:	04WFAAV, 08WFA4E, 08WFA4G, 08WFAAE, 08WFAAG, 08WFAAV, 090FAA, 0A0FA1, 0A0FA4, 0A0FAA, 0D0FA1, 0D0FA4, 0D0FAA, 12WFA6E, 12WFA6G, 12WFAAA, 12WFAAE, 12WFAAG, 12WFAAN, 190FA, 190FAA, 190FAB, 190FAD, 191FAAE, 191FAAG, 191FABG, 191FADG, 191FAE, 191FAG, 1A0FA1, 1A0FA2, 1A0FA4, 1A0FA5, 1A0FAA, 1A0FAB, 1A1FA1G, 1A1FA2G, 1A1FA4G, 1A1FA5G, 1A1FAAG, 1A1FABG, 1D0FA1, 1D0FA2, 1D0FA4, 1D0FA5, 1D0FAA, 1D0FAB, 1D1FA1G, 1D1FA2G, 1D1FA4G...(Other models you can see in the webshop)		

2

GEV No.	210179	Ref. No.	36A2610
description	pan support W 370mm L 370mm		
For models:	070DGG, 0712D, 0712VA, 071DGG, 072DGG, 090GG, 091GG, 092GG, 092VAGG, 0A0FAS, 0B0FAS, 0D0FAS, 1A0FAS, 1A0FAS2, 1A1FAS2G, 1A1FASG, 1B0FAS, 1B0FAS2, 1B1FAS2G, 1B1FASG, 1D0FAS, 1D0FAS2, 1D1FAS2G, 1D1FASG, 2A0FAS2, 2A1FAS2G, 2A1FASG, 2A1TPSG, 2D0FAS2, 2D1FAS2G, 2D1FASG, 2D1TPSG, 3A1FASG, 3D1FASG, 712D, 712VA, 71DGG, 71GEGG, 72DGG, 72TPGG, 72VAGG, 72VASGG, 73DGG, 73VADGG, 73VAGG		

reducers for pan supports

1

GEV No.	210005	Ref. No.	3012090 36A0491
description	reducer for pan support L 205mm W 205mm chrome-plated steel suitable for ANGELO PO		

1

GEV No.	210006	Ref. No.	36A2160 36A5450
description	reducer for pan support L 385mm W 190mm Qty 2 pcs		

solid tops

1

GEV No.	103152	Ref. No.	36A0350
description	burner cap ø 125mm cast iron		
For models:	0712VA, 090FAVA, 092VA, 092VAGG, 0A0FAVA, 0D0FAVA, 190FAB, 191FABG, 1A0FA2, 1A0FA5, 1A0FAB, 1A0FAS2, 1A1FA2G, 1A1FA5G, 1A1FABG, 1A1FAS2G, 1B0FAS2, 1B1FAS2G, 1D0FA2, 1D0FA5, 1D0FAB, 1D0FAS2, 1D1FA2G, 1D1FA5G, 1D1FABG, 1D1FAS2G, 2A0FAS2, 2A1FAS2G, 2D0FAS2, 2D1FAS2G, 712VA, 72VA, 72VAGG, 72VAS, 72VASGG, 73VA, 73VAD, 73VADGG, 73VAGG		

miscellaneous

1

GEV No.	104324	Ref. No.	31V0240 31V0241
description	pin ø 7.4mm L 22mm WS 8 thread M5		
For models:	04WFAAV, 08WFA4E, 08WFA4G, 08WFAAE, 08WFAAG, 08WFAAV, 090FAA, 0A0FA1, 0A0FA4, 0A0FAA, 0D0FA1, 0D0FA4, 0D0FAA, 0G0FA0, 12WFA6E, 12WFA6G, 12WFAAA, 12WFAAE, 12WFAAG, 12WFAAN, 190FA, 190FAA, 190FAB, 190FAD, 191FAAE, 191FAAG, 191FABG, 191FADG, 191FAE, 191FAG, 1A0FA1, 1A0FA2, 1A0FA4, 1A0FA5, 1A0FAA, 1A0FAB, 1A1FA1G, 1A1FA2G, 1A1FA4G, 1A1FA5G, 1A1FAAG, 1A1FABG, 1D0FA1, 1D0FA2, 1D0FA4, 1D0FA5, 1D0FAA, 1D0FAB, 1D1FA1G, 1D1FA2G...(Other models you can see in the webshop)		

accessories

reducers for pan supports

1

GEV No.	210005	Ref. No.	3012090 36A0491
description	reducer for pan support L 205mm W 205mm chrome-plated steel suitable for ANGELO PO		

1

GEV No.	210006	Ref. No.	36A2160 36A5450
description	reducer for pan support L 385mm W 190mm Qty 2 pcs		

pan supports



1

GEV No.	210100	Ref. No.	36A0110
description	pan support W 312mm L 632mm		



1

GEV No.	210101	Ref. No.	36A2600
description	pan support W 315mm L 315mm for 700		
For models:	030, 031, 032, 31, 31GE, 31TC, 32, 32TC, 32TP, 32TPV, 32V		



1

GEV No.	210247	Ref. No.	36A4970 36A4971
description	pan support W 345mm L 585mm		
For models:	0G0FA0, 1G0FA0, 1G0FA0B, 1G1FA0E, 1G1FA0EV, 1G1FA0G, 1G1FA0GV, 1G1FABG, 1G1FAPG, 2G0FA0, 2G0FA0A, 2G0FA0B, 2G1FA0E, 2G1FA0G, 2G1FA0GV, 2G1FABG, 2G1FACG, 2G1FADG, 2G1FADGV, 2G1FAPG, 2G1TP3G		



1

GEV No.	210261	Ref. No.	36A2001 36A2002 6029680
description	pan support W 365mm L 395mm H 75mm		
For models:	04WFAAV, 08WFA4E, 08WFA4G, 08WFAAE, 08WFAAG, 08WFAAV, 090FAA, 0A0FA1, 0A0FA4, 0A0FAA, 0D0FA1, 0D0FA4, 0D0FAA, 12WFA6E, 12WFA6G, 12WFAAA, 12WFAAE, 12WFAAG, 12WFAAN, 190FA, 190FAA, 190FAB, 190FAD, 191FAAE, 191FAAG, 191FABG, 191FADG, 191FAE, 191FAG, 1A0FA1, 1A0FA2, 1A0FA4, 1A0FA5, 1A0FAA, 1A0FAB, 1A1FA1G, 1A1FA2G, 1A1FA4G, 1A1FA5G, 1A1FAAG, 1A1FABG, 1D0FA1, 1D0FA2, 1D0FA4, 1D0FA5, 1D0FAA, 1D0FAB, 1D1FA1G, 1D1FA2G, 1D1FA4G...(Other models you can see in the webshop)		



1

GEV No.	210179	Ref. No.	36A2610
description	pan support W 370mm L 370mm		
For models:	070DGG, 0712D, 0712VA, 071DGG, 072DGG, 090GG, 091GG, 092GG, 092VAGG, 0A0FAS, 0B0FAS, 0D0FAS, 1A0FAS, 1A0FAS2, 1A1FAS2G, 1A1FASG, 1B0FAS, 1B0FAS2, 1B1FAS2G, 1B1FASG, 1D0FAS, 1D0FAS2, 1D1FAS2G, 1D1FASG, 2A0FAS2, 2A1FAS2G, 2A1FASG, 2A1TPSG, 2D0FAS2, 2D1FAS2G, 2D1FASG, 2D1TPSG, 3A1FASG, 3D1FASG, 712D, 712VA, 71DGG, 71GEGG, 72DGG, 72TPGG, 72VAGG, 72VASGG, 73DGG, 73VADGG, 73VAGG		

air mixers



1

GEV No.	102200	Ref. No.	36C1210
description	air mixing tube L 27mm D1 ø 24mm D2 ø 20mm ID ø 15mm thickness 2.6mm		
For models:	0A0GRG, 0D0GRG, 1A0GRG, 1D0GRG		

bar burners

bar burners



1

GEV No.	104760	Ref. No.	34A2520 34A2521
description	bar burner 2 row L 370mm W 200mm ømm H 45mm 6kW chargrill		
For models:	1G0GRG		



1

GEV No.	105345	Ref. No.	34A0350
description	bar burner 2 row L 525mm W 167mm ømm H 50mm pasta cooker		
For models:	0A1CP1G, 0B1CP1G, 0D1CP1G, 191CP1G, 1A1CP1G, 1A1CP2G, 1D1CP1G, 1D1CP2G		



			
1			
GEV No.	105373	Ref. No.	34A2080 34A2081 34A2082
description	bar burner 2 row L 560mm W 220mm ømm 9kW chargrill		
For models:	08WGRGV, 090GRG, 0A0GRG, 0D0GRG, 190GRG, 1A0GRG, 1D0GRG, 6042120-08WGRGV		

			
1			
GEV No.	105334	Ref. No.	34A0900
description	bar burner 4 row L 545mm W 300mm ømm 12kW solid top		
For models:	190TP0, 191TPG, 1A0TP0, 1A1FASG, 1A1TP0G, 1A1TP0G-VERS.2002, 1B0TP0, 1D0TP0, 1D1TP0G, 1D1TP0G-VERS.2002, 291TPCG, 2A1FASG, 2A1TP3G, 2A1TP6G, 2A1TPCG, 2A1TPSG, 2D1TP3G, 2D1TP6G, 2D1TPCG, 2D1TPSG, 3A1FASG		

			
1			
GEV No.	104163	Ref. No.	34A0580
description	bar burner 2 row L 600mm W 300mm ømm griddle		
For models:	071FT, 071FTR, 071FTRL, 091FT, 091FTR, 091FTRL		

			
1			
GEV No.	105369	Ref. No.	34A0730
description	bar burner 6 row L 445mm W 620mm ømm tilting bratt pan		
For models:	71RA, 91RA		

			
1			
GEV No.	105339	Ref. No.	34A0110
description	bar burner 3 row L 460mm W 280mm ømm H 90mm griddle		
For models:	031FT04, 031FT06, 08WFT1GV, 08WFT2GV, 08WFT3GV, 08WFT4GV, 08WFT6GV, 08WFT7GV, 0G0FT1G, 0G0FT1G-VERS.032008, 0G0FT2G, 0G0FT2G-VERS.032008, 0G0FT4G, 0G0FT4G-VERS.032008, 0G0FT5G, 0G0FT5G-VERS.032008, 0G0FT7G, 1G0FT1G, 1G0FT1G-VERS.032008, 1G0FT2G, 1G0FT2G-VERS.032008, 1G0FT3G, 1G0FT3G-VERS.032008, 1G0FT4G, 1G0FT4G-VERS.032008, 1G0FT6E, 1G0FT6G, 1G0FT6G-VERS.032008, 1G0FT7G, 6040560, 6042490, 6042500, 6043200		

			
1			
GEV No.	105335	Ref. No.	34A1520
description	bar burner angled L 605mm W 247mm ømm Hmm oven		
For models:	31, 31TC, 31TP, 32, 32TC, 32TP, 32TPV, 32V		

			
1			
GEV No.	105337	Ref. No.	34A1880
description	bar burner angled L 765mm W 345mm ømm Hmm oven		
For models:	191FAAG, 191FABG, 191FADG, 191TPG, 1A1FA1G, 1A1FA2G, 1A1FA4G, 1A1FASG, 1A1FAAG, 1A1FABG, 1A1FAS2G, 1A1FASG, 1A1TP0G, 1A1TP0G-VERS.2002, 1D1FA1G, 1D1FA2G, 1D1FA4G, 1D1FA5G, 1D1FAAG, 1D1FABG, 1D1FAS2G, 1D1FASG, 1D1TP0G, 1D1TP0G-VERS.2002, 291FAG, 291TPCG, 2A1FA1G, 2A1FA4G, 2A1FAAG, 2A1FAS2G, 2A1FASG, 2A1TP3G, 2A1TP6G, 2A1TPCG, 2A1TPSG, 2D1FA1G, 2D1FA4G, 2D1FAAG, 2D1FAS2G, 2D1FASG, 2D1TP3G, 2D1TP6G, 2D1TPCG, 2D1TPSG, 391FAG, 3A1FA1G, 3A1FA4G, 3A1FAAG, 3A1FASG, 3D1FA1G...(Other models you can see in the webshop)		

			
1			
GEV No.	105343	Ref. No.	34A1840 34A1841
description	bar burner 3 row L 585mm W 270mm ømm griddle		
For models:	070FT04, 070FT05, 071FT04, 071FT06, 090FT04, 090FT05, 090FT1G, 090FT2G, 090FT4G, 090FT5G, 090FT7G, 091FT04, 091FT06, 0A0FT1G, 0A0FT2G, 0A0FT4G, 0A0FT5G, 0B0FT1G, 0B0FT2G, 0B0FT4G, 0B0FT5G, 0D0FT1G, 0D0FT2G, 0D0FT4G, 0D0FT5G, 190FT15G, 190FT1G, 190FT2G, 190FT3G, 190FT42G, 190FT4G, 190FT6G, 190FT72G, 190FT7G, 1A0FT1G, 1A0FT2G, 1A0FT3G, 1A0FT4G, 1A0FT6G, 1B0FT1G, 1B0FT2G, 1B0FT3G, 1B0FT4G, 1B0FT6G, 1D0FT1G, 1D0FT2G, 1D0FT3G, 1D0FT4G, 1D0FT6G		

			
1			
GEV No.	105279	Ref. No.	34A1370
description	bar burner angled L 770mm W 345mm ømm Hmm oven		
For models:	71D, 71DGG, 71TP, 72D, 72DGG, 72TP, 72TPGG, 72VA, 72VAGG, 72VAS, 72VASGG, 73D, 73DGG, 73VA, 73VAD, 73VADGG, 73VAGG, FS30		

			
1			
GEV No.	105304	Ref. No.	34A1640 34A1641
description	bar burner ø 27mm Wmm Hmm L 425mm salamander grill		
For models:	60SM		



GEV No.	105347	Ref. No.	34A1510
description	bar burner ø 27mm Wmm Hmm L 440mm bain marie		
For models:	090BM1G, 0A0BMG, 0D0BMG		



GEV No.	107843	Ref. No.	34A0500
description	bar burner ø 50mm L 550mm flange width 57mm flange length 57mm 15kW combi-steamer		
For models:	FC241G, FCV241G, FCV241G-CSA, FCV241GDM, FCV241GDM-CSA, FCV241GDS, FCV241GDS-CSA, FCV401DM, FCV401DM-CSA		



GEV No.	105502	Ref. No.	34A1690 34A1690-2
description	bar burner ø 50mm Wmm Hmm L 424mm convection oven		
For models:	FC101, FCV101, FCV101-CSA, FCV101DM, FCV101DM-CSA, FCV101DS, FCV101DS-CSA		



GEV No.	105697	Ref. No.	34A2310
description	bar burner ø 50mm Wmm Hmm L 450mm with bolt M5x12 flange width 65mm flange length 71mm kettle		



GEV No.	105372	Ref. No.	34A1850
description	bar burner ømm kettle		
For models:	1G1PD1G, 1G1PI1G, 31PD6, 31PI6		



GEV No.	105367	Ref. No.	34A1790 34A1793
description	bar burner ømm tilting bratt pan		
For models:	1G1BR1G, 31R		



GEV No.	105368	Ref. No.	34A1480
description	bar burner ømm tilting bratt pan		
For models:	71AR, 91AR		



GEV No.	104136	Ref. No.	34A0230
description	bar burner ømm W 28mm H 42mm L 335mm flange width 35mm flange length 80mm kettle		
For models:	71PD10, 71PD15, 71PI10, 71PI10A, 91PI10, 91PI10A		





GEV No.	104162	Ref. No.	34A1461
description	bar burner T-shape L 560mm Wmm ø 40mm solid top		
For models:	070FT, 070FTR, 0712VA, 090FAVA, 090FT, 090FTR, 092VA, 092VAGG, 0A0FAVA, 0D0FAVA, 190FAB, 191FABG, 1A0FA2, 1A0FA5, 1A0FAB, 1A0FAS2, 1A1FA2G, 1A1FA5G, 1A1FABG, 1A1FAS2G, 1B0FAS2, 1B1FAS2G, 1D0FA2, 1D0FA5, 1D0FAB, 1D0FAS2, 1D1FA2G, 1D1FA5G, 1D1FABG, 1D1FAS2G, 2A0FAS2, 2A1FAS2G, 2D0FAS2, 2D1FAS2G, 712VA, 72VA, 72VAGG, 72VAS, 72VASGG, 73VA, 73VAD, 73VADGG, 73VAGG		





GEV No.	105346	Ref. No.	34A1450
description	bar burner U-shape L 610mm W 205mm ømm Hmm bain marie		
For models:	070BM, 071BM, 090BM, 091BM		





			
1			
GEV No.	105370	Ref. No.	34A1430 34A1431
description	burner ømm tilting bratt pan		
For models:	1A1BR1G, 1A1BR1GA, 1A1BR2G, 1A1BR2GA, 1D1BR1G, 1D1BR1GA, 1D1BR2G, 1D1BR2GA		

			
1			
GEV No.	105371	Ref. No.	34A1890 34A1891
description	burner ømm tilting bratt pan		
For models:	2A1BR1G, 2A1BR1GA, 2A1BR2G, 2A1BR2GA, 2D1BR1G, 2D1BR1GA, 2D1BR2G, 2D1BR2GA		

			
1			
GEV No.	211057	Ref. No.	3193150 36A5540
description	lava rock grid L 419mm W 282mm H 23.2mm suitable for ANGELO PO		
For models:	1G0GRG		

			
1			
GEV No.	211000	Ref. No.	36A4230 36A5290
description	lava rock grid L 600mm W 330mm H 22mm		
For models:	0A0GRG, 0D0GRG, 1A0GRG, 1D0GRG		
accessories for	211000		
	GEV No.	693000	Ref. No. 35Y2780
spring for lava rock grid			

lava rock grids

			
1			
GEV No.	211000	Ref. No.	36A4230 36A5290
description	lava rock grid L 600mm W 330mm H 22mm		
For models:	0A0GRG, 0D0GRG, 1A0GRG, 1D0GRG		
accessories for	211000		
	GEV No.	693000	Ref. No. 35Y2780
spring for lava rock grid			

tube burners

			
1			
GEV No.	105401	Ref. No.	3007720 34A2120
description	burner L 300mm W 75mm H 42mm for fryer		
For models:	06WFR3GD, 091FR1G, 091FR1GD, 091FR11, 091FR11A, 091FR11D, 091FR11D-VERS.052012, 091FR11-VERS.032012, 091FR3G, 091FR3GD, 0A1FR1GD-VERS.2004, 0A1FR1G-VERS.2004, 0A1FR3G, 0A1FR3GD, 0D1FR1GD-VERS.2004, 0D1FR1G-VERS.2004, 0D1FR3G, 0D1FR3GD, 0G1FR3G, 0G1FR3GD, 10WFR4GD, 191FR2G, 191FR2GD, 191FR2I, 191FR2ID, 191FR2ID-VERS.092012, 191FR2I-VERS.032012, 191FR4G, 191FR4GD, 1A1FR2GD-VERS.2004, 1A1FR2G-VERS.2004, 1A1FR4G, 1A1FR4GD, 1D1FR2GD-VERS.2004, 1D1FR2G-VERS.2004, 1D1FR4G, 1D1FR4GD, 1G1FR4G, 1G1FR4GD		

			
1			
GEV No.	105344	Ref. No.	34A1670
description	tubular burner L 305mm W 55mm H 63mm for fryer/pasta cooker oval		
For models:	0A1FR1G, 0A1FR1GD, 0B1FR1G, 0B1FR1GD, 0D1FR1G, 0D1FR1GD, 1A1FR2G, 1A1FR2GD, 1D1FR2G, 1D1FR2GD, 30CPS, 30F1, 30F1B, 30FS2, 30FS2B, 70CP, 70F1, 70F1B, 71CP, 71CP2, 71F2, 71F2B, 90CP, 90F110B, 91CP, 91F210, 91F210B, 91F223B		

solid top burners

			
1			
GEV No.	105332	Ref. No.	34A1650
description	solid top burner ø 162mm H 117mm L 330mm		
For models:	031TP, 1G0TP0, 1G1TP0G, 2G1TP3G, 31TP, 32TP, 32TPV		



forced air burners



GEV No.	108153	Ref. No.	6300748
description	burner blower combi-steamer 230V 65W hole distance 50mm NRG118/0800-3612-030204		
For models:	BX101G, BX101G-VERS.122013, BX122G, BX122G-VERS.122013, BX61G, BX61G-VERS.122013, BX82G, BX82G-VERS.122013, FX101G1, FX101G1R, FX101G2, FX101G2C, FX101G2C-VERS.032014, FX101G2R, FX101G2R-VERS.032014, FX101G2-VERS.032014, FX101G3, FX101G3C, FX101G3C-VERS.022014, FX101G3R, FX101G3R-VERS.022014, FX101G3-VERS.022014, FX10G2CR, FX10G2CR-VERS.032014, FX10G3CR, FX10G3CR-VERS.022014, FX122G1, FX122G2, FX122G2C, FX122G2T, FX122G2T-VERS.032014, FX122G3, FX122G3C, FX122G3T, FX122G3T-VERS.022014, FX12G3CT, FX12G3CT-VERS.022014, FX201G2, FX201G2P, FX201G2P-VERS.032014, FX201G2-VERS.032014, FX201G3P, FX201G3-VERS.022014, FX202G2, FX202G2-VERS.032014, FX202G3, FX202G3-VERS.022014, FX61G1, FX61G1R, FX61G2...(Other models you can see in the webshop)		

accessories

gaskets



GEV No.	109208	Ref. No.	36E3770
description	gasket L 89mm W 89mm D1 ø 76mm thickness 1mm hole ø 6mm hole distance 69mm for burner chamber combi-steamer		
For models:	FC1011G, FC1221G, FC611G, FM1011G1, FM1011G1-VERS.2006, FM1011G2, FM1011G2-VERS.2006, FM1011G3, FM1011G3-VERS.2006, FM1221G1, FM1221G1-VERS.2006, FM1221G2, FM1221G2-VERS.2006, FM1221G3, FM1221G3-VERS.2006, FM2011G2-VERS.2006, FM2011G3-VERS.2006, FM2021G1, FM2021G2, FM2021G2-VERS.2006, FM2021G3, FM2021G3-VERS.2006, FM611G1, FM611G1-VERS.2006, FM611G2, FM611G2-VERS.2006, FM611G3, FM611G3-VERS.2006, FM721G1, FM721G1-VERS.2006, FM721G2, FM721G2-VERS.2006, FM721G3, FM721G3-VERS.2006		



GEV No.	109207	Ref. No.	36E3390
description	gasket L 89mm W 89mm ø 76mm thickness 3mm hole ø 4mm hole distance 69mm for burner chamber combi-steamer		
For models:	FC1011G, FC1221G, FC611G, FM1011G1, FM1011G1-VERS.2006, FM1011G2, FM1011G2-VERS.2006, FM1011G3, FM1011G3-VERS.2006, FM1221G1, FM1221G1-VERS.2006, FM1221G2, FM1221G2-VERS.2006, FM1221G3, FM1221G3-VERS.2006, FM2011G2-VERS.2006, FM2011G3-VERS.2006, FM2021G1, FM2021G2, FM2021G2-VERS.2006, FM2021G3, FM2021G3-VERS.2006, FM611G1, FM611G1-VERS.2006, FM611G2, FM611G2-VERS.2006, FM611G3, FM611G3-VERS.2006, FM721G1, FM721G1-VERS.2006, FM721G2, FM721G2-VERS.2006, FM721G3, FM721G3-VERS.2006		

gas nozzles

main nozzles

gas nozzles M6x0.75



GEV No.	102570	Ref. No.	33T3060
description	gas injector thread M6x0.75 WS 8 bore ø 1.15mm		



GEV No.	106744	Ref. No.	33T4490
description	gas injector thread M6x0.75 WS 8 bore ø 1.3mm		



GEV No.	102571	Ref. No.	3033010
description	gas injector thread M6x0.75 WS 8 bore ø 1.4mm		



GEV No.	106745	Ref. No.	3033000
description	gas injector thread M6x0.75 WS 8 bore ø 1.55mm		



GEV No.	102569	Ref. No.	33T4480
description	gas injector thread M6x0.75 WS 8 bore ø 1.5mm		



GEV No.	102564	Ref. No.	33T4230
description	gas injector thread M6x0.75 WS 8 bore ø 1.65mm		





GEV No.	102565	Ref. No.	33T4250
description	gas injector thread M6x0.75 WS 8 bore ø 1.75mm		



GEV No.	102961	Ref. No.	33T4240
description	gas injector thread M6x0.75 WS 8 bore ø 1.85mm		





			
1			
GEV No.	102567	Ref. No.	33T3050
description	gas injector thread M6x0.75 WS 8 bore ø 1mm		

gas nozzles M8x1			
			
1			
GEV No.	104737	Ref. No.	3032930
description	gas injector thread M8x1 WS 10 bore ø 0.5mm		
For models:	BX61E, BX61E-VERS.122013, BX61G, BX61G-VERS.122013, FC611E, FC611G, FM1221E1-VERS.2006, FM1221E2-VERS.2006, FM1221E3-VERS.2006, FM1221G1-VERS.2006, FM1221G2-VERS.2006, FM1221G3-VERS.2006, FM2011E2-VERS.2006, FM2011E3-VERS.2006, FM2011G2-VERS.2006, FM2011G3-VERS.2006, FM2021E2-VERS.2006, FM2021E3-VERS.2006, FM2021G2-VERS.2006, FM2021G3-VERS.2006, FM611E1, FM611E1-VERS.2006, FM611E2, FM611E2-VERS.2006, FM611E3, FM611E3-VERS.2006, FM611G1, FM611G1-VERS.2006, FM611G2, FM611G2-VERS.2006, FM611G3, FM611G3-VERS.2006, FX61E1, FX61E1R, FX61E2, FX61E2C, FX61E2CR, FX61E2CR-VERS.032014, FX61E2C-VERS.032014, FX61E2R, FX61E2R-VERS.032014, FX61E2-VERS.032014, FX61E3, FX61E3C, FX61E3CR, FX61E3CR-VERS.022014, FX61E3C-VERS.022014, FX61E3R, FX61E3R-VERS.022014, FX61E3-VERS.022014...(Other models you can see in the webshop)		

			
1			
GEV No.	104736	Ref. No.	3032920
description	gas injector thread M8x1 WS 10 bore ø 1.85mm		
For models:	FC1011E, FC1011G, FC1221E, FC1221G, FC611E, FC611G, FM1011E1, FM1011E1-VERS.2006, FM1011E2, FM1011E2-VERS.2006, FM1011E3, FM1011E3-VERS.2006, FM1011G1, FM1011G1-VERS.2006, FM1011G2, FM1011G2-VERS.2006, FM1011G3, FM1011G3-VERS.2006, FM1221E1-VERS.2006, FM1221E2-VERS.2006, FM1221E3, FM1221E3-VERS.2006, FM1221G1-VERS.2006, FM1221G2-VERS.2006, FM1221G3, FM1221G3-VERS.2006, FM2011E2-VERS.2006, FM2011E3-VERS.2006, FM2011G2-VERS.2006, FM2011G3-VERS.2006, FM611E1, FM611E1-VERS.2006, FM611E2, FM611E2-VERS.2006, FM611E3, FM611E3-VERS.2006, FM611G1, FM611G1-VERS.2006, FM611G2, FM611G2-VERS.2006, FM611G3, FM611G3-VERS.2006, FM721E3, FM721G3		

gas nozzles M10x1			
			
1			
GEV No.	100670	Ref. No.	33T3880
description	gas injector thread M10x1 bore ø 0.9mm L 30mm WS 12		

			
1			
GEV No.	106400	Ref. No.	33T0650
description	gas injector thread M10x1 bore ø 1.1mm L 30mm WS 12		

			
1			
GEV No.	101974	Ref. No.	33T3910
description	gas injector thread M10x1 bore ø 1.35mm L 30mm WS 12		

			
1			
GEV No.	101975	Ref. No.	33T3980
description	gas injector thread M10x1 bore ø 1.55mm L 30mm WS 12		

			
1			
GEV No.	100816	Ref. No.	33T3900
description	gas injector thread M10x1 bore ø 1.5mm WS 12		

			
1			
GEV No.	100153	Ref. No.	33T1700
description	gas injector thread M10x1 bore ø 1.6mm L 30mm WS 12		

			
1			
GEV No.	106402	Ref. No.	33T0710
description	gas injector thread M10x1 bore ø 1.75mm L 30mm WS 12		

			
1			
GEV No.	106407	Ref. No.	33T1750
description	gas injector thread M10x1 bore ø 1.85mm L 30mm WS 12		

			
1			
GEV No.	106403	Ref. No.	33T1920
description	gas injector thread M10x1 bore ø 1.9mm L 30mm WS 12		

			
1			
GEV No.	100676	Ref. No.	33T0690
description	gas injector thread M10x1 bore ø 1mm L 30mm WS 12		

			
1			
GEV No.	100673	Ref. No.	33T1990
description	gas injector thread M10x1 bore ø 2.05mm L 30mm WS 12		

			
1			
GEV No.	106401	Ref. No.	33T0720
description	gas injector thread M10x1 bore ø 2.2mm L 30mm WS 12		

			
1			
GEV No.	101973	Ref. No.	33T3920
description	gas injector thread M10x1 bore ø 2.3mm L 30mm WS 12		

			
1			
GEV No.	107898	Ref. No.	33T0550
description	gas injector thread M10x1 bore ø 2.7mm L 30mm WS 12		

			
1			
GEV No.	106404	Ref. No.	33T0750
description	gas injector thread M10x1 bore ø 2.8mm L 30mm WS 12		

			
1			
GEV No.	106405	Ref. No.	33T3360
description	gas injector thread M10x1 bore ø 2mm L 30mm WS 12		

			
1			
GEV No.	106406	Ref. No.	33T2280
description	gas injector thread M10x1 bore ø 3.5mm L 30mm WS 12		

			
1			
GEV No.	101972	Ref. No.	33T4030
description	gas injector thread M10x1 bore ø 3.6mm L 30mm WS 12		

			
1			
GEV No.	106408	Ref. No.	33T3370
description	gas injector thread M10x1 bore ø 3mm L 30mm WS 12		

			
1			
GEV No.	106471	Ref. No.	33T1520
description	gas injector thread M10x1 WS 12 bore ø 0.7mm		

			
1			
GEV No.	106472	Ref. No.	33T1550
description	gas injector thread M10x1 WS 12 bore ø 0.85mm		

			
1			
GEV No.	106465	Ref. No.	33T1540
description	gas injector thread M10x1 WS 12 bore ø 0.8mm		

			
1			
GEV No.	106451	Ref. No.	33T1560
description	gas injector thread M10x1 WS 12 bore ø 0.9mm		

			
1			
GEV No.	106473	Ref. No.	33T1590
description	gas injector thread M10x1 WS 12 bore ø 1.05mm		

			
1			
GEV No.	106466	Ref. No.	33T1610
description	gas injector thread M10x1 WS 12 bore ø 1.15mm		

			
1			
GEV No.	106611	Ref. No.	33T1630
description	gas injector thread M10x1 WS 12 bore ø 1.25mm		





			
1			
GEV No.	106452	Ref. No.	33T3760
description	gas injector thread M10x1 WS 12 bore ø 1.35mm		

			
1			
GEV No.	106454	Ref. No.	33T1740
description	gas injector thread M10x1 WS 12 bore ø 1.8mm		

			
1			
GEV No.	106453	Ref. No.	33T1660
description	gas injector thread M10x1 WS 12 bore ø 1.4mm		

			
1			
GEV No.	106456	Ref. No.	33T1770
description	gas injector thread M10x1 WS 12 bore ø 1.95mm		

			
1			
GEV No.	101961	Ref. No.	33T3490
description	gas injector thread M10x1 WS 12 bore ø 1.55mm		

			
1			
GEV No.	106457	Ref. No.	33T1790
description	gas injector thread M10x1 WS 12 bore ø 2.05mm		

			
1			
GEV No.	106467	Ref. No.	33T0790
description	gas injector thread M10x1 WS 12 bore ø 1.6mm		

			
1			
GEV No.	106458	Ref. No.	33T1800
description	gas injector thread M10x1 WS 12 bore ø 2.1mm		

			
1			
GEV No.	106468	Ref. No.	33T1720
description	gas injector thread M10x1 WS 12 bore ø 1.7mm		

			
1			
GEV No.	106475	Ref. No.	33T1820
description	gas injector thread M10x1 WS 12 bore ø 2.2mm		

			
1			
GEV No.	106455	Ref. No.	33T1380
description	gas injector thread M10x1 WS 12 bore ø 1.85mm		

			
1			
GEV No.	106459	Ref. No.	33T1840
description	gas injector thread M10x1 WS 12 bore ø 2.4mm		

			
1			
GEV No.	106469	Ref. No.	33T1850
description	gas injector thread M10x1 WS 12 bore ø 2.5mm		

			
1			
GEV No.	106463	Ref. No.	33T1900
description	gas injector thread M10x1 WS 12 bore ø 3mm		

			
1			
GEV No.	106460	Ref. No.	33T1860
description	gas injector thread M10x1 WS 12 bore ø 2.6mm		

			
1			
GEV No.	101997	Ref. No.	33T4210
description	gas injector thread M10x1 WS 11 bore ø 1.4mm		

			
1			
GEV No.	106461	Ref. No.	33T1880
description	gas injector thread M10x1 WS 12 bore ø 2.8mm		

			
1			
GEV No.	100380	Ref. No.	33T0070
description	gas injector thread M10x1 WS 12 bore ø 0.7mm		

			
1			
GEV No.	106462	Ref. No.	33T3750
description	gas injector thread M10x1 WS 12 bore ø 2.9mm		

			
1			
GEV No.	100381	Ref. No.	33T0080
description	gas injector thread M10x1 WS 12 bore ø 0.85mm		

			
1			
GEV No.	106474	Ref. No.	33T1780
description	gas injector thread M10x1 WS 12 bore ø 2mm		

			
1			
GEV No.	100382	Ref. No.	33T0090
description	gas injector thread M10x1 WS 12 bore ø 1.05mm		

			
1			
GEV No.	106464	Ref. No.	33T1930
description	gas injector thread M10x1 WS 12 bore ø 3.4mm		

			
1			
GEV No.	100539	Ref. No.	33T0390
description	gas injector thread M10x1 WS 12 bore ø 1.15mm		

1

GEV No.	100540	Ref. No.	33T1620
description	gas injector thread M10x1 WS 12 bore ø 1.2mm		



1

GEV No.	100537	Ref. No.	33T1580
description	gas injector thread M10x1 WS 12 bore ø 1mm		



1

GEV No.	100387	Ref. No.	33T1670
description	gas injector thread M10x1 WS 12 bore ø 1.45mm		



1

GEV No.	100386	Ref. No.	33T0160
description	gas injector thread M10x1 WS 12 bore ø 2.2mm		



1

GEV No.	102151	Ref. No.	33T0110
description	gas injector thread M10x1 WS 12 bore ø 1.4mm		



1

GEV No.	100388	Ref. No.	33T0170
description	gas injector thread M10x1 WS 12 bore ø 2.3mm		



1

GEV No.	100383	Ref. No.	33T0120
description	gas injector thread M10x1 WS 12 bore ø 1.6mm		



1

GEV No.	106430	Ref. No.	33T0190
description	gas injector thread M10x1 WS 12 bore ø 2.6mm		



1

GEV No.	100384	Ref. No.	33T0130
description	gas injector thread M10x1 WS 12 bore ø 1.8mm		



1

GEV No.	107466	Ref. No.	33T4640
description	gas injector thread M10x1 WS 12 bore ø 3.05mm		



1

GEV No.	100544	Ref. No.	33T1760
description	gas injector thread M10x1 WS 12 bore ø 1.9mm		
For models:	91AR		





1

GEV No.	106431	Ref. No.	33T0510
description	gas injector thread M10x1 WS 12 bore ø 3.3mm		

			
1			
GEV No.	106300	Ref. No.	33T2420
description	gas injector thread M10x1 WS 12 bore ø 0.9mm L 31mm		

			
1			
GEV No.	106301	Ref. No.	33T0310
description	gas injector thread M10x1 WS 12 bore ø 1.05mm L 31mm		

			
1			
GEV No.	106302	Ref. No.	33T2140
description	gas injector thread M10x1 WS 12 bore ø 1.25mm L 31mm		

			
1			
GEV No.	106305	Ref. No.	33T3210
description	gas injector thread M10x1 WS 12 bore ø 1.5mm L 31mm		

			
1			
GEV No.	102236	Ref. No.	33T1310
description	gas injector thread M10x1 WS 12 bore ø 2.1mm		

			
1			
GEV No.	106303	Ref. No.	33T0320
description	gas injector thread M10x1 WS 12 bore ø 2.3mm L 31mm		

pilot burner nozzles

pilot burner nozzle AB

			
1			
GEV No.	106237	Ref. No.	33T1510
description	pilot burner nozzle natural/liquid gas code 25 bore ø 0.25mm Qty 1 pcs		

pilot burner nozzles JUNKERS

CB 50203_/503_ series

			
1			
GEV No.	100220	Ref. No.	33T0540
description	pilot burner nozzle LPG gas pressure 50mbar code 2 Qty 1 pcs suitable for JUNKERS CB503_		

			
1			
GEV No.	100224	Ref. No.	33T0560
description	pilot burner nozzle natural gas gas pressure 25mbar code 26 Qty 1 pcs suitable for JUNKERS CB503_		

pilot burner nozzles SIT

100 series

			
1			
GEV No.	100246	Ref. No.	33T0410
description	pilot burner nozzle natural gas bore ø 0.35mm Qty 1 pcs thread M8x0.75		

			
1			
GEV No.	102972	Ref. No.	33T3130
description	pilot burner nozzle natural gas code 40 bore ø 0.4mm Qty 1 pcs		

			
1			
GEV No.	107171	Ref. No.	33T0340
description	pilot burner nozzle SIT natural/liquid gas bore ø 0.25mm Qty 1 pcs		

160 series

			
1			
GEV No.	107649	Ref. No.	33T4300
description	pilot burner nozzle SIT LPG code 20 Qty 1 pcs		

			
1			
GEV No.	107650	Ref. No.	33T3310
description	pilot burner nozzle SIT LPG code 30 Qty 1 pcs		

			
1			
GEV No.	107173	Ref. No.	33T4310
description	pilot burner nozzle SIT natural gas code 35 Qty 1 pcs suitable for 160 series nozzle ø 0.35mm		



			
1			
GEV No.	107174	Ref. No.	33T2870
description	pilot burner nozzle SIT natural gas code 41 Qty 1 pcs		

pilot burner nozzles (other)
ANGELO PO

			
1			
GEV No.	100253	Ref. No.	33T0040
description	pilot burner nozzle LPG code 2 gas pressure 50mbar Qty 1 pcs brass		

			
1			
GEV No.	100240	Ref. No.	33T0240
description	pilot burner nozzle LPG code 39 gas pressure 30mbar brass		
accessories for	100240		
	GEV No.	100240	Ref. No. 33T0240
pilot burner nozzle LPG code 39 gas pressure 30mbar brass			
	GEV No.	100241	Ref. No. 33T0050
pilot burner nozzle natural gas code 13 gas pressure 25mbar bore ø 0.4mm Qty 1 pcs brass			
	GEV No.	100909	Ref. No. 36Q0060
union screw thread M10x1 for pipe ø 6mm Qty 1 pcs			
	GEV No.	101282	Ref. No. —
olive for pipe ø 4mm L 7.4mm Qty 1 pcs			
	GEV No.	101283	Ref. No. —
union screw thread M10x1 for pipe ø 4mm Qty 1 pcs			
	GEV No.	101288	Ref. No. —
olive for pipe ø 6mm L 6mm aluminium Qty 1 pcs ED ø 8.5mm			

			
1			
GEV No.	100241	Ref. No.	33T0050
description	pilot burner nozzle natural gas code 13 gas pressure 25mbar bore ø 0.4mm Qty 1 pcs brass		

bypass nozzles

bypass nozzles EGA

			
1			
GEV No.	100357	Ref. No.	33T2340
description	bypass nozzle EGA type 31248 series bore ø 0.7mm		

			
1			
GEV No.	100328	Ref. No.	33T2370
description	bypass nozzle EGA type 31248 series bore ø 0.8mm		

			
1			
GEV No.	100363	Ref. No.	33T2360
description	bypass nozzle EGA type 31248 series bore ø 1.5mm		

			
1			
GEV No.	106236	Ref. No.	33T2350
description	bypass nozzle EGA type 31248 series bore ø 1.7mm		

bypass nozzles PEL20/21

			
1			
GEV No.	100408	Ref. No.	33T3630
description	bypass nozzle type PEL20/21 bore ø 0.35mm thread M5x0.5		

			
1			
GEV No.	100553	Ref. No.	33T1450
description	bypass nozzle type PEL20/21 bore ø 0.4mm thread M5x0.5		

			
1			
GEV No.	100550	Ref. No.	33T3530
description	bypass nozzle type PEL20/21 bore ø 0.55mm thread M5x0.5		

			
1			
GEV No.	100548	Ref. No.	33T3640
description	bypass nozzle type PEL20/21 bore ø 0.65mm thread M5x0.5		

			
1			
GEV No.	100278	Ref. No.	33T2640
description	bypass nozzle type PEL20/21 bore ø 0.75mm thread M5x0.5		

			
GEV No.	100552	Ref. No.	33T3650
description	bypass nozzle type PEL20/21 bore ø 0.7mm thread M5x0.5		

			
GEV No.	100527	Ref. No.	33T3660
description	bypass nozzle type PEL20/21 bore ø 0.85mm thread M5x0.5		

			
GEV No.	100555	Ref. No.	33T3540
description	bypass nozzle type PEL20/21 bore ø 0.8mm thread M5x0.5		

			
GEV No.	100556	Ref. No.	33T3810
description	bypass nozzle type PEL20/21 bore ø 0.95mm thread M5x0.5		

			
GEV No.	100557	Ref. No.	33T3670
description	bypass nozzle type PEL20/21 bore ø 1.05mm thread M5x0.5		

			
GEV No.	100530	Ref. No.	33T4260
description	bypass nozzle type PEL20/21 bore ø 1.1mm thread M5x0.5		

			
GEV No.	100532	Ref. No.	33T4270
description	bypass nozzle type PEL20/21 bore ø 1.2mm thread M5x0.5		

			
GEV No.	100533	Ref. No.	33T4290
description	bypass nozzle type PEL20/21 bore ø 1.3mm thread M5x0.5		

bypass nozzles PEL22			
			
GEV No.	100259	Ref. No.	33T1180
description	bypass nozzle type PEL22 bore ø 0.35mm thread M6x0.5		

			
GEV No.	100281	Ref. No.	33T1690
description	bypass nozzle type PEL22 bore ø 0.4mm thread M6x0.5		

			
GEV No.	100391	Ref. No.	33T2120
description	bypass nozzle type PEL22 bore ø 0.55mm thread M6x0.5		

			
GEV No.	100390	Ref. No.	33T1190
description	bypass nozzle type PEL22 bore ø 0.5mm thread M6x0.5		

			
GEV No.	100428	Ref. No.	33T1210
description	bypass nozzle type PEL22 bore ø 0.65mm thread M6x0.5		

			
GEV No.	100432	Ref. No.	33T2160
description	bypass nozzle type PEL22 bore ø 0.75mm thread M6x0.5		

			
GEV No.	100409	Ref. No.	33T3970
description	bypass nozzle type PEL22 bore ø 0.8mm thread M6x0.5		

			
GEV No.	100433	Ref. No.	33T3850
description	bypass nozzle type PEL22 bore ø 0.9mm thread M6x0.5		

			
GEV No.	100435	Ref. No.	33T2250
description	bypass nozzle type PEL22 bore ø 1.05mm thread M6x0.5		

			
GEV No.	102974	Ref. No.	33T0590
description	bypass nozzle type PEL22 bore ø 1.25mm thread M6x0.5		



bypass nozzles PEL23/24

	1		
GEV No.	106235	Ref. No.	33T1480
description	bypass nozzle type PEL23/24 bore \varnothing 0.4mm thread M8x0.5		
	1		
GEV No.	100448	Ref. No.	33T2500
description	bypass nozzle type PEL23/24 bore \varnothing 0.5mm thread M8x0.5		
	1		
GEV No.	100494	Ref. No.	33T4050
description	bypass nozzle type PEL23/24 bore \varnothing 0.75mm thread M8x0.5		
	1		
GEV No.	100497	Ref. No.	33T4060
description	bypass nozzle type PEL23/24 bore \varnothing 0.8mm thread M8x0.5		
	1		
GEV No.	100598	Ref. No.	33T2490
description	bypass nozzle type PEL23/24 bore \varnothing 0.95mm thread M8x0.5		
	1		
GEV No.	100597	Ref. No.	33T2690
description	bypass nozzle type PEL23/24 bore \varnothing 0.9mm thread M8x0.5		
	1		
GEV No.	100628	Ref. No.	33T3280
description	bypass nozzle type PEL23/24 bore \varnothing 1.05mm thread M8x0.5		
	1		
GEV No.	100667	Ref. No.	33T2720
description	bypass nozzle type PEL23/24 bore \varnothing 1.35mm thread M8x0.5		
	1		
GEV No.	100677	Ref. No.	33T2660
description	bypass nozzle type PEL23/24 bore \varnothing 1.45mm thread M8x0.5		

gas nozzles sets

	1		
GEV No.	102171	Ref. No.	6018090
description	gas injector set		
	1		
GEV No.	102610	Ref. No.	6018330 60A0640
description	gas injector set LPG 2 flames ANGELO PO		
	1		
GEV No.	102622	Ref. No.	6012660
description	gas injector set LPG ANGELO PO		
For models:	1A1FA1G, 1A1FA2G, 1A1FA4G, 1A1FA5G, 1A1TP0G-VERS.2002, 1D1FA1G, 1D1FA2G, 1D1FA4G, 1D1FA5G, 1D1TP0G-VERS.2002, 2A1FA1G, 2A1FA4G, 2A1TP3G, 2A1TP6G, 2D1FA1G, 2D1FA4G, 2D1TP3G, 2D1TP6G, 3A1FA1G, 3A1FA4G, 3D1FA1G, 3D1FA4G		
	1		
GEV No.	102613	Ref. No.	6018340 60A0650
description	gas injector set LPG for gas range 4 ANGELO PO		



1

GEV No.	102611	Ref. No.	6018360 60A0670
description	gas injector set LPG for gas range 4 with gas oven ANGELO PO		



1

GEV No.	102618	Ref. No.	6018250 60A0560
description	gas injector set LPG gas fryer 2 basins ANGELO PO		



1

GEV No.	102619	Ref. No.	6018430 60A0740
description	gas injector set LPG for solid top range with gas hob and gas oven ANGELO PO		



1

GEV No.	102625	Ref. No.	6018270 60A0580
description	gas injector set LPG gas fryer 2 basins ANGELO PO		



1

GEV No.	102626	Ref. No.	6018260 60A0570
description	gas injector set LPG gas fryer 1 basin ANGELO PO		



1

GEV No.	102617	Ref. No.	6018180 60A0490
description	gas injector set LPG gas pasta cooker 2 basins ANGELO PO		



1

GEV No.	102629	Ref. No.	6018240 60A0550
description	gas injector set LPG gas fryer 1 basin ANGELO PO		



1

GEV No.	102623	Ref. No.	6018190 60A0500
description	gas injector set LPG gas pasta cooker ANGELO PO		





1

GEV No.	102624	Ref. No.	6018170 60A0480
description	gas injector set LPG gas pasta cooker ANGELO PO		



1

GEV No.	102621	Ref. No.	6012700
description	gas injector set LPG nominal power 5.5KW ANGELO PO		
For models:	0A0FA1, 0A0FA4, 0D0FA1, 0D0FA4, 1A0FA1, 1A0FA2, 1A0FA4, 1A0FA5, 1A1FA1G, 1A1FA2G, 1A1FA4G, 1A1FA5G, 1D0FA1, 1D0FA2, 1D0FA4, 1D0FA5, 1D1FA1G, 1D1FA2G, 1D1FA4G, 1D1FA5G, 2A0FA1, 2A0FA4, 2A1FA1G, 2A1FA4G, 2A1TP3G, 2A1TP6G, 2D0FA1, 2D0FA4, 2D1FA1G, 2D1FA4G, 2D1TP3G, 2D1TP6G, 3A1FA1G, 3A1FA4G, 3D1FA1G, 3D1FA4G		



1

GEV No.	102620	Ref. No.	6012680
description	gas injector set LPG nominal power 7.5KW ANGELO PO		



1

GEV No.	102616	Ref. No.	6018410 60A0720
description	gas injector set LPG solid top range ANGELO PO		



1

GEV No.	102615	Ref. No.	6018420 60A0730
description	gas injector set LPG solid top range with gas oven ANGELO PO		



1

GEV No.	106808	Ref. No.	6025800
description	gas injector set natural gas ANGELO PO		



1

GEV No.	106807	Ref. No.	6018060 60A0370
description	gas injector set natural gas ANGELO PO 0G0FT		



1

GEV No.	102614	Ref. No.	6018290 60A0600
description	gas injector set natural gas for gas range 4 ANGELO PO		



1

GEV No.	102612	Ref. No.	6018320 60A0630
description	gas injector set natural gas for gas range 6 with gas oven ANGELO PO		



1

GEV No.	106550	Ref. No.	6018370 60A0680
description	nozzle set LPG ANGELO PO		



auxiliary gas parts

screw connections

adapters



1

GEV No.	103097	Ref. No.	33Q2870
description	screw connection for thermostat		
For models:	1A1PI1G, 1A1PI1GA, 1D1PI1G, 1D1PI1GA, 1G1PI1G, 31PI6, 71PI10, 71PI10A, 91PI10, 91PI10A		

olives



1

GEV No.	103325	Ref. No.	3034890
description	olive for pipe ø 10mm D2 ø 9mm L 8mm		
For models:	08WFA4G, 090FT1G, 090FT2G, 090FT4G, 090FT5G, 090FT7G, 0G0FR5G, 0G0FT1G-VERS.032008, 0G0FT2G-VERS.032008, 0G0FT4G-VERS.032008, 0G0FT5G-VERS.032008, 0G0FT7G, 0G1FR7G, 12WFA6G, 190FT15G, 190FT1G, 190FT2G, 190FT3G, 190FT42G, 190FT4G, 190FT6G, 190FT72G, 190FT7G, 191FAAG, 191FABG, 191FADG, 191FAG, 191TPG, 1A1FAAG, 1A1FABG, 1D1FAAG, 1D1FABG, 1G0FR6G, 1G0FT1G-VERS.032008, 1G0FT2G-VERS.032008, 1G0FT3G-VERS.032008, 1G0FT4G-VERS.032008, 1G0FT6E, 1G0FT6G-VERS.032008, 1G0FT7G, 1G1BR1G, 1G1FR8G, 291FAG, 291FAGE, 291TPCG, 2A1FAAG, 2A1TPCG, 2D1FAAG, 2D1TPCG, 391FAG...(Other models you can see in the webshop)		





1

GEV No.	101249	Ref. No.	36Q1700
description	olive for pipe ø 10mm Qty 1 pcs		
For models:	06WCP1GM, 08WCP1GM, 08WGRGV, 090FAVA, 090GRG, 091CP1G, 091FR3G, 091FR3GD, 0A0BMG, 0A0FAS, 0A0FT1G, 0A0FT2G, 0A0FT4G, 0A0FT5G, 0A0GRG, 0A1CP1G, 0B0FAS, 0B0FT1G, 0B0FT2G, 0B0FT4G, 0B0FT5G, 0B1CP1G, 0D0BMG, 0D0FAS, 0D0FT1G, 0D0FT2G, 0D0FT4G, 0D0FT5G, 0D0GRG, 0D1CP1G, 0G0FR5G, 0G0FT1G, 0G0FT2G, 0G0FT4G, 0G0FT5G, 0G1BR3G, 10WTPGE, 10WTPGV, 190FAB, 190GRG, 190TP0, 191CP1G, 191CP2G, 191FABG, 191FR4G, 191FR4GD, 191PD2G, 191PI1G, 191PI1GA, 191PI2G...(Other models you can see in the webshop)		
accessories for	101249		
	GEV No.	101250	Ref. No. 36Q0610
	union nut thread M20x1.5 for pipe ø 10mm		



1

GEV No.	101278	Ref. No.	36Q0080
description	olive for pipe ø 10mm Qty 1 pcs		
For models:	030, 031, 032, 04WFAAV, 06WCP1GM, 06WFR3GD, 070BM, 070BME, 071BM, 071BME, 08WCP1GM, 08WFA4E, 08WFA4G, 08WFAAE, 08WFAAG, 08WFAAV, 08WFT1GV, 08WFT2GV, 08WFT3GV, 08WFT4GV, 08WFT6GV, 08WFT7GV, 08WGRGV, 090BM, 090BM1G, 090BME, 090FAA, 090FAVA, 090FT1G, 090FT2G, 090FT4G, 090FT5G, 090FT7G, 090GRG, 091BM, 091BME, 091CP1G, 091FR1EX, 091FR3G, 091FR3GD, 091FR7G5, 091FR7GX, 0A0BMG, 0A0FA1, 0A0FA4, 0A0FAA, 0A0FT1G, 0A0FT2G, 0A0FT4G, 0A0FT5G...(Other models you can see in the webshop)		
accessories for	101278		
	GEV No.	100943	Ref. No. —
	union nut thread M17x1 tube ø 10mm		
	GEV No.	101300	Ref. No. 36Q0830
	union nut thread M16x1.5 tube ø 10mm		
	GEV No.	101478	Ref. No. —
	union nut thread 3/8" for pipe ø 10mm		



1

GEV No.	101248	Ref. No.	36Q0030
description	olive for pipe ø 12mm Qty 1 pcs suitable for PEL		
For models:	030FT, 030FTR, 031FT, 031FT04, 031FT06, 031FTR, 031FTRL, 031TP, 032, 070BM, 070D, 070DGG, 070FT, 070FT04, 070FT05, 070FTR, 0712D, 0712VA, 071BM, 071D, 071DGG, 071FT, 071FT04, 071FT06, 071FTR, 071FTRL, 071TP, 072D, 072DGG, 090, 090BM, 090FT, 090FT04, 090FT05, 090FT1G, 090FT2G, 090FT4G, 090FT5G, 090FT7G, 090FTR, 090GG, 090GRG, 091, 091BM, 091FR1G, 091FR1GD, 091FR11, 091FR11A, 091FR11D, 091FR11D-VERS.052012...(Other models you can see in the webshop)		
accessories for	101248		
	GEV No.	101251	Ref. No. 36Q0050
	union nut thread M20x1.5 for pipe ø 12mm		





1

GEV No.	101428	Ref. No.	36Q0310
description	olive for pipe ø 14mm L 9mm Qty 1 pcs ED ø 16mm		
For models:	04WFAAV, 08WFAAE, 08WFAAG, 08WFAAV, 12WFAAE, 12WFAAG, 191BR1G, 191BR1GA, 191BR2G, 191BR2GA, 1A1BR1G, 1A1BR1GA, 1A1BR2G, 1A1BR2GA, 1D1BR1G, 1D1BR1GA, 1D1BR2G, 1D1BR2GA, 291BR1G, 291BR1GA, 291BR2G, 291BR2GA, 2A1BR1G, 2A1BR1GA, 2A1BR2G, 2A1BR2GA, 2D1BR1G, 2D1BR1GA, 2D1BR2G, 2D1BR2GA, FC241, FCV141, FCV141DM, FCV141DS, FCV241, FCV241DM, FCV241DS		





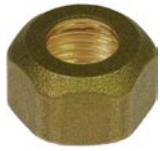

			
1			
GEV No.	100870	Ref. No.	36Q1040
description	olive for pipe ø 4mm Qty 1 pcs suitable for 160 series for pilot burner		
For models:	04WFAAV, 06WCP1GM, 06WFR3GD, 08WFA4E, 08WFA4G, 08WFAAE, 08WFAAG, 08WFAAV, 08WFT1GV, 08WFT2GV, 08WFT3GV, 08WFT4GV, 08WFT6GV, 08WFT7GV, 08WGRGV, 090BM1G, 090FAA, 090FAVA, 090FT1G, 090FT2G, 090FT4G, 090FT5G, 090FT7G, 090GRG, 091FR1G, 091FR1GD, 091FR3G, 091FR3GD, 0A0FA1, 0A0FA4, 0A0FAA, 0A0FT1G, 0A0FT2G, 0A0FT4G, 0A0FT5G, 0A0GRG, 0A1CP1G, 0B0FT1G, 0B0FT2G, 0B0FT4G, 0B0FT5G, 0B1CP1G, 0D0FA1, 0D0FA4, 0D0FAA, 0D0FT1G, 0D0FT2G, 0D0FT4G, 0D0FT5G, 0D0GRG...(Other models you can see in the webshop)		

			
1			
GEV No.	101286	Ref. No.	36Q0020
description	olive ID ø 6mm Qty 1 pcs		
For models:	04WFAAV, 08WFA4E, 08WFA4G, 08WFAAE, 08WFAAG, 08WFAAV, 090FAA, 0A0FA1, 0A0FA4, 0A0FAA, 0D0FA1, 0D0FA4, 0D0FAA, 0G0FA0, 12WFA6E, 12WFA6G, 12WFAAA, 12WFAAE, 12WFAAG, 12WFAAN, 190FA, 190FAA, 190FAB, 190FAD, 191FAAE, 191FAAG, 191FABG, 191FADG, 191FAE, 191FAG, 1A0FA1, 1A0FA2, 1A0FA4, 1A0FA5, 1A0FAA, 1A0FAB, 1A1FA1G, 1A1FA2G, 1A1FA4G, 1A1FA5G, 1A1FAAG, 1A1FABG, 1D0FA1, 1D0FA2, 1D0FA4, 1D0FA5, 1D0FAA, 1D0FAB, 1D1FA1G, 1D1FA2G...(Other models you can see in the webshop)		
accessories for	101286		
		GEV No.	100909
		Ref. No.	36Q0060
	union screw thread M10x1 for pipe ø 6mm Qty 1 pcs		
		GEV No.	101464
		Ref. No.	—
	union nut thread M12x1 for pipe ø 6mm		



T-pieces			
			
1			
GEV No.	541502	Ref. No.	33Q0140
description	T-piece thread 3/8" ET - 3/8" ET - 3/8" ET brass		
For models:	1A1CP1G, 1D1CP1G, 1G1CP2G, 1G1PD1G, 1G1PI1E, 1G1PI1G, 31PD6, 31PI6, 31PIE6, 71CP, 71CP2, 71PD10, 71PD15, 71PI10, 71PI10A, 71PIE15, 71PIE15A, 71PV15, 71PV15A, 91CP, 91PI10, 91PI10A, 91PIE15, 91PIE15A		



union nuts			
			
1			
GEV No.	520666	Ref. No.	36Q0590
description	union nut thread 1/2" H 12mm		
For models:	091FR1I, 091FR1IA, 091FR1ID, 091FR1ID-VERS.052012, 091FR1I-VERS.032012, 091FR7G, 091FR7GS, 091FR7G-VERS.052012, 091FR7GX, 0A1CP1E, 0A1CP1G, 0B1CP1G, 0D1CP1E, 0D1CP1G, 10CP1IA, 12CP1IA, 18CP2IA, 191FR2I, 191FR2ID, 191FR2ID-VERS.092012, 191FR2I-VERS.032012, 1A1BR1E, 1A1BR1G, 1A1BR1GA, 1A1BR2E, 1A1BR2EA, 1A1BR2G, 1A1BR2GA, 1A1CP1G, 1A1CP2G, 1A1PD1G, 1A1PD2G, 1A1PI1G, 1A1PI1GA, 1A1PI2E, 1A1PI2EA, 1A1PI2V, 1A1PI-2VA, 1D1BR1E, 1D1BR1G, 1D1BR1GA, 1D1BR2E, 1D1BR2EA, 1D1BR2G, 1D1BR2GA, 1D1CP1G, 1D1CP2G, 1D1PD1G, 1D1PD2G, 1D1PI1G...(Other models you can see in the webshop)		

			
1			
GEV No.	101300	Ref. No.	36Q0830
description	union nut thread M16x1.5 tube ø 10mm		
For models:	030, 031, 032, 04WFAAV, 06WCP1GM, 06WFR3GD, 08WCP1GM, 08WFA4E, 08WFA4G, 08WFAAE, 08WFAAG, 08WFAAV, 08WFT1GV, 08WFT2GV, 08WFT3GV, 08WFT4GV, 08WFT6GV, 08WFT7GV, 08WGRGV, 090FAA, 090GRG, 091CP1G, 0A0BMG, 0A0FA1, 0A0FA4, 0A0FAA, 0A0GRG, 0D0BMG, 0D0FA1, 0D0FA4, 0D0FAA, 0D0GRG, 0G0FA0, 0G0FR5G, 0G1BR3G, 0G1CP1G, 0G1CP1G-VERS.2004, 0G1FR7G, 10WFR4GD, 12WFA6E, 12WFA6G, 12WFAAA, 12WFAAE, 12WFAAG, 12WFAAN, 190FA, 190FAA, 190FAB, 190FAD, 190GRG...(Other models you can see in the webshop)		
accessories for	101300		
		GEV No.	101278
		Ref. No.	36Q0080
	olive for pipe ø 10mm Qty 1 pcs		

			
1			
GEV No.	100944	Ref. No.	36Q0040
description	union nut thread M18x1.5 for pipe ø 12mm		
accessories for	100944		
		GEV No.	101273
		Ref. No.	—
	olive for pipe ø 12mm L 9.5mm brass Qty 1 pcs suitable for universal		



			
1			
GEV No.	101250	Ref. No.	36Q0610
description	union nut thread M20x1.5 for pipe ø 10mm		
For models:	04WFAAV, 06WCP1GM, 06WFR3GD, 08WCP1GM, 08WFA4E, 08WFA4G, 08WFAAE, 08WFAAG, 08WFAAV, 08WGRGV, 090FAA, 090FAVA, 090FT1G, 090FT2G, 090FT4G, 090FT5G, 090FT7G, 090GRG, 091CP1G, 091FR3G, 091FR3GD, 0A0FA1, 0A0FA4, 0A0FAA, 0A0FAS, 0A0FT1G, 0A0FT2G, 0A0FT4G, 0A0FT5G, 0A0GRG, 0A1CP1G, 0A1FR3G, 0A1FR3GD, 0B0FAS, 0B0FT1G, 0B0FT2G, 0B0FT4G, 0B0FT5G, 0B1CP1G, 0D0FA1, 0D0FA4, 0D0FAA, 0D0FAS, 0D0FT1G, 0D0FT2G, 0D0FT4G, 0D0FT5G, 0D0GRG, 0D1CP1G, 0D1FR3G...(Other models you can see in the webshop)		
accessories for	101250		
	GEV No.	101249	Ref. No. 36Q1700
	olive for pipe ø 10mm Qty 1 pcs		

			
1			
GEV No.	101251	Ref. No.	36Q0050
description	union nut thread M20x1.5 for pipe ø 12mm		
For models:	030FT, 030FTR, 031FT, 031FTR, 031FTRL, 031TP, 032, 070D, 070DGG, 070FT, 070FTR, 0712D, 0712VA, 071BM, 071D, 071DGG, 071FT, 071FTR, 071FTRL, 071TP, 072D, 072DGG, 090, 090FT, 090FT1G, 090FT2G, 090FT4G, 090FT5G, 090FT7G, 090FTR, 090GG, 090GRG, 091, 091FR1G, 091FR1GD, 091FR1I, 091FR1IA, 091FR1ID, 091FR1ID-VERS.052012, 091FR1I-VERS.032012, 091FR3G, 091FR3GD, 091FR7G, 091FR7GS, 091FR7G-VERS.052012, 091FR7GX, 091FT, 091FTR, 091FTRL, 091GG...(Other models you can see in the webshop)		
accessories for	101251		
	GEV No.	101248	Ref. No. 36Q0030
	olive for pipe ø 12mm Qty 1 pcs suitable for PEL		



			
1			
GEV No.	107892	Ref. No.	36Q0210
description	union nut thread M20x1.5 for pipe ø 14 WS 25		
For models:	04WFAAV, 08WFA4E, 08WFA4G, 08WFAAE, 08WFAAG, 08WFAAV, 12WFA6E, 12WFA6G, 12WFAAA, 12WFAAE, 12WFAAG, 12WFAAN, 191BR2G, 1A1BR1G, 1A1BR1GA, 1A1BR2G, 1A1BR2GA, 1D1BR1G, 1D1BR1GA, 1D1BR2G, 2A1BR1G, 2A1BR1GA, 2A1BR2G, 2A1BR2GA, 2D1BR1G, 2D1BR1GA, 2D1BR2G, 2D1BR2GA, 71AR, 71RA, 91AR, 91RA, FC241, FCV141, FCV141DM, FCV141DS, FCV241, FCV241DM, FCV241DS		

union screws			
			
1			
GEV No.	100906	Ref. No.	36Q1050
description	screw connection thread M10x1 for ignition electrode brass Qty 1 pcs WS 10		
For models:	08WGRGV, 090GRG, 0A0GRG, 0A1CP1G, 0B1CP1G, 0D0GRG, 0D1CP1G, 190GRG, 191CP1G, 1A0GRG, 1A1CP1G, 1A1CP2G, 1A1PD1G, 1A1PD2G, 1A1PI1G, 1A1PI1GA, 1D0GRG, 1D1CP1G, 1D1CP2G, 1D1PD1G, 1D1PD2G, 1D1PI1G, 1D1PI1GA, 1G0GRG, 6042120-08WGRGV		

			
1			
GEV No.	101279	Ref. No.	3032790
description	union screw thread 3/8" for pipe ø 10mm Qty 1 pcs		
For models:	06WFR3GD, 08WFA4G, 090BM1G, 090FT1G, 090FT2G, 090FT4G, 090FT5G, 090FT7G, 091FR1EX, 091FR3G, 091FR3GD, 091FR7GS, 091FR7GX, 0A1FR3G, 0A1FR3GD, 0D1FR3G, 0D1FR3GD, 0G0FR5G, 0G0FT1G-VERS.032008, 0G0FT2G-VERS.032008, 0G0FT4G-VERS.032008, 0G0FT5G-VERS.032008, 0G0FT7G, 0G1FR3G, 0G1FR3GD, 0G1FR7G, 10WFR4GD, 12WFA6G, 190BM2G, 190FT15G, 190FT1G, 190FT2G, 190FT3G, 190FT42G, 190FT4G, 190FT6G, 190FT72G, 190FT7G, 191FAAG, 191FABG, 191FADG, 191FAG, 191FR4G, 191FR4GD, 191TPG, 1A1FAAG, 1A1FABG, 1A1FR4G, 1A1FR4GD, 1D1FAAG...(Other models you can see in the webshop)		

			
1			
GEV No.	100908	Ref. No.	36Q1000
description	union screw thread M10x1 for pipe ø 4mm Qty 1 pcs		
For models:	04WFAAV, 06WCP1GM, 06WFR3GD, 08WFA4E, 08WFA4G, 08WFAAE, 08WFAAG, 08WFAAV, 08WFT1GV, 08WFT2GV, 08WFT3GV, 08WFT4GV, 08WFT6GV, 08WFT7GV, 08WGRGV, 090BM1G, 090FAA, 090FAVA, 090FT1G, 090FT2G, 090FT4G, 090FT5G, 090FT7G, 090GRG, 091FR1G, 091FR1GD, 091FR3G, 091FR3GD, 0A0FA1, 0A0FA4, 0A0FAA, 0A0FT1G, 0A0FT2G, 0A0FT4G, 0A0FT5G, 0A0GRG, 0A1CP1G, 0B0FT1G, 0B0FT2G, 0B0FT4G, 0B0FT5G, 0B1CP1G, 0D0FA1, 0D0FA4, 0D0FAA, 0D0FT1G, 0D0FT2G, 0D0FT4G, 0D0FT5G, 0D0GRG...(Other models you can see in the webshop)		
accessories for	100908		
	GEV No.	100897	Ref. No. —
	olive for pipe ø 4mm Qty 1 pcs for pilot burner		
	GEV No.	101246	Ref. No. —
	olive for pipe ø 4mm Qty 1 pcs		
	GEV No.	101280	Ref. No. —
	olive for pipe ø 4mm Qty 1 pcs		
	GEV No.	101282	Ref. No. —
	olive for pipe ø 4mm L 7.4mm Qty 1 pcs		



			
1			
GEV No.	100909	Ref. No.	36Q0060
description	union screw thread M10x1 for pipe ø 6mm Qty 1 pcs		
For models:	04WFAAV, 08WFA4E, 08WFA4G, 08WFAAE, 08WFAAG, 08WFAAV, 090FAA, 0A0FA1, 0A0FA4, 0A0FAA, 0D0FA1, 0D0FA4, 0D0FAA, 0G0FA0, 12WFA6E, 12WFA6G, 12WFAAA, 12WFAAE, 12WFAAG, 12WFAAN, 190FA, 190FAA, 190FAB, 190FAD, 191FAAE, 191FAAG, 191FABG, 191FADG, 191FAE, 191FAG, 1A0FA1, 1A0FA2, 1A0FA4, 1A0FA5, 1A0FAA, 1A0FAB, 1A1FA1G, 1A1FA2G, 1A1FA4G, 1A1FA5G, 1A1FAAG, 1A1FABG, 1D0FA1, 1D0FA2, 1D0FA4, 1D0FA5, 1D0FAA, 1D0FAB, 1D1FA1G, 1D1FA2G...(Other models you can see in the webshop)		
accessories for	100909		
	GEV No.	100898	Ref. No. —
	olive for pipe ø 6mm Qty 1 pcs for pilot burner		
	GEV No.	101286	Ref. No. 36Q0020
	olive ID ø 6mm Qty 1 pcs		
	GEV No.	101287	Ref. No. 36Q0150
	olive for pipe ø 6mm Qty 1 pcs		
	GEV No.	101288	Ref. No. —
	olive for pipe ø 6mm L 6mm aluminium Qty 1 pcs ED ø 8.5mm		

gas lines

main gas lines

producer-specific

			
1			
GEV No.	102991	Ref. No.	35Z4960
description	gas line tube ø 10mm L 300mm with screw connection		
For models:	070D, 070DGG, 0712D, 0712VA, 071D, 071DGG, 072D, 072DGG, 090, 090GG, 091, 091GG, 092, 092GG, 092VA, 092VAGG, 712D, 712VA, 71D, 71DGG, 71GE, 71GEGG, 72D, 72DGG, 72TP, 72TPGG, 72VA, 72VAGG, 72VAS, 72VASGG, 73D, 73DGG, 73VA, 73VAD, 73VADGG, 73VAGG		

			
1			
GEV No.	107551	Ref. No.	30Z2040
description	gas line tube ø 21mm L 745mm W 180mm H 70mm steel		
For models:	1A0FT1G, 1A0FT2G, 1A0FT3G, 1A0FT4G, 1A0FT6G, 1D0FT1G, 1D0FT2G, 1D0FT3G, 1D0FT4G, 1D0FT6G		

universal

			
1			
GEV No.	107589	Ref. No.	3029620
description	gas line connection ø10mm L 1250mm ED ø 13mm SS flexible thickness 1mm connection length 30mm		
For models:	08WFT1GV, 08WFT2GV, 08WFT3GV, 08WFT4GV, 08WFT6GV, 08WFT-7GV, 1G1FA0G, 1G1FABG, 1G1FAPG, 1G1TP0G, 2G1FA0G, 2G1FABG, 2G1FACG, 2G1FADG, 2G1FADGV, 2G1FAPG, 2G1TP3G		

			
1			
GEV No.	102990	Ref. No.	35Z6650
description	gas line connection ø10mm L 320mm ED ø 13mm SS with screw connection thickness 1mm connection length 30mm		
For models:	071FT, 071FTR, 071FTRL, 091FT, 091FTR, 091FTRL		

			
1			
GEV No.	102987	Ref. No.	3014320
description	gas line connection ø10mm L 400mm ED ø 13mm SS flexible thickness 1mm connection length 30mm		
For models:	04WFAAV, 08WFA4E, 08WFA4G, 08WFAAE, 08WFAAG, 08WFAAV, 08WFT1GV, 08WFT2GV, 08WFT3GV, 08WFT4GV, 08WFT6GV, 08WFT-7GV, 08WGRGV, 090BM1G, 090FAA, 090FAVA, 090FT1G, 090FT2G, 090FT4G, 090FT5G, 090FT7G, 090GRG, 091FR3G, 091FR3GD, 0A0BMG, 0A0FAA, 0A0FT1G, 0A0FT2G, 0A0FT4G, 0A0FT5G, 0A0GRG, 0A1FR3G, 0A1FR3GD, 0B0FT1G, 0B0FT2G, 0B0FT4G, 0B0FT5G, 0D0BMG, 0D0FAA, 0D0FT1G, 0D0FT2G, 0D0FT4G, 0D0FT5G, 0D0GRG, 0D1FR3G, 0D1FR3GD, 0G0FA0, 0G0FR5G, 0G0FT1G, 0G0FT1G-VERS.032008... (Other models you can see in the webshop)		

			
1			
GEV No.	106655	Ref. No.	3029630
description	gas line connection ø10mm L 800mm ED ø 13mm SS flexible		
For models:	06WFR3GD, 08WCP1GM, 08WFA4G, 10WFR4GD, 12WFA6G, 191FAAG, 191FABG, 191FADG, 191FAG, 191FR4G, 191FR4GD, 191PD2G, 191PI1G, 191PI1GA, 191PI2G, 191PI2GA, 191TPG, 1A1FAAG, 1A1FABG, 1A1FR4G, 1A1FR4GD, 1A1PD1G, 1A1PD2G, 1A1PI1G, 1A1PI1GA, 1D1FAAG, 1D1FABG, 1D1FR4G, 1D1FR4GD, 1D1PD1G, 1D1PD2G, 1D1PI1G, 1D1PI1GA, 1G1BR1G, 1G1FR4G, 1G1FR4GD, 1G1PD1G, 1G1PI1G, 291FAG, 291FAGF, 291TPCG, 2A1FAAG, 2A1TPCG, 2D1FAAG, 2D1TPCG, 391FAG, 3A1FAAG, 3D1FAAG		



			
1			
GEV No.	102460	Ref. No.	3079320 32Z0640
description	gas line connection ø4mm L 750mm ED ø 12mm SS flexible thickness 0.75mm connection length 20mm		
For models:	06WCP1GM, 06WFR3GD, 08WFT1GV, 08WFT2GV, 08WFT3GV, 08WFT4GV, 08WFT6GV, 08WFT7GV, 090BM1G, 090FAVA, 091FR1G, 091FR1GD, 091FR3G, 091FR3GD, 0G1CP1G, 0G1CP1G-VERS.2004, 0G1FR3G, 0G1FR3GD, 0G1FR7G, 10WFR4GD, 190BM2G, 190FAB, 190TP0, 191CP1G, 191FABG, 191FR2G, 191FR2GD, 191PD2G, 191PI1G, 191PI1GA, 191PI2G, 191PI2GA, 191TPG, 1A1FR2GD-VERS.2004, 1A1FR2G-VERS.2004, 1A1PD1G, 1A1PD2G, 1A1PI1G, 1A1PI1GA, 1D1FR2GD-VERS.2004, 1D1FR2G-VERS.2004, 1D1PD1G, 1D1PD2G, 1D1PI1G, 1D1PI1GA, 1G0FT1G, 1G0FT2G, 1G0FT3G, 1G0FT4G, 1G0FT6G...(Other models you can see in the webshop)		

pilot tubes

producer-specific

			
1			
GEV No.	106991	Ref. No.	3079290
description	pilot tube tube ø 4mm L 400mm aluminium flexible		
For models:	04WFAAV, 08WFA4E, 08WFA4G, 08WFAAE, 08WFAAG, 08WFAAV, 08WGRGV, 090BM1G, 090FT1G, 090FT2G, 090FT4G, 090FT5G, 090FT7G, 090GRG, 0G0FR5G, 0G0FT1G-VERS.032008, 0G0FT2G-VERS.032008, 0G0FT4G-VERS.032008, 0G0FT5G-VERS.032008, 0G0FT7G, 0G1BR3G, 12WFA6E, 12WFA6G, 12WFAAA, 12WFAAE, 12WFAAG, 12WFAAN, 190BM2G, 190FT15G, 190FT1G, 190FT2G, 190FT3G, 190FT42G, 190FT4G, 190FT6G, 190FT72G, 190FT7G, 190GRG, 191BR1G, 191BR1GA, 191BR2G, 191BR2GA, 1G0FR6G, 1G0FT1G-VERS.032008, 1G0FT2G-VERS.032008, 1G0FT3G-VERS.032008, 1G0FT4G-VERS.032008, 1G0FT6E, 1G0FT6G-VERS.032008, 1G0FT7G...(Other models you can see in the webshop)		

			
1			
GEV No.	102988	Ref. No.	35Z7410
description	pilot tube tube ø 5mm L 400mm		

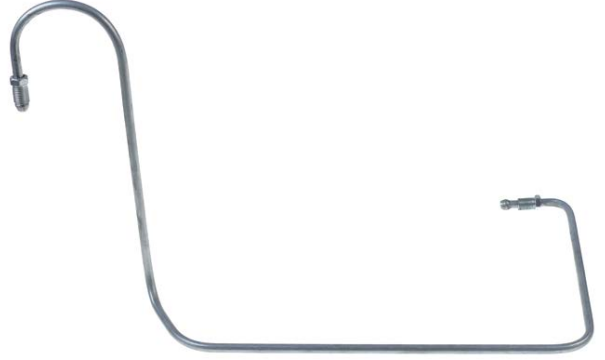
			
1			
GEV No.	102296	Ref. No.	35X4590
description	pilot tube tube ø 6mm T1: M10 T2: M10		
For models:	FC101, FC61, FCV101, FCV101-CSA, FCV101DM, FCV101DM-CSA, FCV101DS, FCV101DS-CSA, FCV61, FCV61-CSA, FCV61DM, FCV61DM-CSA, FCV61DS, FCV61DS-CSA		

			
1			
GEV No.	102989	Ref. No.	35Z7400
description	pilot tube tube ø 5mm L 130mm		
For models:	030, 031, 032, 31, 31GE, 31TC, 32, 32TC, 32TP, 32TPV, 32V		

consumables

lava rocks / ceramic briquetts

			
1			
GEV No.	211049	Ref. No.	37T1320
description	ceramic briquetts size 50x50x26mm Qty 40 pieces (2.4kg)		
For models:	08WGRGV, 090GRG, 0A0GRG, 0D0GRG, 190GRG, 1A0GRG, 1D0GRG, 1G0GRG, 6042120-08WGRGV		



equipment-specific units

for slicers

adjustment knobs



1

GEV No.	697796	Ref. No.	36M3680
description	adjusting knob \varnothing 68mm shaft \varnothing 18mm shaft L 73mm handle \varnothing 68mm turn direction left		

eccentric disc for slice thickness



1

GEV No.	697508	Ref. No.	3FL0209
description	eccentrics for cutting thickness hole \varnothing 18mm groove width 8mm ED \varnothing 85mm thickness 24.5mm		

hand guard



1

GEV No.	698212	Ref. No.	35Q9820
description	hand protection		
For models:	AFT30MS, AFT30S, AFT33MS, AFT33S, AFT35		

blades

standard



1

GEV No.	697463	Ref. No.	36G8610
description	slicing machine blade ED \varnothing 350mm seat \varnothing 57mm 4 hole ID \varnothing 280mm H 22.5mm 100Cr6 standard		
For models:	AFC35, AFT35, AFT35VS		

grindstones

pair of grindstones



1

GEV No.	699007	Ref. No.	36G1030
description	grindstone 1 pair		



1

GEV No.	698340	Ref. No.	36G3950
description	pair of grindstones 1 pair		
For models:	AFC35, AFT33MS, AFT33S, AFT35, AFT35VS		

for bandsaws

saw blades

width 16mm



1

GEV No.	699003	Ref. No.	LF152020U16
description	saw blade L 2020mm W 16mm thickness 0.5mm tooth spacing 6mm		

for meat mincers

gear wheels



1

GEV No.	698205	Ref. No.	36G0390
description	gear wheel double \varnothing 32/70mm shaft intake \varnothing 15mm W 30mm teeth 18/41 splitting tooth width 14/11mm DIN/ISO Mod.12-22		

for cutters

drive shafts



1

GEV No.	694061	Ref. No.	36G7000
description	drive shaft \varnothing 22mm stainless steel L 137mm CL3		
For models:	Q3, Q3M		

lids



1			
GEV No.	698209	Ref. No.	6000920
description	lid complete ø 215mm ID ø 210mm with magnet Q 3-5-8		
For models:	Q3, Q3M, Q5, Q52, Q5M, Q8, Q82		



1			
GEV No.	691664	Ref. No.	3031610
description	lid for cutter ø 225mm ID ø 204mm plastic with gasket C4-C6 edition since 08/2003		
For models:	SC4, SC6		



1			
GEV No.	694243	Ref. No.	36Z0665
description	lid ø 215mm ID ø 210mm plastic with magnet CL 3-5-8		

blades

spacer rings



1			
GEV No.	697106	Ref. No.	36G0650
description	spacer ring ED ø 63mm int. ø 1 39mm mounting distance 52mm hole ø 5.5mm plastic CL 3-5-8		
For models:	Q5, Q52, Q5M, Q8, Q82		

holders



1			
GEV No.	651037	Ref. No.	36G7010
description	blade holder ED ø 63mm int. ø 1 39mm int. ø 2 10mm H 81.5mm mounting distance 52mm thread M5 plastic CL 3-5-8		
For models:	Q3, Q3M, Q5, Q52, Q5M, Q8, Q82		

blades

blades smooth



1			
GEV No.	696177	Ref. No.	3017950
description	knife mounting pos. lower L 93mm seat ø 33mm mounting distance 46mm 4 hole hole ø 4.4mm thickness 2mm model C4-C6		
For models:	SC4, SC6		



1			
GEV No.	696173	Ref. No.	36G7030
description	knife mounting pos. upper seat ø 42mm mounting distance 52mm hole ø 5.5mm thickness 2mm model CL 3-5-8		
For models:	Q3, Q3M, Q5, Q52, Q5M, Q8, Q82		

for vegetable slicers

ejector discs



1			
GEV No.	699011	Ref. No.	36G6960
description	ejector disc H 7mm ø 195mm shaft diameter 22x27mm		
For models:	TV1, TV1M, TV2L		



miscellaneous



1

GEV No.	692145	Ref. No.	36G6600
description	pulley disc ø 157mm disc width 31mm shaft intake ø 15mm overall width 30mm plastic for potato peeler device		
For models:	LCV, P10, P102, P10M, P20, P202, P5, TV1, TV1M, TV2L		

for potato peelers

drive shafts



1

GEV No.	692147	Ref. No.	36G6590
description	drive shaft for potato peeler device L 134mm		
For models:	P10, P102, P10M, P20, P202, P5		

lids



1

GEV No.	696454	Ref. No.	36Z6501
description	lid for potato peeler device ø 430mm ID ø 380mm plastic mounting distance 220mm H 80mm		
For models:	LCV, P10, P102, P10M, P20, P202, P5		
accessories for	696454		
	GEV No.	901522	Ref. No.
			—
	lid gasket suitable for FIMAR for potato peeler device L 1280mm external height 12mm external width 12mm		

abrasive side elements

grinding discs



1

GEV No.	696769	Ref. No.	3030900
description	peeling disk ø 383mm for potato peeler device C565		
For models:	MPK10, MPK10I, PK10, PK10I		

miscellaneous



1

GEV No.	696412	Ref. No.	3600870
description	bottom plastic		
For models:	P10, P102, P10M, P20, P202, P5		



1

GEV No.	696408	Ref. No.	36G5950
description	bush for potato peeler device ED ø 20mm ID ø 16mm thickness 2mm L 19.4mm		
For models:	LCV, P10, P102, P10M, P20, P202, P5		



1			
GEV No.	696407	Ref. No.	36D9660
description	deflector for potato peeler device plastic L 144mm W 38mm H 130mm thread 1/4"/M6		
For models:	P10, P102, P10M, P20, P202		



1			
GEV No.	696406	Ref. No.	3190830
description	disc for potato peeler device ED ø 42mm ID ø 28.7mm thickness 4.5mm		
For models:	LCV, P10, P102, P10M, P20, P202, P5		

for planetary mixers

beaters



1			
GEV No.	699393	Ref. No.	KA/W10731415
description	whisk shaft intake ø 12.7mm H 185mm suitable for KitchenAid		

for fridges

spare parts and accessories



1			
GEV No.	691195	Ref. No.	36G5250
description	bracket for rack plastic		
For models:	135, 135BX, 135CPX, SP135, SP135B, SP135BN, SP135CP, SP135NN, SP65, SP65B, SP65NB		

miscellaneous



1			
GEV No.	695580	Ref. No.	36D1250
description	frame L 1528mm W 55mm		
For models:	120, 120B, 120PV, 135, 135-4, 135A, 135B, 135BA, 135BX, 135BXE, 135BXR, 135CPX, 135PVX, 135X, 135X-3, 135X-4, 135XE, 135XR, SP120, SP120B, SP135, SP135B, SP135CP		



1			
GEV No.	695581	Ref. No.	36D1290
description	frame L 1639mm W 55mm		
For models:	120, 120B, 120NN, 120PV, 135, 135-4, 135A, 135B, 135BA, 135BN, 135BNX, 135BX, 135BXE, 135BXR, 135CPX, 135NN, 135NNX, 135PVX, 135X, 135X-3, 135X-4, 135XE, 135XR, 55, 55B, 55PV, 65, 65A, 65B, 65BA, 65BX, 65BX-2, 65BXE, 65BXR, 65NB, 65NBX, 65NN, 65NNX, 65PVX, 65X, 65X-2, 65XE, 65XR, SP120, SP120B, SP120BN, SP120NN, SP135, SP135B, SP135BN...(Other models you can see in the webshop)		

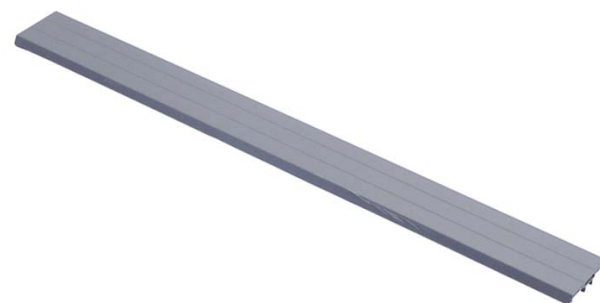

1			
GEV No.	695579	Ref. No.	36D1260
description	frame L 621mm W 55mm		
For models:	135-4, 135CPX, 135X-3, 135X-4, 65BX-2, 65NB, 65NBX, 65NN, 65NNX, 65X-2, SP135CP, SP65NB, SP65NN		



 <p>1</p>			
GEV No.	694636	Ref. No.	33Q6300
description	hose ID ø 21mm ED ø 27mm L 66mm ø 40mm thickness 3.5mm		
For models:	AF2B, AF2B-OPR01, AF2N, AF2N-OPR01, PGA20, PGA30, PGA40, PGA60, PGA80, PGW20, PGW30, PGW40, PGW60, PGW80, SM4SR		

 <p>1</p>			
GEV No.	690689	Ref. No.	35X3460
description	spacer ring		
For models:	40EV, 40EVP, 40PV, 40XPV		

 <p>1</p>			
GEV No.	690691	Ref. No.	36C2440
description	spacer ring		
For models:	40EV, 40EVP, 40PV, 40XPV		

 <p>1</p>			
GEV No.	698476	Ref. No.	36E3990
description	thermostatic steam trap W 55mm H 45mm for fridge D1 ø 22mm D2 ø 16mm		
For models:	6EA, 6EA11, 6EA11A, 6EA11M, 6EA13, 6EA13A, 6EA13M, 6EA2, 6EA2A, 6EA2M, 6EAA, 6EAB, 6EABA, 6EABM, 6EAM, 6EB, 6EB11, 6EB11A, 6EB11M, 6EB13, 6EB13A, 6EB13M, 6EB2, 6EB22, 6EB22A, 6EB22M, 6EB2A, 6EB2M, 6EB4, 6EB4A, 6EB4M, 6EBA, 6EBB, 6EBBA, 6EBBM, 6EBM, 6EC, 6EC11, 6EC11A, 6EC11M, 6EC13, 6EC13A, 6EC13M, 6EC2, 6EC22, 6EC22A, 6EC22M, 6EC2A, 6EC2M, 6EC4...(Other models you can see in the webshop)		

for refrigerated counters			
lid hinges			
 <p>1</p>			
GEV No.	691099	Ref. No.	35G4630
description	hinge for lid mounting pos. left		
For models:	SA87		

spare parts and accessories			
 <p>1</p>			
GEV No.	691189	Ref. No.	36G8660
description	bush L 9mm ID ø 7mm ext. ø 10		
For models:	6BMA11A, 6BMA11B, 6BMA11M, 6BMA11Z, 6BMA2A, 6BMA2B, 6BMA2M, 6BMA2Z, 6BMA3A, 6BMA3B, 6BMA3M, 6BMA3Z, 6BMAA, 6BMAB, 6BMABA, 6BMABB, 6BMABM, 6BMABZ, 6BMAM, 6BMAZ, 6BMB11A, 6BMB11B, 6BMB11M, 6BMB11Z, 6BMB22A, 6BMB22B, 6BMB22M, 6BMB22Z, 6BMB2A, 6BMB2B, 6BMB2M, 6BMB2Z, 6BMB3A, 6BMB3B, 6BMB3M, 6BMB3Z, 6BMB4A, 6BMB4B, 6BMB4M, 6BMB4Z, 6BMB A, 6BMBB, 6BMBBA, 6BMBBB, 6BMBBM, 6BMBBZ, 6BMBM, 6BMBZ, 6BMC11A, 6BMC11B...(Other models you can see in the webshop)		

 <p>1</p>			
GEV No.	698475	Ref. No.	3048360
description	drain pipe W 65mm H 145mm for refrigerated counters plastic Qty 1 pcs		
For models:	6EA, 6EA11, 6EA11A, 6EA11M, 6EA13, 6EA13A, 6EA13M, 6EA2, 6EA2A, 6EA2M, 6EAA, 6EAB, 6EABA, 6EABM, 6EAM, 6EB, 6EB11, 6EB11A, 6EB11M, 6EB13, 6EB13A, 6EB13M, 6EB2, 6EB22, 6EB22A, 6EB22M, 6EB2A, 6EB2M, 6EB4, 6EB4A, 6EB4M, 6EBA, 6EBB, 6EBBA, 6EBBM, 6EBM, 6EC, 6EC11, 6EC11A, 6EC11M, 6EC13, 6EC13A, 6EC13M, 6EC2, 6EC22, 6EC22A, 6EC22M, 6EC2A, 6EC2M, 6EC4...(Other models you can see in the webshop)		



1

GEV No.	697867	Ref. No.	3300030
description	drain tray for condensation water plastic		
For models:	120B, 135, 135-4, 135A, 135B, 135BA, 135BN, 135BNX, 135BX, 135BXE, 135BXR, 135CPX, 135NN, 135NNX, 135PVX, 135X, 135X-3, 135X-4, 135XE, 135XR, 40CP, 40CPX, 55B, 65, 65A, 65B, 65BA, 65BX, 65BX-2, 65BXE, 65BXR, 65NB, 65NBX, 65NN, 65NNX, 65PVX, 65X, 65X-2, 65XE, 65XR, 6BEA11A, 6BEA11B, 6BEA11M, 6BEA11Z, 6BEA2A, 6BEA2B, 6BEA2M, 6BEA2Z, 6BEA3A, 6BEA3B...(Other models you can see in the webshop)		

for freezer cabinets

glass panels



1

GEV No.	700682	Ref. No.	37W0270
description	glass panel L 190mm W 310mm mounting pos. lateral		
For models:	AL1433V, AL1437V, AL1633V, AL1637V, AL2033V, AL2037V, AL2533V, AL2537V, AR143V, AR147V, AR163V, AR167V, AR203V, AR207V, AR253V, AR257V, BP53V, BP64V, BP83V, BP94V, BPZ163A, BPZ163B, BPZ163S, BPZ167A, BPZ167B, BPZ167S, BPZ203A, BPZ203B, BPZ203S, BPZ207A, BPZ207B, BPZ207S, BPZ253A, BPZ253B, BPZ257A, BPZ257B, PE1633V, PE2033V, PM1633V, PM2033V, PZ1633A, PZ1633B, PZ1637A, PZ1637B, PZ2033A, PZ2033B, PZ2037A, PZ2037B, PZ2533A, PZ2533B...(Other models you can see in the webshop)		

for display coolers

glass panels

accessories



1

GEV No.	519386	Ref. No.	3190800
description	knurled nut for glass plate thread M4		
For models:	BRPRV, BRVRV, SE14PRV, SE14PRW, SE14VRV, SE14VRW, SI14PRV, SI14PRW, SI14VRV, SI14VRW, SL14RPRV, SL14RPRW, SL14RVRV, SL14RVRW, TPRV, TVRV		

for ice-cube maker

ice chutes

slide grates

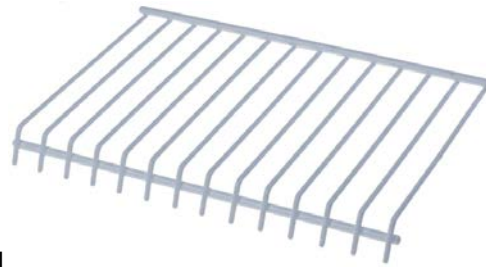

1

GEV No.	694145	Ref. No.	3020430
description	slide grate for ice-cube maker L 250mm W 170mm H 25mm		
For models:	PG22C, PG23CW		

hoses

miscellaneous



1

GEV No.	694636	Ref. No.	33Q6300
description	hose ID ø 21mm ED ø 27mm L 66mm ø 40mm thickness 3.5mm		
For models:	AF2B, AF2B-OPR01, AF2N, AF2N-OPR01, PGA20, PGA30, PGA40, PGA60, PGA80, PGW20, PGW30, PGW40, PGW60, PGW80, SM45R		

for espresso machines

brewing units

filter holder gaskets

O-rings



1

GEV No.	510409	Ref. No.	3150430 3151960 37Q5260
description	O-ring EPDM thickness 5.34mm ID ø 56.52mm Qty 1 pcs		
For models:	091CP1E, 0A1CP1E, 0G1CP1E, 0G1CP1EC, 0G1CP1E-VERS.2004, 191PI2E, 191PI2EA, 1A1PI2E, 1A1PI2EA, 1D1PI2E, 1D1PI2EA, 1G1PI1E, 30CPSE, 31PIE6, 6040090, 6040310, 6043850, 6043980, 70CPE, 71PIE15, 71PIE15A, 90CPE, 91PIE15, 91PIE15A, F60P, F60PR, F60T, F80P, F80PR, KD100, KD100A, KD100PSD, KD130, KD130A, KD130E, KD130EAT, KD60, KD60E, KD60EAT, KD60M, KD60MA, KD60ME, KD60MPS, KD60MPSA, KD60PS, KD60PSD, KD6EATSD, KD85, KD85A, KD85E...(Other models you can see in the webshop)		



screw connections

reducers



1

GEV No.	520700	Ref. No.	33Q5650
description	reducer thread 3/4" IT - 1/2" ET brass		
For models:	FCV101, FCV101-CSA, FCV101DM, FCV101DM-CSA, FCV101DS, FCV101DS-CSA, FCV101E, FCV101EDM, FCV101EDM-UL, FCV101EDS, FCV101EDS-UL, FCV101E-UL, FCV141, FCV141-CSA, FCV141DM, FCV141DM-CSA, FCV141DS, FCV141DS-CSA, FCV141E, FCV141EDM, FCV141EDS, FCV241, FCV241DM, FCV241DS, FCV241E, FCV241EDM, FCV241EDM-UL, FCV241EDS, FCV241EDS-UL, FCV241E-UL, FCV241G, FCV241G-CSA, FCV241GDM, FCV241GDM-CSA, FCV241GDS, FCV241GDS-CSA, FCV3EM, FCV401DM, FCV401DM-CSA, FCV401EDM, FCV401EDM-UL, FCV4E, FCV4EDS, FCV4EM, FCV61, FCV61-CSA, FCV61DM, FCV61DM-CSA, FCV61DS, FCV61DS-CSA...(Other models you can see in the webshop)		

for bain marie

housing and bezels

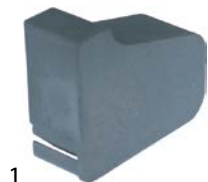

1

GEV No.	691183	Ref. No.	36D3430
description	end cap for control panel mounting pos. left		
For models:	030, 030BME, 030E, 030EBM, 030FE, 030FE1, 030FE1B, 030FT, 030FTE, 030FTER, 030FTR, 031, 031BME, 031E, 031EBM, 031FT, 031FT04, 031FT06, 031FTE, 031FTE04, 031FTE06, 031FTER, 031FTERL, 031FTR, 031FTRL, 031TP, 032, 070BM, 070BME, 070D, 070DGG, 070E, 070FT, 070FT04, 070FT05, 070FTE, 070FTE04, 070FTE05, 070FTER, 070FTR, 0712D, 0712VA, 071BM, 071BME, 071D, 071DGG, 071E, 071FT, 071FT04, 071FT06...(Other models you can see in the webshop)		



1

GEV No.	691184	Ref. No.	36D3420
description	end cap for control panel mounting pos. right		
For models:	030, 030BME, 030E, 030EBM, 030FE, 030FE1, 030FE1B, 030FT, 030FTE, 030FTER, 030FTR, 031, 031BME, 031E, 031EBM, 031FT, 031FT04, 031FT06, 031FTE, 031FTE04, 031FTE06, 031FTER, 031FTERL, 031FTR, 031FTRL, 031TP, 032, 070BM, 070BME, 070D, 070DGG, 070E, 070FT, 070FT04, 070FT05, 070FTE, 070FTE04, 070FTE05, 070FTER, 070FTR, 0712D, 0712VA, 071BM, 071BME, 071D, 071DGG, 071E, 071FT, 071FT04, 071FT06...(Other models you can see in the webshop)		

for deep fryers

housing and bezels

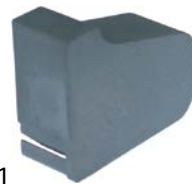

1

GEV No.	691183	Ref. No.	36D3430
description	end cap for control panel mounting pos. left		
For models:	030, 030BME, 030E, 030EBM, 030FE, 030FE1, 030FE1B, 030FT, 030FTE, 030FTER, 030FTR, 031, 031BME, 031E, 031EBM, 031FT, 031FT04, 031FT06, 031FTE, 031FTE04, 031FTE06, 031FTER, 031FTERL, 031FTR, 031FTRL, 031TP, 032, 070BM, 070BME, 070D, 070DGG, 070E, 070FT, 070FT04, 070FT05, 070FTE, 070FTE04, 070FTE05, 070FTER, 070FTR, 0712D, 0712VA, 071BM, 071BME, 071D, 071DGG, 071E, 071FT, 071FT04, 071FT06...(Other models you can see in the webshop)		



1

GEV No.	691184	Ref. No.	36D3420
description	end cap for control panel mounting pos. right		
For models:	030, 030BME, 030E, 030EBM, 030FE, 030FE1, 030FE1B, 030FT, 030FTE, 030FTER, 030FTR, 031, 031BME, 031E, 031EBM, 031FT, 031FT04, 031FT06, 031FTE, 031FTE04, 031FTE06, 031FTER, 031FTERL, 031FTR, 031FTRL, 031TP, 032, 070BM, 070BME, 070D, 070DGG, 070E, 070FT, 070FT04, 070FT05, 070FTE, 070FTE04, 070FTE05, 070FTER, 070FTR, 0712D, 0712VA, 071BM, 071BME, 071D, 071DGG, 071E, 071FT, 071FT04, 071FT06...(Other models you can see in the webshop)		

glass panels



1

GEV No.	693397	Ref. No.	3070970 37N1420
description	glass panel L 29mm W 29mm thickness 3.5mm square		
For models:	06WCP1GM, 08WCP1GM, 08WFT1GV, 08WFT2GV, 08WFT3GV, 08WFT4GV, 08WFT6GV, 08WFT7GV, 090FT1G, 090FT2G, 090FT4G, 090FT5G, 090FT7G, 091CP1G, 091FR7G, 091FR7GS, 091FR7G-VERS.052012, 091FR7GX, 0A0FT1G, 0A0FT2G, 0A0FT4G, 0A0FT5G, 0A1CP1G, 0B0FT1G, 0B0FT2G, 0B0FT4G, 0B0FT5G, 0B1CP1G, 0D0FT1G, 0D0FT2G, 0D0FT4G, 0D0FT5G, 0D1CP1G, 0G0FT1G, 0G0FT1G-VERS.032008, 0G0FT2G, 0G0FT2G-VERS.032008, 0G0FT4G, 0G0FT4G-VERS.032008, 0G0FT5G, 0G0FT5G-VERS.032008, 0G0FT7G, 0G1CP1G, 0G1CP1G-VERS.2004, 0G1FR7G, 10CP1GA, 10CP1IA, 10WTPGE, 10WTPGV, 12CP1GA...(Other models you can see in the webshop)		

miscellaneous



1

GEV No.	691164	Ref. No.	36D6960
description	bar for spacer L 180mm thread M6x1		
For models:	030FE1, 030FE1B, 091FE28, 091FE28B, 30FES2, 30FES2B, 70FES2, 70FES2B		

1 

GEV No.	691163	Ref. No.	36D6950
description	bar for spacer L 270mm thread M6x1		
For models:	70FE1, 70FE1B, 71FE2, 71FE2B		

1 

GEV No.	541506	Ref. No.	33Q5730
description	screw connection complete thread 1"		
For models:	30CPS, 30CPSE, 70CP, 70CPE, 71CP, 71CP2, 90CP, 90CPE, 91CP		

1 

GEV No.	691121	Ref. No.	36D7150
description	support bracket for heating element		
For models:	030FE1, 030FE1B, 091FE28, 091FE28B, 30FES2, 30FES2B, 70FES2, 70FES2B		

for grills



GEV No.	690425	Ref. No.	3600770
description	base plate L 105mm W 35mm H 7mm hole distance 76mm hole ø 12mm		
For models:	120, 120B, 120NN, 120PV, 135, 135-4, 135A, 135B, 135BA, 135BN, 135BNX, 135BX, 135BXE, 135BXR, 135CPX, 135NN, 135NNX, 135PVX, 135X, 135X-3, 135X-4, 135XE, 135XR, 55, 55B, 55PV, 65, 65A, 65B, 65BA, 65BX, 65BX-2, 65BXE, 65BXR, 65NB, 65NBX, 65NN, 65NNX, 65PVX, 65X, 65X-2, 65XE, 65XR, ART1LD, ART1LDA, ART2LD, ART2SD, ART3SD, S125, S125-4...(Other models you can see in the webshop)		

for griddles

spare parts and accessories



GEV No.	691169	Ref. No.	35T2260
description	hook for solid top		
For models:	031TP, 071TP, 091TP, 31TP, 32TP, 32TPV, 71TP, 72TP, 72TPGG		



GEV No.	693000	Ref. No.	35Y2780
description	spring for lava rock grid		
For models:	08WGRGV, 090GRG, 0A0GRG, 0D0GRG, 190GRG, 1A0GRG, 1D0GRG, 1G0GRG		

housing and bezels

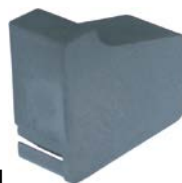

GEV No.	691183	Ref. No.	36D3430
description	end cap for control panel mounting pos. left		
For models:	030, 030BME, 030E, 030EBM, 030FE, 030FE1, 030FE1B, 030FT, 030FTE, 030FTER, 030FTR, 031, 031BME, 031E, 031EBM, 031FT, 031FT04, 031FT06, 031FTE, 031FTE04, 031FTE06, 031FTER, 031FTERL, 031FTR, 031FTRL, 031TP, 032, 070BM, 070BME, 070D, 070DGG, 070E, 070FT, 070FT04, 070FT05, 070FTE, 070FTE04, 070FTE05, 070FTER, 070FTR, 0712D, 0712VA, 071BM, 071BME, 071D, 071DGG, 071E, 071FT, 071FT04, 071FT06...(Other models you can see in the webshop)		



GEV No.	691184	Ref. No.	36D3420
description	end cap for control panel mounting pos. right		
For models:	030, 030BME, 030E, 030EBM, 030FE, 030FE1, 030FE1B, 030FT, 030FTE, 030FTER, 030FTR, 031, 031BME, 031E, 031EBM, 031FT, 031FT04, 031FT06, 031FTE, 031FTE04, 031FTE06, 031FTER, 031FTERL, 031FTR, 031FTRL, 031TP, 032, 070BM, 070BME, 070D, 070DGG, 070E, 070FT, 070FT04, 070FT05, 070FTE, 070FTE04, 070FTE05, 070FTER, 070FTR, 0712D, 0712VA, 071BM, 071BME, 071D, 071DGG, 071E, 071FT, 071FT04, 071FT06...(Other models you can see in the webshop)		



sumps



1

GEV No.	691207	Ref. No.	35N2250
description	grease collecting tray L 540mm W 32mm H 15mm		
For models:	0A0FT1E, 0A0FT1G, 0A0FT2E, 0A0FT2G, 0A0FT4E, 0A0FT4G, 0A0FT5E, 0A0FT5G, 0B0FT1G, 0B0FT2G, 0B0FT4G, 0B0FT5G, 0D0FT1E, 0D0FT1G, 0D0FT2E, 0D0FT2G, 0D0FT4E, 0D0FT4G, 0D0FT5E, 0D0FT5G, 0G0FT1E, 0G0FT1G, 0G0FT1G-VERS.032008, 0G0FT2E, 0G0FT2G, 0G0FT2G-VERS.032008, 0G0FT4E, 0G0FT4G, 0G0FT4G-VERS.032008, 0G0FT5E, 0G0FT5G, 0G0FT5G-VERS.032008, 0G0FT7E, 0G0FT7G		

drain stoppers



1

GEV No.	691190	Ref. No.	3062770 3115040 36C0360
description	outflow plug PTFE L 52mm D1 ø 40mm D2 ø 33mm D3 ø 28mm		
For models:	031FT04, 031FT06, 031FTE04, 031FTE06, 06WFT1EV, 06WFT2EV, 06WFT3EV, 06WFT4EV, 06WFT6EV, 06WFT7EV, 070FT04, 070FT05, 070FTE04, 070FTE05, 071FT04, 071FT06, 071FTE04, 071FTE06, 08WFT1EV, 08WFT1GV, 08WFT2EV, 08WFT2GV, 08WFT3EV, 08WFT-3GV, 08WFT4EV, 08WFT4GV, 08WFT6EV, 08WFT6GV, 08WFT7EV, 08WFT7GV, 08WGREV, 090FT04, 090FT05, 090FT1E, 090FT1G, 090FT2E, 090FT2G, 090FT4E, 090FT4G, 090FT5E, 090FT5G, 090FT7E, 090FT7G, 090FTE04, 090FTE05, 091FT04, 091FT06, 091FT1E, 091FT2E, 091FT5E...(Other models you can see in the webshop)		

for convection ovens/combi-steamers

drain valves



1

GEV No.	696773	Ref. No.	6300833
description	drain fitting set for combi-steamer hose ø 8mm		
For models:	FX101E3, FX101E3C, FX101E3C-VERS.022014, FX101E3R, FX101E3R-VERS.022014, FX101E3-VERS.022014, FX101G3, FX101G3C, FX101G3C-VERS.022014, FX101G3R, FX101G3R-VERS.022014, FX101G3-VERS.022014, FX10E3CR, FX10E3CR-VERS.022014, FX10G3CR, FX10G3CR-VERS.022014, FX122E3, FX122E3C, FX122E3T, FX122E3T-VERS.022014, FX122G3, FX122G3C, FX122G3T, FX122G3T-VERS.022014, FX12E3CT, FX12E3CT-VERS.022014, FX12G3CT, FX12G3CT-VERS.022014, FX201E3, FX201E3P, FX201E3P-VERS.022014, FX201E3-VERS.022014, FX201G3P, FX201G3-VERS.022014, FX202E3, FX202E3-230V-3-50Hz-60Hz, FX202E3-230V-3-50Hz-60Hz-VERS.022014, FX202E3-VERS.022014, FX202G3, FX202G3-VERS.022014, FX61E3, FX61E3C, FX61E3CR, FX61E3CR-VERS.022014, FX61E3C-VERS.022014, FX61E3R, FX61E3R-VERS.022014, FX61E3-VERS.022014, FX61G3, FX61G3C...(Other models you can see in the webshop)		



1

GEV No.	696790	Ref. No.	30Z3011
description	drain pipe thread 1 1/2" IT angled 90° plastic ID ø 37mm ED ø 40mm for combi-steamer		
For models:	FC1011E, FC1011G, FC1221E, FC1221G, FC611E, FC611G, FM1011E1-VERS.2006, FM1011E2-VERS.2006, FM1011E3-VERS.2006, FM1011G1-VERS.2006, FM1011G2-VERS.2006, FM1011G3-VERS.2006, FM1221E1-VERS.2006, FM1221E2-VERS.2006, FM1221E3-VERS.2006, FM1221G1-VERS.2006, FM1221G2-VERS.2006, FM1221G3-VERS.2006, FM2011E2-VERS.2006, FM2011E3-VERS.2006, FM2011G2-VERS.2006, FM2011G3-VERS.2006, FM2021E2-VERS.2006, FM2021E3-VERS.2006, FM2021G2-VERS.2006, FM2021G3-VERS.2006, FM611E1-VERS.2006, FM611E2-VERS.2006, FM611E3-VERS.2006, FM611G1-VERS.2006, FM611G2-VERS.2006, FM611G3-VERS.2006, FM721E1-VERS.2006, FM721E2-VERS.2006, FM721E3-VERS.2006, FM721G1-VERS.2006, FM721G2-VERS.2006, FM721G3-VERS.2006		



1

GEV No.	696788	Ref. No.	3120620 3215240
description	drain pipe thread 1 1/2" IT T-piece plastic ID ø 37mm ED ø 40mm for combi-steamer		
For models:	BX101E, BX101E-VERS.122013, BX101G, BX101G-VERS.122013, BX61E, BX61E-VERS.122013, BX61G, BX61G-VERS.122013, FX101E1, FX101E1R, FX101E2, FX101E2C, FX101E2C-VERS.032014, FX101E2R, FX101E2R-VERS.032014, FX101E2-VERS.032014, FX101E3, FX101E3C, FX101E3C-VERS.022014, FX101E3R, FX101E3R-VERS.022014, FX101E3-VERS.022014, FX101G1, FX101G1R, FX101G2, FX101G2C, FX101G2C-VERS.032014, FX101G2R, FX101G2R-VERS.032014, FX101G2-VERS.032014, FX101G3, FX101G3C, FX101G3C-VERS.022014, FX101G3R, FX101G3R-VERS.022014, FX101G3-VERS.022014, FX10E2CR, FX10E2CR-VERS.032014, FX10E3CR, FX10E3CR-VERS.022014, FX10G2CR, FX10G2CR-VERS.032014, FX10G3CR, FX10G3CR-VERS.022014, FX61E1, FX61E1R, FX61E2, FX61E2C, FX61E2CR, FX61E2CR-VERS.032014...(Other models you can see in the webshop)		



1

GEV No.	692880	Ref. No.	36A3400 36A3401
description	bush ID ø 34mm ED ø 60mm L 20mm thread 1 1/4" ET		
For models:	BX101E, BX101E-VERS.122013, BX101G, BX101G-VERS.122013, BX122E, BX122E-VERS.122013, BX122G, BX122G-VERS.122013, BX61E, BX61E-VERS.122013, BX61G, BX61G-VERS.122013, BX82E, BX82E-VERS.122013, BX82G, BX82G-VERS.122013, FC101, FC1011E, FC1011G, FC101E, FC1221E, FC1221G, FC241, FC241E, FC241G, FC61, FC611E, FC611G, FC61E, FCV101, FCV101-CSA, FCV101DM, FCV101DM-CSA, FCV101DS, FCV101DS-CSA, FCV101E, FCV101EDM, FCV101EDM-UL, FCV101EDS, FCV101EDS-UL, FCV101E-UL, FCV141, FCV141-CSA, FCV141DM, FCV141DM-CSA, FCV141DS, FCV141DS-CSA, FCV141E, FCV141EDM, FCV141EDS...(Other models you can see in the webshop)		

steam pipes



1

GEV No.	691639	Ref. No.	33Q6230
description	bush stainless steel L 31mm ID ø 33mm ED ø 35mm		
For models:	FC101, FC241, FC241G, FC61, FCV101, FCV101-CSA, FCV101DM, FCV101DM-CSA, FCV101DS, FCV101DS-CSA, FCV141, FCV141-CSA, FCV141DM, FCV141DM-CSA, FCV141DS, FCV141DS-CSA, FCV241, FCV241DM, FCV241DS, FCV241G, FCV241G-CSA, FCV241GDM, FCV241GDM-CSA, FCV241GDS, FCV241GDS-CSA, FCV401DM, FCV401DM-CSA, FCV61, FCV61-CSA, FCV61DM, FCV61DM-CSA, FCV61DS, FCV61DS-CSA		



1

GEV No.	540906	Ref. No.	33Q5980
description	steam nozzle plastic L 78.5mm ID ø 12.5mm ED ø 40mm		
For models:	FC101, FC1011E, FC1011G, FC101E, FC1221E, FC1221G, FC241, FC241E, FC241G, FC61, FC611E, FC611G, FC61E, FCV101, FCV101-CSA, FCV101DM, FCV101DM-CSA, FCV101DS, FCV101DS-CSA, FCV101E, FCV101EDM, FCV101EDM-UL, FCV101EDS, FCV101EDS-UL, FCV101E-UL, FCV141, FCV141-CSA, FCV141DM, FCV141DM-CSA, FCV141DS, FCV141DS-CSA, FCV141E, FCV141EDM, FCV141EDS, FCV241, FCV241DM, FCV241DS, FCV241E, FCV241EDM, FCV241EDM-UL, FCV241EDS, FCV241EDS-UL, FCV241E-UL, FCV241G, FCV241G-CSA, FCV241GDM, FCV241GDM-CSA, FCV241GDS, FCV241GDS-CSA, FCV61...(Other models you can see in the webshop)		

injection nozzles





1

GEV No.	692721	Ref. No.	33Q5441 33Q5442
description	injection nozzle bore ø 0.5mm D1 ø 12mm D2 ø 12mm L 60mm WS 17 brass for combi-steamer thread 1/8"		
For models:	FC61, FC61E, FCV61, FCV61-CSA, FCV61DM, FCV61DM-CSA, FCV61DS, FCV61DS-CSA, FCV61E, FCV61EDM, FCV61EDM-UL, FCV61EDS, FCV61EDS-UL, FCV61E-UL, FM611E1, FM611E2, FM611E3, FM611G1, FM611G2, FM611G3		



1

GEV No.	541487	Ref. No.	33Q5910 33Q5911
description	injection nozzle bore ø 7/0.6mm D1 ø 12mm D2 ø 12mm L 60mm WS 17 brass for combi-steamer thread 1/8"		
For models:	FC101, FC101E, FCV101, FCV101-CSA, FCV101DM, FCV101DM-CSA, FCV101DS, FCV101DS-CSA, FCV101E, FCV101EDM, FCV101EDM-UL, FCV101EDS, FCV101EDS-UL, FCV101E-UL, FCV401DM, FM1011E1, FM1011E2, FM1011E3, FM1011G1, FM1011G2, FM1011G3		
accessories for	541487		
	GEV No.	541508	Ref. No. 33D1680
	manometer ø 40mm pressure range 0-4bar connection thread 1/8"		





1

GEV No.	542427	Ref. No.	33Q6081
description	injection nozzle bore ø 7/0.7mm D1 ø 12mm D2 ø 12mm L 60mm WS 17 brass for combi-steamer thread 1/8"		
For models:	FC241E, FC241G, FCV141, FCV141-CSA, FCV141DM, FCV141DM-CSA, FCV141DS, FCV141DS-CSA, FCV141E, FCV141EDM, FCV141EDS, FCV241E, FCV241EDM, FCV241EDM-UL, FCV241EDS, FCV241EDS-UL, FCV241E-UL, FCV241G, FCV241G-CSA, FCV241GDM, FCV241GDM-CSA, FCV241GDS, FCV241GDS-CSA, FCV401EDM, FCV401EDM-UL, FCV72EDM-UL, FCV72EDS-UL, FCV72E-UL, FM1221E1, FM1221E2, FM1221E3, FM1221G1, FM1221G2, FM1221G3, FM721E1, FM721E2, FM721E3, FM721G1, FM721G2, FM721G3		



 <p>1</p>			
GEV No.	542425	Ref. No.	33Q5920 33Q5921
description	injection nozzle bore \varnothing 7/4.5mm D1 \varnothing 12mm D2 \varnothing 12mm L 60mm WS 17 brass for combi-steamer thread 1/8"		
For models:	FC101, FC101E, FC241, FC241E, FC241G, FC61, FC61E, FCV101, FCV101-CSA, FCV101DM, FCV101DM-CSA, FCV101DS, FCV101DS-CSA, FCV101E, FCV101EDM, FCV101EDM-UL, FCV101EDS, FCV101EDS-UL, FCV101E-UL, FCV141, FCV141-CSA, FCV141DM, FCV141DM-CSA, FCV141DS, FCV141DS-CSA, FCV141E, FCV141EDM, FCV141EDS, FCV241, FCV241DM, FCV241DS, FCV241E, FCV241EDM, FCV241EDM-UL, FCV241EDS, FCV241EDS-UL, FCV241E-UL, FCV241G, FCV241G-CSA, FCV241GDM, FCV241GDM-CSA, FCV241GDS, FCV241GDS-CSA, FCV401DM, FCV401DM-CSA, FCV401EDM, FCV401EDM-UL, FCV61, FCV61-CSA, FCV61DM...(Other models you can see in the webshop)		

 <p>1</p>			
GEV No.	542429	Ref. No.	33T4450
description	nozzle bore \varnothing 5/3.65mm L 24mm WS 12 brass thread M10x1		

 <p>1</p>			
GEV No.	541507	Ref. No.	33T4110
description	nozzle cooling thread 1/8"		
For models:	FCV3EM, FCV4E, FCV4EDS, FCV4EM, FM423E1, FM423E2		
accessories for	541507		
	 <p>GEV No.</p>	541488	<p>Ref. No.</p> <p>33Q5591 33Q5592</p>
	hose connector thread M14x1 ET - 1/8" IT angled		

 <p>1</p>			
GEV No.	541509	Ref. No.	33T3720
description	nozzle cooling thread 1/8"		
For models:	FC101, FC101E, FC241, FC241E, FC241G, FC61, FC61E, FCV101, FCV101-CSA, FCV101DM, FCV101DM-CSA, FCV101DS, FCV101DS-CSA, FCV101E, FCV101EDM, FCV101EDM-UL, FCV101EDS, FCV101EDS-UL, FCV101E-UL, FCV141, FCV141-CSA, FCV141DM, FCV141DM-CSA, FCV141DS, FCV141DS-CSA, FCV141E, FCV141EDM, FCV141EDS, FCV241, FCV241DM, FCV241DS, FCV241E, FCV241EDM, FCV241EDM-UL, FCV241EDS, FCV241EDS-UL, FCV241E-UL, FCV241G, FCV241G-CSA, FCV241GDM, FCV241GDM-CSA, FCV241GDS, FCV241GDS-CSA, FCV401DM, FCV401DM-CSA, FCV401EDM, FCV401EDM-UL, FCV61, FCV61-CSA, FCV61DM...(Other models you can see in the webshop)		
accessories for	541509		
	 <p>GEV No.</p>	541488	<p>Ref. No.</p> <p>33Q5591 33Q5592</p>
	hose connector thread M14x1 ET - 1/8" IT angled		

<p>spare parts and accessories</p>  <p>1</p>			
GEV No.	108153	Ref. No.	6300748
description	burner blower combi-steamer 230V 65W hole distance 50mm NRG118/0800-3612-030204		
For models:	BX101G, BX101G-VERS.122013, BX122G, BX122G-VERS.122013, BX61G, BX61G-VERS.122013, BX82G, BX82G-VERS.122013, FX101G1, FX101G1R, FX101G2, FX101G2C, FX101G2C-VERS.032014, FX101G2R, FX101G2R-VERS.032014, FX101G2-VERS.032014, FX101G3, FX101G3C, FX101G3C-VERS.022014, FX101G3R, FX101G3R-VERS.022014, FX101G3-VERS.022014, FX10G2CR, FX10G2CR-VERS.032014, FX10G3CR, FX10G3CR-VERS.022014, FX122G1, FX122G2, FX122G2C, FX122G2T, FX122G2T-VERS.032014, FX122G3, FX122G3C, FX122G3T, FX122G3T-VERS.022014, FX12G3CT, FX12G3CT-VERS.022014, FX201G2, FX201G2P, FX201G2P-VERS.032014, FX201G2-VERS.032014, FX201G3P, FX201G3-VERS.022014, FX202G2, FX202G2-VERS.032014, FX202G3, FX202G3-VERS.022014, FX61G1, FX61G1R, FX61G2...(Other models you can see in the webshop)		

 <p>1</p>			
GEV No.	542426	Ref. No.	3007200
description	connecting piece for combi-steamer L 22mm \varnothing 13.5mm WS 14 1/8" ET - 1/8" IT		
For models:	FM1011E2-VERS.2006, FM1011E3, FM1011E3-VERS.2006, FM1011G2-VERS.2006, FM1011G3, FM1011G3-VERS.2006, FM1221E2-VERS.2006, FM1221E3, FM1221E3-VERS.2006, FM1221G2-VERS.2006, FM1221G3, FM1221G3-VERS.2006, FM2011E2-VERS.2006, FM2011E3-VERS.2006, FM2011G2-VERS.2006, FM2011G3-VERS.2006, FM2021E2-VERS.2006, FM2021E3, FM2021E3-VERS.2006, FM2021G2-VERS.2006, FM2021G3, FM2021G3-VERS.2006, FM423E2, FM611E2-VERS.2006, FM611E3, FM611E3-VERS.2006, FM611G2-VERS.2006, FM611G3, FM611G3-VERS.2006, FM721E2-VERS.2006, FM721E3, FM721E3-VERS.2006, FM721G2-VERS.2006, FM721G3, FM721G3-VERS.2006		

 <p>1</p>			
GEV No.	551447	Ref. No.	3091170
description	connecting piece for combi-steamer stainless steel L 162mm \varnothing 10mm		

 <p>1</p>			
GEV No.	552007	Ref. No.	33Q5641
description	connecting piece incl reducer 1/2" - 3/4" L 48mm brass for combi-steamer		
For models:	FCV101, FCV101-CSA, FCV101DM, FCV101DM-CSA, FCV101DS, FCV101DS-CSA, FCV101E, FCV101EDM, FCV101EDM-UL, FCV101EDS, FCV101EDS-UL, FCV101E-UL, FCV141, FCV141-CSA, FCV141DM, FCV141DM-CSA, FCV141DS, FCV141DS-CSA, FCV141E, FCV141EDM, FCV141EDS, FCV241, FCV241DM, FCV241DS, FCV241E, FCV241EDM, FCV241EDM-UL, FCV241EDS, FCV241EDS-UL, FCV241E-UL, FCV241G, FCV241G-CSA, FCV241GDM, FCV241GDM-CSA, FCV241GDS, FCV241GDS-CSA, FCV3EM, FCV401DM, FCV401DM-CSA, FCV401EDM, FCV401EDM-UL, FCV4E, FCV4EDS, FCV4EM, FCV61, FCV61-CSA, FCV61DM, FCV61DM-CSA, FCV61DS, FCV61DS-CSA...(Other models you can see in the webshop)		



			
1			
GEV No.	551446	Ref. No.	3003760
description	connecting piece L 42mm WS 14 1/8" IT - 1/8" ET		
For models:	FM1011E2-VERS.2006, FM1011E3, FM1011E3-VERS.2006, FM1011G2-VERS.2006, FM1011G3, FM1011G3-VERS.2006, FM1221E2-VERS.2006, FM1221E3, FM1221E3-VERS.2006, FM1221G2-VERS.2006, FM1221G3, FM1221G3-VERS.2006, FM2011E2-VERS.2006, FM2011E3-VERS.2006, FM2011G2-VERS.2006, FM2011G3-VERS.2006, FM2021E2-VERS.2006, FM2021E3, FM2021E3-VERS.2006, FM2021G2-VERS.2006, FM2021G3, FM2021G3-VERS.2006, FM611E2-VERS.2006, FM611E3, FM611E3-VERS.2006, FM611G2-VERS.2006, FM611G3, FM611G3-VERS.2006, FM721E2-VERS.2006, FM721E3, FM721E3-VERS.2006, FM721G2-VERS.2006, FM721G3, FM721G3-VERS.2006, FX201E3, FX201E3P, FX201E3P-VERS.022014, FX201E3-VERS.022014, FX201G3P, FX201G3-VERS.022014, FX202E3, FX202E3-230V-3-50Hz-60Hz, FX202E3-230V-3-50Hz-60Hz-VERS.022014, FX202E3-VERS.022014, FX202G3, FX202G3-VERS.022014		

			
1			
GEV No.	691742	Ref. No.	3120030
description	disc ext. ø 30		
For models:	FCV241G-CSA, FCV241GDM-CSA, FCV241GDS-CSA, L80		

			
1			
GEV No.	541503	Ref. No.	33Q0530
description	end cap for hot air oven thread 3/8"		
For models:	FC1011E, FC1011G, FC1221E, FC1221G, FC611E, FC611G, FCV101DM, FCV101DM-CSA, FCV101DS, FCV101DS-CSA, FCV101EDM, FCV101EDM-UL, FCV101EDS, FCV101EDS-UL, FCV141DM, FCV141DM-CSA, FCV141DS, FCV141DS-CSA, FCV141EDM, FCV141EDS, FCV241DM, FCV241DS, FCV241EDM, FCV241EDM-UL, FCV241EDS, FCV241EDS-UL, FCV241GDM, FCV241GDM-CSA, FCV241GDS, FCV241GDS-CSA, FCV401DM, FCV401DM-CSA, FCV61DM, FCV61DM-CSA, FCV61DS, FCV61DS-CSA, FCV61EDM, FCV61EDM-UL, FCV61EDS, FCV61EDS-UL, FCV72EDM-UL, FCV72EDS-UL, FM1011E1-VERS.2006, FM1011E2, FM1011E3, FM1011G1-VERS.2006, FM1011G2, FM1011G3, FM1221E1-VERS.2006, FM1221G1-VERS.2006...(Other models you can see in the webshop)		

			
1			
GEV No.	691192	Ref. No.	36D0360
description	flange		

			
1			
GEV No.	521194	Ref. No.	36E2350
description	gasket for heat exchanger combi-steamer ID ø 40mm hole distance 52mm thickness 4mm		
For models:	BX101G, BX101G-VERS.122013, BX61G, BX61G-VERS.122013, FC1011G, FM1011G1, FM1011G1-VERS.2006, FM1011G2, FM1011G2-VERS.2006, FM1011G3, FM1011G3-VERS.2006, FX101G1, FX101G1R, FX101G2, FX101G2C, FX101G2C-VERS.032014, FX101G2R, FX101G2R-VERS.032014, FX101G2-VERS.032014, FX101G3, FX101G3C, FX101G3C-VERS.022014, FX101G3R, FX101G3R-VERS.022014, FX101G3-VERS.022014, FX10G2CR, FX10G2CR-VERS.032014, FX10G3CR, FX10G3CR-VERS.022014, FX201G2, FX201G2P, FX201G2P-VERS.032014, FX201G2-VERS.032014, FX201G3P, FX201G3-VERS.022014, FX61G1, FX61G1R, FX61G2, FX61G2C, FX61G2CR, FX61G2CR-VERS.032014, FX61G2C-VERS.032014, FX61G2R, FX61G2R-VERS.032014, FX61G2-VERS.032014, FX61G3, FX61G3C, FX61G3CR, FX61G3CR-VERS.022014, FX61G3C-VERS.022014...(Other models you can see in the webshop)		

			
1			
GEV No.	691199	Ref. No.	36G5380
description	guide counterweight ø 37mm		
For models:	FC101, FC101E, FC241, FC241E, FC241G, FC61, FC61E, FCV101, FCV101-CSA, FCV101DM, FCV101DM-CSA, FCV101DS, FCV101DS-CSA, FCV101E, FCV101EDM, FCV101EDM-UL, FCV101EDS, FCV101EDS-UL, FCV101E-UL, FCV141, FCV141-CSA, FCV141DM, FCV141DM-CSA, FCV141DS, FCV141DS-CSA, FCV141E, FCV141EDM, FCV141EDS, FCV241, FCV241DM, FCV241DS, FCV241E, FCV241EDM, FCV241EDM-UL, FCV241EDS, FCV241EDS-UL, FCV241E-UL, FCV241G, FCV241G-CSA, FCV241GDM, FCV241GDM-CSA, FCV241GDS, FCV241GDS-CSA, FCV61, FCV61-CSA, FCV61DM, FCV61DM-CSA, FCV61DS, FCV61DS-CSA, FCV61E...(Other models you can see in the webshop)		

			
1			
GEV No.	691176	Ref. No.	35T0080
description	guide plate ø 60mm		

			
1			
GEV No.	691177	Ref. No.	35S8650
description	mounting ring for bulb socket		



			
1			
GEV No.	696791	Ref. No.	3011590 3253680
description	protective covering for igniter L 80mm 7/9 rubber		
For models:	091FR1I, 091FR1IA, 091FR1ID, 091FR1ID-VERS.052012, 091FR1I-VERS.032012, 091FR7G, 091FR7GS, 091FR7G-VERS.052012, 091FR7GX, 10CP1IA, 12CP1IA, 18CP2IA, 191FR2I, 191FR2ID, 191FR2ID-VERS.092012, 191FR2I-VERS.032012, BX101G, BX122G, BX61G, BX82G, FC1011G, FC1221G, FC611G, FM1011G1, FM1011G1-VERS.2006, FM1011G2, FM1011G2-VERS.2006, FM1011G3, FM1011G3-VERS.2006, FM1221G1, FM1221G1-VERS.2006, FM1221G2, FM1221G2-VERS.2006, FM1221G3, FM1221G3-VERS.2006, FM2011G2-VERS.2006, FM2011G3-VERS.2006, FM2021G1, FM2021G2, FM2021G2-VERS.2006, FM2021G3, FM2021G3-VERS.2006, FM611G1, FM611G1-VERS.2006, FM611G2, FM611G2-VERS.2006, FM611G3, FM611G3-VERS.2006, FM721G1, FM721G1-VERS.2006...(Other models you can see in the webshop)		

			
2			
GEV No.	541495	Ref. No.	33Q5630
description	reducer for hot air oven L 44mm WS 21 IT 3/8" ET M16x1.5		
For models:	FC101, FC101E, FC241, FC241E, FC241G, FC61, FC61E, FCV101, FCV101-CSA, FCV101DM, FCV101DM-CSA, FCV101DS, FCV101DS-CSA, FCV101E, FCV101EDM, FCV101EDM-UL, FCV101EDS, FCV101EDS-UL, FCV101E-UL, FCV141, FCV141-CSA, FCV141DM, FCV141DM-CSA, FCV141DS, FCV141DS-CSA, FCV141E, FCV141EDM, FCV141EDS, FCV241, FCV241DM, FCV241DS, FCV241E, FCV241EDM, FCV241EDM-UL, FCV241EDS, FCV241EDS-UL, FCV241E-UL, FCV241G, FCV241G-CSA, FCV241GDM, FCV241GDM-CSA, FCV241GDS, FCV241GDS-CSA, FCV401DM, FCV401DM-CSA, FCV401EDM, FCV401EDM-UL, FCV61, FCV61-CSA, FCV61DM...(Other models you can see in the webshop)		

			
1			
GEV No.	691167	Ref. No.	36D9150
description	ring ID ø 26mm ext. ø 30 thickness 1.5mm		

			
1			
GEV No.	541498	Ref. No.	33Q5410
description	screw connection WS 50 thread 1/4" ID ø 31mm		
For models:	FC101, FC101E, FC241, FC241E, FC241G, FC61, FC61E, FCV101, FCV101-CSA, FCV101DM, FCV101DM-CSA, FCV101DS, FCV101DS-CSA, FCV101E, FCV101EDM, FCV101EDM-UL, FCV101EDS, FCV101EDS-UL, FCV101E-UL, FCV141, FCV141-CSA, FCV141DM, FCV141DM-CSA, FCV141DS, FCV141DS-CSA, FCV141E, FCV141EDM, FCV141EDS, FCV241, FCV241DM, FCV241DS, FCV241E, FCV241EDM, FCV241EDM-UL, FCV241EDS, FCV241EDS-UL, FCV241E-UL, FCV241G, FCV241G-CSA, FCV241GDM, FCV241GDM-CSA, FCV241GDS, FCV401DM, FCV401DM-CSA, FCV401EDM, FCV401EDM-UL, FCV61, FCV61-CSA, FCV61DM, FCV61DM-CSA...(Other models you can see in the webshop)		
accessories for	541498		
	GEV No.	Ref. No.	
	541499	3151450	
	gasket suitable for ANGELO PO size 1/4"		

			
1			
GEV No.	691160	Ref. No.	36G0060
description	spring guide		

			
1			
GEV No.	551445	Ref. No.	3004791
description	water distributor for combi-steamer chrome-plated sheet steel L 92mm ø 35mm		
For models:	FM1011E1, FM1011E1-VERS.2006, FM1011E2, FM1011E2-VERS.2006, FM1011E3, FM1011E3-VERS.2006, FM1011G1, FM1011G1-VERS.2006, FM1011G2, FM1011G2-VERS.2006, FM1011G3, FM1011G3-VERS.2006, FM1221E1, FM1221E1-VERS.2006, FM1221E2, FM1221E2-VERS.2006, FM1221E3, FM1221E3-VERS.2006, FM1221G1, FM1221G1-VERS.2006, FM1221G2, FM1221G2-VERS.2006, FM1221G3, FM1221G3-VERS.2006, FM2011E2-VERS.2006, FM2011E3-VERS.2006, FM2011G2-VERS.2006, FM2011G3-VERS.2006, FM2021E1, FM2021E2, FM2021E2-VERS.2006, FM2021E3, FM2021E3-VERS.2006, FM2021G1, FM2021G2, FM2021G2-VERS.2006, FM2021G3, FM2021G3-VERS.2006, FM611E1, FM611E1-VERS.2006, FM611E2, FM611E2-VERS.2006, FM611E3, FM611E3-VERS.2006, FM611G1, FM611G1-VERS.2006, FM611G2, FM611G2-VERS.2006, FM611G3, FM611G3-VERS.2006...(Other models you can see in the webshop)		

			
1			
GEV No.	691165	Ref. No.	36G0190
description	wheel W 35mm ø 44mm		

			
1			
GEV No.	521197	Ref. No.	36E4290
description	Y-piece thread 1/8" IT - 1/8" IT - 1/8" IT stainless steel WS 13		
For models:	FM1011E3, FM1011G3, FM1221E3, FM1221G3, FM611E3, FM611G3, FM721E3, FM721G3		

glass panels

			
1			
GEV No.	693397	Ref. No.	3070970 37N1420
description	glass panel L 29mm W 29mm thickness 3.5mm square		
For models:	06WCP1GM, 08WCP1GM, 08WFT1GV, 08WFT2GV, 08WFT3GV, 08WFT4GV, 08WFT6GV, 08WFT7GV, 090FT1G, 090FT2G, 090FT4G, 090FT5G, 090FT7G, 091CP1G, 091FR7G, 091FR7GS, 091FR7G-VERS.052012, 091FR7GX, 0A0FT1G, 0A0FT2G, 0A0FT4G, 0A0FT5G, 0A1CP1G, 0B0FT1G, 0B0FT2G, 0B0FT4G, 0B0FT5G, 0B1CP1G, 0D0FT1G, 0D0FT2G, 0D0FT4G, 0D0FT5G, 0D1CP1G, 0G0FT1G, 0G0FT1G-VERS.032008, 0G0FT2G, 0G0FT2G-VERS.032008, 0G0FT4G, 0G0FT4G-VERS.032008, 0G0FT5G, 0G0FT5G-VERS.032008, 0G0FT7G, 0G1CP1G, 0G1CP1G-VERS.2004, 0G1FR7G, 10CP1GA, 10CP1IA, 10WTPGE, 10WTPGV, 12CP1GA...(Other models you can see in the webshop)		



1

GEV No.	691146	Ref. No.	3000770
description	glass panel L 515mm W 505mm thickness 6mm rectangular		
For models:	FM611E1, FM611E2, FM611E3, FM611G1, FM611G2, FM611G3		



1

GEV No.	691147	Ref. No.	3000760
description	glass panel L 720mm W 515mm thickness 6mm rectangular		
For models:	FM1011E1, FM1011E2, FM1011E3, FM1011G1, FM1011G2, FM1011G3		

cleaning system

nozzles



1

GEV No.	510626	Ref. No.	33T1120 33T1121
description	rinse jet ø 0.7/1.5mm thread 1/8" ET		
For models:	L100, L40, L40S, L60, L80		

screw connections



1

GEV No.	362028	Ref. No.	3041000
description	manifold 4+2 L 116mm plastic thread M10 IT		
For models:	FM1011E3-VERS.2006, FM1011G3-VERS.2006, FM1221E3-VERS.2006, FM1221G3-VERS.2006, FM2011E3-VERS.2006, FM2011G3-VERS.2006, FM611E3-VERS.2006, FM611G3-VERS.2006, FM721E3-VERS.2006, FM721G3-VERS.2006		

pipes



1

GEV No.	521196	Ref. No.	3120710
description	drain pipe L 568mm W 182mm ø 30mm for combi-steamer ID ø 21mm EPDM		
For models:	BX101E, BX101E-VERS.122013, BX122E, BX122E-VERS.122013, BX122G, BX122G-VERS.122013, BX61E, BX61E-VERS.122013, BX82E, BX82E-VERS.122013, BX82G, BX82G-VERS.122013, FM423E1, FM423E2, FX101E1, FX101E1R, FX101E2, FX101E2C, FX101E2C-VERS.032014, FX101E2R, FX101E2R-VERS.032014, FX101E2-VERS.032014, FX101E3, FX101E3C, FX101E3C-VERS.022014, FX101E3R, FX101E3R-VERS.022014, FX101E3-VERS.022014, FX101G1, FX101G1R, FX101G2, FX101G2C, FX101G2R, FX101G3, FX101G3C, FX101G3R, FX10E2CR, FX10E2CR-VERS.032014, FX10E3CR, FX10E3CR-VERS.022014, FX10G2CR, FX10G3CR, FX122E1, FX122E2, FX122E2C, FX122E2T, FX122E2T-VERS.032014, FX122E3, FX122E3C, FX122E3T... (Other models you can see in the webshop)		



1

GEV No.	521198	Ref. No.	30Z2050
description	water pipe L 180mm W 120mm ø 11/12mm thread M16x1.5		
For models:	FC101, FC1011E, FC1011G, FC101E, FC1221E, FC1221G, FC241E, FC241G, FC61, FC611E, FC611G, FC61E, FCV101, FCV101-CSA, FCV101DM, FCV101DM-CSA, FCV101DS, FCV101DS-CSA, FCV101E, FCV101EDM, FCV101EDM-UL, FCV101EDS, FCV101E-UL, FCV141, FCV141-CSA, FCV141DM, FCV141DM-CSA, FCV141DS, FCV141DS-CSA, FCV141E, FCV141EDM, FCV141EDS, FCV241E, FCV241EDM, FCV241EDM-UL, FCV241EDS, FCV241EDS-UL, FCV241E-UL, FCV241G, FCV241G-CSA, FCV241GDM, FCV241GDM-CSA, FCV241GDS, FCV241GDS-CSA, FCV401DM, FCV401DM-CSA, FCV401EDM, FCV401EDM-UL, FCV61, FCV61-CSA... (Other models you can see in the webshop)		

hoses



1

GEV No.	696792	Ref. No.	3067460
description	hose ID ø 32mm ED ø 40mm L 1000mm combi-steamer		
For models:	08WGREV, 091CP1E, 091CP1G, 10CP1EA, 10CP1GA, 10CP1IA, 12CP1EA, 12CP1GA, 12CP1IA, 18CP2EA, 18CP2GA, 18CP2IA, 191CP1G, 191CP2G, 6040090, 6040310, 6043850, 6043980, FMS, FMSX, PIER-06HD, PIER15HD		

service kits



1

GEV No.	696773	Ref. No.	6300833
description	drain fitting set for combi-steamer hose ø 8mm		
For models:	FX101E3, FX101E3C, FX101E3C-VERS.022014, FX101E3R, FX101E3R-VERS.022014, FX101E3-VERS.022014, FX101G3, FX101G3C, FX101G3C-VERS.022014, FX101G3R, FX101G3R-VERS.022014, FX101G3-VERS.022014, FX10E3CR, FX10E3CR-VERS.022014, FX10G3CR, FX10G3CR-VERS.022014, FX122E3, FX122E3C, FX122E3T, FX122E3T-VERS.022014, FX122G3, FX122G3C, FX122G3T, FX122G3T-VERS.022014, FX12E3CT, FX12E3CT-VERS.022014, FX12G3CT, FX12G3CT-VERS.022014, FX201E3, FX201E3P, FX201E3P-VERS.022014, FX201E3-VERS.022014, FX201G3P, FX201G3-VERS.022014, FX202E3, FX202E3-230V-3-50Hz-60Hz, FX202E3-230V-3-50Hz-60Hz-VERS.022014, FX202E3-VERS.022014, FX202G3, FX202G3-VERS.022014, FX61E3, FX61E3C, FX61E3CR, FX61E3CR-VERS.022014, FX61E3C-VERS.022014, FX61E3R, FX61E3R-VERS.022014, FX61E3-VERS.022014, FX61G3, FX61G3C... (Other models you can see in the webshop)		



door mechanics

holders



GEV No.	692858	Ref. No.	6300798
description	bracket for glass door combi-steamer		
For models:	FX101E1, FX101E2, FX101E2C, FX101E2C-VERS.032014, FX101E2-VERS.032014, FX101E3, FX101E3C, FX101E3C-VERS.022014, FX101E3R, FX101E3-VERS.022014, FX101G1, FX101G2, FX101G2C, FX101G2C-VERS.032014, FX101G2-VERS.032014, FX101G3, FX101G3C, FX101G3C-VERS.022014, FX101G3-VERS.022014, FX10E2CR-VERS.032014, FX122E1, FX122E2, FX122E2C, FX122E2T, FX122E2T-VERS.032014, FX122E3, FX122E3C, FX122E3T, FX122E3T-VERS.022014, FX122G1, FX122G3, FX122G3C, FX122G3T, FX122G3T-VERS.022014, FX12E3CT, FX12E3CT-VERS.022014, FX12G3CT, FX12G3CT-VERS.022014, FX61E1, FX61E2, FX61E2C, FX61E2C-VERS.032014, FX61E2-VERS.032014, FX61E3, FX61E3C, FX61E3C-VERS.022014, FX61E3-VERS.022014, FX61G1, FX61G2, FX61G2C... (Other models you can see in the webshop)		

locking mechanism

GEV No.	698503	Ref. No.	6300965
description	espagnolette lock complete		
For models:	FX201E2, FX201E2P, FX201E2P-VERS.032014, FX201E2-VERS.032014, FX201E3, FX201E3P, FX201E3P-VERS.022014, FX201E3-VERS.022014, FX201G2, FX201G2P, FX201G2P-VERS.032014, FX201G2-VERS.032014, FX201G3P, FX201G3-VERS.022014, FX202E2, FX202E2-VERS.032014, FX202E3, FX202E3-230V-3-50Hz-60Hz, FX202E3-230V-3-50Hz-60Hz-VERS.022014, FX202E3-VERS.022014, FX202G2, FX202G2-VERS.032014, FX202G3, FX202G3-VERS.022014		
accessories for	698503		
	GEV No.	690041	Ref. No. 3088460
cam L 148mm mounting distance 32mm			
	GEV No.	694409	Ref. No. —
mounting set for espagnolette lock 694382			
	GEV No.	700604	Ref. No. —
latch gear opening to the right shaft intake 8x8mm L 170mm W 40mm H 40mm			

accessories



GEV No.	696775	Ref. No.	36E2781
description	buffer for door ø 15mm silicone L 20mm		
For models:	BX101E, BX101E-VERS.122013, BX101G, BX101G-VERS.122013, BX122E, BX122E-VERS.122013, BX122G, BX122G-VERS.122013, BX61E, BX61E-VERS.122013, BX61G, BX61G-VERS.122013, BX82E, BX82E-VERS.122013, BX82G, BX82G-VERS.122013, FC1011E, FC1011G, FC1221E, FC1221G, FC611E, FC611G, FM1011E1, FM1011E1-VERS.2006, FM1011E2, FM1011E2-VERS.2006, FM1011E3, FM1011E3-VERS.2006, FM1011G1, FM1011G1-VERS.2006, FM1011G2, FM1011G2-VERS.2006, FM1011G3, FM1011G3-VERS.2006, FM1221E1, FM1221E1-VERS.2006, FM1221E2, FM1221E2-VERS.2006, FM1221E3, FM1221E3-VERS.2006, FM1221G1, FM1221G1-VERS.2006, FM1221G2, FM1221G2-VERS.2006, FM1221G3, FM1221G3-VERS.2006, FM2011E2-VERS.2006, FM2011E3-VERS.2006, FM2011G2-VERS.2006, FM2011G3-VERS.2006...(Other models you can see in the webshop)		



GEV No.	696774	Ref. No.	3171920
description	bush for door handle ø 43mm hole ø 20mm plastic		
For models:	FX101E1, FX101E2, FX101E2C, FX101E2C-VERS.032014, FX101E2-VERS.032014, FX101E3, FX101E3C, FX101E3C-VERS.022014, FX101E3R, FX101E3-VERS.022014, FX101G1, FX101G2, FX101G2C, FX101G2C-VERS.032014, FX101G2-VERS.032014, FX101G3, FX101G3C, FX101G3C-VERS.022014, FX101G3-VERS.022014, FX10E2CR-VERS.032014, FX122E1, FX122E2, FX122E2C, FX122E2T, FX122E2T-VERS.032014, FX122E3, FX122E3C, FX122E3T, FX122E3T-VERS.022014, FX122G1, FX122G3, FX122G3C, FX122G3T, FX122G3T-VERS.022014, FX12E3CT, FX12E3CT-VERS.022014, FX12G3CT, FX12G3CT-VERS.022014, FX61E1, FX61E2, FX61E2C, FX61E2C-VERS.032014, FX61E2-VERS.032014, FX61E3, FX61E3C, FX61E3C-VERS.022014, FX61E3-VERS.022014, FX61G1, FX61G2, FX61G2C... (Other models you can see in the webshop)		



GEV No.	692859	Ref. No.	3019510
description	fixing plate for catch W 42mm zinc-plated sheet steel L 93.5mm		
For models:	FC1011E, FC1011G, FC1221E, FC1221G, FC611E, FC611G, FM1011E1, FM1011E1-VERS.2006, FM1011E2, FM1011E2-VERS.2006, FM1011E3, FM1011E3-VERS.2006, FM1011G1, FM1011G1-VERS.2006, FM1011G2, FM1011G2-VERS.2006, FM1011G3, FM1011G3-VERS.2006, FM1221E1, FM1221E1-VERS.2006, FM1221E2, FM1221E2-VERS.2006, FM1221E3, FM1221E3-VERS.2006, FM1221G1, FM1221G1-VERS.2006, FM1221G2, FM1221G2-VERS.2006, FM1221G3, FM1221G3-VERS.2006, FM2011E2-VERS.2006, FM2011E3-VERS.2006, FM2011G2-VERS.2006, FM2011G3-VERS.2006, FM2021E1, FM2021E2, FM2021E2-VERS.2006, FM2021E3, FM2021E3-VERS.2006, FM2021G1, FM2021G2, FM2021G2-VERS.2006, FM2021G3, FM2021G3-VERS.2006, FM611E1, FM611E1-VERS.2006, FM611E2, FM611E2-VERS.2006, FM611E3, FM611E3-VERS.2006... (Other models you can see in the webshop)		

vibration pumps



GEV No.	500972	Ref. No.	32M7000 32M7001
description	vibration pump 230V 47W 50Hz inlet ø 7 outlet ø 1/8" IT CEME type E507		
For models:	FM1011E3, FM1011E3-VERS.2006, FM1011G3, FM1011G3-VERS.2006, FM1221E3, FM1221E3-VERS.2006, FM1221G3-VERS.2006, FM2011E3-VERS.2006, FM2011G3-VERS.2006, FM2021E3, FM2021E3-VERS.2006, FM2021G3, FM2021G3-VERS.2006, FM611E3, FM611E3-VERS.2006, FM611G3, FM611G3-VERS.2006, FM721E3, FM721E3-VERS.2006, FM721G3, FM721G3-VERS.2006		

heat exchangers



GEV No.	521194	Ref. No.	36E2350
description	gasket for heat exchanger combi-steamer ID ø 40mm hole distance 52mm thickness 4mm		
For models:	BX101G, BX101G-VERS.122013, BX61G, BX61G-VERS.122013, FC1011G, FM1011G1, FM1011G1-VERS.2006, FM1011G2, FM1011G2-VERS.2006, FM1011G3, FM1011G3-VERS.2006, FX101G1, FX101G1R, FX101G2, FX101G2C, FX101G2C-VERS.032014, FX101G2R, FX101G2R-VERS.032014, FX101G2-VERS.032014, FX101G3, FX101G3C, FX101G3C-VERS.022014, FX101G3R, FX101G3R-VERS.022014, FX101G3-VERS.022014, FX10G2CR, FX10G2CR-VERS.032014, FX10G3CR, FX10G3CR-VERS.022014, FX201G2, FX201G2P, FX201G2P-VERS.032014, FX201G2-VERS.032014, FX201G3P, FX201G3-VERS.022014, FX61G1, FX61G1R, FX61G2, FX61G2C, FX61G2CR, FX61G2CR-VERS.032014, FX61G2C-VERS.032014, FX61G2R, FX61G2R-VERS.032014, FX61G2-VERS.032014, FX61G3, FX61G3C, FX61G3CR, FX61G3CR-VERS.022014, FX61G3C-VERS.022014...(Other models you can see in the webshop)		



GEV No.	521195	Ref. No.	36E3570
description	gasket for heat exchanger combi-steamer ID ø 52mm hole distance 63mm thickness 3mm		
For models:	BX122G, BX122G-VERS.122013, BX82G, BX82G-VERS.122013, FC1221G, FM1221G1, FM1221G1-VERS.2006, FM1221G2, FM1221G2-VERS.2006, FM1221G3, FM1221G3-VERS.2006, FM2021G1, FM2021G2, FM2021G2-VERS.2006, FM2021G3, FM2021G3-VERS.2006, FM721G1, FM721G1-VERS.2006, FM721G2, FM721G2-VERS.2006, FM721G3, FM721G3-VERS.2006, FX122G1, FX122G2, FX122G2C, FX122G2T, FX122G2T-VERS.032014, FX122G3, FX122G3C, FX122G3T, FX122G3T-VERS.022014, FX12G3CT, FX12G3CT-VERS.022014, FX202G2, FX202G2-VERS.032014, FX202G3, FX202G3-VERS.022014, FX82G1, FX82G2, FX82G2C, FX82G2T, FX82G2T-VERS.032014, FX82G3, FX82G3C, FX82G3CT, FX82G3CT-VERS.022014, FX82G3T, FX82G3T-VERS.022014		

miscellaneous



GEV No.	691179	Ref. No.	33Q0730
description	bush thread M10x1 ø 5mm		
For models:	FCV101DM, FCV101DM-CSA, FCV101DS, FCV101DS-CSA, FCV101EDM, FCV101EDM-UL, FCV101EDS, FCV101EDS-UL, FCV141DM, FCV141DM-CSA, FCV141DS, FCV141DS-CSA, FCV141EDM, FCV141EDS, FCV241DM, FCV241DS, FCV241EDM, FCV241EDM-UL, FCV241EDS, FCV241EDS-UL, FCV241GDM, FCV241GDM-CSA, FCV241GDS, FCV241GDS-CSA, FCV401DM, FCV401DM-CSA, FCV401EDM, FCV401EDM-UL, FCV4EDS, FCV61DM, FCV61DM-CSA, FCV61DS, FCV61DS-CSA, FCV61EDM, FCV61EDM-UL, FCV61EDS, FCV61EDS-UL, FCV72EDM-UL, FCV72EDS-UL, FM101E2, FM101E3, FM101G2, FM101G3, FM1221E2, FM1221E3, FM1221G2, FM1221G3, FM2021E2, FM2021E3, FM2021G2...(Other models you can see in the webshop)		
accessories for	691179		
	GEV No.	519385	Ref. No. 3150220
	GEV No.	691180	Ref. No. 3120100



GEV No.	691123	Ref. No.	36E2060
description	duct for door opener		
For models:	FCV3EM, FCV4E, FCV4EDS, FCV4EM, FM423E1, FM423E2		



GEV No.	541486	Ref. No.	33Q5901
description	hose connector for manometer bore ø 0.4mm thread 1/8"		
For models:	FM423E1, FM423E2		
accessories for	541486		
	GEV No.	541508	Ref. No. 33D1680



GEV No.	542121	Ref. No.	3032890
description	hose connector for manometer L 60mm WS 17 brass thread 1/8" ø 12mm T2: M8		
For models:	BX101E, BX101E-VERS.122013, BX101G, BX101G-VERS.122013, FC1011E, FC1011G, FC1221E, FC1221G, FC611E, FC611G, FM1011E1, FM1011E1-VERS.2006, FM1011E2, FM1011E2-VERS.2006, FM1011E3, FM1011E3-VERS.2006, FM1011G1, FM1011G1-VERS.2006, FM1011G2, FM1011G2-VERS.2006, FM1011G3, FM1011G3-VERS.2006, FM1221E1-VERS.2006, FM1221E2-VERS.2006, FM1221E3, FM1221E3-VERS.2006, FM1221G1-VERS.2006, FM1221G2-VERS.2006, FM1221G3, FM1221G3-VERS.2006, FM2011E2-VERS.2006, FM2011E3-VERS.2006, FM2011G2-VERS.2006, FM2011G3-VERS.2006, FM2021E1, FM2021E2, FM2021E2-VERS.2006, FM2021E3, FM2021E3-VERS.2006, FM2021G1, FM2021G2, FM2021G2-VERS.2006, FM2021G3, FM2021G3-VERS.2006, FM611E1, FM611E1-VERS.2006, FM611E2, FM611E2-VERS.2006, FM611E3, FM611E3-VERS.2006...(Other models you can see in the webshop)		

1

GEV No.	697869	Ref. No.	3010750
description	mounting flange for fan steel		
For models:	FM1011G1, FM1011G2, FM1011G3, FM611G1, FM611G2, FM611G3, FM721G1, FM721G2, FM721G3		



1

GEV No.	691180	Ref. No.	3120100
description	plain washer		
For models:	10CP1EA, 10CP1GA, 10CP1IA, 12CP1EA, 12CP1GA, 12CP1IA, 18CP2EA, 18CP2GA, 18CP2IA, C304AD, C304AS, C304AVD, C304AVS, CS370AD, CS370AS, CS370AVD, CS370AVS, CS466AD, CS466AS, CS466AVD, CS466AVS, FCV101DM, FCV101DM-CSA, FCV101DS, FCV101DS-CSA, FCV101EDM, FCV101EDM-UL, FCV101EDS, FCV101EDS-UL, FCV141DM, FCV141DM-CSA, FCV141DS, FCV141DS-CSA, FCV141EDM, FCV141EDS, FCV241DM, FCV241DS, FCV241EDM, FCV241EDM-UL, FCV241EDS, FCV241EDS-UL, FCV241GDM, FCV241GDM-CSA, FCV241GDS, FCV241GDS-CSA, FCV401DM, FCV401DM-CSA, FCV401EDM, FCV401EDM-UL, FCV4EDS...(Other models you can see in the webshop)		



1

GEV No.	697870	Ref. No.	3010670
description	protector for aspiration		
For models:	FM1011G1, FM1011G2, FM1011G3, FM1221G1, FM1221G2, FM1221G3, FM2021G1, FM2021G2, FM2021G3, FM611G1, FM611G2, FM611G3		

for tilting bratt pans

drive shafts



1

GEV No.	514043	Ref. No.	36G1290
description	spindle for tilting bratt pan seat ø 16mm		
For models:	1G1BR1E, 1G1BR1G, 31R, 31RE		

spare parts and accessories



1

GEV No.	693824	Ref. No.	36G6431
description	extension L 255mm thread M14x1.5 ø 25mm		



1

GEV No.	700735	Ref. No.	36E0870
description	spacer piece		
For models:	191BR1E, 191BR1G, 191BR1GA, 191BR2E, 191BR2EA, 191BR2G, 191BR2GA, 1A1BR1E, 1A1BR1G, 1A1BR1GA, 1A1BR2E, 1A1BR2EA, 1A1BR2G, 1A1BR2GA, 1D1BR1E, 1D1BR1G, 1D1BR1GA, 1D1BR2E, 1D1BR2EA, 1D1BR2G, 1D1BR2GA, 291BR1E, 291BR1G, 291BR1GA, 291BR2E, 291BR2EA, 291BR2G, 291BR2GA, 2A1BR1E, 2A1BR1G, 2A1BR1GA, 2A1BR2E, 2A1BR2EA, 2A1BR2G, 2A1BR2GA, 2D1BR1E, 2D1BR1G, 2D1BR1GA, 2D1BR2E, 2D1BR2EA, 2D1BR2G, 2D1BR2GA		



1

GEV No.	700734	Ref. No.	36E0440
description	thread bolt thread M5 D1 ø 18mm D2 ø 12mm		
For models:	191BR1E, 191BR1G, 191BR1GA, 191BR2E, 191BR2EA, 191BR2G, 191BR2GA, 1A1BR1E, 1A1BR1G, 1A1BR1GA, 1A1BR2E, 1A1BR2EA, 1A1BR2G, 1A1BR2GA, 1D1BR1E, 1D1BR1G, 1D1BR1GA, 1D1BR2E, 1D1BR2EA, 1D1BR2G, 1D1BR2GA, 291BR1E, 291BR1G, 291BR1GA, 291BR2E, 291BR2EA, 291BR2G, 291BR2GA, 2A1BR1E, 2A1BR1G, 2A1BR1GA, 2A1BR2E, 2A1BR2EA, 2A1BR2G, 2A1BR2GA, 2D1BR1E, 2D1BR1G, 2D1BR1GA, 2D1BR2E, 2D1BR2EA, 2D1BR2G, 2D1BR2GA		

housing and bezels

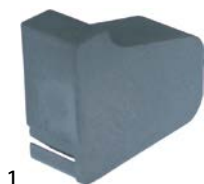

GEV No.	691183	Ref. No.	36D3430
description	end cap for control panel mounting pos. left		
For models:	030, 030BME, 030E, 030EBM, 030FE, 030FE1, 030FE1B, 030FT, 030FTE, 030FTER, 030FTR, 031, 031BME, 031E, 031EBM, 031FT, 031FT04, 031FT06, 031FTE, 031FTE04, 031FTE06, 031FTER, 031FTERL, 031FTR, 031FTRL, 031TP, 032, 070BM, 070BME, 070D, 070DGG, 070E, 070FT, 070FT04, 070FT05, 070FTE, 070FTE04, 070FTE05, 070FTER, 070FTR, 0712D, 0712VA, 071BM, 071BME, 071D, 071DGG, 071E, 071FT, 071FT04, 071FT06...(Other models you can see in the webshop)		



GEV No.	691184	Ref. No.	36D3420
description	end cap for control panel mounting pos. right		
For models:	030, 030BME, 030E, 030EBM, 030FE, 030FE1, 030FE1B, 030FT, 030FTE, 030FTER, 030FTR, 031, 031BME, 031E, 031EBM, 031FT, 031FT04, 031FT06, 031FTE, 031FTE04, 031FTE06, 031FTER, 031FTERL, 031FTR, 031FTRL, 031TP, 032, 070BM, 070BME, 070D, 070DGG, 070E, 070FT, 070FT04, 070FT05, 070FTE, 070FTE04, 070FTE05, 070FTER, 070FTR, 0712D, 0712VA, 071BM, 071BME, 071D, 071DGG, 071E, 071FT, 071FT04, 071FT06...(Other models you can see in the webshop)		

glass panels



GEV No.	693397	Ref. No.	3070970 37N1420
description	glass panel L 29mm W 29mm thickness 3.5mm square		
For models:	06WCP1GM, 08WCP1GM, 08WFT1GV, 08WFT2GV, 08WFT3GV, 08WFT4GV, 08WFT6GV, 08WFT7GV, 090FT1G, 090FT2G, 090FT4G, 090FT5G, 090FT7G, 091CP1G, 091FR7G, 091FR7GS, 091FR7G-VERS.052012, 091FR7GX, 0A0FT1G, 0A0FT2G, 0A0FT4G, 0A0FT5G, 0A1CP1G, 0B0FT1G, 0B0FT2G, 0B0FT4G, 0B0FT5G, 0B1CP1G, 0D0FT1G, 0D0FT2G, 0D0FT4G, 0D0FT5G, 0D1CP1G, 0G0FT1G, 0G0FT1G-VERS.032008, 0G0FT2G, 0G0FT2G-VERS.032008, 0G0FT4G, 0G0FT4G-VERS.032008, 0G0FT5G, 0G0FT5G-VERS.032008, 0G0FT7G, 0G1CP1G, 0G1CP1G-VERS.2004, 0G1FR7G, 10CP1GA, 10CP1IA, 10WTPGE, 10WTPGV, 12CP1GA...(Other models you can see in the webshop)		

spindles



GEV No.	514064	Ref. No.	36C0940
description	bearing block for tilting bratt pan ID ø 19/35mm ED ø 14mm		
For models:	1G1BR1E, 1G1BR1G, 31R, 31RE		

GEV No.	514044	Ref. No.	36G8110
description	threaded rod thread M10x1.5 L 640mm ø 20mm		
For models:	191BR1E, 191BR1G, 191BR2E, 191BR2G, 1A1BR1E, 1A1BR1G, 1A1BR2E, 1A1BR2G, 1D1BR1E, 1D1BR1G, 1D1BR2E, 1D1BR2G, 291BR1E, 291BR1G, 291BR2E, 291BR2G, 2A1BR1E, 2A1BR2E, 2D1BR1E, 2D1BR2E		

GEV No.	693099	Ref. No.	36G6440
description	threaded rod thread M14x1 L 300mm ø 24mm		
accessories for	693099		
GEV No.	693645	Ref. No.	36G6450
description	threaded bush		
GEV No.	693824	Ref. No.	36G6431
description	extension L 255mm thread M14x1.5 ø 25mm		

GEV No.	514041	Ref. No.	36G1170
description	threaded rod thread M14x1.5 L 615mm ø 25mm		
For models:	31R, 31RE		

miscellaneous



GEV No.	514046	Ref. No.	36C2830
description	bracket for bearing		
For models:	191BR1E, 191BR1G, 191BR2E, 191BR2G, 1A1BR1E, 1A1BR1G, 1A1BR2E, 1A1BR2G, 1D1BR1E, 1D1BR1G, 1D1BR2E, 1D1BR2G, 291BR1E, 291BR1G, 291BR2E, 291BR2G, 2A1BR1E, 2A1BR1G, 2A1BR2E, 2A1BR2G, 2D1BR1E, 2D1BR1G, 2D1BR2E, 2D1BR2G		



GEV No.	691187	Ref. No.	36D9390
description	bushing ø 15/20mm for tilting bratt pan		
For models:	1G1BR1E, 1G1BR1G, 31R, 31RE		



1

GEV No.	105375	Ref. No.	30Z2130
description	gas distributor		
For models:	1A1BR1G, 1A1BR1GA, 1A1BR2G, 1A1BR2GA, 1D1BR1G, 1D1BR1GA, 1D1BR2G, 1D1BR2GA, 2A1BR1G, 2A1BR1GA, 2A1BR2G, 2A1BR2GA, 2D1BR1G, 2D1BR1GA, 2D1BR2G, 2D1BR2GA		



1

GEV No.	500915	Ref. No.	36G2082
description	piston L 270mm ø 40mm for tilting bratt pan		
For models:	71ARE, 71RA, 91ARE, 91RA		



1

GEV No.	693645	Ref. No.	36G6450
description	threaded bush		
accessories for	693645		
	GEV No.	Ref. No.	36G6440
	threaded rod thread M14x1 L 300mm ø 24mm		



1

GEV No.	514249	Ref. No.	36G1250
description	threaded bush for tilting bratt pan		
For models:	1G1BR1E, 1G1BR1G, 31R, 31RE		



1

GEV No.	698477	Ref. No.	33Q3780
description	water supply pipe for tilting bratt pan for ANGELO PO		
For models:	191BR1E, 191BR1G, 191BR1GA, 191BR2E, 191BR2EA, 191BR2G, 191BR2GA, 1A1BR1E, 1A1BR1G, 1A1BR1GA, 1A1BR2E, 1A1BR2EA, 1A1BR2G, 1A1BR2GA, 1D1BR1E, 1D1BR1G, 1D1BR1GA, 1D1BR2E, 1D1BR2EA, 1D1BR2G, 1D1BR2GA, 1G1BR1E, 1G1BR1G, 291BR1E, 291BR1G, 291BR1GA, 291BR2E, 291BR2EA, 291BR2G, 291BR2GA, 2A1BR1E, 2A1BR1G, 2A1BR1GA, 2A1BR2E, 2A1BR2EA, 2A1BR2G, 2A1BR2GA, 2D1BR1E, 2D1BR1G, 2D1BR1GA, 2D1BR2E, 2D1BR2EA, 2D1BR2G, 2D1BR2GA		

for boiling pans

filters



1

GEV No.	514388	Ref. No.	30Q0450
description	drain filter kettle		
For models:	191PD1G, 191PD2G, 191PI1G, 191PI1GA, 191PI2E, 191PI2EA, 191PI2G, 191PI2GA, 191PI2V, 191PI2VA, 1A1PD1G, 1A1PD2G, 1A1PI1G, 1A1PI1GA, 1A1PI2E, 1A1PI2EA, 1A1PI2V, 1A1PI2VA, 1D1PD1G, 1D1PD2G, 1D1PI1G, 1D1PI1GA, 1D1PI2E, 1D1PI2EA, 1D1PI2V, 1D1PI2VA, 1G1PD1G, 1G1PI1E, 1G1PI1G, 31PD6, 31PI6, 31PIE6, 71PD10, 71PD15, 71PI10, 71PI10A, 71PIE15, 71PIE15A, 71PV15, 71PV15A, 91PI10, 91PI10A, 91PIE15, 91PIE15A		

housing and bezels

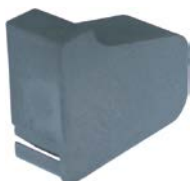

1

GEV No.	691183	Ref. No.	36D3430
description	end cap for control panel mounting pos. left		
For models:	030, 030BME, 030E, 030EBM, 030FE, 030FE1, 030FE1B, 030FT, 030FTE, 030FTEB, 030FTR, 031, 031BME, 031E, 031EBM, 031FT, 031FT04, 031FT06, 031FTE, 031FTE04, 031FTE06, 031FTEB, 031FTEBL, 031FTR, 031FTRL, 031TP, 032, 070BM, 070BME, 070D, 070DGG, 070E, 070FT, 070FT04, 070FT05, 070FTE, 070FTE04, 070FTE05, 070FTEB, 070FTR, 0712D, 0712VA, 071BM, 071BME, 071D, 071DGG, 071E, 071FT, 071FT04, 071FT06...(Other models you can see in the webshop)		



GEV No.	691184	Ref. No.	36D3420
description	end cap for control panel mounting pos. right		
For models:	030, 030BME, 030E, 030EBM, 030FE, 030FE1, 030FE1B, 030FT, 030FTE, 030FTR, 030FTR, 031, 031BME, 031E, 031EBM, 031FT, 031FT04, 031FT06, 031FTE, 031FTE04, 031FTE06, 031FTR, 031FTRERL, 031FTR, 031FTRL, 031TP, 032, 070BM, 070BME, 070D, 070DGG, 070E, 070FT, 070FT04, 070FT05, 070FTE, 070FTE04, 070FTE05, 070FTR, 070FTR, 0712D, 0712VA, 071BM, 071BME, 071D, 071DGG, 071E, 071FT, 071FT04, 071FT06...(Other models you can see in the webshop)		

glass panels



GEV No.	693397	Ref. No.	3070970 37N1420
description	glass panel L 29mm W 29mm thickness 3.5mm square		
For models:	06WCP1GM, 08WCP1GM, 08WFT1GV, 08WFT2GV, 08WFT3GV, 08WFT4GV, 08WFT6GV, 08WFT7GV, 090FT1G, 090FT2G, 090FT4G, 090FT5G, 090FT7G, 091CP1G, 091FR7G, 091FR7GS, 091FR7G-VERS.052012, 091FR7GX, 0A0FT1G, 0A0FT2G, 0A0FT4G, 0A0FT5G, 0A1CP1G, 0B0FT1G, 0B0FT2G, 0B0FT4G, 0B0FT5G, 0B1CP1G, 0D0FT1G, 0D0FT2G, 0D0FT4G, 0D0FT5G, 0D1CP1G, 0G0FT1G, 0G0FT1G-VERS.032008, 0G0FT2G, 0G0FT2G-VERS.032008, 0G0FT4G, 0G0FT4G-VERS.032008, 0G0FT5G, 0G0FT5G-VERS.032008, 0G0FT7G, 0G1CP1G, 0G1CP1G-VERS.2004, 0G1FR7G, 10CP1GA, 10CP1A, 10WTPGE, 10WTPGV, 12CP1GA...(Other models you can see in the webshop)		

miscellaneous



GEV No.	514386	Ref. No.	36M0830
description	closing clamp for kettle		
For models:	71PI10A, 71PIE15A, 71PV15A, 91PI10, 91PI10A, 91PIE15A		
accessories for	514386		
	GEV No.	514387	Ref. No. 36M0840
	locking screw		

for ovens

spare parts and accessories



GEV No.	691172	Ref. No.	35S5970
description	guide for guide counterweight		
For models:	FC101, FC101E, FC241, FC241E, FC241G, FC61, FC61E, FCV101, FCV101-CSA, FCV101DM, FCV101DM-CSA, FCV101DS, FCV101DS-CSA, FCV101E, FCV101EDM, FCV101EDM-UL, FCV101EDS, FCV101EDS-UL, FCV101E-UL, FCV141, FCV141-CSA, FCV141DM, FCV141DM-CSA, FCV141DS, FCV141DS-CSA, FCV141E, FCV141EDM, FCV141EDS, FCV241, FCV241DM, FCV241DS, FCV241E, FCV241EDM, FCV241EDM-UL, FCV241EDS, FCV241EDS-UL, FCV241E-UL, FCV241G, FCV241G-CSA, FCV241GDM, FCV241GDM-CSA, FCV241GDS, FCV241GDS-CSA, FCV61, FCV61-CSA, FCV61DM, FCV61DM-CSA, FCV61DS, FCV61DS-CSA, FCV61E...(Other models you can see in the webshop)		

housing and bezels

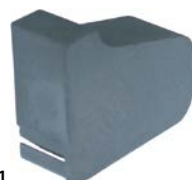

GEV No.	691183	Ref. No.	36D3430
description	end cap for control panel mounting pos. left		
For models:	030, 030BME, 030E, 030EBM, 030FE, 030FE1, 030FE1B, 030FT, 030FTE, 030FTR, 030FTR, 031, 031BME, 031E, 031EBM, 031FT, 031FT04, 031FT06, 031FTE, 031FTE04, 031FTE06, 031FTR, 031FTRERL, 031FTR, 031FTRL, 031TP, 032, 070BM, 070BME, 070D, 070DGG, 070E, 070FT, 070FT04, 070FT05, 070FTE, 070FTE04, 070FTE05, 070FTR, 070FTR, 0712D, 0712VA, 071BM, 071BME, 071D, 071DGG, 071E, 071FT, 071FT04, 071FT06...(Other models you can see in the webshop)		



GEV No.	691184	Ref. No.	36D3420
description	end cap for control panel mounting pos. right		
For models:	030, 030BME, 030E, 030EBM, 030FE, 030FE1, 030FE1B, 030FT, 030FTE, 030FTR, 030FTR, 031, 031BME, 031E, 031EBM, 031FT, 031FT04, 031FT06, 031FTE, 031FTE04, 031FTE06, 031FTR, 031FTRERL, 031FTR, 031FTRL, 031TP, 032, 070BM, 070BME, 070D, 070DGG, 070E, 070FT, 070FT04, 070FT05, 070FTE, 070FTE04, 070FTE05, 070FTR, 070FTR, 0712D, 0712VA, 071BM, 071BME, 071D, 071DGG, 071E, 071FT, 071FT04, 071FT06...(Other models you can see in the webshop)		



cast plates



1

GEV No.	109719	Ref. No.	35D4340
description	cast plate L 530mm W 545mm		
For models:	08WFA4E, 08WFA4G, 08WFAAE, 08WFAAG, 10WTPGE, 12WFA6E, 12WFA6G, 12WFAAE, 12WFAAG, 1B1FAS2G, 1B1FASG, 1G1FA0EV, 1G1FA0GV, 1G1PE1EV, 1G1PE2EV, 2G1FA0GV, 2G1PE1EV, 2G1PE2EV, 31, 31GE, 31TC, 31TCE, 31TP, 32, 32TC, 32TCE, 32TP, 32TPV, 32V, 6043590, 712D, 712VA		

miscellaneous



1

GEV No.	698478	Ref. No.	3142670
description	coupling for oven for door L 80mm W 26mm intake 7.8 x 7.8		
For models:	FX201E2, FX201E2P, FX201E2P-VERS.032014, FX201E2-VERS.032014, FX201E3, FX201E3P, FX201E3P-VERS.022014, FX201E3-VERS.022014, FX201G2, FX201G2P, FX201G2P-VERS.032014, FX201G2-VERS.032014, FX201G3P, FX201G3-VERS.022014, FX202E2, FX202E2-VERS.032014, FX202E3, FX202E3-230V-3-50Hz-60Hz, FX202E3-230V-3-50Hz-60Hz-VERS.022014, FX202E3-VERS.022014, FX202G2, FX202G2-VERS.032014, FX202G3, FX202G3-VERS.022014		

for dishwashers

drain and intake components

ANGELO PO

drain /intake bodies



1

GEV No.	510681	Ref. No.	36G9130
description	body hose ø 32mm		
For models:	LC100-VERS.2001, LC130, LC130-VERS.2001		





1

GEV No.	511440	Ref. No.	33Q2110 6000340
description	drain connection complete		
For models:	L40, L40S, L60		





1

GEV No.	517182	Ref. No.	3030150	
description	drain connection thread 1" ID ø 27mm hose ø 30mm			
For models:	KD37, KD40, LP202, LP202HC, LP302, LP302HC, LP402, LP402HC, LP402V, LPG300			
accessories for	517182			
	GEV No.	517180	Ref. No.	3030170
	nut thread 1" H 5mm WS 36 SS Qty 1 pcs			
	GEV No.	517181	Ref. No.	3030160
	flat gasket rubber ED ø 44mm ID ø 32mm thickness 3mm Qty 1 pcs			



1

GEV No.	511914	Ref. No.	33M0170	
description	drain fitting ED ø 110mm ID ø 80mm hose ø 28/45mm			
For models:	F60P, F60PR, F60T, F80P, F80PR, L45			
spare parts for	511914			
	GEV No.	511915	Ref. No.	33M0180
	flange for filter fixing			
	GEV No.	519383	Ref. No.	3150290
	gasket rubber ED ø 110mm ID ø 83mm thickness 3mm Qty 1 pcs			
accessories for	511914			
	GEV No.	519383	Ref. No.	3150290
	gasket rubber ED ø 110mm ID ø 83mm thickness 3mm Qty 1 pcs			





1

GEV No.	507574	Ref. No.	33Q4740
description	drain fitting thread 1 1/4" ED ø 54mm H 40mm ID ø 36/33mm		
For models:	C165D, C165S, C165VD, C165VS, C207D, C207D-VERS.2006, C207S, C207S-VERS.2006, C207VD, C207VD-VERS.2006, C207VS, C207VS-VERS.2006, C304AD, C304AD-VERS.2006, C304AS, C304AS-VERS.2006, C304AVD, C304AVD-VERS.2006, C304AVS, C304AVS-VERS.2006, C304D, C304D-VERS.2006, C304S, C304S-VERS.2006, C304VD, C304VD-VERS.2006, C304VS, C304VS-VERS.2006, C92D-VERS.2006, C92S-VERS.2006, C92VD-VERS.2006, C92VS-VERS.2006, CS243D, CS243D-VERS.2006, CS243S, CS243S-VERS.2006, CS243VD, CS243VD-VERS.2006, CS243VS, CS243VS-VERS.2006, CS370AD, CS370AD-VERS.2006, CS370AS, CS370AS-VERS.2006, CS370AVD, CS370AVD-VERS.2006, CS370AVS, CS370AVS-VERS.2006, CS370D, CS370D-VERS.2006...(Other models you can see in the webshop)		



2

GEV No.	519232	Ref. No.	33D3090 33Q2290
description	drain fitting thread 1 1/4" ED ø 54mm ID ø 35mm		
For models:	C165D, C165S, C165VD, C165VS, C207D, C207S, C207VD, C207VS, C304AD, C304AS, C304AVD, C304AVS, C304D, C304S, C304VD, C304VS, CS243D, CS243S, CS243VD, CS243VS, CS370AD, CS370AS, CS370AVD, CS370AVS, CS370D, CS370S, CS370VD, CS370VS, CS466AD, CS466AS, CS466AVD, CS466AVS, CS466D, CS466S, CS466VD, CS466VS, LC100-VERS.2001, LC130-VERS.2001, LF50E, LF50EM, LF50EMPS, LF50E-VERS.2007, LP124, LP124S-VERS.052006, LP124V, LP124-VERS.052006, LP124VS-VERS.052006, LP124V-VERS.052006, LP84, LP84S-VERS.052006...(Other models you can see in the webshop)		
accessories for	519232		
	GEV No.	519055	Ref. No. —
	locknut thread 1 1/4"		
	GEV No.	519179	Ref. No. 3151930
	O-ring EPDM thickness 3.53mm ID ø 41.28mm Qty 1 pcs		





1

GEV No.	503505	Ref. No.	33Q3050
description	drain fitting thread 1 1/2"		
For models:	L100, L40, L40S, L60, L80		
accessories for	503505		
	GEV No.	532114	Ref. No. 3150240
	O-ring EPDM thickness 3.53mm ID ø 50.8mm Qty 10 pcs		



1

GEV No.	517254	Ref. No.	33D3340
description	drain fitting thread 2"/1 1/4" H 64mm ID ø 43mm		
For models:	KD100, KD100A, KD100PSD, LP151		
accessories for	517254		
	GEV No.	517205	Ref. No. —
	flat gasket rubber ED ø 75mm ID ø 58mm thickness 3mm Qty 1 pcs		
	GEV No.	517206	Ref. No. —
	nut thread 2"		



1

GEV No.	517181	Ref. No.	3030160
description	flat gasket rubber ED ø 44mm ID ø 32mm thickness 3mm Qty 1 pcs		
For models:	KD37, KD40, LP202, LP202HC, LP302, LP302HC, LP402, LP402HC, LP402V, N100D, N100S, N100VD, N100VS, N38D, N38S, N38VD, N38VS, N42D, N42S, N42VD, N42VS, N50D, N50S, N50VD, N50VS, N66D, N66S, N66VD, N66VS, N70D, N70S, N70VD, N70VS, N85D, N85S, N85VD, N85VS		



1



GEV No.	517180	Ref. No.	3030170
description	nut thread 1" H 5mm WS 36 SS Qty 1 pcs		
For models:	KD37, KD37PS, KD37-VERS.112009, KD40, LP202, LP202HC, LP302, LP302HC, LP402, LP402HC, LP402V, LPG300, N100D, N100S, N100VD, N100VS, N38D, N38S, N38VD, N38VS, N42D, N42S, N42VD, N42VS, N50D, N50S, N50VD, N50VS, N66D, N66S, N66VD, N66VS, N70D, N70S, N70VD, N70VS, N85D, N85S, N85VD, N85VS		





1

GEV No.	505505	Ref. No.	33Q2160
description	nut thread 1 1/2" WS 55 plastic		
For models:	C165D, C165S, C165VD, C165VS, C207D, C207D-VERS.2006, C207S, C207S-VERS.2006, C207VD, C207VD-VERS.2006, C207VS, C207VS-VERS.2006, C304AD, C304AD-VERS.2006, C304AS, C304AS-VERS.2006, C304AVD, C304AVD-VERS.2006, C304AVS, C304AVS-VERS.2006, C304D, C304D-VERS.2006, C304S, C304S-VERS.2006, C304VD, C304VD-VERS.2006, C304VS, C304VS-VERS.2006, C92D-VERS.2006, C92S-VERS.2006, C92VD-VERS.2006, C92VS-VERS.2006, CS243D, CS243D-VERS.2006, CS243S, CS243S-VERS.2006, CS243VD, CS243VD-VERS.2006, CS243VS, CS243VS-VERS.2006, CS370AD, CS370AD-VERS.2006, CS370AS, CS370AS-VERS.2006, CS370AVD, CS370AVD-VERS.2006, CS370AVS, CS370AVS-VERS.2006, CS370D, CS370D-VERS.2006...(Other models you can see in the webshop)		





			
1			
GEV No.	510356	Ref. No.	33Q2320
description	nut thread 1 1/2"		
accessories for	510356		
	GEV No.	510876	Ref. No.
	flat gasket rubber ED ø 45mm ID ø 33mm thickness 3mm Qty 1 pcs		
	GEV No.	511298	Ref. No.
	hose connector hose ø 35mm		

			
1			
GEV No.	511309	Ref. No.	33Q0240
description	nut thread 1 1/2" ø 66mm H 9mm WS 51 brass Qty 1 pcs		
For models:	L100, L40, L40S, L60, L80		

			
1			
GEV No.	519179	Ref. No.	3151930
description	O-ring EPDM thickness 3.53mm ID ø 41.28mm Qty 1 pcs		
For models:	C165D, C165S, C165VD, C165VS, C207D, C207D-VERS.2006, C207S, C207S-VERS.2006, C207VD, C207VD-VERS.2006, C207VS, C207VS-VERS.2006, C304AD, C304AD-VERS.2006, C304AS, C304AS-VERS.2006, C304AVD, C304AVD-VERS.2006, C304AVS, C304AVS-VERS.2006, C304D, C304D-VERS.2006, C304S, C304S-VERS.2006, C304VD, C304VD-VERS.2006, C304VS, C304VS-VERS.2006, C92D-VERS.2006, C92S-VERS.2006, C92VD-VERS.2006, C92VS-VERS.2006, CS243D, CS243D-VERS.2006, CS243S, CS243S-VERS.2006, CS243VD, CS243VD-VERS.2006, CS243VS, CS243VS-VERS.2006, CS370AD, CS370AD-VERS.2006, CS370AS, CS370AS-VERS.2006, CS370AVD, CS370AVD-VERS.2006, CS370AVS, CS370AVS-VERS.2006, CS370D, CS370D-VERS.2006...(Other models you can see in the webshop)		

			
1			
GEV No.	532114	Ref. No.	3150240
description	O-ring EPDM thickness 3.53mm ID ø 50.8mm Qty 10 pcs		
For models:	L100, L40, L40S, L60, L80		

filters			
			
1			
GEV No.	504251	Ref. No.	30Q0490
description	drain filter ø 105mm H 80mm hole ø 40mm		
For models:	F60P, F60T, F80P, L45		

			
1			
GEV No.	519064	Ref. No.	30Q0300 30Q1510
description	drain filter ø 96mm H 81mm		
For models:	F60P, F60PR, F80PR, L45		

			
1			
GEV No.	519063	Ref. No.	30Q1330
description	filter H 75mm L 160mm W 75mm		
For models:	CS243D-VERS.2006, CS243S-VERS.2006, CS243VD-VERS.2006, CS243VS-VERS.2006, CS370AD-VERS.2006, CS370AS-VERS.2006, CS370AVD-VERS.2006, CS370AVS-VERS.2006, CS370D-VERS.2006, CS370S-VERS.2006, CS370VD-VERS.2006, CS370VS-VERS.2006, CS466AD-VERS.2006, CS466AS-VERS.2006, CS466AVD-VERS.2006, CS466AVS-VERS.2006, CS466D-VERS.2006, CS466S-VERS.2006, CS466VD-VERS.2006, CS466VS-VERS.2006, LF50, LF50E, LF50EM, LF50EMPS-VERS.122012, LF50EM-VERS.122012, LF50E-VERS.122012, LF50E-VERS.2007, LP70		

			
1			
GEV No.	511915	Ref. No.	33M0180
description	flange for filter fixing		
For models:	F60P, F60PR, F60T, F80P, F80PR, L45		

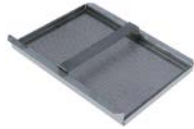
			
1			
GEV No.	507381	Ref. No.	30G0140
description	flat filter L 295mm W 195mm		
For models:	L100, L80		

			
1			
GEV No.	510002	Ref. No.	30Q3280
description	flat filter ø 50mm H 95mm L 383mm W 136mm		
For models:	KD100, KD100A, KD100PSD, LP151		

			
1			
GEV No.	519391	Ref. No.	35Q1030
description	intake filter ø 77mm H 100mm		



1

GEV No.	511439	Ref. No.	30G0150
----------------	--------	-----------------	---------

description	rectangular filter H 42mm L 114mm W 104mm
--------------------	---

For models:	L100, L80
--------------------	-----------



1

GEV No.	511438	Ref. No.	30Q2120
----------------	--------	-----------------	---------

description	rectangular filter H 70mm L 160mm W 145mm
--------------------	---



1

GEV No.	505268	Ref. No.	30Q1440
----------------	--------	-----------------	---------

description	round filters \varnothing 184mm H 103mm SS
--------------------	--

For models:	LC100
--------------------	-------



1

GEV No.	516079	Ref. No.	35Q9940
----------------	--------	-----------------	---------

description	round filters \varnothing 508mm H 55mm
--------------------	--

For models:	LT10R, LT20F, LT25F
--------------------	---------------------

overflow pipes



1

GEV No.	517175	Ref. No.	3018870
----------------	--------	-----------------	---------

description	overflow pipe L 107mm \varnothing 28mm
--------------------	--

For models:	KD40
--------------------	------



1

GEV No.	519266	Ref. No.	33D2360
----------------	--------	-----------------	---------

description	overflow pipe L 115mm
--------------------	-----------------------



1

GEV No.	519378	Ref. No.	33D3080
----------------	--------	-----------------	---------

description	overflow pipe L 115mm \varnothing 28mm
--------------------	--

For models:	LF50E, LF50EM, LP70
--------------------	---------------------



1

GEV No.	516252	Ref. No.	33D0390
----------------	--------	-----------------	---------

description	overflow pipe L 120mm \varnothing 29mm
--------------------	--

For models:	LT10R, LT20F, LT25F
--------------------	---------------------



1

GEV No.	519387	Ref. No.	33D0341
----------------	--------	-----------------	---------

description	overflow pipe L 185mm \varnothing 36mm
--------------------	--

For models:	L40, L60
--------------------	----------



1

GEV No.	517185	Ref. No.	33D3350
----------------	--------	-----------------	---------

description	overflow pipe L 185mm \varnothing 40mm
--------------------	--

For models:	KD100, KD100A, KD100PSD, KN50, KN50M, KN50MPS, KN50PS, KN50PSD, KN50PSDD, KN80, KN80PS, LP70
--------------------	--



accessories for	517185
------------------------	--------

GEV No.	517189	Ref. No.	37Q5140
----------------	--------	-----------------	---------





description	gasket \varnothing 28mm D1 \varnothing 40mm thickness 6mm
--------------------	---





			
1			
GEV No.	517186	Ref. No.	33D3360
description	overflow pipe L 210mm ø 40mm		
For models:	KD100, KD100A, KD100PSD, KD60, KD60E, KD60EAT, KD60M, KD60MA, KD60ME, KD6EATSD, KD85, KD85A, KD85E, KD85EA, KD85EAT, KD85EATS, KD85EPS, KD85EPSA, KD85PS, KD85PSA, KN1100, KN1100SD, KN11PSDD, KN800, KN800PSD, LP151		
accessories for	517186		
		GEV No.	517189
		Ref. No.	37Q5140
	gasket ø 28mm D1 ø 40mm thickness 6mm		

			
1			
GEV No.	516081	Ref. No.	33D0140
description	overflow pipe L 223mm ø 30mm		
For models:	F60P, F60PR, F80PR, L45		

			
1			
GEV No.	510679	Ref. No.	33D2320
description	overflow pipe L 245mm ø 35mm		
For models:	LC100, LC80		

			
1			
GEV No.	517357	Ref. No.	3056130
description	overflow pipe L 420mm ø 44mm		
For models:	KD130, KD130A, KD130E, KD130EAT		
accessories for	517357		
		GEV No.	517189
		Ref. No.	37Q5140
	gasket ø 28mm D1 ø 40mm thickness 6mm		

			
1			
GEV No.	519390	Ref. No.	33D2880
description	overflow pipe L 430mm ø 35mm		
For models:	C165D, C165S, C165VD, C165VS, C207D, C207S, C207VD, C207VD-VERS.2006, C207VS, C207VS-VERS.2006, C304AD, C304AS, C304AVD, C304AVD-VERS.2006, C304AVS, C304AVS-VERS.2006, C304D, C304S, C304VD, C304VD-VERS.2006, C304VS, C304VS-VERS.2006, C92VD-VERS.2006, C92VS-VERS.2006, CS243D, CS243S, CS243VD, CS243VD-VERS.2006, CS243VS, CS243VS-VERS.2006, CS370AD, CS370AS, CS370AVD, CS370AVD-VERS.2006, CS370AVS, CS370AVS-VERS.2006, CS370D, CS370S, CS370VD, CS370VD-VERS.2006, CS370VS, CS370VS-VERS.2006, CS466AD, CS466AD-VERS.2006, CS466AS, CS466AS-VERS.2006, CS466AVD, CS466AVD-VERS.2006, CS466AVS, CS466AVS-VERS.2006...(Other models you can see in the webshop)		

			
1			
GEV No.	519381	Ref. No.	33D0050
description	overflow pipe L 430mm ø 42mm		
For models:	L100, L80		

			
1			
GEV No.	517177	Ref. No.	3081150
description	overflow pipe L 96mm ø 28mm		
For models:	KD37		

containers

dosing containers

			
1			
GEV No.	361736	Ref. No.	36A4160
description	rinse aid container		
For models:	LF50, LF50E, LF50EM, LF50EM-VERS.122012, LF50E-VERS.122012, LF50E-VERS.2007		

			
1			
GEV No.	519380	Ref. No.	33D0660
description	rinse aid container		
For models:	F60P, F60PR, F60T, F80P, F80PR, L45		



boilers

boilers for dishwashers



1			
GEV No.	516163	Ref. No.	34A0700
description	boiler		
For models:	LT10R, LT20F, LT25F		



1			
GEV No.	517294	Ref. No.	3022510
description	boiler ø 113mm L 320mm		
For models:	KD37, KD37PS, KD37-VERS.112009, KN35, KN37PS		



1			
GEV No.	517295	Ref. No.	3023900
description	boiler ø 113mm L 370mm		
For models:	KD40, KD40PS, KD40-VERS.112009, KN40, KN40PS, KN40PSD		



1			
GEV No.	519022	Ref. No.	34A1950
description	boiler ø 150mm L 400mm		
For models:	LF50, LF50E, LF50EM		



1			
GEV No.	517302	Ref. No.	34A2560
description	boiler with insulation ø 160mm L 500mm		
For models:	KD100, KD100A, KD100PSD, KD130, KD130A, KD85, KD85A, KD85E, KD85EA, KD85EAT, KD85EATS, KD85EPS, KD85EPSA, KD85PS, KD85PSA, KN1100, KN1100SD, KN11PSDD, KN800, KN800PSD, LP151		
accessories for	517302		
	GEV No.	517337	Ref. No.
			—
	insulating mat boiler ø 160mm		

spare parts and accessories



1			
GEV No.	691742	Ref. No.	3120030
description	disc ext. ø 30		
For models:	FCV241G-CSA, FCV241GDM-CSA, FCV241GDS-CSA, L80		

hood mechanics for dishwashers

bolts



1			
GEV No.	510595	Ref. No.	3100100
description	bolt thread M6x1 for hood handle		
For models:	L100, L80		

bushes





1			
GEV No.	512423	Ref. No.	N/A
description	bush for hood handle		



1			
GEV No.	519205	Ref. No.	36C3560
description	bush hood mechanics		
For models:	LC100, LC100-VERS.2001, LC130, LC130-VERS.2001, LC80		



			
1			
GEV No.	524445	Ref. No.	35Z0770
description	bush L 22mm for handle rod ø 12mm		
For models:	L100, L80		

			
1			
GEV No.	524446	Ref. No.	35Z4410
description	bush L 35mm for handle rod ø 8mm		

spring holders

			
1			
GEV No.	519243	Ref. No.	36H0450
description	bush for spring holder hood mechanics		
For models:	LC100, LC100-VERS.2001, LC130, LC130-VERS.2001, LC80		

			
1			
GEV No.	516094	Ref. No.	36G0210
description	spring holder		
For models:	L100, L80		

guide bars



			
1			
GEV No.	517378	Ref. No.	3036440
description	guide bar L 650mm mounting pos. left for hood mechanics thickness 25mm		
For models:	KD100, KD100A, KD100PSD, KD130, KD130A, KD130E, KD130EAT		



			
1			
GEV No.	513019	Ref. No.	3036430
description	guide bar L 695mm mounting pos. right thickness 25mm		
For models:	KD100, KD100A, KD100PSD, KD130, KD130A, KD130E, KD130EAT		



miscellaneous

			
1			
GEV No.	510864	Ref. No.	N/A
description	bush for spring holder hood mechanics		



air traps



			
1			
GEV No.	510344	Ref. No.	33D0360
description	air trap		
For models:	L100, L40, L40S, L60, L80		
accessories for	510344		
	GEV No.	361182	Ref. No. 3117580
	nut thread 1/4" H 5mm nickel-plated brass WS 17 Qty 1 pcs		
	GEV No.	511512	Ref. No. 3150410
	O-ring EPDM thickness 2.62mm ID ø 18.72mm Qty 10 pcs		



			
1			
GEV No.	511450	Ref. No.	33M0220
description	air trap		
For models:	F60P, F60PR, F60T, F80P, F80PR, L45		
accessories for	511450		
	GEV No.	511197	Ref. No. 3151770
	gasket L 46mm W 33mm for air trap		

			
1			
GEV No.	516241	Ref. No.	3060029
description	air trap		
accessories for	516241		
	GEV No.	528485	Ref. No. —
	O-ring EPDM thickness 1.78mm ID ø 6.07mm Qty 1 pcs		



			
1			
GEV No.	519263	Ref. No.	33M0510
description	air trap		
For models:	CS243D, CS243S, CS243VD, CS243VS, CS370AD, CS370AS, CS370AVD, CS370AVS, CS370D, CS370S, CS370VD, CS370VS, CS466AD, CS466AS, CS466AVD, CS466AVS, CS466D, CS466S, CS466VD, CS466VS, LF50, LF50E, LF50EM, LF50EMPS, LF50E-VERS.2007, LP70		
accessories for	519263		
	GEV No.	519057	Ref. No.
			—
	nut thread 3/8" WS 25 H 6mm brass		
	GEV No.	519114	Ref. No.
			3151890
	flat gasket rubber ED ø 25mm ID ø 16.5mm thickness 2mm Qty 1 pcs		

			
1			
GEV No.	519319	Ref. No.	33D1390
description	air trap		
For models:	C165D, C165S, C165VD, C165VS, C207D, C207D-VERS.2006, C207S, C207S-VERS.2006, C207VD, C207VD-VERS.2006, C207VS, C207VS-VERS.2006, C304AD, C304AD-VERS.2006, C304AS, C304AS-VERS.2006, C304AVD, C304AVD-VERS.2006, C304AVS, C304AVS-VERS.2006, C304D, C304D-VERS.2006, C304S, C304S-VERS.2006, C304VD, C304VD-VERS.2006, C304VS, C304VS-VERS.2006, C92D-VERS.2006, C92S-VERS.2006, C92VD-VERS.2006, C92VS-VERS.2006, CS243D, CS243D-VERS.2006, CS243S, CS243S-VERS.2006, CS243VD, CS243VD-VERS.2006, CS243VS, CS243VS-VERS.2006, CS370AD, CS370AD-VERS.2006, CS370AS, CS370AS-VERS.2006, CS370AVD, CS370AVD-VERS.2006, CS370AVS, CS370AVS-VERS.2006, CS370D, CS370D-VERS.2006...(Other models you can see in the webshop)		
accessories for	519319		
	GEV No.	519057	Ref. No.
			—
	nut thread 3/8" WS 25 H 6mm brass		
	GEV No.	519114	Ref. No.
			3151890
	flat gasket rubber ED ø 25mm ID ø 16.5mm thickness 2mm Qty 1 pcs		

			
1			
GEV No.	517168	Ref. No.	33D3330
description	air trap H 56mm		
accessories for	517168		
	GEV No.	517173	Ref. No.
			37Q5130
	flat gasket FIBER ED ø 14mm ID ø 8mm thickness 1.5mm Qty 1 pcs		
	GEV No.	517174	Ref. No.
			3110050 33Q6470
	nut thread M8 H 6.5mm WS 13 SS DIN/ISO DIN 934 / ISO 4032/8673 Qty 1 pcs		

			
1			
GEV No.	517308	Ref. No.	33D3320
description	air trap H 65mm		
For models:	KD100, KD100A, KD100PSD, KN35, KN37, KN37PS, KN40, KN40PS, KN40PSD, LP151		

air trap accessories			
			
1			
GEV No.	511385	Ref. No.	35Z0050
description	flange L 46mm W 32mm for air trap		
For models:	F60P, F60PR, F60T, F80P, F80PR, L45		

			
1			
GEV No.	511197	Ref. No.	3151770
description	gasket L 46mm W 33mm for air trap		
For models:	F60P, F60PR, F60T, F80P, F80PR, L45		

mechanics for flight type dishwashers			
			
1			
GEV No.	691638	Ref. No.	36G7550
description	tappet		
For models:	C165D, C165S, C165VD, C165VS, C207D, C207D-VERS.2006, C207S, C207S-VERS.2006, C207VD, C207VD-VERS.2006, C207VS, C207VS-VERS.2006, C304AD, C304AD-VERS.2006, C304AS, C304AS-VERS.2006, C304AVD, C304AVD-VERS.2006, C304AVS, C304AVS-VERS.2006, C304D, C304D-VERS.2006, C304S, C304S-VERS.2006, C304VD, C304VD-VERS.2006, C304VS, C304VS-VERS.2006, C92D-VERS.2006, C92S-VERS.2006, C92VD-VERS.2006, C92VS-VERS.2006, CAD, CAS, CS243D, CS243D-VERS.2006, CS243S, CS243VD, CS243VD-VERS.2006, CS243VS, CS243VS-VERS.2006, CS370AD, CS370AD-VERS.2006, CS370AS, CS370AS-VERS.2006, CS370AVD, CS370AVD-VERS.2006, CS370AVS, CS370AVS-VERS.2006, CS370D...(Other models you can see in the webshop)		



backflow preventers

backflow preventers



GEV No.	504140	Ref. No.	33D0650 33D2100 33D2330
description	backflow preventer		



GEV No.	516101	Ref. No.	33D0650 33D2330
description	backflow preventer dishwasher hose ø 12mm		
For models:	C165D, C165S, C207D, C207S, C304AD, C304AS, C304D, C304S, CS243D, CS243S, CS243VD, CS243VS, CS370AD, CS370AS, CS370A-VD, CS370AVS, CS370D, CS370S, CS370VD, CS370VS, CS466AD, CS466AS, CS466AVD, CS466AVS, CS466D, CS466S, CS466VD, CS466VS, F60P, KD100, KD100PSD, KD130, KD130E, KD37, KD40, KD40EPSD, KD40LEPS, KD40LSPS, KD40LUX, KD40LUXE, KD60, KD60M, KD60MPS, KD60PS, KD60PSD, KD85, KD85PS, L100, L45, L80...(Other models you can see in the webshop)		
spare parts for	516101		
	GEV No.	506367	Ref. No. —
	flat gasket rubber ED ø 40mm ID ø 28mm thickness 1.8mm Qty 1 pcs		

miscellaneous



GEV No.	506160	Ref. No.	3120050
description	plain washer ID ø 8.6mm ED ø 16mm thickness 1.5mm SS Qty 1 pcs		
For models:	091FR1EX, 091FR7GS, 091FR7GX, BRE21HD, BRE31HD, FM1011E2-VERS.2006, FM1011E3-VERS.2006, FM1011G2-VERS.2006, FM1011G3-VERS.2006, FM1221E2-VERS.2006, FM1221E3-VERS.2006, FM1221G2-VERS.2006, FM1221G3-VERS.2006, FM611E2-VERS.2006, FM611E3-VERS.2006, FM611G2-VERS.2006, FM611G3-VERS.2006, FM721E3-VERS.2006, FM721G3-VERS.2006, FX101E2C, FX101E3C, FX101G2C, FX101G3C, FX10E2CR, FX10E3CR, FX10G2CR, FX10G3CR, FX122E2C, FX122E3, FX122E3C, FX122E3T, FX122E3T-VERS.022014, FX122G2C, FX122G3, FX122G3C, FX122G3T, FX122G3T-VERS.022014, FX12E3CT, FX12E3CT-VERS.022014, FX12G3CT, FX12G3CT-VERS.022014, FX61E2C, FX61E2CR, FX61E3CR, FX61G2C, FX61G2CR, FX61G3C, FX61G3CR, FX82E2C, FX82E3C...(Other models you can see in the webshop)		

door mechanics

bolts



GEV No.	514283	Ref. No.	36D7060 36D7061 36D7062
description	bolt with flattening 7mm ø 10mm L 20mm for door		
For models:	BX101E, BX101E-VERS.122013, BX101G, BX101G-VERS.122013, BX122E, BX122E-VERS.122013, BX122G, BX122G-VERS.122013, BX61E, BX61E-VERS.122013, BX61G, BX61G-VERS.122013, BX82E, BX82E-VERS.122013, BX82G, BX82G-VERS.122013, FC101, FC1011E, FC1011G, FC101E, FC1221E, FC1221G, FC241, FC241E, FC241G, FC61, FC611E, FC611G, FC61E, FCV101, FCV101-CSA, FCV101DM, FCV101DM-CSA, FCV101DS, FCV101DS-CSA, FCV101E, FCV101EDM, FCV101EDM-UL, FCV101EDS, FCV101EDS-UL, FCV141, FCV141-CSA, FCV141DM, FCV141DM-CSA, FCV141DS, FCV141DS-CSA, FCV141E, FCV141EDM, FCV141EDS, FCV241...(Other models you can see in the webshop)		

springs

roller springs



GEV No.	519340	Ref. No.	36G8430
description	roller spring		
For models:	LP124, LP124S-VERS.052006, LP124V, LP124-VERS.052006, LP124VS-VERS.052006, LP124V-VERS.052006		

sliding plates



GEV No.	518584	Ref. No.	36M1230
description	sliding plate		

hinges



GEV No.	510594	Ref. No.	3190130
description	door bolt ø 8mm L 42mm		
For models:	L40, L40S, L60		



1

GEV No.	510593	Ref. No.	35S1980	
description	door hinge			
For models:	L40, L40S, L60			
accessories for	510593			
	GEV No.	510594	Ref. No.	3190130
	door bolt ø 8mm L 42mm			



1

GEV No.	516089	Ref. No.	36G7400
description	spring assisted hinge spring hinge		
For models:	LT10R, LT20F, LT25F		

door shafts



1

GEV No.	695575	Ref. No.	3011520
description	door shaft ø 10mm L 458mm icemaker		
For models:	PG23C, PG24CW, PG30C, PG31CW		

locks





1

GEV No.	510210	Ref. No.	36M0030	
description	counterpart counterpart			
For models:	L40, L40S, L60			
accessories for	510210			
	GEV No.	510209	Ref. No.	36M0020
	door catch			





1

GEV No.	510209	Ref. No.	36M0020	
description	door catch			
For models:	L40, L40S, L60			
accessories for	510209			
	GEV No.	510210	Ref. No.	36M0030
	counterpart counterpart			



1

GEV No.	517276	Ref. No.	3030100	
description	door catch catch			
accessories for	517276			
	GEV No.	517277	Ref. No.	—
	gasket for catch			
	GEV No.	517278	Ref. No.	—
	counterpart door catch			



1

GEV No.	519247	Ref. No.	31W0061	
description	door catch door locking catch			
For models:	F60P, F60PR, F60T, F80P, F80PR, L45, LF50, LF50E, LF50EM, LF50EMPS, LF50EMPS-VERS.122012, LF50EM-VERS.122012, LF50E-VERS.122012, LF50E-VERS.2007			
accessories for	519247			
	GEV No.	519050	Ref. No.	—
	nut thread M12x1.75 H 4mm WS 16 SS Qty 1 pcs for snap lock			

miscellaneous



1

GEV No.	504435	Ref. No.	3152010
description	flat gasket plastic ED ø 18mm ID ø 9.5mm thickness 2.5mm for door hinge Qty 1 pcs		



screw connections



GEV No.	519008	Ref. No.	N/A
description	locknut thread 2 1/4" Qty 1 pcs		



GEV No.	505506	Ref. No.	33Q0220
description	nut		



GEV No.	505505	Ref. No.	33Q2160
description	nut thread 1 1/4" WS 55 plastic		

For models: C165D, C165S, C165VD, C165VS, C207D, C207D-VERS.2006, C207S, C207S-VERS.2006, C207VD, C207VD-VERS.2006, C207VS, C207VS-VERS.2006, C304AD, C304AD-VERS.2006, C304AS, C304AS-VERS.2006, C304AVD, C304AVD-VERS.2006, C304AVS, C304AVS-VERS.2006, C304D, C304D-VERS.2006, C304S, C304S-VERS.2006, C304VD, C304VD-VERS.2006, C304VS, C304VS-VERS.2006, C92D-VERS.2006, C92S-VERS.2006, C92VD-VERS.2006, C92VS-VERS.2006, CS243D, CS243D-VERS.2006, CS243S, CS243S-VERS.2006, CS243VD, CS243VD-VERS.2006, CS243VS, CS243VS-VERS.2006, CS370AD, CS370AD-VERS.2006, CS370AS, CS370AS-VERS.2006, CS370AVD, CS370AVD-VERS.2006, CS370AVS, CS370AVS-VERS.2006, CS370D, CS370D-VERS.2006...(Other models you can see in the webshop)



GEV No.	506278	Ref. No.	33Q4700
description	nut thread M26x1.5 H 15mm WS 32 plastic Qty 1 pcs 12		
For models:	F60PR, F60T, F80P, F80PR		

curtains

curtains



GEV No.	533016	Ref. No.	36Z0720
description	curtain W 640mm H 410mm plastic thickness 1.5mm warewashing		

washing and rinsing systems



GEV No.	505508	Ref. No.	33Q0280
description	bearing for wash arm		





GEV No.	524877	Ref. No.	36D0740
description	bush for rinse arm ø 20mm ID ø 16mm H 8mm ED ø 26mm		
For models:	L100, L40, L40S, L60, L80		



GEV No.	510053	Ref. No.	36G8460
description	bush for rinse arm ø 24mm H 5.7mm		
For models:	LP124, LP124S-VERS.052006, LP124V, LP124V-VERS.052006, LP124VS-VERS.052006, LP124V-VERS.052006, LP84, LP84S-VERS.052006, LP84V, LP84V-VERS.052006, LP84VS-VERS.052006, LP84V-VERS.052006		





GEV No.	519088	Ref. No.	36G9110
description	bush for wash arm		

			
1			
GEV No.	519167	Ref. No.	33Q370 33Q3700
description	bush for wash arm		
For models:	LP124, LP124S-VERS.052006, LP124V, LP124-VERS.052006, LP124VS-VERS.052006, LP124V-VERS.052006, LP84, LP84S-VERS.052006, LP84V, LP84-VERS.052006, LP84VS-VERS.052006, LP84V-VERS.052006		
accessories for	519167		
		GEV No.	519087
		Ref. No.	36G8720
	locknut for wash arm		

			
1			
GEV No.	695590	Ref. No.	31Z0250
description	bush for wash arm		
For models:	KD100, KD100A, KD100PSD, KD37, KD37PS, KD37-VERS.112009, KD40PS, KD40-VERS.112009, KD85, KD85A, KD85PS, KD85PSA, KN35, KN37, KN37PS, KN40, KN40PS, KN40PSD		

			
1			
GEV No.	517341	Ref. No.	33Q6600
description	bush ID ø 16mm ED ø 48mm		
For models:	KD100, KD100A, KD100PSD, KD130, KD130A, KD130E, KD130EAT, KN1100, KN1100SD, KN11PSDD, LP151, N100D, N100S, N100VD, N100VS, N38D, N38S, N38VD, N38VS, N42D, N42S, N42VD, N42VS, N50D, N50S, N50VD, N50VS, N66D, N66S, N66VD, N66VS, N70D, N70S, N70VD, N70VS, N85D, N85S, N85VD, N85VS		

			
1			
GEV No.	541505	Ref. No.	33Q0740
description	connecting piece thread 1/2" ø 14mm		
For models:	L100, L40, L60, L80		

			
1			
GEV No.	518075	Ref. No.	36Q0180
description	end cap thread 1/4" WS 14		
For models:	L100, L40, L40S, L60, L80		

			
1			
GEV No.	519047	Ref. No.	36U0740
description	flange		
For models:	LF50		

			
1			
GEV No.	517095	Ref. No.	3021600
description	flange ø 60mm		

			
1			
GEV No.	519122	Ref. No.	37Q4200
description	flat gasket for rinse arm		
For models:	C165D, C165S, C207D, C207S, C304AD, C304AS, C304D, C304S, CS243D, CS243S, CS243VD, CS243VS, CS370AD, CS370AS, CS370AVD, CS370AVS, CS370D, CS370S, CS370VD, CS370VS, CS466AD, CS466AS, CS466AVD, CS466AVS, CS466D, CS466S, CS466VD, CS466VS, LC100, LC100-VERS.2001, LC130, LC130-VERS.2001, LC80, N303D, N303S, N303VD, N303VS, N354D, N354S, N354VD, N354VS, N506D, N506S, N506VD, N506VS, N607D, N607S, N607VD, N607VS, N760D... (Other models you can see in the webshop)		

			
1			
GEV No.	691730	Ref. No.	33Q0510
description	knurled nut thread M10x1.5 ø 36mm H 3.5mm stainless steel		
For models:	L100, L40S, L60, L80		

			
1			
GEV No.	519006	Ref. No.	33Q4220
description	locknut		









			
1			
GEV No.	519087	Ref. No.	36G8720
description	locknut for wash arm		
For models:	LC100, LC100-VERS.2001, LC130, LC130-VERS.2001, LP124, LP124S-VERS.052006, LP124V, LP124-VERS.052006, LP124VS-VERS.052006, LP124V-VERS.052006, LP84, LP84S-VERS.052006, LP84V, LP84-VERS.052006, LP84VS-VERS.052006, LP84V-VERS.052006		

			
1			
GEV No.	510183	Ref. No.	33T0270
description	opposite support for rinse jet		

			
1			
GEV No.	510181	Ref. No.	33T0280
description	opposite support for wash jet		

			
1			
GEV No.	532536	Ref. No.	3152400
description	O-ring for rinse jet		
For models:	C207D-VERS.2006, C207S-VERS.2006, C207VD-VERS.2006, C207VS-VERS.2006, C304AD-VERS.2006, C304AS-VERS.2006, C304AVD-VERS.2006, C304AVS-VERS.2006, C304D-VERS.2006, C304S-VERS.2006, C304VD-VERS.2006, C304VS-VERS.2006, C92D-VERS.2006, C92S-VERS.2006, C92VD-VERS.2006, C92VS-VERS.2006, CS243D-VERS.2006, CS243S-VERS.2006, CS243VD-VERS.2006, CS243VS-VERS.2006, CS370AD-VERS.2006, CS370AS-VERS.2006, CS370AVD-VERS.2006, CS370AVS-VERS.2006, CS370D-VERS.2006, CS370S-VERS.2006, CS370VD-VERS.2006, CS370VS-VERS.2006, CS466AD-VERS.2006, CS466AS-VERS.2006, CS466AVD-VERS.2006, CS466AVS-VERS.2006, CS466D-VERS.2006, CS466S-VERS.2006, CS466VD-VERS.2006, CS466VS-VERS.2006, LC100, LC100-VERS.2001, LC130, LC130-VERS.2001, LC80, LF50, LF50E, LF50EM, LF50EMPS		

			
1			
GEV No.	505516	Ref. No.	30Z0240 6001920
description	rinse arm L 495mm nozzles 4 complete		
For models:	L100, L40, L40S, L60, L80		
spare parts for	505516		
	GEV No.	505502	Ref. No. 36D0720
	rinse arm shaft		
	GEV No.	510626	Ref. No. 33T1120 33T1121
	rinse jet ø 0.7/1.5mm thread 1/8" ET		

spare parts for	505516		
	GEV No.	518075	Ref. No. 36Q0180
	end cap thread 1/4" WS 14		
	GEV No.	524877	Ref. No. 36D0740
	bush for rinse arm ø 20mm ID ø 16mm H 8mm ED ø 26mm		
	GEV No.	691730	Ref. No. 33Q0510
	knurled nut thread M10x1.5 ø 36mm H 3.5mm stainless steel		

			
1			
GEV No.	505502	Ref. No.	36D0720
description	rinse arm shaft		
For models:	L100, L40, L40S, L60, L80		



			
1			
GEV No.	517332	Ref. No.	33Q0420
description	rinse arm shaft		
For models:	L100, L40, L60, L80		

			
1			
GEV No.	510626	Ref. No.	33T1120 33T1121
description	rinse jet ø 0.7/1.5mm thread 1/8" ET		
For models:	L100, L40, L40S, L60, L80		

			
1			
GEV No.	519201	Ref. No.	36G9080
description	rinse pipe		
For models:	LC80, LF50		

			
1			
GEV No.	517333	Ref. No.	33Q5070
description	sleeve thread M16x1 ø 25mm stainless steel		
For models:	L40, L40S, L60		

			
1			
GEV No.	519085	Ref. No.	33Q3710
description	Thumb screw ø 34mm thread M6		
For models:	LC100, LC100-VERS.2001, LC130, LC130-VERS.2001, LC80, LF50, LF50E, LF50EM, LF50EMPS, LF50EMPS-VERS.122012, LF50EM-VERS.122012, LF50E-VERS.122012, LF50E-VERS.2007, LP124, LP124V, LP84, LP84V		

			
1			
GEV No.	524804	Ref. No.	3036730
description	Thumb screw thread M5 thread L 7mm ø 30mm H 5mm SS Qty 1 pcs		
For models:	KD100, KD100A, KD100PSD, KD130, KD130A, KD130E, KD130EAT, KD40EPSD, KD40LEPS, KD40LUXE, KD60, KD60E, KD60EAT, KD60M, KD60MA, KD60ME, KD60MPS, KD60MPSA, KD60PS, KD60PSD, KD6E-ATSD, KD85, KD85A, KD85E, KD85EA, KD85EAT, KD85EATS, KD85EPS, KD85EPSA, KD85PS, KD85PSA, KN1100, KN1100SD, KN11PSDD, KN80, KN80PS, LP151, LP202, LP202HC, LP302, LP302HC, LP402, LP402HC, LP402V, LP70		
accessories for	524804		
	GEV No.	505277	Ref. No. 3036720 33q6400
	rinse arm shaft warewashing ø 14mm H 38mm thread 1/4"		

			
1			
GEV No.	510338	Ref. No.	N/A
description	union nut dosing pump thread 1/2" ø 32mm H 15mm for dosing pump		

			
1			
GEV No.	505507	Ref. No.	33Q1380
description	wash arm bearing		

			
1			
GEV No.	505510	Ref. No.	33Q1400
description	wash arm boss		

			
1			
GEV No.	511911	Ref. No.	36D7750
description	wash arm support		
accessories for	511911		
	GEV No.	510884	Ref. No. —
	gasket		

			
1			
GEV No.	511912	Ref. No.	33M0820
description	wash arm support		
accessories for	511912		
	GEV No.	510884	Ref. No. —
	gasket		

			
1			
GEV No.	511561	Ref. No.	3021590
description	wash arm support mounting pos. lower H 103mm		
For models:	KD40		

			
1			
GEV No.	504779	Ref. No.	33Q3380
description	wash arm support ø 43mm H 36.5mm M4		
For models:	L100, L40, L40S, L60, L80		

1

GEV No.	519388	Ref. No.	33T0970
description	wash jet		



1

GEV No.	519389	Ref. No.	33T0260
description	wash jet		

for vacuum packers

PTFE tapes



1

GEV No.	692155	Ref. No.	304184
description	PTFE tape W 50mm Qty 1m		

knobs

universal knobs





1

GEV No.	111934	Ref. No.	36M0700	
description	knob thermostat t.max. 90°C ø 50mm shaft ø 6x4.6mm shaft flat upper black temperature range 30-90°C rotation 270°			
For models:	L100, L40, L40S, L60, L80			
accessories for	111934			
	GEV No.	110135	Ref. No.	—
	rosette knob up to ø 52mm			



1

GEV No.	110117	Ref. No.	36M0750	
description	knob energy regulator 1-3 t.max.°C ø 60mm shaft ø 6x4.6mm shaft flat upper black			
spare parts for	110117			
	GEV No.	112495	Ref. No.	—
	knob spring L 10.5mm W 8.5mm Qty 1 pcs			



1

GEV No.	110111	Ref. No.	36M0590
description	knob switch 5-position ø 60mm shaft ø 6x4.6mm shaft flat upper black		



1

GEV No.	110116	Ref. No.	3110114 3110117
description	knob thermostat t.max. 110°C ø 60mm shaft ø 6x4.6mm shaft flat upper black temperature range 30-110°C rotation 270°		



1

GEV No.	110114	Ref. No.	36M0610
description	knob thermostat t.max. 300°C ø 60mm shaft ø 6x4.6mm shaft flat upper black temperature range 50-300°C rotation 270°		

producer-specific knobs

ANGELO PO



1

GEV No.	110899	Ref. No.	6300489
description	knob gas tap with ignition flame t.max.°C°C ø 77mm shaft ø 10x9mm shaft flat upper red		
For models:	0A0FAS, 0A0FAVA, 0A0GRG, 0A1CP1G, 0B0FAS, 0B1CP1G, 0D0FAS, 0D0FAVA, 0D0GRG, 0D1CP1G, 1A0FA2, 1A0FA5, 1A0FAB, 1A0FAS, 1A0FAS2, 1A0GRG, 1A0TP0, 1A1CP1G, 1A1CP2G, 1A1FA2G, 1A1FA5G, 1A1FABG, 1A1FAS2G, 1A1FASG, 1A1PD1G, 1A1PD2G, 1A1PI1G, 1A1PI1GA, 1A1TP0G, 1A1TP0G-VERS.2002, 1B0FAS, 1B0FAS2, 1B0TP0, 1B1FAS2G, 1B1FASG, 1D0FA2, 1D0FA5, 1D0FAB, 1D0FAS, 1D0FAS2, 1D0GRG, 1D0TP0, 1D1CP1G, 1D1CP2G, 1D1FA2G, 1D1FA5G, 1D1FABG, 1D1FAS2G, 1D1FASG, 1D1PD1G...(Other models you can see in the webshop)		



1

GEV No.	112192	Ref. No.	6300518 6300521
description	knob gas tap with ignition flame t.max.°C°C ø 77mm shaft ø 8x6.5mm shaft flat upper red		
For models:	0A0FA1, 0A0FA4, 0A0FAA, 0D0FA1, 0D0FA4, 0D0FAA, 0G0FA0, 0G1CP1G, 0G1CP1G-VERS.2004, 1A0FA1, 1A0FA2, 1A0FA4, 1A0FA5, 1A0FAA, 1A0FAB, 1A1FA1G, 1A1FA2G, 1A1FA4G, 1A1FA5G, 1A1FAAG, 1A1FABG, 1D0FA1, 1D0FA2, 1D0FA4, 1D0FA5, 1D0FAA, 1D0FAB, 1D1FA1G, 1D1FA2G, 1D1FA4G, 1D1FA5G, 1D1FAAG, 1D1FABG, 1G0FA0, 1G0GRG, 1G0TP0, 1G1CP1G, 1G1CP1G-VERS.2004, 1G1CP2G, 1G1CP2G-VERS.2004, 1G1FA0E, 1G1FA0EV, 1G1FA0G, 1G1FA0GV, 1G1FAPG, 1G1TP0G, 2A0FA1, 2A0FA4, 2A0FAA, 2A1FA1G...(Other models you can see in the webshop)		



1

GEV No.	110924	Ref. No.	6300486
description	knob gas thermostat t.max. 100°C 30-100°C ø 77mm shaft ø 8x6.5mm shaft flat upper red		
For models:	0A0BMG, 0D0BMG, 1A0BMG, 1D0BMG		



1

GEV No.	112191	Ref. No.	6300504
description	knob gas thermostat t.max. 280°C 100-280°C shaft ø 10x9mm shaft flat upper red		
For models:	0A0FT4G, 0A0FT5G, 0B0FT1G, 0B0FT2G, 0B0FT4G, 0B0FT5G, 0D0FT4G, 0D0FT5G, 0G0FT4G, 0G0FT5G, 1A0FT4G, 1A0FT6G, 1B0FT4G, 1B0FT6G, 1D0FT4G, 1D0FT6G, 1G0FT4G, 1G0FT6G		



1

GEV No.	112187	Ref. No.	6300488
description	knob gas thermostat t.max. 280°C 100-280°C shaft ø 8x6.5mm shaft flat upper red		
For models:	0A0FT1G, 0A0FT2G, 0A0FT4G, 0A0FT5G, 0D0FT1G, 0D0FT2G, 0D0FT4G, 0D0FT5G, 0G1BR3G, 1A0FT1G, 1A0FT2G, 1A0FT3G, 1A0FT4G, 1A0FT6G, 1D0FT1G, 1D0FT2G, 1D0FT3G, 1D0FT4G, 1D0FT6G, 1G1BR3G		



1

GEV No.	112186	Ref. No.	6300553
description	knob gas thermostat t.max. 280°C 160-280°C shaft ø 8x6.5mm shaft flat upper red		
For models:	1G1FA0G, 1G1FA0GV, 1G1FAPG, 1G1TP0G, 2G1FA0G, 2G1FA0GV, 2G1FADG, 2G1FADGV, 2G1FAPG, 2G1TP3G, G1FAGS, G1FAGST		



1

GEV No.	112710	Ref. No.	6300510
description	knob gas thermostat t.max. 300°C 100-300°C ø 79mm shaft ø 8x6.5mm shaft flat upper black/red		
For models:	1A1FA1G, 1A1FA2G, 1A1FA4G, 1A1FA5G, 1A1FAAG, 1A1FABG, 1A1TP0G-VERS.2002, 1B1FAS2G, 1B1FASG, 1D1FA1G, 1D1FA2G, 1D1FA4G, 1D1FA5G, 1D1FAAG, 1D1FABG, 1D1TP0G-VERS.2002, 2A1FA1G, 2A1FA4G, 2A1FAAG, 2A1TP3G, 2A1TP6G, 2A1TPCG, 2D1FA1G, 2D1FA4G, 2D1FAAG, 2D1TP3G, 2D1TP6G, 2D1TPCG, 3A1FA1G, 3A1FA4G, 3A1FAAG, 3D1FA1G, 3D1FA4G, 3D1FAAG		

1

GEV No.	112189	Ref. No.	6300503
description	knob gas thermostat t.max. 340°C 160-340°C shaft ø 10x9mm shaft flat upper red		
For models:	0A0FT1G, 0A0FT2G, 0D0FT1G, 0D0FT2G, 0G0FT1G, 0G0FT2G, 1A0FT1G, 1A0FT2G, 1A0FT3G, 1B0FT1G, 1B0FT2G, 1B0FT3G, 1D0FT1G, 1D0FT2G, 1D0FT3G, 1G0FT1G, 1G0FT2G, 1G0FT3G		



1

GEV No.	110927	Ref. No.	6300481
description	knob switch 0-1-0-1 t.max.°C°C ø 77mm shaft ø 6x4.6mm shaft flat upper red		
For models:	0A1FR1ED, 0A1FR1GD, 0A1FR1GD-VERS.2004, 0B1FR1GD, 0D1FR1ED, 0D1FR1GD, 0D1FR1GD-VERS.2004, 0G0FR3ED, 0G1FR3GD, 1A1FR2ED, 1A1FR2GD, 1A1FR2GD-VERS.2004, 1A1PI2G, 1A1PI2GA, 1D1FR2ED, 1D1FR2GD, 1D1FR2GD-VERS.2004, 1D1PI2G, 1D1PI2GA, 1G1FR4GD		



1

GEV No.	110908	Ref. No.	6300485
description	knob switch 5-position t.max.°C°C ø 77mm shaft ø 6x4.6mm shaft flat upper red		
For models:	0A0PE4, 0A1CP1E, 0D0PE4, 0D1CP1E, 0G1CP1E, 0G1CP1E-VERS.2004, 1A0PE4, 1A1PE4E, 1A1PEFTE, 1A1PI2E, 1A1PI2EA, 1D0PE4, 1D1PE4E, 1D1PI2E, 1D1PI2EA, 1G1PI1E		



1

GEV No.	112275	Ref. No.	6300522
description	knob switch 7-position t.max.°C°C ø 84mm shaft ø 6x4.6mm shaft flat upper red		
For models:	60SME		



1

GEV No.	112188	Ref. No.	6300556
description	knob switch 7-position t.max.°C°C shaft ø 6x4.6mm shaft flat upper red		
For models:	0G0PE1, 0G0PE2, 0G1PE2, 1G0PE1, 1G0PE2, 1G1PE1E, 1G1PE1EV, 1G1PE2, 1G1PE2E, 1G1PE2EV, 2G0PE1, 2G0PE2, 2G1PE1E, 2G1PE1EV, 2G1PE2E, 2G1PE2EV		
spare parts for	112188		
	GEV No.	550965	Ref. No. 3170290
	knob spring ø 6x4.6mm Qty 1 pcs		



1

GEV No.	110926	Ref. No.	6300480
description	knob thermostat t.max. 190°C 110-190°C shaft ø 6x4.6mm shaft flat upper red temperature range 110-190°C		
For models:	0A1FR1E, 0A1FR1G, 0A1FR1G-VERS.2004, 0A1FR3E, 0A1FR3ED, 0A1FR3G, 0A1FR3GD, 0B1FR1G, 0D1FR1E, 0D1FR1G, 0D1FR1G-VERS.2004, 0D1FR3E, 0D1FR3ED, 0D1FR3G, 0D1FR3GD, 0G0FR3E, 0G1FR3G, 1A1FR2E, 1A1FR2G, 1A1FR2G-VERS.2004, 1A1FR4E, 1A1FR4ED, 1A1FR4G, 1A1FR4GD, 1D1FR2G, 1D1FR2G-VERS.2004, 1D1FR4E, 1D1FR4ED, 1D1FR4G, 1D1FR4GD, 1G0FR4E, 1G1FR4G		



1

GEV No.	110923	Ref. No.	6300492
description	knob thermostat t.max. 270°C 100-270°C shaft ø 6x4.6mm shaft flat upper red rotation 270°		
For models:	0A0FT1E, 0A0FT2E, 0A0FT4E, 0A0FT5E, 0D0FT1E, 0D0FT2E, 0D0FT4E, 0D0FT5E, 0G0FT1E, 0G0FT2E, 0G0FT4E, 0G0FT5E, 0G1FT2E, 0G1FT4E, 1A0FT1E, 1A0FT2E, 1A0FT3E, 1A0FT4E, 1A0FT6E, 1D0FT1E, 1D0FT2E, 1D0FT3E, 1D0FT4E, 1D0FT6E, 1G0FT1E, 1G0FT2E, 1G0FT3E, 1G0FT4E, 1G1FT2E, 1G1FT4E, 1G1FT6E		



1

GEV No.	112190	Ref. No.	6300554
description	knob thermostat t.max. 300°C 80-300°C shaft ø 6x4.6mm shaft flat upper red		
For models:	1G1FA0E, 1G1FA0EV, 1G1PE1E, 1G1PE1EV, 1G1PE2E, 1G1PE2EV, 2G1PE1E, 2G1PE1EV, 2G1PE2E, 2G1PE2EV		



1

GEV No.	110934	Ref. No.	6300493
description	knob energy regulators 1-8 t.max.°C°C shaft ø 6x4.6mm shaft flat upper red		
For models:	OG1BR3E, 1A1BR1E, 1A1BR2E, 1A1BR2EA, 1D1BR1E, 1D1BR2E, 1D1BR2EA, 1G1BR3E, 2A1BR1E, 2A1BR2E, 2A1BR2EA, 2A1PI3E, 2D1BR1E, 2D1BR2E, 2D1BR2EA		



1

GEV No.	110919	Ref. No.	6300483
description	knob thermostat t.max. 300°C 100-300°C ø 65mm shaft ø 6x4.6mm shaft flat upper red		
For models:	0M0FT1E, 0M0FT2E, 0M0FT4E, 0M0FT5E, 1A1PE4E, 1A1PEFE, 1A1FBE, 1D1PE4E, 1D1FBE, 1M0FT1E, 1M0FT2E, 1M0FT3E, 1M0FT4E, 1M0FT5E, 1M0FT6E, 2M0FT1E, 2M0FT2E, 2M0FT3E, 2M0FT4E, 2M0FT5E, 2M0FT6E		



1

GEV No.	110909	Ref. No.	6300487
description	knob gas thermostat t.max. 300°C 100-300°C shaft ø 8x6.5mm shaft flat upper		
For models:	1A1FAS2G, 1A1FASG, 1A1TP0G, 1D1FAS2G, 1D1FASG, 1D1TP0G, 2A1FAS2G, 2A1FASG, 2A1TPSG, 2D1FAS2G, 2D1FASG, 2D1TPSG, 3A1FASG, 3D1FASG		



1

GEV No.	112193	Ref. No.	6300490
description	knob dial plate gas valves t.max.°C°C ø 65mm shaft ø 8x6.5mm shaft flat upper NOVASIT		
For models:	1A1BR1G, 1A1BR1GA, 1A1BR2G, 1A1BR2GA, 1D1BR1G, 1D1BR1GA, 1D1BR2G, 1D1BR2GA, 2A1BR1G, 2A1BR1GA, 2A1BR2G, 2A1BR2GA, 2D1BR1G, 2D1BR1GA, 2D1BR2G, 2D1BR2GA		



1

GEV No.	110922	Ref. No.	6300484
description	knob switch 4-position t.max.°C°C ø 65mm shaft ø 6x4.6mm shaft flat upper red		
For models:	1A1PE4E, 1A1PEFE, 1A1FBE, 1D1PE4E, 1D1FBE		



1

GEV No.	112798	Ref. No.	3015731
description	knob gas tap with ignition flame t.max.°C°C ø 72mm shaft ø 10x8mm shaft flat upper red		
For models:	06WCP1GM, 08WCP1GM, 08WGRGV, 090FAVA, 090GRG, 091CP1G, 10CP1GA, 10WTPGE, 10WTPGV, 190FAB, 190GRG, 190TP0, 191CP1G, 191CP2G, 191FABG, 191PD1G, 191PD2G, 191PI1G, 191PI1GA, 191PI2G, 191PI2GA, 191TPG, 1G1PD1G, 1G1PI1G, 291PD3G, 291PI3G, 291TPCG		



1

GEV No.	110933	Ref. No.	6300491
description	knob thermostat t.max. 270°C 100-270°C shaft ø 6x4.6mm shaft flat upper red temperature range 100-270°C		
For models:	OG1BR3E, 1A1BR1E, 1A1BR1G, 1A1BR1GA, 1A1BR2E, 1A1BR2EA, 1A1BR2G, 1A1BR2GA, 1D1BR1E, 1D1BR1G, 1D1BR1GA, 1D1BR2E, 1D1BR2EA, 1D1BR2G, 1D1BR2GA, 1G1BR1E, 1G1BR3E, 2A1BR1E, 2A1BR1G, 2A1BR1GA, 2A1BR2E, 2A1BR2EA, 2A1BR2G, 2A1BR2GA, 2D1BR1E, 2D1BR1G, 2D1BR1GA, 2D1BR2E, 2D1BR2EA, 2D1BR2G, 2D1BR2GA		



1

GEV No.	112636	Ref. No.	3013170 3013171
description	knob gas tap with ignition flame t.max.°C°C ø 72mm shaft ø 8x6.5mm shaft flat upper red		
For models:	04WFAAV, 08WFA4E, 08WFA4G, 08WFAAE, 08WFAAG, 08WFAAV, 090FAA, 0G0FA0, 0G1CP1G-VERS.2004, 10WTPGE, 12WFA6E, 12WFA6G, 12WFAAA, 12WFAAE, 12WFAAG, 12WFAAN, 190FA, 190FAA, 190FAB, 190FAD, 191FAAE, 191FAAG, 191FABG, 191FADG, 191FAE, 191FAG, 1G0FA0, 1G0FA0B, 1G0GRG, 1G0TP0, 1G1CP1G-VERS.2004, 1G1CP2G-VERS.2004, 1G1FA0E, 1G1FA0EV, 1G1FA0G, 1G1FA0GV, 1G1FABG, 1G1FAPG, 1G1TP0G, 290FA, 291FAG, 291FAGF, 291TPCG, 2G0FA0, 2G0FA0A, 2G0FA0B, 2G1FA0E, 2G1FA0G, 2G1FA0GV, 2G1FABG...(Other models you can see in the webshop)		





			
1			
GEV No.	112774	Ref. No.	3144110
description	knob gas thermostat t.max. 250°C 100-250°C ø 72mm shaft ø 8x6.5mm shaft flat upper red		
For models:	0G0FT1G-VERS.032008, 0G0FT2G-VERS.032008, 0G0FT4G-VERS.032008, 0G0FT5G-VERS.032008, 0G0FT7G, 1G0FT1G-VERS.032008, 1G0FT2G-VERS.032008, 1G0FT3G-VERS.032008, 1G0FT4G-VERS.032008, 1G0FT6E, 1G0FT6G-VERS.032008, 1G0FT7G		

			
1			
GEV No.	112638	Ref. No.	3020250 3020251
description	knob switch 4-position t.max.°C ø 72mm shaft ø 6x4.6mm shaft flat upper red		
For models:	08WFA4E, 08WFAAE, 10WTPGE, 12WFA6E, 12WFAAE, 191FAAE, 191FAE, 191PE4E		

			
1			
GEV No.	112641	Ref. No.	3010330 3010331
description	knob gas thermostat t.max. 270°C 140-270°C ø 72mm shaft ø 8x6.5mm shaft flat upper red		
For models:	08WFA4G, 08WFAAG, 08WFT1GV, 08WFT2GV, 08WFT3GV, 08WFT4GV, 08WFT6GV, 08WFT7GV, 090FT1G, 090FT2G, 090FT4G, 090FT5G, 090FT7G, 12WFA6G, 12WFAAG, 190FT15G, 190FT1G, 190FT2G, 190FT3G, 190FT42G, 190FT4G, 190FT6G, 190FT72G, 190FT7G, 191FAAG, 191FABG, 191FADG, 191FAG, 191TPG, 1G1BR1G, 291FAG, 291FAGF, 291TPCG, 391FAG		

			
1			
GEV No.	112634	Ref. No.	3015940 3015941
description	knob switch 5-position t.max.°C ø 72mm shaft ø 6x4.6mm shaft flat upper red		
For models:	04WPE4V, 08WPE4V, 090PE4, 0G1CP1E-VERS.2004, 190PE4, 191PE4E, 191PI2E, 191PI2EA, 1G1PI1E		

			
1			
GEV No.	112643	Ref. No.	3015990 3015991
description	knob switch 0-10 t.max.°C ø 72mm shaft ø 6x4.6mm shaft flat upper		
For models:	04WVT1V, 04WVT1IV-VERS.022010, 04WVT2IV, 04WVT2IV-VERS.022010, 08WVT1IV, 08WVT1IV-VERS.112009, 08WVT2IV, 08WVT2IV-VERS.112009, 090VT1I, 090VT1I-VERS.112010, 090VT1W, 090VT1W-VERS.102008, 091VT1I, 091VT1I-VERS.2009, 091VT1W, 091VT2I, 091VT2I-VERS.2009, 0G0VT1I, 0G0VT1I-VERS.112010, 0G0VT1IW, 190VT1I, 190VT1I-VERS.112010, 191VT1I, 191VT1I-VERS.2009, 191VT2I, 191VT2I-VERS.2009, 1G0VT1I, 1G0VT1I-VERS.122010		

			
1			
GEV No.	112635	Ref. No.	3015831
description	knob thermostat t.max. 190°C 110-190°C ø 72mm shaft ø 6x4.6mm shaft flat upper red		
For models:	091FR1E, 091FR1G, 091FR1I, 091FR1I-VERS.032012, 091FR3E, 091FR3G, 091FR7G, 091FR7G-VERS.052012, 0G0FR3E, 0G1FR3G, 191FR2E, 191FR2G, 191FR2I, 191FR2I-VERS.032012, 191FR4E, 191FR4G, 1G0FR4E, 1G1FR4G		

			
1			
GEV No.	112640	Ref. No.	3015850 3015851
description	knob switch 0-1-0-1 t.max.°C ø 72mm shaft ø 6x4.6mm shaft flat upper red		
For models:	04WFR3ED, 06WFR3GD, 08WFR4ED, 08WGREV, 091FR1ED, 091FR1GD, 091FR3ED, 091FR3GD, 0G0FR3ED, 0G1FR3GD, 10WFR4GD, 190GRE, 191FR2ED, 191FR2GD, 191FR4ED, 191FR4GD, 1G0GRE, 1G1FR4GD, 291PI3G, 2A1PI3G, 2D1PI3G		

			
1			
GEV No.	112797	Ref. No.	3015870 3015871
description	knob thermostat t.max. 270°C 110-270°C ø 72mm shaft ø 6x4.6mm shaft flat upper red		
For models:	06WBR3E, 06WFT1EV, 06WFT2EV, 06WFT3EV, 06WFT4EV, 06WFT6EV, 06WFT7EV, 08WFT1EV, 08WFT2EV, 08WFT3EV, 08WFT4EV, 08WFT6EV, 08WFT7EV, 090FT1E, 090FT2E, 090FT4E, 090FT5E, 090FT7E, 091FT1E, 091FT2E, 091FT4E, 091FT5E, 091FT7E, 0G0FT1E, 0G0FT2E, 0G0FT4E, 0G0FT5E, 0G0FT7E, 0G1BR3E, 0G1FT2E, 0G1FT4E, 0G1FT5E, 0G1FT7E, 190FT15E, 190FT1E, 190FT2E, 190FT3E, 190FT42E, 190FT4E, 190FT5E, 190FT6E, 190FT72E, 190FT7E, 191BR1E, 191BR1G, 191BR1GA, 191BR2E, 191BR2EA, 191BR2G, 191BR2GA...(Other models you can see in the webshop)		



1

GEV No.	112639	Ref. No.	3015900 3015901
description	knob thermostat t.max. 300°C 100-300°C ø 72mm shaft ø 6x4.6mm shaft flat upper red		
For models:	08WFA4E, 08WFAAE, 10WTPGE, 12WFA6E, 12WFAAE, 191FAAE, 191FAE, 191PE4E		



1

GEV No.	112637	Ref. No.	3019901 3112000
description	knob water t.max. °C ø 72mm shaft ø 6x4.6mm shaft flat upper red		
For models:	04WCP1EM, 06WCP1GM, 08WCP1GM, 091CP1E, 091CP1G, 0G1CP1EC, 0G1CP1E-VERS.2004, 0G1CP1G-VERS.2004, 191CP1G, 191CP2G, 1G1CP1G-VERS.2004, 1G1CP2G-VERS.2004		



1

GEV No.	110140	Ref. No.	36M2390 36M5140
description	knob switch zero mark ø 67mm shaft ø 10x9mm shaft flat upper black		
For models:	030FT, 030FTR, 031FT, 031FTR, 031FTRL, 031TP, 070D, 070DGG, 070FT, 070FTR, 0712D, 0712VA, 071D, 071DGG, 071FT, 071FTR, 071FTRL, 071TP, 072D, 072DGG, 090, 090FT, 090FTR, 090GG, 091, 091FT, 091FTR, 091FTRL, 091GG, 091TP, 092, 092GG, 092VA, 092VAGG, 30CPS, 31, 31PD6, 31PI6, 31TC, 31TP, 32, 32TC, 32TP, 32TPV, 32V, 70CP, 712D, 712VA, 71CP, 71CP2...(Other models you can see in the webshop)		



1

GEV No.	110142	Ref. No.	36M2400
description	knob switch zero mark ø 67mm shaft ø 6x4.6mm shaft flat upper black		
For models:	030BME, 030E, 030EBM, 030FE, 030FE1, 030FTE, 030FTE04, 030FTE06, 031BME, 031E, 031EBM, 031FTE, 031FTE04, 031FTE06, 031FTE08, 031FTE08L, 070BME, 070E, 070FTE, 070FTE04, 070FTE05, 070FTE08, 071BME, 071E, 071FTE, 071FTE04, 071FTE06, 071FTE08, 071FTE08L, 30CPSE, 30F1, 30FES, 30FES2, 30FS2, 31GE, 31PIE6, 31TCE, 32TCE, 60SME, 70CPE, 70F1, 70FE, 70FE1, 70FES, 70FES2, 71E, 71F2, 71FE, 71FE2, 71PIE15, 71PIE15A		



1

GEV No.	110141	Ref. No.	36M3050
description	knob switch zero mark ø 67mm shaft ø 8x6.5mm shaft flat upper black		
For models:	030, 031, 032, 31, 31GE, 31TC, 32, 32TC, 32TP, 32TPV, 32V, 60SM		





1

GEV No.	111745	Ref. No.	36M4970
description	knob switch zero mark ø 45mm shaft ø 6x4.6mm shaft flat upper blue/black		
For models:	FCV3EM, FCV4EM		



1

GEV No.	110925	Ref. No.	36M4560
description	knob switch zero mark ø 45mm shaft ø 6x4.6mm shaft flat upper red		
For models:	030FE1B, 091FE28B, 30F1B, 30FES2B, 30FS2B, 70F1B, 70FE1B, 70FES2, 70FES2B, 71F2B, 71FE2B, 90F110B, 91AR, 91ARE, 91F210B, 91F223B, 91RA, FC101, FC101E, FC241, FC241E, FC241G, FC61, FC61E, FCV101, FCV101-CSA, FCV101E, FCV101E-UL, FCV141, FCV141-CSA, FCV141E, FCV241, FCV241E, FCV241E-UL, FCV241G, FCV241G-CSA, FCV61, FCV61-CSA, FCV61E, FCV61E-UL, FCV72E-UL		
accessories for	110925		
		GEV No.	550965
		Ref. No.	3170290
	knob spring ø 6x4.6mm Qty 1 pcs		



1

GEV No.	112910	Ref. No.	36M5270
description	knob switch zero mark ø 45mm shaft ø 6x4.6mm shaft flat upper silver		





			
1			
GEV No.	110143	Ref. No.	36M0560
description	knob gas tap with ignition flame ø 65mm shaft ø 10x8mm shaft flat lower black		

			
1			
GEV No.	112860	Ref. No.	3104143
description	knob ø 60mm shaft ø 6x9mm silver		

			
1			
GEV No.	110292	Ref. No.	36M2800
description	cover cap switch zero mark t.max.°C ø 32mm shaft ømm shaft flat red knob		
For models:	031FT04, 031FT06, 070BM, 070FT04, 070FT05, 071BM, 071FT04, 071FT06, 090BM, 090FT04, 090FT05, 091BM, 091FT04, 091FT06, 30F, 30FS, 31R, 31RE, 70F, 712D, 712VA, 71AR, 71ARE, 71D, 71DGG, 71E, 71F, 71GE, 71GEGG, 71RA, 71TP, 72D, 72DGG, 72TP, 72TPGG, 72VA, 72VAGG, 72VAS, 72VASGG, 73D, 73DGG, 73VA, 73VAD, 73VADGG, 73VAGG, A12A1E, A12B1E, A12B2E, A12M1E, A12Z1E...(Other models you can see in the webshop)		

			
1			
GEV No.	112570	Ref. No.	36H0900 36H0901
description	knob potentiometer ø 62mm shaft ø 6x4.6mm shaft flat universal black		
For models:	FM1011E1, FM1011E1-VERS.2006, FM1011E2, FM1011E2-VERS.2006, FM1011E3, FM1011E3-VERS.2006, FM1011G1, FM1011G1-VERS.2006, FM1011G2, FM1011G2-VERS.2006, FM1011G3, FM1011G3-VERS.2006, FM1221E1, FM1221E1-VERS.2006, FM1221E2, FM1221E2-VERS.2006, FM1221E3, FM1221E3-VERS.2006, FM1221G1, FM1221G1-VERS.2006, FM1221G2, FM1221G2-VERS.2006, FM1221G3, FM1221G3-VERS.2006, FM2011E2-VERS.2006, FM2011E3-VERS.2006, FM2011G2-VERS.2006, FM2011G3-VERS.2006, FM2021E1, FM2021E2, FM2021E2-VERS.2006, FM2021E3, FM2021E3-VERS.2006, FM2021G1, FM2021G2, FM2021G2-VERS.2006, FM2021G3, FM2021G3-VERS.2006, FM423E1, FM423E2, FM611E1, FM611E1-VERS.2006, FM611E2, FM611E2-VERS.2006, FM611E3, FM611E3-VERS.2006, FM611G1, FM611G1-VERS.2006, FM611G2, FM611G2-VERS.2006...(Other models you can see in the webshop)		

			
1			
GEV No.	110293	Ref. No.	36M2580
description	knob gas regulator t.max.°C ø 44mm shaft ø Minisitmm black		
For models:	031FT04, 031FT06, 070BM, 070FT04, 070FT05, 071BM, 071FT04, 071FT06, 090BM, 090FT04, 090FT05, 091BM, 091FT04, 091FT06, 1G1BR1G, 30F, 30FS, 31R, 70F, 712D, 712VA, 71D, 71DGG, 71F, 71TP, 72D, 72DGG, 72TP, 72TPGG, 72VA, 72VAGG, 72VAS, 72VASGG, 73D, 73DGG, 73VA, 73VAD, 73VADGG, 73VAGG, F530		

			
1			
GEV No.	111213	Ref. No.	36M1590 alt
description	knob switch zero mark ø 38mm shaft ø 6x4.6mm shaft flat lower black		

			
1			
GEV No.	110294	Ref. No.	36M2620
description	knob t.max.°C ø 44mm shaft ø 8x5.5mm shaft flat universal black		
For models:	31RE, 71AR, 71ARE, 71E, 71GE, 71GEGG, 71RA, A12A1E, A12B1E, A12B2E, A12M1E, A12Z1E, A12Z2E, A14A1E, A14B1E, A14B2E, A14M1E, A14Z1E, A14Z2E, A16A1E, A16B1E, A16B2E, A16M1E, A16Z1E, A16Z2E, A18A1E, A18B1E, A18B2E, A18M1E, A18Z1E, A18Z2E, A20A1E, A20B1E, A20B2E, A20M1E, A20Z1E, A20Z2E, ACBM, ACBM218, ACPN, ACPN218, AJ12AE, AJ12ME, AJ14AE, AJ14ME, AJ16AE, AJ16ME, AJ18AE, AJ18ME, AJ20AE...(Other models you can see in the webshop)		

			
1			
GEV No.	111215	Ref. No.	36M1511
description	knob switch zero mark ø 38mm shaft ø 6x4.6mm shaft flat upper black		
For models:	F60P, F60PR, F60T, F80P, F80PR, L100, L40, L40S, L45, L60, L80, SM-1LAM, SM1LM		



1

GEV No.	111212	Ref. No.	36M1800
description	knob switch zero mark ø 40mm shaft ø 6x4.6mm shaft flat upper black		



1

GEV No.	111218	Ref. No.	36M4620
description	knob switch zero mark ø 44mm shaft ø 6x4.6mm shaft flat upper black		
For models:	K16APGPZ, K16XPZAP, SA16AGB, SA16GB, SI14VB, SI21VB		



1

GEV No.	110918	Ref. No.	36M4710
description	knob switch zero mark ø 45mm shaft ø 6x6mm black		
accessories for	110918		
	GEV No.	510923	Ref. No. —
	clamping ring for shaft ø 10mm ID ø 9.4mm H 6mm		

accessories

button springs



1

GEV No.	550965	Ref. No.	3170290
description	knob spring ø 6x4.6mm Qty 1 pcs		
For models:	030BME, 030E, 030EBM, 030FE, 030FE1, 030FE1B, 030FTE, 030FTER, 031BME, 031E, 031EBM, 031FTE, 031FTE04, 031FTE06, 031FTER, 031FTERL, 070BME, 070E, 070FTE, 070FTE04, 070FTE05, 070FTER, 071BME, 071E, 071FTE, 071FTE04, 071FTE06, 071FTER, 071FTERL, 090BME, 090E, 090FTE, 090FTE04, 090FTE05, 090FTER, 090SPE, 091BME, 091E, 091FE28, 091FE28B, 091FR1ED, 091FR3ED, 091FTE, 091FTE04, 091FTE06, 091FTER, 091FTERL, 0A0BME, 0A0FT1E, 0A0FT2E...(Other models you can see in the webshop)		

gaskets



1

GEV No.	550493	Ref. No.	3150790
description	gasket for knob		
For models:	030E, 030EBM, 030FE1, 030FE1B, 030FTE, 030FTER, 031E, 031EBM, 031FTE04, 031FTE06, 04WCP1EM, 06WFR3GD, 070E, 070FTE04, 070FTE05, 071E, 071FTE04, 071FTE06, 08WCP1GM, 08WFAAE, 090, 090BM, 090BME, 090E, 090FT, 090FTE04, 090FTE05, 090FTR, 090GG, 091, 091BM, 091BME, 091CP1E, 091CP1G, 091E, 091FE28, 091FE28B, 091FR1E, 091FR1ED, 091FR1GD, 091FR3G, 091FR3GD, 091FT, 091FTE04, 091FTE06, 091FTR, 091FTRL, 091GG, 091TP, 092...(Other models you can see in the webshop)		



1

GEV No.	101729	Ref. No.	3152250
description	gasket knob D1 ø 70mm D2 ø 7mm thickness 1mm equiv. no. 3152250 suitable for ANGELO PO		
For models:	04WFAAV, 06WCP1GM, 08WCP1GM, 08WFA4E, 08WFA4G, 08WFAAE, 08WFAAG, 08WFAAV, 08WFT1GV, 08WFT2GV, 08WFT3GV, 08WFT4GV, 08WFT6GV, 08WFT7GV, 08WGRGV, 090BM1G, 090FT1G, 090FT2G, 090FT4G, 090FT5G, 090FT7G, 090GRG, 091CP1G, 0A0BMG, 0A0FA1, 0A0FA4, 0A0FAA, 0A0FAS, 0A0FAVA, 0A0FT1G, 0A0FT2G, 0A0FT4G, 0A0FT5G, 0A0GRG, 0A1CP1G, 0B0FAS, 0B0FT1G, 0B0FT2G, 0B0FT4G, 0B0FT5G, 0B1CP1G, 0D0BMG, 0D0FA1, 0D0FA4, 0D0FAA, 0D0FAS, 0D0FAVA, 0D0FT1G, 0D0FT2G, 0D0FT4G...(Other models you can see in the webshop)		

handles and hand wheels

hand wheels

hand wheels



1

GEV No.	514026	Ref. No.	36M4910
description	hand wheel ø 160mm D1 ø 40mm bore ø 16mm thread M8 hole distance 9mm groove widthmm L1 22mm L2 50mm handle length 75mm with folding handle		
For models:	1G1BR1E, 1G1BR1G, 31R, 31RE		
accessories for	514026		
	GEV No.	560224	Ref. No. 31W0020
	grub screw thread M8 L 10mm WS 4 Qty 1 pcs		



1

GEV No.	694634	Ref. No.	3214440 3342840
description	hand wheel ø 200mm D1 ø 48mm bore ø 16mm depth of bore 34mm thread groove widthmm L1 29mm L2 55mm handle length 80mm with folding handle plastic		
For models:	191BR1E, 191BR1G, 191BR2E, 191BR2G, 1A1BR1E, 1A1BR1G, 1A1BR2E, 1A1BR2G, 1D1BR1E, 1D1BR1G, 1D1BR2E, 1D1BR2G, 291BR1E, 291BR1G, 291BR2E, 291BR2G, 2A1BR1E, 2A1BR1G, 2A1BR2E, 2A1BR2G, 2D1BR1E, 2D1BR1G, 2D1BR2E, 2D1BR2G		



1

GEV No.	690249	Ref. No.	36M5560 36M5561 36M5562
description	hand wheel ø 200mm D1 ø 48mm bore ø 20mm hole ø 7mm thread hole distance 11mm groove widthmm L1 30mm L2 60mm handle length 82mm with folding handle		
For models:	191BR1E, 191BR1G, 191BR2E, 191BR2G, 1A1BR1E, 1A1BR1G, 1A1BR2E, 1A1BR2G, 1D1BR1E, 1D1BR1G, 1D1BR2E, 1D1BR2G, 291BR1E, 291BR1G, 291BR2E, 291BR2G, 2A1BR1E, 2A1BR1G, 2A1BR2E, 2A1BR2G, 2D1BR1E, 2D1BR1G, 2D1BR2E, 2D1BR2G		
spare parts for	690249		
		GEV No.	514255 Ref. No. —
	folding handle ø 26mm total length 85mm seat ø 20mm shaft ømm thread M6 with pin L 85mm		

cylindrical handles

fixed



1

GEV No.	514065	Ref. No.	36M5750
description	cylindrical handle thread M12 ø 23mm L 65mm		
For models:	091FR1E, 091FR1EA, 091FR1ED, 0A1FR1E, 0A1FR1ED, 0D1FR1E, 0D1FR1ED, 191FR2E, 191FR2ED, 1A1FR2E, 1A1FR2ED, 1D1FR2ED		

cone handles



1

GEV No.	694633	Ref. No.	3000900
description	cone handle thread M8x1.25 ø 28mm plastic L 105mm black thread L 25mm		
For models:	08WGRGV, 090GRG, 0A0GRG, 0D0GRG, 190GRG, 191PD1G, 191PD2G, 191PI1G, 191PI1GA, 191PI2E, 191PI2EA, 191PI2G, 191PI2GA, 191PI2V, 191PI2VA, 1A0GRG, 1D0GRG, 1G0GRG		

handle bars

handle bars



1

GEV No.	691148	Ref. No.	36M4830
description	handle rod H 40mm L 450mm		



1

GEV No.	691149	Ref. No.	36M2441
description	handle rod H 40mm L 615mm		
For models:	712D, 712VA, 71D, 71DGG, 71E, 71GE, 71GEGG, 71TP, 72D, 72DGG, 72TP, 72TPGG, 72VA, 72VAGG, 72VAS, 72VASGG, 73D, 73DGG, 73VA, 73VAD, 73VADGG, 73VAGG, FS30, FS30E		

consoles



1

GEV No.	691135	Ref. No.	36M2910
description	console for door handle		
For models:	091T, 60SM, 60SME, 70CP, 70CPE, 70F, 70F1, 70F1B, 70FE, 70FE1, 70FE1B, 70FES, 70FES2, 70FES2B, 712D, 712VA, 71CP, 71CP2, 71D, 71DGG, 71E, 71F, 71F2, 71F2B, 71FE, 71FE2, 71FE2B, 71GE, 71GEGG, 71TP, 72D, 72DGG, 72TP, 72TPGG, 72VA, 72VAGG, 72VAS, 72VASGG, 73D, 73DGG, 73VA, 73VAD, 73VADGG, 73VAGG, 90CP, 90CPE, 91CP, 91F223B, FS30, FS30E		



			
1			
GEV No.	690297	Ref. No.	36D0230
description	console Qty 1 pcs		

handle rails

ANGELO PO

			
1			
GEV No.	691153	Ref. No.	36M3590
description	handle rail hole distance 650mm		
For models:	31, 31GE, 31TC, 31TCE, 31TP, 32, 32TC, 32TCE, 32TP, 32TPV, 32V		

handle rails

			
1			
GEV No.	691153	Ref. No.	36M3590
description	handle rail hole distance 650mm		
For models:	31, 31GE, 31TC, 31TCE, 31TP, 32, 32TC, 32TCE, 32TP, 32TPV, 32V		

bracket handles

			
1			
GEV No.	692176	Ref. No.	3010570 3010571 3010572 3010573
description	pull handle L 295mm H 40mm mounting distance 255mm thread M5 chrome-plated		
For models:	04WBMEV, 04WCP1EM, 04WF AAV, 04WFR3ED, 04WPE4V, 04WPEBV, 04WVT1IV, 04WVT1IV-VERS.022010, 04WVT2IV, 04WVT2IV-VERS.022010, 04WVT3RV, 06WBR3E, 06WCP1GM, 06WFR3GD, 06WFT1EV, 06WFT2EV, 06WFT3EV, 06WFT4EV, 06WFT6EV, 06WFT7EV, 08WCP1GM, 08WF AAV, 08WFR4ED, 08WFT1EV, 08WFT1GV, 08WFT2EV, 08WFT2GV, 08WFT3EV, 08WFT3GV, 08WFT4EV, 08WFT4GV, 08WFT6EV, 08WFT6GV, 08WFT7EV, 08WFT7GV, 08WGRGV, 08WPE4V, 08WPEBV, 08WTPEV, 08WVT1IV, 08WVT1IV-VERS.112009, 08WVT2IV, 08WVT2IV-VERS.112009, 091CP1E, 091CP1G, 091FR1E, 091FR1EA, 091FR1ED, 091FR1EX, 091FR1G...(Other models you can see in the webshop)		

			
1			
GEV No.	690451	Ref. No.	36M4040
description	pull handle L 426mm H 40mm mounting distance 376mm black		
For models:	40EVP, 40PV, 40XPV, 55PV		

covers

			
1			
GEV No.	691158	Ref. No.	3002970
description	cover for handle plastic		
For models:	PG22C, PG23CW		

fasteners

locking screws

			
1			
GEV No.	514387	Ref. No.	36M0840
description	locking screw		
accessories for	514387		
	GEV No.	514386	Ref. No. 36M0830
	closing clamp for kettle		

miscellaneous

			
1			
GEV No.	110146	Ref. No.	36M1100
description	handle L 195mm W 65mm		



			
1			
GEV No.	691193	Ref. No.	36M4640
description	handle thread M5		
For models:	BRPRV, BRVRV, SE14PRV, SE14VRV, SI14PRV, SI14VRV, SL14RPRV, SL14VRV, TPRV, TVRV		

accessories

miscellaneous



			
1			
GEV No.	691134	Ref. No.	36M3720
description	spacer piece for door handle		
For models:	30CPS, 30CPSE, 30F1, 30F1B, 30FES2, 30FES2B, 30FS2, 30FS2B, 31, 31GE, 31TC, 31TCE, 31TP, 32, 32TC, 32TCE, 32TP, 32TPV, 32V		

locks

locking devices

producer-specific

ANGELO PO







			
1			
GEV No.	690462	Ref. No.	36M7070
description	key cylinder ø 23mm thread M19x1 mounting measurements 16.5x19mm hub 38-45mm shaft ø 11mm thread L 12mm		
For models:	AF1B, AF1B-OPR01, AF1N, AF1N-OPR01, AF2B, AF2B-OPR01, AF2N, AF2N-OPR01, AGL6B, CX120, CX120B, CX120NN, CX130, CX130B, CX130NN, CX140, CX140B, CX140BN, CX140BR, CX140CP, CX140NN, CX140R, CX150, CX150B, CX150BN, CX150BR, CX150CP, CX150NN, CX150R, CX55, CX55B, CX60, CX60B, CX65, CX652, CX65B, CX65BR, CX65NB, CX65NCP, CX65NN, CX65R, CX70, CX702, CX70B, CX70BR, CX70NB, CX70NN, CX70R, FG2B, FSD1B...(Other models you can see in the webshop)		
spare parts for	690462		
	GEV No.	691589	Ref. No. —
spare keys for key cylinder 690462 key number 9233			



			
1			
GEV No.	690662	Ref. No.	36M0140 36M5020
description	key cylinder with slide latch ø 23mm thread M19x1 cam width 11mm mounting measurements 16.5x19mm hub 20-28mm thread L 15mm		
For models:	135, 135-4, 135A, 135B, 135BA, 135BN, 135BNX, 135BX, 135BXE, 135BXR, 135CPX, 135NN, 135NNX, 135PVX, 135X, 135X-3, 135X-4, 135XE, 135XR, 40B, 40CP, 40CPX, 40EV, 40EVP, 65, 65A, 65B, 65BA, 65BX, 65BX-2, 65BXE, 65BXR, 65NB, 65NBX, 65NN, 65NNX, 65PVX, 65X, 65X-2, 65XE, 65XR, S125, S125-4, S125B, S125B-4, S125BE, S125BX, S125BX-4, S125E, S125X...(Other models you can see in the webshop)		

turning lever locks

universal



RAHRBACH



			
1			
GEV No.	690500	Ref. No.	36M0880 36M3180 36M6380 6300421
description	handle latch right L 185mm H 66mm handle material plastic type 6300 series		
For models:	FC101, FC101E, FC241, FC241E, FC241G, FC61, FC61E, FCV101, FCV101-CSA, FCV101DM, FCV101DM-CSA, FCV101DS, FCV101DS-CSA, FCV101E, FCV101EDM, FCV101EDM-UL, FCV101EDS, FCV101EDS-UL, FCV101E-UL, FCV141, FCV141-CSA, FCV141DM, FCV141DM-CSA, FCV141DS, FCV141DS-CSA, FCV141E, FCV141EDM, FCV141EDS, FCV241, FCV241DM, FCV241DS, FCV241E, FCV241EDM, FCV241EDM-UL, FCV241EDS, FCV241EDS-UL, FCV241E-UL, FCV241G, FCV241G-CSA, FCV241GDM, FCV241GDM-CSA, FCV241GDS, FCV241GDS-CSA, FCV401DM, FCV401DM-CSA, FCV401EDM, FCV401EDM-UL, FCV61, FCV61-CSA, FCV61DM...(Other models you can see in the webshop)		
spare parts for	690500		
	GEV No.	699841	Ref. No. —
cover cap for turning lever lock ø 32mm H 14mm			
accessories for	690500		
	GEV No.	514281	Ref. No. 36M1570
base plate L 110mm W 35mm for door catch thickness 10mm			
	GEV No.	690136	Ref. No. 3FL0197
sliding plate mounting pos. right L 28mm H 3mm W 21mm H2 12.5mm			
	GEV No.	691174	Ref. No. 35V9050
counterpart L 90mm W 60mm for door latch			
	GEV No.	700091	Ref. No. —
door catch mounting pos. right off-set 20mm L 110mm H 56mm W 33mm mounting distance 68/68mm zinc die cast series 6300			
	GEV No.	700098	Ref. No. 36M0820
door catch mounting pos. right off-set 38mm L 110mm H 74mm W 33mm mounting distance 68/68mm series 1750			

			
GEV No.	700098	Ref. No.	36M0820
description	door catch mounting pos. right off-set 38mm L 110mm H 74mm W 33mm mounting distance 68/68mm series 1750		
For models:	FC101, FC101E, FC241, FC241E, FC241G, FC61, FC61E, FCV101, FCV101-CSA, FCV101DM, FCV101DM-CSA, FCV101DS, FCV101DS-CSA, FCV101E, FCV101EDM, FCV101EDM-UL, FCV101EDS, FCV101EDS-UL, FCV101E-UL, FCV141, FCV141-CSA, FCV141DM, FCV141DM-CSA, FCV141DS, FCV141DS-CSA, FCV141E, FCV141EDM, FCV141EDS, FCV241, FCV241DM, FCV241DS, FCV241E, FCV241EDM, FCV241EDM-UL, FCV241EDS, FCV241EDS-UL, FCV241E-UL, FCV241G, FCV241G-CSA, FCV241GDM, FCV241GDM-CSA, FCV241GDS, FCV241GDS-CSA, FCV401DM, FCV401DM-CSA, FCV401EDM, FCV401EDM-UL, FCV61, FCV61-CSA, FCV61DM...(Other models you can see in the webshop)		
spare parts for	700098		
			
GEV No.	690136	Ref. No.	3FL0197
description	sliding plate mounting pos. right L 28mm H 3mm W 21mm H2 12.5mm		
accessories for	700098		
			
GEV No.	514281	Ref. No.	36M1570
description	base plate L 110mm W 35mm for door catch thickness 10mm		

			
GEV No.	690137	Ref. No.	36E2530 6300843
description	sliding plate mounting pos. left L 28mm H 3mm W 21mm H2 12.5mm		
For models:	FC101, FC1011E, FC1011G, FC101E, FC1221E, FC1221G, FC241, FC241E, FC241G, FC61, FC611E, FC611G, FC61E, FCV101, FCV101DM, FCV101DS, FCV101E, FCV101EDM, FCV101EDS, FCV141, FCV141DM, FCV141DS, FCV141E, FCV141EDM, FCV141EDS, FCV241, FCV241DM, FCV241DS, FCV241E, FCV241EDM, FCV241EDS, FCV241G, FCV241GDM, FCV241GDS, FCV401DM, FCV401EDM, FCV61, FCV61DM, FCV61DS, FCV61E, FCV61EDM, FCV61EDS, FM1011E1, FM1011E1-VERS.2006, FM1011E2, FM1011E2-VERS.2006, FM1011E3, FM1011E3-VERS.2006, FM1011G1, FM1011G1-VERS.2006...(Other models you can see in the webshop)		

			
GEV No.	690136	Ref. No.	3FL0197
description	sliding plate mounting pos. right L 28mm H 3mm W 21mm H2 12.5mm		
For models:	FCV101-CSA, FCV101DM-CSA, FCV101DS-CSA, FCV101EDM-UL, FCV101EDS-UL, FCV101E-UL, FCV141-CSA, FCV141DM-CSA, FCV141DS-CSA, FCV241EDM-UL, FCV241EDS-UL, FCV241E-UL, FCV241G-CSA, FCV241GDM-CSA, FCV241GDS-CSA, FCV401DM-CSA, FCV401EDM-UL, FCV61-CSA, FCV61DM-CSA, FCV61DS-CSA, FCV61EDM-UL, FCV61EDS-UL, FCV61E-UL, FCV72EDM-UL, FCV72EDS-UL, FCV72E-UL		

STUV			
			
GEV No.	700098	Ref. No.	36M0820
description	door catch mounting pos. right off-set 38mm L 110mm H 74mm W 33mm mounting distance 68/68mm series 1750		
For models:	FC101, FC101E, FC241, FC241E, FC241G, FC61, FC61E, FCV101, FCV101-CSA, FCV101DM, FCV101DM-CSA, FCV101DS, FCV101DS-CSA, FCV101E, FCV101EDM, FCV101EDM-UL, FCV101EDS, FCV101EDS-UL, FCV101E-UL, FCV141, FCV141-CSA, FCV141DM, FCV141DM-CSA, FCV141DS, FCV141DS-CSA, FCV141E, FCV141EDM, FCV141EDS, FCV241, FCV241DM, FCV241DS, FCV241E, FCV241EDM, FCV241EDM-UL, FCV241EDS, FCV241EDS-UL, FCV241E-UL, FCV241G, FCV241G-CSA, FCV241GDM, FCV241GDM-CSA, FCV241GDS, FCV241GDS-CSA, FCV401DM, FCV401DM-CSA, FCV401EDM, FCV401EDM-UL, FCV61, FCV61-CSA, FCV61DM...(Other models you can see in the webshop)		
accessories for	700098		
			
GEV No.	514281	Ref. No.	36M1570
description	base plate L 110mm W 35mm for door catch thickness 10mm		

producer-specific			
ANGELO PO			
			
GEV No.	694640	Ref. No.	36E2580 36E2581
description	door catch H 42mm mounting pos. left L 98mm W 42mm for turning lever lock		
For models:	FC1011E, FC1011G, FC1221E, FC1221G, FC611E, FC611G, FM1011E1, FM1011E1-VERS.2006, FM1011E2, FM1011E2-VERS.2006, FM1011E3, FM1011E3-VERS.2006, FM1011G1, FM1011G1-VERS.2006, FM1011G2, FM1011G2-VERS.2006, FM1011G3, FM1011G3-VERS.2006, FM1221E1, FM1221E1-VERS.2006, FM1221E2, FM1221E2-VERS.2006, FM1221E3, FM1221E3-VERS.2006, FM1221G1, FM1221G1-VERS.2006, FM1221G2, FM1221G2-VERS.2006, FM1221G3, FM1221G3-VERS.2006, FM2011E2-VERS.2006, FM2011E3-VERS.2006, FM2011G2-VERS.2006, FM2011G3-VERS.2006, FM2021E1, FM2021E2, FM2021E2-VERS.2006, FM2021E3, FM2021E3-VERS.2006, FM2021G1, FM2021G2, FM2021G2-VERS.2006, FM2021G3, FM2021G3-VERS.2006, FM611E1, FM611E1-VERS.2006, FM611E2, FM611E2-VERS.2006, FM611E3, FM611E3-VERS.2006...(Other models you can see in the webshop)		
accessories for	694640		
			
GEV No.	694227	Ref. No.	36E2570
description	handle latch convection oven		





1

GEV No.	694227	Ref. No.	36E2570	
description	handle latch convection oven			
For models:	FC1011E, FC1011G, FC1221E, FC1221G, FC611E, FC611G, FM1011E1, FM1011E1-VERS.2006, FM1011E2, FM1011E2-VERS.2006, FM1011E3, FM1011E3-VERS.2006, FM1011G1, FM1011G1-VERS.2006, FM1011G2, FM1011G2-VERS.2006, FM1011G3, FM1011G3-VERS.2006, FM1221E1, FM1221E1-VERS.2006, FM1221E2, FM1221E2-VERS.2006, FM1221E3, FM1221E3-VERS.2006, FM1221G1, FM1221G1-VERS.2006, FM1221G2, FM1221G2-VERS.2006, FM1221G3, FM1221G3-VERS.2006, FM2011E2-VERS.2006, FM2011E3-VERS.2006, FM2011G2-VERS.2006, FM2011G3-VERS.2006, FM2021E1, FM2021E2, FM2021E2-VERS.2006, FM2021E3, FM2021E3-VERS.2006, FM2021G1, FM2021G2, FM2021G2-VERS.2006, FM2021G3, FM2021G3-VERS.2006, FM611E1, FM611E1-VERS.2006, FM611E2, FM611E2-VERS.2006, FM611E3, FM611E3-VERS.2006... (Other models you can see in the webshop)			
accessories for	694227			
	GEV No.	694640	Ref. No.	36E2580 36E2581
	door catch H 42mm mounting pos. left L 98mm W 42mm for turning lever lock			



1

GEV No.	514281	Ref. No.	36M1570
description	base plate L 110mm W 35mm for door catch thickness 10mm		
For models:	FC101, FC101E, FC241, FC241E, FC241G, FC61, FC61E, FCV101, FCV101-CSA, FCV101DM, FCV101DM-CSA, FCV101DS, FCV101DS-CSA, FCV101E, FCV101EDM, FCV101EDM-UL, FCV101EDS, FCV101EDS-UL, FCV101E-UL, FCV141, FCV141-CSA, FCV141DM, FCV141DM-CSA, FCV141DS, FCV141DS-CSA, FCV141E, FCV141EDM, FCV141EDS, FCV241, FCV241DM, FCV241DS, FCV241E, FCV241EDM, FCV241EDM-UL, FCV241EDS, FCV241EDS-UL, FCV241E-UL, FCV241G, FCV241G-CSA, FCV241GDM, FCV241GDM-CSA, FCV241GDS, FCV241GDS-CSA, FCV61, FCV61-CSA, FCV61DM, FCV61DM-CSA, FCV61DS, FCV61DS-CSA, FCV61E... (Other models you can see in the webshop)		



1

GEV No.	691174	Ref. No.	35V9050
description	counterpart L 90mm W 60mm for door latch		
For models:	FC101, FC101E, FC241E, FC241G, FC61, FC61E, FCV101, FCV101-CSA, FCV101DM, FCV101DM-CSA, FCV101DS, FCV101DS-CSA, FCV101E, FCV101EDM, FCV101EDM-UL, FCV101EDS, FCV101EDS-UL, FCV101E-UL, FCV141, FCV141-CSA, FCV141DM, FCV141DM-CSA, FCV141DS, FCV141DS-CSA, FCV141E, FCV141EDM, FCV141EDS, FCV241E, FCV241EDM, FCV241EDM-UL, FCV241EDS, FCV241EDS-UL, FCV241G, FCV241G-CSA, FCV241GDM, FCV241GDM-CSA, FCV241GDS, FCV241GDS-CSA, FCV61, FCV61-CSA, FCV61DM, FCV61DM-CSA, FCV61DS, FCV61DS-CSA, FCV61E, FCV61EDM, FCV61EDM-UL, FCV61EDS, FCV61EDS-UL, FCV61E-UL... (Other models you can see in the webshop)		











1

GEV No.	700711	Ref. No.	6300420	
description	door catch			
For models:	FC101, FC101E, FC241, FC241E, FC241G, FC61, FC61E, FCV101, FCV101-CSA, FCV101DM, FCV101DM-CSA, FCV101DS, FCV101DS-CSA, FCV101E, FCV101EDM, FCV101EDM-UL, FCV101EDS, FCV101EDS-UL, FCV101E-UL, FCV141, FCV141-CSA, FCV141DM, FCV141DM-CSA, FCV141DS, FCV141DS-CSA, FCV141E, FCV141EDM, FCV141EDS, FCV241, FCV241DM, FCV241DS, FCV241E, FCV241EDM, FCV241EDM-UL, FCV241EDS, FCV241EDS-UL, FCV241E-UL, FCV241G, FCV241G-CSA, FCV241GDM, FCV241GDM-CSA, FCV241GDS, FCV241GDS-CSA, FCV401DM, FCV401DM-CSA, FCV401EDM, FCV401EDM-UL, FCV61, FCV61-CSA, FCV61DM... (Other models you can see in the webshop)			
accessories for	700711			
	GEV No.	514281	Ref. No.	36M1570
	base plate L 110mm W 35mm for door catch thickness 10mm			
	GEV No.	700098	Ref. No.	36M0820
	door catch mounting pos. right off-set 38mm L 110mm H 74mm W 33mm mounting distance 68/68mm series 1750			



1

GEV No.	700098	Ref. No.	36M0820	
description	door catch mounting pos. right off-set 38mm L 110mm H 74mm W 33mm mounting distance 68/68mm series 1750			
For models:	FC101, FC101E, FC241, FC241E, FC241G, FC61, FC61E, FCV101, FCV101-CSA, FCV101DM, FCV101DM-CSA, FCV101DS, FCV101DS-CSA, FCV101E, FCV101EDM, FCV101EDM-UL, FCV101EDS, FCV101EDS-UL, FCV101E-UL, FCV141, FCV141-CSA, FCV141DM, FCV141DM-CSA, FCV141DS, FCV141DS-CSA, FCV141E, FCV141EDM, FCV141EDS, FCV241, FCV241DM, FCV241DS, FCV241E, FCV241EDM, FCV241EDM-UL, FCV241EDS, FCV241EDS-UL, FCV241E-UL, FCV241G, FCV241G-CSA, FCV241GDM, FCV241GDM-CSA, FCV241GDS, FCV241GDS-CSA, FCV401DM, FCV401DM-CSA, FCV401EDM, FCV401EDM-UL, FCV61, FCV61-CSA, FCV61DM... (Other models you can see in the webshop)			
spare parts for	700098			
	GEV No.	690136	Ref. No.	3FL0197
	sliding plate mounting pos. right L 28mm H 3mm W 21mm H2 12.5mm			
accessories for	700098			
	GEV No.	514281	Ref. No.	36M1570
	base plate L 110mm W 35mm for door catch thickness 10mm			

			
1			
GEV No.	690500	Ref. No.	36M0880 36M3180 36M6380 6300421
description	handle latch right L 185mm H 66mm handle material plastic type 6300 series		
For models:	FC101, FC101E, FC241, FC241E, FC241G, FC61, FC61E, FCV101, FCV101-CSA, FCV101DM, FCV101DM-CSA, FCV101DS, FCV101DS-CSA, FCV101E, FCV101EDM, FCV101EDM-UL, FCV101EDS, FCV101EDS-UL, FCV101E-UL, FCV141, FCV141-CSA, FCV141DM, FCV141DM-CSA, FCV141DS, FCV141DS-CSA, FCV141E, FCV141EDM, FCV141EDS, FCV241, FCV241DM, FCV241DS, FCV241E, FCV241EDM, FCV241EDM-UL, FCV241EDS, FCV241EDS-UL, FCV241E-UL, FCV241G, FCV241G-CSA, FCV241GDM, FCV241GDM-CSA, FCV241GDS, FCV241GDS-CSA, FCV401DM, FCV401DM-CSA, FCV401EDM, FCV401EDM-UL, FCV61, FCV61-CSA, FCV61DM...(Other models you can see in the webshop)		
spare parts for	690500		
		GEV No.	699841 Ref. No. —
	cover cap for turning lever lock ø 32mm H 14mm		
accessories for	690500		
		GEV No.	514281 Ref. No. 36M1570
	base plate L 110mm W 35mm for door catch thickness 10mm		
		GEV No.	690136 Ref. No. 3FL0197
	sliding plate mounting pos. right L 28mm H 3mm W 21mm H2 12.5mm		
		GEV No.	691174 Ref. No. 35V9050
	counterpart L 90mm W 60mm for door latch		
		GEV No.	700091 Ref. No. —
	door catch mounting pos. right off-set 20mm L 110mm H 56mm W 33mm mounting distance 68/68mm zinc die cast series 6300		
		GEV No.	700098 Ref. No. 36M0820
	door catch mounting pos. right off-set 38mm L 110mm H 74mm W 33mm mounting distance 68/68mm series 1750		

			
1			
GEV No.	111786	Ref. No.	37M4040
description	knob dial plate		
For models:	FC101, FC101E, FC241, FC241E, FC241G, FC61, FC61E, FCV101, FCV101-CSA, FCV101DM, FCV101DS, FCV101E, FCV101EDM, FCV101EDS, FCV101EDS-UL, FCV101E-UL, FCV141, FCV141DM, FCV141DS, FCV141E, FCV141EDM, FCV141EDS, FCV241, FCV241DM, FCV241DS, FCV241E, FCV241EDM, FCV241EDM-UL, FCV241EDS, FCV241EDS-UL, FCV241G, FCV241G-CSA, FCV241GDM, FCV241GDS, FCV401DM, FCV401EDM, FCV4E, FCV4EDS, FCV61, FCV61DM, FCV61DS, FCV61E, FCV61EDM, FCV61EDS, FCV61E-UL, FCV72EDM-UL, FCV72EDS-UL		

			
1			
GEV No.	690136	Ref. No.	3FL0197
description	sliding plate mounting pos. right L 28mm H 3mm W 21mm H2 12.5mm		
For models:	FCV101-CSA, FCV101DM-CSA, FCV101DS-CSA, FCV101EDM-UL, FCV101EDS-UL, FCV101E-UL, FCV141-CSA, FCV141DM-CSA, FCV141DS-CSA, FCV241EDM-UL, FCV241EDS-UL, FCV241E-UL, FCV241G-CSA, FCV241GDM-CSA, FCV241GDS-CSA, FCV401DM-CSA, FCV401EDM-UL, FCV61-CSA, FCV61DM-CSA, FCV61DS-CSA, FCV61EDM-UL, FCV61EDS-UL, FCV61E-UL, FCV72EDM-UL, FCV72EDS-UL, FCV72E-UL		

handle latches

universal

inside fixing

locks









			
1			
GEV No.	694054	Ref. No.	36M7000
description	door handle for headed units L 145mm W 40mm H 62mm spring length 33mm inner black		
For models:	BX101E, BX101E-VERS.122013, BX101G, BX101G-VERS.122013, BX122E, BX122E-VERS.122013, BX122G, BX122G-VERS.122013, BX61E, BX61E-VERS.122013, BX61G, BX61G-VERS.122013, BX82E, BX82E-VERS.122013, BX82G, BX82G-VERS.122013, FCV3EM, FCV4E, FCV4EDS, FCV4EM, FM423E1, FM423E2		
spare parts for	694054		
		GEV No.	514390 Ref. No. 3005920 3236250
	spring for door handle ø 6mm L 54mm W 27.5mm		
		GEV No.	694675 Ref. No. —
	door catch L 88mm W 40mm H 37mm spring length 33mm mounting distance 60mm		
		GEV No.	694734 Ref. No. —
	door handle L 165mm W 40mm H 25mm black		
		GEV No.	694735 Ref. No. —
	cap ø 32mm black		
accessories for	694054		
		GEV No.	691123 Ref. No. 36E2060
	duct for door opener		
		GEV No.	694055 Ref. No. 3238740 3238750 36C4391
	door catch L 25mm W 14mm total length 54mm thread M8 thread L 29mm		
		GEV No.	694066 Ref. No. —
	door catch with spigot 2-stage L 28mm W 14mm H 15mm H1 16mm total length 51mm thread M8 thread L 23mm stainless steel		

Table continues overleaf





accessories for 694054	
	GEV No. 694067 Ref. No. 3108770
door catch with spigot 1-stage L 26mm total length 51mm thread M8	





producer-specific



ANGELO PO

	
1	
GEV No.	514289 Ref. No. 36D3670
description	bush for door mechanism
For models:	FCV3EM, FCV4E, FCV4EDS, FCV4EM

	
1	
GEV No.	514287 Ref. No. 36Q1360
description	bush H 8mm thickness 2mm D1 ø 14mm D2 ø 10mm
For models:	FCV3EM, FCV4E, FCV4EDS, FCV4EM

	
1	
GEV No.	514288 Ref. No. 30G1650 30G2192
description	door catch ø 10mm L 102mm door catch height 24mm T1: M8 T2: M20x1.5
For models:	FCV3EM, FCV4E, FCV4EDS, FCV4EM
accessories for 514288	
	GEV No. 514287 Ref. No. 36Q1360
bush H 8mm thickness 2mm D1 ø 14mm D2 ø 10mm	



	
1	
GEV No.	514290 Ref. No. 36M5340
description	door handle L 150mm W 42mm H 57mm black plastic shaft 8x8mm intake square
For models:	FCV3EM, FCV4E, FCV4EDS, FCV4EM
accessories for 514290	
	GEV No. 111746 Ref. No. 37M4700
knob dial plate W 1mm ø 36mm	
	GEV No. 111786 Ref. No. 37M4040
knob dial plate	
	GEV No. 514286 Ref. No. 36D8011
sleeve L 15mm M20x1.5	



accessories for 514290	
	GEV No. 514287 Ref. No. 36Q1360
bush H 8mm thickness 2mm D1 ø 14mm D2 ø 10mm	
	GEV No. 514288 Ref. No. 30G1650 30G2192
door catch ø 10mm L 102mm door catch height 24mm T1: M8 T2: M20x1.5	
	GEV No. 514289 Ref. No. 36D3670
bush for door mechanism	

	
1	
GEV No.	111786 Ref. No. 37M4040
description	knob dial plate
For models:	FC101, FC101E, FC241, FC241E, FC241G, FC61, FC61E, FCV101, FCV101-CSA, FCV101DM, FCV101DS, FCV101E, FCV101EDM, FCV101EDS, FCV101EDS-UL, FCV101E-UL, FCV141, FCV141DM, FCV141DS, FCV141E, FCV141EDM, FCV141EDS, FCV241, FCV241DM, FCV241DS, FCV241E, FCV241EDM, FCV241EDM-UL, FCV241EDS, FCV241EDS-UL, FCV241G, FCV241G-CSA, FCV241GDM, FCV241GDS, FCV401DM, FCV401EDM, FCV4E, FCV4EDS, FCV61, FCV61DM, FCV61DS, FCV61E, FCV61EDM, FCV61EDS, FCV61E-UL, FCV72EDM-UL, FCV72EDS-UL

	
1	
GEV No.	111746 Ref. No. 37M4700
description	knob dial plate W 1mm ø 36mm
For models:	FCV3EM, FCV4EM

	
1	
GEV No.	514286 Ref. No. 36D8011
description	sleeve L 15mm M20x1.5
For models:	FCV3EM, FCV4E, FCV4EDS, FCV4EM





 <p>1</p>			
GEV No.	694055	Ref. No.	3238740 3238750 36C4391
description	door catch L 25mm W 14mm total length 54mm thread M8 thread L 29mm		
For models:	BX101E, BX101E-VERS.122013, BX101G, BX101G-VERS.122013, BX122E, BX122E-VERS.122013, BX122G, BX122G-VERS.122013, BX61E, BX61E-VERS.122013, BX61G, BX61G-VERS.122013, BX82E, BX82E-VERS.122013, BX82G, BX82G-VERS.122013, FCV3EM, FCV4E, FCV4EDS, FCV4EM, FM423E1, FM423E2, FX101E1, FX101E1R, FX101E2, FX101E2C, FX101E2C-VERS.032014, FX101E2R, FX101E2R-VERS.032014, FX101E2-VERS.032014, FX101E3, FX101E3C, FX101E3C-VERS.022014, FX101E3R, FX101E3R-VERS.022014, FX101E3-VERS.022014, FX101G1, FX101G1R, FX101G2, FX101G2C, FX101G2C-VERS.032014, FX101G2R, FX101G2R-VERS.032014, FX101G2-VERS.032014, FX101G3, FX101G3C, FX101G3C-VERS.022014, FX101G3R, FX101G3R-VERS.022014, FX101G3-VERS.022014...(Other models you can see in the webshop)		
accessories for	694055		
	 <p>GEV No. 694772 Ref. No. 36E2490</p>	protection cap for door catch ø 21mm	

accessories for	694054		
	 <p>GEV No. 694055 Ref. No. 3238740 3238750 36C4391</p>	door catch L 25mm W 14mm total length 54mm thread M8 thread L 29mm	
	 <p>GEV No. 694066 Ref. No. —</p>	door catch with spigot 2-stage L 28mm W 14mm H 15mm H1 16mm total length 51mm thread M8 thread L 23mm stainless steel	
	 <p>GEV No. 694067 Ref. No. 3108770</p>	door catch with spigot 1-stage L 26mm total length 51mm thread M8	

 <p>1</p>			
GEV No.	691123	Ref. No.	36E2060
description	duct for door opener		
For models:	FCV3EM, FCV4E, FCV4EDS, FCV4EM, FM423E1, FM423E2		

 <p>1</p>			
GEV No.	517174	Ref. No.	3110050 33Q6470
description	nut thread M8 H 6.5mm WS 13 SS DIN/ISO DIN 934 / ISO 4032/8673 Qty 1 pcs		

 <p>1</p>			
GEV No.	694772	Ref. No.	36E2490
description	protection cap for door catch ø 21mm		
For models:	BX101E, BX101E-VERS.122013, BX101G, BX101G-VERS.122013, BX122E, BX122E-VERS.122013, BX122G, BX122G-VERS.122013, BX61E, BX61E-VERS.122013, BX61G, BX61G-VERS.122013, BX82E, BX82E-VERS.122013, BX82G, BX82G-VERS.122013, FCV3EM, FCV4E, FCV4EDS, FCV4EM, FM423E1, FM423E2, FX101E1, FX101E1R, FX101E2, FX101E2C, FX101E2C-VERS.032014, FX101E2R, FX101E2R-VERS.032014, FX101E2-VERS.032014, FX101E3, FX101E3C, FX101E3C-VERS.022014, FX101E3R, FX101E3R-VERS.022014, FX101E3-VERS.022014, FX101G1, FX101G1R, FX101G2, FX101G2C, FX101G2C-VERS.032014, FX101G2R, FX101G2R-VERS.032014, FX101G2-VERS.032014, FX101G3, FX101G3C, FX101G3C-VERS.022014, FX101G3R, FX101G3R-VERS.022014, FX101G3-VERS.022014...(Other models you can see in the webshop)		

 <p>1</p>			
GEV No.	694054	Ref. No.	36M7000
description	door handle for headed units L 145mm W 40mm H 62mm spring length 33mm inner black		
For models:	BX101E, BX101E-VERS.122013, BX101G, BX101G-VERS.122013, BX122E, BX122E-VERS.122013, BX122G, BX122G-VERS.122013, BX61E, BX61E-VERS.122013, BX61G, BX61G-VERS.122013, BX82E, BX82E-VERS.122013, BX82G, BX82G-VERS.122013, FCV3EM, FCV4E, FCV4EDS, FCV4EM, FM423E1, FM423E2		
spare parts for	694054		
	 <p>GEV No. 514390 Ref. No. 3005920 3236250</p>	spring for door handle ø 6mm L 54mm W 27.5mm	
	 <p>GEV No. 694675 Ref. No. —</p>	door catch L 88mm W 40mm H 37mm spring length 33mm mounting distance 60mm	
	 <p>GEV No. 694734 Ref. No. —</p>	door handle L 165mm W 40mm H 25mm black	
	 <p>GEV No. 694735 Ref. No. —</p>	cap ø 32mm black	
accessories for	694054		
	 <p>GEV No. 691123 Ref. No. 36E2060</p>	duct for door opener	





			
1			
GEV No.	514390	Ref. No.	3005920 3236250
description	spring for door handle \varnothing 6mm L 54mm W 27.5mm		
For models:	BX101E, BX101E-VERS.122013, BX101G, BX101G-VERS.122013, BX122E, BX122E-VERS.122013, BX122G, BX122G-VERS.122013, BX61E, BX61E-VERS.122013, BX61G, BX61G-VERS.122013, BX82E, BX82E-VERS.122013, BX82G, BX82G-VERS.122013, FCV3EM, FCV4E, FCV4EDS, FCV4EM, FM423E1, FM423E2, FX101E1R, FX101E2R, FX101E2R-VERS.032014, FX101E3R, FX101E3R-VERS.022014, FX101G1R, FX101G2R, FX101G2R-VERS.032014, FX101G3R, FX101G3R-VERS.022014, FX10E2CR, FX10E2CR-VERS.032014, FX10E3CR, FX10E3CR-VERS.022014, FX10G2CR, FX10G2CR-VERS.032014, FX10G3CR, FX10G3CR-VERS.022014, FX61E1R, FX61E2CR, FX61E2CR-VERS.032014, FX61E2R, FX61E2R-VERS.032014, FX61E3CR, FX61E3CR-VERS.022014, FX61E3R, FX61E3R-VERS.022014, FX61G1R...(Other models you can see in the webshop)		

handles			
			
1			
GEV No.	694631	Ref. No.	3104201 3104202 3104203
description	door handle for combi-steamer L 210mm W 170mm H 55mm silver plastic		
For models:	FX101E1, FX101E2, FX101E2C, FX101E2C-VERS.032014, FX101E2-VERS.032014, FX101E3, FX101E3C, FX101E3C-VERS.022014, FX101E3R, FX101E3-VERS.022014, FX101G1, FX101G2, FX101G2C, FX101G2C-VERS.032014, FX101G2-VERS.032014, FX101G3, FX101G3C, FX101G3C-VERS.022014, FX101G3-VERS.022014, FX10E2CR-VERS.032014, FX122E1, FX122E2, FX122E2C, FX122E2T, FX122E2T-VERS.032014, FX122E3, FX122E3C, FX122E3T, FX122E3T-VERS.022014, FX122G1, FX122G3, FX122G3C, FX122G3T, FX122G3T-VERS.022014, FX12E3CT, FX12E3CT-VERS.022014, FX12G3CT, FX12G3CT-VERS.022014, FX201E2, FX201E2P, FX201E2P-VERS.032014, FX201E2-VERS.032014, FX201E3, FX201E3P, FX201E3P-VERS.022014, FX201E3-VERS.022014, FX201G2, FX201G2P, FX201G2P-VERS.032014, FX201G2-VERS.032014...(Other models you can see in the webshop)		

edgmount latches

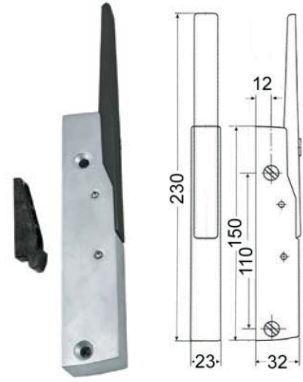
handle latches

CAFF/FERMOD

			
1			
GEV No.	690454	Ref. No.	36M0470
description	handle latch L 150mm mounting distance 110mm matt chrome-plated/Rilsan non lockable heated units 560 black complete with door catch		
spare parts for	690454		
		GEV No.	690429
		Ref. No.	—
	door catch CT 25.5mm		
accessories for	690454		
		GEV No.	690428
		Ref. No.	36M0480
	door catch H 51mm W 13.9mm mounting distance 30mm plastic CT 16.5mm		
		GEV No.	690445
		Ref. No.	—
	base plate H 2mm		
		GEV No.	690446
		Ref. No.	—
	base plate H 5mm L 56mm W 18mm		

RAHRBACH

6201 DUPLO series

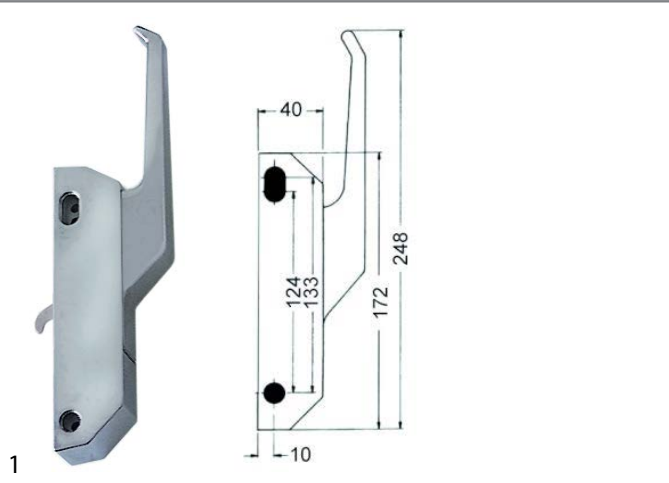

GEV No.	690024	Ref. No.	36M0600
description	handle latch L 172mm mounting distance 124/133mm chrome-plated non lockable refrigeration units 6201 H 65mm type DUPLO total length 248mm		
accessories for	690024		
	GEV No.	690123	Ref. No. —
	door catch with roller		

door catches



GEV No.	690428	Ref. No.	36M0480
description	door catch H 51mm W 13.9mm mounting distance 30mm plastic CT 16.5mm		

snap locks

universal



GEV No.	690596	Ref. No.	36M3600
description	snap lock L 60mm W 15mm H 36mm mounting distance 48/28mm spring thickness 1.5mm complete with door catch zamak		

espagnolette locks

universal



GEV No.	690041	Ref. No.	3088460
description	cam L 148mm mounting distance 32mm		

producer-specific

ANGELO PO

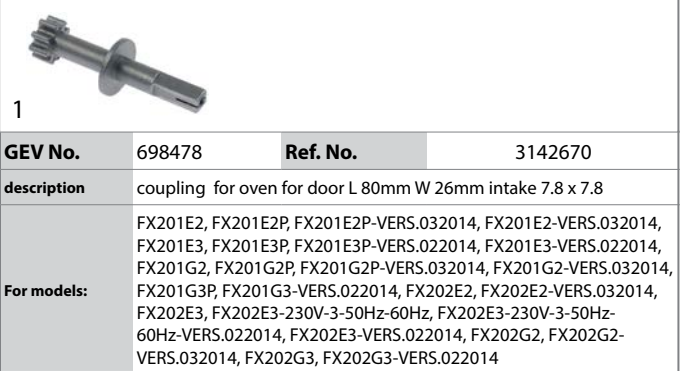

GEV No.	698478	Ref. No.	3142670
description	coupling for oven for door L 80mm W 26mm intake 7.8 x 7.8		
For models:	FX201E2, FX201E2P, FX201E2P-VERS.032014, FX201E2-VERS.032014, FX201E3, FX201E3P, FX201E3P-VERS.022014, FX201E3-VERS.022014, FX201G2, FX201G2P, FX201G2P-VERS.032014, FX201G2-VERS.032014, FX201G3P, FX201G3-VERS.022014, FX202E2, FX202E2-VERS.032014, FX202E3, FX202E3-230V-3-50Hz-60Hz, FX202E3-230V-3-50Hz-60Hz-VERS.022014, FX202E3-VERS.022014, FX202G2, FX202G2-VERS.032014, FX202G3, FX202G3-VERS.022014		



GEV No.	692718	Ref. No.	3104152 3104153
description	cover cap ø 38.5mm		
For models:	FX101E1, FX101E2, FX101E2C, FX101E2C-VERS.032014, FX101E2-VERS.032014, FX101E3, FX101E3C, FX101E3C-VERS.022014, FX101E3R, FX101E3-VERS.022014, FX101G1, FX101G2, FX101G2C, FX101G2C-VERS.032014, FX101G2-VERS.032014, FX101G3, FX101G3C, FX101G3C-VERS.022014, FX101G3-VERS.022014, FX10E2CR-VERS.032014, FX122E1, FX122E2, FX122E2C, FX122E2T, FX122E2T-VERS.032014, FX122E3, FX122E3C, FX122E3T, FX122E3T-VERS.022014, FX122G1, FX122G3, FX122G3C, FX122G3T, FX122G3T-VERS.022014, FX12E3CT, FX12E3CT-VERS.022014, FX12G3CT, FX12G3CT-VERS.022014, FX201E2, FX201E2P, FX201E2P-VERS.032014, FX201E2-VERS.032014, FX201E3, FX201E3P, FX201E3P-VERS.022014, FX201E3-VERS.022014, FX201G2, FX201G2P, FX201G2P-VERS.032014, FX201G2-VERS.032014...(Other models you can see in the webshop)		



GEV No.	694631	Ref. No.	3104201 3104202 3104203
description	door handle for combi-steamer L 210mm W 170mm H 55mm silver plastic		
For models:	FX101E1, FX101E2, FX101E2C, FX101E2C-VERS.032014, FX101E2-VERS.032014, FX101E3, FX101E3C, FX101E3C-VERS.022014, FX101E3R, FX101E3-VERS.022014, FX101G1, FX101G2, FX101G2C, FX101G2C-VERS.032014, FX101G2-VERS.032014, FX101G3, FX101G3C, FX101G3C-VERS.022014, FX101G3-VERS.022014, FX10E2CR-VERS.032014, FX122E1, FX122E2, FX122E2C, FX122E2T, FX122E2T-VERS.032014, FX122E3, FX122E3C, FX122E3T, FX122E3T-VERS.022014, FX122G1, FX122G3, FX122G3C, FX122G3T, FX122G3T-VERS.022014, FX12E3CT, FX12E3CT-VERS.022014, FX12G3CT, FX12G3CT-VERS.022014, FX201E2, FX201E2P, FX201E2P-VERS.032014, FX201E2-VERS.032014, FX201E3, FX201E3P, FX201E3P-VERS.022014, FX201E3-VERS.022014, FX201G2, FX201G2P, FX201G2P-VERS.032014, FX201G2-VERS.032014...(Other models you can see in the webshop)		

			
GEV No.	698503	Ref. No.	6300965
description	espagnolette lock complete		
For models:	FX201E2, FX201E2P, FX201E2P-VERS.032014, FX201E2-VERS.032014, FX201E3, FX201E3P, FX201E3P-VERS.022014, FX201E3-VERS.022014, FX201G2, FX201G2P, FX201G2P-VERS.032014, FX201G2-VERS.032014, FX201G3P, FX201G3-VERS.022014, FX202E2, FX202E2-VERS.032014, FX202E3, FX202E3-230V-3-50Hz-60Hz, FX202E3-230V-3-50Hz-60Hz-VERS.022014, FX202E3-VERS.022014, FX202G2, FX202G2-VERS.032014, FX202G3, FX202G3-VERS.022014		
accessories for	698503		
	GEV No.	690041	Ref. No. 3088460
	cam L 148mm mounting distance 32mm		
	GEV No.	694409	Ref. No. —
	mounting set for espagnolette lock 694382		
	GEV No.	700604	Ref. No. —
	latch gear opening to the right shaft intake \varnothing 8x8mm L 170mm W 40mm H 40mm		

			
GEV No.	692720	Ref. No.	3101630
description	gasket for door latch PTFE D1 \varnothing 26mm D2 \varnothing 11.7mm thickness 2mm		
For models:	FX201E2, FX201E2P, FX201E2P-VERS.032014, FX201E2-VERS.032014, FX201E3, FX201E3P, FX201E3P-VERS.022014, FX201E3-VERS.022014, FX201G2, FX201G2P, FX201G2P-VERS.032014, FX201G2-VERS.032014, FX201G3P, FX201G3-VERS.022014, FX202E2, FX202E2-VERS.032014, FX202E3, FX202E3-230V-3-50Hz-60Hz, FX202E3-230V-3-50Hz-60Hz-VERS.022014, FX202E3-VERS.022014, FX202G2, FX202G2-VERS.032014, FX202G3, FX202G3-VERS.022014		

miscellaneous

			
GEV No.	518585	Ref. No.	36M1240
description	door catch		

hinges

piano hinges

universal

			
GEV No.	692866	Ref. No.	3085860
description	hinge L 25mm mounting distance 14mm hole \varnothing 3mm thickness 1mm		
For models:	BX101E, BX101E-VERS.122013, BX101G, BX101G-VERS.122013, BX122E, BX122E-VERS.122013, BX122G, BX122G-VERS.122013, BX61E, BX61E-VERS.122013, BX61G, BX61G-VERS.122013, BX82E, BX82E-VERS.122013, BX82G, BX82G-VERS.122013, FX101E1, FX101E1R, FX101E2, FX101E2C, FX101E2C-VERS.032014, FX101E2R, FX101E2R-VERS.032014, FX101E2-VERS.032014, FX101E3, FX101E3C, FX101E3C-VERS.022014, FX101E3R, FX101E3R-VERS.022014, FX101E3-VERS.022014, FX101G1, FX101G1R, FX101G2, FX101G2C, FX101G2C-VERS.032014, FX101G2R, FX101G2R-VERS.032014, FX101G2-VERS.032014, FX101G3, FX101G3C, FX101G3C-VERS.022014, FX101G3R, FX101G3R-VERS.022014, FX101G3-VERS.022014, FX10E2CR, FX10E2CR-VERS.032014, FX10E3CR, FX10E3CR-VERS.022014, FX10G2CR, FX10G2CR-VERS.032014...(Other models you can see in the webshop)		

spring assisted hinges

universal

CAFF/FERMOD

group 2

			
GEV No.	690574	Ref. No.	36M2460
description	spring assisted hinge series 176 mounting pos. left/right L 75mm W 25.6mm A 11mm B 15mm mounting measurements 22x22mm intake 7.5x7.5		

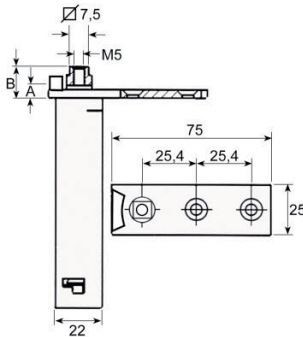

INTERKLIMAT

hinges

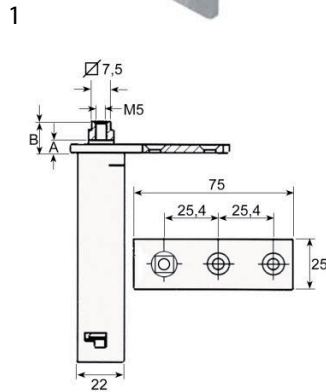

GEV No.	690622	Ref. No.	36G6520
description	spring assisted hinge series 28L mounting pos. left/right L 75mm W 25mm H 103mm A 13mm B 18mm mounting measurements 22x22mm intake 7.5x7.5 refrigeration units		

accessories



GEV No.	690747	Ref. No.	3178300
description	bush for hinge ID ϕ 7.5mm L 25.5mm W 25.5mm white mounting measurements 22x22mm H 4.5mm		
For models:	120, 120B, 120NN, 135, 135-4, 135A, 135B, 135BA, 135BN, 135BNX, 135BX, 135BXE, 135BXR, 135CPX, 135NN, 135NNX, 135X, 135X-3, 135X-4, 135XE, 135XR, 55, 55B, 65, 65A, 65B, 65BA, 65BX, 65BX-2, 65BXE, 65BXR, 65NB, 65NBX, 65NN, 65NNX, 65X, 65X-2, 65XE, 65XR, AF1B, AF1N, AF2B, AF2N, ART1L, ART1LA, ART1LD, ART1LDA, ART2LD, ART2SD, ART3SD...(Other models you can see in the webshop)		

producer-specific

ANGELO PO



GEV No.	691198	Ref. No.	36G2650
description	bar for spring hinge L 345mm ϕ 12mm		
For models:	191PD1G, 191PD2G, 191PI1G, 191PI1GA, 191PI2E, 191PI2EA, 191PI2G, 191PI2GA, 191PI2V, 191PI2VA, 1A1PD1G, 1A1PD2G, 1A1PI1G, 1A1PI1GA, 1A1PI2E, 1A1PI2EA, 1A1PI2G, 1A1PI2GA, 1A1PI2V, 1A1PI2VA, 1D1PD1G, 1D1PD2G, 1D1PI1G, 1D1PI1GA, 1D1PI2E, 1D1PI2EA, 1D1PI2G, 1D1PI2GA, 1D1PI2V, 1D1PI2VA, 1G1BR1E, 1G1BR1G, 1G1PD1G, 1G1PI1E, 1G1PI1G, 31PD6, 31PI6, 31PIE6, 31R, 31RE, 71AR, 71ARE, 71PD10, 71PD15, 71PI10, 71PI10A, 71PIE15, 71PIE15A, 71PV15, 71PV15A...(Other models you can see in the webshop)		



GEV No.	690747	Ref. No.	3178300
description	bush for hinge ID ϕ 7.5mm L 25.5mm W 25.5mm white mounting measurements 22x22mm H 4.5mm		
For models:	120, 120B, 120NN, 135, 135-4, 135A, 135B, 135BA, 135BN, 135BNX, 135BX, 135BXE, 135BXR, 135CPX, 135NN, 135NNX, 135X, 135X-3, 135X-4, 135XE, 135XR, 55, 55B, 65, 65A, 65B, 65BA, 65BX, 65BX-2, 65BXE, 65BXR, 65NB, 65NBX, 65NN, 65NNX, 65X, 65X-2, 65XE, 65XR, AF1B, AF1N, AF2B, AF2N, ART1L, ART1LA, ART1LD, ART1LDA, ART2LD, ART2SD, ART3SD...(Other models you can see in the webshop)		



GEV No.	691185	Ref. No.	36D2800
description	hinge camp mounting pos. left		
For models:	31PD6, 31PI6, 31PIE6, 31R, 31RE, 71AR, 71ARE, 71PD10, 71PD15, 71PI10, 71PI10A, 71PIE15, 71PIE15A, 71PV15, 71PV15A, 71RA, 91AR, 91ARE, 91PI10, 91PI10A, 91PIE15, 91PIE15A, 91RA		



GEV No.	691186	Ref. No.	36D2790
description	hinge camp mounting pos. right		
For models:	31PD6, 31PI6, 31PIE6, 31R, 31RE, 71AR, 71ARE, 71PD10, 71PD15, 71PI10, 71PI10A, 71PIE15, 71PIE15A, 71PV15, 71PV15A, 71RA, 91AR, 91ARE, 91PI10, 91PI10A, 91PIE15, 91PIE15A, 91RA		



GEV No.	690675	Ref. No.	6008500
description	spring assisted hinge left		
For models:	135PVX		



GEV No.	690573	Ref. No.	30M0350 36M0350
description	spring assisted hinge left refrigerator suitable for SAGI		

1

GEV No.	690674	Ref. No.	6008490
description	spring assisted hinge right L 128mm spring thickness 2.5mm		
For models:	135PVX, 55PV		



1

GEV No.	690675	Ref. No.	6008500
description	spring assisted hinge left		
For models:	135PVX		



1

GEV No.	690572	Ref. No.	36M0340
description	spring assisted hinge right refrigerator suitable for SAGI		



1

GEV No.	690573	Ref. No.	30M0350 36M0350
description	spring assisted hinge left refrigerator suitable for SAGI		

ELECTROLUX/ZANUSSI



1

GEV No.	690747	Ref. No.	3178300
description	bush for hinge ID \varnothing 7.5mm L 25.5mm W 25.5mm white mounting measurements 22x22mm H 4.5mm		
For models:	120, 120B, 120NN, 135, 135-4, 135A, 135B, 135BA, 135BN, 135BNX, 135BX, 135BXE, 135BXR, 135CPX, 135NN, 135NNX, 135X, 135X-3, 135X-4, 135XE, 135XR, 55, 55B, 65, 65A, 65B, 65BA, 65BX, 65BX-2, 65BXE, 65BXR, 65NB, 65NBX, 65NN, 65NNX, 65X, 65X-2, 65XE, 65XR, AF1B, AF1N, AF2B, AF2N, ART1L, ART1LA, ART1LD, ART1LDA, ART2LD, ART2SD, ART3SD...(Other models you can see in the webshop)		



1

GEV No.	690674	Ref. No.	6008490
description	spring assisted hinge right L 128mm spring thickness 2.5mm		
For models:	135PVX, 55PV		

SAGI



1

GEV No.	691198	Ref. No.	36G2650
description	bar for spring hinge L 345mm \varnothing 12mm		
For models:	191PD1G, 191PD2G, 191PI1G, 191PI1GA, 191PI2E, 191PI2EA, 191PI2G, 191PI2GA, 191PI2V, 191PI2VA, 1A1PD1G, 1A1PD2G, 1A1PI1G, 1A1PI1GA, 1A1PI2E, 1A1PI2EA, 1A1PI2G, 1A1PI2GA, 1A1PI2V, 1A1PI2VA, 1D1PD1G, 1D1PD2G, 1D1PI1G, 1D1PI1GA, 1D1PI2E, 1D1PI2EA, 1D1PI2G, 1D1PI2GA, 1D1PI2V, 1D1PI2VA, 1G1BR1E, 1G1BR1G, 1G1PD1G, 1G1PI1E, 1G1PI1G, 31PD6, 31PI6, 31PIE6, 31R, 31RE, 71AR, 71ARE, 71PD10, 71PD15, 71PI10, 71PI10A, 71PIE15, 71PIE15A, 71PV15, 71PV15A...(Other models you can see in the webshop)		



1

GEV No.	690572	Ref. No.	36M0340
description	spring assisted hinge right refrigerator suitable for SAGI		



1

GEV No.	690747	Ref. No.	3178300
description	bush for hinge ID \varnothing 7.5mm L 25.5mm W 25.5mm white mounting measurements 22x22mm H 4.5mm		
For models:	120, 120B, 120NN, 135, 135-4, 135A, 135B, 135BA, 135BN, 135BNX, 135BX, 135BXE, 135BXR, 135CPX, 135NN, 135NNX, 135X, 135X-3, 135X-4, 135XE, 135XR, 55, 55B, 65, 65A, 65B, 65BA, 65BX, 65BX-2, 65BXE, 65BXR, 65NB, 65NBX, 65NN, 65NNX, 65X, 65X-2, 65XE, 65XR, AF1B, AF1N, AF2B, AF2N, ART1L, ART1LA, ART1LD, ART1LDA, ART2LD, ART2SD, ART3SD...(Other models you can see in the webshop)		

oven hinges

			
GEV No.	109720	Ref. No.	35U3170
description	cover mounting distance 94mm L 124mm W 20mm oven hinge		
For models:	08WFA4E, 08WFA4G, 08WFAAE, 08WFAAG, 10WTPGE, 12WFA6E, 12WFA6G, 12WFAAE, 12WFAAG, 191FAAE, 191FAAG, 191FABG, 191FADG, 191FAE, 191FAG, 191PE4E, 191TPG, 1A1FA1G, 1A1FA2G, 1A1FA4G, 1A1FA5G, 1A1FAAG, 1A1FABG, 1A1FAS2G, 1A1FASG, 1A1PE4E, 1A1PEFTE, 1A1TP0G, 1A1TP0G-VERS.2002, 1A1FBE, 1B1FAS2G, 1B1FASG, 1D1FA1G, 1D1FA2G, 1D1FA4G, 1D1FA5G, 1D1FAAG, 1D1FABG, 1D1FAS2G, 1D1FASG, 1D1PE4E, 1D1TP0G, 1D1TP0G-VERS.2002, 1D1FBE, 1G1FA0E, 1G1FA0EV, 1G1FA0G, 1G1FA0GV, 1G1FAPG, 1G1PE1E...(Other models you can see in the webshop)		

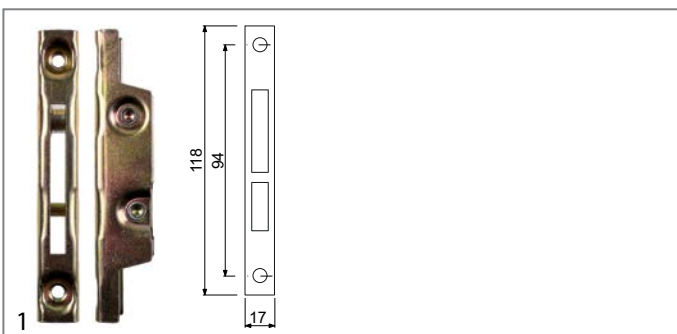

GEV No.	700001	Ref. No.	3094780 36M0120 36M0270
description	opposite support L 118mm W 17mm mounting distance 94mm		
For models:	08WFA4E, 08WFA4G, 08WFAAE, 08WFAAG, 10WTPGE, 12WFA6E, 12WFA6G, 12WFAAE, 12WFAAG, 191FAAE, 191FAAG, 191FABG, 191FADG, 191FAE, 191FAG, 191PE4E, 191TPG, 1A1FA1G, 1A1FA2G, 1A1FA4G, 1A1FA5G, 1A1FAAG, 1A1FABG, 1A1FAS2G, 1A1FASG, 1A1PE4E, 1A1PEFTE, 1A1TP0G, 1A1TP0G-VERS.2002, 1A1FBE, 1B1FAS2G, 1B1FASG, 1D1FA1G, 1D1FA2G, 1D1FA4G, 1D1FA5G, 1D1FAAG, 1D1FABG, 1D1FAS2G, 1D1FASG, 1D1PE4E, 1D1TP0G, 1D1TP0G-VERS.2002, 1D1FBE, 1G1FA0E, 1G1FA0EV, 1G1FA0G, 1G1FA0GV, 1G1FABG, 1G1FAPG...(Other models you can see in the webshop)		

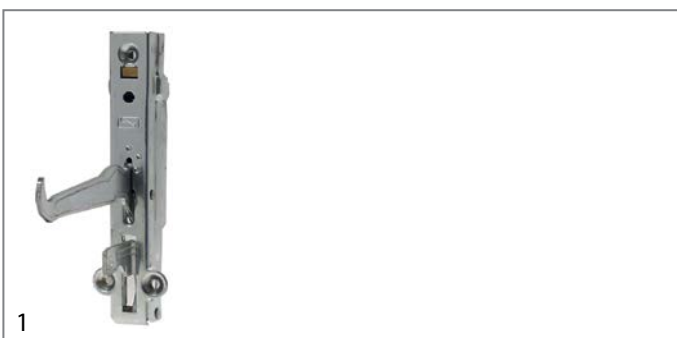

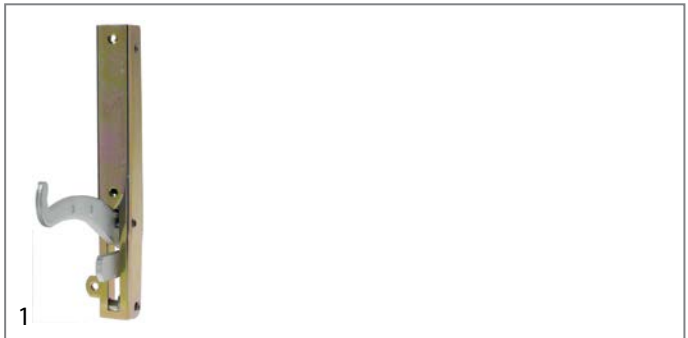

GEV No.	700704 ¹	Ref. No.	36M0190
description	oven hinge mounting distance 120mm lug mounting 13mm lever length 115mm groove distance 7mm spring thickness 2.2mm mounting ear position left/right spring length 52mm W 27mm		

¹with opposite support



GEV No.	700006	Ref. No.	36M0100 36M2420
description	oven hinge mounting distance 173mm mounting distance 2 105mm lug mounting 14mm lever length 120mm groove distance 11mm spring thickness 3.5mm mounting ear position left spring length 112mm W 25mm		
For models:	08WFA4E, 08WFA4G, 08WFAAE, 08WFAAG, 10WTPGE, 12WFA6E, 12WFA6G, 12WFAAE, 12WFAAG, 191FAAE, 191FAAG, 191FABG, 191FADG, 191FAE, 191FAG, 191PE4E, 191TPG, 1A1FA1G, 1A1FA2G, 1A1FA4G, 1A1FA5G, 1A1FAAG, 1A1FABG, 1A1FAS2G, 1A1FASG, 1A1PE4E, 1A1PEFTE, 1A1TP0G, 1A1TP0G-VERS.2002, 1A1FBE, 1B1FAS2G, 1B1FASG, 1D1FA1G, 1D1FA2G, 1D1FA4G, 1D1FA5G, 1D1FAAG, 1D1FABG, 1D1FAS2G, 1D1FASG, 1D1PE4E, 1D1TP0G, 1D1TP0G-VERS.2002, 1D1FBE, 1G1FA0E, 1G1FA0EV, 1G1FA0G, 1G1FA0GV, 1G1FABG, 1G1FAPG...(Other models you can see in the webshop)		

accessories for	700006			
	GEV No.	700001	Ref. No.	3094780 36M0120 36M0270
	opposite support L 118mm W 17mm mounting distance 94mm			
	GEV No.	700007	Ref. No.	36M0110 36M2430
	oven hinge mounting distance 173mm mounting distance 2 105mm lug mounting 14mm lever length 120mm groove distance 11mm spring thickness 3.5mm mounting ear position right spring length 112mm W 25mm			

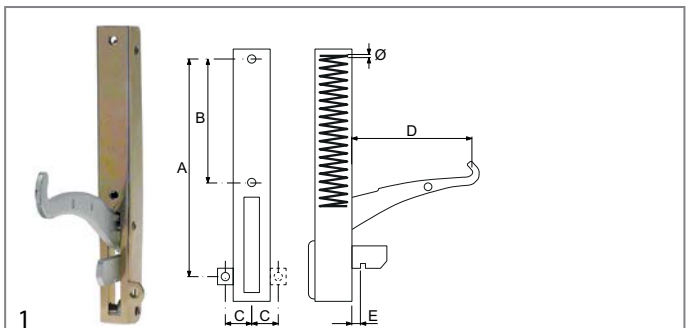

GEV No.	700007	Ref. No.	36M0110 36M2430
description	oven hinge mounting distance 173mm mounting distance 2 105mm lug mounting 14mm lever length 120mm groove distance 11mm spring thickness 3.5mm mounting ear position right spring length 112mm W 25mm		
For models:	08WFA4E, 08WFA4G, 08WFAAE, 08WFAAG, 10WTPGE, 12WFA6E, 12WFA6G, 12WFAAE, 12WFAAG, 191FAAE, 191FAAG, 191FABG, 191FADG, 191FAE, 191FAG, 191PE4E, 191TPG, 1A1FA1G, 1A1FA2G, 1A1FA4G, 1A1FA5G, 1A1FAAG, 1A1FABG, 1A1FAS2G, 1A1FASG, 1A1PE4E, 1A1PEFTE, 1A1TP0G, 1A1TP0G-VERS.2002, 1A1FBE, 1B1FAS2G, 1B1FASG, 1D1FA1G, 1D1FA2G, 1D1FA4G, 1D1FA5G, 1D1FAAG, 1D1FABG, 1D1FAS2G, 1D1FASG, 1D1PE4E, 1D1TP0G, 1D1TP0G-VERS.2002, 1D1FBE, 1G1FA0E, 1G1FA0EV, 1G1FA0G, 1G1FA0GV, 1G1FABG, 1G1FAPG...(Other models you can see in the webshop)		

accessories for	700007			
	GEV No.	700001	Ref. No.	3094780 36M0120 36M0270
	opposite support L 118mm W 17mm mounting distance 94mm			

door bearing



1

GEV No.	690686	Ref. No.	36G2810
description	bush for door hinge		
For models:	40, 40B, 40CP, 40CPX, 40PL, 40X, ART1L7, ART1L7A, ART1L7M, ART1LD7, ART1LD7A, ART1LD7M, BRPR, BRPR218, BRPR21C, BRPRV, BRVR, BRVR218, BRVR21C, BRVRV, K16APGPZ, K16XPZAP, SA16AGB, SA16GB, SA87, SM03LT7, SM03LT7A, SM03LT7M, SM1L7, SM1L7A, SM1L7FCV, SM1L7M, SM1LT7, SM1LT7A, SM1LT7M		



1

GEV No.	690742	Ref. No.	36D4610
description	bush for door hinge		
For models:	6BEA11Z, 6BEA2Z, 6BEA3Z, 6BEABA, 6BEABB, 6BEABM, 6BEABZ, 6BEAZ, 6BEB11Z, 6BEB22Z, 6BEB2Z, 6BEB3Z, 6BEB4Z, 6BEBBA, 6BEBBB, 6BEBBM, 6BEBBZ, 6BEBZ, 6BEC11Z, 6BEC22Z, 6BEC2Z, 6BEC33Z, 6BEC3Z, 6BEC4Z, 6BEC6Z, 6BECBA, 6BECBB, 6BECBM, 6BECBZ, 6BECZ, 6BMA11A, 6BMA11B, 6BMA11M, 6BMA11Z, 6BMA2A, 6BMA2B, 6BMA2M, 6BMA2Z, 6BMA3A, 6BMA3B, 6BMA3M, 6BMA3Z, 6BMAA, 6BMAB, 6BMABA, 6BMABB, 6BMABM, 6BMABZ, 6BMAM, 6BMAZ... (Other models you can see in the webshop)		



1

GEV No.	690743	Ref. No.	36D4700
description	bush for door hinge		
For models:	6BEA11Z, 6BEA2Z, 6BEA3Z, 6BEABA, 6BEABB, 6BEABM, 6BEABZ, 6BEAZ, 6BEB11Z, 6BEB22Z, 6BEB2Z, 6BEB3Z, 6BEB4Z, 6BEBBA, 6BEBBB, 6BEBBM, 6BEBBZ, 6BEBZ, 6BEC11Z, 6BEC22Z, 6BEC2Z, 6BEC33Z, 6BEC3Z, 6BEC4Z, 6BEC6Z, 6BECBA, 6BECBB, 6BECBM, 6BECBZ, 6BECZ, 6BMA11Z, 6BMA2Z, 6BMA3Z, 6BMABA, 6BMABB, 6BMABM, 6BMABZ, 6BMAZ, 6BMB11Z, 6BMB22Z, 6BMB2Z, 6BMB3Z, 6BMB4Z, 6BMBBZ, 6BMBZ, 6BMC11Z, 6BMC22Z, 6BMC2Z, 6BMC33Z, 6BMC3Z...(Other models you can see in the webshop)		



1

GEV No.	695571	Ref. No.	36M0090
description	bush for door hinge		
For models:	135-4, 135CPX, 135X-3, 135X-4, 65BX-2, 65NB, 65NBX, 65NN, 65NNX, 65X-2, CX140CP, CX150CP, CX65Z, CX65NB, CX65NCP, CX65NN, CX70Z, CX70NB, CX70NN, FSD2B2-OPR01, FSD2N2, FSD2N2-OPR01, FSDR2B2-OPR01, FSE2B2, FSE2B2-OPR01, FSE2N2, FSE2N2-OPR01, FSER2B2-OPR01, FSER2N2-OPR01, ISFEB, ISFEB-OPR01, ISFEN, ISFEN-OPR01, MD1504, MD150B4, MD70Z, MD70B2, MD70NB, MD70NCP, MD70NN, PD150CP, PD70Z, PD70B2, S12004, S1200B4, S125-4, S125B-4, S125BX-4, S125X-4, S600Z...(Other models you can see in the webshop)		



1

GEV No.	690479	Ref. No.	3170250
description	bush H 20mm ø 7mm mounting measurements 22x22mm external size 26.5x26.5mm		
For models:	135-4, 135CPX, 135X-3, 135X-4, 65BX-2, 65NB, 65NBX, 65NN, 65NNX, 65X-2, SP135CP, SP65NB, SP65NN		



1

GEV No.	690795	Ref. No.	36D9490
description	counterpart for spring hinge		
For models:	120, 120B, 120NN, 135, 135-4, 135A, 135B, 135BA, 135BN, 135BNX, 135BX, 135BXE, 135BXR, 135CPX, 135NN, 135NNX, 135X, 135X-3, 135X-4, 135XE, 135XR, 55, 55B, 65, 65A, 65B, 65BA, 65BX, 65BX-2, 65BXE, 65BXR, 65NB, 65NBX, 65NN, 65NNX, 65X, 65X-2, 65XE, 65XR, ART1L, ART1LA, ART1LD, ART1LDA, ART2LD, ART2SD, ART3SD, S125, S125-4, S125B, S125B-4...(Other models you can see in the webshop)		



1

GEV No.	691157	Ref. No.	30T2000
description	door hinge mounting pos. bottom right		



1

GEV No.	690563	Ref. No.	3AG0040
description	hinge		





1

GEV No.	690489	Ref. No.	30T5910
description	hinge L 138mm mounting pos. upper/lower		
For models:	135-4, 135CPX, 135X-3, 135X-4, 65BX-2, 65NB, 65NBX, 65NN, 65NNX, 65X-2, S125-4, S125B-4, S125BX-4, S125X-4, S60-2, S60B-2, S60BX-2, S60X-2, SP135CP, SP65NB, SP65NN		

			
1			
GEV No.	695570	Ref. No.	36M2490
description	hinge mounting pos. bottom left		
For models:	71CP, 71CP2, 71F, 71F2, 71F2B, 71FE, 71FE2, 71FE2B, 91CP, 91F210, 91F210B, 91F223B		

			
1			
GEV No.	690793	Ref. No.	30T4780
description	hinge mounting pos. bottom right		
For models:	120PV, 135PVX, 55PV, 65PVX		

			
1			
GEV No.	690788	Ref. No.	36M0320 36M2610
description	hinge mounting pos. centre with bolt		

			
1			
GEV No.	700740	Ref. No.	3043190 3088700
description	hinge mounting pos. lower		
For models:	3G65A, 3G65A2, 3G65A4, 4G65B, 4G65B2, 4G65B4, 4G65B6, 6BR15V, 6BR15VC, 6BR19V, 6BR19VC, 6EA, 6EA11, 6EA11A, 6EA11M, 6EA13, 6EA13A, 6EA13M, 6EA2, 6EA2A, 6EA2M, 6EAA, 6EAB, 6EABA, 6EABM, 6EAM, 6EB, 6EB11, 6EB11A, 6EB11M, 6EB13, 6EB13A, 6EB13M, 6EB2, 6EB22, 6EB22A, 6EB22M, 6EB2A, 6EB2M, 6EB4, 6EB4A, 6EB4M, 6EBA, 6EBB, 6EBBA, 6EBBM, 6EBM, 6EC, 6EC11, 6EC11A...(Other models you can see in the webshop)		

			
1			
GEV No.	700741	Ref. No.	3043180
description	hinge mounting pos. upper		
For models:	3G65A, 3G65A2, 3G65A4, 4G65B, 4G65B2, 4G65B4, 4G65B6, 6BR15V, 6BR15VC, 6BR19V, 6BR19VC, 6EA, 6EA11, 6EA11A, 6EA11M, 6EA13, 6EA13A, 6EA13M, 6EA2, 6EA2A, 6EA2M, 6EAA, 6EAB, 6EABA, 6EABM, 6EAM, 6EB, 6EB11, 6EB11A, 6EB11M, 6EB13, 6EB13A, 6EB13M, 6EB2, 6EB22, 6EB22A, 6EB22M, 6EB2A, 6EB2M, 6EB4, 6EB4A, 6EB4M, 6EBA, 6EBB, 6EBBA, 6EBBM, 6EBM, 6EC, 6EC11, 6EC11A...(Other models you can see in the webshop)		

			
1			
GEV No.	690787	Ref. No.	30T1980
description	hinge mounting pos. upper left		

			
1			
GEV No.	690794	Ref. No.	30T4800
description	hinge mounting pos. upper left		
For models:	120PV, 135PVX		

			
1			
GEV No.	690790	Ref. No.	30T1080
description	hinge mounting pos. upper right		

			
1			
GEV No.	700719	Ref. No.	36M2541
description	hinge mounting pos. upper right		
For models:	30CPS, 30CPSE, 30F1, 30F1B, 30FES2, 30FES2B, 30FS2, 30FS2B, 32TC, 32TCE, 32TPV, 32V, 70CP, 70CPE, 70F, 70F1, 70F1B, 70FE, 70FE1, 70FE1B, 70FES, 70FES2, 70FES2B, 71CP, 71CP2, 71F, 71F2, 71F2B, 71FE, 71FE2, 71FE2B, 72D, 72DGG, 72TP, 72TPGG, 72VA, 72VAGG, 72VAS, 72VASGG, 90CP, 90CPE, 90F110B, 91CP, 91F210, 91F210B, 91F223B		

			
1			
GEV No.	690746	Ref. No.	30T5900
description	hinge bearing mounting pos. centre with bolt		
For models:	135-4, 135CPX, 135X-3, 135X-4, 65BX-2, 65NB, 65NBX, 65NN, 65NNX, 65X-2, S125-4, S125B-4, S125BX-4, S125X-4, S60-2, S60B-2, S60BX-2, S60X-2, SP135CP, SP65NB, SP65NN		

1

GEV No.	690741	Ref. No.	30T6230
description	hinge bearing mounting pos. lower with bolt		
For models:	6BEA11Z, 6BEA2Z, 6BEA3Z, 6BEABA, 6BEABB, 6BEABM, 6BEABZ, 6BEAZ, 6BEB11Z, 6BEB22Z, 6BEB2Z, 6BEB3Z, 6BEB4Z, 6BEBBA, 6BEBBB, 6BEBBM, 6BEBBZ, 6BEBZ, 6BEC11Z, 6BEC22Z, 6BEC2Z, 6BEC33Z, 6BEC3Z, 6BEC4Z, 6BEC6Z, 6BECBA, 6BECBB, 6BECBM, 6BECBZ, 6BECZ, 6BMA11Z, 6BMA2Z, 6BMA3Z, 6BMABA, 6BMABB, 6BMABM, 6BMABZ, 6BMAZ, 6BMB11Z, 6BMB22Z, 6BMB2Z, 6BMB3Z, 6BMB4Z, 6BMBBA, 6BMBBB, 6BMBBM, 6BMBBZ, 6BMBZ, 6BMC11Z, 6BMC22Z...(Other models you can see in the webshop)		



1

GEV No.	690755	Ref. No.	30T1950
description	hinge bearing mounting pos. lower with bolt		



1

GEV No.	690749	Ref. No.	36M2740
description	hinge bearing mounting pos. lower without bolt		
For models:	K16APGPZ, K16XPZAP, SA16AGB, SA16GB		



1

GEV No.	514282	Ref. No.	36M4122
description	hinge bearing mounting pos. right/left without bolt		
For models:	FC101, FC101E, FC241, FC241E, FC241G, FC61, FC61E, FCV101, FCV101-CSA, FCV101DM, FCV101DM-CSA, FCV101DS, FCV101DS-CSA, FCV101E, FCV101EDM, FCV101EDM-UL, FCV101EDS, FCV101EDS-UL, FCV101E-UL, FCV141, FCV141-CSA, FCV141DM, FCV141DM-CSA, FCV141DS, FCV141DS-CSA, FCV141E, FCV141EDM, FCV141EDS, FCV241, FCV241DM, FCV241DS, FCV241E, FCV241EDM, FCV241EDM-UL, FCV241EDS, FCV241EDS-UL, FCV241E-UL, FCV241G, FCV241G-CSA, FCV241GDM, FCV241GDM-CSA, FCV241GDS, FCV241GDS-CSA, FCV3EM, FCV401DM, FCV401DM-CSA, FCV401EDM, FCV401EDM-UL, FCV4E, FCV4EDS...(Other models you can see in the webshop)		



1

GEV No.	690672	Ref. No.	30T5970
description	hinge bearing mounting pos. upper left with bolt		
For models:	120PV, 135PVX		



1

GEV No.	690792	Ref. No.	30T4810
description	hinge bearing mounting pos. upper left with bolt		



1

GEV No.	690671	Ref. No.	30T5800
description	hinge bearing mounting pos. upper right with bolt		
For models:	120PV, 135PVX, 55PV, 65PVX		



1

GEV No.	690748	Ref. No.	36M2730
description	hinge bearing mounting pos. upper right with bolt		
For models:	K16APGPZ, K16XPZAP, SA16AGB, SA16GB		



1

GEV No.	690740	Ref. No.	30T6220
description	hinge bearing mounting pos. upper with bolt		
For models:	6BEA11Z, 6BEA2Z, 6BEA3Z, 6BEABA, 6BEABB, 6BEABM, 6BEABZ, 6BEAZ, 6BEB11Z, 6BEB22Z, 6BEB2Z, 6BEB3Z, 6BEB4Z, 6BEBBA, 6BEBBB, 6BEBBM, 6BEBBZ, 6BEBZ, 6BEC11Z, 6BEC22Z, 6BEC2Z, 6BEC33Z, 6BEC3Z, 6BEC4Z, 6BEC6Z, 6BECBA, 6BECBB, 6BECBM, 6BECBZ, 6BECZ, 6BMA11Z, 6BMA2Z, 6BMA3Z, 6BMABA, 6BMABB, 6BMABM, 6BMABZ, 6BMAZ, 6BMB11Z, 6BMB22Z, 6BMB2Z, 6BMB3Z, 6BMB4Z, 6BMBBA, 6BMBBB, 6BMBBM, 6BMBBZ, 6BMBZ, 6BMC11Z, 6BMC22Z...(Other models you can see in the webshop)		



GEV No.	690684	Ref. No.	35V7760
description	hinge bearing mounting pos. upper without bolt		
For models:	40, 40B, 40CP, 40CPX, 40PL, 40X		



GEV No.	690688	Ref. No.	35V8800
description	hinge bearing mounting pos. upper without bolt		
For models:	40EV, 40EVP, 40PV, 40XPV		



GEV No.	690571	Ref. No.	30T5810
description	hinge bearing with bolt suitable for SAGI		
For models:	120, 120B, 120NN, 135, 135A, 135B, 135BA, 135BN, 135BNX, 135BX, 135BXE, 135BXR, 135CPX, 135NN, 135NNX, 135X, 135X-3, 135XE, 135XR, 55, 55B, 65, 65A, 65B, 65BA, 65BX, 65BXE, 65BXR, 65X, 65XE, 65XR, S125, S125B, S125BE, S125BG, S125E, S125X, S60, S60B, S60BE, S60BX, S60E, S60X, SP120, SP120B, SP120BN, SP120NN, SP135, SP135B, SP135BN...(Other models you can see in the webshop)		



GEV No.	690751	Ref. No.	30T2051
description	hinge bearing with bolt suitable for SAGI		
For models:	K16APGPZ, K16XPZAP, SA16AGB, SA16GB		



GEV No.	692862	Ref. No.	3108730
description	hinge bearing without bolt mounting pos. bottom right		
For models:	BX101E, BX101E-VERS.122013, BX101G, BX101G-VERS.122013, BX122E, BX122E-VERS.122013, BX122G, BX122G-VERS.122013, BX61E, BX61E-VERS.122013, BX61G, BX61G-VERS.122013, BX82E, BX82E-VERS.122013, BX82G, BX82G-VERS.122013, FX101E1, FX101E1R, FX101E2, FX101E2C, FX101E2C-VERS.032014, FX101E2R, FX101E2R-VERS.032014, FX101E2-VERS.032014, FX101E3, FX101E3C, FX101E3C-VERS.022014, FX101E3R, FX101E3R-VERS.022014, FX101E3-VERS.022014, FX101G1, FX101G1R, FX101G2, FX101G2C, FX101G2C-VERS.032014, FX101G2R, FX101G2R-VERS.032014, FX101G2-VERS.032014, FX101G3, FX101G3C, FX101G3C-VERS.022014, FX101G3R, FX101G3R-VERS.022014, FX101G3-VERS.022014, FX10E2CR, FX10E2CR-VERS.032014, FX10E3CR, FX10E3CR-VERS.022014, FX10G2CR, FX10G2CR-VERS.032014...(Other models you can see in the webshop)		



GEV No.	692861	Ref. No.	36E2680
description	hinge bearing without bolt mounting pos. upper right		
For models:	FC1011E, FC1011G, FC1221E, FC1221G, FC611E, FC611G, FM1011E1, FM1011E1-VERS.2006, FM1011E2, FM1011E2-VERS.2006, FM1011E3, FM1011E3-VERS.2006, FM1011G1, FM1011G1-VERS.2006, FM1011G2, FM1011G2-VERS.2006, FM1011G3, FM1011G3-VERS.2006, FM1221E1, FM1221E1-VERS.2006, FM1221E2, FM1221E2-VERS.2006, FM1221E3, FM1221E3-VERS.2006, FM1221G1, FM1221G1-VERS.2006, FM1221G2, FM1221G2-VERS.2006, FM1221G3, FM1221G3-VERS.2006, FM2011E2-VERS.2006, FM2011E3-VERS.2006, FM2011G2-VERS.2006, FM2011G3-VERS.2006, FM2021E1, FM2021E2, FM2021E2-VERS.2006, FM2021E3, FM2021E3-VERS.2006, FM2021G1, FM2021G2, FM2021G2-VERS.2006, FM2021G3, FM2021G3-VERS.2006, FM611E1, FM611E1-VERS.2006, FM611E2, FM611E2-VERS.2006, FM611E3, FM611E3-VERS.2006...(Other models you can see in the webshop)		



GEV No.	505513	Ref. No.	30T1350
description	spring assisted hinge left		
For models:	F60P, F60PR, F60T, F80P, F80PR		



GEV No.	505512	Ref. No.	30T1340
description	spring assisted hinge right		
For models:	F60P, F60PR, F60T, F80P, F80PR		

miscellaneous



GEV No.	700715	Ref. No.	30T3150
description	hinge mounting pos. left/right		
For models:	L45		



			
1			
GEV No.	698474	Ref. No.	36E2820
description	hinge block total length 50mm overall height 14mm suitable for ANGELO PO		
For models:	FC1011E, FC1011G, FC1221E, FC1221G, FC611E, FC611G, FM1011E1, FM1011E1-VERS.2006, FM1011E2, FM1011E2-VERS.2006, FM1011E3, FM1011E3-VERS.2006, FM1011G1, FM1011G1-VERS.2006, FM1011G2, FM1011G2-VERS.2006, FM1011G3, FM1011G3-VERS.2006, FM1221E1, FM1221E1-VERS.2006, FM1221E2, FM1221E2-VERS.2006, FM1221E3, FM1221E3-VERS.2006, FM1221G1, FM1221G1-VERS.2006, FM1221G2, FM1221G2-VERS.2006, FM1221G3, FM1221G3-VERS.2006, FM2011E2-VERS.2006, FM2011E3-VERS.2006, FM2011G2-VERS.2006, FM2011G3-VERS.2006, FM2021E1, FM2021E2, FM2021E2-VERS.2006, FM2021E3, FM2021E3-VERS.2006, FM2021G1, FM2021G2, FM2021G2-VERS.2006, FM2021G3, FM2021G3-VERS.2006, FM611E1, FM611E1-VERS.2006, FM611E2, FM611E2-VERS.2006, FM611E3, FM611E3-VERS.2006... (Other models you can see in the webshop)		

			
1			
GEV No.	690689	Ref. No.	35X3460
description	spacer ring		
For models:	40EV, 40EVP, 40PV, 40XPV		

			
1			
GEV No.	690691	Ref. No.	36C2440
description	spacer ring		
For models:	40EV, 40EVP, 40PV, 40XPV		

accessories

miscellaneous

			
1			
GEV No.	692864	Ref. No.	3108741
description	hinge bearing latching with bolt mounting pos. bottom right		



			
1			
GEV No.	692863	Ref. No.	36E2660
description	hinge bearing latching without bolt mounting pos. bottom right		
For models:	FC1011E, FC1011G, FC1221E, FC1221G, FC611E, FC611G, FM1011E1, FM1011E1-VERS.2006, FM1011E2, FM1011E2-VERS.2006, FM1011E3, FM1011E3-VERS.2006, FM1011G1, FM1011G1-VERS.2006, FM1011G2, FM1011G2-VERS.2006, FM1011G3, FM1011G3-VERS.2006, FM1221E1, FM1221E1-VERS.2006, FM1221E2, FM1221E2-VERS.2006, FM1221E3, FM1221E3-VERS.2006, FM1221G1, FM1221G1-VERS.2006, FM1221G2, FM1221G2-VERS.2006, FM1221G3, FM1221G3-VERS.2006, FM2011E2-VERS.2006, FM2011E3-VERS.2006, FM2011G2-VERS.2006, FM2011G3-VERS.2006, FM2021E1, FM2021E2, FM2021E2-VERS.2006, FM2021E3, FM2021E3-VERS.2006, FM2021G1, FM2021G2, FM2021G2-VERS.2006, FM2021G3, FM2021G3-VERS.2006, FM611E1, FM611E1-VERS.2006, FM611E2, FM611E2-VERS.2006, FM611E3, FM611E3-VERS.2006... (Other models you can see in the webshop)		

			
1			
GEV No.	690687	Ref. No.	36D2880
description	plain washer		
For models:	40, 40B, 40CP, 40CPX, 40PL, 40X, SA87		

pullouts



drawer slides

universal

				
1				
GEV No.	696714 ¹	Ref. No.	36M8080 36M8090	
description	drawer slide L 550mm pull-out length 610mm total length 1160mm Qty 1 pair capacity 50kg W 16mm H 60mm SS telescopic			
For models:	3G6SA, 3G6SA2, 3G6SA4, 4G6SB, 4G6SB2, 4G6SB4, 4G6SB6, 6BR15V, 6BR15VC, 6BR19V, 6BR19VC, 6EA11, 6EA11A, 6EA11M, 6EA13, 6EA13A, 6EA13M, 6EA2, 6EA2A, 6EA2M, 6EB11, 6EB11A, 6EB11M, 6EB13, 6EB13A, 6EB13M, 6EB2, 6EB22, 6EB22A, 6EB22M, 6EB2A, 6EB2M, 6EB4, 6EB4A, 6EB4M, 6EC11, 6EC11A, 6EC11M, 6EC13, 6EC13A, 6EC13M, 6EC2, 6EC22, 6EC22A, 6EC22M, 6EC2A, 6EC2M, 6EC4, 6EC4A, 6EC4M... (Other models you can see in the webshop)			
spare parts for	696714			
	GEV No.	690750	Ref. No.	—
	stop for telescopic rail L 20mm plastic H 12mm D 9mm			
	GEV No.	696333	Ref. No.	—
	stop for telescopic rail L 20mm plastic H 15mm D 8mm			

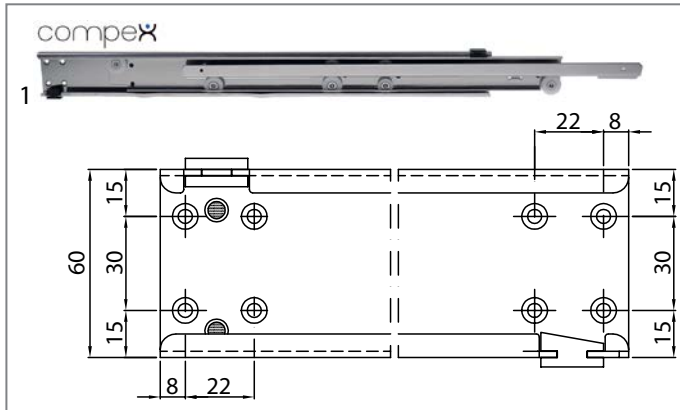

¹multiple slide (60mm more than nominal length)

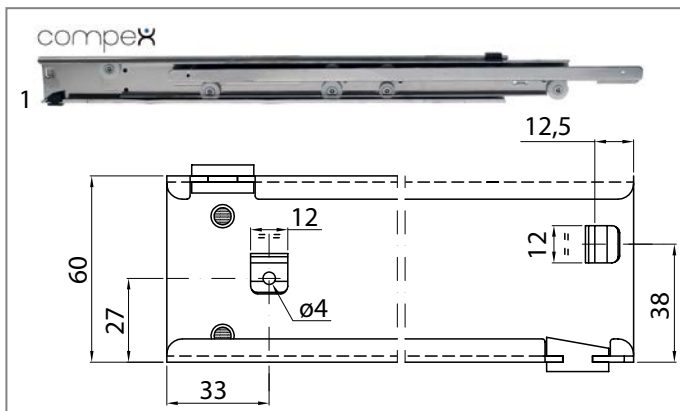

GEV No.	690752 ¹	Ref. No.	36M2700 36M2710 36M4920 36M4940
description	drawer slide L 600mm pull-out length 660mm total length 1260mm Qty 1 pair capacity 45kg H 60mm SS telescopic		
spare parts for	690752		
	GEV No.	690750	Ref. No. —
	stop for telescopic rail L 20mm plastic H 12mm D 9mm		
	GEV No.	696333	Ref. No. —
	stop for telescopic rail L 20mm plastic H 15mm D 8mm		

¹multiple slide (60mm more than nominal length)



GEV No.	690744 ¹	Ref. No.	36M5380 36M5390
description	drawer slide L 600mm pull-out length 660mm total length 1260mm Qty 1 pair capacity 45kg W 17mm H 60mm mounting pos. right/left SS telescopic		
For models:	6BEA11A, 6BEA11B, 6BEA11M, 6BEA11Z, 6BEA2A, 6BEA2B, 6BEA2M, 6BEA2Z, 6BEA3A, 6BEA3B, 6BEA3M, 6BEA3Z, 6BEB11A, 6BEB11B, 6BEB11M, 6BEB11Z, 6BEB22A, 6BEB22B, 6BEB22M, 6BEB22Z, 6BEB2A, 6BEB2B, 6BEB2M, 6BEB2Z, 6BEB3A, 6BEB3B, 6BEB3M, 6BEB3Z, 6BEB4A, 6BEB4B, 6BEB4M, 6BEB4Z, 6BEC11A, 6BEC11B, 6BEC11M, 6BEC11Z, 6BEC22A, 6BEC22B, 6BEC22M, 6BEC22Z, 6BEC2A, 6BEC2B, 6BEC2M, 6BEC2Z, 6BEC33A, 6BEC33B, 6BEC33M, 6BEC33Z, 6BEC3A, 6BEC3B...(Other models you can see in the webshop)		
spare parts for	690744		
	GEV No.	690750	Ref. No. —
	stop for telescopic rail L 20mm plastic H 12mm D 9mm		
	GEV No.	696333	Ref. No. —
	stop for telescopic rail L 20mm plastic H 15mm D 8mm		

¹multiple slide (60mm more than nominal length)

producer-specific

	GEV No.	690770	Ref. No.	30A2660 36M2660
description	drawer slide L 500mm pull-out length 400mm Qty 1 piece W 23mm mounting pos. left			

	GEV No.	690771	Ref. No.	30A2650 36M2650
description	drawer slide L 500mm pull-out length 400mm Qty 1 piece W 23mm mounting pos. right			

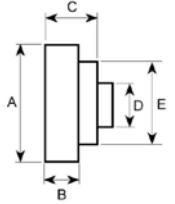

rollers

rollers

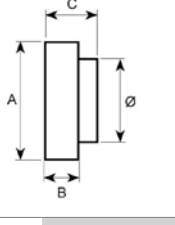
		GEV No.	690680	Ref. No.	36G2810
description	roller rollerø 24mm B1 6mm overall width 9mm A 24mm B 6mm C 9mm D 6mm E 10mm ceramic bearing ball bearing				

		GEV No.	691127	Ref. No.	36F0440
description	roller rollerø 24mm B1 6mm overall width 7.5mm A 24mm B 6mm C 7.5mm ø 10mm plastic tread plastic bore ø 6mm				





			
GEV No.	691197	Ref. No.	36G3940
description	roller rollerø 30mm overall width 10mm A 90mm B 10mm plastic		
For models:	A12A1E, A12B1E, A12B2E, A12M1E, A12Z1E, A12Z2E, A14A1E, A14B1E, A14B2E, A14M1E, A14Z1E, A14Z2E, A16A1E, A16B1E, A16B2E, A16M1E, A16Z1E, A16Z2E, A18A1E, A18B1E, A18B2E, A18M1E, A18Z1E, A18Z2E, A20A1E, A20B1E, A20B2E, A20M1E, A20Z1E, A20Z2E, ACBM, ACBM218, ACPN, ACPN218, AJ12AE, AJ12ME, AJ14AE, AJ14ME, AJ16AE, AJ16ME, AJ18AE, AJ18ME, AJ20AE, AJ20ME, ANBM, ANBM218, ART1LD, ART1LDA, ART2LD, ART2SD... (Other models you can see in the webshop)		
accessories for	691197		
			
GEV No.	691126	Ref. No.	36D4440
description	bushing H 11mm for roller		

accessories			
			
GEV No.	691126	Ref. No.	36D4440
description	bushing H 11mm for roller		
For models:	A12A1E, A12B1E, A12B2E, A12M1E, A12Z1E, A12Z2E, A14A1E, A14B1E, A14B2E, A14M1E, A14Z1E, A14Z2E, A16A1E, A16B1E, A16B2E, A16M1E, A16Z1E, A16Z2E, A18A1E, A18B1E, A18B2E, A18M1E, A18Z1E, A18Z2E, A20A1E, A20B1E, A20B2E, A20M1E, A20Z1E, A20Z2E, ACBM, ACBM218, ACPN, ACPN218, AJ12AE, AJ12ME, AJ14AE, AJ14ME, AJ16AE, AJ16ME, AJ18AE, AJ18ME, AJ20AE, AJ20ME, ANBM, ANBM218, ART1LD, ART1LDA, ART2LD, ART2SD... (Other models you can see in the webshop)		

fittings for catering equipment

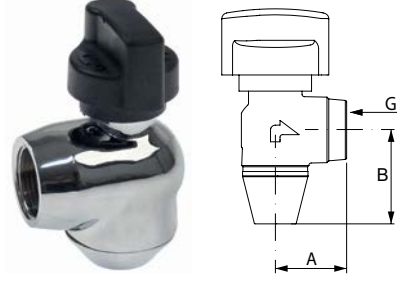
outlet taps			
universal			
			
GEV No.	540685	Ref. No.	33D0853
description	outlet tap stainless steel angled W 46mm H 40mm thread 3/4" IT		
For models:	030FE1, 030FE1B		

			
GEV No.	540699	Ref. No.	3072720
description	outlet tap W 35mm H 35mm thread 3/4" IT		
For models:	6BM, 6CP, 6FR		

producer-specific			
ANGELO PO			
			
GEV No.	540683	Ref. No.	36D4080
description	adapter thread		
For models:	030BME, 030EBM, 030FE, 031BME, 031EBM		

			
GEV No.	540730	Ref. No.	33D0170
description	ball valve connection 3/4" IT - 3/4" IT DN20 total length 70mm with lever handle length 95mm		
For models:	030BME, 030EBM, 030FE, 031BME, 031EBM, 070BM, 070BME, 071BM, 071BME, 090BM, 090BME, 091BM, 091BME, 30F, 30FES, 30FS, 70FES		





			
GEV No.	540681	Ref. No.	36D4070
description	drain pipe L 97mm thread 3/4" ET		
For models:	030BME, 030FE, 031BME		





			
GEV No.	514153	Ref. No.	3AZ0100
description	drain pipe thread		
For models:	091FR1E, 091FR1EA, 091FR1ED, 091FR1G, 091FR1GD, 091FR1I, 091FR1IA, 091FR1ID, 091FR1I-VERS.032012, 091FR7G, 091FR7G-VERS.052012, 0A1FR1E, 0A1FR1ED, 0A1FR1G, 0A1FR1GD, 0A1FR1GD-VERS.2004, 0A1FR1G-VERS.2004, 0B1FR1G, 0B1FR1GD, 0D1FR1E, 0D1FR1ED, 0D1FR1G, 0D1FR1GD, 0D1FR1GD-VERS.2004, 0D1FR1G-VERS.2004, 191FR2E, 191FR2ED, 191FR2G, 191FR2GD, 191FR2I, 191FR2ID, 191FR2I-VERS.032012, 1A1FR2E, 1A1FR2ED, 1A1FR2G, 1A1FR2GD, 1A1FR2GD-VERS.2004, 1A1FR2G-VERS.2004, 1D1FR2ED, 1D1FR2G, 1D1FR2GD, 1D1FR2GD-VERS.2004, 1D1FR2G-VERS.2004, 70F1, 70F1B, 70FE1, 70FE1B, 71F2, 71F2B, 71FE2... (Other models you can see in the webshop)		

			
GEV No.	541530	Ref. No.	3268961 3AZ0090
description	drain pipe thread		
For models:	04WFR3ED, 06WFR3GD, 08WFR4ED, 091FE28, 091FE28B, 091FR3E, 091FR3ED, 091FR3G, 091FR3GD, 0A1FR3E, 0A1FR3ED, 0A1FR3G, 0A1FR3GD, 0D1FR3E, 0D1FR3ED, 0D1FR3G, 0D1FR3GD, 0G1FR3G, 0G1FR3GD, 0G1FR7G, 10WFR4GD, 191FR4E, 191FR4ED, 191FR4G, 191FR4GD, 1A1FR4E, 1A1FR4ED, 1A1FR4G, 1A1FR4GD, 1D1FR4E, 1D1FR4ED, 1D1FR4G, 1D1FR4GD, 1G1FR4G, 1G1FR4GD, 1G1FR8G, 30F1, 30F1B, 30FES2, 30FES2B, 30FS2, 30FS2B, 90F110B, 91F210, 91F210B		

			
GEV No.	540684	Ref. No.	33Q5020
description	drain pipe thread total length 54mm shaft intake ø 22mm		
For models:	030BME, 030EBM, 030FE, 031BME, 031EBM		

			
GEV No.	540952	Ref. No.	33D2840
description	outlet tap L 84mm fryer lever handle grommet ø 30mm grommet length 29mm thread 3/4" IT handle length 81mm		
For models:	0M0BME, 0M0FR1E, 0M0FR1G, 1M0BME, 1M0CP1E, 1M0FR2E, 1M0FR2G		

			
GEV No.	540759	Ref. No.	3111510 33D1760
description	outlet tap without handle thread 1" IT		
For models:	091FR1E, 091FR1EA, 091FR1ED, 091FR1G, 091FR1GD, 091FR1I, 091FR1IA, 091FR1ID, 091FR1ID-VERS.052012, 091FR1I-VERS.032012, 091FR7G, 091FR7G-VERS.052012, 0A1FR1E, 0A1FR1ED, 0A1FR1G, 0A1FR1GD, 0A1FR1GD-VERS.2004, 0A1FR1G-VERS.2004, 0B1FR1G, 0B1FR1GD, 0D1FR1E, 0D1FR1ED, 0D1FR1G, 0D1FR1GD, 0D1FR1GD-VERS.2004, 0D1FR1G-VERS.2004, 191FR2E, 191FR2ED, 191FR2G, 191FR2GD, 191FR2I, 191FR2ID, 191FR2ID-VERS.092012, 191FR2I-VERS.032012, 1A1FR2E, 1A1FR2ED, 1A1FR2G, 1A1FR2GD, 1A1FR2GD-VERS.2004, 1A1FR2G-VERS.2004, 1D1FR2ED, 1D1FR2G, 1D1FR2GD, 1D1FR2GD-VERS.2004, 1D1FR2G-VERS.2004, 70F1, 70F1B, 70FE1, 70FE1B, 71F2...(Other models you can see in the webshop)		
spare parts for	540759		
	GEV No.	504561	Ref. No. 3151080
	O-ring EPDM thickness 2.62mm ID ø 29.82mm Qty 1 pcs		
accessories for	540759		
	GEV No.	504561	Ref. No. 3151080
	O-ring EPDM thickness 2.62mm ID ø 29.82mm Qty 1 pcs		
	GEV No.	540530	Ref. No. —
	handle plastic white L 109mm		
	GEV No.	541529	Ref. No. —
	drain pipe L 110mm thread		

			
GEV No.	540689	Ref. No.	33D1770
description	outlet tap without handle thread 3/4" IT		
For models:	04WFR3ED, 06WFR3GD, 08WFR4ED, 091FE28, 091FE28B, 091FR3E, 091FR3ED, 091FR3G, 091FR3GD, 0A1FR3E, 0A1FR3ED, 0A1FR3G, 0A1FR3GD, 0D1FR3E, 0D1FR3ED, 0D1FR3G, 0D1FR3GD, 0G1FR3G, 0G1FR3GD, 0G1FR7G, 10WFR4GD, 191FR4E, 191FR4ED, 191FR4G, 191FR4GD, 1A1FR4E, 1A1FR4ED, 1A1FR4G, 1A1FR4GD, 1D1FR4E, 1D1FR4ED, 1D1FR4G, 1D1FR4GD, 1G1FR4G, 1G1FR4GD, 1G1FR8G, 30F1, 30F1B, 30FES2, 30FES2B, 30FS2, 30FS2B, 6043840, 6043970, 70FES2, 70FES2B, 90F110B, 91F210, 91F210B		
accessories for	540689		
	GEV No.	514217	Ref. No. —
	handle for outlet tap		
	GEV No.	532487	Ref. No. 3150690
	O-ring Viton thickness 2.62mm ID ø 25.07mm Qty 1 pcs		
	GEV No.	541530	Ref. No. 3268961 3AZ0090
	drain pipe thread		

aerators and air bleeders

			
GEV No.	540827	Ref. No.	33G0170
description	aerator and air bleeder thread 3/4" ET chrome-plated L 45mm ø 36mm		
For models:	31PI6, 31PIE6, 71PI10, 71PI10A, 71PIE15, 71PIE15A, 71PV15, 71PV15A, 91PI10, 91PI10A, 91PIE15, 91PIE15A, BPV2, MCF40V, PV200, PV200A, PV300, PV300A		

			
GEV No.	540825	Ref. No.	33G0650
description	aerator and air bleeder thread 3/8" ET WS 24 chrome-plated L 37mm		
For models:	191PI1G, 191PI1GA, 191PI2E, 191PI2EA, 191PI2G, 191PI2GA, 191PI2V, 191PI2VA, 1A1PI1G, 1A1PI1GA, 1A1PI2E, 1A1PI2EA, 1A1PI2G, 1A1PI2GA, 1A1PI2V, 1A1PI2VA, 1D1PI1G, 1D1PI1GA, 1D1PI2E, 1D1PI2EA, 1D1PI2G, 1D1PI2GA, 1D1PI2V, 1D1PI2VA, 2A1PI3G, 2D1PI3G, PV200, PV200A, PV300, PV300A		



steam valves

 <p>1</p>			
GEV No.	520000	Ref. No.	33G0030 33G0031
description	steam valve angled connection 1 1/4" IT total length 52mm H 190mm brass		
For models:	191PI2V, 191PI2VA, 1A1PI2V, 1A1PI2VA, 1D1PI2V, 1D1PI2VA, 71PV15, 71PV15A, PV200, PV200A, PV300, PV300A		
spare parts for	520000		
		GEV No.	541566 Ref. No. —
	tap head for steam tap 1 1/4" shaft 9x9mm		
		GEV No.	541567 Ref. No. —
	star handle shaft 9x9mm ø 74mm L 24mm black plastic		

lid hinges

ANGELO PO

 <p>1</p>			
GEV No.	692704	Ref. No.	36C2600
description	bracket mounting pos. left mounting distance 45mm for lid		
For models:	10CP1EA, 10CP1GA, 12CP1EA, 12CP1GA, 18CP2EA, 18CP2GA, 191BR1E, 191BR1G, 191BR1GA, 191BR2E, 191BR2EA, 191BR2G, 191BR2GA, 191PD1G, 191PD2G, 191PI1G, 191PI1GA, 191PI2E, 191PI2EA, 191PI2G, 191PI2GA, 191PI2V, 191PI2VA, 1A1BR1E, 1A1BR1G, 1A1BR1GA, 1A1BR2E, 1A1BR2EA, 1A1BR2G, 1A1BR2GA, 1A1PD1G, 1A1PD2G, 1A1PI1G, 1A1PI1GA, 1A1PI2E, 1A1PI2EA, 1A1PI2G, 1A1PI2GA, 1A1PI2V, 1A1PI2VA, 1D1BR1E, 1D1BR1G, 1D1BR1GA, 1D1BR2E, 1D1BR2EA, 1D1BR2G, 1D1BR2GA, 1D1PD1G, 1D1PD2G, 1D1PI1G... (Other models you can see in the webshop)		

 <p>1</p>			
GEV No.	692705	Ref. No.	36C2590
description	bracket mounting pos. right mounting distance 45mm for lid		
For models:	10CP1EA, 10CP1GA, 12CP1EA, 12CP1GA, 18CP2EA, 18CP2GA, 191BR1E, 191BR1G, 191BR1GA, 191BR2E, 191BR2EA, 191BR2G, 191BR2GA, 191PD1G, 191PD2G, 191PI1G, 191PI1GA, 191PI2E, 191PI2EA, 191PI2G, 191PI2GA, 191PI2V, 191PI2VA, 1A1BR1E, 1A1BR1G, 1A1BR1GA, 1A1BR2E, 1A1BR2EA, 1A1BR2G, 1A1BR2GA, 1A1PD1G, 1A1PD2G, 1A1PI1G, 1A1PI1GA, 1A1PI2E, 1A1PI2EA, 1A1PI2G, 1A1PI2GA, 1A1PI2V, 1A1PI2VA, 1D1BR1E, 1D1BR1G, 1D1BR1GA, 1D1BR2E, 1D1BR2EA, 1D1BR2G, 1D1BR2GA, 1D1PD1G, 1D1PD2G, 1D1PI1G... (Other models you can see in the webshop)		

 <p>1</p>			
GEV No.	692706	Ref. No.	36H0260
description	spindle L 445mm ø 12mm for lid		
For models:	10CP1EA, 10CP1GA, 10CP1IA, 12CP1EA, 12CP1GA, 12CP1IA, 18CP2EA, 18CP2GA, 18CP2IA, 191BR1E, 191BR1G, 191BR1GA, 191BR2E, 191BR2EA, 191BR2G, 191BR2GA, 1A1BR1E, 1A1BR1G, 1A1BR1GA, 1A1BR2E, 1A1BR2EA, 1A1BR2G, 1A1BR2GA, 1D1BR1E, 1D1BR1G, 1D1BR1GA, 1D1BR2E, 1D1BR2EA, 1D1BR2G, 1D1BR2GA, 291BR1E, 291BR1G, 291BR1GA, 291BR2E, 291BR2EA, 291BR2G, 291BR2GA, 2A1BR1E, 2A1BR1G, 2A1BR1GA, 2A1BR2E, 2A1BR2EA, 2A1BR2G, 2A1BR2GA, 2D1BR1E, 2D1BR1G, 2D1BR1GA, 2D1BR2E, 2D1BR2EA, 2D1BR2G... (Other models you can see in the webshop)		

miscellaneous

spare parts



 <p>1</p>			
GEV No.	700683	Ref. No.	36G2680
description	bolt for torsion spring		
For models:	12CP1GA, 12CP1IA, 191BR1E, 191BR1G, 191BR1GA, 191BR2E, 191BR2EA, 191BR2G, 191BR2GA, 191PD1G, 191PD2G, 191PI1G, 191PI1GA, 191PI2E, 191PI2EA, 191PI2G, 191PI2GA, 191PI2V, 191PI2VA, 1A1BR1E, 1A1BR1G, 1A1BR1GA, 1A1BR2E, 1A1BR2EA, 1A1BR2G, 1A1BR2GA, 1A1PD1G, 1A1PD2G, 1A1PI1G, 1A1PI1GA, 1A1PI2E, 1A1PI2EA, 1A1PI2G, 1A1PI2GA, 1A1PI2V, 1A1PI2VA, 1D1BR1E, 1D1BR1G, 1D1BR1GA, 1D1BR2E, 1D1BR2EA, 1D1BR2G, 1D1BR2GA, 1D1PD1G, 1D1PD2G, 1D1PI1G, 1D1PI1GA, 1D1PI2E, 1D1PI2EA, 1D1PI2G... (Other models you can see in the webshop)		

drain taps





brass

drain taps



GEV No.	540131	Ref. No.	33D0080
description	drain tap 1 1/4" IT chrome-plated brass		
spare parts for	540131		
	GEV No.	540213	Ref. No. —
	handle ID ø 5mm L 117mm		
	GEV No.	540461	Ref. No. —
	shim for drain tap		
	GEV No.	540464	Ref. No. —
	nut for drain tap thread 1 1/2"		





GEV No.	540134	Ref. No.	33D2291
description	drain tap 2" IT fixed A 115mm B1 90mm B2 165mm chrome-plated brass		
For models:	191CP1GA, 191PD1G, 191PD2G, 191PI1G, 191PI1GA, 191PI2E, 191PI2EA, 191PI2G, 191PI2GA, 191PI2V, 191PI2VA, 1A1CP1GA, 1A1PD1G, 1A1PD2G, 1A1PI1G, 1A1PI1GA, 1A1PI2E, 1A1PI2EA, 1A1PI2G, 1A1PI2GA, 1A1PI2V, 1A1PI2VA, 1D1CP1GA, 1D1PD1G, 1D1PD2G, 1D1PI1G, 1D1PI1GA, 1D1PI2E, 1D1PI2EA, 1D1PI2G, 1D1PI2GA, 1D1PI2V, 1D1PI2VA, 1G1PD1G, 1G1PI1E, 1G1PI1G, 291PD3G, 291PI3E, 291PI3G, 2A1PD3G, 2A1PI3E, 2A1PI3G, 2D1PI3G, 31PD6, 31PI6, 31PIE6, 71PD10, 71PD15, 71PI10, 71PI10A...(Other models you can see in the webshop)		
spare parts for	540134		
	GEV No.	540214	Ref. No. —
	handle ID ø 6mm L 145mm		
	GEV No.	540462	Ref. No. —
	ring for drain tap		
	GEV No.	540465	Ref. No. —
	nut for drain tap thread 2 3/4"		
accessories for	540134		
	GEV No.	529484	Ref. No. —
	flat gasket fibre ED ø 58mm ID ø 50mm thickness 2mm Qty 1 pcs		



GEV No.	540275	Ref. No.	33D0600
description	drain tap 2" IT with union nut A 90mm B 151mm B1 80mm chrome-plated brass		
For models:	31PD6, 31PI6, 31PIE6, 71PD10, 71PD15, 71PI10, 71PI10A, 71PIE15, 71PIE15A, 71PV15, 71PV15A, 91PI10, 91PI10A, 91PIE15, 91PIE15A		
spare parts for	540275		
	GEV No.	540214	Ref. No. —
	handle ID ø 6mm L 145mm		
accessories for	540275		
	GEV No.	529484	Ref. No. —
	flat gasket fibre ED ø 58mm ID ø 50mm thickness 2mm Qty 1 pcs		
	GEV No.	542448	Ref. No. —
	gasket silicone 60x49x2 for drain tap 2"		



GEV No.	540267	Ref. No.	33D2290
description	drain tap connection with union nut thread 2"		
For models:	191CP1GA, 191PD1G, 191PD2G, 191PI1G, 191PI1GA, 191PI2E, 191PI2EA, 191PI2G, 191PI2GA, 191PI2V, 191PI2VA, 1A1CP1GA, 1A1PD1G, 1A1PD2G, 1A1PI1G, 1A1PI1GA, 1A1PI2E, 1A1PI2EA, 1A1PI2G, 1A1PI2GA, 1A1PI2V, 1A1PI2VA, 1D1CP1GA, 1D1PD1G, 1D1PD2G, 1D1PI1G, 1D1PI1GA, 1D1PI2E, 1D1PI2EA, 1D1PI2G, 1D1PI2GA, 1D1PI2V, 1D1PI2VA, 1G1PD1G, 1G1PI1E, 1G1PI1G, 291PD3G, 291PI3E, 291PI3G, 2A1PD3G, 2A1PI3E, 2A1PI3G, 2D1PI3G, 31PD6, 31PI6, 31PIE6, 71PD10, 71PD15, 71PI10, 71PI10A...(Other models you can see in the webshop)		
spare parts for	540267		
	GEV No.	505517	Ref. No. —
	O-ring EPDM thickness 5.34mm ID ø 53.34mm Qty 1 pcs		
	GEV No.	540214	Ref. No. —
	handle ID ø 6mm L 145mm		



accessories

1 

GEV No.	541485	Ref. No.	35Z5100
description	screw-in socket for drain tap thread 2" L 167mm		
For models:	71PD10, 71PD15, 71PI10, 71PI10A, 71PIE15, 71PIE15A, 71PV15, 71PV15A, 91PI10, 91PI10A, 91PIE15, 91PIE15A		

test taps

test taps

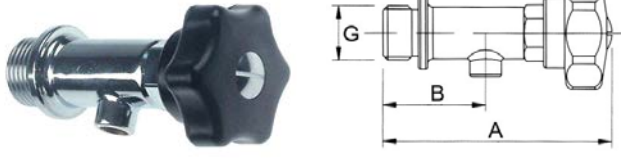
1 

GEV No.	540818	Ref. No.	3028010
description	test tap thread 1/2" ET W 88mm W1 38mm		
For models:	191PI1G, 191PI1GA, 191PI2E, 191PI2EA, 191PI2G, 191PI2GA, 1A1PI1G, 1A1PI1GA, 1A1PI2E, 1A1PI2EA, 1D1PI1G, 1D1PI1GA, 1D1PI2E, 1D1PI2EA, 1G1PI1E, 1G1PI1G, 31PI6, 31PIE6, 71PI10, 71PI10A, 71PIE15, 71PIE15A, 91PI10, 91PI10A, 91PIE15, 91PIE15A		

accessories





1 

GEV No.	515105	Ref. No.	37M0590
description	rosette		
For models:	1A1PI1G, 1A1PI1GA, 1A1PI2E, 1A1PI2EA, 1D1PI1G, 1D1PI1GA, 1D1PI2E, 1D1PI2EA, 1G1PI1E, 1G1PI1G, 31PI6, 31PIE6, 71PI10, 71PI10A, 71PIE15, 71PIE15A, 91PI10, 91PI10A, 91PIE15, 91PIE15A		

safety fittings

safety fittings

1 

GEV No.	514275	Ref. No.	3006310	
description	safety fitting thread 3/4" 0.45bar with manometer and aerator/air bleeder 3.3kg H 200mm W 150mm			
For models:	191PI1G, 191PI1GA, 191PI2E, 191PI2EA, 191PI2G, 191PI2GA, 191PI2V, 191PI2VA, 1A1PI1G, 1A1PI1GA, 1A1PI2E, 1A1PI2EA, 1A1PI2G, 1A1PI2GA, 1A1PI2V, 1A1PI2VA, 1D1PI1G, 1D1PI1GA, 1D1PI2E, 1D1PI2EA, 1D1PI2G, 1D1PI2GA, 1D1PI2V, 1D1PI2VA, 1G1PI1E, 1G1PI1G, 291PI3E, 291PI3G, 2A1PI3G, 2D1PI3G, PV200, PV200A, PV300, PV300A			
spare parts for	514275			
	GEV No.	514094	Ref. No.	—
	angle piece thread 3/8"			
	GEV No.	514276	Ref. No.	—
	safety fitting thread 3/4" 0.45bar H 165mm ø 65mm			
	GEV No.	540825	Ref. No.	33G0650
	aerator and air bleeder thread 3/8" ET WS 24 chrome-plated L 37mm			
	GEV No.	540828	Ref. No.	—
	manometer siphon thread 3/8"			
	GEV No.	541579	Ref. No.	—
	manometer ø 52mm pressure range 0 up to 1bar connection marking 0.5 thread 1/4"			

accessories

1 

GEV No.	540633	Ref. No.	33G0560
description	fitting support thread 1/2" IT		
For models:	1A1PI1G, 1A1PI1GA, 1A1PI2E, 1A1PI2EA, 1A1PI2V, 1A1PI2VA, 1D1PI1G, 1D1PI1GA, 1D1PI2E, 1D1PI2EA, 1D1PI2V, 1D1PI2VA		

1 

GEV No.	540821	Ref. No.	33G0130
description	fitting support thread 1 1/4"		
For models:	31PI6, 31PIE6, 71PI10, 71PI10A, 71PIE15, 71PIE15A, 71PV15, 71PV15A, 91PI10, 91PI10A, 91PIE15, 91PIE15A		



1

GEV No.	540830	Ref. No.	33G0160
description	pressure gauge tap IT 1/4" ET 1/4"		



1

GEV No.	541501	Ref. No.	33Q4650
description	reducer for safety fitting IT 1/4" ET 3/4"		

safety valves



1

GEV No.	540721	Ref. No.	33G0200
description	safety valve triggering pressure 0.5bar M88 thread 1/4"		
For models:	31PI6, 31PIE6, 71PI10, 71PI10A, 71PIE15, 71PIE15A, 71PV15, 71PV15A, 91PI10, 91PI10A, 91PIE15, 91PIE15A, PV200, PV200A, PV300, PV300A		
accessories for	540721		
	GEV No.	541501	Ref. No. 33Q4650
	reducer for safety fitting IT 1/4" ET 3/4"		



1

GEV No.	540722	Ref. No.	33G0150
description	safety valve with outlet for lid		
For models:	191PI1GA, 191PI2EA, 191PI2GA, 191PI2VA, 1A1PI1GA, 1A1PI2EA, 1A1PI2GA, 1A1PI2VA, 1D1PI1GA, 1D1PI2E, 1D1PI2EA, 1D1PI2GA, 1D1PI2VA, 71PI10A, 71PIE15A, 71PV15A, 91PI10A, 91PIE15A, PV200A, PV300A		

filters

air filters



1

GEV No.	750164	Ref. No.	36D5560
description	air filter L 240mm W 190mm H 5mm		
For models:	AL1433, AL1433V, AL1437, AL1437V, AL1633, AL1633V, AL2033, AL2033V, AL2533, AL2533V, PE1633, PE1633V, PE2033, PE2033V, PM1633, PM1633V, PM2033, PM2033V, PZ1633A, PZ1633B, PZ2033A, PZ2033B, PZ2533A, PZ2533B, SP120, SP120BN, SP120NN, SP135, SP135BN, SP135CP, SP135NN, SP55, SP65, SP65NN		

equipment feet and end caps

equipment feet

with screw mounting



1

GEV No.	701638	Ref. No.	3313390
description	equipment foot tube ø 63.5mm thread M10 IT H 145-230mm SS Qty 1 pcs		

components



1

GEV No.	701091	Ref. No.	6000150
description	equipment foot H 125mm WS 55 1/2" IT		



with fixing plate



1

GEV No.	701379	Ref. No.	3137690 36C5600
description	equipment foot tube ø 64mm plate size 80-100mm hole distance 60-80mm H 105-155mm SS size 2 1/2" Qty 1 pcs		
For models:	3G6SA, 3G6SA2, 3G6SA4, 4G6SB, 4G6SB2, 4G6SB4, 4G6SB6, 6SA, 6SA2, 6SA2M, 6SAM, 6SB, 6SB2, 6SB2M, 6SBM, AF1B, AF1B-OPR01, AF1N, AF1N-OPR01, AF2B, AF2B-OPR01, AF2N, AF2N-OPR01, AGL6B, B1101S, BF101L, BF101S, C12Q1M, C12Q2M, CX120, CX120B, CX120NN, CX130, CX130B, CX130NN, CX140, CX140B, CX140BN, CX140BR, CX140CP, CX140NN, CX140PV, CX140R, CX150, CX150B, CX150BN, CX150BR, CX150CP, CX150NN, CX150PV...(Other models you can see in the webshop)		



2

GEV No.	700709	Ref. No.	36C5550
description	equipment foot tube ø 64mm plate size 80x100mm hole distance 60x80mm H 115-170mm SS size 2 2/3" Qty 1 pcs		
For models:	3G6SA, 3G6SA2, 3G6SA4, 4G6SB, 4G6SB2, 4G6SB4, 4G6SB6, 6MRA, 6MRA2, 6MRA2A, 6MRA2M, 6MRA2Z, 6MRA4, 6MRA4A, 6MRA4M, 6MRA4Z, 6MRAA, 6MRAM, 6MRAZ, 6MRB, 6MRB11, 6MRB11A, 6MRB11M, 6MRB11Z, 6MRB2, 6MRB2A, 6MRB2M, 6MRB2Z, 6MRB4, 6MRB4A, 6MRB4M, 6MRB4Z, 6MRB6, 6MRB6A, 6MRB6M, 6MRB6Z, 6MRBA, 6MRBM, 6MRBZ, 6MRC, 6MRC11, 6MRC11A, 6MRC11M, 6MRC11Z, 6MRC2, 6MRC2A, 6MRC2M, 6MRC2Z, 6MRC4, 6MRC4A...(Other models you can see in the webshop)		



1

GEV No.	701378	Ref. No.	3145280 36C4540
description	equipment foot tube ø 64mm plate size 80x100mm hole distance 60x80mm H 150-200mm SS size 2 1/2" Qty 1 pcs		
For models:	6BR15V, 6BR15VC, 6BR19V, 6BR19VC, 6EA, 6EA11, 6EA11A, 6EA11M, 6EA13, 6EA13A, 6EA13M, 6EA2, 6EA2A, 6EA2M, 6EAA, 6EAB, 6EABA, 6EABM, 6EAM, 6EB, 6EB11, 6EB11A, 6EB11M, 6EB13, 6EB13A, 6EB13M, 6EB2, 6EB22, 6EB22A, 6EB22M, 6EB2A, 6EB2M, 6EB4, 6EB4A, 6EB4M, 6EBA, 6EBB, 6EBBA, 6EBBM, 6EBM, 6EC, 6EC11, 6EC11A, 6EC11M, 6EC13, 6EC13A, 6EC13M, 6EC2, 6EC22, 6EC22A...(Other models you can see in the webshop)		



1

GEV No.	700708	Ref. No.	36C4540 36C4540 old
description	equipment foot tube ø 64mm plate size 90x90mm hole distance 70x70mm H 140-195mm SS size 2 1/2" Qty 1 pcs		

components



1

GEV No.	701091	Ref. No.	6000150
description	equipment foot H 125mm WS 55 1 1/2" IT		



1

GEV No.	701090	Ref. No.	36D4000
description	equipment foot tube ø 51mm plate size 80x100mm hole distance 145mm plastic size 2" ET Qty 1 pcs		
For models:	30CPS, 30CPSE, 30F, 30F1, 30F1B, 30FES, 30FES2, 30FES2B, 30FS, 30FS2, 30FS2B, 31, 31GE, 31PD6, 31PI6, 31PIE6, 31R, 31RE, 31TC, 31TCE, 31TP, 32, 32TC, 32TCE, 32TP, 32TPV, 32V, 40, 40B, 40CP, 40CPX, 40EV, 40EVP, 40PV, 40X, 40XPV		

miscellaneous



1

GEV No.	691162	Ref. No.	36D0160
description	equipment foot H 25mm WS 46 plastic		



1

GEV No.	691161	Ref. No.	36D0150
description	equipment foot H 41mm WS 56 bottom part plastic		
spare parts for	691161		
	GEV No.	694485	Ref. No. —
	sign for walk-in cold room catch Exit ø 78mm		

screw-in feet



1

GEV No.	695601	Ref. No.	3095690
description	equipment foot thread M17 thread L 23mm ø 24mm H 11mm plastic WS 24 Qty 1 pcs		



1

GEV No.	697815	Ref. No.	36D4430
description	equipment foot thread M8 thread L 10mm ø 48mm H 47mm rubber Qty 1 pcs		



1

GEV No.	697770	Ref. No.	36D5690
description	equipment foot thread M8 thread L 12mm ø 47mm H 35mm Qty 1 pcs		
For models:	FCV3EM, FCV4E, FCV4EDS, FCV4EM, FM423E1, FM423E2, FMS, FMSX		



1

GEV No.	691122	Ref. No.	36E0010
description	equipment foot thread M8 thread L 24mm ø 38mm H 13mm Qty 1 pcs		
For models:	6CP, 6FA, 6FA1, 6FR, 6FTL, 6FTR, 6PC, 6VTIM, 6VTIMM, 6VTIW, 6VTIWM, 6VTR, 6VTR2, F60P, F60PR, F60T, L45		

baskets

fryer baskets

ANGELO PO



1

GEV No.	970547	Ref. No.	3007210 3007220
description	fryer basket L1 280mm W1 225mm H1 115mm		
For models:	04WFR3ED, 06WFR3GD, 08WFR4ED, 091FR3E, 091FR3ED, 091FR3G, 091FR3GD, 0A1FR3E, 0A1FR3ED, 0A1FR3G, 0A1FR3GD, 0D1FR3E, 0D1FR3ED, 0D1FR3G, 0D1FR3GD, 0G0FR3E, 0G0FR3ED, 0G1FR3G, 0G1FR3GD, 0G1FR7G, 10WFR4GD, 191FR4E, 191FR4ED, 191FR4G, 191FR4GD, 1A1FR4E, 1A1FR4ED, 1A1FR4G, 1A1FR4GD, 1D1FR4E, 1D1FR4ED, 1D1FR4G, 1D1FR4GD, 1G0FR4E, 1G1FR4G, 1G1FR4GD, 1G1FR8G, 6043840, 6043970		



1

GEV No.	970175	Ref. No.	36A2640
description	fryer basket L1 288mm W1 190mm H1 115mm L2 570mm H2 135mm H3 185mm chrome-plated steel		
For models:	030FE, 30F, 30FES, 30FS, 70FES		



1

GEV No.	970338	Ref. No.	36A3481
description	fryer basket L1 290mm W1 190mm H1 115mm L2 520mm H2 210mm H3 260mm chrome-plated steel plastic/rubber with holder		
For models:	030FE1, 030FE1B, 091FE28, 091FE28B, 30F1, 30F1B, 30FES2, 30FES2B, 30FS2, 30FS2B, 70FES2, 70FES2B, 90F110B, 91F210, 91F210B		



1

GEV No.	970551	Ref. No.	36A5350
description	fryer basket L1 305mm W1 225mm H1 115mm		



			
1			
GEV No.	970172	Ref. No.	36A1300
description	fryer basket L1 315mm W1 210mm H1 120mm L2 495mm H2 170mm chrome-plated steel		

			
1			
GEV No.	970174	Ref. No.	36A2020
description	fryer basket L1 368mm W1 150mm H1 120mm L2 700mm H2 140mm H3 200mm chrome-plated steel		
For models:	70F, 70FE, 71F, 71FE		

			
1			
GEV No.	970339	Ref. No.	36A3491
description	fryer basket L1 368mm W1 150mm H1 120mm L2 700mm H2 210mm H3 250mm chrome-plated steel		
For models:	70F1, 70F1B, 70FE1, 70FE1B, 71F2, 71F2B, 71FE2, 71FE2B, 91F223B		

			
1			
GEV No.	970340	Ref. No.	36A2340
description	fryer basket L1 370mm W1 150mm H1 120mm chrome-plated steel		
For models:	091FR1E, 091FR1ED, 091FR1G, 091FR1GD, 091FR1I, 091FR1ID, 091FR1ID-VERS.052012, 091FR1I-VERS.032012, 0A1FR1E, 0A1FR1ED, 0A1FR1G, 0A1FR1GD, 0A1FR1GD-VERS.2004, 0A1FR1G-VERS.2004, 0B1FR1G, 0B1FR1GD, 0D1FR1E, 0D1FR1ED, 0D1FR1G, 0D1FR1GD, 0D1FR1GD-VERS.2004, 0D1FR1G-VERS.2004, 191FR2E, 191FR2ED, 191FR2G, 191FR2GD, 191FR2I, 191FR2ID, 191FR2ID-VERS.092012, 191FR2I-VERS.032012, 1A1FR2E, 1A1FR2ED, 1A1FR2G, 1A1FR2GD, 1A1FR2GD-VERS.2004, 1A1FR2G-VERS.2004, 1D1FR2ED, 1D1FR2G, 1D1FR2GD, 1D1FR2GD-VERS.2004, 1D1FR2G-VERS.2004		

			
1			
GEV No.	970173	Ref. No.	36A0901
description	fryer basket L1 400mm W1 230mm H1 130mm L2 185mm H2 165mm H3 180mm		

			
1			
GEV No.	970775	Ref. No.	55AL942 C3830AD
description	fryer basket W1 300mm L1 365mm H1 120mm		

pasta baskets

ANGELO PO

ANGELO PO

			
1			
GEV No.	970952	Ref. No.	55AG018 C3023
description	pasta basket H1 200mm W1 230mm L1 306mm L2 480mm H2 250mm H3 310mm SS holder length 165mm		

			
1			
GEV No.	970678	Ref. No.	C4627
description	pasta basket H1 200mm W1 270mm L1 460mm		

			
1			
GEV No.	970563	Ref. No.	3012120 C1011
description	pasta basket L1 110mm W1 100mm H1 150mm size GN 1/8 stainless steel		



1

GEV No.	970565	Ref. No.	3012140
description	pasta basket L1 280mm W1 300mm H1 150mm size GN 3/4 stainless steel		



1

GEV No.	970777	Ref. No.	55AG028 KCP40G
description	pasta basket set 4 pieces L1 265mm H1 200mm W1 115mm		



1

GEV No.	970337	Ref. No.	36A2582
description	pasta basket L1 295mm W1 100mm H1 150mm size GN 2/8 L2 470mm H2 230mm H3 310mm stainless steel		
For models:	30CPS, 30CPSE, 70CP, 70CPE, 71CP, 71CP2, 90CP, 90CPE, 91CP		

accessories



1

GEV No.	692119	Ref. No.	36A4631
description	chargrill grid L 500mm W 296mm H 83mm for pasta cooker		
For models:	06WCP1GM, 08WCP1GM, 091CP1G, 0A1CP1G, 0B1CP1G, 0D1CP1G, 191CP2G, 1A1CP2G, 1D1CP2G, 1G1CP1G, 1G1CP1G-VERS.2004		



1

GEV No.	970564	Ref. No.	3012130 51AL961 C2028
description	pasta basket L1 295mm W1 180mm H1 150mm size GN 1/2 stainless steel		

crumb screens



1

GEV No.	970553	Ref. No.	36A2591
description	crumb screen L 340mm W 330mm H handle 185mm stainless steel suitable for pasta cooker		
For models:	70CP, 71CP2, 90CP		



1

GEV No.	970548	Ref. No.	3240680 C0930
description	pasta basket L1 305mm W1 95mm H1 205mm size GN 2/8 H3 320mm stainless steel		



1

GEV No.	970554	Ref. No.	36A2270
description	crumb screen L 500mm W 295mm H 135mm		
For models:	0A1CP1E, 0A1CP1G, 0D1CP1E, 0D1CP1G, 1A1CP2G, 1D1CP2G		





Image not available

1

GEV No.	970573	Ref. No.	36A2301
description	crumb screen L 650mm W 340mm H handle 175mm stainless steel suitable for pasta cooker		
For models:	71CP, 91CP		



1

GEV No.	970560	Ref. No.	3006800
description	crumb screen L 335mm W 235mm suitable for fryer		
For models:	091FR3E, 091FR3ED, 0A1FR3E, 0A1FR3ED, 0D1FR3E, 0D1FR3ED, 0G0FR3E, 0G0FR3ED, 0G0FR5G, 191FR4E, 191FR4ED, 1A1FR4E, 1A1FR4ED, 1D1FR4E, 1D1FR4ED, 1G0FR4E, 1G0FR6G, 6043840, 6043970, 6FR		



1

GEV No.	970552	Ref. No.	36A2320
description	crumb screen L 430mm W 310mm H 190mm suitable for fryer		
For models:	091FR1E, 091FR1ED, 091FR1G, 091FR1GD, 091FR1I, 091FR1ID, 091FR1ID-VERS.052012, 091FR1I-VERS.032012, 0A1FR1E, 0A1FR1ED, 0A1FR1G, 0A1FR1GD, 0A1FR1GD-VERS.2004, 0A1FR1G-VERS.2004, 0B1FR1G, 0B1FR1GD, 0D1FR1E, 0D1FR1ED, 0D1FR1G, 0D1FR1GD, 0D1FR1GD-VERS.2004, 0D1FR1G-VERS.2004, 191FR2E, 191FR2ED, 191FR2G, 191FR2GD, 191FR2I, 191FR2ID, 191FR2ID-VERS.092012, 191FR2I-VERS.032012, 1A1FR2E, 1A1FR2ED, 1A1FR2G, 1A1FR2GD, 1A1FR2GD-VERS.2004, 1A1FR2G-VERS.2004, 1D1FR2ED, 1D1FR2G, 1D1FR2GD, 1D1FR2GD-VERS.2004, 1D1FR2G-VERS.2004		



1

GEV No.	970949	Ref. No.	36A4641 36A4642
description	crumb screen L 500mm W 295mm H 105mm stainless steel for pasta cooker		
For models:	04WCP1EM, 091CP1E, 6040090, 6040310, 6043850, 6043980		



1

GEV No.	970951	Ref. No.	36A5260
description	grate L 340mm W 240mm H 100mm for pasta cooker		
For models:	0G1CP1E, 0G1CP1EC, 0G1CP1E-VERS.2004, 0G1CP1G, 0G1CP1G-VERS.2004, 1G1CP2G, 1G1CP2G-VERS.2004		



1

GEV No.	970849	Ref. No.	3007230
description	crumb screen L 335mm W 235mm H 148mm fryer		
For models:	091FR3G, 091FR3GD, 0A1FR3G, 0A1FR3GD, 0D1FR3G, 0D1FR3GD, 0G1FR3G, 0G1FR3GD, 0G1FR7G, 191FR4G, 191FR4GD, 1A1FR4G, 1A1FR4GD, 1D1FR4G, 1D1FR4GD, 1G1FR4G, 1G1FR4GD, 1G1FR8G		

warewashing baskets

steel wire baskets round

mix baskets



1

GEV No.	970323	Ref. No.	3053810
description	mix basket ED ø 370mm H 145mm seat ø 325mm		

plastic baskets round



1

GEV No.	970699	Ref. No.	3053810
description	mix basket ED ø 380mm H 170mm seat ø 325mm plastic		

shelves and shelf rails

chargrill grids

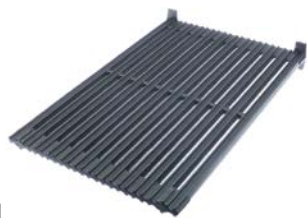

1

GEV No.	210042	Ref. No.	3000930 3000931
description	chargrill grid L 470mm W 300mm H 55mm cast iron suitable for ANGELO PO chargrill		
For models:	1G0GRG		

grates

universal

without upstand



1

GEV No.	970120	Ref. No.	36M3540 G610
description	grate W 325mm D 530mm GN 1/1 chrome-plated steel wire gauge frame 7mm lengthwise wires gauge 4mm crossing wires 1		
For models:	31GE, 31TC, 31TCE, 32TC, 32TCE		
accessories for	970120		
	GEV No.	690330	Ref. No. —
	rack L 1000mm W 22mm H 4mm aperture 3x8mm hole distance 12.5mm stainless steel		
	GEV No.	694700	Ref. No. —
	shelf support L 31/28mm W 22mm H 18mm SS Qty 12 pcs		
	GEV No.	694701	Ref. No. —
	shelf support L 31/28mm W 22mm H 17mm SS with hook Qty 12 pcs		



1

GEV No.	970122	Ref. No.	G610X
description	grate W 325mm D 530mm GN 1/1 H 8mm stainless steel wire gauge frame 7mm lengthwise wires gauge 4mm crossing wires 1		
accessories for	970122		
	GEV No.	690330	Ref. No. —
	rack L 1000mm W 22mm H 4mm aperture 3x8mm hole distance 12.5mm stainless steel		
	GEV No.	694700	Ref. No. —
	shelf support L 31/28mm W 22mm H 18mm SS Qty 12 pcs		
	GEV No.	694701	Ref. No. —
	shelf support L 31/28mm W 22mm H 17mm SS with hook Qty 12 pcs		





1

GEV No.	970125	Ref. No.	32A2430 36A2430
description	grate W 325mm D 530mm GN 1/1 plastic-coated steel crossing wires 1 white suitable for refrigerator		
For models:	BRPR218, BRPR21C, BRVR218, BRVR21C, K16APGPZ, K16XPZAP, SA16AGB, SA16GB, SL21RPR, SL21RVR		
accessories for	970125		
	GEV No.	690330	Ref. No. —
	rack L 1000mm W 22mm H 4mm aperture 3x8mm hole distance 12.5mm stainless steel		
	GEV No.	694700	Ref. No. —
	shelf support L 31/28mm W 22mm H 18mm SS Qty 12 pcs		
	GEV No.	694701	Ref. No. —
	shelf support L 31/28mm W 22mm H 17mm SS with hook Qty 12 pcs		





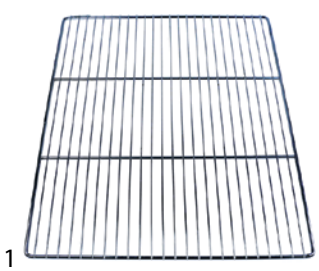

1

GEV No.	970132	Ref. No.	36A0131
description	grate W 400mm D 600mm plastic-coated steel crossing wires 1 white suitable for refrigerator		
For models:	40, 40-OPR01, 40CP, 40CP-OPR01, 40CPX, 40CPX-OPR01, 40PV, 40PV-OPR01, 40X, 40X-OPR01, 40XPV		
accessories for	970132		
	GEV No.	Ref. No.	—
	rack L 1000mm W 22mm H 4mm aperture 3x8mm hole distance 12.5mm stainless steel		
	GEV No.	Ref. No.	—
	shelf support L 31/28mm W 22mm H 18mm SS Qty 12 pcs		
	GEV No.	Ref. No.	—
	shelf support L 31/28mm W 22mm H 17mm SS with hook Qty 12 pcs		



1

GEV No.	970123	Ref. No.	G241X
description	grate W 650mm D 530mm GN 2/1 stainless steel wire gauge frame 7.8mm lengthwise wires gauge 3.8mm crossing wires 2 suitable for refrigerator		
accessories for	970123		
	GEV No.	Ref. No.	—
	rack L 1000mm W 22mm H 4mm aperture 3x8mm hole distance 12.5mm stainless steel		
	GEV No.	Ref. No.	—
	shelf support L 31/28mm W 22mm H 18mm SS Qty 12 pcs		
	GEV No.	Ref. No.	—
	shelf support L 31/28mm W 22mm H 17mm SS with hook Qty 12 pcs		

with upstand







1

GEV No.	970558	Ref. No.	3012000
description	grate W 325mm D 530mm GN 1/1 chrome-plated iron		
For models:	1G1FA0EV, 1G1FA0GV, 1G1PE1EV, 1G1PE2EV, 2G1FA0GV, 2G1PE1EV, 2G1PE2EV, 31GE, 31TC, 31TCE, 32TC, 32TCE		



1

GEV No.	970527	Ref. No.	36A0990 G241
description	grate W 530mm D 650mm GN 2/1 chrome-plated steel with hinge camp crossing wires 2 suitable for refrigerator		
accessories for	970527		
	GEV No.	Ref. No.	—
	rack L 1000mm W 22mm H 4mm aperture 3x8mm hole distance 12.5mm stainless steel		
	GEV No.	Ref. No.	—
	shelf support L 31/28mm W 22mm H 18mm SS Qty 12 pcs		
	GEV No.	Ref. No.	—
	shelf support L 31/28mm W 22mm H 17mm SS with hook Qty 12 pcs		



1

GEV No.	970555	Ref. No.	36A0990
description	grate W 530mm D 650mm GN 2/1 chrome-plated steel with hinge camp for fridge		
For models:	191FAAE, 191FAAG, 191FABG, 191FADG, 191FAE, 191FAG, 191PE4E, 191TPG, 1A1FA1G, 1A1FA2G, 1A1FA4G, 1A1FA5G, 1A1FAAG, 1A1FABG, 1A1FAS2G, 1A1FASG, 1A1PE4E, 1A1PEFTE, 1A1TP0G, 1A1TP0G-VERS.2002, 1A1FBE, 1D1FA1G, 1D1FA2G, 1D1FA4G, 1D1FA5G, 1D1FAAG, 1D1FABG, 1D1FAS2G, 1D1FASG, 1D1PE4E, 1D1TP0G, 1D1TP0G-VERS.2002, 1D1FBE, 1G1FA0E, 1G1FA0G, 1G1FABG, 1G1FAPG, 1G1PE1E, 1G1PE2E, 1G1TP0G, 291FAG, 291TPCG, 2A1FA1G, 2A1FA4G, 2A1FAAG, 2A1FAS2G, 2A1FASG, 2A1TP3G, 2A1TP6G, 2A1TPCG... (Other models you can see in the webshop)		

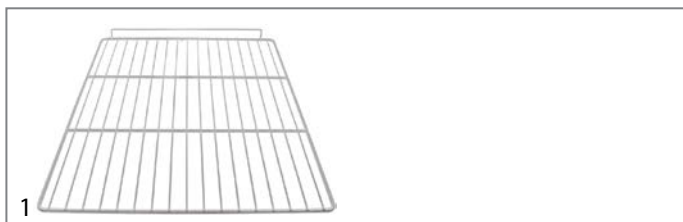

GEV No.	970556	Ref. No.	36A0710 36A1040 36A3630 RGP/2-1
description	grate W 530mm D 650mm GN 2/1 plastic-coated steel with hinge camp wire gauge frame 9mm lengthwise wires gauge 5mm crossing wires 2 white suitable for refrigerator		
For models:	135, 135-4, 135A, 135B, 135BA, 135BN, 135BNX, 135BX, 135BXE, 135BXR, 135CPX, 135NN, 135NNX, 135PVX, 135X, 135X-3, 135X-4, 135XE, 135XR, 65, 65A, 65B, 65BA, 65BX, 65BX-2, 65BXE, 65BXR, 65NB, 65NBX, 65NN, 65NNX, 65PVX, 65X, 65X-2, 65XE, 65XR, CX140, CX140B, CX140BN, CX140BR, CX140CP, CX140NN, CX140PV, CX140R, CX150, CX150B, CX150BN, CX150BR, CX150CP, CX150NN...(Other models you can see in the webshop)		
accessories for	970556		
	GEV No.	690330	Ref. No. —
	rack L 1000mm W 22mm H 4mm aperture 3x8mm hole distance 12.5mm stainless steel		
	GEV No.	690332	Ref. No. —
	shelf support L 31/28mm W 22mm H 17mm SS with hook Qty 1 pcs		
	GEV No.	694700	Ref. No. —
	shelf support L 31/28mm W 22mm H 18mm SS Qty 12 pcs		
	GEV No.	694701	Ref. No. —
	shelf support L 31/28mm W 22mm H 17mm SS with hook Qty 12 pcs		

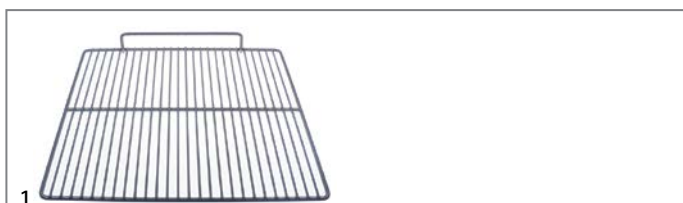

GEV No.	970643	Ref. No.	36A3010
description	grate W 555mm D 510mm H 60mm plastic-coated steel with hinge camp crossing wires 1		
For models:	120, 120B, 120NN, 120PV, 55, 55B, 55PV, SP120, SP120B, SP120BN, SP120NN, SP55, SP55B		
accessories for	970643		
	GEV No.	690330	Ref. No. —
	rack L 1000mm W 22mm H 4mm aperture 3x8mm hole distance 12.5mm stainless steel		
	GEV No.	694700	Ref. No. —
	shelf support L 31/28mm W 22mm H 18mm SS Qty 12 pcs		
	GEV No.	694701	Ref. No. —
	shelf support L 31/28mm W 22mm H 17mm SS with hook Qty 12 pcs		



GEV No.	970557	Ref. No.	36A3020
description	grate W 555mm D 670mm plastic-coated steel with hinge camp crossing wires 2 suitable for refrigerator		
accessories for	970557		
	GEV No.	690330	Ref. No. —
	rack L 1000mm W 22mm H 4mm aperture 3x8mm hole distance 12.5mm stainless steel		
	GEV No.	694700	Ref. No. —
	shelf support L 31/28mm W 22mm H 18mm SS Qty 12 pcs		
	GEV No.	694701	Ref. No. —
	shelf support L 31/28mm W 22mm H 17mm SS with hook Qty 12 pcs		

grates



GEV No.	210248	Ref. No.	36C4230
description	chimney grate		
For models:	08WFA4E, 08WFA4G, 12WFA6E, 12WFA6G, 12WFAAN, 1B0FAS, 1B0FAS2, 1B1FAS2G, 1B1FASG, 6043590		

grid attachments



GEV No.	695572	Ref. No.	36M7340
description	rack support		
For models:	6MRA, 6MRA2, 6MRA2A, 6MRA2M, 6MRA2Z, 6MRA4, 6MRA4A, 6MRA4M, 6MRA4Z, 6MRAA, 6MRAAM, 6MRAZ, 6MRB, 6MRB11, 6MRB11A, 6MRB11M, 6MRB11Z, 6MRB2, 6MRB2A, 6MRB2M, 6MRB2Z, 6MRB4, 6MRB4A, 6MRB4M, 6MRB4Z, 6MRB6, 6MRB6A, 6MRB6M, 6MRB6Z, 6MRBA, 6MRBM, 6MRBZ, 6MRC, 6MRC11, 6MRC11A, 6MRC11M, 6MRC11Z, 6MRC2, 6MRC2A, 6MRC2M, 6MRC2Z, 6MRC4, 6MRC4A, 6MRC4M, 6MRC4Z, 6MRC6, 6MRC6A, 6MRC6M, 6MRC6Z, 6MRC... (Other models you can see in the webshop)		



1

GEV No.	695577	Ref. No.	36G8640
description	rack support L 20mm H 15.5mm W 11mm plastic		
For models:	6JA, 6JA2, 6JA2A, 6JA2M, 6JAA, 6JAM, 6JB, 6JB2, 6JB2A, 6JB2M, 6JB4A, 6JB4M, 6JBA, 6JBM, 6MRA, 6MRA2, 6MRA2A, 6MRA2M, 6MRA2Z, 6MRA4, 6MRA4A, 6MRA4M, 6MRA4Z, 6MRAA, 6MRAM, 6MRAZ, 6MRB, 6MRB11, 6MRB11A, 6MRB11M, 6MRB11Z, 6MRB2, 6MRB2A, 6MRB2M, 6MRB2Z, 6MRB4, 6MRB4A, 6MRB4M, 6MRB4Z, 6MRB6, 6MRB6A, 6MRB6M, 6MRB6Z, 6MRBA, 6MRBM, 6MRBZ, 6MRC, 6MRC11, 6MRC11A, 6MRC11M...(Other models you can see in the webshop)		



1

GEV No.	691925	Ref. No.	35V6610
description	guide U-shape L 430mm W 13mm mounting pos. right inner height 21mm		
For models:	40CP, 40CPX		

shelf rails and supports

producer-specific



1

GEV No.	701465	Ref. No.	3069950
description	guide L-shape L 600mm W 20mm H 30mm mounting pos. left		
For models:	BP53G, BP53V, BP53X, BP64G, BP64V, BP64X, BP83A, BP83G, BP83M, BP83V, BP83X, BP94G, BP94V, BP94X, BPZ16, BPZ163A, BPZ163B, BPZ163S, BPZ167A, BPZ167B, BPZ167S, BPZ20, BPZ203A, BPZ203B, BPZ203S, BPZ207A, BPZ207B, BPZ207S, BPZ25, BPZ253A, BPZ253B, BPZ257A, BPZ257B, BS11, BS11A, BS11M, BS16, BS16A, BS16M, BS21, BS21A, BS21M, BSR11, BSR11A, BSR11M, BSR16, BSR16A, BSR16M, BSR21, BSR21A...(Other models you can see in the webshop)		

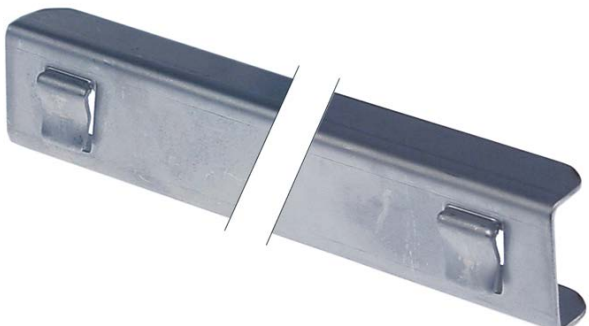

1

GEV No.	970888	Ref. No.	35R9140
description	guide U-shape L 638mm W 13mm H 20mm mounting pos. right/left		
For models:	CX140, CX140B, CX140BN, CX140BR, CX140CP, CX140NN, CX140PV, CX140R, CX150, CX150B, CX150BN, CX150BR, CX150CP, CX150NN, CX150PV, CX150R, CX65, CX652, CX65B, CX65BR, CX65NB, CX65NCP, CX65NN, CX65PV, CX65R, CX70, CX702, CX70B, CX70BR, CX70NB, CX70NN, CX70PV, CX70R, FX150, FX150B, FX150NN, FX70, FX70B, ISFEB, ISFEN, MD150, MD1504, MD150B, MD150B4, MD150BB, MD150BN, MD150BPV, MD150BR, MD150NCP, MD150NN...(Other models you can see in the webshop)		



1

GEV No.	701466	Ref. No.	3069940
description	guide L-shape L 600mm W 20mm H 30mm mounting pos. right		
For models:	BP53G, BP53V, BP53X, BP64G, BP64V, BP64X, BP83A, BP83G, BP83M, BP83V, BP83X, BP94G, BP94V, BP94X, BPZ16, BPZ163A, BPZ163B, BPZ163S, BPZ167A, BPZ167B, BPZ167S, BPZ20, BPZ203A, BPZ203B, BPZ203S, BPZ207A, BPZ207B, BPZ207S, BPZ25, BPZ253A, BPZ253B, BPZ257A, BPZ257B, BS11, BS11A, BS11M, BS16, BS16A, BS16M, BS21, BS21A, BS21M, BSR11, BSR11A, BSR11M, BSR16, BSR16A, BSR16M, BSR21, BSR21A...(Other models you can see in the webshop)		



1

GEV No.	690657	Ref. No.	36D9470
description	rack L 650mm W 34mm H 57mm mounting pos. vertical		
For models:	120PV, 135, 135-4, 135A, 135B, 135BA, 135BN, 135BNX, 135BX, 135BXE, 135BXR, 135CPX, 135NN, 135NNX, 135X, 135X-3, 135X-4, 135XE, 135XR, 55PV, 65, 65A, 65B, 65BA, 65BX, 65BX-2, 65BXE, 65BXR, 65PVX, 65X, 65X-2, 65XE, 65XR		



1

GEV No.	691841	Ref. No.	35V6620
description	guide U-shape L 430mm W 13mm mounting pos. left inner height 21mm		
For models:	40CP, 40CPX		

gaskets

refrigeration gaskets

plug-in gaskets

profile 9048

We offer custom-made gaskets for this profile

mechanical components, equipment accessories

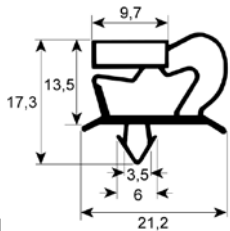

GEV No.	900863	Ref. No.	37Q4730
description	refrigeration gasket profile 9048 W 138mm L 373mm plug size		
For models:	6BMA11A, 6BMA11M, 6BMA11Z, 6BMA3A, 6BMA3M, 6BMA3Z, 6MB11A, 6MB11M, 6MB11Z, 6BMB22A, 6BMB22M, 6BMB22Z, 6BMB3A, 6BMB3M, 6BMB3Z, 6BMC11A, 6BMC11M, 6BMC11Z, 6BMC22A, 6BMC22M, 6BMC22Z, 6BMC33A, 6BMC33M, 6BMC33Z, 6BMC3A, 6BMC3M, 6BMC3Z, 6EA11, 6EA11A, 6EA11M, 6EA13, 6EA13A, 6EA13M, 6EB11, 6EB11A, 6EB11M, 6EB13, 6EB13A, 6EB13M, 6EB22, 6EB22A, 6EB22M, 6EC11, 6EC11A, 6EC11M, 6EC13, 6EC13A, 6EC13M, 6EC22, 6EC22A... (Other models you can see in the webshop)		

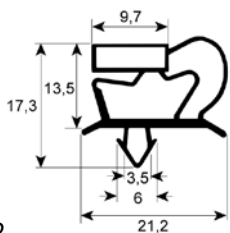

GEV No.	900862	Ref. No.	37Q4720
description	refrigeration gasket profile 9048 W 246mm L 373mm plug size		
For models:	6BMA2A, 6BMA2M, 6BMA2Z, 6BMB2A, 6BMB2M, 6BMB2Z, 6BMB4A, 6BMB4M, 6BMB4Z, 6BMC2A, 6BMC2M, 6BMC2Z, 6BMC4A, 6BMC4M, 6BMC4Z, 6BMC6A, 6BMC6M, 6BMC6Z, 6EA2, 6EA2A, 6EA2M, 6EB2, 6EB2A, 6EB2M, 6EB4, 6EB4A, 6EB4M, 6EC2, 6EC2A, 6EC2M, 6EC4, 6EC4A, 6EC4M, 6ERA2, 6ERA2A, 6ERA2M, 6ERB2, 6ERB2A, 6ERB2M, 6ERB4, 6ERB4A, 6ERB4M, 6ERC2, 6ERC2A, 6ERC2M, 6MA2, 6MA2A, 6MA2M, 6MB2, 6MB2A... (Other models you can see in the webshop)		

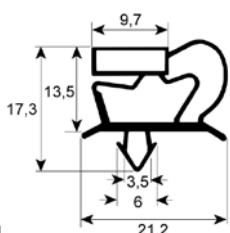

GEV No.	900860	Ref. No.	37Q3950
description	refrigeration gasket profile 9048 W 253mm L 373mm plug size		
For models:	6JA2, 6JA2A, 6JA2M, 6JB2, 6JB2A, 6JB2M, 6JB4A, 6JB4M, 6SMA2, 6SMA2A, 6SMA2B, 6SMA2M, 6SMA2Z, 6SMA4Z, 6SMB2, 6SMB2A, 6SMB2B, 6SMB2M, 6SMB2Z, 6SMB4, 6SMB4A, 6SMB4B, 6SMB4M, 6SMB4Z, 6SMB6Z, 6SMC2, 6SMC2A, 6SMC2B, 6SMC2M, 6SMC2Z, 6SMC4, 6SMC4A, 6SMC4B, 6SMC4M, 6SMC4Z, 6SMC6, 6SMC6A, 6SMC6B, 6SMC6M, 6SMC6Z, 6SMC8Z		

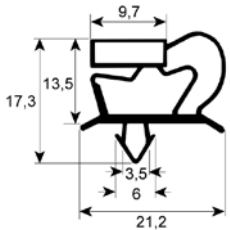

GEV No.	900864	Ref. No.	37Q4740
description	refrigeration gasket profile 9048 W 354mm L 373mm plug size		
For models:	6BMA11A, 6BMA11M, 6BMA11Z, 6BMB11A, 6BMB11M, 6BMB11Z, 6BMB22A, 6BMB22M, 6BMB22Z, 6BMC11A, 6BMC11M, 6BMC11Z, 6BMC22A, 6BMC22M, 6BMC22Z, 6BMC33A, 6BMC33M, 6BMC33Z, 6EA11, 6EA11A, 6EA11M, 6EB11, 6EB11A, 6EB11M, 6EB22, 6EB22A, 6EB22M, 6EC11, 6EC11A, 6EC11M, 6EC22, 6EC22A, 6EC22M, 6MB11, 6MB11A, 6MB11M, 6MC11, 6MC11A, 6MC11M, 6MRB11, 6MRB11A, 6MRB11M, 6MRB11Z, 6MRC11, 6MRC11A, 6MRC11M, 6MRC11Z, 6RB11, 6RB11A, 6RB11M... (Other models you can see in the webshop)		

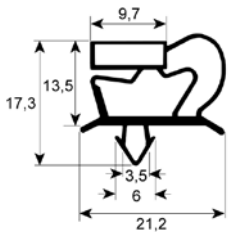

GEV No.	900861	Ref. No.	37Q4710
description	refrigeration gasket profile 9048 W 373mm L 570mm plug size		
For models:	6BMA11A, 6BMA11B, 6BMA11M, 6BMA11Z, 6BMA2A, 6BMA2B, 6BMA2M, 6BMA2Z, 6BMA3A, 6BMA3B, 6BMA3M, 6BMA3Z, 6BMAA, 6BMAAB, 6BMAAM, 6BMAZ, 6BMB11A, 6BMB11B, 6BMB11M, 6BMB11Z, 6BMB22A, 6BMB22B, 6BMB22M, 6BMB22Z, 6BMB2A, 6BMB2B, 6BMB2M, 6BMB2Z, 6BMB3A, 6BMB3B, 6BMB3M, 6BMB3Z, 6BMB4A, 6BMB4B, 6BMB4M, 6BMB4Z, 6BMBBA, 6BMBBB, 6BMBMB, 6BMBZ, 6BMC11A, 6BMC11B, 6BMC11M, 6BMC11Z, 6BMC22A, 6BMC22B, 6BMC22M, 6BMC22Z, 6BMC2A, 6BMC2B... (Other models you can see in the webshop)		

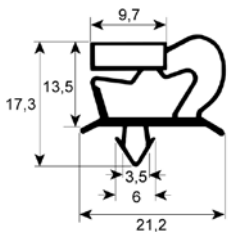

GEV No.	900709	Ref. No.	37Q3870
description	refrigeration gasket profile 9048 W 373mm L 580mm plug size		
For models:	6JA, 6JA2, 6JA2A, 6JA2M, 6JAA, 6JAM, 6JB, 6JB2, 6JB2A, 6JB2M, 6JB4A, 6JB4M, 6JBA, 6JBM, 6SMA, 6SMA2, 6SMA2A, 6SMA2B, 6SMA2M, 6SMA2Z, 6SMAA, 6SMAB, 6SMAM, 6SMAZ, 6SMB, 6SMB2, 6SMB2A, 6SMB2B, 6SMB2M, 6SMB2Z, 6SMB4, 6SMB4A, 6SMB4B, 6SMB4M, 6SMB4Z, 6SMBBA, 6SMBBB, 6SMBMB, 6SMBZ, 6SMC, 6SMC2, 6SMC2A, 6SMC2B, 6SMC2M, 6SMC2Z, 6SMC4, 6SMC4A, 6SMC4B, 6SMC4M, 6SMC4Z... (Other models you can see in the webshop)		



GEV No.	900812	Ref. No.	37Q4490
description	refrigeration gasket profile 9048 W 400mm L 650mm plug size for blast chiller		
For models:	ART1L7, ART1L7A, ART1L7M, ART1LD7, ART1LD7A, ART1LD7M, B151M, BF51M, DA51, DA51A, DA51M, DS31, DS31A, DS31C, DS31M, DS51, DS51A, DS51C, DS51M, IA51, IA51A, IA51C, IA51M, IS51, IS51A, IS51AR, IS51C, IS51CR, IS51M, IS51MR, IS51R, IS51W, IS51WA, IS51WC, IS51WM, SM03LT7, SM03LT7A, SM03LT7M, SM1L7, SM1L7A, SM1L7FCV, SM1L7M, SM1LT7, SM1LT7A, SM1LT7M, VA51, VA51M, VS31, VS31M, VS51...(Other models you can see in the webshop)		

GEV No.	900710	Ref. No.	37Q5450
description	refrigeration gasket profile 9048 W 655mm L 1500mm plug size		
For models:	AGL6B, CX120, CX120B, CX120NN, CX140, CX140B, CX140BN, CX140BR, CX140CP, CX140NN, CX140R, CX55, CX55B, CX65, CX65B, CX65BR, CX65R, GD150, GD150B, GD70, GD70B, MD130, MD130B, MD130BN, MD130NN, MD150, MD150B, MD150BB, MD150BN, MD150BR, MD150NCP, MD150NN, MD150R, MD60, MD60B, MD70, MD70B, MD70BR, MD70CP, MD70R, MDE150, MDE150B, MDE70, MDE70B, MX120, MX120B, MX120NN, MX140, MX140B, MX140NN...(Other models you can see in the webshop)		

GEV No.	901207	Ref. No.	37Q3810
description	refrigeration gasket profile 9048 W 429mm L 675mm plug size for blast chiller		
For models:	ART1L, ART1LA, ART1LD, ART1LDA, BF51H, DS351H, IS51H, IS51HW, SM1L, SM1LA, SM1LAM, SM1LAR, SM1LAT, SM1LAW, SM1LM, SM1LR, SM1LT, SM1LW		

GEV No.	901329	Ref. No.	37Q5460
description	refrigeration gasket profile 9048 W 655mm L 704mm plug size		
For models:	CX140CP, CX652, CX65NB, CX65NCP, CX65NN, MD1504, MD150B4, MD702, MD70B2, MD70NB, MD70NCP, MD70NN, PD150CP, PD702, PD70B2		

GEV No.	902533	Ref. No.	37Q4140
description	refrigeration gasket profile 9048 W 450mm L 600mm plug size		

GEV No.	900706	Ref. No.	37Q4370
description	refrigeration gasket profile 9048 W 660mm L 1610mm plug size		
For models:	CX130, CX130B, CX130NN, CX150, CX150B, CX150BN, CX150BR, CX150CP, CX150NN, CX150R, CX60, CX60B, CX70, CX70B, CX70BR, CX70R, FX150, FX150B, FX150NN, FX70, FX70B, MX130, MX130B, MX130NN, MX150, MX150B, MX150NN, MX60, MX60B, MX70, MX70B		

GEV No.	900712	Ref. No.	37Q1020 37Q4850
description	refrigeration gasket profile 9048 W 595mm L 1590mm plug size		
For models:	S1200, S1200B, S1200BE, S1200E, S125, S125B, S125BE, S125BX, S125E, S125X, S60, S600, S600B, S600BE, S600E, S60B, S60BE, S60BX, S60E, S60X		

GEV No.	900350	Ref. No.	37Q2600
description	refrigeration gasket profile 9048 W 670mm L 760mm plug size 1/2 door		
For models:	135-4, 135CPX, 135X-3, 135X-4, 65BX-2, 65NB, 65NBX, 65NN, 65NNX, 65X-2, SP135CP, SP65NB, SP65NN		

GEV No.	900351	Ref. No.	37Q2590
description	refrigeration gasket profile 9048 W 672mm L 1587mm plug size door		
For models:	120, 120B, 120NN, 135, 135A, 135B, 135BA, 135BN, 135BNX, 135BX, 135BXE, 135BXR, 135CPX, 135NN, 135NNX, 135X, 135X-3, 135XE, 135XR, 55, 55B, 55PV, 65, 65A, 65B, 65BA, 65BX, 65BXE, 65BXR, 65X, 65XE, 65XR, SP120, SP120B, SP120BN, SP120NN, SP135, SP135B, SP135BN, SP135CP, SP135NN, SP55, SP55B, SP65, SP65B		

GEV No.	901205	Ref. No.	37Q5340
description	refrigeration gasket profile 9048 W 690mm L 835mm plug size for blast chiller		
For models:	B1101S, BF101L, BF101S, IA101L, IA101S, IS101L, IS101LR, IS101LW, IS101S, IS101SR, IS101SW, VS101L, XA101L, XA101S, XS101L, XS101S		

GEV No.	900328	Ref. No.	37Q1370
description	refrigeration gasket profile 9048 W 675mm L 1525mm plug size glass door		
For models:	40EV, 40EVP, 40PV, 40XPV		

GEV No.	901204	Ref. No.	37Q5380
description	refrigeration gasket profile 9048 W 941mm L 1002mm plug size for blast chiller		
For models:	IA72S, IS102S, IS102SR, IS102SR-0NR01, IS102SW, IS72S, IS72SR, IS72SW		

GEV No.	901206	Ref. No.	37Q3800
description	refrigeration gasket profile 9048 W 675mm L 820mm plug size for blast chiller		
For models:	ART2LD, ART2SD, SM2L, SM2LR, SM2LW, SM2S, SM2SR, SM2SW		

GEV No.	902258	Ref. No.	N/A
description	refrigeration gasket profile 9048 Wmm L 2500mm		

GEV No.	900326	Ref. No.	37Q1380
description	refrigeration gasket profile 9048 W 685mm L 1600mm plug size glass door		
For models:	120PV, 135PVX, 65PVX		

profile 9046

We offer custom-made gaskets for this profile

GEV No.	902515	Ref. No.	3125970
description	refrigeration gasket profile 9046 W 377mm L 395mm plug size		
For models:	3G6SA, 3G6SA2, 3G6SA4, 4G6SB, 4G6SB2, 4G6SB4, 4G6SB6, 6BR15V, 6BR15VC, 6BR19V, 6BR19VC, 6SA, 6SA2, 6SA2M, 6SAM, 6SB, 6SB2, 6SB2M, 6SBM		



GEV No.	902314	Ref. No.	37Q5510
description	refrigeration gasket profile 9046 W 520mm L 1495mm plug size		
For models:	AF1B, AF1B-OPR01, AF1N, AF1N-OPR01, FSD1B, FSD1B-OPR01, FSD1N, FSD1N-OPR01, FSDR1B-OPR01, FSDR1N-OPR01		

GEV No.	901801	Ref. No.	37Q4470
description	refrigeration gasket profile 9046 W 650mm L 750mm plug size		
For models:	CX150CP, CX702, CX70NB, CX70NN		

GEV No.	902257	Ref. No.	N/A
description	refrigeration gasket profile 9046 Wmm L 2500mm		

profile 9704

We offer custom-made gaskets for this profile

GEV No.	902315	Ref. No.	37Q5490
description	refrigeration gasket profile 9704 W 655mm L 1500mm plug size		
For models:	CX140PV, CX65PV, MD150BPV, MD150PV, MD70BPV, MD70PV, PD70B-PV, PD70PV, TE140PV, TE65PV		

profile 9753

We offer custom-made gaskets for this profile

GEV No.	900875	Ref. No.	N/A
description	refrigeration gasket profile 9753 Wmm L 2500mm		

profile 9333

We offer custom-made gaskets for this profile

GEV No.	900016	Ref. No.	37Q1890
description	refrigeration gasket profile 9333 W 650mm L 1550mm plug size 1/2 door		

profile 9012

We offer custom-made gaskets for this profile

GEV No.	900354	Ref. No.	37Q7730
description	refrigeration gasket profile 9012 W 130mm L 367mm plug size drawer size 1/3		
For models:	6BEA11A, 6BEA11B, 6BEA11M, 6BEA11Z, 6BEA3A, 6BEA3B, 6BEA3M, 6BEA3Z, 6BEB11A, 6BEB11M, 6BEB11Z, 6BEB22A, 6BEB22M, 6BEB22Z, 6BEB3A, 6BEB3B, 6BEB3M, 6BEB3Z, 6BEC11A, 6BEC11B, 6BEC11M, 6BEC11Z, 6BEC22A, 6BEC22B, 6BEC22M, 6BEC22Z, 6BEC33A, 6BEC33B, 6BEC33M, 6BEC33Z, 6BEC3A, 6BEC3B, 6BEC3M, 6BEC3Z, 6BMA11A, 6BMA11B, 6BMA11M, 6BMA11Z, 6BMA3A, 6BMA3M, 6BMA3Z, 6BMB11A, 6BMB11B, 6BMB11M, 6BMB11Z, 6BMB22A, 6BMB22B, 6BMB22M, 6BMB22Z, 6BMB3A...(Other models you can see in the webshop)		

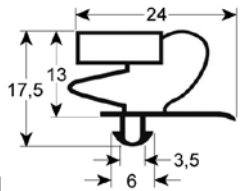

GEV No.	900353	Ref. No.	37Q7690
description	refrigeration gasket profile 9012 W 242mm L 367mm plug size drawer size 1/2		
For models:	6BEA2A, 6BEA2B, 6BEA2M, 6BEA2Z, 6BEB2A, 6BEB2B, 6BEB2M, 6BEB2Z, 6BEB4A, 6BEB4B, 6BEB4M, 6BEB4Z, 6BEC2A, 6BEC2B, 6BEC2M, 6BEC2Z, 6BEC4A, 6BEC4B, 6BEC4M, 6BEC4Z, 6BEC6A, 6BEC6B, 6BEC6M, 6BEC6Z, 6BMA2M, 6BMA2Z, 6BMB2B, 6BMB2M, 6BMB2Z, 6BMB4A, 6BMB4B, 6BMB4M, 6BMB4Z, 6BMC2A, 6BMC2B, 6BMC2M, 6BMC2Z, 6BMC4A, 6BMC4B, 6BMC4M, 6BMC4Z, 6BMC6A, 6BMC6B, 6BMC6M, 6BMC6Z, 6FMA2A, 6FMA2B, 6FMA2M, 6FMA2Z, 6FMA4A...(Other models you can see in the webshop)		

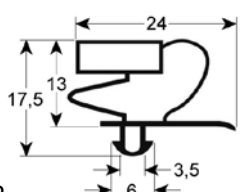

GEV No.	900325	Ref. No.	37Q7720
description	refrigeration gasket profile 9012 W 345mm L 362mm plug size drawer size 2/3		
For models:	6BEA11A, 6BEA11B, 6BEA11M, 6BEA11Z, 6BEB11A, 6BEB11M, 6BEB11Z, 6BEB22A, 6BEB22M, 6BEB22Z, 6BEC11A, 6BEC11B, 6BEC11M, 6BEC11Z, 6BEC22A, 6BEC22B, 6BEC22M, 6BEC22Z, 6BEC33A, 6BEC33B, 6BEC33M, 6BEC33Z, 6BMA11A, 6BMA11B, 6BMA11M, 6BMA11Z, 6BMB11A, 6BMB11B, 6BMB11M, 6BMB11Z, 6BMB22A, 6BMB22B, 6BMB22M, 6BMB22Z, 6BMC11A, 6BMC11B, 6BMC11M, 6BMC11Z, 6BMC22A, 6BMC22B, 6BMC22M, 6BMC22Z, 6BMC33A, 6BMC33B, 6BMC33M, 6BMC33Z, 6FMA11A, 6FMA11B, 6FMA11M, 6FMA11Z...(Other models you can see in the webshop)		

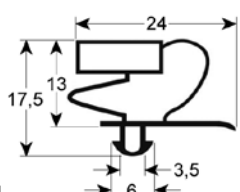

GEV No.	900352	Ref. No.	37Q7590
description	refrigeration gasket profile 9012 W 367mm L 567mm plug size door size 1/1		
For models:	6BEA11A, 6BEA11B, 6BEA11M, 6BEA11Z, 6BEA2A, 6BEA2B, 6BEA2M, 6BEA2Z, 6BEA3A, 6BEA3B, 6BEA3M, 6BEA3Z, 6BEA4A, 6BEA4B, 6BEA4M, 6BEA4Z, 6BEA4A, 6BEA4B, 6BEA4M, 6BEA4Z, 6BEB11A, 6BEB11B, 6BEB11M, 6BEB11Z, 6BEB22A, 6BEB22B, 6BEB22M, 6BEB22Z, 6BEB2A, 6BEB2B, 6BEB2M, 6BEB2Z, 6BEB3A, 6BEB3B, 6BEB3M, 6BEB3Z, 6BEB4A, 6BEB4B, 6BEB4M, 6BEB4Z, 6BEBA, 6BEBB, 6BEBBA, 6BEBBB, 6BEBBM, 6BEBBZ, 6BEBM, 6BEBZ, 6BEC11A, 6BEC11B...(Other models you can see in the webshop)		

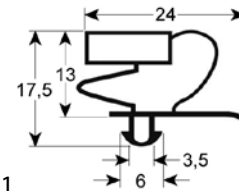

GEV No.	900327	Ref. No.	37Q0210
description	refrigeration gasket profile 9012 W 657mm L 1512mm plug size door refrigeration		
For models:	40, 40B, 40CP, 40CPX, 40PL, 40X		

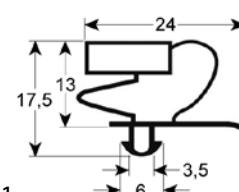

GEV No.	900017	Ref. No.	37Q2010
description	refrigeration gasket profile 9012 W 657mm L 747mm plug size door/glass door		

profile 9251

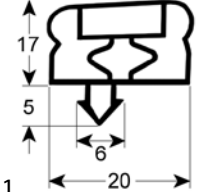

GEV No.	901504	Ref. No.	37Q4290
description	refrigeration gasket profile 9251 W 750mm L 2000mm plug size 3-sided short side open		
For models:	10003C, 10003CP, 10003CPB, 10043C, 10043CP, 10043CPB, 11703C, 11703CP, 11703CPB, 12003C, 12003CP, 12003CPB, 12043C, 12043CP, 12043CPB, 14003C, 14003CP, 14003CPB, 14043C, 14043CP, 14043CPB, 14343C, 14343CP, 14343CPB, 16743C, 16743CP, 16743CPB, 3103C, 3103CP, 3103CPB, 3743C, 3743CP, 3743CPB, 4103C, 4103CP, 4103CPB, 4943C, 4943CP, 4943CPB, 5103C, 5103CP, 5103CPB, 5403C, 5403CP, 5403CPB, 6103C, 6103CP, 6103CPB, 6143C, 6143CP...(Other models you can see in the webshop)		

screw-in gaskets

profile 9031

We offer custom-made gaskets for this profile

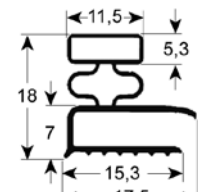

GEV No.	901006	Ref. No.	37Q0470
description	refrigeration gasket profile 9031 W 614mm L 590mm external size		



GEV No.	901005	Ref. No.	37Q0450
description	refrigeration gasket profile 9031 W 660mm L 1360mm external size		

profile 9140

We offer custom-made gaskets for this profile

GEV No.	900705	Ref. No.	37Q2050
description	refrigeration gasket profile 9140 W 295mm L 380mm external size		
For models:	K16APGPZ, K16XPZAP, SA16AGB, SA16GB		

GEV No.	900009	Ref. No.	37Q2040
description	refrigeration gasket profile 9140 W 380mm L 610mm external size		
For models:	K16APGPZ, K16XPZAP, SA16AGB, SA16GB		

GEV No.	900858	Ref. No.	37Q3210
description	refrigeration gasket profile 9140 W 383mm L 531mm external size		
For models:	SA87		

GEV No.	900859	Ref. No.	37Q3250
description	refrigeration gasket profile 9140 W 459mm L 613mm external size		

GEV No.	900717	Ref. No.	37Q2380
description	refrigeration gasket profile 9140 W 575mm L 610mm external size		

GEV No.	901606	Ref. No.	37Q3320
description	refrigeration gasket profile 9140 W 600mm L 645mm external size		
For models:	BRPR, BRPR218, BRPR21C, BRPRV, BRVR, BRVR218, BRVR21C, BRVRV		

GEV No.	901657	Ref. No.	37Q0760
description	refrigeration gasket profile 9140 W 655mm L 1555mm external size		

GEV No.	902264	Ref. No.	N/A
description	refrigeration gasket profile 9140 Wmm L 2500mm		

profile 9106

We offer custom-made gaskets for this profile

GEV No.	902262	Ref. No.	N/A
description	refrigeration gasket profile 9106 Wmm L 2500mm		

profile 9207

We offer custom-made gaskets for this profile

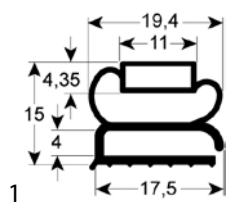

GEV No.	901004	Ref. No.	37Q0770
description	refrigeration gasket profile 9207 W 660mm L 755mm external size		

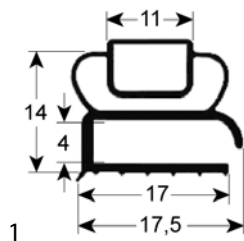

GEV No.	902277	Ref. No.	N/A
description	refrigeration gasket profile 9207 Wmm L 2500mm		

gaskets for heated units

window seals

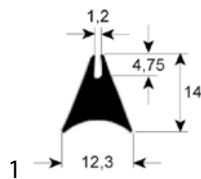

GEV No.	900058	Ref. No.	37Q2470
description	window gasket profile 1620 Qty supplied by meter		

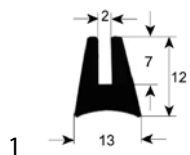

GEV No.	900442	Ref. No.	37Q7400 37Q7401
description	window gasket profile 1630 L 1075mm Qty 1		
For models:	FCV3EM, FCV4E, FCV4EDS, FCV4EM, FM423E1, FM423E2		

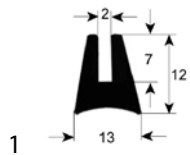

GEV No.	900447	Ref. No.	37Q2981 37Q2982
description	window gasket profile 1630 L 1350mm Qty 1		
For models:	71AR, 71ARE, 71RA, 91AR, 91ARE, 91RA, FC61, FC61E, FCV61, FCV61-CSA, FCV61DM, FCV61DM-CSA, FCV61DS, FCV61DS-CSA, FCV61E, FCV61EDM, FCV61EDM-UL, FCV61EDS, FCV61EDS-UL, FCV61E-UL		

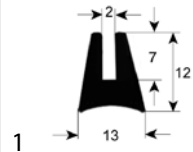

GEV No.	900448	Ref. No.	37Q2991 37Q2992
description	window gasket profile 1630 L 1800mm Qty 1		
For models:	FC101, FC101E, FCV101, FCV101-CSA, FCV101DM, FCV101DM-CSA, FCV101DS, FCV101DS-CSA, FCV101E, FCV101EDM, FCV101EDM-UL, FCV101EDS, FCV101EDS-UL, FCV101E-UL		

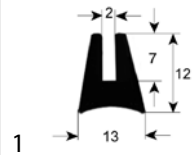

GEV No.	900449	Ref. No.	37Q7530 37Q7531
description	window gasket profile 1630 L 2050mm Qty 1		
For models:	FCV141, FCV141-CSA, FCV141DM, FCV141DM-CSA, FCV141DS, FCV141DS-CSA, FCV141E, FCV141EDM, FCV141EDS, FCV72EDM-UL, FCV72EDS-UL, FCV72E-UL		

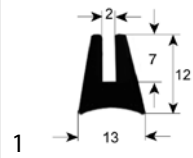

GEV No.	900450	Ref. No.	37Q3000 37Q3001
description	window gasket profile 1630 L 2700mm Qty 1		
For models:	FC241, FC241E, FC241G, FCV241, FCV241DM, FCV241DS, FCV241E, FCV241EDM, FCV241EDM-UL, FCV241EDS, FCV241EDS-UL, FCV241E-UL, FCV241G, FCV241G-CSA, FCV241GDM, FCV241GDM-CSA, FCV241GDS, FCV241GDS-CSA		

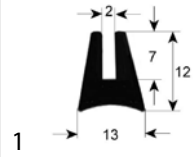

GEV No.	900730	Ref. No.	N/A
description	window gasket profile 1630 Qty supplied by meter		

door seals

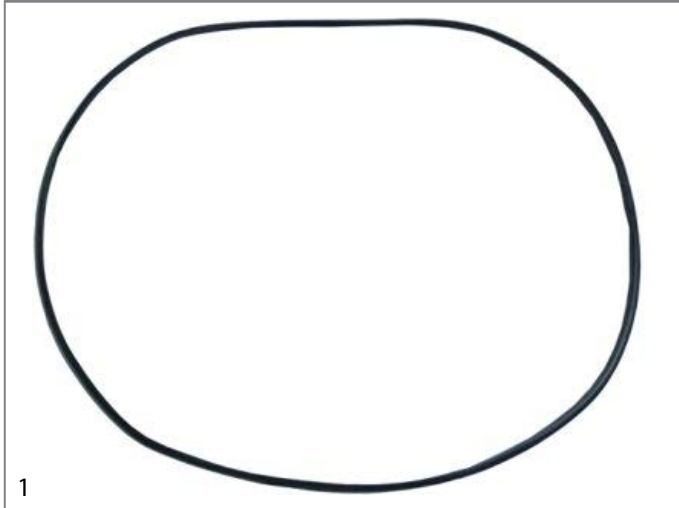

GEV No.	900725	Ref. No.	37Q7621
description	door seal		
For models:	FCV401DM, FCV401DM-CSA, FCV401EDM, FCV401EDM-UL		



GEV No.	900720	Ref. No.	3031880
description	door seal profile 1855 Qty supplied by meter		
For models:	1G1FA0E, 1G1FA0G, 1G1FABG, 1G1FAPG, 1G1PE1E, 1G1PE2E, 1G1TP0G, 2G1FAGF, 2G1FA0E, 2G1FA0G, 2G1FABG, 2G1FACG, 2G1FADG, 2G1FADGV, 2G1FAPG, 2G1PE1E, 2G1PE2E, 2G1TP3G		

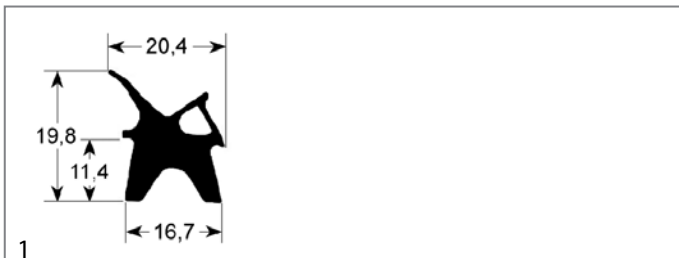

GEV No.	900059	Ref. No.	37Q2480
description	door seal profile 2410 Qty supplied by meter		

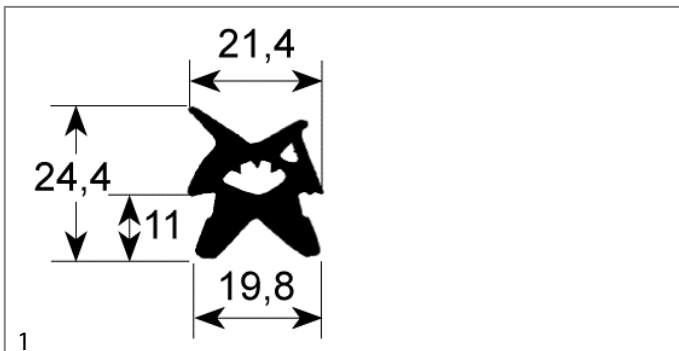

GEV No.	900441	Ref. No.	37Q1001 37Q1002
description	door seal profile 2420 W 330mm L 410mm external size Qty 1		
For models:	FCV3EM, FCV4E, FCV4EDS, FCV4EM		

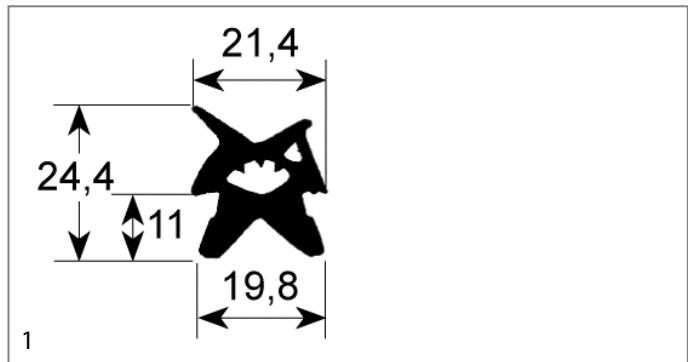

GEV No.	900443	Ref. No.	37Q0951 37Q0952
description	door seal profile 2420 W 450mm L 460mm outer plug size Qty 1 suitable for CONVOTHERM		
For models:	FC61, FC61E, FCV61, FCV61-CSA, FCV61DM, FCV61DM-CSA, FCV61DS, FCV61DS-CSA, FCV61E, FCV61EDM, FCV61EDM-UL, FCV61EDS, FCV61EDS-UL, FCV61E-UL		

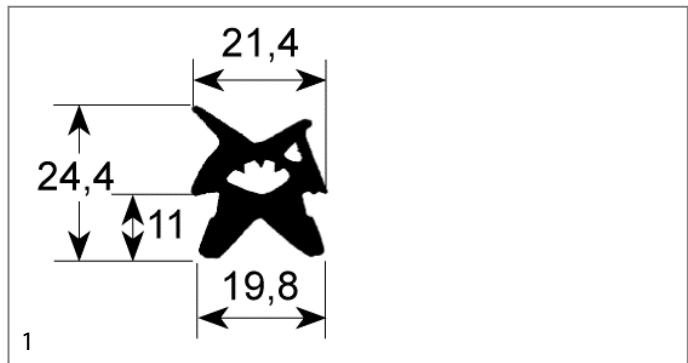

GEV No.	900713	Ref. No.	37Q2952
description	door seal profile 2420 W 450mm L 700mm external size Qty 1		

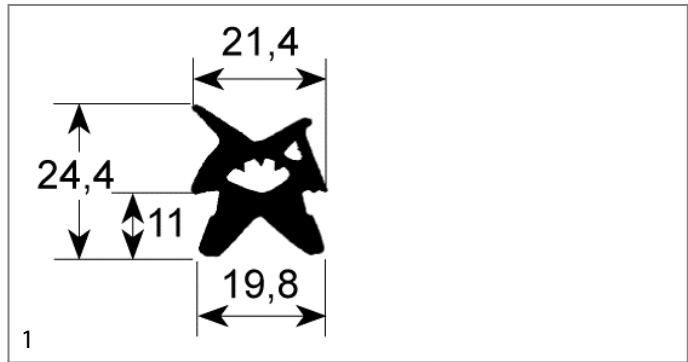

GEV No.	900444	Ref. No.	37Q0970 37Q0971 37Q0972
description	door seal profile 2420 W 450mm L 700mm outer plug size Qty 1 suitable for CONVOTHERM		
For models:	FC101, FC101E, FCV101, FCV101-CSA, FCV101DM, FCV101DM-CSA, FCV101DS, FCV101DS-CSA, FCV101E, FCV101EDM, FCV101EDM-UL, FCV101EDS, FCV101EDS-UL, FCV101E-UL		

GEV No.	900445	Ref. No.	37Q0981 37Q0982
description	door seal profile 2420 W 565mm L 680mm external size Qty 1		
For models:	FCV141, FCV141-CSA, FCV141DM, FCV141DM-CSA, FCV141DS, FCV141DS-CSA, FCV141E, FCV141EDM, FCV141EDS, FCV72EDM-UL, FCV72EDS-UL, FCV72E-UL		

GEV No.	900446	Ref. No.	37Q0990 37Q0991 37Q0992
description	door seal profile 2420 W 670mm L 860mm external size Qty 1		
For models:	FC241, FC241E, FC241G, FCV241, FCV241DM, FCV241DS, FCV241E, FCV241EDM, FCV241EDM-UL, FCV241EDS, FCV241EDS-UL, FCV241E-UL, FCV241G, FCV241G-CSA, FCV241GDM, FCV241GDM-CSA, FCV241GDS, FCV241GDS-CSA		

GEV No.	900721	Ref. No.	37Q7633
description	door seal profile 2420 W 680mm L 1380mm external size Qty 1		
For models:	FCV401DM, FCV401DM-CSA, FCV401EDM, FCV401EDM-UL		

GEV No.	901394	Ref. No.	37Q4980
description	door seal profile 2438 W 330mm L 410mm external size		
For models:	FCV3EM, FCV4E, FCV4EDS, FCV4EM, FM423E1, FM423E2		

GEV No.	900748	Ref. No.	3050160
description	door seal profile 2780 W 475mm L 1360mm external size Qty 1		
For models:	FM2011E2-VERS.2006, FM2011E3-VERS.2006, FM2011G2-VERS.2006, FM2011G3-VERS.2006		

GEV No.	900716	Ref. No.	36E3030 36E3031
description	door seal profile 2780 W 485mm L 485mm external size Qty 1		
For models:	FC611E, FC611G, FM611E1, FM611E1-VERS.2006, FM611E2, FM611E2-VERS.2006, FM611E3, FM611E3-VERS.2006, FM611G1, FM611G1-VERS.2006, FM611G2, FM611G2-VERS.2006, FM611G3, FM611G3-VERS.2006		

GEV No.	900715	Ref. No.	36E3020 36E3021
description	door seal profile 2780 W 490mm L 700mm external size Qty 1		
For models:	FC1011E, FC1011G, FM1011E1, FM1011E1-VERS.2006, FM1011E2, FM1011E2-VERS.2006, FM1011E3, FM1011E3-VERS.2006, FM1011G1, FM1011G1-VERS.2006, FM1011G2, FM1011G2-VERS.2006, FM1011G3, FM1011G3-VERS.2006		



GEV No.	900749	Ref. No.	36E4061
description	door seal profile 2780 W 630mm L 690mm external size Qty 1		
For models:	FM721E1, FM721E1-VERS.2006, FM721E2, FM721E2-VERS.2006, FM721E3, FM721E3-VERS.2006, FM721G1, FM721G1-VERS.2006, FM721G2, FM721G2-VERS.2006, FM721G3, FM721G3-VERS.2006		

GEV No.	900746	Ref. No.	36E3921
description	door seal profile 2780 W 690mm L 1360mm external size Qty 1		
For models:	FM2021E1, FM2021E2, FM2021E2-VERS.2006, FM2021E3, FM2021E3-VERS.2006, FM2021G1, FM2021G2, FM2021G2-VERS.2006, FM2021G3, FM2021G3-VERS.2006		

GEV No.	900747	Ref. No.	36E3520 36E3521
description	door seal profile 2780 W 690mm L 860mm external size Qty 1		
For models:	FC1221E, FC1221G, FM1221E1, FM1221E1-VERS.2006, FM1221E2, FM1221E2-VERS.2006, FM1221E3, FM1221E3-VERS.2006, FM1221G1, FM1221G1-VERS.2006, FM1221G2, FM1221G2-VERS.2006, FM1221G3, FM1221G3-VERS.2006		

GEV No.	901624	Ref. No.	3077280 3077281 3077282
description	door seal profile 2781 W 475mm L 1410mm external size suitable for ANGELO PO		
For models:	FX201E2, FX201E2P, FX201E2P-VERS.032014, FX201E2-VERS.032014, FX201E3, FX201E3P, FX201E3P-VERS.022014, FX201E3-VERS.022014, FX201G2, FX201G2P, FX201G2P-VERS.032014, FX201G2-VERS.032014, FX201G3P, FX201G3-VERS.022014		

GEV No.	901622	Ref. No.	3077260 3077261 3077262
description	door seal profile 2781 W 475mm L 475mm external size suitable for ANGELO PO		
For models:	BX61E, BX61E-VERS.122013, BX61G, BX61G-VERS.122013, FX61E1, FX61E1R, FX61E2, FX61E2C, FX61E2CR, FX61E2CR-VERS.032014, FX61E2C-VERS.032014, FX61E2R, FX61E2R-VERS.032014, FX61E2-VERS.032014, FX61E3, FX61E3C, FX61E3CR, FX61E3CR-VERS.022014, FX61E3C-VERS.022014, FX61E3R, FX61E3R-VERS.022014, FX61E3-VERS.022014, FX61G1, FX61G1R, FX61G2, FX61G2C, FX61G2CR, FX61G2CR-VERS.032014, FX61G2C-VERS.032014, FX61G2R, FX61G2R-VERS.032014, FX61G2-VERS.032014, FX61G3, FX61G3C, FX61G3CR, FX61G3CR-VERS.022014, FX61G3C-VERS.022014, FX61G3R, FX61G3R-VERS.022014, FX61G3-VERS.022014		

GEV No.	901623	Ref. No.	3077270 3077271 3077272
description	door seal profile 2781 W 475mm L 725mm external size suitable for ANGELO PO		
For models:	BX101E, BX101E-VERS.122013, BX101G, BX101G-VERS.122013, FX101E1, FX101E1R, FX101E2, FX101E2C, FX101E2C-VERS.032014, FX101E2R, FX101E2R-VERS.032014, FX101E2-VERS.032014, FX101E3, FX101E3C, FX101E3C-VERS.022014, FX101E3R, FX101E3R-VERS.022014, FX101E3-VERS.022014, FX101G1, FX101G1R, FX101G2, FX101G2C, FX101G2C-VERS.032014, FX101G2R, FX101G2R-VERS.032014, FX101G2-VERS.032014, FX101G3, FX101G3C, FX101G3C-VERS.022014, FX101G3R, FX101G3R-VERS.022014, FX101G3-VERS.022014, FX10E2CR, FX10E2CR-VERS.032014, FX10E3CR, FX10E3CR-VERS.022014, FX10G2CR, FX10G2CR-VERS.032014, FX10G3CR, FX10G3CR-VERS.022014		

GEV No.	901625	Ref. No.	3077290 3077291 3077292
description	door seal profile 2781 W 628mm L 686mm external size suitable for ANGELO PO		
For models:	BX82E, BX82E-VERS.122013, BX82G, BX82G-VERS.122013, FX82E1, FX82E2, FX82E2C, FX82E2T, FX82E2T-VERS.032014, FX82E3, FX82E3C, FX82E3CT, FX82E3CT-VERS.022014, FX82E3T, FX82E3T-VERS.022014, FX82G1, FX82G2, FX82G2C, FX82G2T, FX82G2T-VERS.032014, FX82G3, FX82G3C, FX82G3CT, FX82G3CT-VERS.022014, FX82G3T, FX82G3T-VERS.022014		

GEV No.	901627	Ref. No.	3077310 3077311 3077312
description	door seal profile 2781 W 688mm L 1410mm external size suitable for ANGELO PO		
For models:	FX202E2, FX202E2-VERS.032014, FX202E3, FX202E3-230V-3-50Hz-60Hz, FX202E3-230V-3-50Hz-60Hz-VERS.022014, FX202E3-VERS.022014, FX202G2, FX202G2-VERS.032014, FX202G3, FX202G3-VERS.022014		

GEV No.	901626	Ref. No.	3077300 3077301 3077302
description	door seal profile 2781 W 688mm L 886mm external size suitable for ANGELO PO		
For models:	BX122E, BX122E-VERS.122013, BX122G, BX122G-VERS.122013, FX122E1, FX122E2, FX122E2C, FX122E2T, FX122E2T-VERS.032014, FX122E3, FX122E3C, FX122E3T, FX122E3T-VERS.022014, FX122G1, FX122G3, FX122G3C, FX122G3T, FX122G3T-VERS.022014, FX12E3CT, FX12E3CT-VERS.022014, FX12G3CT, FX12G3CT-VERS.022014		

gaskets for tray rack trolleys

GEV No.	902513	Ref. No.	3040480
description	tray rack trolley gasket profile 4110 L 510mm Qty 1		
For models:	FM2011E2-VERS.2006, FM2011E3-VERS.2006, FM2011G2-VERS.2006, FM2011G3-VERS.2006		

GEV No.	901396	Ref. No.	3039710
description	tray rack trolley gasket profile 4110 L 712mm Qty 1		
For models:	FM2021E2-VERS.2006, FM2021E3-VERS.2006, FM2021G2-VERS.2006, FM2021G3-VERS.2006		

GEV No.	902520	Ref. No.	3091160 3199570
description	tray rack trolley gasket profile 4140 L 515mm Qty 1		
For models:	FX201E2, FX201E2P, FX201E2P-VERS.032014, FX201E2-VERS.032014, FX201E3, FX201E3P, FX201E3P-VERS.022014, FX201E3-VERS.022014, FX201G2, FX201G2P, FX201G2P-VERS.032014, FX201G2-VERS.032014, FX201G3P, FX201G3-VERS.022014		



O-rings

EPDM

GEV No.	540682	Ref. No.	3150840 37Q1210
description	O-ring EPDM thickness 1.78mm ID ø 18.77mm Qty 1 pcs		
For models:	030BME, 030EBM, 030FE, 031BME, 031EBM, 04WBMEV, 08WGREV, 090BM1E, 090BM1G, 091CP1E, 091CP1G, 091FR1EX, 091FR7GS, 091FR7GX, 0A1CP1E, 0A1CP1G, 0B1CP1G, 0D1CP1E, 0D1CP1G, 0G1CP1E, 0G1CP1E-VERS.2004, 0G1CP1G, 0G1CP1G-VERS.2004, 190BM2E, 190BM2G, 190GRE, 191CP1G, 191CP2G, 1A1CP1G, 1A1CP2G, 1D1CP1G, 1D1CP2G, 1G0GRE, 1G1CP1G, 1G1CP1G-VERS.2004, 1G1CP2G, 1G1CP2G-VERS.2004, 30CP5, 30CPSE, 6040090, 6040110, 6040310, 6042680, 6043850, 6043980, 70CP, 71CP2, 90CP		

GEV No.	510303	Ref. No.	3152180
description	O-ring EPDM thickness 1.78mm ID ø 6.75mm Qty 1 pcs		
For models:	LC100, LC100-VERS.2001, LC130, LC130-VERS.2001, LC80, LF50, LF50E, LF50EM, LF50EMPS, LP124, LP124S-VERS.052006, LP124V, LP124-VERS.052006, LP124VS-VERS.052006, LP124V-VERS.052006, LP84, LP84S-VERS.052006, LP84V, LP84-VERS.052006, LP84VS-VERS.052006, LP84V-VERS.052006		

GEV No.	510177	Ref. No.	3035830 3152210
description	O-ring EPDM thickness 1.78mm ID ø 7.66mm Qty 1 pcs		

GEV No.	519181	Ref. No.	3152400
description	O-ring EPDM thickness 1mm ID ø 5mm Qty 1 pcs		

GEV No.	102997	Ref. No.	3152550
description	O-ring EPDM thickness 1mm ID ø 6mm Qty 1 pcs		
For models:	04WFAAV, 08WFA4E, 08WFA4G, 08WFAAE, 08WFAAG, 08WFAAV, 090FAA, 0A0FA1, 0A0FA4, 0A0FAA, 0D0FA1, 0D0FA4, 0D0FAA, 0G0FA0, 12WFA6E, 12WFA6G, 12WFAAA, 12WFAAE, 12WFAAG, 12WFAAN, 190FA, 190FAA, 190FAB, 190FAD, 191FAAE, 191FAAG, 191FABG, 191FADG, 191FAE, 191FAG, 1A0FA1, 1A0FA2, 1A0FA4, 1A0FA5, 1A0FAA, 1A0FAB, 1A1FA1G, 1A1FA2G, 1A1FA4G, 1A1FA5G, 1A1FAAG, 1A1FABG, 1D0FA1, 1D0FA2, 1D0FA4, 1D0FA5, 1D0FAA, 1D0FAB, 1D1FA1G, 1D1FA2G...(Other models you can see in the webshop)		

GEV No.	528223	Ref. No.	3152100
description	O-ring EPDM thickness 2.62mm ID ø 11.91mm Qty 1 pcs		

GEV No.	518227	Ref. No.	N/A
description	O-ring EPDM thickness 2.62mm ID ø 12.37mm Qty 1 pcs		

GEV No.	528333	Ref. No.	3152410
description	O-ring EPDM thickness 2.62mm ID ø 13.1mm Qty 1 pcs		
For models:	LC80		

GEV No.	516026	Ref. No.	3186287
description	O-ring EPDM thickness 2.62mm ID ø 17.86mm Qty 1 pcs		

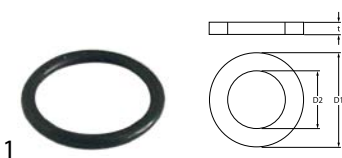

GEV No.	504590	Ref. No.	3152170
description	O-ring EPDM thickness 2.62mm ID ø 18.72mm Qty 1 pcs		
For models:	C165D, C165S, C165VD, C165VS, C207D, C207D-VERS.2006, C207S, C207S-VERS.2006, C207VD, C207VD-VERS.2006, C207VS, C207VS-VERS.2006, C304AD, C304AD-VERS.2006, C304AS, C304AS-VERS.2006, C304AVD, C304AVD-VERS.2006, C304AVS, C304AVS-VERS.2006, C304D, C304D-VERS.2006, C304S, C304S-VERS.2006, C304VD, C304VD-VERS.2006, C304VS, C304VS-VERS.2006, C92D-VERS.2006, C92S-VERS.2006, C92VD-VERS.2006, C92VS-VERS.2006, CS243D, CS243D-VERS.2006, CS243S, CS243S-VERS.2006, CS243VD, CS243VD-VERS.2006, CS243VS, CS243VS-VERS.2006, CS370AD, CS370AD-VERS.2006, CS370AS, CS370AS-VERS.2006, CS370AVD, CS370AVD-VERS.2006, CS370AVS, CS370AVS-VERS.2006, CS370D, CS370D-VERS.2006...(Other models you can see in the webshop)		

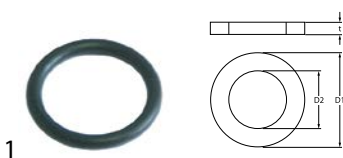

GEV No.	511518	Ref. No.	3150520
description	O-ring EPDM thickness 3.53mm ID ø 23.4mm Qty 10 pcs		
For models:	F60P, F60PR, F80PR, L45		

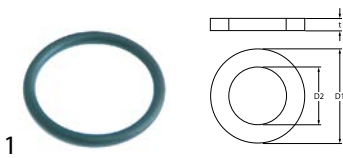

GEV No.	511524	Ref. No.	3150260
description	O-ring EPDM thickness 3.53mm ID ø 32.93mm Qty 10 pcs		
For models:	L100, L40, L40S, L60, L80		

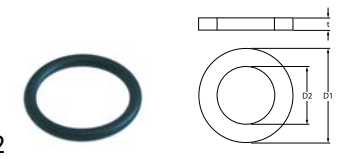

GEV No.	511512	Ref. No.	3150410
description	O-ring EPDM thickness 2.62mm ID ø 18.72mm Qty 10 pcs		
For models:	090BME, 091BME, L100, L40, L40S, L60, L80, PGA20, PGA30, PGA40, PGA60, PGA80, PGW20, PGW30, PGW40, PGW60, PGW80		

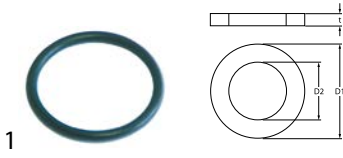

GEV No.	511526	Ref. No.	3150010
description	O-ring EPDM thickness 3.53mm ID ø 36.1mm Qty 10 pcs		
For models:	F60P, F60PR, F60T, F80P, F80PR, L40, L40S, L45, L60		

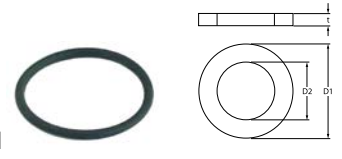

GEV No.	504561	Ref. No.	3151080
description	O-ring EPDM thickness 2.62mm ID ø 29.82mm Qty 1 pcs		
For models:	091FR1E, 091FR1EA, 091FR1ED, 091FR1G, 091FR1GD, 091FR1I, 091FR1IA, 091FR1ID, 091FR1ID-VERS.052012, 091FR1I-VERS.032012, 091FR7G, 091FR7G-VERS.052012, 0A1FR1E, 0A1FR1ED, 0A1FR1G, 0A1FR1GD, 0A1FR1GD-VERS.2004, 0A1FR1G-VERS.2004, 0B1FR1G, 0B1FR1GD, 0D1FR1E, 0D1FR1ED, 0D1FR1G, 0D1FR1GD, 0D1FR1GD-VERS.2004, 0D1FR1G-VERS.2004, 191FR2E, 191FR2ED, 191FR2G, 191FR2GD, 191FR2I, 191FR2ID, 191FR2ID-VERS.092012, 191FR2I-VERS.032012, 1A1FR2E, 1A1FR2ED, 1A1FR2G, 1A1FR2GD, 1A1FR2GD-VERS.2004, 1A1FR2G-VERS.2004, 1D1FR2ED, 1D1FR2G, 1D1FR2GD, 1D1FR2GD-VERS.2004, 1D1FR2G-VERS.2004, 70F1, 70F1B, 70FE1, 70FE1B, 71F2...(Other models you can see in the webshop)		

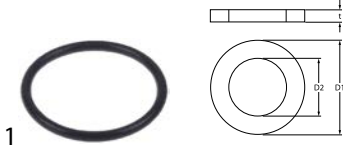

GEV No.	519179	Ref. No.	3151930
description	O-ring EPDM thickness 3.53mm ID ø 41.28mm Qty 1 pcs		
For models:	C165D, C165S, C165VD, C165VS, C207D, C207D-VERS.2006, C207S, C207S-VERS.2006, C207VD, C207VD-VERS.2006, C207VS, C207VS-VERS.2006, C304AD, C304AD-VERS.2006, C304AS, C304AS-VERS.2006, C304AVD, C304AVD-VERS.2006, C304AVS, C304AVS-VERS.2006, C304D, C304D-VERS.2006, C304S, C304S-VERS.2006, C304VD, C304VD-VERS.2006, C304VS, C304VS-VERS.2006, C92D-VERS.2006, C92S-VERS.2006, C92VD-VERS.2006, C92VS-VERS.2006, CS243D, CS243D-VERS.2006, CS243S, CS243S-VERS.2006, CS243VD, CS243VD-VERS.2006, CS243VS, CS243VS-VERS.2006, CS370AD, CS370AD-VERS.2006, CS370AS, CS370AS-VERS.2006, CS370AVD, CS370AVD-VERS.2006, CS370AVS, CS370AVS-VERS.2006, CS370D, CS370D-VERS.2006...(Other models you can see in the webshop)		

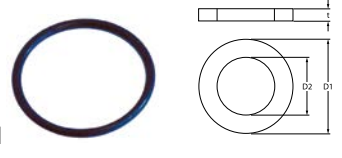

GEV No.	532064	Ref. No.	3150140
description	O-ring EPDM thickness 2.62mm ID ø 32.99mm Qty 10 pcs		
For models:	L100, L40, L40S, L60, L80		

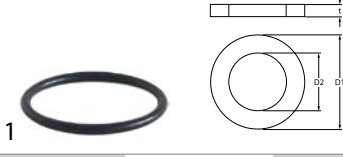



GEV No.	532109	Ref. No.	3150360
description	O-ring EPDM thickness 3.53mm ID ø 42.86mm Qty 10 pcs		

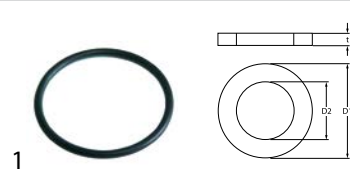

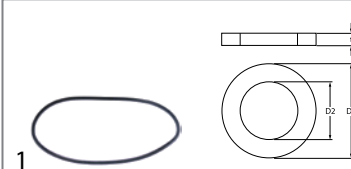
			
GEV No.	532114	Ref. No.	3150240
description	O-ring EPDM thickness 3.53mm ID ø 50.8mm Qty 10 pcs		
For models:	L100, L40, L40S, L60, L80		

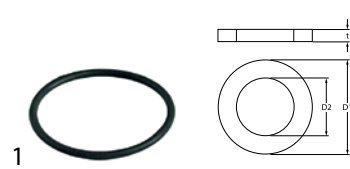
			
GEV No.	510551	Ref. No.	3FL1123
description	pump cover gasket ID ø 158.3mm pump type 1214/1293/1225/2243/1226/1204/3473/1241 thickness 3.53mm EPDM Qty 1 pcs		

			
GEV No.	511331	Ref. No.	3152390
description	O-ring EPDM thickness 3.53mm ID ø 53.57mm Qty 1 pcs		

<p>silicone</p> 			
GEV No.	532521	Ref. No.	3152370
description	O-ring silicone thickness 1.78mm ID ø 34.65mm Qty 1 pcs		
For models:	04WFAAV, 08WFA4E, 08WFA4G, 08WFAAE, 08WFAAG, 08WFAAV, 090FAA, 0A0FA1, 0A0FA4, 0A0FAA, 0D0FA1, 0D0FA4, 0D0FAA, 0G0FA0, 12WFA6E, 12WFA6G, 12WFAAA, 12WFAAE, 12WFAAG, 12WFAAN, 190FA, 190FAA, 190FAB, 190FAD, 191FAAE, 191FAAG, 191FABG, 191FADG, 191FAE, 191FAG, 1A0FA1, 1A0FA2, 1A0FA4, 1A0FA5, 1A0FAA, 1A0FAB, 1A1FA1G, 1A1FA2G, 1A1FA4G, 1A1FA5G, 1A1FAAG, 1A1FABG, 1D0FA1, 1D0FA2, 1D0FA4, 1D0FA5, 1D0FAA, 1D0FAB, 1D1FA1G, 1D1FA2G...(Other models you can see in the webshop)		

			
GEV No.	521120	Ref. No.	3035850 3152160
description	O-ring EPDM thickness 5.34mm ID ø 37.47mm Qty 1 pcs		
For models:	C165D, C165S, C165VD, C165VS, C207D, C207D-VERS.2006, C207S, C207S-VERS.2006, C207VD, C207VS, C304AD, C304AD-VERS.2006, C304AS, C304AS-VERS.2006, C304AVD, C304AVS, C304D, C304D-VERS.2006, C304S, C304S-VERS.2006, C304VD, C304VS, C92D-VERS.2006, C92S-VERS.2006, CS243D, CS243D-VERS.2006, CS243S, CS243S-VERS.2006, CS243VD, CS243VS, CS370AD, CS370AD-VERS.2006, CS370AS, CS370AS-VERS.2006, CS370AVD, CS370AVS, CS370D, CS370D-VERS.2006, CS370S, CS370S-VERS.2006, CS370VD, CS370VS, CS466AD, CS466AD-VERS.2006, CS466AS, CS466AS-VERS.2006, CS466AVD, CS466AVS, CS466D, CS466D-VERS.2006...(Other models you can see in the webshop)		

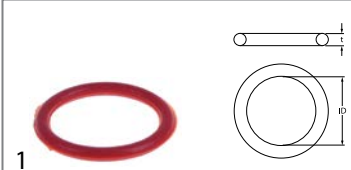
			
GEV No.	532541	Ref. No.	3152040
description	O-ring silicone thickness 1.78mm ID ø 47.35mm Qty 1 pcs		
For models:	04WFAAV, 08WFA4E, 08WFA4G, 08WFAAE, 08WFAAG, 08WFAAV, 090FAA, 0A0FA1, 0A0FA4, 0A0FAA, 0D0FA1, 0D0FA4, 0D0FAA, 0G0FA0, 12WFA6E, 12WFA6G, 12WFAAA, 12WFAAE, 12WFAAG, 12WFAAN, 190FA, 190FAA, 190FAB, 190FAD, 191FAAE, 191FAAG, 191FABG, 191FADG, 191FAE, 191FAG, 1A0FA1, 1A0FA2, 1A0FA4, 1A0FA5, 1A0FAA, 1A0FAB, 1A1FA1G, 1A1FA2G, 1A1FA4G, 1A1FA5G, 1A1FAAG, 1A1FABG, 1D0FA1, 1D0FA2, 1D0FA4, 1D0FA5, 1D0FAA, 1D0FAB, 1D1FA1G, 1D1FA2G...(Other models you can see in the webshop)		

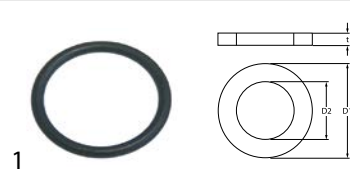
			
GEV No.	510408	Ref. No.	3152650
description	O-ring EPDM thickness 5.34mm ID ø 47mm Qty 1 pcs		

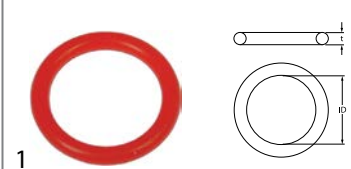
			
GEV No.	532520	Ref. No.	3150390
description	O-ring silicone thickness 2.62mm ID ø 15.08mm Qty 1 pcs		
For models:	030BME, 030FE, 031BME, 070BM, 070BME, 071BM, 071BME, 090BM, 090BME, 091BM, 091BME, 1A1PI1G, 1A1PI1GA, 1D1PI1G, 1D1PI1GA, 1G1PI1G, 30F, 30FES, 30FS, 31PI6, 70F, 70FE, 70FES, 71F, 71FE, 71PI10, 71PI10A, 91PI10, 91PI10A		

			
GEV No.	510409	Ref. No.	3150430 3151960 37Q5260
description	O-ring EPDM thickness 5.34mm ID ø 56.52mm Qty 1 pcs		
For models:	091CP1E, 0A1CP1E, 0G1CP1E, 0G1CP1EC, 0G1CP1E-VERS.2004, 191PI2E, 191PI2EA, 1A1PI2E, 1A1PI2EA, 1D1PI2E, 1D1PI2EA, 1G1PI1E, 30CPSE, 31PIE6, 6040090, 6040310, 6043850, 6043980, 70CPE, 71PIE15, 71PIE15A, 90CPE, 91PIE15, 91PIE15A, F60P, F60PR, F60T, F80P, F80PR, KD100, KD100A, KD100PSD, KD130, KD130A, KD130E, KD130EAT, KD60, KD60E, KD60EAT, KD60M, KD60MA, KD60ME, KD60MPS, KD60MPSA, KD60PS, KD60PSD, KD6EATSD, KD85, KD85A, KD85E...(Other models you can see in the webshop)		



GEV No.	532519	Ref. No.	3152331
description	O-ring silicone thickness 5.34mm ID ø 53.34mm Qty 1 pcs		
For models:	191CP1GA, 191PD1G, 191PD2G, 191PI1G, 191PI1GA, 191PI2E, 191PI2EA, 191PI2G, 191PI2GA, 191PI2V, 191PI2VA, 1A1CP1GA, 1A1PD1G, 1A1PD2G, 1A1PI1G, 1A1PI1GA, 1A1PI2E, 1A1PI2EA, 1A1PI2G, 1A1PI2GA, 1A1PI2V, 1A1PI2VA, 1D1CP1GA, 1D1PD1G, 1D1PD2G, 1D1PI1G, 1D1PI1GA, 1D1PI2E, 1D1PI2EA, 1D1PI2G, 1D1PI2GA, 1D1PI2V, 1D1PI2VA, 1G1PD1G, 1G1PI1E, 1G1PI1G, 291PD3G, 291PI3E, 291PI3G, 2A1PD3G, 2A1PI3E, 2A1PI3G, 2D1PI3G, PV200, PV200A, PV300, PV300A		

Viton

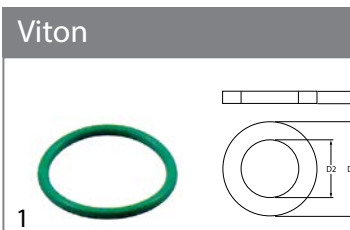

GEV No.	532487	Ref. No.	3150690
description	O-ring Viton thickness 2.62mm ID ø 25.07mm Qty 1 pcs		
For models:	04WFR3ED, 06WFR3GD, 08WFR4ED, 091FE28, 091FE28B, 091FR3E, 091FR3ED, 091FR3G, 091FR3GD, 0A1FR3E, 0A1FR3ED, 0A1FR3G, 0A1FR3GD, 0D1FR3E, 0D1FR3ED, 0D1FR3G, 0D1FR3GD, 0G1FR3G, 0G1FR3GD, 0G1FR7G, 10WFR4GD, 191FR4E, 191FR4ED, 191FR4G, 191FR4GD, 1A1FR4E, 1A1FR4ED, 1A1FR4G, 1A1FR4GD, 1D1FR4E, 1D1FR4ED, 1D1FR4G, 1D1FR4GD, 1G1FR4G, 1G1FR4GD, 1G1FR8G, 30F1, 30F1B, 30FES2, 30FES2B, 30FS2, 30FS2B, 70FES2, 70FES2B, 90F110B, 91F210, 91F210B, FC1011G, FC1221G, FC611G...(Other models you can see in the webshop)		

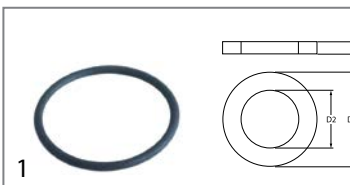

GEV No.	550494	Ref. No.	3152150 3152151
description	O-ring Viton thickness 3.53mm ID ø 47.22mm Qty 1 pcs		
For models:	0A1FR1E, 0A1FR1ED, 0D1FR1E, 0D1FR1ED, 1A1FR2E, 1A1FR2ED, 1D1FR2ED		

NBR

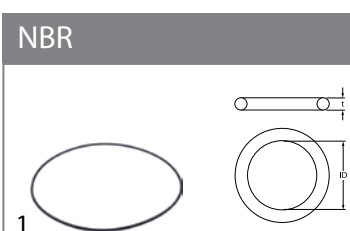

GEV No.	532609	Ref. No.	3151750
description	O-ring NBR thickness 7mm ID ø 387mm Qty 1 pcs		
For models:	LCV, P10, P102, P10M, P20, P202, P5		

HNBR

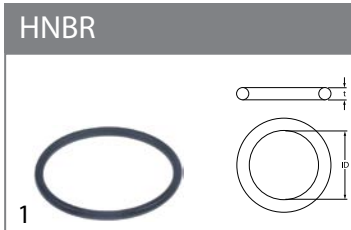

GEV No.	526272	Ref. No.	3152151
description	O-ring HNBR thickness 3.53mm ID ø 47.22mm Qty 1 pcs		

sealing washers

fibre gaskets



GEV No.	517173	Ref. No.	37Q5130
description	flat gasket FIBER ED ø 14mm ID ø 8mm thickness 1.5mm Qty 1 pcs		



GEV No.	506071	Ref. No.	37Q2340
description	flat gasket FIBER ED ø 25mm ID ø 18mm thickness 2mm Qty 1 pcs		





GEV No.	510123	Ref. No.	37Q4070
description	flat gasket FIBER ED ø 60mm ID ø 46mm thickness 2mm Qty 1 pcs		
For models:	191PD1G, 191PD2G, 191PI1G, 191PI1GA, 191PI2E, 191PI2EA, 191PI2G, 191PI2GA, 191PI2V, 191PI2VA, 1A1PI2G, 1A1PI2GA, 1D1PI2G, 1D1PI2GA, MCF20, MCF40, PV200, PV200A, PV300, PV300A		



GEV No.	510405	Ref. No.	N/A
description	flat gasket fibre ED ø 56mm ID ø 42mm thickness 2mm for thread 1/4" Qty 1 pcs		





rubber gaskets			
			
1			
GEV No.	505405	Ref. No.	3045960
description	flat gasket NBR ED ø 58mm ID ø 40mm thickness 3mm drain		
For models:	BX101E, BX101E-VERS.122013, BX101G, BX101G-VERS.122013, BX122E, BX122E-VERS.122013, BX122G, BX122G-VERS.122013, BX61E, BX61E-VERS.122013, BX61G, BX61G-VERS.122013, BX82E, BX82E-VERS.122013, BX82G, BX82G-VERS.122013, FC1011E, FC1011G, FC1221E, FC1221G, FC611E, FC611G, FM1011E1, FM1011E1-VERS.2006, FM1011E2, FM1011E2-VERS.2006, FM1011E3, FM1011E3-VERS.2006, FM1011G1, FM1011G1-VERS.2006, FM1011G2, FM1011G2-VERS.2006, FM1011G3, FM1011G3-VERS.2006, FM1221E1, FM1221E1-VERS.2006, FM1221E2, FM1221E2-VERS.2006, FM1221E3, FM1221E3-VERS.2006, FM1221G1, FM1221G1-VERS.2006, FM1221G2, FM1221G2-VERS.2006, FM1221G3, FM1221G3-VERS.2006, FM2011E2-VERS.2006, FM2011E3-VERS.2006, FM2011G2-VERS.2006, FM2011G3-VERS.2006...(Other models you can see in the webshop)		

			
2			
GEV No.	520054 ¹	Ref. No.	3152480
description	flat gasket rubber ED ø 23.5mm ID ø 14mm thickness 2.3mm Qty 10 pcs		

¹Qty 10 pieces

			
1			
GEV No.	519114	Ref. No.	3151890
description	flat gasket rubber ED ø 25mm ID ø 16.5mm thickness 2mm Qty 1 pcs		
For models:	C165D, C165S, C165VD, C165VS, C207D, C207D-VERS.2006, C207S, C207S-VERS.2006, C207VD, C207VD-VERS.2006, C207VS, C207VS-VERS.2006, C304AD, C304AD-VERS.2006, C304AS, C304AS-VERS.2006, C304AVD, C304AVD-VERS.2006, C304AVS, C304AVS-VERS.2006, C304D, C304D-VERS.2006, C304S, C304S-VERS.2006, C304VD, C304VD-VERS.2006, C304VS, C304VS-VERS.2006, C92D-VERS.2006, C92S-VERS.2006, C92VD-VERS.2006, C92VS-VERS.2006, CS243D, CS243D-VERS.2006, CS243S, CS243S-VERS.2006, CS243VD, CS243VD-VERS.2006, CS243VS, CS243VS-VERS.2006, CS370AD, CS370AD-VERS.2006, CS370AS, CS370AS-VERS.2006, CS370AVD, CS370AVD-VERS.2006, CS370AVS, CS370AVS-VERS.2006, CS370D, CS370D-VERS.2006...(Other models you can see in the webshop)		

			
1			
GEV No.	507360	Ref. No.	3150060
description	flat gasket rubber ED ø 30mm ID ø 21mm thickness 2mm Qty 1 pcs		
For models:	L100, L80		

			
1			
GEV No.	519341	Ref. No.	3151980
description	flat gasket rubber ED ø 40mm ID ø 5.5mm thickness 2mm Qty 1 pcs		
For models:	C165D, C165S, C165VD, C165VS, C207D, C207D-VERS.2006, C207S, C207S-VERS.2006, C207VD, C207VD-VERS.2006, C207VS, C207VS-VERS.2006, C304AD, C304AD-VERS.2006, C304AS, C304AS-VERS.2006, C304AVD, C304AVD-VERS.2006, C304AVS, C304AVS-VERS.2006, C304D, C304D-VERS.2006, C304S, C304S-VERS.2006, C304VD, C304VD-VERS.2006, C304VS, C304VS-VERS.2006, C92D-VERS.2006, C92S-VERS.2006, C92VD-VERS.2006, C92VS-VERS.2006, CS243D, CS243D-VERS.2006, CS243S, CS243S-VERS.2006, CS243VD, CS243VD-VERS.2006, CS243VS, CS243VS-VERS.2006, CS370AD, CS370AD-VERS.2006, CS370AS, CS370AS-VERS.2006, CS370AVD, CS370AVD-VERS.2006, CS370AVS, CS370AVS-VERS.2006, CS370D, CS370D-VERS.2006...(Other models you can see in the webshop)		

			
1			
GEV No.	517181	Ref. No.	3030160
description	flat gasket rubber ED ø 44mm ID ø 32mm thickness 3mm Qty 1 pcs		
For models:	KD37, KD40, LP202, LP202HC, LP302, LP302HC, LP402, LP402HC, LP402V, N100D, N100S, N100VD, N100VS, N38D, N38S, N38VD, N38VS, N42D, N42S, N42VD, N42VS, N50D, N50S, N50VD, N50VS, N66D, N66S, N66VD, N66VS, N70D, N70S, N70VD, N70VS, N85D, N85S, N85VD, N85VS		

			
1			
GEV No.	511435	Ref. No.	37Q3420
description	flat gasket rubber ED ø 47mm ID ø 39mm thickness 2mm Qty 1 pcs		

			
1			
GEV No.	519117	Ref. No.	37Q4220
description	flat gasket rubber ED ø 60mm ID ø 47mm thickness 3mm Qty 1 pcs		

			
1			
GEV No.	519118	Ref. No.	37Q4190
description	flat gasket rubber ED ø 70mm ID ø 52mm thickness 3mm Qty 1 pcs		
For models:	LF50, LF50E, LF50EM, LF50EMPS, LF50EMPS-VERS.122012, LF50EM-VERS.122012, LF50E-VERS.122012, LF50E-VERS.2007, LP70		

			
1			
GEV No.	511318	Ref. No.	37Q1580
description	flat gasket rubber ED ø 75mm ID ø 59mm thickness 2mm Qty 1 pcs		
For models:	KSV25P, KSV325P		



GEV No.	510680	Ref. No.	37Q4210
description	flat gasket rubber ED ø 82mm ID ø 62mm thickness 2mm Qty 1 pcs		
For models:	LC100, LC100-VERS.2001, LC130, LC130-VERS.2001		



GEV No.	519383	Ref. No.	3150290
description	gasket rubber ED ø 110mm ID ø 83mm thickness 3mm Qty 1 pcs		
For models:	F60P, F60PR, F60T, F80P, F80PR, L45		

plastic gaskets



GEV No.	504435	Ref. No.	3152010
description	flat gasket plastic ED ø 18mm ID ø 9.5mm thickness 2.5mm for door hinge Qty 1 pcs		

copper gaskets

DIN-7603-A



GEV No.	506411	Ref. No.	3151730
description	flat gasket copper ED ø 32.9mm ID ø 27mm thickness 1.5mm		
For models:	FC101, FC101E, FC241E, FC241G, FC61, FC61E, FCV101, FCV101-CSA, FCV101DM, FCV101DM-CSA, FCV101DS, FCV101DS-CSA, FCV101E, FCV101EDM, FCV101EDM-UL, FCV101EDS, FCV101EDS-UL, FCV101E-UL, FCV141, FCV141-CSA, FCV141DM, FCV141DM-CSA, FCV141DS, FCV141DS-CSA, FCV141E, FCV141EDM, FCV141EDS, FCV241E, FCV241EDM, FCV241EDM-UL, FCV241EDS, FCV241EDS-UL, FCV241E-UL, FCV241G, FCV241G-CSA, FCV241GDM, FCV241GDM-CSA, FCV241GDS, FCV241GDS-CSA, FCV3EM, FCV401DM, FCV401DM-CSA, FCV401EDM, FCV401EDM-UL, FCV4E, FCV4EDS, FCV4EM, FCV61, FCV61-CSA, FCV61DM...(Other models you can see in the webshop)		

silicone gaskets



GEV No.	694916	Ref. No.	36E3320
description	gasket silicone ED ø 45mm ID ø 34mm thickness 5mm		
For models:	BX101E, BX101E-VERS.122013, BX101G, BX101G-VERS.122013, BX122E, BX122E-VERS.122013, BX122G, BX122G-VERS.122013, BX61E, BX61E-VERS.122013, BX61G, BX61G-VERS.122013, BX82E, BX82E-VERS.122013, BX82G, BX82G-VERS.122013, FC1011E, FC1011G, FC1221E, FC1221G, FC611E, FC611G, FM1011E1, FM1011E1-VERS.2006, FM1011E2, FM1011E2-VERS.2006, FM1011E3, FM1011E3-VERS.2006, FM1011G1, FM1011G1-VERS.2006, FM1011G2, FM1011G2-VERS.2006, FM1011G3, FM1011G3-VERS.2006, FM1221E1, FM1221E1-VERS.2006, FM1221E2, FM1221E2-VERS.2006, FM1221E3, FM1221E3-VERS.2006, FM1221G1, FM1221G1-VERS.2006, FM1221G2, FM1221G2-VERS.2006, FM1221G3, FM1221G3-VERS.2006, FM2011E2-VERS.2006, FM2011E3-VERS.2006, FM2011G2-VERS.2006, FM2011G3-VERS.2006...(Other models you can see in the webshop)		

foam rubber gaskets



GEV No.	901678	Ref. No.	3022960
description	foam rubber gasket Qty 1200mm incl. adhesive for lid		
For models:	DP10		

shaft gaskets

shaft gaskets



GEV No.	520473	Ref. No.	3004400
description	gasket		
For models:	FC1011E, FC1011G, FC1221E, FC1221G, FC611E, FC611G, FM1011E1, FM1011E1-VERS.2006, FM1011E2, FM1011E2-VERS.2006, FM1011E3, FM1011E3-VERS.2006, FM1011G1, FM1011G1-VERS.2006, FM1011G2, FM1011G2-VERS.2006, FM1011G3, FM1011G3-VERS.2006, FM1221E1, FM1221E1-VERS.2006, FM1221E2, FM1221E2-VERS.2006, FM1221E3, FM1221E3-VERS.2006, FM1221G1, FM1221G1-VERS.2006, FM1221G2, FM1221G2-VERS.2006, FM1221G3, FM1221G3-VERS.2006, FM2011E2-VERS.2006, FM2011E3-VERS.2006, FM2011G2-VERS.2006, FM2011G3-VERS.2006, FM2021E1, FM2021E2, FM2021E2-VERS.2006, FM2021E3, FM2021E3-VERS.2006, FM2021G1, FM2021G2, FM2021G2-VERS.2006, FM2021G3, FM2021G3-VERS.2006, FM611E1, FM611E1-VERS.2006, FM611E2, FM611E2-VERS.2006, FM611E3, FM611E3-VERS.2006...(Other models you can see in the webshop)		



GEV No.	550685	Ref. No.	3151670
description	shaft seal ID ø 12mm ED ø 32mm thickness 7mm		
For models:	FCV3EM, FCV4E, FCV4EDS, FCV4EM		



GEV No.	698207	Ref. No.	3FL1137
description	shaft seal ID ø 30mm ED ø 40mm thickness 7mm		



special gaskets

for combi-steamers



1

GEV No.	505405	Ref. No.	3045960
description	flat gasket NBR ED ø 58mm ID ø 40mm thickness 3mm drain		
For models:	BX101E, BX101E-VERS.122013, BX101G, BX101G-VERS.122013, BX122E, BX122E-VERS.122013, BX122G, BX122G-VERS.122013, BX61E, BX61E-VERS.122013, BX61G, BX61G-VERS.122013, BX82E, BX82E-VERS.122013, BX82G, BX82G-VERS.122013, FC1011E, FC1011G, FC1221E, FC1221G, FC611E, FC611G, FM1011E1, FM1011E1-VERS.2006, FM1011E2, FM1011E2-VERS.2006, FM1011E3, FM1011E3-VERS.2006, FM1011G1, FM1011G1-VERS.2006, FM1011G2, FM1011G2-VERS.2006, FM1011G3, FM1011G3-VERS.2006, FM1221E1, FM1221E1-VERS.2006, FM1221E2, FM1221E2-VERS.2006, FM1221E3, FM1221E3-VERS.2006, FM1221G1, FM1221G1-VERS.2006, FM1221G2, FM1221G2-VERS.2006, FM1221G3, FM1221G3-VERS.2006, FM2011E2-VERS.2006, FM2011E3-VERS.2006, FM2011G2-VERS.2006, FM2011G3-VERS.2006...(Other models you can see in the webshop)		



1

GEV No.	699497	Ref. No.	3332580
description	gasket ED ø 92.5mm ID ø 51mm graphite thickness 2mm		



1

GEV No.	696776	Ref. No.	36E3780
description	gasket for heat exchanger L 50mm W 50mm flange ID ø 34mm thickness 1mm hole distance 40mm		
For models:	FM1011G1, FM1011G2, FM1011G3, FM1221G1, FM1221G2, FM1221G3, FM2021G1, FM2021G2, FM2021G3, FM611G1, FM611G2, FM611G3, FM721G1, FM721G2, FM721G3		



1

GEV No.	696779	Ref. No.	36E3400
description	gasket for heat exchanger L 60mm W 60mm flange ID ø 34mm thickness 3mm hole distance 40mm		
For models:	FC1011G, FC1221G, FC611G, FM1011G1, FM1011G1-VERS.2006, FM1011G2, FM1011G2-VERS.2006, FM1011G3, FM1011G3-VERS.2006, FM1221G1, FM1221G1-VERS.2006, FM1221G2, FM1221G2-VERS.2006, FM1221G3, FM1221G3-VERS.2006, FM2011G2-VERS.2006, FM2011G3-VERS.2006, FM2021G1, FM2021G2, FM2021G2-VERS.2006, FM2021G3, FM2021G3-VERS.2006, FM611G1, FM611G1-VERS.2006, FM611G2, FM611G2-VERS.2006, FM611G3, FM611G3-VERS.2006, FM721G1, FM721G1-VERS.2006, FM721G2, FM721G2-VERS.2006, FM721G3, FM721G3-VERS.2006		

door seals for dishwashers

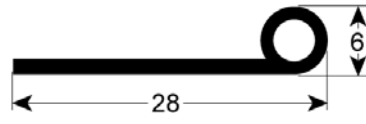

1

GEV No.	518234	Ref. No.	37Q3910
description	door seal L 450mm W 28mm H 6mm Qty 1 with 5 holes		
For models:	LT10R, LT20F, LT25F		

miscellaneous



1

GEV No.	901678	Ref. No.	3022960
description	foam rubber gasket Qty 1200mm incl. adhesive for lid		
For models:	DP10		



1

GEV No.	519385	Ref. No.	3150220
description	gasket for core temperature probe ED ø 8mm ID ø 4mm thickness 5mm		
For models:	FCV101DM, FCV101DM-CSA, FCV101DS, FCV101DS-CSA, FCV101EDM, FCV101EDM-UL, FCV101EDS, FCV101EDS-UL, FCV141DM, FCV141DM-CSA, FCV141DS, FCV141DS-CSA, FCV141EDM, FCV141EDS, FCV241DM, FCV241DS, FCV241EDM, FCV241EDM-UL, FCV241EDS, FCV241EDS-UL, FCV241GDM, FCV241GDM-CSA, FCV241GDS, FCV241GDS-CSA, FCV401DM, FCV401DM-CSA, FCV401EDM, FCV401EDM-UL, FCV4EDS, FCV61DM, FCV61DM-CSA, FCV61DS, FCV61DS-CSA, FCV61EDM, FCV61EDM-UL, FCV61EDS, FCV61EDS-UL, FCV72EDM-UL, FCV72EDS-UL, FM1011E2, FM1011E3, FM1011G2, FM1011G3, FM1221E2, FM1221E3, FM1221G2, FM1221G3, FM2021E2, FM2021E3, FM2021G2...(Other models you can see in the webshop)		



1

GEV No.	510847	Ref. No.	N/A
description	gasket polishing agent dosing ID ø 22mm ED ø 32mm external height 5mm		



1

GEV No.	541499	Ref. No.	3151450
description	gasket suitable for ANGELO PO size 1¼"		
For models:	FC101, FC1011E, FC1011G, FC101E, FC1221E, FC1221G, FC241, FC241E, FC241G, FC61, FC611E, FC611G, FC61E, FCV101, FCV101-CSA, FCV101DM, FCV101DM-CSA, FCV101DS, FCV101DS-CSA, FCV101E, FCV101EDM, FCV101EDM-UL, FCV101EDS, FCV101EDS-UL, FCV101E-UL, FCV141, FCV141-CSA, FCV141DM, FCV141DM-CSA, FCV141DS, FCV141DS-CSA, FCV141E, FCV141EDM, FCV141EDS, FCV241, FCV241DM, FCV241DS, FCV241E, FCV241EDM, FCV241EDM-UL, FCV241EDS, FCV241EDS-UL, FCV241E-UL, FCV241G, FCV241G-CSA, FCV241GDM, FCV241GDM-CSA, FCV241GDS, FCV241GDS-CSA, FCV401DM...(Other models you can see in the webshop)		



2

GEV No.	519384	Ref. No.	3150880
description	gasket thickness 3mm hole ø 40mm dimensions 100x100mm		



1

GEV No.	900854	Ref. No.	37Q4440
description	oven gasket L 332mm W 128mm mineral wool		
For models:	FPZ14E, FPZ16E, FPZ24E, FPZ2635E, FPZ26E, FPZ4G, FPZ6G		

thermostat gaskets



1

GEV No.	550492	Ref. No.	3152240
description	gasket for thermostat		
For models:	04WBMEV, 04WCP1EM, 04WVT1IV, 04WVT1IV-VERS.022010, 04WVT2IV, 04WVT2IV-VERS.022010, 04WVT3RV, 06WBR3E, 06WCP1GM, 06WFT1EV, 06WFT2EV, 06WFT3EV, 06WFT4EV, 06WFT6EV, 06WFT7EV, 08WCP1GM, 08WFA4E, 08WFAAE, 08WFT1EV, 08WFT2EV, 08WFT3EV, 08WFT4EV, 08WFT6EV, 08WFT7EV, 08WVT1IV, 08WVT1IV-VERS.112009, 08WVT2IV, 08WVT2IV-VERS.112009, 090FT1E, 090FT2E, 090FT4E, 090FT5E, 090FT7E, 090PE4, 090VT1I, 090VT1I-VERS.112010, 090VT1W, 090VT1W-VERS.102008, 090VTR, 091CP1E, 091FR1E, 091FR1ED, 091FR1G, 091FR1GD, 091FR1I, 091FR1I-VERS.032012, 091FR3ED, 091FR3G, 091FR3GD, 091FR7G...(Other models you can see in the webshop)		



1

GEV No.	510167	Ref. No.	3150270 315Q270
description	gasket for thermostat ED ø 41mm ID ø 18mm Qty ANGELO PO/ ZANUSSI pcs equiv. no. 3150270/66717		
For models:	030BME, 031BME		

gaskets for wash arm support



1

GEV No.	519445	Ref. No.	3150230
description	gasket D1 ø 80mm D2 ø 50mm thickness 3mm with 4 screw holes		
For models:	F60P, F60PR, F60T, F80P, F80PR, FCV61EDS, FCV61EDS-UL, L45, LF50E, LF50EM, LF50EMPS, LF50EMPS-VERS.122012, LF50EM-VERS.122012, LF50E-VERS.122012, LF50E-VERS.2007, LP70		

refrigeration cycle components

valves

expansion valves

DANFOSS

valves

type TS2/TE52



1

GEV No.	750520	Ref. No.	33A0500
description	expansion valve DANFOSS type TES2 coolant R404a/R507 angled 90° inlet 3/8" SAE outlet 12mm soldering connection 6mm soldering connection p max 34bar capillary pipe 1500mm		
For models:	IS102S, IS102SR, IS102SR-ONR01, IS102SW, SM2L, SM2LR, SM2LW, SM2S, SM2SR, SM2SW, SM3S, SM3SR, SM4SR		



1

GEV No.	750304	Ref. No.	33A0870
description	expansion valve DANFOSS type TES2 coolant R404a/R507 angled 90° thermostatically controlled inlet 3/8" SAE outlet 12mm soldering connection 6mm soldering connection p max 34bar -40 up to +10°C capillary pipe 1500mm		
For models:	ART2LD, ART2SD, ART3SD, GR4A-ONR01, IA101L, IA101S, IA72S, XA101L, XA101S, XA72S		



filter driers

miscellaneous



GEV No.	750177	Ref. No.	33A0180
description	dryer ø 24mm L 155mm connection 6,3/6,3mm		
For models:	120, 120NN, 120PV, 135, 135-4, 135A, 135BN, 135BNX, 135CPX, 135NN, 135NNX, 135PVX, 135X, 135X-3, 135X-4, 135XE, 3G6SA, 3G6SA2, 3G6SA4, 40, 40-OPR01, 40B, 40B-OPR01, 40BX-OPR01, 40CP, 40CP-OPR01, 40CPX, 40CPX-OPR01, 40EV, 40EV-OPR01, 40EVP, 40PL, 40PV, 40PV-OPR01, 40X, 40X-OPR01, 40XPV, 4G6SB, 4G6SB2, 4G6SB4, 4G6SB6, 55, 55B, 55PV, 65, 65A, 65B, 65BA, 65BX, 65BX-2...(Other models you can see in the webshop)		



GEV No.	750058	Ref. No.	33A1150
description	dryer ø 24mm L 158mm connection 3.1/6.3mm		
For models:	120PV, 55, 55PV, TVRV		

evaporators

for fridges

producer-specific



GEV No.	750248	Ref. No.	34E0640
description	evaporator complete with fan		
For models:	MX120, MX130, MX140, MX150		

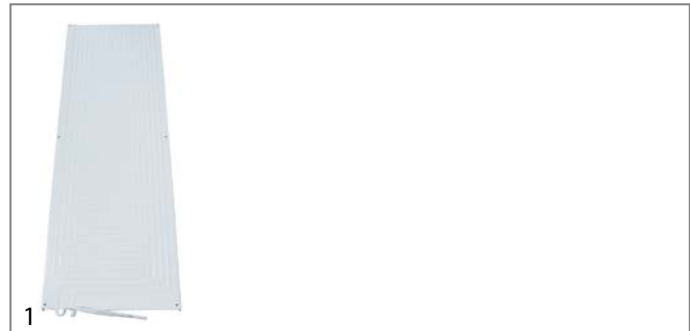

GEV No.	750049	Ref. No.	34D0360
description	evaporator L 1340mm W 430mm H 5mm type		
For models:	120, 120NN, 120PV, 55, 55PV		



GEV No.	750247	Ref. No.	32Z3420
description	evaporator L 255mm H 255mm W 50mm		
For models:	6BEA11A, 6BEA11B, 6BEA11M, 6BEA11Z, 6BEA2A, 6BEA2B, 6BEA2M, 6BEA2Z, 6BEA3A, 6BEA3B, 6BEA3M, 6BEA3Z, 6BEAA, 6BEAB, 6BEAM, 6BEAZ, 6BEB11A, 6BEB11B, 6BEB11M, 6BEB11Z, 6BEB22A, 6BEB22B, 6BEB22M, 6BEB22Z, 6BEB2A, 6BEB2B, 6BEB2M, 6BEB2Z, 6BEB3A, 6BEB3B, 6BEB3M, 6BEB3Z, 6BEB4A, 6BEB4B, 6BEB4M, 6BEB4Z, 6BEBA, 6BEBB, 6BEBM, 6BEBZ, 6BMA11A, 6BMA11B, 6BMA11M, 6BMA11Z, 6BMA2A, 6BMA2B, 6BMA2M, 6BMA2Z, 6BMA3A, 6BMA3B...(Other models you can see in the webshop)		

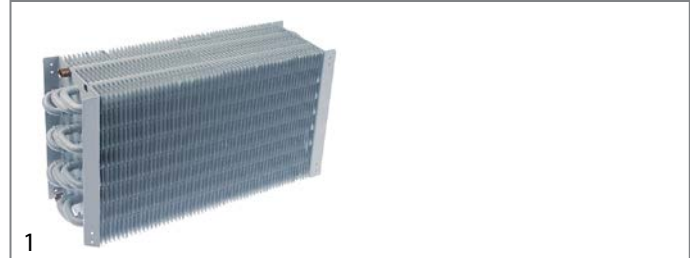

GEV No.	750230	Ref. No.	34D3390
description	evaporator L 360mm W 110mm H 200mm		
For models:	6BEA11A, 6BEA11B, 6BEA11M, 6BEA2A, 6BEA2B, 6BEA2M, 6BEA3A, 6BEA3B, 6BEA3M, 6BEAA, 6BEAB, 6BEAM, 6BMA11A, 6BMA11B, 6BMA11M, 6BMA2A, 6BMA2B, 6BMA2M, 6BMA3A, 6BMA3B, 6BMA3M, 6BMAA, 6BMAB, 6BMAM, 6RMA2A, 6RMA2B, 6RMA2M, 6RMA2Z, 6RMAA, 6RMAB, 6RMAM, 6RMAZ, 6RMB2A, 6RMB2B, 6RMB2M, 6RMB2Z, 6RMB4A, 6RMB4B, 6RMB4M, 6RMB4Z, 6RMBA, 6RMBB, 6RMBM, 6RMBZ, BE1A, BE1A-11, BE1A-2, BE1A-3, BM1A, BM1A-11...(Other models you can see in the webshop)		



1

GEV No.	750118	Ref. No.	34D4260
description	evaporator L 410mm W 90mm H 130mm		
For models:	CX120NN, CX130NN, CX140BN, CX140CP, CX140NN, CX150BN, CX150CP, CX150NN, CX55, CX60, CX65, CX652, CX65NB, CX65NCP, CX65NN, CX65PV, CX70, CX702, CX70NB, CX70NN, CX70PV, CX70R, ISFEN, S60, S60-2, S60E, S60X, S60X-2		



1

GEV No.	750658	Ref. No.	34E2930
description	evaporator L 415mm W 105mm H 330mm		
For models:	6EB, 6EB11, 6EB11A, 6EB11M, 6EB13, 6EB13A, 6EB13M, 6EB2, 6EB22, 6EB22A, 6EB22M, 6EB2A, 6EB2M, 6EB4, 6EB4A, 6EB4M, 6EBA, 6EBM, 6EC, 6EC11, 6EC11A, 6EC11M, 6EC13, 6EC13A, 6EC13M, 6EC2, 6EC22, 6EC22A, 6EC22M, 6EC2A, 6EC2M, 6EC4, 6EC4A, 6EC4M, 6ECA, 6ECM, 6ERB, 6ERB2, 6ERB2A, 6ERB2M, 6ERB4, 6ERB4A, 6ERB4M, 6ERBA, 6ERBM, 6ERC, 6ERC2, 6ERC2A, 6ERC2M, 6ERC4...(Other models you can see in the webshop)		



1

GEV No.	750069	Ref. No.	34D7670
description	evaporator L 420mm W 47mm H 300mm		
For models:	6JA, 6JA2, 6JA2A, 6JA2M, 6JAA, 6JAM, 6JB, 6JB2, 6JB2A, 6JB2M, 6JB4A, 6JB4M, 6JBA, 6JBM		



1

GEV No.	750000	Ref. No.	34D4300
description	evaporator L 730mm W 90mm H 130mm		
For models:	CX120, CX130, CX140, CX140PV, CX150, CX150PV, CX150R, S125, S125-4, S125E, S125X, S125X-4		

condensors

condensors



1

GEV No.	605131	Ref. No.	34D4831
description	condenser W 260mm D 110mm H 260mm		
For models:	135XE, 55B, 65BA, 65BXE, CX60B, DS31, DS31A, DS31C, DS31M, FX70B, MX60B, MX70B, S125, S125X, S600B, S600B2, S600BE, S60BE, SM03LT7, SM03LT7A, SM03LT7M, SP120BN, SP55B, VS31, VS31M		



1

GEV No.	750543	Ref. No.	34d6180
description	condenser W 275mm D 100mm H 260mm		
For models:	135BN, 135BNX, 135CPX, 55, 55PV, 65, 65A, 65PVX, 65X, 65X-2, 65XE, 6FMB11A, 6FMB11B, 6FMB11M, 6FMB11Z, 6FMB2A, 6FMB2B, 6FMB2M, 6FMB2Z, 6FMB4A, 6FMB4B, 6FMB4M, 6FMB4Z, 6FMB4A, 6FMB4B, 6FMB4M, 6FMB4Z, 6FMB4A, 6FMB4B, 6FMB4M, 6FMB4Z, 6FMC11A, 6FMC11B, 6FMC11M, 6FMC11Z, 6FMC2A, 6FMC2B, 6FMC2M, 6FMC2Z, 6FMC4A, 6FMC4B, 6FMC4M, 6FMC4Z, 6FMC4A, 6FMC4B, 6FMC4M, 6FMC4Z, 6JB, 6JB2, 6JB2A, 6JB2M, 6JB4A, 6JB4M, 6JBA...(Other models you can see in the webshop)		



evaporation and condensing trays

evaporation trays

			
1			
GEV No.	750716	Ref. No.	36Z0300
description	evaporation tray L 610mm W 295mm H 50mm		
For models:	120, 120B, 120NN, 120PV, 135, 135-4, 135A, 135B, 135BA, 135BN, 135BNX, 135BX, 135BXE, 135BXR, 135CPX, 135NN, 135NNX, 135PVX, 135X, 135X-3, 135X-4, 135XE, 135XR, 55, 55B, 55PV, 65, 65A, 65B, 65BA, 65BX, 65BX-2, 65BXE, 65BXR, 65NB, 65NBX, 65NN, 65NNX, 65PVX, 65X, 65X-2, 65XE, 65XR, 6FMA11A, 6FMA11B, 6FMA11M, 6FMA11Z, 6FMA2A, 6FMA2B, 6FMA2M...(Other models you can see in the webshop)		

miscellaneous

			
1			
GEV No.	750059	Ref. No.	36Z6471
description	evaporation tray for condenser L 440mm W 357mm		
For models:	135BN, 135BNX, 65B, 65BA, 65BX, 65BX-2, 65BXE, 65BXR, SP135BN, SP65B		

transmission technology and ball bearings

drive belts

poly-v belts

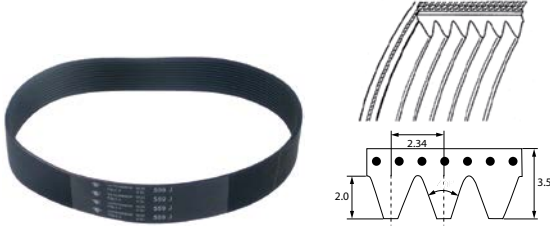
			
1			
GEV No.	692144	Ref. No.	36G6610
description	poly-v belt grooves 12 W 28mm L 559mm profile J		
For models:	LCV, P10, P102, P10M, P20, P202, P5, TV1, TV1M, TV2L		

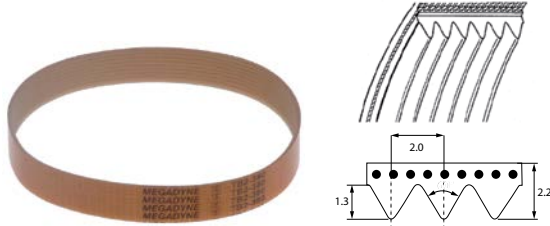
			
1			
GEV No.	698156	Ref. No.	36G6630
description	poly-v belt grooves 14 W 28mm L 430mm profile TB2		

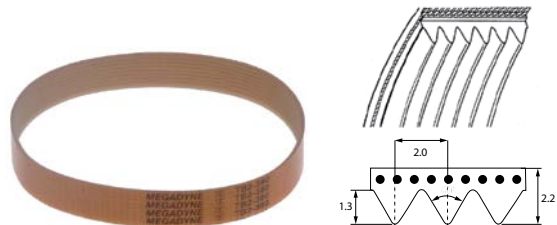
			
1			
GEV No.	698223	Ref. No.	3042690
description	poly-v belt grooves 6 W 12mm L 660mm profile TB2		
For models:	SC4, SC6		

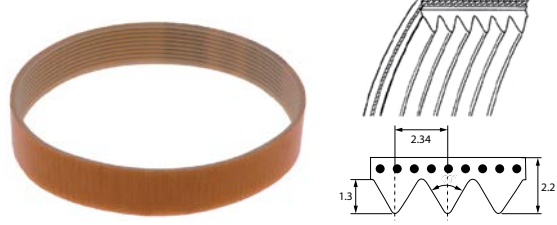
			
1			
GEV No.	698206	Ref. No.	36G4900
description	poly-v belt grooves 12 W 28mm L 457mm profile TB2.34		

springs

torsion springs

			
1			
GEV No.	516090	Ref. No.	36G8360
description	torsion spring mounting pos. right for door		

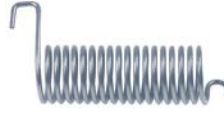
			
1			
GEV No.	700221	Ref. No.	36E0220
description	torsion spring ϕ 17mm wire gauge ϕ 1.5mm L1 48mm		
For models:	C1424		

			
1			
GEV No.	700185	Ref. No.	36G1300
description	torsion spring ϕ 30.5mm wire gauge ϕ 4.7mm L1 30mm L2 295mm L3 30mm		
For models:	1G1BR1E, 1G1BR1G, 1G1PD1G, 1G1PI1E, 1G1PI1G, 31PD6, 31PI6, 31PIE6, 31R, 31RE		

1 			
GEV No.	700186	Ref. No.	36G2640
description	torsion spring \varnothing 31.7mm wire gauge \varnothing 5.5mm L1 30mm L2 300mm L3 30mm		
For models:	191PD1G, 191PD2G, 191PI1G, 191PI1GA, 191PI2E, 191PI2EA, 191PI2G, 191PI2GA, 191PI2V, 191PI2VA, 1A1PD1G, 1A1PD2G, 1A1PI1G, 1A1PI1GA, 1A1PI2E, 1A1PI2EA, 1A1PI2G, 1A1PI2GA, 1A1PI2V, 1A1PI2VA, 1D1PD1G, 1D1PD2G, 1D1PI1G, 1D1PI1GA, 1D1PI2E, 1D1PI2EA, 1D1PI2G, 1D1PI2GA, 1D1PI2V, 1D1PI2VA, 71AR, 71ARE, 71PD10, 71PD15, 71PI10, 71PI10A, 71PIE15, 71PIE15A, 71PV15, 71PV15A, 71RA, 91AR, 91ARE, 91PI10, 91PI10A, 91PIE15, 91PIE15A, 91RA		

2 			
GEV No.	691182	Ref. No.	36G9970
description	torsion spring \varnothing 52mm wire gauge \varnothing 6mm L1 110mm L2 30mm L3 30mm Qty 2 pcs		
For models:	PV200A, PV300		

compression springs

1 			
GEV No.	516247	Ref. No.	36G1730
description	compression spring \varnothing 18mm L 30mm		
For models:	LT10R, LT20F, LT25F		

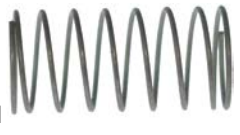
1 			
GEV No.	514284	Ref. No.	36G5320
description	compression spring \varnothing 9mm L 18mm wire gauge \varnothing 0.5mm		
For models:	04WCP1EM, 08WCP1GM, BX101E, BX101E-VERS.122013, BX101G, BX101G-VERS.122013, BX122E, BX122E-VERS.122013, BX122G, BX122G-VERS.122013, BX61E, BX61E-VERS.122013, BX61G, BX61G-VERS.122013, BX82E, BX82E-VERS.122013, BX82G, BX82G-VERS.122013, FC101, FC1011E, FC1011G, FC101E, FC1221E, FC1221G, FC241, FC241E, FC241G, FC61, FC611E, FC611G, FC61E, FCV101, FCV101-CSA, FCV101DM, FCV101DM-CSA, FCV101DS, FCV101DS-CSA, FCV101E, FCV101EDM, FCV101EDM-UL, FCV101EDS, FCV101EDS-UL, FCV101E-UL, FCV141, FCV141-CSA, FCV141DM, FCV141DM-CSA, FCV141DS, FCV141DS-CSA, FCV141E...(Other models you can see in the webshop)		

roller springs

roller springs

1 			
GEV No.	517338	Ref. No.	36G7650
description	roller spring		
For models:	N303D, N303S, N303VD, N303VS, N354D, N354S, N354VD, N354VS, N506D, N506S, N506VD, N506VS, N607D, N607S, N607VD, N607VS, N760D, N760S, N760VD, N760VS, N886D, N886S, N886VD, N886VS		

1 			
GEV No.	519340	Ref. No.	36G8430
description	roller spring		
For models:	LP124, LP124S-VERS.052006, LP124V, LP124-VERS.052006, LP124VS-VERS.052006, LP124V-VERS.052006		

1 			
GEV No.	519616	Ref. No.	36G8740
description	roller spring W 40mm ID \varnothing 36mm lug length 50mm		
For models:	C165D, C165S, C165VD, C165VS, C207D, C207D-VERS.2006, C207S, C207S-VERS.2006, C207VD, C207VD-VERS.2006, C207VS, C207VS-VERS.2006, C304AD, C304AD-VERS.2006, C304AS, C304AS-VERS.2006, C304AVD, C304AVD-VERS.2006, C304AVS, C304AVS-VERS.2006, C304D, C304D-VERS.2006, C304S, C304S-VERS.2006, C304VD, C304VD-VERS.2006, C304VS, C304VS-VERS.2006, C92D-VERS.2006, C92S-VERS.2006, C92VD-VERS.2006, C92VS-VERS.2006, CS243D, CS243D-VERS.2006, CS243S, CS243S-VERS.2006, CS243VD, CS243VD-VERS.2006, CS243VS, CS243VS-VERS.2006, CS370AD, CS370AD-VERS.2006, CS370AS, CS370AS-VERS.2006, CS370AVD, CS370AVD-VERS.2006, CS370AVS, CS370AVS-VERS.2006, CS370D, CS370D-VERS.2006...(Other models you can see in the webshop)		



			
1			
GEV No.	519619	Ref. No.	36G8750
description	roller spring with holder W 40mm ID ø 36.5mm lug length 60mm mounting distance 18mm bore ø 5mm		
For models:	C207D-VERS.2006, C207S-VERS.2006, C207VD-VERS.2006, C207VS-VERS.2006, C304AD, C304AD-VERS.2006, C304AS, C304AS-VERS.2006, C304AVD, C304AVD-VERS.2006, C304AVS, C304AVS-VERS.2006, C304D, C304D-VERS.2006, C304S, C304S-VERS.2006, C304VD, C304VD-VERS.2006, C304VS, C304VS-VERS.2006, C92D-VERS.2006, C92S-VERS.2006, C92VD-VERS.2006, C92VS-VERS.2006, CS243D, CS243D-VERS.2006, CS243S, CS243VD, CS243VD-VERS.2006, CS243VS, CS243VS-VERS.2006, CS370AD, CS370AD-VERS.2006, CS370AS, CS370AS-VERS.2006, CS370AVD, CS370AVD-VERS.2006, CS370AVS, CS370AVS-VERS.2006, CS370D, CS370D-VERS.2006, CS370S, CS370S-VERS.2006, CS370VD, CS370VD-VERS.2006, CS370VS, CS370VS-VERS.2006, CS466AD, CS466AD-VERS.2006, CS466AS...(Other models you can see in the webshop)		

			
1			
GEV No.	519163	Ref. No.	36G8870
description	tension spring ø 38.5mm total length 394mm wire gauge ø 6.5mm for hood		
For models:	LC100, LC100-VERS.2001, LC130, LC130-VERS.2001, LC80		

kitchen accessories

gastronorm

bridges

			
1			
GEV No.	691173	Ref. No.	35S6320
description	bridge for Gastronorm container L1 175mm L2 155mm SS W 25mm H 15mm Qty 1 pcs		
For models:	SA87		

shock absorbers

			
1			
GEV No.	691188	Ref. No.	36G1370
description	shock absorber		

tension springs

			
1			
GEV No.	505501	Ref. No.	36G1340
description	tension spring ø 11mm wire gauge ø 1.5mm L 220mm		
For models:	F60P, F60PR, F60T, F80P, F80PR, L45		

			
1			
GEV No.	501296	Ref. No.	36H1430
description	tension spring ø 12mm total length 275mm wire gauge ø 1.6mm		

			
1			
GEV No.	700718	Ref. No.	36G5240
description	tension spring ø 16.4mm total length 79.2mm wire gauge ø 2.9mm		
For models:	0A1CP1E, 0A1CP1G, 0A1FR1E, 0A1FR1ED, 0A1FR1G, 0A1FR1GD, 0A1FR1GD-VERS.2004, 0A1FR1G-VERS.2004, 0A1FR3G, 0A1FR3GD, 0B1CP1G, 0B1FR1G, 0B1FR1GD, 0D1CP1E, 0D1CP1G, 0D1FR1E, 0D1FR1ED, 0D1FR1G, 0D1FR1GD, 0D1FR1GD-VERS.2004, 0D1FR1G-VERS.2004, 0D1FR3G, 0D1FR3GD, 1A1CP1G, 1A1CP2G, 1A1FR2E, 1A1FR2ED, 1A1FR2G, 1A1FR2GD, 1A1FR2GD-VERS.2004, 1A1FR2G-VERS.2004, 1A1FR4G, 1A1FR4GD, 1D1CP1G, 1D1CP2G, 1D1FR2ED, 1D1FR2G, 1D1FR2GD, 1D1FR2GD-VERS.2004, 1D1FR2G-VERS.2004, 1D1FR4G, 1D1FR4GD, 30CPS, 30CPSE, 30F1, 30F1B, 30FES2, 30FES2B, 30FS2, 30FS2B...(Other models you can see in the webshop)		

			
1			
GEV No.	517286	Ref. No.	36H1460
description	tension spring ø 35mm total length 865mm wire gauge ø 5mm		
For models:	KD100, KD100A, KD100PSD, KD130, KD130A, KD130E, KD130EAT		

manometers

			
1			
GEV No.	541508	Ref. No.	33D1680
description	manometer ø 40mm pressure range 0-4bar connection thread 1/8"		
For models:	BX101E, BX101E-VERS.122013, BX101G, BX101G-VERS.122013, BX122E, BX122E-VERS.122013, BX122G, BX122G-VERS.122013, BX61E, BX61E-VERS.122013, BX61G, BX61G-VERS.122013, BX82E, BX82E-VERS.122013, BX82G, BX82G-VERS.122013, FCV101, FCV101-CSA, FCV101DM, FCV101DM-CSA, FCV101DS, FCV101DS-CSA, FCV101E, FCV101EDM, FCV101EDM-UL, FCV101EDS, FCV101EDS-UL, FCV101E-UL, FCV141, FCV141-CSA, FCV141DM, FCV141DM-CSA, FCV141DS, FCV141DS-CSA, FCV141E, FCV141EDM, FCV141EDS, FCV241, FCV241DM, FCV241DS, FCV241E, FCV241EDM, FCV241EDM-UL, FCV241EDS, FCV241EDS-UL, FCV241E-UL, FCV241G, FCV241G-CSA, FCV241GDM, FCV241GDM-CSA...(Other models you can see in the webshop)		

			
1			
GEV No.	541880	Ref. No.	33D1680-old
description	manometer ø 41mm pressure range 0-6bar thread 1/8" 0-90PSI		



1

GEV No.	541334	Ref. No.	32V0940
description	manometer ø 60mm pressure range 0 up to 1bar thread 1/8" marking 0.5 kettle connection on the backside		
For models:	1A1PI1G, 1A1PI1GA, 1A1PI2E, 1A1PI2EA, 1A1PI2G, 1A1PI2GA, 1A1PI2V, 1A1PI2VA, 1D1PI1G, 1D1PI1GA, 1D1PI2E, 1D1PI2EA, 1D1PI2G, 1D1PI2GA, 1D1PI2V, 1D1PI2VA, 2A1PI3G, 2D1PI3G		



1

GEV No.	541062	Ref. No.	32Z0060	
description	manometer ø 63mm pressure range 0 up to 1bar connection marking adjustable kettle thread 1/4"			
For models:	191PI1G, 191PI1GA, 191PI2E, 191PI2EA, 191PI2G, 191PI2GA, 191PI2V, 191PI2VA, 1A1PI1G, 1A1PI1GA, 1A1PI2E, 1A1PI2EA, 1A1PI2V, 1A1PI2VA, 1D1PI1G, 1D1PI1GA, 1D1PI2E, 1D1PI2EA, 1D1PI2V, 1D1PI2VA, 1G1PI1E, 1G1PI1G, 291PI3E, 291PI3G, 2A1PI3E, 31PI6, 31PIE6, 71PI10, 71PI10A, 71PIE15, 71PIE15A, 71PV15, 71PV15A, 91PI10, 91PI10A, 91PIE15, 91PIE15A, BPV2, PV200, PV200A, PV300, PV300A			
spare parts for	541062			
	GEV No.	541130	Ref. No.	—
	glass panel ø 58mm thickness 2mm			

hose reels and spray guns

spray guns



1

GEV No.	691048	Ref. No.	33D1700	
description	spray gun for appliances 1/2" ET L 225mm type STAR			
spare parts for	691048			
	GEV No.	507309	Ref. No.	—
	O-ring EPDM thickness 2.62mm ID ø 17.13mm Qty 1 pcs			
	GEV No.	510322	Ref. No.	—
	O-ring EPDM thickness 1.78mm ID ø 17.17mm Qty 1 pcs			
	GEV No.	524055	Ref. No.	—
	flat gasket rubber ED ø 18mm ID ø 12mm thickness 2mm Qty 1 pcs			
	GEV No.	528485	Ref. No.	—
	O-ring EPDM thickness 1.78mm ID ø 6.07mm Qty 1 pcs			
	GEV No.	528494	Ref. No.	—
	gasket rubber ED ø 13mm ID ø 4mm thickness 4mm Qty 1 pcs			



1

GEV No.	542068	Ref. No.	33D1700
description	spray gun for appliances 1/2" IT L 219mm with D-ring type KLARCO		



1

GEV No.	540675	Ref. No.	3212740 3FL0182
description	shower head		

dosing pumps

peristaltic dosing pumps

- BORES
- built-in version
- with flow control







1

GEV No.	361028	Ref. No.	33D0750	
description	dosing pump BORES flow control 0.39l/h 230VAC rinse aid hose ø 4x6mm hose silicone type Perios built-in version with integrated non-return valve CODE P1B			
For models:	F60PR, F60T, F80P, F80PR			
spare parts for	361028			
	GEV No.	361127	Ref. No.	—
	pump hose Perios rinse aid hose ø 3x6mm hose type silicone L 120mm			
	GEV No.	361464	Ref. No.	—
	roller assembly rinse aid/detergent hose type Santoprene/silicone pump type Perios			
accessories for	361028			
	GEV No.	361142	Ref. No.	—
	mounting set detergent hose type 4x6mm hose length 2m PVC 2x hose/container filter/tank intake transparent			
	GEV No.	520090	Ref. No.	—
	PVC hose ID ø 4mm ED ø 6mm L 2m thickness 1mm t.max. 60°C transparent			
	GEV No.	520091	Ref. No.	—
	nylon hose ID ø 4mm ED ø 6mm L 2m thickness 1mm operating p. 10bar burst p. 50bar t.max. 100°C transparent			





SEKO			
spare parts			
			
1			
GEV No.	362021	Ref. No.	3186560
description	pump hose SEKO hose ø 6x10mm hose Santoprene		
For models:	FX101E3, FX101E3C, FX101E3C-VERS.022014, FX101E3R, FX101E3R-VERS.022014, FX101E3-VERS.022014, FX101G3, FX101G3C, FX101G3C-VERS.022014, FX101G3R, FX101G3R-VERS.022014, FX101G3-VERS.022014, FX10E3CR, FX10E3CR-VERS.022014, FX10G3CR, FX10G3CR-VERS.022014, FX122E3, FX122E3C, FX122E3T, FX122E3T-VERS.022014, FX122G3, FX122G3C, FX122G3T, FX122G3T-VERS.022014, FX12E3CT, FX12E3CT-VERS.022014, FX12G3CT, FX12G3CT-VERS.022014, FX201E3, FX201E3P, FX201E3P-VERS.022014, FX201E3-VERS.022014, FX201G3P, FX201G3-VERS.022014, FX202E3, FX202E3-230V-3-50Hz-60Hz, FX202E3-230V-3-50Hz-60Hz-VERS.022014, FX202E3-VERS.022014, FX202G3, FX202G3-VERS.022014, FX61E3, FX61E3C, FX61E3CR, FX61E3CR-VERS.022014, FX61E3C-VERS.022014, FX61E3R, FX61E3R-VERS.022014, FX61E3-VERS.022014, FX61G3, FX61G3C...(Other models you can see in the webshop)		



spare parts for 361003				
	GEV No.	361123	Ref. No.	—
membrane type DELTA				
	GEV No.	361169	Ref. No.	—
hose connector type DELTA				
	GEV No.	361188	Ref. No.	—
disc type DELTA				
	GEV No.	361319	Ref. No.	—
flat gasket rubber ID ø 9mm ED ø 14.5mm thickness 1mm type DELTA				

piston pumps			
spare parts			
			
1			
GEV No.	361113	Ref. No.	—
description	solenoid coil 230VAC for type DB2		

spare parts			
			
1			
GEV No.	361169	Ref. No.	—
description	hose connector type DELTA		

			
1			
GEV No.	510298	Ref. No.	N/A
description	lip valve dosing pump suitable for DB2/DS5		

			
1			
GEV No.	361123	Ref. No.	—
description	membrane type DELTA		

membrane dosing pumps				
electric dosing pumps				
Delta				
				
1				
GEV No.	361003	Ref. No.	32Z1610	
description	dosing pump 220V rinse aid duty cycle 25% type EL-1 valve lip valve			
spare parts for	361003			
	GEV No.	361122	Ref. No.	—
lip valve type DELTA				







self-priming				
LANG				
				
1				
GEV No.	361575	Ref. No.	33D2300	
description	dosing pump type N6 rinse aid pressure connection ø straight, 4x6mm suction connection ø angled, 6mm LANG			
spare parts for	361575			
	GEV No.	361079	Ref. No.	—
spring for type N5/N6 for ball				
	GEV No.	361080	Ref. No.	—
O-ring EPDM thickness 2mm ID ø 16mm Qty 1 pcs				
	GEV No.	361085	Ref. No.	—
O-ring EPDM thickness 2mm ID ø 8mm Qty 1 pcs				
	GEV No.	361309	Ref. No.	—
ball for type N5/N6				
	GEV No.	361310	Ref. No.	—
bracket for type N6 ball guide				

Table continues overleaf





spare parts for		361575		
GEV No.	361311	Ref. No.	—	
	O-ring EPDM thickness 2mm ID ø 6mm Qty 1 pcs for type N6			
	valve ring for type N6 holder for O-ring			
	sealing disc for type N6			
	non-return valve inletmm outletmm outlet ø 12.4mm L 12.7mm			

accessories

				
1				
GEV No.	101286	Ref. No.	36Q0020	
description	olive ID ø 6mm Qty 1 pcs			
For models:	04WFAAV, 08WFA4E, 08WFA4G, 08WFAAE, 08WFAAG, 08WFAAV, 090FAA, 0A0FA1, 0A0FA4, 0A0FAA, 0D0FA1, 0D0FA4, 0D0FAA, 0G0FA0, 12WFA6E, 12WFA6G, 12WFAAA, 12WFAAE, 12WFAAG, 12WFAAN, 190FA, 190FAA, 190FAB, 190FAD, 191FAAE, 191FAAG, 191FABG, 191FADG, 191FAE, 191FAG, 1A0FA1, 1A0FA2, 1A0FA4, 1A0FA5, 1A0FAA, 1A0FAB, 1A1FA1G, 1A1FA2G, 1A1FA4G, 1A1FA5G, 1A1FAAG, 1A1FABG, 1D0FA1, 1D0FA2, 1D0FA4, 1D0FA5, 1D0FAA, 1D0FAB, 1D1FA1G, 1D1FA2G...(Other models you can see in the webshop)			
accessories for	101286			
	GEV No.	100909	Ref. No.	36Q0060
union screw thread M10x1 for pipe ø 6mm Qty 1 pcs				
	GEV No.	101464	Ref. No.	—
union nut thread M12x1 for pipe ø 6mm				

various

				
1				
GEV No.	361002	Ref. No.	33D0060 33D0061	
description	dosing pump rinse aid inlet 6x8mm outlet 4x6mm pressure connection ø 4x6mm suction connection ø 6x8mm			
For models:	F60P, L100, L40, L40S, L45, L60, L80			
spare parts for	361002			
	GEV No.	510297	Ref. No.	N/A
membrane for dosing pump ED ø 83mm thickness 1mm dosing pump equiv. no. 630614 suitable for COMENDA				
	GEV No.	510298	Ref. No.	N/A
lip valve dosing pump suitable for DB2/DS5				

spare parts for		361002		
GEV No.	510299	Ref. No.	N/A	
	hose connector for dosing pump			
	union nut dosing pump thread 1/2" ø 32mm H 15mm for dosing pump			
	gasket polishing agent dosing ID ø 22mm ED ø 32mm external height 5mm			
	filter support for dosing pump			
	filter for dosing pump			

spare parts

				
1				
GEV No.	510916	Ref. No.	N/A	
description	filter for dosing pump			

				
1				
GEV No.	510870	Ref. No.	N/A	
description	filter support for dosing pump			

				
1				
GEV No.	510847	Ref. No.	N/A	
description	gasket polishing agent dosing ID ø 22mm ED ø 32mm external height 5mm			

				
1				
GEV No.	510298	Ref. No.	N/A	
description	lip valve dosing pump suitable for DB2/DS5			



			
1			
GEV No.	510297	Ref. No.	N/A
description	membrane for dosing pump ED ø 83mm thickness 1mm dosing pump equiv. no. 630614 suitable for COMENDA		

			
1			
GEV No.	510338	Ref. No.	N/A
description	union nut dosing pump thread 1/2" ø 32mm H 15mm for dosing pump		

self-priming with supporting pressure

DIHR

			
1			
GEV No.	361744	Ref. No.	33D3240
description	dosing pump type DW with auxiliary pressure connection rinse aid inlet 4mm outlet 8mm suction connection ø 4mm auxiliary pressure connection 10mm		
For models:	KD100, KD100A, KD100PSD, KD130E, KD130EAT, KD37, KD40, KD40E-PSD, KD40LEPS, KD40LSPS, KD40LUX, KD40LUXE, KD40-VERS.112009, KD60, KD60M, KD60MA, KD60MPS, KD60MPSA, KD60PS, KD60PSD, KD85, KD85A, KD85E, KD85EA, KD85EAT, KD85EATS, KD85EPS, KD85E-PSA, KD85PS, KD85PSA, KN1100, KN1100SD, KN11PSDD, KN35, KN37, KN37PS, KN40, KN40PS, KN40PSD, KN50, KN50M, KN50MPS, KN50PS, KN50PSD, KN50PSDD, KN80, KN800, KN800PSD, KN80PS, LP70		
spare parts for	361744		
	GEV No.	520026	Ref. No.
	 PVC hose ID ø 4mm ED ø 6mm L 10m thickness 1mm t.max. 60°C transparent		
	GEV No.	520090	Ref. No.
	 PVC hose ID ø 4mm ED ø 6mm L 2m thickness 1mm t.max. 60°C transparent		

ELETTROBAR

			
1			
GEV No.	510298	Ref. No.	N/A
description	lip valve dosing pump suitable for DB2/DS5		

GERMAC			
spare parts			
			
1			
GEV No.	510298	Ref. No.	N/A
description	lip valve dosing pump suitable for DB2/DS5		

accessories

			
1			
GEV No.	361829	Ref. No.	—
description	container filter complete plastic hose ø 5mm		

hose couplings

metal			
			
1			
GEV No.	361507	Ref. No.	3016150
description	screw pipe fitting angled nickel-plated brass thread 1/4" hose ø 6/8mm Qty 1 pcs		

			
1			
GEV No.	361506	Ref. No.	3014470
description	screw pipe fitting angled nickel-plated brass thread 1/8" hose ø 6/8mm Qty 1 pcs		
For models:	FM1011E2-VERS.2006, FM1011E3, FM1011E3-VERS.2006, FM1011G2-VERS.2006, FM1011G3, FM1011G3-VERS.2006, FM1221E2-VERS.2006, FM1221E3, FM1221E3-VERS.2006, FM1221G2-VERS.2006, FM1221G3, FM1221G3-VERS.2006, FM2011E2-VERS.2006, FM2011E3-VERS.2006, FM2011G2-VERS.2006, FM2011G3-VERS.2006, FM2021E2-VERS.2006, FM2021E3-VERS.2006, FM2021G2-VERS.2006, FM2021G3-VERS.2006, FM423E2, FM611E2-VERS.2006, FM611E3, FM611E3-VERS.2006, FM611G2-VERS.2006, FM611G3, FM611G3-VERS.2006, FM721E2-VERS.2006, FM721E3, FM721E3-VERS.2006, FM721G2-VERS.2006, FM721G3, FM721G3-VERS.2006, FX101E2, FX101E2C, FX101E2C-VERS.032014, FX101E2R, FX101E2R-VERS.032014, FX101E3, FX101E3C, FX101E3C-VERS.022014, FX101E3R, FX101E3R-VERS.022014, FX101E3-VERS.022014, FX101G2, FX101G2C, FX101G2C-VERS.032014, FX101G2R, FX101G2R-VERS.032014...(Other models you can see in the webshop)		

			
1			
GEV No.	361182	Ref. No.	3117580
description	nut thread 1/4" H 5mm nickel-plated brass WS 17 Qty 1 pcs		
For models:	L100, L40, L40S, L60, L80, P5		

T-pieces

without non-return valve



GEV No.	516082	Ref. No.	35Z1090
description	T-piece plastic hose ø 12-7-12mm 3-way hose ø 12-7-12mmmm		





GEV No.	519217	Ref. No.	33Q3070
description	T-piece plastic hose ø 12-9-12mm 3-way hose ø 12-9-12mmmm		
For models:	F60P, L45, LC100, LC100-VERS.2001, LC130, LC130-VERS.2001, LC80, LF50		

hoses

supply hoses

PVC supply hoses



GEV No.	520010	Ref. No.	33M0350
description	supply hose PVC straight-curved DN13 connections 3/4" L 1500mm operating p. 10bar burst p. 32bar t.max. 90°C blue approval VDE flat seal		
accessories for	520010		
	GEV No.	520053	Ref. No. —
	screen connection 3/4" D1 ø 26mm D2 ø 15mm Qty 10 pcs rubber thickness 8mm		
	GEV No.	520054	Ref. No. 3152480
	flat gasket rubber ED ø 23.5mm ID ø 14mm thickness 2.3mm Qty 10 pcs		

drain hoses



GEV No.	530608	Ref. No.	33M1660
description	drain hose DN24 L 1500mm A int. ø 24mm A ext. ø 28mm B int. ø 28mm B ext. ø 35mm outer hose ø 29mm temp.-resist. 90°C		
For models:	KD100, KD100A, KD100PSD, KD40, KD40EPSD, KD40LEPS, KD40LSPS, KD40PS, KD60, KD60E, KD60EAT, KD60M, KD60MA, KD60ME, KD60MPS, KD60MPSA, KD60PS, KD60PSD, KD60EATSD, KN1100, KN1100SD, KN11PSDD, KN35, KN37PS, KN40PS, KN50MPS, KN50PS, KN50PSD, KN50PSDD, KN800, KN800PSD, KN80PS, N100D, N100S, N100VD, N100VS, N38D, N38S, N38VD, N38VS, N42D, N42S, N42VD, N42VS, N50D, N50S, N50VD, N50VS, N66D, N66S...(Other models you can see in the webshop)		

GEV No.	530574	Ref. No.	3033760
description	drain hose DN31 L 2000mm A int. ø 31mm A ext. ø 35mm B int. ø 40mm B ext. ø 46mm outer hose ø 38mm		
For models:	KD85EATS, KD85EPS, KD85EPSA		

GEV No.	519272	Ref. No.	3029590 36U0730
description	drain hose DN24 L 1500mm straight ø inside 32mm straight ext. ø 35mm elbow ø inside 40mm elbow ext. ø 46mm outer hose ø 38mm		
For models:	LC100, LC100-VERS.2001, LC130, LC130-VERS.2001, LC80, LF50, LF50E, LF50EM, LF50EMPS-VERS.122012, LF50EM-VERS.122012, LF50E-VERS.122012, LP70		

industrial hoses

Niplaflex hoses



GEV No.	530561	Ref. No.	111AA05 131AA12 131AA14 131AA16
description	pressure hose ID ø 10mm ED ø 17mm L 5m thickness 3.5mm operating p. 10bar burst p. 30bar t.max. 110°C		
For models:	04WBMEV, 04WCP1EM, 06WCP1GM, 06WFR3GD, 08WCP1GM, 08WGREV, 090BM1E, 090BM1G, 091CP1E, 091CP1G, 0G1CP1EC, 0G1CP1E-VERS.2004, 0G1CP1G-VERS.2004, 10CP1EA, 10CP1GA, 10CP1IA, 10WFR4GD, 12CP1EA, 12CP1GA, 12CP1IA, 18CP2EA, 18CP2GA, 18CP2IA, 190BM2E, 190BM2G, 190GRE, 191BR1E, 191BR1G, 191BR1GA, 191BR2E, 191BR2EA, 191BR2G, 191BR2GA, 191CP1G, 191CP2G, 1G0GRE, 1G1CP1G-VERS.2004, 1G1CP2G-VERS.2004, 291BR1E, 291BR1G, 291BR1GA, 291BR2E, 291BR2EA, 291BR2G, 291BR2GA, 6040090, 6040110, 6040310, 6042610, 6042630...(Other models you can see in the webshop)		

pressure control hoses



GEV No.	530560	Ref. No.	111AA04
description	pressure control hose ID ø 5mm ED ø 9mm L 5m operating p. 30bar burst p. 90bar temp.-resist. 60°C		



PU hoses



1

GEV No.	512475	Ref. No.	3003920
description	dosing hose ED ø 8mm ID ø 6mm polyurethane blue Qty supplied by meter		
For models:	FM1011E3, FM1011E3-VERS.2006, FM1011G3, FM1011G3-VERS.2006, FM1221E3, FM1221E3-VERS.2006, FM1221G3-VERS.2006, FM2011E3-VERS.2006, FM2011G3-VERS.2006, FM2021E3, FM2021E3-VERS.2006, FM2021G3, FM2021G3-VERS.2006, FM611E3, FM611E3-VERS.2006, FM611G3, FM611G3-VERS.2006, FM721E3, FM721E3-VERS.2006, FM721G3, FM721G3-VERS.2006, FX101E3, FX101E3C, FX101E3C-VERS.022014, FX101E3R, FX101E3R-VERS.022014, FX101E3-VERS.022014, FX101G3, FX101G3C, FX101G3C-VERS.022014, FX101G3R, FX101G3R-VERS.022014, FX101G3-VERS.022014, FX10E3CR, FX10E3CR-VERS.022014, FX10G3CR, FX10G3CR-VERS.022014, FX122E3, FX122E3C, FX122E3T, FX122E3T-VERS.022014, FX122G3, FX122G3C, FX122G3T, FX122G3T-VERS.022014, FX12E3CT, FX12E3CT-VERS.022014, FX12G3CT, FX12G3CT-VERS.022014, FX201E3...(Other models you can see in the webshop)		

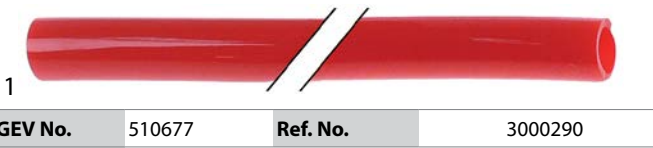

1

GEV No.	510677	Ref. No.	3000290
description	dosing hose ED ø 8mm ID ø 6mm polyurethane red Qty supplied by meter		
For models:	FM1011E3, FM1011E3-VERS.2006, FM1011G3, FM1011G3-VERS.2006, FM1221E3, FM1221E3-VERS.2006, FM1221G3-VERS.2006, FM2011E3-VERS.2006, FM2011G3-VERS.2006, FM2021E3, FM2021E3-VERS.2006, FM2021G3, FM2021G3-VERS.2006, FM611E3, FM611E3-VERS.2006, FM611G3, FM611G3-VERS.2006, FM721E3, FM721E3-VERS.2006, FM721G3, FM721G3-VERS.2006, FX101E3, FX101E3C, FX101E3R, FX101G3, FX101G3C, FX101G3R, FX10E3CR, FX10G3CR, FX122E3, FX122E3C, FX122G3, FX122G3C, FX201E3, FX202E3, FX61E3, FX61E3C, FX61E3CR, FX61E3R, FX61G3, FX61G3C, FX61G3CR, FX61G3R, FX82E3, FX82E3C, FX82G3, FX82G3C		

formed hoses

straight



1

GEV No.	506412	Ref. No.	111AA08
description	formed hose dishwasher straight hose ext. ø 60mm hose int. ø 50mm		
For models:	FM1221E1, FM1221E2, FM1221E3, FM1221G1, FM1221G2, FM1221G3, FM2021E1, FM2021E2, FM2021E3, FM2021G1, FM2021G2, FM2021G3, FM721E1, FM721E2, FM721E3, FM721G1, FM721G2, FM721G3, FX101E1, FX101E1R, FX101E2, FX101E2C, FX101E2R, FX101E3, FX101E3C, FX101E3R, FX101G1, FX101G1R, FX101G2, FX101G2C, FX101G2R, FX101G3, FX101G3C, FX101G3R, FX10E2CR, FX10E3CR, FX10G2CR, FX10G3CR, FX61E1, FX61E1R, FX61E2, FX61E2C, FX61E2CR, FX61E2R, FX61E3, FX61E3C, FX61E3CR, FX61E3R, FX61G1, FX61G1R...(Other models you can see in the webshop)		

form L



1

GEV No.	519160	Ref. No.	33M1260
description	formed hose L 150mm warewashing L-shape equiv. no. 903876 W 110mm hose int. ø 40mm		
For models:	LF50, LF50E, LF50EM, LP70		



1

GEV No.	517228	Ref. No.	3115800
description	formed hose warewashing L-shape equiv. no. 15032/A		
For models:	KD130, KD130A, KD130E, KD130EAT		



1

GEV No.	519382	Ref. No.	3300230
description	formed hose warewashing L-shape hose int. ø 44mm		
For models:	F60P, F60PR, F60T, L45		



1

GEV No.	512384	Ref. No.	32Z2810
description	formed hose warewashing L-shape L2 100mm hose ext. ø 65mm hose int. ø 45mm		



with branch



1

GEV No.	517364	Ref. No.	3031860
description	formed hose ext. ø 58 D1 ø 50mm D2 ø 35mm L 455mm black Qty 1		
For models:	KD130, KD130A, KD130E, KD130EAT		



1

GEV No.	517361	Ref. No.	3031860
description	formed hose L 450mm rubber Qty 1		

form S



1

GEV No.	510678	Ref. No.	3300240
description	formed hose hose ext. ø 48mm hose int. ø 39mm L 235mm Qty 1 S-shape		
For models:	F60P, F60PR, F60T, L45		

for dishwashers

miscellaneous



1

GEV No.	530590	Ref. No.	33M1310
description	hose ED ø 15mm ID ø 8mm equiv. no. 200117 Qty supplied by meter		

fittings, hose and pipe connectors
 hose connectors

without screw connection



1

GEV No.	519216	Ref. No.	36G9050
description	T-piece plastic hose ø 12-12-12mm 3-way		
For models:	LC100, LC100-VERS.2001, LC130, LC130-VERS.2001, LC80, LF50, LF50E, LF50EM, LP70		



1

GEV No.	516082	Ref. No.	35Z1090
description	T-piece plastic hose ø 12-7-12mm 3-way hose ø 12-7-12mmmm		



1

GEV No.	519217	Ref. No.	33Q3070
description	T-piece plastic hose ø 12-9-12mm 3-way hose ø 12-9-12mmmm		
For models:	F60P, L45, LC100, LC100-VERS.2001, LC130, LC130-VERS.2001, LC80, LF50		

1

GEV No.	519630	Ref. No.	3008090
description	T-piece plastic hose ø 6x6x6mm 3-way		
For models:	191CP1G, 1G1CP1G-VERS.2004, FM1011E3, FM1011E3-VERS.2006, FM1011G3, FM1011G3-VERS.2006, FM1221E3-VERS.2006, FM1221G3-VERS.2006, FM2011E3-VERS.2006, FM2011G3-VERS.2006, FM2021E3-VERS.2006, FM2021G3-VERS.2006, FM611E3, FM611E3-VERS.2006, FM611G3, FM611G3-VERS.2006, FM721E3-VERS.2006, FM721G3-VERS.2006		

fittings

double nipples



1

GEV No.	520160	Ref. No.	3005480
description	double nipple nickel-plated brass thread 1/8" - 1/8" Qty 1 pcs		



1

GEV No.	541504	Ref. No.	33Q5880
description	double nipple thread 1/2" - 1/2"		
For models:	FC101, FC241G, FC61, FCV101, FCV101-CSA, FCV101DM, FCV101DM-CSA, FCV101DS, FCV101DS-CSA, FCV141-CSA, FCV141DM-CSA, FCV141DS-CSA, FCV241G, FCV241G-CSA, FCV241GDM, FCV241GDM-CSA, FCV241GDS, FCV241GDS-CSA, FCV401DM, FCV401DM-CSA, FCV61, FCV61-CSA, FCV61DM, FCV61DM-CSA, FCV61DS, FCV61DS-CSA		



1

GEV No.	520883	Ref. No.	3020420
description	reducer SS thread 1" - 1/4" Qty 1 pcs L1 15mm L2 7mm WS 50		
For models:	KD100, KD100A, KD100PSD, N100D, N100S, N100VD, N100VS, N38D, N38S, N38VD, N38VS, N42D, N42S, N42VD, N42VS, N50D, N50S, N50VD, N50VS, N66D, N66S, N66VD, N66VS, N70D, N70S, N70VD, N70VS, N85D, N85S, N85VD, N85VS		

reducers



1

GEV No.	520700	Ref. No.	33Q5650
description	reducer thread 3/4" IT - 1/2" ET brass		
For models:	FCV101, FCV101-CSA, FCV101DM, FCV101DM-CSA, FCV101DS, FCV101DS-CSA, FCV101E, FCV101EDM, FCV101EDM-UL, FCV101EDS, FCV101EDS-UL, FCV101E-UL, FCV141, FCV141-CSA, FCV141DM, FCV141DM-CSA, FCV141DS, FCV141DS-CSA, FCV141E, FCV141EDM, FCV141EDS, FCV241, FCV241DM, FCV241DS, FCV241E, FCV241EDM, FCV241EDM-UL, FCV241EDS, FCV241EDS-UL, FCV241E-UL, FCV241G, FCV241G-CSA, FCV241GDM, FCV241GDM-CSA, FCV241GDS, FCV241GDS-CSA, FCV3EM, FCV401DM, FCV401DM-CSA, FCV401EDM, FCV401EDM-UL, FCV4E, FCV4EDS, FCV4EM, FCV61, FCV61-CSA, FCV61DM, FCV61DM-CSA, FCV61DS, FCV61DS-CSA...(Other models you can see in the webshop)		



1

GEV No.	520177	Ref. No.	3040920
description	reducer thread 1/4" ET - 1/8" IT nickel-plated brass total length 13mm WS 17		

angle pieces





1

GEV No.	541924	Ref. No.	33Q4790
description	angle piece thread 1/2" IT - 1/2" IT brass		
For models:	C165D, C165S, C165VD, C165VS, C207D, C207S, C207VD, C207VD-VERS.2006, C207VS, C207VS-VERS.2006, C304AD, C304AS, C304AVD, C304AVD-VERS.2006, C304AVS, C304AVS-VERS.2006, C304D, C304S, C304VD, C304VD-VERS.2006, C304VS, C304VS-VERS.2006, C92VD-VERS.2006, C92VS-VERS.2006, CS243D, CS243S, CS243VD, CS243VD-VERS.2006, CS243VS, CS243VS-VERS.2006, CS370AD, CS370AS, CS370AVD, CS370AVD-VERS.2006, CS370AVS, CS370A-VS-VERS.2006, CS370D, CS370S, CS370VD, CS370VD-VERS.2006, CS370VS, CS370VS-VERS.2006, CS466AD, CS466AS, CS466AVD, CS466AVD-VERS.2006, CS466AVS, CS466AVS-VERS.2006, CS466D, CS466S...(Other models you can see in the webshop)		



			
1			
GEV No.	541493	Ref. No.	33Q3900
description	angle piece thread 1/2" IT - 1/2" ET chrome-plated brass		
For models:	1A1PI1G, 1A1PI1GA, 1A1PI2E, 1A1PI2EA, 1A1PI2V, 1A1PI2VA, 1D1PI1G, 1D1PI1GA, 1D1PI2E, 1D1PI2EA, 1D1PI2V, 1D1PI2VA, 2A1PI3G, 2D1PI3G		

			
1			
GEV No.	541492	Ref. No.	33Q0570
description	angle piece IT 1/2" ET 1/2"		
For models:	FCV3EM, FCV4E, FCV4EDS, FCV4EM, FM1011E3, FM1011G3, FM1221E3, FM1221G3, FM423E1, FM423E2, FM611E3, FM611G3, FM721E3, FM721G3, L100, L40S, L80, PIER06HD, PIER15HD		

			
1			
GEV No.	520821	Ref. No.	33Q4360
description	angle piece thread 1/4" IT - 1/4" IT nickel-plated brass		
For models:	LC100, LC100-VERS.2001, LC130, LC130-VERS.2001, LC80, LP124S-VERS.052006, LP124-VERS.052006, LP124VS-VERS.052006, LP124V-VERS.052006, LP84S-VERS.052006, LP84-VERS.052006, LP84VS-VERS.052006, LP84V-VERS.052006		

T-pieces			
nickel-plated brass			
			
1			
GEV No.	520385	Ref. No.	3003770
description	T-piece thread 1/8" IT - 1/8" IT - 1/8" IT nickel-plated brass L 35mm		
For models:	FM1011E3, FM1011G3, FM1221E3, FM611E3, FM611G3, FM721E3, FM721G3		

			
1			
GEV No.	520824	Ref. No.	3003750
description	angle piece thread 1/8" ET - 1/8" IT nickel-plated brass		
For models:	FM1011E3, FM1011G3, FM1221E3, FM1221G3, FM2021E3, FM2021G3, FM611E3, FM611G3		

Y-pieces			
			
1			
GEV No.	521197	Ref. No.	36E4290
description	Y-piece thread 1/8" IT - 1/8" IT - 1/8" IT stainless steel WS 13		
For models:	FM1011E3, FM1011G3, FM1221E3, FM1221G3, FM611E3, FM611G3, FM721E3, FM721G3		

			
1			
GEV No.	541496	Ref. No.	33Q5280
description	angle piece thread 1/2" ET - 3/4" IT zinc-coated cast iron		

hose connectors			
plastic			
			
1			
GEV No.	361735	Ref. No.	33Q5040
description	hose connector plastic angled thread 1/4" hose ø 7mm Qty 1 pcs		

			
1			
GEV No.	541494	Ref. No.	33Q0600
description	angle piece thread 3/4" ET - 3/4" IT zinc-coated cast iron		
For models:	ACBM, ACBM218, ANBM, ANBM218, ANBM75, L100, L80, SE14VB, SE21VB, S114VB, S121VB, SL14CVB, SL14NVB, SL21CVB, SL21NVB, SL7NVB, TBM, TBM218		





nickel-plated brass			
			
1			
GEV No.	520159	Ref. No.	3007950
description	hose connector nickel-plated brass straight thread 1/8" hose ø 6mm Qty 1 pcs WS 12 total length 32mm thread L 7.5mm grommet ø 6mm grommet length 19.5mm		
For models:	FM1011E3, FM1011G3, FM1221E3, FM1221G3, FM2021E3, FM2021G3, FM423E2, FM611E3, FM611G3, FM721E3, FM721G3		

			
1			
GEV No.	517108	Ref. No.	3110340
description	hose connector nickel-plated brass angled thread 3/8" ET - M10x1 IT hose ø 12mm Qty 1 pcs		

			
1			
GEV No.	519239	Ref. No.	33Q4270
description	hose connector nickel-plated brass thread 1/4" hose ø 11mm Qty 1 pcs		

			
1			
GEV No.	361507	Ref. No.	3016150
description	screw pipe fitting angled nickel-plated brass thread 1/4" hose ø 6/8mm Qty 1 pcs		

			
1			
GEV No.	361506	Ref. No.	3014470
description	screw pipe fitting angled nickel-plated brass thread 1/8" hose ø 6/8mm Qty 1 pcs		
For models:	FM1011E2-VERS.2006, FM1011E3, FM1011E3-VERS.2006, FM1011G2-VERS.2006, FM1011G3, FM1011G3-VERS.2006, FM1221E2-VERS.2006, FM1221E3, FM1221E3-VERS.2006, FM1221G2-VERS.2006, FM1221G3, FM1221G3-VERS.2006, FM2011E2-VERS.2006, FM2011E3-VERS.2006, FM2011G2-VERS.2006, FM2011G3-VERS.2006, FM2021E2-VERS.2006, FM2021E3-VERS.2006, FM2021G2-VERS.2006, FM2021G3-VERS.2006, FM423E2, FM611E2-VERS.2006, FM611E3, FM611E3-VERS.2006, FM611G2-VERS.2006, FM611G3, FM611G3-VERS.2006, FM721E2-VERS.2006, FM721E3, FM721E3-VERS.2006, FM721G2-VERS.2006, FM721G3, FM721G3-VERS.2006, FX101E2, FX101E2C, FX101E2C-VERS.032014, FX101E2R, FX101E2R-VERS.032014, FX101E2-VERS.032014, FX101E3, FX101E3C, FX101E3C-VERS.022014, FX101E3R, FX101E3R-VERS.022014, FX101E3-VERS.022014, FX101G2, FX101G2C, FX101G2C-VERS.032014, FX101G2R, FX101G2R-VERS.032014...(Other models you can see in the webshop)		

producer-specific			
			
1			
GEV No.	519291	Ref. No.	3012220
description	hose connector		

			
1			
GEV No.	541490	Ref. No.	33Q0590
description	hose connector thread 1/2" grommet ø 15mm		
For models:	ACBM, ACBM218, ANBM75, SL14CVB, SL21CVB, SL7NVB		

			
1			
GEV No.	541489	Ref. No.	33Q0150
description	hose connector thread 1/2" IT grommet ø 15mm		
For models:	L40, L60		

			
1			
GEV No.	520337	Ref. No.	3007980
description	hose connector thread 1/4" grommet ø 7mm ID ø 4.5mm grommet length 19mm WS 14 total length 35mm thread L 10mm		
For models:	04WCP1EM, 06WCP1GM, 08WCP1GM, 091CP1E, 091CP1G, 0G1CP1EC, 0G1CP1E-VERS.2004, 0G1CP1G-VERS.2004, 191CP1G, 191CP2G, 1G1CP1G-VERS.2004, 1G1CP2G-VERS.2004, 6040090, 6040310, 6043850, 6043980, FM1011E3, FM1011G3, FM1221E3, FM1221G3, FM611E3, FM611G3, FM721E3, FM721G3		

			
1			
GEV No.	541491	Ref. No.	33Q1060
description	hose connector thread 3/4" grommet ø 19mm		





1

GEV No.	541497	Ref. No.	33Q5450
description	hose connector thread 3/4" grommet ø 28mm		
For models:	FC101, FC101E, FC241, FC241E, FC241G, FC61, FC61E, FCV101, FCV101-CSA, FCV101DM, FCV101DM-CSA, FCV101DS, FCV101DS-CSA, FCV101E, FCV101EDM, FCV101EDM-UL, FCV101EDS, FCV101EDS-UL, FCV101E-UL, FCV141, FCV141-CSA, FCV141DM, FCV141DM-CSA, FCV141DS, FCV141DS-CSA, FCV141E, FCV141EDM, FCV141EDS, FCV241, FCV241DM, FCV241DS, FCV241E, FCV241EDM, FCV241EDM-UL, FCV241EDS, FCV241EDS-UL, FCV241E-UL, FCV241G, FCV241G-CSA, FCV241GDM, FCV241GDM-CSA, FCV241GDS, FCV241GDS-CSA, FCV3EM, FCV401DM, FCV401DM-CSA, FCV4E, FCV4EDS, FCV4EM, FCV61...(Other models you can see in the webshop)		



2

GEV No.	541488	Ref. No.	33Q5591 33Q5592
description	hose connector thread M14x1 ET - 1/8" IT angled		
For models:	FC101, FC101E, FC241, FC241E, FC241G, FC61, FC61E, FCV101, FCV101-CSA, FCV101DM, FCV101DM-CSA, FCV101DS, FCV101DS-CSA, FCV101E, FCV101EDM, FCV101EDM-UL, FCV101EDS, FCV101EDS-UL, FCV101E-UL, FCV141, FCV141-CSA, FCV141DM, FCV141DM-CSA, FCV141DS, FCV141DS-CSA, FCV141E, FCV141EDM, FCV141EDS, FCV241, FCV241DM, FCV241DS, FCV241E, FCV241EDM, FCV241EDM-UL, FCV241EDS, FCV241EDS-UL, FCV241E-UL, FCV241G, FCV241G-CSA, FCV241GDM, FCV241GDM-CSA, FCV241GDS, FCV241GDS-CSA, FCV3EM, FCV401DM, FCV401DM-CSA, FCV401EDM, FCV401EDM-UL, FCV4E, FCV4EDS...(Other models you can see in the webshop)		
accessories for	541488		
	GEV No.	541507	Ref. No. 33T4110
	nozzle cooling thread 1/8"		
	GEV No.	541509	Ref. No. 33T3720
	nozzle cooling thread 1/8"		

ball valves with lever handle



1

GEV No.	540730	Ref. No.	33D0170
description	ball valve connection 3/4" IT - 3/4" IT DN20 total length 70mm with lever handle handle length 95mm		
For models:	030BME, 030EBM, 030FE, 031BME, 031EBM, 070BM, 070BME, 071BM, 071BME, 090BM, 090BME, 091BM, 091BME, 30F, 30FES, 30FS, 70FES		

producer-specific

ANGELO PO



1

GEV No.	514080	Ref. No.	33D1530
description	ball valve handle length 70mm L 83mm inlet 3/4" IT lever handle outlet ø30mm		



1

GEV No.	540687	Ref. No.	33D0890
description	ball valve inlet 1" ET outlet 1" IT L 92mm without handle shaft ø 13x10mm		
For models:	70F, 71F, 71FE		

valves and tank inlets

ball valves

universal

ball valves with butterfly handle



1

GEV No.	542182	Ref. No.	33A0850
description	ball valve connection 1/2" IT - 1/2" IT DN15 total length 50mm		



1



GEV No.	514392	Ref. No.	33D0250
description	ball valve inlet 1" IT outlet 1" IT L 69mm without handle shaft ø 9x12mm shaft L 54mm		



shut-off valves

universal





GEV No.	540694	Ref. No.	33D2040
description	shut-off valve connection 1/2" 1/2" without handle total length 124.5mm mounting pos. any shaft L 15mm rosette thread G2 1" shaft ø 7.8mm		
For models:	0A1CP1E, 0A1CP1G, 0B1CP1G, 0D1CP1E, 0D1CP1G, 191CP1GA, 1A1BR1E, 1A1BR1G, 1A1BR1GA, 1A1BR2E, 1A1BR2EA, 1A1BR2G, 1A1BR2GA, 1A1CP1G, 1A1CP1GA, 1A1CP2G, 1A1PD1G, 1A1PD2G, 1A1PI1G, 1A1PI1GA, 1A1PI2E, 1A1PI2EA, 1A1PI2G, 1A1PI2GA, 1A1PI2V, 1A1PI2VA, 1D1BR1E, 1D1BR1G, 1D1BR1GA, 1D1BR2E, 1D1BR2EA, 1D1BR2G, 1D1BR2GA, 1D1CP1G, 1D1CP1GA, 1D1CP2G, 1D1PD1G, 1D1PD2G, 1D1PI1G, 1D1PI1GA, 1D1PI2E, 1D1PI2EA, 1D1PI2G, 1D1PI2GA, 1D1PI2V, 1D1PI2VA, 2A1BR1E, 2A1BR1G, 2A1BR1GA, 2A1BR2E...(Other models you can see in the webshop)		
accessories for	540694		
	GEV No.	514090	Ref. No. —
	star handle cold/warm		
	GEV No.	520666	Ref. No. 36Q0590
	union nut thread 1/2" H 12mm		
	GEV No.	541818	Ref. No. —
	rosette chrome-plated thread 28x19G ø 58mm H 25mm WS		

producer-specific

ANGELO PO



GEV No.	514385	Ref. No.	3005990 33D2930
description	shut-off valve connection 3/8" 3/8" without handle mounting pos. any		
For models:	0A0BME, 0A0BMG, 0A1CP1E, 0A1CP1G, 0B1CP1G, 0D0BME, 0D0BMG, 0D1CP1E, 0D1CP1G, 0G1CP1E, 0G1CP1G, 191PD1G, 191PD2G, 191PI1G, 191PI1GA, 191PI2E, 191PI2EA, 191PI2G, 191PI2GA, 191PI2V, 191PI2VA, 1A0BME, 1A0BMG, 1A1BR1E, 1A1BR1G, 1A1BR1GA, 1A1BR2E, 1A1BR2EA, 1A1BR2G, 1A1BR2GA, 1A1CP1G, 1A1CP2G, 1A1PD1G, 1A1PD2G, 1A1PI1G, 1A1PI1GA, 1A1PI2E, 1A1PI2EA, 1A1PI2G, 1A1PI2GA, 1A1PI2V, 1A1PI2VA, 1D0BME, 1D0BMG, 1D1BR1E, 1D1BR1G, 1D1BR1GA, 1D1BR2E, 1D1BR2EA, 1D1BR2G...(Other models you can see in the webshop)		
spare parts for	514385		
	GEV No.	541533	Ref. No. —
	handle cold water H 39.5mm blue ID ø 32.5mm ED ø 50mm		
	GEV No.	541813	Ref. No. 36M2631 36M2632
	star handle cold total length 36mm shaft intake ø 8mm plastic for valve		

	GEV No.	541587	Ref. No.	6300728
description	shut-off valve connection 3/8" conversion kit			
For models:	1A1BR1E, 1A1BR1G, 1A1BR1GA, 1A1BR2E, 1A1BR2EA, 1A1BR2G, 1A1BR2GA, 1D1BR1E, 1D1BR1G, 1D1BR1GA, 1D1BR2E, 1D1BR2EA, 1D1BR2G, 1D1BR2GA, 2A1BR1E, 2A1BR1G, 2A1BR1GA, 2A1BR2E, 2A1BR2EA, 2A1BR2G, 2A1BR2GA, 2D1BR1E, 2D1BR1G, 2D1BR1GA, 2D1BR2E, 2D1BR2EA, 2D1BR2G, 2D1BR2GA			

	GEV No.	541588	Ref. No.	6300729
description	shut-off valve connection 3/8" conversion kit			
For models:	0A1CP1E, 0A1CP1G, 0D1CP1E, 0D1CP1G, 191CP1GA, 1A1CP1G, 1A1CP2G, 1D1CP1G, 1D1CP2G			

	GEV No.	541589	Ref. No.	6300727
description	shut-off valve connection 3/8" conversion kit			
For models:	0A0BME, 0A0BMG, 0D0BME, 0D0BMG, 1A0BME, 1A0BMG, 1D0BME, 1D0BMG			

	GEV No.	541584	Ref. No.	6300730
description	shut-off valve connection 3/8" conversion kit Qty 2 pcs			
For models:	1A1PD1G, 1A1PD2G, 1A1PI1G, 1A1PI1GA, 1D1PD1G, 1D1PD2G, 1D1PI1G, 1D1PI1GA			





1

GEV No.	541590	Ref. No.	6300731
description	shut-off valve connection 3/8" ET conversion kit total length 97mm		



1

GEV No.	540690	Ref. No.	33D0590
description	shut-off valve connection 3/8" total length 27mm mounting pos. angled shaft intake ø M4mm rosette thread G2 1" shaft star-shaped		
For models:	070BM, 070BME, 071BM, 071BME, 090BM, 090BME, 091BM, 091BME, 30CPS, 30CPE, 31PD6, 31PI6, 31PIE6, 70CP, 70CPE, 71AR, 71ARE, 71CP, 71CP2, 71PD10, 71PD15, 71PI10, 71PI10A, 71PIE15, 71PIE15A, 71PV15, 71PV15A, 71RA, 90CP, 90CPE, 91AR, 91ARE, 91CP, 91PI10, 91PI10A, 91PIE15, 91PIE15A, 91RA, ACBM, ACBM218, ANBM, ANBM218, ANBM75, SE14VB, SE21VB, SI14VB, SI21VB, SL14CVB, SL14NVB, SL21CVB...(Other models you can see in the webshop)		
spare parts for	540690		
	GEV No.	514357	Ref. No. 36M2642 36M4010
	description	tap handle hot water for valve plastic total length 36mm shaft diameter ø8mmmm	
	GEV No.	541813	Ref. No. 36M2631 36M2632
	description	star handle cold total length 36mm shaft intake ø 8mm plastic for valve	



1

GEV No.	541813	Ref. No.	36M2631 36M2632
description	star handle cold total length 36mm shaft intake ø 8mm plastic for valve		
For models:	191PD1G, 191PD2G, 191PI1G, 191PI1GA, 191PI2E, 191PI2EA, 191PI2G, 191PI2GA, 191PI2V, 191PI2VA, 1A1PD1G, 1A1PD2G, 1A1PI1G, 1A1PI1GA, 1A1PI2E, 1A1PI2EA, 1A1PI2V, 1A1PI2VA, 1D1PD1G, 1D1PD2G, 1D1PI1G, 1D1PI1GA, 1D1PI2E, 1D1PI2EA, 1D1PI2V, 1D1PI2VA, 1G1PD1G, 1G1PI1E, 1G1PI1G, 291PI3E, 291PI3G, 31PD6, 31PI6, 31PIE6, 71AR, 71ARE, 71PD10, 71PD15, 71PI10, 71PI10A, 71PIE15, 71PIE15A, 71PV15, 71PV15A, 71RA, 91AR, 91ARE, 91PI10, 91PI10A, 91PIE15...(Other models you can see in the webshop)		



1

GEV No.	514383	Ref. No.	36M2641
description	star handle hot total length 36mm shaft intake ø 8mm plastic for valve		
For models:	070BM, 070BME, 071BM, 071BME, 090BM, 090BME, 091BM, 091BME, 0A0BME, 0A0BMG, 0A1CP1E, 0A1CP1G, 0B1CP1G, 0D0BME, 0D0BMG, 0D1CP1E, 0D1CP1G, 0G1CP1E, 0G1CP1G, 191PD1G, 191PD2G, 191PI1G, 191PI1GA, 191PI2E, 191PI2EA, 191PI2G, 191PI2GA, 191PI2V, 191PI2VA, 1A0BME, 1A0BMG, 1A1BR1E, 1A1BR1G, 1A1BR1GA, 1A1BR2E, 1A1BR2EA, 1A1BR2G, 1A1BR2GA, 1A1CP1G, 1A1CP2G, 1A1PD1G, 1A1PD2G, 1A1PI1G, 1A1PI1GA, 1A1PI2E, 1A1PI2EA, 1A1PI2V, 1A1PI2VA, 1D0BME, 1D0BMG, 1D1BR1E, 1D1BR1G, 1D1BR1GA, 1D1BR2E, 1D1BR2EA, 1D1BR2G, 1D1BR2GA, 1D1CP1G, 1D1CP2G...(Other models you can see in the webshop)		



1

GEV No.	514357	Ref. No.	36M2642 36M4010
description	tap handle hot water for valve plastic total length 36mm shaft diameter ø8mmmm		
For models:	070BM, 070BME, 071BM, 071BME, 090BM, 090BME, 091BM, 091BME, 0A1CP1E, 0A1CP1G, 0B1CP1G, 0D1CP1E, 0D1CP1G, 1A1BR1E, 1A1BR1G, 1A1BR1GA, 1A1BR2E, 1A1BR2EA, 1A1BR2G, 1A1BR2GA, 1A1CP1G, 1A1CP2G, 1A1PD1G, 1A1PD2G, 1A1PI1G, 1A1PI1GA, 1A1PI2E, 1A1PI2EA, 1A1PI2G, 1A1PI2GA, 1A1PI2V, 1A1PI2VA, 1D1BR1E, 1D1BR1G, 1D1BR1GA, 1D1BR2E, 1D1BR2EA, 1D1BR2G, 1D1BR2GA, 1D1CP1G, 1D1CP2G, 1D1PD1G, 1D1PD2G, 1D1PI1G, 1D1PI1GA, 1D1PI2E, 1D1PI2EA, 1D1PI2G, 1D1PI2GA, 1D1PI2V...(Other models you can see in the webshop)		

accessories



1

GEV No.	540696	Ref. No.	36M4030
description	hood handle for valve blue		
For models:	04WBMEV, 191CP1GA, 1A1CP1GA, 1A1PD1G, 1A1PD2G, 1A1PI1G, 1A1PI1GA, 1A1PI2E, 1A1PI2EA, 1A1PI2G, 1A1PI2GA, 1A1PI2V, 1A1PI2VA, 1D1CP1GA, 1D1PD1G, 1D1PD2G, 1D1PI1G, 1D1PI1GA, 1D1PI2E, 1D1PI2EA, 1D1PI2G, 1D1PI2GA, 1D1PI2V, 1D1PI2VA, 291PD3G, 2A1PD3G, 2A1PI3E, 2A1PI3G, 2D1PI3G		



1

GEV No.	514438	Ref. No.	3162200
description	star handle plastic thread 7.5 ø 50mm H 50mm WS chrome-plated shaft star-shaped		
For models:	0A0BME, 0A0BMG, 0A1CP1E, 0A1CP1G, 0D0BME, 0D0BMG, 0D1CP1E, 0D1CP1G, 0G1CP1E, 0G1CP1G, 191PD1G, 191PD2G, 191PI1G, 191PI1GA, 191PI2E, 191PI2EA, 191PI2G, 191PI2GA, 191PI2V, 191PI2VA, 1A0BME, 1A0BMG, 1A1BR1E, 1A1BR1G, 1A1BR1GA, 1A1BR2E, 1A1BR2EA, 1A1BR2G, 1A1BR2GA, 1A1CP1G, 1A1CP2G, 1A1PD1G, 1A1PD2G, 1A1PI1G, 1A1PI1GA, 1A1PI2E, 1A1PI2EA, 1A1PI2V, 1A1PI2VA, 1D0BME, 1D0BMG, 1D1BR1E, 1D1BR1G, 1D1BR1GA, 1D1BR2E, 1D1BR2EA, 1D1BR2G, 1D1BR2GA, 1D1CP1G, 1D1CP2G...(Other models you can see in the webshop)		



steam valves





1

GEV No.	520000	Ref. No.	33G0030 33G0031
description	steam valve angled connection 1 1/4" IT total length 52mm H 190mm brass		
For models:	191PI2V, 191PI2VA, 1A1PI2V, 1A1PI2VA, 1D1PI2V, 1D1PI2VA, 71PV15, 71PV15A, PV200, PV200A, PV300, PV300A		
spare parts for	520000		
		GEV No.	541566
		Ref. No.	—
	tap head for steam tap 1 1/4" shaft 9x9mm		



1

GEV No.	514081	Ref. No.	3003440 3003441 33Q3500
description	inlet spout connection 3/8" ET tube ø 10mm projection 50mm overall height 56mm spout height 25mm rotation°		
For models:	04WCP1EM, 06WCP1GM, 08WCP1GM, 091CP1E, 091CP1G, 0A1CP1E, 0A1CP1G, 0B1CP1G, 0D1CP1E, 0D1CP1G, 0G1CP1E, 0G1CP1EC, 0G1CP1E-VERS.2004, 0G1CP1G, 0G1CP1G-VERS.2004, 191CP1G, 191CP2G, 1A1CP1G, 1A1CP2G, 1D1CP1G, 1D1CP2G, 1G1CP1G, 1G1CP1G-VERS.2004, 1G1CP2G, 1G1CP2G-VERS.2004, 6040090, 6040310, 6043850, 6043980		
accessories for	514081		
		GEV No.	503042
		Ref. No.	33Q2190 36Q1110
	nut thread 3/8" H 6mm brass WS 22 Qty 1 pcs		
		GEV No.	540682
		Ref. No.	3150840 37Q1210
	O-ring EPDM thickness 1.78mm ID ø 18.77mm Qty 1 pcs		

inlet taps



1

GEV No.	514078	Ref. No.	33Q2730
description	inlet spout connection 3/8" ET tube ø 10mm projection 48mm overall height 46mm spout height 25mm		
For models:	070BM, 070BME, 071BM, 071BME, 090BM, 090BME, 091BM, 091BME, 30CPS, 30CPE, 70CP, 70CPE, 71CP, 71CP2, 90CP, 90CPE, 91CP		
accessories for	514078		
		GEV No.	101278
		Ref. No.	36Q0080
	olive for pipe ø 10mm Qty 1 pcs		
		GEV No.	101478
		Ref. No.	—
	union nut thread 3/8" for pipe ø 10mm		
		GEV No.	506024
		Ref. No.	—
	nut thread 3/8" H 6mm SS WS 22 Qty 1 pcs		
		GEV No.	514079
		Ref. No.	3120740
	washer ED ø 30mm ID ø 17mm thickness 3mm		
		GEV No.	540682
		Ref. No.	3150840 37Q1210
	O-ring EPDM thickness 1.78mm ID ø 18.77mm Qty 1 pcs		





Image not available

1

GEV No.	541816	Ref. No.	33Q4690
description	inlet spout connection 3/8" IT for bain marie		
For models:	0A0BME, 0A0BMG, 0D0BME, 0D0BMG, 1A0BME, 1A0BMG, 1D0BME, 1D0BMG		



1

GEV No.	540693	Ref. No.	33Q2582
description	inlet spout for kettle type series 700/900		
For models:	31PD6, 31PI6, 31PIE6, 71PD10, 71PD15, 71PI10, 71PI10A, 71PIE15, 71PIE15A, 71PV15, 71PV15A, 91PI10, 91PI10A, 91PIE15, 91PIE15A		



			
GEV No.	540697	Ref. No.	3003430 33Q3570
description	inlet spout tube ø 18mm thread 1/2" IT for kettle		
For models:	191PD1G, 191PD2G, 191PI1G, 191PI1GA, 191PI2E, 191PI2EA, 191PI2G, 191PI2GA, 191PI2V, 191PI2VA, 1A1PD1G, 1A1PD2G, 1A1PI1G, 1A1PI1GA, 1A1PI2E, 1A1PI2EA, 1A1PI2G, 1A1PI2GA, 1A1PI2V, 1A1PI2VA, 1D1PD1G, 1D1PD2G, 1D1PI1G, 1D1PI1GA, 1D1PI2E, 1D1PI2EA, 1D1PI2G, 1D1PI2GA, 1D1PI2V, 1D1PI2VA, 1G1PD1G, 1G1PI1E, 1G1PI1G		

accessories

turning handles

			
GEV No.	540692	Ref. No.	36M2630
description	hood handle for valve blue		
For models:	1A1PD1G, 1A1PD2G, 1A1PI1G, 1A1PI1GA, 1A1PI2E, 1A1PI2EA, 1A1PI2V, 1A1PI2VA, 1D1PD1G, 1D1PD2G, 1D1PI1G, 1D1PI1GA, 1D1PI2E, 1D1PI2EA, 1D1PI2V, 1D1PI2VA, 1G1PD1G, 1G1PI1E, 1G1PI1G, 31PD6, 31PI6, 31PIE6, 71AR, 71ARE, 71PD10, 71PD15, 71PI10, 71PI10A, 71PIE15, 71PIE15A, 71PV15, 71PV15A, 71RA, 91AR, 91ARE, 91PI10, 91PI10A, 91PIE15, 91PIE15A, 91RA		

			
GEV No.	540696	Ref. No.	36M4030
description	hood handle for valve blue		
For models:	04WBMEV, 191CP1GA, 1A1CP1GA, 1A1PD1G, 1A1PD2G, 1A1PI1G, 1A1PI1GA, 1A1PI2E, 1A1PI2EA, 1A1PI2G, 1A1PI2GA, 1A1PI2V, 1A1PI2VA, 1D1CP1GA, 1D1PD1G, 1D1PD2G, 1D1PI1G, 1D1PI1GA, 1D1PI2E, 1D1PI2EA, 1D1PI2G, 1D1PI2GA, 1D1PI2V, 1D1PI2VA, 291PD3G, 2A1PD3G, 2A1PI3E, 2A1PI3G, 2D1PI3G		

			
GEV No.	540691	Ref. No.	36M2640
description	hood handle for valve red		
For models:	070BM, 070BME, 071BM, 071BME, 090BM, 090BME, 091BM, 091BME, 0A0BME, 0A0BMG, 0A1CP1E, 0A1CP1G, 0B1CP1G, 0D0BME, 0D0BMG, 0D1CP1E, 0D1CP1G, 0G1CP1E, 0G1CP1G, 1A0BME, 1A0BMG, 1A1BR1E, 1A1BR1G, 1A1BR1GA, 1A1BR2E, 1A1BR2EA, 1A1BR2G, 1A1BR2GA, 1A1CP1G, 1A1CP2G, 1A1PD1G, 1A1PD2G, 1A1PI1G, 1A1PI1GA, 1A1PI2E, 1A1PI2EA, 1A1PI2V, 1A1PI2VA, 1D0BME, 1D0BMG, 1D1BR1E, 1D1BR1G, 1D1BR1GA, 1D1BR2E, 1D1BR2EA, 1D1BR2G, 1D1BR2GA, 1D1CP1G, 1D1CP2G, 1D1PD1G...(Other models you can see in the webshop)		

beverage technology

valves

non-return valves

			
GEV No.	440729	Ref. No.	3114800
description	non-return valve John Guest pipe connection 5/16" - 5/16" operating pressure at 20°C 10bar opening pressure 0.02bar POM		
For models:	FM1011E3-VERS.2006, FM1011G3-VERS.2006, FM1221E3-VERS.2006, FM1221G3-VERS.2006, FM2011E3-VERS.2006, FM2011G3-VERS.2006, FM2021E3-VERS.2006, FM2021G3-VERS.2006, FM611E3-VERS.2006, FM611G3-VERS.2006, FM721E3-VERS.2006, FM721G3-VERS.2006, FX101E3, FX101E3C, FX101E3C-VERS.022014, FX101E3R, FX101E3R-VERS.022014, FX101E3-VERS.022014, FX101G3, FX101G3C, FX101G3C-VERS.022014, FX101G3R, FX101G3R-VERS.022014, FX101G3-VERS.022014, FX10E3CR, FX10E3CR-VERS.022014, FX10G3CR, FX10G3CR-VERS.022014, FX122E3, FX122E3C, FX122E3T, FX122E3T-VERS.022014, FX122G3, FX122G3C, FX122G3T, FX122G3T-VERS.022014, FX12E3CT, FX12E3CT-VERS.022014, FX12G3CT, FX12G3CT-VERS.022014, FX201E3, FX201E3P, FX201E3P-VERS.022014, FX201E3-VERS.022014, FX201G3P, FX201G3-VERS.022014, FX202E3, FX202E3-230V-3-50Hz-60Hz, FX202E3-230V-3-50Hz-60Hz-VERS.022014, FX202E3-VERS.022014...(Other models you can see in the webshop)		



water cycle components

pressure reduction valves

pressure reduction valves

universal



1

GEV No.	520271	Ref. No.	33D1650
description	pressure reduction valve connection 1/2" default setting 3bar setting range 1 up to 7bar p max 20bar t.max. 80°C		
For models:	BX101E, BX101E-VERS.122013, BX101G, BX101G-VERS.122013, BX122E, BX122E-VERS.122013, BX122G, BX122G-VERS.122013, BX61E, BX61E-VERS.122013, BX61G, BX61G-VERS.122013, BX82E, BX82E-VERS.122013, BX82G, BX82G-VERS.122013, FCV101, FCV101-CSA, FCV101DM, FCV101DM-CSA, FCV101DS, FCV101DS-CSA, FCV101E, FCV101EDM, FCV101EDM-UL, FCV101EDS, FCV101EDS-UL, FCV101E-UL, FCV141, FCV141-CSA, FCV141DM, FCV141DM-CSA, FCV141DS, FCV141DS-CSA, FCV141E, FCV141EDM, FCV141EDS, FCV241, FCV241DM, FCV241DS, FCV241E, FCV241EDM, FCV241EDM-UL, FCV241EDS, FCV241EDS-UL, FCV241E-UL, FCV241G, FCV241G-CSA, FCV241GDM, FCV241GDM-CSA...(Other models you can see in the webshop)		

supply filters



1

GEV No.	520261	Ref. No.	35Q2780
description	supply filter thread 1/2" IT - 1/2" IT total length 58mm red brass mesh opening 0.4mm		



1

GEV No.	520262	Ref. No.	33Q6090 33Q6091 35Q2790
description	supply filter thread 3/4" IT - 3/4" IT total length 70mm red brass DN20 mesh opening 0.4mm		

ancillary products

clamps

hose clamps

DIN 3017 - W2



1

GEV No.	520111	Ref. No.	36E4320
description	hose clamp ø 10-16mm width 9mm Qty 10 pcs DIN 3017		
For models:	FM1011E2-VERS.2006, FM1011E3, FM1011E3-VERS.2006, FM1011G2-VERS.2006, FM1011G3, FM1011G3-VERS.2006, FM1221E2-VERS.2006, FM1221E3, FM1221E3-VERS.2006, FM1221G2-VERS.2006, FM1221G3, FM1221G3-VERS.2006, FM2011E2-VERS.2006, FM2011E3-VERS.2006, FM2011G2-VERS.2006, FM2011G3-VERS.2006, FM2021E2-VERS.2006, FM2021E3, FM2021E3-VERS.2006, FM2021G2-VERS.2006, FM2021G3, FM2021G3-VERS.2006, FM423E2, FM611E2-VERS.2006, FM611E3, FM611E3-VERS.2006, FM611G2-VERS.2006, FM611G3, FM611G3-VERS.2006, FM721E2-VERS.2006, FM721E3, FM721E3-VERS.2006, FM721G2-VERS.2006, FM721G3, FM721G3-VERS.2006		



1

GEV No.	520115	Ref. No.	3140220
description	hose clamp ø 25-40mm width 9mm Qty 10 pcs DIN 3017		



1

GEV No.	520119	Ref. No.	3140200
description	hose clamp ø 60-80mm width 9mm Qty 5 pcs DIN 3017		
For models:	L100, L80, LP202, LP202HC, LP302, LP302HC, LP402, LP402HC, LP402V		



tools

hand tools

pullers



1

GEV No.	801197	Ref. No.	3018670 6003060
description	puller for fan wheel seat \varnothing 27-33mm thread M16x1.5 WS 17		
For models:	FM1011E1, FM1011E2, FM1011E3, FM1011G1, FM1011G2, FM1011G3, FM1221E1, FM1221E2, FM1221E3, FM1221G1, FM1221G2, FM1221G3, FM611E1, FM611E2, FM611E3, FM611G1, FM611G2, FM611G3		
spare parts for	801197		
	GEV No.	801198	Ref. No. 3019160
	screw for puller thread M16x1.5 L 63mm WS 17		



1

GEV No.	801198	Ref. No.	3019160
description	screw for puller thread M16x1.5 L 63mm WS 17		

measuring equipment

thermometers

built-in thermometers



1

GEV No.	541086	Ref. No.	32V1900 32z0020
description	thermometer mounting measurements 58x25.5mm 0 up to +120°C capillary pipe 2000mm probe \varnothing 6mm probe L 23mm		
For models:	LC100, LC100-VERS.2001, LC130, LC130-VERS.2001		



1

GEV No.	541305	Ref. No.	32V7230
description	thermometer mounting measurements 62x11mm +20 up to +120°C capillary pipe 1500mm probe \varnothing 6.5mm probe L 16mm		

\varnothing 52mm



1

GEV No.	541065	Ref. No.	32z2930
description	thermometer mounting \varnothing 52mm t.max. 120°C 0 up to +120°C probe \varnothing 6.5mm probe L 28mm capillary pipe 1500mm		



1

GEV No.	541347	Ref. No.	32Z0151
description	thermometer mounting \varnothing 52mm t.max. 350°C +50 up to +350°C probe \varnothing 4mm probe L 60mm capillary pipe 1000mm		
For models:	FC101, FC1011E, FC1011G, FC101E, FC1221E, FC1221G, FC241, FC241E, FC241G, FC61, FC611E, FC611G, FC61E		



1

GEV No.	541582	Ref. No.	32Z0040
description	thermometer mounting \varnothing 52mm t.max. 350°C +50 up to +350°C probe \varnothing 6mm probe L 17mm capillary pipe 1700mm		

\varnothing 60mm



1

GEV No.	541082	Ref. No.	32Z3190
description	thermometer mounting \varnothing 60mm t.max. 40°C -40 up to +40°C probe \varnothing 6mm probe L 135mm capillary pipe 2000mm		



external power supply			
1			
GEV No.	541193	Ref. No.	32Z3670 32Z3680
description	thermometer mounting measurements 58x25.5mm -40 up to +40°C cable length 2500mm probe ø 6mm probe L 40mm		
For models:	SA87		

fastening material

screws			
countersunk screws			
1			
GEV No.	698481	Ref. No.	31C0070
description	screw thread M4 L 8mm SS DIN 965/ISO 7046 Qty 1 pcs intake Phillips head ø 7mm		
For models:	LC100, LC100-VERS.2001, LC130, LC130-VERS.2001, LC80, LF50, LF50E, LF50EM, LF50EMPS		

hexagonal screws			
1			
GEV No.	506445	Ref. No.	3016470
description	hexagonal screw thread M10 thread L 35mm SS WS 17 Qty 1 pcs DIN 933 / ISO 4017		
For models:	BX101E, BX101E-VERS.122013, BX101G, BX101G-VERS.122013, BX122E, BX122E-VERS.122013, BX122G, BX122G-VERS.122013, BX61E, BX61E-VERS.122013, BX61G, BX61G-VERS.122013, BX82E, BX82E-VERS.122013, BX82G, BX82G-VERS.122013, FC1011E, FC1011G, FC1221E, FC1221G, FC611E, FC611G, FM1011E1, FM1011E1-VERS.2006, FM1011E2, FM1011E2-VERS.2006, FM1011E3, FM1011E3-VERS.2006, FM1011G1, FM1011G1-VERS.2006, FM1011G2, FM1011G2-VERS.2006, FM1011G3, FM1011G3-VERS.2006, FM1221E1, FM1221E1-VERS.2006, FM1221E2, FM1221E2-VERS.2006, FM1221E3, FM1221E3-VERS.2006, FM1221G1, FM1221G1-VERS.2006, FM1221G2, FM1221G2-VERS.2006, FM1221G3, FM1221G3-VERS.2006, FM2011E2-VERS.2006, FM2011E3-VERS.2006, FM2011G2-VERS.2006, FM2011G3-VERS.2006...(Other models you can see in the webshop)		

1			
GEV No.	560086	Ref. No.	31A0560
description	hexagonal screw thread M6 thread L 10mm SS WS 10 Qty 20 pcs DIN 933 / ISO 4017		
For models:	BX101E, BX101E-VERS.122013, BX101G, BX101G-VERS.122013, BX122E, BX122E-VERS.122013, BX122G, BX122G-VERS.122013, BX61E, BX61E-VERS.122013, BX61G, BX61G-VERS.122013, BX82E, BX82E-VERS.122013, BX82G, BX82G-VERS.122013, FX101E1, FX101E1R, FX101E2, FX101E2C, FX101E2C-VERS.032014, FX101E2R, FX101E2R-VERS.032014, FX101E2-VERS.032014, FX101E3, FX101E3C, FX101E3C-VERS.022014, FX101E3R, FX101E3R-VERS.022014, FX101E3-VERS.022014, FX101G1, FX101G1R, FX101G2, FX101G2C, FX101G2C-VERS.032014, FX101G2R, FX101G2R-VERS.032014, FX101G2-VERS.032014, FX101G3, FX101G3C, FX101G3C-VERS.022014, FX101G3R, FX101G3R-VERS.022014, FX101G3-VERS.022014, FX10E2CR, FX10E2CR-VERS.032014, FX10E3CR, FX10E3CR-VERS.022014, FX10G2CR, FX10G2CR-VERS.032014...(Other models you can see in the webshop)		

grub screws			
DIN 914/ISO 4027			
1			
GEV No.	560224	Ref. No.	31W0020
description	grub screw thread M8 L 10mm WS 4 Qty 1 pcs		
For models:	1A1BR1E, 1A1BR1G, 1A1BR2E, 1A1BR2G, 1D1BR1E, 1D1BR1G, 1D1BR2E, 1D1BR2G, 1G1BR1E, 1G1BR1G, 2A1BR1E, 2A1BR1G, 2A1BR2E, 2A1BR2G, 2D1BR1E, 2D1BR1G, 2D1BR2E, 2D1BR2G, 31R, 31RE		

knurled screws						
1						
GEV No.	524804	Ref. No.	3036730			
description	Thumb screw thread M5 thread L 7mm ø 30mm H 5mm SS Qty 1 pcs					
For models:	KD100, KD100A, KD100PSD, KD130, KD130A, KD130E, KD130EAT, KD40EPSD, KD40LEPS, KD40LUXE, KD60, KD60E, KD60EAT, KD60M, KD60MA, KD60ME, KD60MPS, KD60MPSA, KD60PS, KD60PSD, KD6E-ATSD, KD85, KD85A, KD85E, KD85EA, KD85EAT, KD85EATS, KD85EPS, KD85EPSA, KD85PS, KD85PSA, KN1100, KN1100SD, KN11PSDD, KN80, KN80PS, LP151, LP202, LP202HC, LP302, LP302HC, LP402, LP402HC, LP402V, LP70					
accessories for	524804					
		<table border="1"> <tr> <td>GEV No.</td> <td>505277</td> <td>Ref. No.</td> <td>3036720 33q6400</td> </tr> </table>	GEV No.	505277	Ref. No.	3036720 33q6400
GEV No.	505277	Ref. No.	3036720 33q6400			
	rinse arm shaft warewashing ø 14mm H 38mm thread 1/4"					

miscellaneous			
1			
GEV No.	514285	Ref. No.	3190040
description	screw		
For models:	090GRG, 190GRG, FC101, FC1011E, FC1011G, FC101E, FC1221E, FC1221G, FC241, FC241E, FC241G, FC61, FC611E, FC611G, FC61E, FCV101, FCV101-CSA, FCV101DM, FCV101DM-CSA, FCV101DS, FCV101DS-CSA, FCV101E, FCV101EDM, FCV101EDM-UL, FCV101EDS, FCV101EDS-UL, FCV101E-UL, FCV141, FCV141-CSA, FCV141DM, FCV141DM-CSA, FCV141DS, FCV141DS-CSA, FCV141E, FCV141EDM, FCV141EDS, FCV241, FCV241DM, FCV241DS, FCV241E, FCV241EDM, FCV241EDM-UL, FCV241EDS, FCV241EDS-UL, FCV241E-UL, FCV241G, FCV241G-CSA, FCV241GDM, FCV241GDM-CSA, FCV241GDS...(Other models you can see in the webshop)		



1

GEV No.	691459	Ref. No.	3190020
description	screw thread M6 L 10mm WS 14		
For models:	FC101, FC1011E, FC1011G, FC101E, FC1221E, FC1221G, FC241, FC241E, FC241G, FC61, FC611E, FC611G, FC61E, FCV101, FCV101-CSA, FCV101DM, FCV101DM-CSA, FCV101DS, FCV101DS-CSA, FCV101E, FCV101EDM, FCV101EDM-UL, FCV101EDS, FCV101EDS-UL, FCV101E-UL, FCV141, FCV141-CSA, FCV141DM, FCV141DM-CSA, FCV141DS, FCV141DS-CSA, FCV141E, FCV141EDM, FCV141EDS, FCV241, FCV241DM, FCV241DS, FCV241E, FCV241EDM, FCV241EDM-UL, FCV241EDS, FCV241EDS-UL, FCV241E-UL, FCV241G, FCV241G-CSA, FCV241GDM, FCV241GDM-CSA, FCV241GDS, FCV241GDS-CSA, FCV3EM...(Other models you can see in the webshop)		

hexagonal nuts metric (without norm)



1

GEV No.	521103	Ref. No.	N/A
description	nut thread M4 H 3mm WS 7 brass Qty 20 pcs		

nuts

wing nuts



1

GEV No.	560147	Ref. No.	33Q3200
description	wing nuts thread M6 SS DIN/ISO DIN 315 Qty 20 pcs		
For models:	LT10R, LT20F, LT25F		

hexagonal nuts inch thread



1

GEV No.	517180	Ref. No.	3030170
description	nut thread 1" H 5mm WS 36 SS Qty 1 pcs		
For models:	KD37, KD37PS, KD37-VERS.112009, KD40, LP202, LP202HC, LP302, LP302HC, LP402, LP402HC, LP402V, LPG300, N100D, N100S, N100VD, N100VS, N38D, N38S, N38VD, N38VS, N42D, N42S, N42VD, N42VS, N50D, N50S, N50VD, N50VS, N66D, N66S, N66VD, N66VS, N70D, N70S, N70VD, N70VS, N85D, N85S, N85VD, N85VS		

knurled nuts



1

GEV No.	519386	Ref. No.	3190800
description	knurled nut for glass plate thread M4		
For models:	BRPRV, BRVRV, SE14PRV, SE14PRW, SE14VRV, SE14VRW, SI14PRV, SI14PRW, SI14VRV, SI14VRW, SL14RPRV, SL14RPRW, SL14RVRV, SL14RVRW, TPRV, TVRV		



1

GEV No.	503155	Ref. No.	33Q4410
description	nut thread 1/2" H 7mm WS 25 brass Qty 1 pcs		
For models:	LT10R, LT20F, LT25F		

hexagonal nuts

DIN 934 / ISO 4032/8673



1

GEV No.	517174	Ref. No.	3110050 33Q6470
description	nut thread M8 H 6.5mm WS 13 SS DIN/ISO DIN 934 / ISO 4032/8673 Qty 1 pcs		



1

GEV No.	361182	Ref. No.	3117580
description	nut thread 1/4" H 5mm nickel-plated brass WS 17 Qty 1 pcs		
For models:	L100, L40, L40S, L60, L80, P5		



1

GEV No.	503042	Ref. No.	33Q2190 36Q1110
description	nut thread 3/8" H 6mm brass WS 22 Qty 1 pcs		
For models:	030FT, 030FTR, 031FT, 031FT04, 031FT06, 031FTR, 031FTRL, 04WB-MEV, 06WFR3GD, 070BM, 070BME, 070FT, 070FT04, 070FT05, 070FTR, 0712VA, 071BM, 071BME, 071FT, 071FT04, 071FT06, 071FTR, 071FTRL, 08WGREV, 090BM, 090BM1E, 090BM1G, 090BME, 090FAVA, 090FT, 090FT04, 090FT05, 090FT1G, 090FT2G, 090FT4G, 090FT5G, 090FT7G, 090FTR, 091BM, 091BME, 091CP1E, 091CP1G, 091FR1EA, 091FR1EX, 091FR1I, 091FR1IA, 091FR1ID, 091FR1ID-VERS.052012, 091FR1I-VERS.032012, 091FR7G...(Other models you can see in the webshop)		



1			
GEV No.	511182	Ref. No.	33Q2190
description	nut thread 3/8" H 8mm brass WS 24 Qty 1 pcs		
For models:	C165D, C165S, C165VD, C165VS, C207D, C207D-VERS.2006, C207S, C207S-VERS.2006, C207VD, C207VD-VERS.2006, C207VS, C207VS-VERS.2006, C304AD, C304AD-VERS.2006, C304AS, C304AS-VERS.2006, C304AVD, C304AVD-VERS.2006, C304AVS, C304AVS-VERS.2006, C304D, C304D-VERS.2006, C304S, C304S-VERS.2006, C304VD, C304VD-VERS.2006, C304VS, C304VS-VERS.2006, C92D-VERS.2006, C92S-VERS.2006, C92VD-VERS.2006, C92VS-VERS.2006, CS243D, CS243D-VERS.2006, CS243S, CS243S-VERS.2006, CS243VD, CS243VD-VERS.2006, CS243VS, CS243VS-VERS.2006, CS370AD, CS370AD-VERS.2006, CS370AS, CS370AS-VERS.2006, CS370AVD, CS370AVD-VERS.2006, CS370AVS, CS370AVS-VERS.2006, CS370D, CS370D-VERS.2006...(Other models you can see in the webshop)		

1			
GEV No.	511309	Ref. No.	33Q0240
description	nut thread 1 1/2" ø 66mm H 9mm WS 51 brass Qty 1 pcs		
For models:	L100, L40, L40S, L60, L80		

<p>union nuts</p>			
1			
GEV No.	520667	Ref. No.	36Q0100
description	union nut thread 1/4" H 11mm steel WS 17 Qty 1 pcs		

<p>washers</p> <p>spring rings</p>			
1			
GEV No.	560209	Ref. No.	3000860
description	lock washer ID ø 10.3mm ED ø 17.2mm SS Qty 1 pcs for thread M10		
For models:	08WGGRV, 090GRG, 0A0GRG, 0D0GRG, 190GRG, 1A0GRG, 1D0GRG		

<p>washers</p> <p>DIN 125A</p>			
1			
GEV No.	560312	Ref. No.	3120080
description	plain washer ID ø 10.5mm ED ø 20mm thickness 2mm SS Qty 1 pcs DIN 125A for thread M10		
For models:	10CP1EA, 10CP1GA, 10CP1IA, 12CP1EA, 12CP1GA, 12CP1IA, 18CP2EA, 18CP2GA, 18CP2IA, BRE21HD, BRE31HD, FCV101-CSA, FCV101DM-CSA, FCV101DS-CSA, FCV101EDM-UL, FCV101EDS-UL, FCV101E-UL, FCV141-CSA, FCV141DM-CSA, FCV141DS-CSA, FCV241EDM-UL, FCV241EDS-UL, FCV241E-UL, FCV401DM-CSA, FCV401EDM-UL, FCV61-CSA, FCV61DM-CSA, FCV61DS-CSA, FCV61EDM-UL, FCV61EDS-UL, FCV61E-UL, FCV72EDS-UL, FCV72E-UL, PIER06HD, PIER10HD, PIER15HD		

1			
GEV No.	560113	Ref. No.	3121480
description	plain washer ID ø 6.4mm ED ø 12mm thickness 1.6mm SS Qty 20 pcs DIN 125A for thread M6		
For models:	030FE1, 30F1, 30FES2, 30FS2, 70F1, 70FE1, 70FES2, 70FES2B, 71F2, 71FE2, 91F210		

<p>DIN 9021</p>			
1			
GEV No.	560210	Ref. No.	3014810
description	plain washer ID ø 11mm ED ø 30mm thickness 2mm SS Qty 1 pcs DIN 9021 for thread M10		
For models:	FC1011E, FC1011G, FC1221E, FC1221G, FC611E, FC611G, FM1011E1, FM1011E1-VERS.2006, FM1011E2, FM1011E2-VERS.2006, FM1011E3, FM1011E3-VERS.2006, FM1011G1, FM1011G1-VERS.2006, FM1011G2, FM1011G2-VERS.2006, FM1011G3, FM1011G3-VERS.2006, FM1221E1, FM1221E1-VERS.2006, FM1221E2, FM1221E2-VERS.2006, FM1221E3, FM1221E3-VERS.2006, FM1221G1, FM1221G1-VERS.2006, FM1221G2, FM1221G2-VERS.2006, FM1221G3, FM1221G3-VERS.2006, FM2011E2-VERS.2006, FM2011E3-VERS.2006, FM2011G2-VERS.2006, FM2011G3-VERS.2006, FM2021E1, FM2021E2, FM2021E2-VERS.2006, FM2021E3, FM2021E3-VERS.2006, FM2021G1, FM2021G2, FM2021G2-VERS.2006, FM2021G3, FM2021G3-VERS.2006, FM611E1, FM611E1-VERS.2006, FM611E2, FM611E2-VERS.2006, FM611E3, FM611E3-VERS.2006...(Other models you can see in the webshop)		

<p>miscellaneous</p>			
1			
GEV No.	690687	Ref. No.	36D2880
description	plain washer		
For models:	40, 40B, 40CP, 40CPX, 40PL, 40X, SA87		



GEV No.	691180	Ref. No.	3120100
description	plain washer		
For models:	10CP1EA, 10CP1GA, 10CP1IA, 12CP1EA, 12CP1GA, 12CP1IA, 18CP2EA, 18CP2GA, 18CP2IA, C304AD, C304AS, C304AVD, C304AVS, CS370AD, CS370AS, CS370AVD, CS370AVS, CS466AD, CS466AS, CS466AVD, CS466AVS, FCV101DM, FCV101DM-CSA, FCV101DS, FCV101DS-CSA, FCV101EDM, FCV101EDM-UL, FCV101EDS, FCV101EDS-UL, FCV141DM, FCV141DM-CSA, FCV141DS, FCV141DS-CSA, FCV141EDM, FCV141EDS, FCV241DM, FCV241DS, FCV241EDM, FCV241EDM-UL, FCV241EDS, FCV241EDS-UL, FCV241GDM, FCV241GDM-CSA, FCV241GDS, FCV241GDS-CSA, FCV401DM, FCV401DM-CSA, FCV401EDM, FCV401EDM-UL, FCV4EDS...(Other models you can see in the webshop)		

GEV No.	506160	Ref. No.	3120050
description	plain washer ID ø 8.6mm ED ø 16mm thickness 1.5mm SS Qty 1 pcs		
For models:	091FR1EX, 091FR7GS, 091FR7GX, BRE21HD, BRE31HD, FM1011E2-VERS.2006, FM1011E3-VERS.2006, FM1011G2-VERS.2006, FM1011G3-VERS.2006, FM1221E2-VERS.2006, FM1221E3-VERS.2006, FM1221G2-VERS.2006, FM1221G3-VERS.2006, FM611E2-VERS.2006, FM611E3-VERS.2006, FM611G2-VERS.2006, FM611G3-VERS.2006, FM721E3-VERS.2006, FM721G3-VERS.2006, FX101E2C, FX101E3C, FX101G2C, FX101G3C, FX10E2CR, FX10E3CR, FX10G2CR, FX10G3CR, FX122E2C, FX122E3, FX122E3C, FX122E3T, FX122E3T-VERS.022014, FX122G2C, FX122G3, FX122G3C, FX122G3T, FX122G3T-VERS.022014, FX12E3CT, FX12E3CT-VERS.022014, FX12G3CT, FX12G3CT-VERS.022014, FX61E2C, FX61E2CR, FX61E3CR, FX61G2C, FX61G2CR, FX61G3C, FX61G3CR, FX82E2C, FX82E3C...(Other models you can see in the webshop)		

fasteners

clamps

hose clamps

DIN 3017 - W2

GEV No.	520111	Ref. No.	36E4320
description	hose clamp ø 10-16mm width 9mm Qty 10 pcs DIN 3017		
For models:	FM1011E2-VERS.2006, FM1011E3, FM1011E3-VERS.2006, FM1011G2-VERS.2006, FM1011G3, FM1011G3-VERS.2006, FM1221E2-VERS.2006, FM1221E3, FM1221E3-VERS.2006, FM1221G2-VERS.2006, FM1221G3, FM1221G3-VERS.2006, FM2011E2-VERS.2006, FM2011E3-VERS.2006, FM2011G2-VERS.2006, FM2011G3-VERS.2006, FM2021E2-VERS.2006, FM2021E3, FM2021E3-VERS.2006, FM2021G2-VERS.2006, FM2021G3, FM2021G3-VERS.2006, FM423E2, FM611E2-VERS.2006, FM611E3, FM611E3-VERS.2006, FM611G2-VERS.2006, FM611G3, FM611G3-VERS.2006, FM721E2-VERS.2006, FM721E3, FM721E3-VERS.2006, FM721G2-VERS.2006, FM721G3, FM721G3-VERS.2006		

GEV No.	520115	Ref. No.	3140220
description	hose clamp ø 25-40mm width 9mm Qty 10 pcs DIN 3017		

GEV No.	520119	Ref. No.	3140200
description	hose clamp ø 60-80mm width 9mm Qty 5 pcs DIN 3017		
For models:	L100, L80, LP202, LP202HC, LP302, LP302HC, LP402, LP402HC, LP402V		

retaining rings

DIN 6799

GEV No.	518557	Ref. No.	3120460
description	retaining ring E D1 ø 5mm D2 ø 11mm SS DIN 6799 thickness 0.7mm		
For models:	04WFAAV, 04WVT1IV, 04WVT2IV, 08WFA4E, 08WFA4G, 08WFAAE, 08WFAAG, 08WFAAV, 08WVT1IV, 08WVT2IV, 090FAA, 091VT1I, 091VT2I, 0A0FA1, 0A0FA4, 0A0FAA, 0A1VT1I, 0A1VT2I, 0D0FA1, 0D0FA4, 0D0FAA, 0D1VT1I, 0D1VT2I, 0G0FA0, 12WFA6E, 12WFA6G, 12WFAAA, 12WFAAE, 12WFAAG, 12WFAAN, 190FA, 190FAA, 190FAB, 190FAD, 191FAAE, 191FAAG, 191FABG, 191FADG, 191FAE, 191FAG, 191VT1I, 191VT2I, 1A0FA1, 1A0FA2, 1A0FA4, 1A0FA5, 1A0FAA, 1A0FAB, 1A1FA1G, 1A1FA2G...(Other models you can see in the webshop)		

roll pins

GEV No.	691398	Ref. No.	31Z8930
description	roll pin ø 3mm L 16mm		
For models:	0A0BMG, 0A0FT1G, 0A0FT2G, 0A0FT4G, 0A0FT5G, 0D0BMG, 0D0FT1G, 0D0FT2G, 0D0FT4G, 0D0FT5G, 1A0BMG, 1A0FT1G, 1A0FT2G, 1A0FT3G, 1A0FT4G, 1A0FT6G, 1A1BR1G, 1A1BR1GA, 1A1BR2G, 1A1BR2GA, 1A1FA1G, 1A1FA2G, 1A1FA4G, 1A1FA5G, 1A1FAS2G, 1A1FASG, 1A1TP0G, 1A1TP0G-VERS.2002, 1B1FAS2G, 1B1FASG, 1D0B-MG, 1D0FT1G, 1D0FT2G, 1D0FT3G, 1D0FT4G, 1D0FT6G, 1D1BR1G, 1D1BR1GA, 1D1BR2G, 1D1BR2GA, 1D1FA1G, 1D1FA2G, 1D1FA4G, 1D1FA5G, 1D1FAS2G, 1D1FASG, 1D1TP0G, 1D1TP0G-VERS.2002, 2A1BR1G, 2A1BR1GA...(Other models you can see in the webshop)		



screw caps



1			
GEV No.	512516	Ref. No.	3005450
description	screw cap thread 1/2" thread L 8mm SS Qty 1 WS 17 head thickness 4.5mm		
For models:	FM1011E3, FM1011G3, FM1221E3, FM611E3, FM611G3, FM721E3, FM721G3		

consumables

lava rocks / ceramic briquetts



1			
GEV No.	211049	Ref. No.	37T1320
description	ceramic briquetts size 50x50x26mm Qty 40 pieces (2.4kg)		
For models:	08WGRGV, 090GRG, 0A0GRG, 0D0GRG, 190GRG, 1A0GRG, 1D0GRG, 1G0GRG, 6042120-08WGRGV		

fuses

fine fuses



1			
GEV No.	358668	Ref. No.	3201540
description	fine fuse size ø5x20mm 0.5A fast-acting rated 250V Qty 10 pcs		
For models:	04WFR3ED, 08WFR4ED, 08WGREV, 091FR3ED, 0A1FR1ED, 0A1FR3ED, 0D1FR1ED, 0D1FR3ED, 0G0FR3ED, 10CP1EA, 10CP1GA, 10CP1IA, 12CP1EA, 12CP1GA, 12CP1IA, 18CP2EA, 18CP2GA, 18CP2IA, 191FR4ED, 1A1FR2ED, 1A1FR4ED, 1D1FR2ED, 1D1FR4ED, 71RA, 91RA, FC101, FC101E, FC101G, FC101E, FC1221E, FC1221G, FC241, FC241E, FC241G, FC61, FC61E, FC61G, FC61E, FCV101, FCV101DM, FCV101DS, FCV101E, FCV101EDM, FCV101EDS, FCV141, FCV141DM, FCV141DS, FCV141E, FCV141EDM, FCV141EDS...(Other models you can see in the webshop)		



1			
GEV No.	358671	Ref. No.	3200020
description	fine fuse size ø5x20mm 1A fast-acting rated 250V Qty 10 pcs		
For models:	06WBR3E, 0G1BR3E, 191BR1E, 191BR1GA, 191BR2E, 191BR2EA, 191BR2GA, 1A1BR1E, 1A1BR1GA, 1A1BR2E, 1A1BR2EA, 1A1BR2GA, 1D1BR1E, 1D1BR1GA, 1D1BR2E, 1D1BR2EA, 1D1BR2GA, 1G1BR3E, 291BR1E, 291BR1GA, 291BR2E, 291BR2EA, 291BR2GA, 2A1BR1E, 2A1BR1GA, 2A1BR2E, 2A1BR2EA, 2A1BR2GA, 2D1BR1E, 2D1BR1GA, 2D1BR2E, 2D1BR2EA, 2D1BR2GA, 71ARE, 91ARE, FCV401DM, FCV401EDM		

ø10x38mm 500V



1			
GEV No.	358031	Ref. No.	32V6210
description	fine fuse size ø10x38mm 10A rated 500V type Gg fast-acting Qty 1 pcs		
For models:	BX101E, BX101E-VERS.122013, BX122E, BX122E-VERS.122013, BX61E, BX61E-VERS.122013, BX82E, BX82E-VERS.122013, FC1011E, FC1221E, FC611E, FM1011E1, FM1011E1-VERS.2006, FM1011E2, FM1011E2-VERS.2006, FM1011E3, FM1011E3-VERS.2006, FM1221E1, FM1221E1-VERS.2006, FM1221E2, FM1221E2-VERS.2006, FM1221E3-VERS.2006, FM2011E2-VERS.2006, FM2011E3-VERS.2006, FM2021E1, FM2021E2, FM2021E2-VERS.2006, FM2021E3, FM2021E3-VERS.2006, FM611E1, FM611E1-VERS.2006, FM611E2, FM611E2-VERS.2006, FM611E3, FM611E3-VERS.2006, FM721E1, FM721E1-VERS.2006, FM721E2, FM721E2-VERS.2006, FM721E3, FM721E3-VERS.2006, FX101E1, FX101E1R, FX101E2, FX101E2C, FX101E2C-VERS.032014, FX101E2R, FX101E2R-VERS.032014, FX101E2-VERS.032014, FX101E3...(Other models you can see in the webshop)		

A			
alarm devices	59		
axial fans	90		
B			
ball valves	290		
bar burners	158		
beverage technology	294		
bi-metal thermostats	19, 19		
booster pumps I	106		
C			
cables	109		
cam switches	41		
clamps	34, 295, 300		
coil heating elements	9		
cold air circulating fans (complete)	94		
compressors	88		
condensators & interference suppression filters	107		
condensing trays heated	90		
connection cables	110		
consumables	301		
contactors	60		
container filters	283		
control equipment	45		
control thermostats	20, 30		
countersunk screws	297		
cross flow fans	94		
D			
defrost timers	59		
door catches	230		
door seals	263		
door seals for dishwashers	273		
dosing pumps	280		
double nipples	287		
drain hoses	284		
drain pumps	106		
E			
earthing cables	109		
edgemount latches	229		
electric accessories	109		
electronic controllers	64		
energy regulators	19		
espagnolette locks	230		
evaporators	275		
expansion valves	274		
F			
fans	90		
fasteners	300		
		fastening material	297
		filter driers	275
		filters	108
		fine fuses	301
		fittings	287
		float switches	41
		foam rubber gaskets	272
		forced air burners	162
		formed hoses	285
		fridge lamps	51
		fuses	109, 301
G			
		gas burners	148
		gas control valves	127
		gas lines	177
		gas nozzles	162
		gas solenoid valves	132
		gas taps	112
		gas thermostats	118
		gaskets for heated units	262
		gaskets for tray rack trolleys	266
		gaskets for wash arm support	274
		gastronorm	279
		grates	252
		grub screws	297
H			
		halogen lamp	51
		hand tools	296
		handle latches	229
		heater battery	9
		heating cables	8
		heating cartridges	9
		heating elements	3
		heating elements for bain maries	4
		heating elements for chargrills	8
		heating elements for convection	16
		heating elements for defrosting	7
		heating elements for fryers	5
		heating elements for griddles	6
		heating elements for heating bridges	8
		heating elements for ovens	3
		heating elements for pasta cookers	7
		heating elements for refrigeration	7
		heating elements for salamanders/toasters	8
		heating elements for tilting bratt pan	7
		hexagonal nuts	298
		hexagonal screws	297
		hob burners	148
		hose clamps	295, 300
		hose connectors	286, 288

hose couplings	283	pressure switches	85
hoses	284	probe clips	34
hot air fans	99	probes	68
hot air motors	95	programme timers	55
hot plates	18	PU hoses	285
I		pullers	296
ignition boxes	131	pumps	100
ignition cables	143	pumps for ice machines	107
ignition units	145	push/momentary push switches	35
immersion heating elements	10	PVC supply hoses	284
indicator lights	48	R	
indicator lights (complete)	48	radial fans	99
industrial hoses	284	radiation heaters	17
inlet spouts	293	reducers	287
inlet taps	293	refrigeration cycle components	274
K		refrigeration fans	91
knurled nuts	298	refrigeration gaskets	256
knurled screws	297	refrigeration motors universal	91
L		refrigeration thermostats	32
lamp accessories	55	relays	62
lamps	48	retaining rings	300
lava rocks / ceramic briquettes	178, 301	ribbon cables	110
light bulbs	50	rocker/momentary rocker switches	35
M		roll pins	300
magnetic switches	44	rotary switches	43
measuring equipment	296	S	
mechanical timers	58	safety bi-metal thermostats	19
microswitches	37	safety thermostats	23, 31
N		safety valves	132
Niplaflex hoses	284	screw caps	301
non-return valves	294	screw-in gaskets	260
nuts	298	screws	297
O		sealing washers	270
operating capacitors	108	shaft gaskets	272
O-rings	267	shelves and shelf rails	252
oven hinges	234	shut-off valves	291
oven lamps	51	snap locks	230
P		solenoid valves	76
piano hinges	231	solid top burners	161
piezoelectric igniters	144	spray guns	280
pilot burners	132	spray guns with external thread	280
plug connectors	110, 110	spring assisted hinges	231
plug-in gaskets	256	spring rings	299
position switches	40	starting capacitors	107
pressure control hoses	284	steam valves	293
pressure reduction valves	295, 295	supply filters	295, 295
		supply hoses	284
		switches and momentary switches	35
		system switches (ROLD)	40

T

temperature probes	68
terminals	110
terminals and connectors	110
thermocouples	146
thermostat gaskets	274
thermostats	19
timers	55
tools	296
transformers	63
tube burners	161
turning lever locks	223

U

union nuts	299
universal probes	68

V

valves	294
valves and tank inlets	290
vibration pumps	107

W

wash and rinse pumps	100
washers	299
water cycle components	295
window seals	262
wing nuts	298