



GAS COMPONENTS



ELECTRIC COMPONENTS



WATER TECHNOLOGY



MECHANICAL COMPONENTS



TOOLS

Spare parts suitable for

AMBACH

Find the complete and up-to-date range of products in our GEV Webshop



Manufacturer catalogue

The most important spare parts and accessories arranged clearly for every manufacturer

- ✓ Complete product range and all appliance data always up to date in the GEV Webshop
- ✓ Alphabetical Index at the end of the catalogue

GEV Webshop

www.gev-online.co.uk

www.gev-online.com



- 🔍 Add to Favourites
- 🔍 Sign In with email address and usual password
- 🔍 Easy-order – place several items in your basket at the same time
- 🔍 Quick Item search – no login needed



heating elements

heating elements for ovens

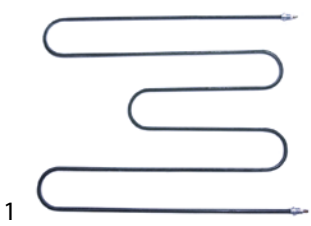

1

GEV No.	415858	Ref. No.	5060804030
description	heating element 1500W 230V L 540mm W 476mm thread 1/4" mounting distance 468mm tube ø 8.5mm connection M4 2 hole fixing dry heating element heating circuits 1		

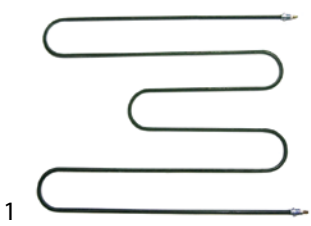

1

GEV No.	415372	Ref. No.	5060804027
description	heating element 1500W 400V L 540mm W 476mm thread 1/4" mounting distance 468mm tube ø 8.5mm connection M5 2 hole fixing dry heating element heating circuits 1		
For models:	EHE-70, GZE-70		



1

GEV No.	415860	Ref. No.	5060808561
description	heating element 1500W 400V L 560mm W 473mm flange length 70mm flange width 22mm hole distance 56mm hole ø 3mm tube ø 8.5mm connection length 11mm connection male faston 6.3mm heating circuits 1 rectangular flange dry heating element		
For models:	EKE-70, ERE-105, ERE-70, EREC-105, GKE-70, GRE-105, GRE-70, GREC-105, SIE-105, SIEC-105		
accessories for	415860		
	GEV No.	510368	Ref. No. —
	gasket L 70mm W 23.5mm hole ø 5mm hole distance 56mm FIBER thickness 2mm for heating element		

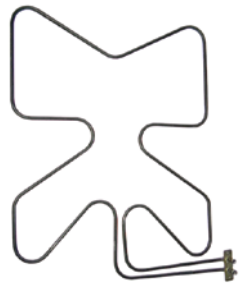

1

GEV No.	415864	Ref. No.	5060804349
description	heating element 2000W 400V L 570mm W 445mm W1 33mm flange length 70mm flange width 22mm hole distance 29mm hole ø 3mm tube ø 8.5mm connection M5 heating circuits 1 rectangular flange dry heating element		
For models:	CHE-80, EHE-80, EPE-80, EPSE-80, GHE-120, GHE-80, GPSE-80, HEE-81, UBE-90, UBE-90-D		
accessories for	415864		
	GEV No.	510368	Ref. No. —
	gasket L 70mm W 23.5mm hole ø 5mm hole distance 56mm FIBER thickness 2mm for heating element		

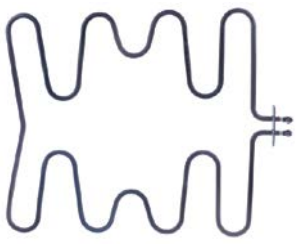



1

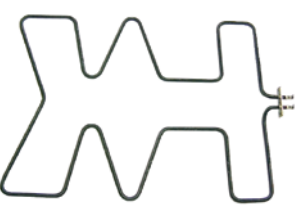

GEV No.	416950	Ref. No.	5060815275
description	heating element 3000W 400V heating circuits 1 L 453mm W 403mm L1 30mm L2 426mm W1 182mm W2 35mm flange length 70mm flange width 22mm hole distance 56mm hole ø 3mm tube ø 8.5mm connection M5 connection length 23mm windings 8 rectangular flange dry heating element oven		
For models:	UBE-90, UBE-90-D		



1

GEV No.	415861	Ref. No.	5060825601
description	heating element 3000W 400V heating circuits 1 L 607mm W 447mm L1 25mm L2 580mm W1 200mm W2 32mm flange length 70mm flange width 22mm hole distance 28mm hole ø 3.5mm tube ø 8.5mm connection M5 rectangular flange dry heating element		
For models:	CHE-80, EHE-80, EKE-70, EPSE-80, ERE-105, ERE-70, EREC-105, GHE-120, GHE-80, GKE-70, GPSE-80, GRE-105, GRE-70, GREC-105, SIE-105, SIEC-105		
accessories for	415861		
	GEV No.	510368	Ref. No. —
	gasket L 70mm W 23.5mm hole ø 5mm hole distance 56mm FIBER thickness 2mm for heating element		
	GEV No.	699566	Ref. No. —
	connection terminal for heating element		

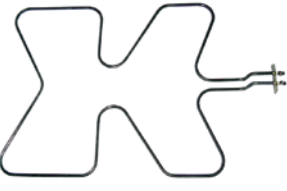

			
1			
GEV No.	415865	Ref. No.	5060804348
description	heating element 3000W 400V heating circuits 1 L 670mm W 445mm L1 173mm L2 525mm W1 208mm W2 30mm flange length 70mm flange width 22mm hole distance 57mm tube ø 8.5mm connection M4 rectangular flange mounting thread M4		
For models:	EPE-80, HEE-81		
accessories for	415865		
	GEV No.	510368	Ref. No. —
	gasket L 70mm W 23.5mm hole ø 5mm hole distance 56mm FIBER thickness 2mm for heating element		

			
1			
GEV No.	415859	Ref. No.	5060804028
description	heating element 3500W 400V L 535mm W 510mm thread 1/4" mounting distance 500mm tube ø 8.5mm connection M4 2 hole fixing		
For models:	EHE-70, GZE-70		
accessories for	415859		
	GEV No.	361182	Ref. No. —
	nut thread 1/4" H 5mm nickel-plated brass WS 17 Qty 1 pcs		
	GEV No.	510417	Ref. No. —
	flat gasket fibre ED ø 20mm ID ø 14mm thickness 2mm Qty 1 pcs		
	GEV No.	520228	Ref. No. —
	tooth lock washer ID ø 15.3mm ED ø 24mm steel Qty 1 pcs for thread M14		
	GEV No.	521103	Ref. No. —
	nut thread M4 H 3mm WS 7 brass Qty 20 pcs		
	GEV No.	521104	Ref. No. —
	washer ID ø 4.3mm ED ø 8mm thickness 0.5mm brass Qty 20 pcs for thread M4		
	GEV No.	550262	Ref. No. —
	flat gasket copper ED ø 20mm ID ø 14mm thickness 2mm		
	GEV No.	560111	Ref. No. —
	plain washer ID ø 4.3mm ED ø 9mm thickness 0.8mm SS Qty 20 pcs DIN 125A for thread M4		
	GEV No.	560131	Ref. No. —
	hexagonal nut thread M4 H 3.2mm WS 7 SS DIN/ISO DIN 934 / ISO 4032/8673 Qty 20 pcs		

heating elements for bain maries

			
1			
GEV No.	415688	Ref. No.	5060801490
description	heating element 2000W 230V heating circuits 1 L 410mm W 150mm tube ø 6.3mm lug length 27mm lug width 16mm connection length 31mm connection M5 hole ø 4mm dry heating element bracket mounting hole distance 165mm mounting distance 160mm		
For models:	BUC-70		

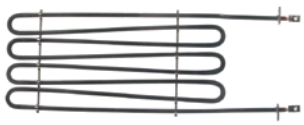

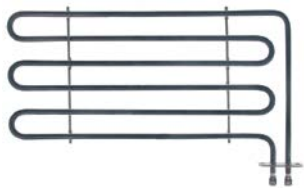

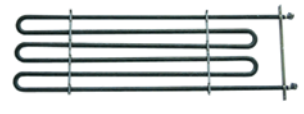
			
1			
GEV No.	416957	Ref. No.	5060811860
description	heating element 2000W 230V heating circuits 1 L 410mm W 150mm tube ø 6.3mm lug length 30mm lug width 18mm connection 28 hole ø 5mm dry heating element bracket mounting		
For models:	BU-35, BU-70, BUC-35, BUC-70, BUC-70-L, BUC-70-R, EBM-40, EBM-80, EBMC-40, EBMC-80, EBMC-80-L, EBMC-80-R		

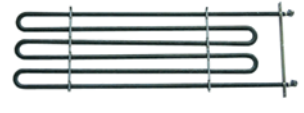
			
1			
GEV No.	416958	Ref. No.	5060814436
description	heating element 2000W 230V heating circuits 1 L 450mm W 240mm flange length 70mm flange width 22mm hole distance 56mm connection M5 tube ø 8.5mm rectangular flange hole ø 6mm dry heating element W1 44mm W2 196mm		
For models:	EBM-45, EBM-45-BF, EBM-45-D		

			
1			
GEV No.	415851	Ref. No.	5060802391
description	heating element 2000W 230V heating circuits 1 L 483mm W 138mm flange length 175mm flange width 16mm hole distance 160mm connection length 28mm connection M5 tube ø 8.5mm rectangular flange hole ø 6mm dry heating element		
For models:	BMW-70		

			
1			
GEV No.	415612	Ref. No.	5060802200
description	heating element 2000W 400V heating circuits 1 L 482mm W 138mm connection length 21mm connection M5 IT tube ø 8.5mm dry heating element connection distance 130mm		
For models:	BEW-80, BEW-85, BEW-90		





			
GEV No.	415852	Ref. No.	5060808748
description	heating element 800W 230V heating circuits 1 L 545mm W 40mm connection length 24mm connection M4 tube ø 8.5mm 2 hole fixing thread 1/4" dry heating element mounting distance 42mm		
For models:	BMW-70, BUC-35, BUC-70, BUC-70-L, BUC-70-R		
spare parts for	415852		
	GEV No.	510417	Ref. No. —
flat gasket fibre ED ø 20mm ID ø 14mm thickness 2mm Qty 1 pcs			
accessories for	415852		
	GEV No.	361182	Ref. No. —
nut thread 1/4" H 5mm nickel-plated brass WS 17 Qty 1 pcs			
	GEV No.	520228	Ref. No. —
tooth lock washer ID ø 15.3mm ED ø 24mm steel Qty 1 pcs for thread M14			
	GEV No.	550262	Ref. No. —
flat gasket copper ED ø 20mm ID ø 14mm thickness 2mm			

			
GEV No.	415853	Ref. No.	5060807674
description	heating element 800W 400V heating circuits 1 L 545mm W 40mm connection M4 tube ø 8.5mm 2 hole fixing thread 1/4" dry heating element heated cabinet mounting distance 32mm		
For models:	BEW-80, BEW-85, BEW-90		
accessories for	415853		
	GEV No.	361182	Ref. No. —
nut thread 1/4" H 5mm nickel-plated brass WS 17 Qty 1 pcs			
	GEV No.	510417	Ref. No. —
flat gasket fibre ED ø 20mm ID ø 14mm thickness 2mm Qty 1 pcs			
	GEV No.	520228	Ref. No. —
tooth lock washer ID ø 15.3mm ED ø 24mm steel Qty 1 pcs for thread M14			
	GEV No.	521103	Ref. No. —
nut thread M4 H 3mm WS 7 brass Qty 20 pcs			
	GEV No.	521104	Ref. No. —
washer ID ø 4.3mm ED ø 8mm thickness 0.5mm brass Qty 20 pcs for thread M4			
	GEV No.	550262	Ref. No. —
flat gasket copper ED ø 20mm ID ø 14mm thickness 2mm			
	GEV No.	560111	Ref. No. —
plain washer ID ø 4.3mm ED ø 9mm thickness 0.8mm SS Qty 20 pcs DIN 125A for thread M4			
	GEV No.	560131	Ref. No. —
hexagonal nut thread M4 H 3.2mm WS 7 SS DIN/ISO DIN 934 / ISO 4032/8673 Qty 20 pcs			

heating elements for frying pans

			
GEV No.	420073	Ref. No.	5060820841
description	heating element 1300W 400V heating circuits 1 L 418mm W 42mm connection M5 tube ø 10mm dry heating element H 74mm connection distance 32mm		
For models:	7EP-80, EUB-45-TB		

			
GEV No.	416961	Ref. No.	5060814355
description	heating element 1500W 230V heating circuits 1 L 530mm W 45mm connection M5 tube ø 10mm dry heating element multi purpose roasting pan L1 20mm H 90mm connection distance 35mm		
For models:	BUE-40, BUE-70, EKB-120, EKB-120E, EKB-150, EKB-150E, EUB-40, EUB-45-TB, EUB-45-TB-BF, EUB-45-TB-D, EUB-60-ECO, EUB-60-TB, EUB-60-TB-BF, EUB-60-TB-D		

 Image not available			
GEV No.	416956	Ref. No.	5060814355
description	heating element 1500W 230V multi purpose roasting pan		

			
GEV No.	416955	Ref. No.	5060811140
description	heating element 500W 230V heating circuits 1 L 450mm W 50mm connection M5 tube ø 10mm dry heating element L1 25mm H 90mm connection distance 40mm		
For models:	BUE-40, BUE-70, EUB-40, EUB-45-TB, EUB-45-TB-BF, EUB-45-TB-D, EUB-60-ECO, EUB-60-TB, EUB-60-TB-BF, EUB-60-TB-D		

heating elements for fryers

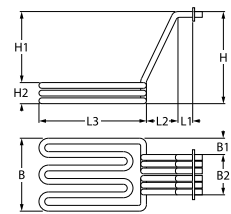
 			
GEV No.	419211	Ref. No.	5060811194
description	heating element 7500W 400V heating circuits 3 L 335mm W 135mm H 400mm H1 320mm H2 30mm rectangular flange connection cable		
For models:	EF1-40, EF1-45, EF1-45-BF, EF1-45-D, EF2-40, EF2-45, EF2-45-BF, EF2-45-D, EY1-40M, EY2-40M, EY-35M		



heating elements for griddles



GEV No.	403696	Ref. No.	5060837083
description	heating element 1000W 230V heating circuits 1 L 524mm W 32mm H 100mm tube ø 6.5mm		



GEV No.	416954	Ref. No.	5060814403
description	heating element 2000W 230V heating circuits 1 L 480mm W 154mm H 92mm tube ø 10mm connection M5 mounting pos. inner griddle dry heating element		
For models:	EBP-45-C, EBP-45-C-BF, EBP-45-C-D, EBP-45-L, EBP-45-L-BF, EBP-45-L-D, EBP-45-R, EBP-45-R-BF, EBP-45-R-D, EBP-90-1-2LR, EBP-90-1-2LR-BF, EBP-90-C, EBP-90-C-BF, EBP-90-C-D, EBP-90-L, EBP-90-L-BF, EBP-90-L-D, EBP-90-LR, EBP-90-R, EBP-90-R-BF, EBP-90-R-D		



GEV No.	416952	Ref. No.	5060814401
description	heating element 2000W 230V heating circuits 1 L 600mm W 305mm H 90mm tube ø 10mm connection 4 mounting pos. outer griddle connection distance 565mm dry heating element		
For models:	EBP-45-C, EBP-45-C-BF, EBP-45-C-D, EBP-45-L, EBP-45-L-BF, EBP-45-L-D, EBP-45-R, EBP-45-R-BF, EBP-45-R-D, EBP-90-1-2LR, EBP-90-1-2LR-BF, EBP-90-C, EBP-90-C-BF, EBP-90-C-D, EBP-90-L, EBP-90-L-BF, EBP-90-L-D, EBP-90-LR, EBP-90-R, EBP-90-R-BF, EBP-90-R-D		

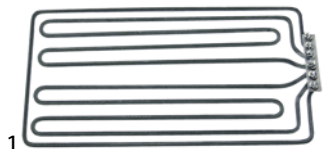

GEV No.	415869	Ref. No.	5060803506
description	heating element 5000W 230V heating circuits 3 L 506mm W 265mm H 50mm tube ø 8.5mm W1 83mm W2 98mm rectangular flange connection M5 flange length 105mm flange width 24mm dry heating element		
For models:	EBP-40-C, EBP-40-L, EBP-40-R, EBP-80-1-2LR, EBP-80-C, EBP-80-L, EBP-80-R, GUE-40, GUE-40-B, GUE-40-C, GUE-40-V, GUE-70, GUE-70-1-2LR, GUE-70-B, GUE-70-C, GUE-70-V, GUE-S-40, GUE-S-70		



GEV No.	415856	Ref. No.	5060803508 5060903508
description	heating element 5000W 230V heating circuits 3 L 506mm W 275mm H 50mm tube ø 8.6mm W1 90mm W2 98mm rectangular flange connection M5 flange length 105mm flange width 24mm connection length 17mm dry heating element		

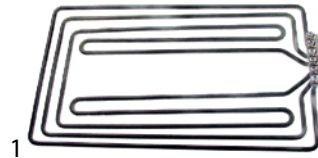

GEV No.	416951	Ref. No.	5060803509
description	heating element 6000W 230V heating circuits 3 L 540mm W 315mm H 50mm tube ø 8.5mm W1 109mm W2 98mm rectangular flange connection M5 flange length 105mm flange width 24mm dry heating element		
For models:	GE-40-V		

heating elements for large hobs



GEV No.	420094	Ref. No.	5060814406
description	heating element 1330W 230V L 168mm W 170mm H 83mm heating circuits 1 tube ø 6mm mounting pos. inner connection length 18mm connection M5		
For models:	EP-45, EP-45-BF, EP-90, EP-90-BF, EP-90-D		



GEV No.	420093	Ref. No.	5060814405
description	heating element 1330W 230V L 230mm W 244mm H 86mm heating circuits 1 tube ø 6.3mm mounting pos. centre connection length 18mm connection M5		
For models:	EP-45, EP-45-BF, EP-90, EP-90-BF, EP-90-D		

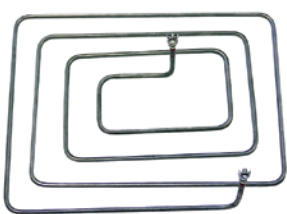

GEV No.	415862	Ref. No.	5060808461
description	heating element 1350W 400V L 228mm W 218mm H 82mm heating circuits 1 tube ø 6.3mm mounting pos. inner connection M5 dry heating element		
For models:	EK-40, EK-70, EKE-70, EPS-40, EPS-80, EPSE-80		

1

GEV No.	415867	Ref. No.	5060808464
description	heating element 1650W 400V L 255mm W 330mm H 72mm heating circuits 1 tube ø 6.3mm mounting pos. outer connection length 23mm connection M4 dry heating element		
For models:	EPE-80		



1

GEV No.	416949	Ref. No.	5060808468 5060811570
description	heating element 2000W 400V L 300mm W 340mm H 68mm heating circuits 1 tube ø 6.3mm mounting pos. outer L1 58mm L2 242mm W1 115mm W2 185mm connection M5 connection distance 187mm dry heating element		





1

GEV No.	415863	Ref. No.	5060808462
description	heating element 1650W 400V L 260mm W 245mm H 100mm heating circuits 1 tube ø 6.3mm mounting pos. outer connection M4 dry heating element		
For models:	EK-40, EK-70, EKE-70, EPS-40, EPS-80, EPSE-80		





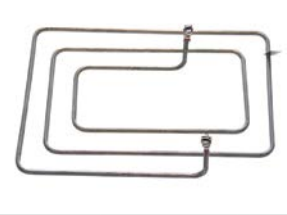

1

GEV No.	415206	Ref. No.	5060808466
description	heating element 2000W 400V L 340mm W 250mm H 80mm tube ø 6.5mm mounting pos. outer connection length 25mm connection M4 dry heating element		
accessories for	415206		
	GEV No.	527169	Ref. No. —
	hexagonal nut thread M3 H 2.8mm WS 5.5 brass Qty 1 pcs		
	GEV No.	560110	Ref. No. —
	plain washer ID ø 3.2mm ED ø 7mm thickness 0.5mm SS Qty 20 pcs DIN 125A for thread M3		
	GEV No.	560130	Ref. No. —
	hexagonal nut thread M3 H 2.4mm WS 5.5 SS DIN/ISO DIN 934 / ISO 4032/8673 Qty 20 pcs		



1

GEV No.	415205	Ref. No.	5060808465
description	heating element 1700W 400V L 220mm W 300mm H 55mm heating circuits 1 tube ø 6.3mm mounting pos. inner connection length 18mm connection M4		
accessories for	415205		
	GEV No.	521103	Ref. No. —
	nut thread M4 H 3mm WS 7 brass Qty 20 pcs		
	GEV No.	521104	Ref. No. —
	washer ID ø 4.3mm ED ø 8mm thickness 0.5mm brass Qty 20 pcs for thread M4		
	GEV No.	560111	Ref. No. —
	plain washer ID ø 4.3mm ED ø 9mm thickness 0.8mm SS Qty 20 pcs DIN 125A for thread M4		
	GEV No.	560131	Ref. No. —
	hexagonal nut thread M4 H 3.2mm WS 7 SS DIN/ISO DIN 934 / ISO 4032/8673 Qty 20 pcs		

heating elements for tilting bratt pan

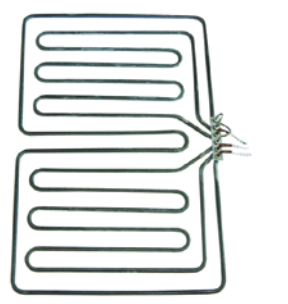

1

GEV No.	415901	Ref. No.	5060803648
description	heating element 12000W 230/400V L 475mm W 700mm H 33mm dry heating element heating circuits 3 tube ø 10mm W1 300mm W2 98mm rectangular flange cable length 1500mm flange length 105mm flange width 24mm connection length 10mm		
For models:	EKH-90, EKM-90, KHE-90		

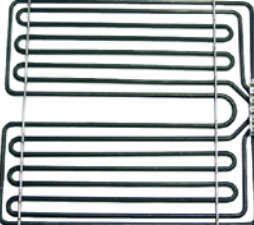

1

GEV No.	415870	Ref. No.	5060807220 AM5060807220
description	heating element 7500W 230V L 480mm W 440mm H 30mm connection M5 dry heating element heating circuits 3 tube ø 8.5mm W1 171mm W2 98mm rectangular flange flange length 105mm flange width 24mm bridge length 450mm		
For models:	KBHE-70-R		

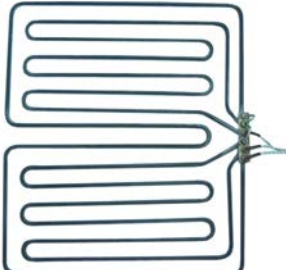

1

GEV No.	415900	Ref. No.	5060807221
description	heating element 9000W 230/400V L 520mm W 600mm H 33mm connection cable dry heating element heating circuits 3 tube ø 10mm W1 250mm W2 100mm rectangular flange cable length 1400mm flange length 105mm flange width 24mm		
For models:	EKM-50, KME-50		



1

GEV No.	416960	Ref. No.	5060808751
description	heating element 9000W 400V L 426mm W 410mm H 33mm dry heating element heating circuits 3 W1 156mm W2 98mm rectangular flange cable length 118mm flange length 105mm flange width 24mm connection length 35mm		
For models:	TPE-80		

heating elements for pasta cookers





1

GEV No.	419228	Ref. No.	AM5060833662
description	heating element 10000W 230V heating circuits 3 L 485mm W 33mm H 36mm 3 hole flange tube ø 8.5mm thermostat sleeves ø 4mm length thermostat sleeves 320mm cable length 800mm mounting ø 47.5mm hole ø 8mm number of thermostat sleeves 1 pasta cooker thermostat sleeve clinging immersion heater		



1

GEV No.	416959	Ref. No.	5060814407	
description	heating element 8000W 230V heating circuits 3 L 485mm W 33mm H 36mm 3 hole flange tube ø 8.5mm thermostat sleeves ø 3mm length thermostat sleeves 320mm hole distance 62mm cable length 800mm mounting ø 47.5mm hole ø 8mm number of thermostat sleeves 1 pasta cooker thermostat sleeve clinging immersion heater			
For models:	CPE-35, CPE-70, EKP40, EPK-40, EUK-45II, EUK-45II-BF, EUK-45II-D			
accessories for	416959			
	GEV No.	510408	Ref. No.	5017303768 5017313781
	O-ring EPDM thickness 5.34mm ID ø 47mm Qty 1 pcs			
	GEV No.	510562	Ref. No.	—
	O-ring silicone thickness 5.34mm ID ø 47mm Qty 1 pcs			

heating elements for salamanders/toast-



1

GEV No.	420271	Ref. No.	6205403708
description	heating element 1000W 230V L 215mm W 95mm L1 25mm L2 25mm L3 165mm W1 16mm W2 63mm hole distance 96mm connection M4 tube ø 8.5mm flange length 106mm flange width 32mm heating circuits 1 hole ø 5mm tilt flange dry heating element H 8.5mm		



1

GEV No.	416654	Ref. No.	6205403706
description	heating element 2000W 230V L 230mm W 230mm L1 22mm L2 208mm W1 83mm W2 63mm hole distance 96mm tube ø 8.5mm flange length 106mm flange width 32mm heating circuits 1 hole ø 5mm tilt flange dry heating element H 8.5mm		

contact heaters



1

GEV No.	418810	Ref. No.	5060818231
description	heating element 1500W 400V heating circuits 1 L 565mm W 71mm tube ø 8.5mm		



immersion heating elements

3 hole flange ø47.5mm

GEV No.	416967	Ref. No.	5060809980
description	heating element 10000W 230V mounting ø 47.5mm heating circuits 3 L 495mm W 37mm H 35mm number of thermostat sleeves 1 thermostat sleeves ø 4.5mm length thermostat sleeves 325mm thermostat sleeve eccentric, clinging tube ø 8.5mm hole distance 64mm hole ø 8x10mm cable length 800mm connection length 45mm connection cable 3 hole flange immersion heater		
For models:	GNKE-100, GNKE-230		
accessories for	416967		
	GEV No.	510408	Ref. No. 5017303768 5017313781
	O-ring EPDM thickness 5.34mm ID ø 47mm Qty 1 pcs		
	GEV No.	510562	Ref. No. —
	O-ring silicone thickness 5.34mm ID ø 47mm Qty 1 pcs		

GEV No.	420182	Ref. No.	5060818238
description	heating element 4000W 230V mounting ø 47.5mm heating circuits 3 L 290mm W 32mm H 42mm number of thermostat sleeves 1 thermostat sleeves ø 8mm length thermostat sleeves 240mm thermostat sleeve eccentric, clinging tube ø 8.4mm hole distance 63mm hole ø 10mm cable length 800mm connection cable 3 hole flange immersion heater		

GEV No.	415674	Ref. No.	5060807384 5060810063
description	heating element 4500W 230V mounting ø 47.5mm heating circuits 3 L 395mm W 30mm H 40mm number of thermostat sleeves 1 thermostat sleeves ø 4mm length thermostat sleeves 330mm thermostat sleeve eccentric, clinging tube ø 8.5mm hole distance 63mm hole ø 10mm cable length 600mm connection cable 3 hole flange immersion heater		
For models:	KKE-100		
accessories for	415674		
	GEV No.	510408	Ref. No. 5017303768 5017313781
	O-ring EPDM thickness 5.34mm ID ø 47mm Qty 1 pcs		
	GEV No.	510562	Ref. No. —
	O-ring silicone thickness 5.34mm ID ø 47mm Qty 1 pcs		

GEV No.	415773	Ref. No.	5060807386 5060810064
description	heating element 6000W 230V mounting ø 47.5mm heating circuits 3 L 390mm W 31mm H 40mm number of thermostat sleeves 1 thermostat sleeves ø 4mm length thermostat sleeves 330mm thermostat sleeve clinging tube ø 6.5mm hole distance 62mm hole ø 8mm cable length 800mm 3 hole flange immersion heater pasta cooker		
For models:	CPE-70, EKK-100, EKK-100-BF, EKK-100E, EKK-150, EKK-150-BF, EKK-40, EKK-40-BF, EKK-40E, ESK-100-80II-BF, ESK150, ESK-150II-BF, ESK-40, ESK-40E, ESK60, ESK-60-40II-BF, ESK-80, ESK-80E, GNKE-150, KKE-100		
accessories for	415773		
	GEV No.	510408	Ref. No. 5017303768 5017313781
	O-ring EPDM thickness 5.34mm ID ø 47mm Qty 1 pcs		
	GEV No.	510562	Ref. No. —
	O-ring silicone thickness 5.34mm ID ø 47mm Qty 1 pcs		



GEV No.	415854	Ref. No.	5060807387 5060809979
description	heating element 8000W 230V mounting ø 47.5mm heating circuits 3 L 385mm W 32mm H 44mm number of thermostat sleeves 1 thermostat sleeves ø 4.5mm length thermostat sleeves 325mm thermostat sleeve clinging tube ø 8.5mm hole distance 62mm hole ø 8x10mm cable length 800mm connection cable 3 hole flange immersion heater		
For models:	BPE-50, EKK-150, EKK-150-BF, ESK150, ESK-150II-BF, GNKE-100, GNKE-150, GNKE-230, KSKE-100, KSKE-50		
spare parts for	415854		
	GEV No.	510408	Ref. No. 5017303768 5017313781
	O-ring EPDM thickness 5.34mm ID ø 47mm Qty 1 pcs		
	GEV No.	510562	Ref. No. —
	O-ring silicone thickness 5.34mm ID ø 47mm Qty 1 pcs		



with round flange ø57.5mm

GEV No.	415849	Ref. No.	R65020420
description	heating element 15000W 230V heating circuits 3 mounting ø 57.5mm L 530mm W 45mm H 30mm round flange connection M4 immersion heater tube ø 8.5mm connection length 15mm thermostat sleeves ø 7mm number of thermostat sleeves 1 length thermostat sleeves 272mm thermostat sleeve eccentric, clinging		
accessories for	415849		
	GEV No.	550002	Ref. No. —
	tension strap H 10mm L 21mm W 10mm hole ø 6.5mm for heating element		

1 electric components





			
1			
GEV No.	415848	Ref. No.	R65020350
description	heating element 7500W 230V heating circuits 3 mounting ø 57.5mm L 365mm W 36mm H 50mm round flange connection M4 immersion heater tube ø 8.5mm thermostat sleeves ø 7.5mm number of thermostat sleeves 1 length thermostat sleeves 270mm thermostat sleeve eccentric, clinging		
spare parts for	415848		
	GEV No.	510409	Ref. No. —
accessories for	415848		
	GEV No.	550002	Ref. No. —
	tension strap H 10mm L 21mm W 10mm hole ø 6.5mm for heating element		



2½"			
			
1			
GEV No.	416966	Ref. No.	5060807398
description	heating element 8000W 220V heating circuits 6 L 300mm W 58mm H 56mm thermostat sleeves ø 7mm length thermostat sleeves 235mm number of thermostat sleeves 1 thermostat sleeve eccentric, clinging connection M5 immersion heater flange with thread thread 2½"		
For models:	K7E-35, K7E-50		
spare parts for	416966		
	GEV No.	510410	Ref. No. —
	O-ring EPDM thickness 5.34mm ID ø 75.57mm Qty 1 pcs		

heating elements for convection

			
1			
GEV No.	415828	Ref. No.	R65011310
description	heating element 15000W 230V heating circuits 3 ID ø 388mm ED ø 408mm L 428mm H 132mm L1 20mm W1 105mm H1 114mm H2 18mm flange length 140mm flange width 25mm hole distance 126mm connection M4 connection length 65mm tube ø 8.5mm convection heating element hole ø 6.3mm rectangular flange		

			
1			
GEV No.	418197	Ref. No.	R65011250
description	heating element 15000W 230V heating circuits 3 ID ø 512mm ED ø 530mm L 545mm H 130mm L1 15mm W1 105mm H1 25mm H2 105mm flange length 142mm flange width 25mm hole distance 126mm connection M4 connection length 68mm tube ø 8.5mm convection heating element hole ø 6mm rectangular flange		

			
1			
GEV No.	416976	Ref. No.	5060809912
description	heating element 1800W 230V heating circuits 1 ID ø 167mm ED ø 182mm L 220mm H 42mm L1 32mm W1 30mm H1 12mm H2 30mm flange length 70mm flange width 22mm hole distance 56mm connection M4 tube ø 6.3mm dry heating element hole ø 5mm rectangular flange		
For models:	EBMC-80, EBMC-80-L, EBMC-80-R, UBW-90II, UBW-90II-D		
accessories for	416976		
	GEV No.	510368	Ref. No. —
	gasket L 70mm W 23.5mm hole ø 5mm hole distance 56mm FIBER thickness 2mm for heating element		

			
1			
GEV No.	415829	Ref. No.	R65011540
description	heating element 7500W 230V heating circuits 3 ID ø 248mm ED ø 260mm L 287mm H 88mm L1 20mm W1 105mm H1 23mm H2 65mm flange length 142mm flange width 25mm hole distance 64mm connection M4 connection length 78mm convection heating element hole ø 5mm rectangular flange		
accessories for	415829		
	GEV No.	531270	Ref. No. —
	gasket L 141mm W 22mm D1 ø 10mm D2 ø 9mm 9 holes graphite thickness 1mm suitable for UNOX		



radiation heaters

square

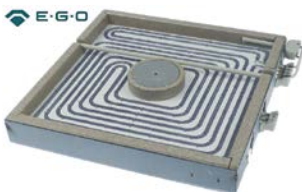

GEV No.	490009 ¹	Ref. No.	5060810557
description	radiation heater L 300mm W 300mm 4000W 400V connections 3+2 square with pan detection EGO		
For models:	CH-45-T, CH-45-T-BF, CH-45-T-D, CHT-40, CHT-80		
spare parts for	490009		
	GEV No.	Ref. No.	—
	protection pipe for temperature probe ceramic L 297mm ED ø 7mm ID ø 5mm		

¹with pan detection



GEV No.	490008	Ref. No.	5060810556
description	radiation heater L 300mm W 300mm 4000W 400V heating circuits 2 connections 3 square connection type male faston 6.3mm without pan detection EGO		
For models:	CH-40, CH-45, CH-45-BF, CH-45-D, CH-80, CHE-80		
spare parts for	490008		
	GEV No.	Ref. No.	—
	protection pipe for temperature probe ceramic L 297mm ED ø 7mm ID ø 5mm		

hot plates

square & rectangular

with radiused edge



GEV No.	490065	Ref. No.	5062502395
description	hot plate dimensions 220x220mm 2000W 230V with spill ring connection 4 screw clamps protector no square		

GEV No.	490067	Ref. No.	5062502383
description	hot plate dimensions 220x220mm 2000W 400V with spill ring connection 4 screw clamps protector no square		
For models:	EHE-70, ER-105, ER-35, ER-70, ERE-105, ERE-70, EREC-105		
accessories for	490067		
	GEV No.	Ref. No.	—
	sealing cord ø 10mm Qty supplied by meter		

GEV No.	490066 ¹	Ref. No.	5062502365
description	hot plate dimensions 220x220mm 2600W 230V with spill ring connection 4 screw clamps protector yes square		

¹incl. protector

GEV No.	490068 ¹	Ref. No.	5062502382
description	hot plate dimensions 220x220mm 2600W 400V with spill ring connection 4 screw clamps protector yes square		
For models:	EHE-70, ER-105, ER-70, ERE-105, ERE-70, EREC-105		

¹incl. protector

GEV No.	490073	Ref. No.	5062508314
description	hot plate dimensions 300x300mm 3000W 400V with spill ring connection 4 screw clamps protector no square		
For models:	EH-40, EH-80, EHE-80, HEE-81		



E-G-O



1

GEV No.	490057 ¹	Ref. No.	5062508314 5062508315
description	hot plate dimensions 300x300mm 3000W 400V with spill ring connection 4 screw clamps protector yes square		

¹incl. protector

E-G-O



1

GEV No.	490074 ¹	Ref. No.	5062508311
description	hot plate dimensions 300x300mm 4000W 400V with spill ring connection 4 screw clamps protector yes square		
For models:	EH-45, EH-45-BF, EH-45-D, EH-90, EH-90-BF, EH-90-D, HEE-81		

¹incl. protector

energy regulators

EGO

1-circuit

E-G-O



1

GEV No.	380015	Ref. No.	5061616087 6205406501
description	energy regulator 230V 13A single-circuit turn direction right shaft ø 6x4.6mm shaft L 23mm mounting thread M4 power release 6-100% no. 50.57021.010		
For models:	7CH-50, 7CH-80, CH-70, EKK-100, EKK-100-BF, EKK-150, EKK-150-BF, EKK-40, EKK-40-BF		

thermostats

control and safety thermostats

EGO

control thermostats

55.10/19_series

E-G-O



1

GEV No.	375546	Ref. No.	5061618077
description	thermostat t.max. 110°C temperature range 30-110°C 1-pole 1NO 16A probe ø 6mm probe L 130mm capillary pipe 900mm capillary pipe isolated 900mm gland nut shaft ø 6x4.6mm shaft L 15mm shaft position upper rotation 318°		
For models:	BU-35, BU-70, BUC-35, BUC-70, BUC-70-L, BUC-70-R, EBM-40, EBM-80, EBMC-40, EBMC-80, EBMC-80-L, EBMC-80-R		

E-G-O



1

GEV No.	375001	Ref. No.	5061602949
description	thermostat t.max. 112°C temperature range 30-110°C 1-pole 1NO 16A probe ø 6mm probe L 130mm capillary pipe 900mm capillary pipe isolatedmm gland nut M9x1 shaft L 23mm shaft position upper rotation 270°		
For models:	BEW-80, BEW-85, BEW-90		

E-G-O



1

GEV No.	375548	Ref. No.	5061609772
description	thermostat t.max. 142°C temperature range fixed 142°C 1-pole 1CO 16A probe ø 4mm probe L 157mm capillary pipe 870mm capillary pipe isolated 870mm gland nut shaft ø 6x4.6mm shaft Lmm shaft position		
For models:	EKK-100, EKK-100-BF, EKK-100E, EKK-150, EKK-150-BF, EKK-40, EKK-40-BF, EKK-40E, ESK-100-80II-BF, ESK150, ESK-150II-BF, ESK-40, ESK-40E, ESK60, ESK-60-40II-BF, ESK-80, ESK-80E, GNKE-100, GNKE-150, GNKE-230, GSK100, GSK-100-80, GSK-100-80-BF, GSK-150, GSK-150-BF, GSK-40, GSK60, GSK-60-40, GSK-60-40-BF, GSK-80		



GEV No.	375549	Ref. No.	5061603920
description	thermostat t.max. 150°C temperature range fixed 150°C 1-pole 1NO 0.5A probe ø 6mm probe L 86mm capillary pipe 1000mm capillary pipe isolatedmm gland nut shaft Lmm shaft position° rotation°		
For models:	BPG-50, EBMC-40, EBMC-80, EBMC-80-L, EBMC-80-R, GKS-100, GKS-150, GKS-60, GKS-80, K7G-35, K7G-50, KKG100, UBW-45II, UBW-45II-D, UBW-90II, UBW-90II-D		

55.13_series



GEV No.	390161	Ref. No.	5061622560
description	thermostat t.max. 114°C temperature range 36-114°C 1-pole 1NO 16A probe ø 31/36mm probe Lmm capillary pipe 870mm capillary pipe isolated 800mm gland nut shaft ø 6x4.6mm shaft L 23mm shaft position upper rotation 270° with knob probe (boiling plate)		



GEV No.	375310	Ref. No.	5061610987 5061611125
description	thermostat t.max. 185°C temperature range 100-185°C 1-pole 1NO 16A probe ø 4mm probe L 231mm capillary pipe 1800mm capillary pipe isolated 1600mm gland nut M9x1 shaft L 23mm shaft position upper rotation 270°		
For models:	7EF1-50, 7EF2-50, EF1-40, EF1-45, EF1-45-BF, EF1-45-D, EF2-40, EF2-45, EF2-45-BF, EF2-45-D, EY1-40M, EY2-40M, EY-35M, GF1-45, GF1-45-BF, GF1-45-D, GF2-60, GF2-60-BF, GF2-60-D		



GEV No.	376070	Ref. No.	5061620575 AM5061620575
description	thermostat t.max. 120°C temperature range 30-120°C 1-pole 1NO 16A probe ø 6mm probe L 113mm capillary pipe 870mm capillary pipe isolated 210mm gland nut shaft ø 6x4.6mm shaft L 28mm shaft position° shaft position upper rotation 270° outer switch		



GEV No.	375553	Ref. No.	5061618075
description	thermostat t.max. 320°C temperature range 57-320°C 1-pole 1NO 16A probe ø 3.1mm probe L 226mm capillary pipe 870mm capillary pipe isolated 870mm gland nut shaft ø 6x4.6mm shaft L 15mm shaft position upper rotation 318°		
For models:	CHE-80, EHE-80, EKE-70, EKH-90, EKM-50, EKM-90, EPSE-80, ERE-105, ERE-70, EREC-105, GHE-120, GHE-80, GKE-70, GPSE-80, GRE-105, GRE-70, GREC-105, SIE-105, SIEC-105, TPG-80, UBE-90, UBE-90-D, UBED-90-D		

55.34_series





GEV No.	375143	Ref. No.	5061608152
description	thermostat t.max. 110°C temperature range 32-110°C 3-pole 3NO 16A probe ø 6mm probe L 138mm capillary pipe 1480mm capillary pipe isolated 1100mm gland nut M9x1 shaft ø 6x4.6mm shaft L 23mm shaft position upper rotation 270°		
For models:	BMW-70		

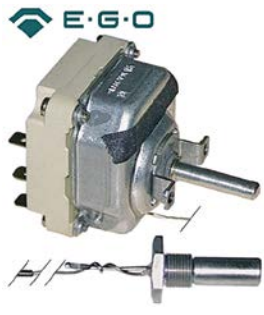

GEV No.	375547	Ref. No.	5061603938
description	thermostat t.max. 120°C temperature range 30-120°C 3-pole 3NO 16A probe ø 11mm probe L 28mm capillary pipe 900mm capillary pipe isolated 900mm gland nut shaft ø 6x4.6mm shaft L 23mm shaft position upper rotation 318° screw-in probe		
For models:	BPE-50, BPG-50, ESK-100-80II-BF, ESK150, ESK-150II-BF, ESK-40, ESK60, ESK-60-40II-BF, ESK-80, GKS-100, GKS-150, GKS-60, GKS-80, GNKE-100, GNKE-150, GNKE-230, GSK100, GSK-100-80, GSK-100-80-BF, GSK-150, GSK-150-BF, GSK-40, GSK60, GSK-60-40, GSK-60-40-BF, GSK-80		
accessories for	375547		
	GEV No.	510417	Ref. No. —
	flat gasket fibre ED ø 20mm ID ø 14mm thickness 2mm Qty 1 pcs		
	GEV No.	550261	Ref. No. —
	nut thread M14x1 H 4mm WS 19 SS Qty 1 pcs		



GEV No.	390190	Ref. No.	5061603922
description	thermostat t.max. 185°C temperature range 80-185°C 3-pole 3NO 16A probe ø 11mm probe L 28mm capillary pipe 900mm capillary pipe isolated 700mm gland nut shaft ø 6x4.6mm shaft L 23mm shaft position upper rotation 270° screw-in probe probe thread M14x1		
For models:	GF-40		
accessories for	390190		
	GEV No.	510417	Ref. No. —
	flat gasket fibre ED ø 20mm ID ø 14mm thickness 2mm Qty 1 pcs		
	GEV No.	550261	Ref. No. —
	nut thread M14x1 H 4mm WS 19 SS Qty 1 pcs		



GEV No.	375602	Ref. No.	AM5061643661
description	thermostat t.max. 120°C temperature range 45-120°C 3-pole 3CO 16A probe ø 6mm probe L 140mm capillary pipe 900mm capillary pipe isolated 870mm gland nut shaft ø 6x4.6mm shaft L 23mm shaft position upper rotation 270°		



GEV No.	375693	Ref. No.	AM5061634257
description	thermostat t.max. 250°C temperature range 48-250°C 3-pole 3NO 16A probe ø 3.1mm probe L 226mm capillary pipe 880mm capillary pipe isolated 850mm gland nut shaft ø 6x4.6mm shaft L 23mm shaft position upper rotation 318°		



GEV No.	375022	Ref. No.	5061608750
description	thermostat t.max. 180°C temperature range 95-180°C 3-pole 3NO 16A probe ø 6mm probe L 133mm capillary pipe 1780mm capillary pipe isolated 1400mm gland nut M9x1 shaft ø 6x4.6mm shaft L 23mm rotation 270°		
For models:	EF-40, FE2-40		



GEV No.	375552	Ref. No.	5061607675 5061618784
description	thermostat t.max. 300°C temperature range 50-300°C 3-pole 3NO 16A probe ø 4mm probe L 229mm capillary pipe 900mm capillary pipe isolated 900mm gland nut shaft ø 6x4.6mm shaft L 23mm shaft position upper rotation 318°		
For models:	7EBP-40-L, 7EBP-60-C, EBP-40-C, EBP-40-L, EBP-40-R, EBP-45-C, EBP-45-C-BF, EBP-45-C-D, EBP-45-L, EBP-45-L-BF, EBP-45-L-D, EBP-45-R, EBP-45-R-BF, EBP-45-R-D, EBP-80-1-2LR, EBP-80-C, EBP-80-L, EBP-80-R, EBP-90-1-2LR, EBP-90-1-2LR-BF, EBP-90-C, EBP-90-C-BF, EBP-90-C-D, EBP-90-L, EBP-90-L-BF, EBP-90-L-D, EBP-90-LR, EBP-90-R, EBP-90-R-BF, EBP-90-R-D, EUB-45-TB, GUE-40, GUE-40-B, GUE-40-C, GUE-70, GUE-70-1-2LR, GUE-70-B, GUE-70-C, GUE-5-40, GUE-5-70		

safety thermostats

55.10/19_ series



GEV No.	375982	Ref. No.	5061600808
description	safety thermostat switch-off temp. 154°C 1-pole 1NC 16A probe ø 3mm probe L 227mm capillary pipe 900mm capillary pipe isolated 850mm gland nut probe probe material SS		
For models:	EKK-100, EKK-100-BF, EKK-100E, EKK-40, EKK-40-BF, EKK-40E, GSK100, GSK-100-80, GSK-100-80-BF, GSK-150, GSK-150-BF, GSK-40, GSK60, GSK-60-40, GSK-60-40-BF, GSK-80		

55.32_ series

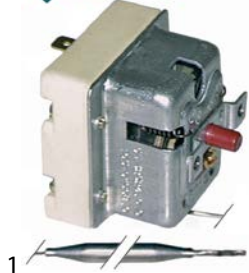

GEV No.	390159	Ref. No.	R65070081
description	safety thermostat switch-off temp. 150°C 1-pole 20A probe ø 6mm probe L 89mm capillary pipe 900mm capillary pipe isolated 800mm gland nut probe		

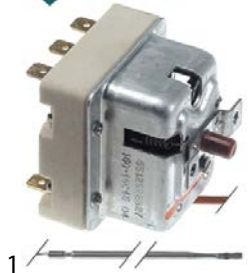

GEV No.	375545	Ref. No.	5061603828
description	safety thermostat switch-off temp. 150°C 3-pole 20A probe ø 3.1mm probe L 219mm capillary pipe 890mm capillary pipe isolated 890mm gland nut probe		
For models:	BPE-50, CPE-35, CPE-70, EKP40, EPK-40, ESK-100-80II-BF, ESK150, ESK-150II-BF, ESK-40, ESK-40E, ESK60, ESK-60-40II-BF, ESK-80, ESK-80E, EUK-45II, EUK-45II-BF, EUK-45II-D, GNKE-100, GNKE-150, GNKE-230, KKE-100, KSKE-100, KSKE-50		



GEV No.	375575	Ref. No.	5061614325
description	safety thermostat switch-off temp. 230°C 1-pole 20A probe ø 6mm probe L 87mm capillary pipe 890mm capillary pipe isolatedmm gland nut probe SS		
For models:	GF1-40, GF1-45, GF1-45-BF, GF1-45-D, GF2-60, GF2-60-BF, GF2-60-D, GF2-60-ECO, GY1-40, GY2-70		



GEV No.	375707	Ref. No.	5061603893
description	safety thermostat switch-off temp. 230°C 3-pole 20A probe ø 6mm probe L 87mm capillary pipe 1490mm capillary pipe isolated 1100mm gland nut M9x1 probe SS		
For models:	EF-40, FE2-40		

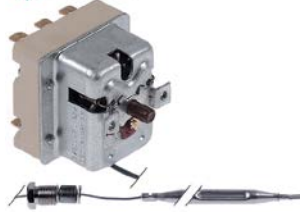

GEV No.	375393	Ref. No.	5061603893
description	safety thermostat switch-off temp. 235°C 3-pole 1CO/2NC 20A probe ø 6mm probe L 87mm capillary pipe 1790mm capillary pipe isolated 1710mm gland nut M9x1 probe SS		

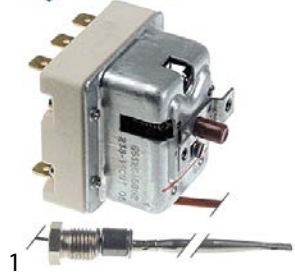

GEV No.	375551	Ref. No.	3561613027 5061603878 5061610988 5061611126
description	safety thermostat switch-off temp. 235°C 3-pole 20A probe ø 4mm probe L 120mm capillary pipe 1800mm capillary pipe isolated 1600mm gland nut probe SS		
For models:	7EF1-50, 7EF2-50, EF1-40, EF1-45, EF1-45-BF, EF1-45-D, EF2-40, EF2-40-E, EF2-45, EF2-45-BF, EF2-45-D, EY1-40M, EY2-40-E, EY2-40M, EY-35M, FE2-40-E, FE2-80-E		

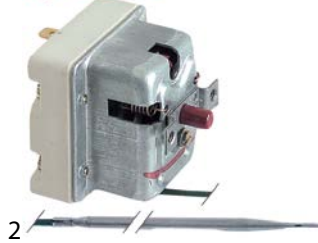

GEV No.	375344	Ref. No.	AM5061638556
description	safety thermostat switch-off temp. 360°C 1-pole 0.5A probe ø 4mm probe L 120mm capillary pipe 1500mm capillary pipe isolated 1500mm gland nut probe		



GEV No.	375684	Ref. No.	R65070350
description	safety thermostat switch-off temp. 360°C 1-pole 20A probe ø 11mm probe L 16mm capillary pipe 900mm capillary pipe isolated 900mm gland nut probe screw-in probe probe thread M14x1		

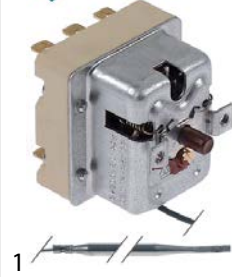

GEV No.	375392	Ref. No.	5061603684 5061616223
description	safety thermostat switch-off temp. 360°C 3-pole 1CO/2NC 20A probe ø 4mm probe L 120mm capillary pipe 1490mm capillary pipe isolated 1450mm gland nut probe SS		
For models:	7EBP-40-L, 7EBP-60-C, BUE-40, BUE-70, EBP-40-C, EBP-40-L, EBP-40-R, EBP-45-C, EBP-45-C-BF, EBP-45-C-D, EBP-45-L, EBP-45-L-BF, EBP-45-L-D, EBP-45-R, EBP-45-R-BF, EBP-45-R-D, EBP-70-V, EBP-80-1-2LR, EBP-80-C, EBP-80-L, EBP-80-R, EBP-90-1-2LR, EBP-90-1-2LR-BF, EBP-90-C, EBP-90-C-BF, EBP-90-C-D, EBP-90-L, EBP-90-L-BF, EBP-90-L-D, EBP-90-LR, EBP-90-R, EBP-90-R-BF, EBP-90-R-D, EKB-120, EKB-120E, EKB-120EII, EKB-120EII-BF, EKB-150, EKB-150E, EKB-150EII, EKB-150EII-BF, EKBD-125EII, EKBD-125EII-BF, EKBD-160EII, EKBD-160EII-BF, EKH-90, EKM-50, EKM-90, EUB-40, EUB-45-TB...(Other models you can see in the webshop)		

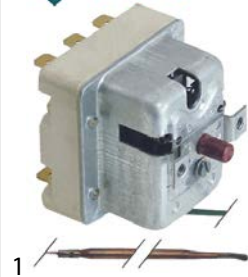

GEV No.	375257	Ref. No.	5061621356
description	safety thermostat switch-off temp. 580°C 3-pole 20A probe ø 4mm probe L 163mm capillary pipe 1200mm capillary pipe isolated gland nut probe		
For models:	7EP-80		

control thermostats with operation switch
55.10/19_ series



GEV No.	375629	Ref. No.	5061603162
description	thermostat t.max. 110°C temperature range 30-110°C 1-pole 1NC 16A probe ø 6mm probe L 130mm capillary pipe 2000mm capillary pipe isolated 1920mm gland nut shaft ø 6x4.6mm shaft L 23mm shaft position lower rotation 318° outer switch 2NO probe material SS		
For models:	BUC-70		





GEV No.	390799	Ref. No.	5061608580
description	thermostat t.max. 110°C temperature range 30-110°C 1-pole 1NO 16A probe ø 6mm probe L 129mm capillary pipe 870mm capillary pipe isolated 850mm gland nut shaft ø 6x4.6mm shaft L 23mm shaft position left rotation 318° outer switch 2NO		
For models:	BEW-80, BEW-85, BEW-90, EBM-45, EBM-45-BF, EBM-45-D, UBW-45II, UBW-45II-D, UBW-90II, UBW-90II-D		

55.34_series



GEV No.	375140	Ref. No.	5061610558
description	thermostat t.max. 650°C temperature range 50°C/50-600°C/70-650°C 3-pole 3NO 16A probe ø 4mm probe L 228mm capillary pipe 1200mm capillary pipe isolated 1200mm gland nut shaft ø 6x4.6mm shaft L 23mm shaft position left rotation 318° outer switch 2NO		
For models:	CH-40, CH-45, CH-45-BF, CH-45-D, CH-45-T, CH-45-T-BF, CH-45-T-D, CH-80, CHE-80, CHT-40, CHT-80		



GEV No.	375555	Ref. No.	5061608580 alt
description	thermostat t.max. 110°C temperature range 32-110°C 1-pole 1NO 16A probe ø 6mm probe L 129mm capillary pipe 870mm capillary pipe isolated 870mm gland nut shaft ø 6x4.6mm shaft L 23mm shaft position left rotation 318° outer switch 2NO		



JUMO

control thermostats



GEV No.	375533	Ref. No.	5061614400
description	thermostat t.max. 440°C temperature range 20-440°C 3-pole 3CO 10A probe ø 20mm probe L 21mm capillary pipe 1000mm capillary pipe isolated 900mm gland nut shaft ø 6x4.6mm shaft L 17mm shaft position upper rotation 270° with knob probe		
For models:	7EP-80, EP-45, EP-45-BF, EP-90, EP-90-BF, EP-90-D		



GEV No.	375590	Ref. No.	5061602948	
description	thermostat t.max. 320°C temperature range 57-320°C 1-pole 1NO 16A probe ø 3.1mm probe L 226mm capillary pipe 870mm capillary pipe isolated 800mm gland nut shaft ø 6x4.6mm shaft L 23mm shaft position upper rotation 270° outer switch 2NO probe material SS			
For models:	EBP-45-C, EBP-45-L, EBP-45-R, EBP-90-C, EBP-90-L, EBP-90-LR, EBP-90-R, EHE-70, EKE-70, EKH-90, EKM-90, EPE-80, ERE-70, GZE-70, HEE-81, KBHE-70-R, KME-50, TPE-80, TPG-80			
spare parts for	375590			
	GEV No.	300091	Ref. No.	5060904057
	operation switch EGO 2 operating positions 2NO 16A sequence 0-1 shaft ø 6x4.6mm shaft L 23mm connection screw ceramic			
	GEV No.	375553	Ref. No.	5061618075
	thermostat t.max. 320°C temperature range 57-320°C 1-pole 1NO 16A probe ø 3.1mm probe L 226mm capillary pipe 870mm capillary pipe isolated 870mm gland nut shaft ø 6x4.6mm shaft L 15mm shaft position upper rotation 318°			
	GEV No.	550059	Ref. No.	5006304040
	connecting bow short for switch Qty 1 pcs			



GEV No.	375105	Ref. No.	5061608151 5061608296
description	thermostat t.max. 440°C temperature range 20-500°C 1-pole 1CO 10A probe ø 20mm probe L 21mm capillary pipe 1000mm capillary pipe isolated 900mm gland nut shaft L 17mm shaft position upper rotation 270°		
For models:	EK-40, EK-70, EKE-70, EPE-80, EPS-40, EPS-80, EPSE-80		



TECASA

control thermostats



GEV No.	376071	Ref. No.	5061613760 5061619760 5061633536 AM5061633536
description	thermostat t.max. 300°C temperature range 30-300°C 1-pole 1NO 16A probe ø 4mm probe L 105mm capillary pipe 1600mm capillary pipe isolated 1250mm gland nut shaft ø 6x4.6mm shaft position° shaft position upper		
For models:	BUE-40, BUE-70, EUB-40, EUB-60-ECO		

various

control thermostats



GEV No.	381452	Ref. No.	5061633537 AM5061633537
description	thermostat t.max. 320°C temperature range 57-320°C 1-pole 1NO 20A probe ø 3mm probe L 210mm capillary pipe 935mm capillary pipe isolated 800mm gland nut shaft ø 6x4mm shaft L 16mm shaft position upper		

safety thermostats

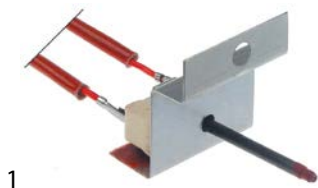



GEV No.	400972	Ref. No.	3506309549
description	protector		
For models:	EK-40, EK-70, EKE-70, EP-45, EP-45-BF, EP-90, EP-90-BF, EP-90-D, EPS-40, EPS-80, EPSE-80		

control thermostats with actual value



GEV No.	379914	Ref. No.	5020700031 5020704262
description	thermostat t.max. 120°C temperature range 0-120°C 1-pole 1CO 10A probe ø 12mm probe L 15mm capillary pipe 1200mm gland nut 3/4" mounting ø 60mm		
For models:	KKE-100, KKG100		



GEV No.	379392	Ref. No.	5020700032 5020704263	
description	thermostat t.max. 200°C temperature range 0-200°C 1-pole 1CO probe ø 6mm probe L 58mm capillary pipe 550mm mounting ø 60mm thread M20x1			
For models:	FG1-40			
accessories for	379392			
	GEV No.	527161	Ref. No.	—
	flat gasket copper ED ø 25.8mm ID ø 20.4mm thickness 2mm			
	GEV No.	691861	Ref. No.	—
	nut thread M20x1 H 4mm WS 23 brass Qty 1 pcs			

accessories

fitting parts



GEV No.	550020	Ref. No.	5009600963 AM5009600963
description	connecting piece for thermostat and switch		
For models:	EF1-40, EF1-45, EF1-45-BF, EF1-45-D, EF2-40, EF2-45, EF2-45-BF, EF2-45-D, EY1-40M, EY2-40M, EY-35M		



plunger sockets



1

GEV No.	550270	Ref. No.	5028600827
description	thermowell thread 1/2" ID ø 6.5mm L 90/150mm SS/brass double ø 8mm		
For models:	EF-40, FE2-40		
accessories for	550270		
	GEV No.	361184	Ref. No. —
	nut thread 1/2" H 6mm nickel-plated brass WS 24 Qty 1 pcs		
	GEV No.	521122	Ref. No. —
	flat gasket fibre ED ø 31mm ID ø 21.5mm thickness 2mm for thread 1/2" Qty 1 pcs		



1

GEV No.	550538	Ref. No.	3500514648 3500538801 AM3500514648 AM3500538801
description	thermowell thread M10x1 L 230mm SS single ø 4mm		
For models:	GF1-40, GF1-45, GF1-45-BF, GF1-45-D, GF2-60, GF2-60-BF, GF2-60-D, GF2-60-ECO, GSK100, GSK-100-80, GSK-100-80-BF, GSK-150, GSK-150-BF, GSK-40, GSK60, GSK-60-40, GSK-60-40-BF, GSK-80, GY1-40, GY2-70		

connecting bows



1

GEV No.	550059	Ref. No.	5006304040
description	connecting bow short for switch Qty 1 pcs		
For models:	7EBP-40-L, 7EBP-60-C, BU-35, BU-70, BUC-35, BUC-70, BUC-70-L, BUC-70-R, BUE-40, BUE-70, CHE-80, EBM-40, EBM-80, EBMC-40, EBMC-80, EBMC-80-L, EBMC-80-R, EBP-40-C, EBP-40-L, EBP-40-R, EBP-45-C, EBP-45-C-BF, EBP-45-C-D, EBP-45-L, EBP-45-L-BF, EBP-45-L-D, EBP-45-R, EBP-45-R-BF, EBP-45-R-D, EBP-80-1-2LR, EBP-80-C, EBP-80-L, EBP-80-R, EBP-90-C, EBP-90-C-BF, EBP-90-C-D, EBP-90-L, EBP-90-L-BF, EBP-90-L-D, EBP-90-LR, EBP-90-R, EBP-90-R-BF, EBP-90-R-D, EHE-80, EK-40, EK-70, EKE-70, EKH-90, EKM-90, EP-45...(Other models you can see in the webshop)		

switches and momentary switches

rocker/momentary rocker switches

30x22mm



1

GEV No.	301003	Ref. No.	5060903316
description	rocker switch mounting measurements 30x22mm green 2NO 250V 16A illuminated 0-1 connection male faston 6.3mm ambient temperature max. 125/55°C protection IP65		
For models:	7FC-40, EBP-70-V, EF2-40-E, EY2-40-E, FC-35, FE2-40-E, FE2-80-E, GE-40-V, GF-40, GUE-40-V, GUE-70-V		
accessories for	301003		
	GEV No.	301036	Ref. No. —
	protective cover internal size 30x22mm for rocker switch mounting measurementsmm		

push/momentary push switches

ø16mm



1

GEV No.	346287 ¹	Ref. No.	5018609593
description	momentary push switch mounting ø 16mm red 1NO 250V 3A illuminated connection male faston 2.8mm ambient temperature max. 125/55°C protection IP65 with cover cap		

¹illuminated



1

GEV No.	346315	Ref. No.	5018609593
description	momentary push switch mounting ø 16mm red 1NO/indicator light 250V 3A connection male faston 2.8mm ambient temperature max. 85°C protection IP40		
For models:	GF1-45, GF1-45-BF, GF1-45-D, GF2-60, GF2-60-BF, GF2-60-D, GSK100, GSK-100-80, GSK-100-80-BF, GSK-150, GSK-150-BF, GSK-40, GSK60, GSK-60-40, GSK-60-40-BF, GSK-80, TPG-80		
accessories for	346315		
	GEV No.	346343	Ref. No. —
	protective cover		
	GEV No.	346344	Ref. No. —
	ring for protecting cover		



miscellaneous



GEV No.	346348	Ref. No.	5018611265
description	momentary push switch		
For models:	EKB-120, EKB-150, EKK-100, EKK-100-BF, EKK-150, EKK-150-BF, EKK-40, EKK-40-BF, EKM-50, EKM-90, GKB-120, GKB-120-BF, GKB-150, GKB-150-BF, GKM-50, GKM-90		

microswitches

roller-lever actuated

microswitches



GEV No.	345041	Ref. No.	5060909894
description	microswitch with handle with a switch 250V 16A 1CO connection male faston 6.3mm ambient temperature max. 85°C black lever length 20.5mm		
For models:	7EF1-50, 7EF2-50, EF1-40, EF1-45, EF1-45-BF, EF1-45-D, EF2-40, EF2-45, EF2-45-BF, EF2-45-D, EKBD-125EII, EKBD-125EII-BF, EKBD-160EII, EKBD-160EII-BF, EY1-40M, EY2-40M, EY-35M		

non-standard



GEV No.	346274	Ref. No.	5060917629
description	microswitch with handle with a switch 250V 6A 1CO connection cable 200mm ambient temperature max. 70°C		
For models:	EKBD-125EII, EKBD-125EII-BF, EKBD-160EII, EKBD-160EII-BF		

position switches

MOELLER/EATON

extendable with actuators

extended plungers



GEV No.	347082	Ref. No.	0160927929
description	microswitch plastic 1NO/1NC 230V 3A L 75mm W 31mm H 33mm protection IP66 actuating force: 700g screw connection M20 mounting distance 22mm marking LS-11D		



GEV No.	346283	Ref. No.	5060907229
description	position switch cast aluminum 1NO/1NC 230V 3A L 75mm W 31mm H 33mm protection IP66 actuating force: 700g screw connection M20 mounting distance 22mm marking LS-S11D		
For models:	KBHE-70-R, KME-50, KSKE-100, KSKE-50		



GEV No.	346284	Ref. No.	5060909930
description	position switch plastic 1NO/1NC 230V 3A L 75mm W 31mm H 33mm protection IP66 actuating force: 500g screw connection M20 mounting distance 22mm marking LS-11		
For models:	EKM-50, EKM-90, GKM-90, TPE-80, TPG-80		



GEV No.	346285	Ref. No.	5060909748
description	position switch plastic 1NO/1NC 230V 3A L 75mm W 31mm H 33mm protection IP66 actuating force: 700g screw connection M20 mounting distance 22mm marking LS-S11D		
For models:	EKB-120, EKB-120E, EKB-120EII, EKB-120EII-BF, EKB-150, EKB-150E, EKB-150EII, EKB-150EII-BF, EKBD-125EII, EKBD-125EII-BF, EKBD-160EII, EKBD-160EII-BF, EKH-90, EKK-100, EKK-100-BF, EKK-100E, EKK-150, EKK-150-BF, EKK-40, EKK-40-BF, EKK-40E, EKM-90, GKB120E, GKB-120, GKB-120-BF, GKB-120EII, GKB-150, GKB-150-BF, GKB-150EII		

actuators



GEV No.	346990	Ref. No.	5060927013
description	roller lever MÖLLER		

toggle switches



GEV No.	301204	Ref. No.	5060901909
description	toggle switch		
For models:	EKM-50, GKM-50, KME-50, KMG-50		

1

GEV No.	301198	Ref. No.	5060921417
description	toggle switch 2NO/2NC 10A L 85mm		





1

GEV No.	300104	Ref. No.	5060909122
description	cam switch 4 operating positions 3NO/1CO sequence 0-1-2-3 32A shaft \varnothing 6x4.6mm shaft L 23mm connection screw ceramic		
For models:	BPE-50, CPE-35, CPE-70, EKP40, EPK-40, EUK-45II, EUK-45II-BF, EUK-45II-D		

cam switches



4-position



1



GEV No.	300023	Ref. No.	5060902384
description	cam switch 4 operating positions 1NO/2CO sequence 0-1-2-3 16A shaft \varnothing 6x4.6mm shaft L 23mm connection screw 4-position ceramic		
For models:	EHE-70, ER-105, ER-35, ER-70, ERE-105, ERE-70, EREC-105		

7-position

1

GEV No.	300025	Ref. No.	5060904034
description	cam switch 7 operating positions 1NO/2CO sequence 0-1-2-3-4-5-6 16A shaft \varnothing 6x4.6mm shaft L 23mm connection screw 7-position ceramic		
For models:	EHE-70, ER-105, ER-70, ERE-105, ERE-70, EREC-105		
accessories for	300025		
	GEV No.	112172	Ref. No. —
	knob universal \varnothing 70mm black without adaptor/dial plate		
	GEV No.	112213	Ref. No. —
	knob dial plate silver switch 7-position t.max.°C ED \varnothing 63mm ID \varnothing 45.5mm		
	GEV No.	112311	Ref. No. —
	knob adapter shaft \varnothing 6x4.6mm L 0mm with spring		



1

GEV No.	300103	Ref. No.	5060902396
description	cam switch 4 operating positions 1NO/2CO sequence 0-1-2-3 24A shaft \varnothing 6x4.6mm shaft L 23mm connection screw ceramic		
For models:	HEE-81, K7E-35, K7E-50, KSKE-100, KSKE-50		

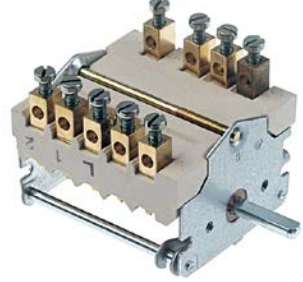

1

GEV No.	300174	Ref. No.	5060908251
description	cam switch 4 operating positions 2NO/2CO sequence 0-1-2-3 32A shaft \varnothing 6x4.6mm shaft L 23mm connection screw 4-position ceramic		
For models:	EH-40, EH-45, EH-45-BF, EH-45-D, EH-80, EH-90, EH-90-BF, EH-90-D, EHE-80		

1

GEV No.	300106	Ref. No.	5060904041
description	cam switch 7 operating positions 1NO/2CO sequence 0-1-2-3-4-5-6 32A shaft \varnothing 6x4.6mm shaft L 23mm connection screw 7-position shaft flat upper		
For models:	HEE-81		





4 operating positions

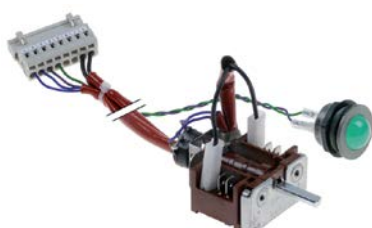

1			
GEV No.	301097	Ref. No.	5060904035
description	cam switch 4 operating positions sequence 0-1-2-3 16A shaft \varnothing 6x4.6mm shaft L 21mm connection screw clamp 4-pole		
For models:	EKK-100, EKK-100-BF, EKK-150, EKK-150-BF, EKK-40, EKK-40-BF, ESK-100-80II-BF, ESK150, ESK-150II-BF, ESK-40, ESK60, ESK-60-40II-BF, ESK-80, GNKE-100, GNKE-150, GNKE-230, KKE-100		

5 operating positions



1			
GEV No.	347532	Ref. No.	5003519072
description	cam switch with potentiometer connection with plug 2-pole		
spare parts for	347532		
	GEV No.	345119	Ref. No. —
	cam switch 2 operating positions 2NO sequence 0-1 16A shaft \varnothing 6x4.6mm shaft L 23mm connection soldering connection operation switch cable lengthmm 10kOhm plastic with potentiometer		

with potentiometer



1			
GEV No.	347436	Ref. No.	5003518422
description	cam switch 2 operating positions 2NO sequence 0-1 16A shaft \varnothing 6x4.6mm shaft L 23mm connection coded plug 10K/J cable length 2400mm 0.1-10kOhm 2-pole with potentiometer lampe green/red plug type 8-pole		
For models:	IHF-60, IHF-60-BF, IHF-60-D, IHF-90, IHF-90-BF, IHF-90-D		



1			
GEV No.	300252	Ref. No.	5003522626 AM5003522626
description	potentiometer 2 operating positions 2NO sequence 0-1 16A shaft \varnothing 6x4.6mm shaft L 23mm connection coded plug cable length 1420mm 10kOhm 12V with cable and indicator light		

operation switches



1			
GEV No.	300080	Ref. No.	5060904036
description	cam switch 2 operating positions 4NO 16A sequence 0-1 shaft \varnothing 6x4.6mm shaft L 23mm connection screw operation switch ceramic ambient temperature max. 150°C		
For models:	7EBP-40-L, 7EBP-60-C, 7EP-80, EBP-40-C, EBP-40-L, EBP-40-R, EBP-45-C, EBP-45-C-BF, EBP-45-C-D, EBP-45-L, EBP-45-L-BF, EBP-45-L-D, EBP-45-R, EBP-45-R-BF, EBP-45-R-D, EBP-80-1-2LR, EBP-80-C, EBP-80-L, EBP-80-R, EBP-90-1-2LR, EBP-90-1-2LR-BF, EBP-90-C, EBP-90-C-BF, EBP-90-C-D, EBP-90-L, EBP-90-L-BF, EBP-90-L-D, EBP-90-LR, EBP-90-R, EBP-90-R-BF, EBP-90-R-D, EP-45, EP-45-BF, EP-90, EP-90-BF, EP-90-D, EUB-45-TB, GF1-45, GF1-45-BF, GF1-45-D, GF2-60, GF2-60-BF, GF2-60-D, GKS-100, GKS-150, GKS-60, GKS-80, GSK100, GSK-100-80, GSK-100-80-BF...(Other models you can see in the webshop)		
accessories for	300080		
	GEV No.	551456	Ref. No. —
	gasket for switch ED \varnothing 14mm ID \varnothing 2.5mm thickness 3.5mm white		

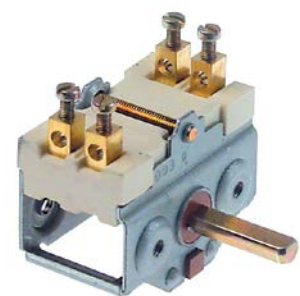

1			
GEV No.	300175	Ref. No.	5060904057
description	cam switch 2 operating positions operation switch 16A sequence 0-1 shaft \varnothing 6x4.6mm connection screw clamp 2-pole ambient temperature max. 318°C		
For models:	7CH-50, 7CH-80, BPG-50, BU-35, BU-70, BUC-35, BUC-70, BUC-70-L, BUC-70-R, BUE-40, BUE-70, CH-70, CHE-80, EBM-40, EBM-80, EBM-40, EBM-80, EBM-80-L, EBM-80-R, EHE-80, EK-40, EK-70, EKB-120, EKB-150, EKE-70, EKH-90, EKM-50, EKM-90, EPE-80, EPS-40, EPS-80, EPSE-80, ERE-105, ERE-70, EREC-105, EUB-40, EUB-45-TB, EUB-45-TB-BF, EUB-45-TB-D, EUB-60-ECO, EUB-60-TB, EUB-60-TB-BF, EUB-60-TB-D, GHE-120, GHE-80, GKB-120, GKB-120-BF, GKB-150, GKB-150-BF, GKE-70...(Other models you can see in the webshop)		



1			
GEV No.	300361	Ref. No.	5060910023
description	cam switch 3 operating positions 4NO 16A sequence 0-1-2 shaft \varnothing 6x4.6mm shaft L 23mm connection screw operation switch ceramic		
For models:	7EF1-50, 7EF2-50, EF1-40, EF1-45, EF1-45-BF, EF1-45-D, EF2-40, EF2-45, EF2-45-BF, EF2-45-D, EY1-40M, EY2-40M, EY-35M		



1

GEV No.	300091	Ref. No.	5060904057
description	operation switch EGO 2 operating positions 2NO 16A sequence 0-1 shaft \varnothing 6x4.6mm shaft L 23mm connection screw ceramic		

touch sensitive light switches



1

GEV No.	346388	Ref. No.	R65260750
description	touch sensitive light switch 1NOVA for combi-steamer L 47mm W 20mm H 30mm		

magnetic switches

37x16mm



1

GEV No.	347790	Ref. No.	R65265100
description	magnetic switch L 37mm W 16mm 1NO 250V connection cable cable length 1960mm 10W with magnet nominal 0.04A		

51x16mm



1

GEV No.	346273	Ref. No.	5060909191
description	magnetic switch L 51mm W 16mm connection cable		
For models:	EY2-40-E		

control equipment

SCHLEGEL

\varnothing 22mm

switches (complete)



1

GEV No.	346977	Ref. No.	3560926097
description	momentary push switch mounting measurements \varnothing 22mm clear 2NO/indicator light sequence 0-1 250V connection screw 16A protection IP40 ambient temperature max. 85°C		



1

GEV No.	346980	Ref. No.	3560926096
description	momentary push switch mounting measurements \varnothing 22mm red 1NO/indicator light sequence 0-1 250V connection screw 16A protection IP40 ambient temperature max. 85°C		

ALLEN BRADLEY

push buttons



1

GEV No.	346278	Ref. No.	5018619756
description	push button mounting measurements \varnothing 22mm illuminated red without switch		
For models:	EKK-100E, EKK-40E, GBK120E, GKB-120, GKB-120-BF, GKB-120EII, GKB-150, GKB-150-BF, GKB-150EII		



1

GEV No.	346277	Ref. No.	5060919757
description	push button mounting measurements \varnothing 22mm latching white without switch		
For models:	EKB-120E, EKB-120EII, EKB-120EII-BF, EKB-150E, EKB-150EII, EKB-150EII-BF, EKBD-125EII, EKBD-125EII-BF, EKBD-160EII, EKBD-160EII-BF, EKK-100E, EKK-40E, ESK-40E, ESK-80E, GBK120E, GKB-120EII, GKB-150EII		

switch block brackets



1

GEV No.	346329	Ref. No.	5060919759
description	contact block holder		
For models:	EKB-120E, EKB-120EII, EKB-120EII-BF, EKB-150E, EKB-150EII, EKB-150EII-BF, EKBD-125EII, EKBD-125EII-BF, EKBD-160EII, EKBD-160EII-BF, EKK-100E, EKK-40E, ESK-40E, ESK-80E, GBK120E, GKB-120, GKB-120-BF, GKB-120EII, GKB-150, GKB-150-BF, GKB-150EII		

lamp holders



1

GEV No.	346275	Ref. No.	5061119760
description	indicator socket		
For models:	EKB-120E, EKB-120EII, EKB-120EII-BF, EKB-150E, EKB-150EII, EKB-150EII-BF, EKBD-125EII, EKBD-125EII-BF, EKBD-160EII, EKBD-160EII-BF, EKK-100E, EKK-40E, ESK-40E, ESK-80E, GBK120E, GKB-120, GKB-120-BF, GKB-120EII, GKB-150, GKB-150-BF, GKB-150EII		

BRETER



1

GEV No.	345640	Ref. No.	5060902730
description	contact block BRETER 1NO		
For models:	EKM-50, GKM-50, KME-50, KMG-50		

GENERAL ELECTRIC (AEG)



1

GEV No.	346282	Ref. No.	5060906309
description	contact block GENERAL ELECTRIC 1NC/1NO black		



1

GEV No.	346280	Ref. No.	5060906194 5060911266
description	contact block GENERAL ELECTRIC P9901VN 1NC/1NO max 660V 10A red		
For models:	EKB-120, EKB-150, EKK-100, EKK-100-BF, EKK-150, EKK-150-BF, EKK-40, EKK-40-BF, EKM-50, EKM-90, GKB-120, GKB-120-BF, GKB-150, GKB-150-BF, GKM-50, GKM-90, KME-50, KMG-50		

momentary mushroom switches



1

GEV No.	346281	Ref. No.	5018606295 5018611265	
description	push button mounting measurements ø22mm black without switch			
For models:	KME-50, KMG-50			
accessories for	346281			
	GEV No.	345779	Ref. No.	—
	contact block GENERAL ELECTRIC P9B10VN 1NO max 400V 10A brown			
	GEV No.	345780	Ref. No.	—
	contact block GENERAL ELECTRIC P9B01VN 1NC max 660V 10A			
	GEV No.	346280	Ref. No.	5060906194 5060911266
	contact block GENERAL ELECTRIC P9901VN 1NC/1NO max 660V 10A red			

lamps



1

GEV No.	359606	Ref. No.	5061103274	
description	neon light bulb socket Ba9s 220V 2W clear ø 10mm L 28mm			
For models:	BMW-70, EKB-120E, EKB-120EII, EKB-120EII-BF, EKB-150E, EKB-150EII, EKB-150EII-BF, EKBD-125EII, EKBD-125EII-BF, EKBD-160EII, EKBD-160EII-BF, EKK-100E, EKK-40E, ESK-40E, ESK-80E, GBK120E, GKB-120, GKB-120-BF, GKB-120EII, GKB-150, GKB-150-BF, GKB-150EII, KKE-100, KKG100			
accessories for	359606			
	GEV No.	359832	Ref. No.	—
	lamp socket mounting measurements ø16.2mm socket Ba9s connection male faston 6.3mm			
	GEV No.	359853	Ref. No.	—
	lamp socket mounting measurements ø18.2mm socket Ba9s connection male faston 6.3mm			



1









GEV No.	359607	Ref. No.	5061103275	
description	neon light bulb socket Ba9s 380V 2W clear ø 10mm L 28mm			
accessories for	359607			
	GEV No.	359060	Ref. No.	—
	lamp socket mounting measurements ø16.2mm socket E10 connection screw			
	GEV No.	359063	Ref. No.	—
	lamp socket mounting measurements ø19.2mm socket E14 connection screw			
	GEV No.	359064	Ref. No.	—
	lamp socket mounting measurements ø22.3mm socket E14 connection screw 250/380V ambient temperature at 1W 100°C ambient temperature at 2W 85°C			

Table continues overleaf



accessories for	359607		
	GEV No.	359685	Ref. No. —
	lamp socket mounting measurements ø16.2mm socket E10		
	GEV No.	359832	Ref. No. —
	lamp socket mounting measurements ø16.2mm socket Ba9s connection male faston 6.3mm		
	GEV No.	359853	Ref. No. —
	lamp socket mounting measurements ø18.2mm socket Ba9s connection male faston 6.3mm		
	GEV No.	359988	Ref. No. —
	lamp socket mounting measurements ø30.5mm 250V connection F6.3 temp.-resist. 55°C E14		

encoders and potentiometers

	1		
GEV No.	347436	Ref. No.	5003518422
description	cam switch 2 operating positions 2NO sequence 0-1 16A shaft ø 6x4.6mm shaft L 23mm connection coded plug 10K/J cable length 2400mm 0.1-10KOhm 2-pole with potentiometer lampe green/red plug type 8-pole		
For models:	IHF-60, IHF-60-BF, IHF-60-D, IHF-90, IHF-90-BF, IHF-90-D		

	1		
GEV No.	401338	Ref. No.	R65321450
description	encoder		

	1		
GEV No.	300252	Ref. No.	5003522626 AM5003522626
description	potentiometer 2 operating positions 2NO sequence 0-1 16A shaft ø 6x4.6mm shaft L 23mm connection coded plug cable length 1420mm 10kOhm 12V with cable and indicator light		

lamps

indicator lights

indicator lights 2-piece (lens and indicator lamp)

indicator light lenses

ø13mm (type SFK-3)

	1		
GEV No.	359225	Ref. No.	5061111119
description	indicator light housings mounting measurements ø13mm clear Qty 1 pcs		

	1		
GEV No.	359127	Ref. No.	5061108880
description	indicator light housings mounting measurements ø13mm yellow Qty 1 pcs		
For models:	BPE-50, BPG-50, BUC-70, CPE-70, EKE-70, ERE-70, GUE-40, GUE-70, TPE-80, TPG-80		

indicator lamps for socket type SRZ / SDK / SDY / SFK

	1		
GEV No.	359131	Ref. No.	5061108879
description	indicator lamp 400V clear connection male faston 6.3mm		
For models:	BPE-50, BPG-50, BUC-70, CPE-70, EKE-70, ERE-70, GUE-40, GUE-70, TPE-80, TPG-80		

indicator lights 3-piece (housing, lens and bulb)

ø18.2mm

	1		
GEV No.	359069	Ref. No.	5061103271
description	indicator light ø 18.2mm 230V red		

lamps

neon light bulbs





	1		
GEV No.	359606	Ref. No.	5061103274
description	neon light bulb socket Ba9s 220V 2W clear ø 10mm L 28mm		
For models:	BMW-70, EKB-120E, EKB-120EII, EKB-120EII-BF, EKB-150E, EKB-150EII, EKB-150EII-BF, EKBD-125EII, EKBD-125EII-BF, EKBD-160EII, EKBD-160EII-BF, EKK-100E, EKK-40E, ESK-40E, ESK-80E, GBK120E, GKB-120, GKB-120-BF, GKB-120EII, GKB-150, GKB-150-BF, GKB-150EII, KKE-100, KKG100		
accessories for	359606		
	GEV No.	359832	Ref. No. —
	lamp socket mounting measurements ø16.2mm socket Ba9s connection male faston 6.3mm		

Table continues overleaf





accessories for	359606			
	GEV No.	359853	Ref. No.	—
	lamp socket mounting measurements ø18.2mm socket Ba9s connection male faston 6.3mm			



	1			
GEV No.	359607	Ref. No.	5061103275	
description	neon light bulb socket Ba9s 380V 2W clear ø 10mm L 28mm			
accessories for	359607			
	GEV No.	359060	Ref. No.	—
	lamp socket mounting measurements ø16.2mm socket E10 connection screw			
	GEV No.	359063	Ref. No.	—
	lamp socket mounting measurements ø19.2mm socket E14 connection screw			
	GEV No.	359064	Ref. No.	—
	lamp socket mounting measurements ø22.3mm socket E14 connection screw 250/380V ambient temperature at 1W 100°C ambient temperature at 2W 85°C			
	GEV No.	359685	Ref. No.	—
	lamp socket mounting measurements ø16.2mm socket E10			
	GEV No.	359832	Ref. No.	—
	lamp socket mounting measurements ø16.2mm socket Ba9s connection male faston 6.3mm			
	GEV No.	359853	Ref. No.	—
	lamp socket mounting measurements ø18.2mm socket Ba9s connection male faston 6.3mm			
	GEV No.	359988	Ref. No.	—
	lamp socket mounting measurements ø30.5mm 250V connection F6.3 temp.-resist. 55°C E14			



indicator lights (complete)



ø13mm

with screw socket



	1			
GEV No.	359046	Ref. No.	5061111708 5061111709	
description	indicator light ø 13mm 230V clear			
For models:	BPE-50, BUE-40, BUE-70, CH-40, CH-80, CHE-80, CHT-40, CHT-80, EBP-40-C, EBP-40-L, EBP-40-R, EBP-80-1-2LR, EBP-80-C, EBP-80-L, EBP-80-R, EF1-40, EF2-40, EHE-80, EPSE-80, EUB-40, EUB-60-ECO, EY1-40M, EY2-40M, EY-35M, GHE-120, GHE-80, GKS-100, GKS-150, GKS-60, GKS-80, GPSE-80, GUE-40, GUE-40-B, GUE-40-C, GUE-70, GUE-70-1-2LR, GUE-70-B, GUE-70-C, GUE-S-40, GUE-S-70, IHE-40, TPE-80, UBW-45II, UBW-45II-D			
accessories for	359046			
	GEV No.	510302	Ref. No.	—
	O-ring EPDM ID ø 12.42mm thickness 1.78mm Qty 1 pcs			
	GEV No.	511505	Ref. No.	—
	O-ring EPDM thickness 1.78mm ID ø 12.42mm Qty 10 pcs			



	1			
GEV No.	359144	Ref. No.	5061111704	
description	indicator light ø 13mm 230V red			
For models:	CH-40, CH-80, CHE-80, CHT-40, CHT-80			
accessories for	359144			
	GEV No.	510302	Ref. No.	—
	O-ring EPDM ID ø 12.42mm thickness 1.78mm Qty 1 pcs			
	GEV No.	511505	Ref. No.	—
	O-ring EPDM thickness 1.78mm ID ø 12.42mm Qty 10 pcs			



	1			
GEV No.	359146	Ref. No.	5061111706	
description	indicator light ø 13mm 230V yellow			
For models:	BPE-50, BPG-50, BU-35, BU-70, BUC-35, BUC-70, BUC-70-L, BUC-70-R, BUE-40, BUE-70, EBM-40, EBM-80, EBMC-40, EBMC-80, EBMC-80-L, EBMC-80-R, EF1-40, EF2-40, EUB-40, EUB-60-ECO, EY1-40M, EY2-40M, EY-35M, GKS-100, GKS-150, GKS-60, GKS-80, TPE-80, TPG-80			
accessories for	359146			
	GEV No.	510302	Ref. No.	—
	O-ring EPDM ID ø 12.42mm thickness 1.78mm Qty 1 pcs			
	GEV No.	511505	Ref. No.	—
	O-ring EPDM thickness 1.78mm ID ø 12.42mm Qty 10 pcs			



	1			
GEV No.	359050	Ref. No.	5061111707	
description	indicator light ø 13mm 400V yellow			
For models:	CHE-80, CPE-35, CPE-70, EBP-40-C, EBP-40-L, EBP-40-R, EBP-80-1-2LR, EBP-80-C, EBP-80-L, EBP-80-R, EH-40, EH-80, EHE-80, EK-40, EK-70, EKE-70, EKP40, EPK-40, EPS-40, EPS-80, EPSE-80, ER-105, ER-35, ER-70, ERE-105, ERE-70, EREC-105, GHE-120, GHE-80, GKE-70, GPSE-80, GRE-105, GRE-70, GREC-105, GUE-40, GUE-40-B, GUE-40-C, GUE-70, GUE-70-1-2LR, GUE-70-B, GUE-70-C, GUE-S-40, GUE-S-70, SIE-105, SIEC-105			
accessories for	359050			
	GEV No.	510302	Ref. No.	—
	O-ring EPDM ID ø 12.42mm thickness 1.78mm Qty 1 pcs			
	GEV No.	511505	Ref. No.	—
	O-ring EPDM thickness 1.78mm ID ø 12.42mm Qty 10 pcs			







ø16mm			
with screw socket			
			
1			
GEV No.	359835	Ref. No.	5061113846
description	indicator light ø 16mm 230V green connection male faston 6.3mm		
For models:	EKK-100, EKK-100-BF, EKK-150, EKK-150-BF, EKK-40, EKK-40-BF, ESK-100-80II-BF, ESK150, ESK-150II-BF, ESK-40, ESK60, ESK-60-40II-BF, ESK-80, GNKE-100, GNKE-150, GNKE-230, GSK100, GSK-100-80, GSK-100-80-BF, GSK-150, GSK-150-BF, GSK-40, GSK60, GSK-60-40, GSK-60-40-BF, GSK-80		
accessories for	359835		
	GEV No.	550559	Ref. No. —
nut thread M16x1 H 5.5mm WS 19			



			
1			
GEV No.	359831	Ref. No.	5061110293
description	indicator light ø 16mm 230V red connection male faston 6.3mm		
For models:	CH-45, CH-45-BF, CH-45-D, CH-45-T, CH-45-T-BF, CH-45-T-D, EKK-100, EKK-100-BF, EKK-40, EKK-40-BF, EP-45, EP-45-BF, EP-90, EP-90-BF, EP-90-D, ESK-100-80II-BF, ESK150, ESK-150II-BF, ESK-40, ESK-40E, ESK60, ESK-60-40II-BF, ESK-80, ESK-80E, GNKE-100, GNKE-150, GNKE-230, GSK100, GSK-100-80, GSK-100-80-BF, GSK-150, GSK-150-BF, GSK-40, GSK60, GSK-60-40, GSK-60-40-BF, GSK-80		
accessories for	359831		
	GEV No.	550559	Ref. No. —
nut thread M16x1 H 5.5mm WS 19			

			
1			
GEV No.	359829	Ref. No.	5061111121
description	indicator light ø 16mm 230V white connection male faston 6.3mm		
For models:	7CH-50, 7CH-80, 7EBP-40-L, 7EBP-60-C, 7EF1-50, 7EF2-50, 7EP-80, CH-45, CH-45-BF, CH-45-D, CH-45-T, CH-45-T-BF, CH-45-T-D, CH-70, EBM-45, EBM-45-BF, EBM-45-D, EBP-45-C, EBP-45-C-BF, EBP-45-C-D, EBP-45-L, EBP-45-L-BF, EBP-45-L-D, EBP-45-R, EBP-45-R-BF, EBP-45-R-D, EBP-90-1-2LR, EBP-90-1-2LR-BF, EBP-90-C, EBP-90-C-BF, EBP-90-C-D, EBP-90-L, EBP-90-L-BF, EBP-90-L-D, EBP-90-LR, EBP-90-R, EBP-90-R-BF, EBP-90-R-D, EF1-45, EF1-45-BF, EF1-45-D, EF2-45, EF2-45-BF, EF2-45-D, EH-45, EH-45-BF, EH-45-D, EH-90, EH-90-BF, EH-90-D...(Other models you can see in the webshop)		
accessories for	359829		
	GEV No.	550559	Ref. No. —
nut thread M16x1 H 5.5mm WS 19			

			
1			
GEV No.	359834	Ref. No.	5061109898
description	indicator light ø 16mm 230V yellow connection male faston 6.3mm temp.-resist. 120°C		
For models:	7EBP-40-L, 7EBP-60-C, 7EF1-50, 7EF2-50, 7EP-80, EBP-45-C, EBP-45-C-BF, EBP-45-C-D, EBP-45-L, EBP-45-L-BF, EBP-45-L-D, EBP-45-R, EBP-45-R-BF, EBP-45-R-D, EBP-90-1-2LR, EBP-90-1-2LR-BF, EBP-90-C, EBP-90-C-BF, EBP-90-C-D, EBP-90-L, EBP-90-L-BF, EBP-90-L-D, EBP-90-LR, EBP-90-R, EBP-90-R-BF, EBP-90-R-D, EF1-45, EF1-45-BF, EF1-45-D, EF2-45, EF2-45-BF, EF2-45-D, EKB-120, EKB-150, EKH-90, EKK-100, EKK-100-BF, EKK-150, EKK-150-BF, EKK-40, EKK-40-BF, EKM-50, EKM-90, ESK-100-80II-BF, ESK150, ESK-150II-BF, ESK-40, ESK60, ESK-60-40II-BF, ESK-80...(Other models you can see in the webshop)		
accessories for	359834		
	GEV No.	550559	Ref. No. —
nut thread M16x1 H 5.5mm WS 19			

			
1			
GEV No.	359830	Ref. No.	5061103271 5061103275 5061109899
description	indicator light ø 16mm 400V yellow connection male faston 6.3mm		
For models:	BEW-80, BEW-85, BEW-90, BMW-70, EF-40, EHE-70, EPE-80, FE2-40, GZE-70, HEE-81, K7E-35, K7E-50, KBHE-70-R, KKE-100, KKG100, KME-50, KSKE-100, KSKE-50, UBE-90, UBE-90-D, UBED-90-D		
accessories for	359830		
	GEV No.	550559	Ref. No. —
nut thread M16x1 H 5.5mm WS 19			

			
1			
GEV No.	357088	Ref. No.	5061119976
description	indicator light green LED ø 16mm 24VDC connection cable cable length 200mm temp.-resist. 150°C		
For models:	IHF4-80		
accessories for	357088		
	GEV No.	550559	Ref. No. —
nut thread M16x1 H 5.5mm WS 19			

			
1			
GEV No.	357089	Ref. No.	5061119975
description	indicator light red LED ø 16mm 24VDC connection cable cable length 200mm temp.-resist. 150°C		
For models:	IHF4-80		
accessories for	357089		
	GEV No.	550559	Ref. No. —
nut thread M16x1 H 5.5mm WS 19			



LED

indicator lamps

mounting diameter 25mm



1

GEV No.	360605	Ref. No.	5061112697 AM5061112697
description	indicator light LED mounting ø 25mm 24VDC green connection male faston 2.8mm		
For models:	IHE-40, IHE-45, IHF-60, IHF-60-BF, IHF-60-D, IHF-90, IHF-90-BF, IHF-90-D, IWOK-45II, IWOK-45II-BF, IWOK-45II-D		



1

GEV No.	360604	Ref. No.	5061112698 AM5061112698
description	indicator light LED mounting ø 25mm 24VDC red connection male faston 2.8mm		
For models:	IHE-40, IHE-45, IHF-60, IHF-60-BF, IHF-60-D, IHF-90, IHF-90-BF, IHF-90-D, IWOK-45II, IWOK-45II-BF, IWOK-45II-D		



screw-on/push-on fit

neon light bulbs



1





GEV No.	359606	Ref. No.	5061103274
description	neon light bulb socket Ba9s 220V 2W clear ø 10mm L 28mm		
For models:	BMW-70, EKB-120E, EKB-120EII, EKB-120EII-BF, EKB-150E, EKB-150EII, EKB-150EII-BF, EKBD-125EII, EKBD-125EII-BF, EKBD-160EII, EKBD-160EII-BF, EKK-100E, EKK-40E, ESK-40E, ESK-80E, GBK120E, GKB-120, GKB-120-BF, GKB-120EII, GKB-150, GKB-150-BF, GKB-150EII, KKE-100, KKG100		

accessories for	359606			
	GEV No.	359832	Ref. No.	—
	lamp socket mounting measurements ø16.2mm socket Ba9s connection male faston 6.3mm			
	GEV No.	359853	Ref. No.	—
	lamp socket mounting measurements ø18.2mm socket Ba9s connection male faston 6.3mm			



1

GEV No.	359607	Ref. No.	5061103275	
description	neon light bulb socket Ba9s 380V 2W clear ø 10mm L 28mm			
accessories for	359607			
	GEV No.	359060	Ref. No.	—
	lamp socket mounting measurements ø16.2mm socket E10 connection screw			

accessories for	359607			
	GEV No.	359063	Ref. No.	—
	lamp socket mounting measurements ø19.2mm socket E14 connection screw			
	GEV No.	359064	Ref. No.	—
	lamp socket mounting measurements ø22.3mm socket E14 connection screw 250/380V ambient temperature at 1W 100°C ambient temperature at 2W 85°C			
	GEV No.	359685	Ref. No.	—
	lamp socket mounting measurements ø16.2mm socket E10			
	GEV No.	359832	Ref. No.	—
	lamp socket mounting measurements ø16.2mm socket Ba9s connection male faston 6.3mm			
	GEV No.	359853	Ref. No.	—
	lamp socket mounting measurements ø18.2mm socket Ba9s connection male faston 6.3mm			
	GEV No.	359988	Ref. No.	—
	lamp socket mounting measurements ø30.5mm 250V connection F6.3 temp.-resist. 55°C E14			

halogen lamp

for socket G4 / G6.35 / G9



1

GEV No.	359599	Ref. No.	R65270020
description	halogen lamp socket G4 12V 20W temp.-resist. 500°C		

oven lamps

lamps

halogen lamps

for socket G4 / G6.35 / G9



1

GEV No.	359599	Ref. No.	R65270020
description	halogen lamp socket G4 12V 20W temp.-resist. 500°C		



timers

programme timers



1

GEV No.	400115	Ref. No.	R65095000 (old version)
description	gear motor FIBER P25 engines 1 chambers 1 operation time 20s 230V 50Hz shaft ø 6x4.6mm shaft L 24mm type M51BJ0R0000		

alarm devices

buzzers

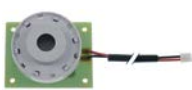

1

GEV No.	350086	Ref. No.	R65321440
description	buzzer 12VDC connection cable 200mm PCB buzzer 20dB		

contactors

BENEDIKT & JÄGER

power contactors



1

GEV No.	381082	Ref. No.	5061418833 AM5061418833
description	power contactor resistive load 25A 230VAC (AC3/400V) 14A/5.5kW main contacts 3NO auxiliary contacts 1NO connection screw connection type K3-14A10230		
For models:	IHF-60, IHF-60-BF, IHF-60-D, IHF-90, IHF-90-BF, IHF-90-D		

GENERAL ELECTRIC (AEG)

power contactors



1

GEV No.	380239	Ref. No.	5061411122
description	power contactor resistive load 20A 230VAC (AC3/400V) 8.4A/4kW main contacts 3NO auxiliary contacts 1NC connection screw connection type LS05 01A type AEG LS05 01A type GE MC1A 301A		
For models:	7EF1-50, 7EF2-50, EF1-40, EF2-45, EF2-45-BF, EF2-45-D, EY1-40M		



1

GEV No.	380263	Ref. No.	5061411123
description	power contactor resistive load 32A 230VAC (AC3/400V) 17A/7.5kW main contacts 4NO auxiliary contacts connection screw connection type AEG LS7K 400A type GE CL00A 310		
For models:	7EF1-50, 7EF2-50, BUE-40, BUE-70, EF1-40, EF1-45, EF1-45-BF, EF1-45-D, EF2-40, EF2-45, EF2-45-BF, EF2-45-D, EKB-120EII, EKB-120EII-BF, EKB-150EII, EKB-150EII-BF, EKBD-125EII, EKBD-125EII-BF, EKBD-160EII, EKBD-160EII-BF, EKK-100, EKK-100-BF, EKK-150, EKK-150-BF, EKK-40, EKK-40-BF, ESK-100-80II-BF, ESK150, ESK-150II-BF, ESK-40, ESK-40E, ESK60, ESK-60-40II-BF, ESK-80, ESK-80E, EUB-40, EUB-45-TB, EUB-45-TB-BF, EUB-45-TB-D, EUB-60-ECCO, EUB-60-TB, EUB-60-TB-BF, EUB-60-TB-D, EY1-40M, EY2-40M, EY-35M, GNKE-100, GNKE-150, GNKE-230		



1

GEV No.	380264	Ref. No.	5061407226
description	power contactor resistive load 45A 230VAC (AC3/400V) 25A/11kW main contacts 3NO auxiliary contacts connection screw connection type AEG LS11K 00A type GE CL25A 300		
For models:	BPE-50, EBP-70-V, EF1-45, EF1-45-BF, EF1-45-D, EF2-40, EF2-40-E, EKB-120, EKB-120E, EKB-120EII, EKB-120EII-BF, EKB-150, EKB-150E, EKB-150EII, EKB-150EII-BF, EKBD-125EII, EKBD-125EII-BF, EKBD-160EII, EKBD-160EII-BF, EKH-90, EKK-100, EKK-100-BF, EKK-100E, EKK-150, EKK-150-BF, EKK-40, EKK-40-BF, EKK-40E, EKM-50, EKM-90, ESK-100-80II-BF, ESK150, ESK-150II-BF, ESK-40, ESK-40E, ESK60, ESK-60-40II-BF, ESK-80, ESK-80E, EY2-40-E, EY2-40M, FE2-40-E, FE2-80-E, GE-40-V, GNKE-100, GNKE-150, GNKE-230, GUE-40-V, GUE-70-V, K7E-35...(Other models you can see in the webshop)		



auxiliary contacts



1

GEV No.	380270	Ref. No.	5061410718
description	auxiliary contact contacts 1NO/1NC for contactors CL+LS_K connection screw AC-12 10A type AEG HS08K 11 type GE BCLL 11		
For models:	7EF1-50, EF1-40, EF1-45, EF1-45-BF, EF1-45-D, EF2-40, EF2-45, EF2-45-BF, EF2-45-D, EY1-40M, EY2-40M, EY-35M		

SIEMENS

power contactors



1

GEV No.	380652	Ref. No.	R65140380
description	power contactor resistive load 22A 230VAC (AC3/400V) 9A/4kW main contacts 3NO auxiliary contacts 1NC connection screw connection type 3RT10-16-1AP02		



1

GEV No.	380646	Ref. No.	R65140400
description	power contactor resistive load 40A 230VAC (AC3/400V) 17A/7.5kW main contacts 3NO auxiliary contacts connection screw connection type 3RT10-25-1AL20		

auxiliary contacts



1

GEV No.	380647	Ref. No.	R65140430
description	auxiliary contact contacts 1NO/1NC AC15 3A for contactors 3RT102 3 RT103 connection screw connection type 3RH1921-1EA11 resistive load 10A AC-12 10A		



relays

plug-in/print relays

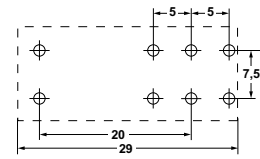

1



GEV No.	380333	Ref. No.	R65170050	
description	print relay 230VAC 2CO at 250V 8A connection pins raster size 5mm FINDER manuf. no. 40.52.8.230.0000 95.65/95.75			
accessories for	380333			
	GEV No.	380340	Ref. No.	—
	relay socket dimensions 62x36x15mm 250V voltage AC 10A Italiana Relè manuf. no. ZMEM/5			
	GEV No.	380505	Ref. No.	—
	relay socket 2CO 40.52 dimensions 81.9x15.5x75mm 250V voltage AC 10A FINDER manuf. no. 95.95.3			
	GEV No.	381181	Ref. No.	—
	relay socket 2-pole 40.51/40.52/40.61 connection screw clamp dimensions 15.8x78.6mm 250V voltage AC 10A FINDER manuf. no. 95.75			

time relays

time relays



1

GEV No.	380088	Ref. No.	5061410308
description	time relay 16A 230V		
For models:	EKB-120E, EKB-150E, EKK-100E, EKK-40E, ESK-40E, ESK-80E, GBK120E, GKB-120EII, GKB-150EII		



transformers

encapsulated transformers

with screw connection



1

GEV No.	400127	Ref. No.	R65180430
description	transformer primary 230VAC secondary 12VAC 40VA secondary 3.2A H 63mm L 75mm W 78mm connection 2-wire connection systems 50/60Hz moulded		

PMA



1

GEV No.	401340	Ref. No.	R65180770
description	transformer primary 220/240V secondary 24V 50VA secondary 2.1A connection screw 50/60Hz		



1

GEV No.	400982	Ref. No.	5062808246
description	transformer primary 230V secondary 9V 16VA secondary 1.7A connection screw 50Hz		



1

GEV No.	400988	Ref. No.	5062808246 5062812746
description	transformer primary 230V secondary 9V 16VA secondary 1.7A connection screw 50Hz		
For models:	EKB-120E, EKB-120EII, EKB-120EII-BF, EKB-150E, EKB-150EII, EKB-150EII-BF, EKBD-125EII, EKBD-125EII-BF, EKBD-160EII, EKBD-160EII-BF, EKK-100E, EKK-40E, ESK-40E, ESK-80E, GBK120E, GKB-120EII, GKB-150EII		



1

GEV No.	400126	Ref. No.	R65180420
description	transformer primary 230VAC secondary 12VAC 20VA secondary 2.1A connection screw 50Hz		

power supplies



1

GEV No.	378114	Ref. No.	5062807686
description	transformer primary 230VAC secondary 12VDC 50/60Hz DIN rail 1.5A		



1

GEV No.	379257	Ref. No.	5062807686
description	transformer type EC-PSM10 EVERY CONTROL supply 230VAC supply 12VDC		
For models:	EBP-70-V, EF2-40-E, EY2-40-E, FE2-80-E, GE-40-V, GUE-40-V, GUE-70-V		

electronic controllers

EVCO - EVERY CONTROL

accessories



1

GEV No.	379257	Ref. No.	5062807686
description	transformer type EC-PSM10 EVERY CONTROL supply 230VAC supply 12VDC		
For models:	EBP-70-V, EF2-40-E, EY2-40-E, FE2-80-E, GE-40-V, GUE-40-V, GUE-70-V		



JUMO

universal controllers

built-in version



GEV No.	379255	Ref. No.	5061607180
----------------	--------	-----------------	------------

description electronic controller 0-200°C

For models: EF2-40-E, EY2-40-E, FE2-40-E, FE2-80-E

accessories for 379255

GEV No.	379111	Ref. No.	5024107685
----------------	--------	-----------------	------------

description temperature probe thermocouple J (Fe-CuNi) cable Vetrotex probe -50 up to +750°C cable -50 up to +350°C connection 2-wire thread M20x1 probe ø6x140mm cable length 0.6m

GEV No.	379257	Ref. No.	5062807686
----------------	--------	-----------------	------------

description transformer type EC-PSM10 EVERY CONTROL supply 230VAC supply 12VDC



GEV No.	379042	Ref. No.	5061608159
----------------	--------	-----------------	------------

description electronic controller 0-250°C

For models: EBP-70-V, GE-40-V, GUE-40-V, GUE-70-V

accessories for 379042

GEV No.	379099	Ref. No.	5024107164
----------------	--------	-----------------	------------

description temperature probe thermocouple J (Fe-CuNi) cable Vetrotex probe -50 up to +750°C cable -50 up to +350°C connection 2-wire thread probe ø4.5x50mm cable length 1.4m

GEV No.	379257	Ref. No.	5062807686
----------------	--------	-----------------	------------

description transformer type EC-PSM10 EVERY CONTROL supply 230VAC supply 12VDC

accessories

transformers



GEV No.	378114	Ref. No.	5062807686
----------------	--------	-----------------	------------

description transformer primary 230VAC secondary 12VDC 50/60Hz DIN rail 1.5A



GEV No.	379257	Ref. No.	5062807686
----------------	--------	-----------------	------------

description transformer type EC-PSM10 EVERY CONTROL supply 230VAC supply 12VDC

For models: EBP-70-V, EF2-40-E, EY2-40-E, FE2-80-E, GE-40-V, GUE-40-V, GUE-70-V

probes

producer-specific probes

probes

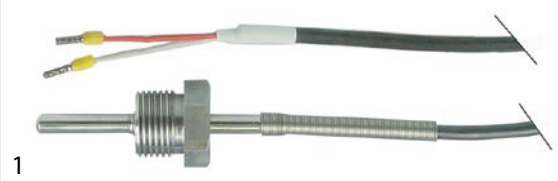

GEV No.	379915	Ref. No.	5024109876
----------------	--------	-----------------	------------

description temperature probe Pt100 cable silicone probe -100 up to 450°C cable -50 up to +180°C connection 2-wire probe ø6x30mm cable length 2.1m

For models: EKK-100E, EKK-40E



GEV No.	379394	Ref. No.	5024117582
----------------	--------	-----------------	------------

description temperature probe Pt100 cable silicone probe -100 up to 450°C cable -50 up to +180°C connection 3-wire thread probe ø8mm cable length 1.5m probe ø 8mm

For models: EKBD-125EII, EKBD-125EII-BF, EKBD-160EII, EKBD-160EII-BF



GEV No.	379393	Ref. No.	5024109875
----------------	--------	-----------------	------------

description temperature probe Pt100 cable Vetrotex probe -200 up to +600°C cable -50 up to +350°C connection 2-wire thread 1/4" probe ø6x15mm cable length 2m

For models: EKBD-125EII, EKBD-125EII-BF, EKBD-160EII, EKBD-160EII-BF



GEV No.	379111	Ref. No.	5024107685
----------------	--------	-----------------	------------

description temperature probe thermocouple J (Fe-CuNi) cable Vetrotex probe -50 up to +750°C cable -50 up to +350°C connection 2-wire thread M20x1 probe ø6x140mm cable length 0.6m

For models: EF2-40-E, EY2-40-E, FE2-40-E, FE2-80-E



GEV No.	379099	Ref. No.	5024107164
----------------	--------	-----------------	------------

description temperature probe thermocouple J (Fe-CuNi) cable Vetrotex probe -50 up to +750°C cable -50 up to +350°C connection 2-wire thread probe ø4.5x50mm cable length 1.4m

For models: EBP-70-V, GE-40-V, GUE-40-V, GUE-70-V

accessories

plugs/bushes



1			
GEV No.	378016	Ref. No.	LAR65320920
description	female connector 4-pole		



1			
GEV No.	378017	Ref. No.	LAR65321020
description	lid for plug contact		

miscellaneous



1			
GEV No.	379856	Ref. No.	R86020420
description	bag for core temperature probe		

electronics

EPROMS



1			
GEV No.	400977	Ref. No.	5062916941
description	EPROM		
For models:	EKB-120EII, EKB-120EII-BF, EKB-150EII, EKB-150EII-BF		



1			
GEV No.	400978	Ref. No.	5062916935
description	EPROM		
For models:	EKB-120EII, EKB-120EII-BF, EKB-150EII, EKB-150EII-BF		



1			
GEV No.	400985	Ref. No.	5062916940
description	EPROM		
For models:	EKBD-125EII, EKBD-125EII-BF, EKBD-160EII, EKBD-160EII-BF		



1			
GEV No.	400986	Ref. No.	5062916934
description	EPROM		
For models:	EKBD-125EII, EKBD-125EII-BF, EKBD-160EII, EKBD-160EII-BF		

PCBs



1			
GEV No.	400973	Ref. No.	5062909870
description	keypad PCB		
For models:	EKB-120E, EKB-150E, EKK-100E, EKK-40E, ESK-40E, ESK-80E, GBK120E, GKB-120EII, GKB-150EII		





1

GEV No.	400979	Ref. No.	5062916945
description	keypad PCB		
For models:	EKB-120EII, EKB-120EII-BF, EKB-150EII, EKB-150EII-BF, EKBD-125EII, EKBD-125EII-BF, EKBD-160EII, EKBD-160EII-BF		



1

GEV No.	401591	Ref. No.	LAR65301460 R65301410
description	keypad PCB combi-steamer ME061T complete		
spare parts for	401591		
	GEV No.	350086	Ref. No. R65321440
	buzzer 12VDC connection cable 200mm PCB buzzer 20dB		
	GEV No.	401338	Ref. No. R65321450
	encoder		



1

GEV No.	401352	Ref. No.	R65301330
description	keypad PCB temperature		



1

GEV No.	401341	Ref. No.	LAR63130021 R63130020
description	PCB		



1

GEV No.	402825	Ref. No.	R65301480
description	PCB combi-steamer GEMT L 130mm W 86mm new edition level control steam generator EVCO		



1

GEV No.	401935	Ref. No.	3562916938 AM3562916938 AM5062916944
description	PCB for tilting bratt pan L 225mm W 150mm cable length 700mm with housing		
For models:	EKB-120EII, EKB-120EII-BF, EKB-150EII, EKB-150EII-BF		



1

GEV No.	400074	Ref. No.	5070110568
description	PCB pyroceram range 2023206-00 400V		



1

GEV No.	400411	Ref. No.	5070110568
description	PCB pyroceram range CH 40/45/80 230V		
For models:	CH-45-T, CH-45-T-BF, CH-45-T-D, CHT-40, CHT-80		



central units

1 
Image not available

GEV No.	400976	Ref. No.	3562917713
description	control box RS485 for tilting bratt pan		
For models:	EKB-120EII, EKB-120EII-BF, EKB-150EII, EKB-150EII-BF		

2 
Image not available

GEV No.	400984	Ref. No.	3562917712
description	control box RS485 for tilting bratt pan		
For models:	EKBD-125EII, EKBD-125EII-BF, EKBD-160EII, EKBD-160EII-BF		

1 
Image not available

GEV No.	400983	Ref. No.	3562916937
description	control box standard for tilting bratt pan		
For models:	EKBD-125EII, EKBD-125EII-BF, EKBD-160EII, EKBD-160EII-BF		

keypads

front foils

1 

GEV No.	400974	Ref. No.	5011814552
description	keypad foil		
For models:	EKB-120E, EKB-150E, EKK-100E, EKK-40E, GBK120E, GKB-120EII, GKB-150EII		

1 

GEV No.	400980	Ref. No.	5011810838
description	keypad foil		
For models:	EKB-120EII, EKB-120EII-BF, EKB-150EII, EKB-150EII-BF, ESK-40E, ESK-80E		

1 

GEV No.	400987	Ref. No.	5011817558
description	keypad foil		
For models:	EKBD-125EII, EKBD-125EII-BF, EKBD-160EII, EKBD-160EII-BF		









solenoid valves

solenoid valves (water)

MÜLLER

medium temperature: 90°C
duty cycle: 100%

1 

GEV No.	370005	Ref. No.	0118111645 5018106152
description	solenoid valve single straight 230VAC inlet 1/2" outlet 1/2" DN10 t.max. 90°C duty cycle 100% MÜLLER		
For models:	KME-50, KMG-50		
spare parts for	370005		
	GEV No.	371002	Ref. No. —
	solenoid valve holder MÜLLER flange support		
	GEV No.	371009	Ref. No. —
	compression spring for solenoid coil		
	GEV No.	371011	Ref. No. —
	spare parts kit membrane with long star star high 8mm MÜLLER		
	GEV No.	371017	Ref. No. —
	solenoid coil MÜLLER 230VAC connection male faston 6.3mm		
accessories for	370005		
	GEV No.	371010	Ref. No. —
	solenoid coil 230VAC connection with cable cable length 2000mm		
	GEV No.	371037	Ref. No. —
	solenoid coil 24VAC 50/60Hz connection male faston 6.3mm		
	GEV No.	371038	Ref. No. —
	solenoid coil 230VAC connection appliance plug		
	GEV No.	501064	Ref. No. —
	solenoid valve filter SS filter		

RPE

JOHN GUEST

1 

GEV No.	374032 ¹	Ref. No.	R65110230
description	solenoid valve double straight 230VAC inlet 3/4" outlet 10mm DN10 plastic output A w/t membrane (constantly open)		

¹cylindrical outlet

			
1			
GEV No.	370768 ¹	Ref. No.	R65110200
description	solenoid valve single straight 230VAC inlet 3/4" outlet 10mm input/ min output/ min DN10 t.max. 90°C duty cycle 100% RPE		

¹cylindrical outlet

solenoid valves with reducers

2-fold

			
1			
GEV No.	374031	Ref. No.	R65110210
description	solenoid valve double straight 230VAC inlet 3/4 outlet JG 10 input 10-12l/min t.max. 90°C RPE plastic flow regulating valve inlet white + outlet reducer red		

3-fold

			
1			
GEV No.	374033	Ref. No.	R65110240
description	solenoid valve triple straight 230VAC inlet 3/4" outlet 10mm input 10-12l/min t.max. 90°C RPE plastic flow regulating valve inlet white output B w/t membrane (constantly open)		

various

			
1			
GEV No.	370363	Ref. No.	R65110260
description	solenoid valve single straight cable length 600mm suitable for LAINOX		

metal

OLAB

solenoid valves

2-way

			
1			
GEV No.	370695	Ref. No.	5018127041
description	solenoid valve brass 2-ways 230VAC inlet 1/2" IT outlet 1/2" IT connection 1/2" L 69mm DN 13.5mm Olab 50Hz		
For models:	GNKG-150EIII		

SIRAI

2-way

L180-B series

			
1			
GEV No.	370047	Ref. No.	5018106153
description	solenoid valve brass 2-ways 230VAC inlet 1/2" outlet 1/2" connection 1/2" L 66mm DN 13.5mm slide-on receptacle compact -10 up to +90°C SIRAI type series L180-B coil type Z610A membranes NBR (water) p max 12bar p min 0.35bar 50/60Hz		
spare parts for	370047		
	GEV No.	371085	Ref. No. —
	solenoid coil 230VAC 4VA SIRAI coil type ZB10A seat ø 10mm 50/60Hz		
	GEV No.	371171	Ref. No. —
	membrane series L180-B membrane type NBR (water)		
accessories for	370047		
	GEV No.	371091	Ref. No. —
	power socket plug type DIN 43650B cable lengthmm small		



solenoid valves steam (water)

2-way

L153-D series



1

GEV No.	370079	Ref. No.	5018120322
description	solenoid valve 2-ways 230VAC connection 3/4" L 79mm DN 17mm slide-on receptacle DIN -10 up to 140°C SIRAI type series L153-D coil type Z134A membranes EPDM (steam/water) p max 8bar p min 0.1bar 50Hz		
accessories for	370079		
	GEV No.	371077	Ref. No. —
	solenoid coil 230VAC 24VA SIRAI coil type Z110A/Z114A/Z134A seat ø 14mm		

solenoid valves (gas)

BRAHMA

solenoid valves



1

GEV No.	101948 ¹	Ref. No.	5018106116
description	solenoid valve 230VAC DN 15mm connection 1/2" L 72mm BRAHMA coil type 18811003 p max 0.5bar reg. no. 63AQ0626		
For models:	KKG100		
spare parts for	101948		
	GEV No.	101968	Ref. No. 5061507400
	solenoid valve 230VAC 20VA seat ø 17mm coil type 13902001 BRAHMA		

¹aluminium housing

spare parts and accessories

solenoid coils



1

GEV No.	101968	Ref. No.	5061507400
description	solenoid valve 230VAC 20VA seat ø 17mm coil type 13902001 BRAHMA		

ball valves electric



1

GEV No.	401342	Ref. No.	R65110560 old Version
description	ball valve inlet 3/4" IT outlet 3/4" IT 230V IT 3/4"		



1

GEV No.	403042	Ref. No.	R65110560
description	ball valve inlet 3/4" IT outlet 3/4" IT 230V L 68mm closed off-current mode of operation electric connection cable 400mm		

pressure switches

for gas equipment



1

GEV No.	541073	Ref. No.	5061309598 R63070010
description	pressure control ø 45mm pressure range adjustable 5-20mbar pressure connection vertical gas technology connection 1/4" pressure connection ø 1/4"mm		
For models:	GF1-45, GF1-45-BF, GF1-45-D, GF2-60, GF2-60-BF, GF2-60-D, GSK100, GSK-100-80, GSK-100-80-BF, GSK-150, GSK-150-BF, GSK-40, GSK60, GSK-60-40, GSK-60-40-BF, GSK-80, TPG-80		



for steam control

			
1			
GEV No.	541181	Ref. No.	5061307558 5061315480
description	pressure control ø 45mm pressure range max. 1000mbar pressure connection vertical steam control pressure range 0.450+20/0.400+20bar connection 3/8" 1CO 250V 6A membranes Viton pressure connection 3/8"		
For models:	BPE-50, BPG-50, EKBD-125EII, EKBD-125EII-BF, EKBD-160EII, EKBD-160EII-BF, EKK-100, EKK-100-BF, EKK-100E, EKK-150, EKK-150-BF, EKK-40, EKK-40-BF, EKK-40E, ESK-100-80II-BF, ESK150, ESK-150II-BF, ESK-40, ESK-40E, ESK60, ESK-60-40II-BF, ESK-80, ESK-80E, GBK120E, GKB-120, GKB-120-BF, GKB-120EII, GKB-150, GKB-150-BF, GKB-150EII, GKS-100, GKS-150, GKS-60, GKS-80, GNKE-100, GNKE-150, GNKE-230, GSK100, GSK-100-80, GSK-100-80-BF, GSK-150, GSK-150-BF, GSK-40, GSK60, GSK-60-40, GSK-60-40-BF, GSK-80, K7E-35, K7E-50, KKE-100...(Other models you can see in the webshop)		

cross flow fans

			
1			
GEV No.	601505	Ref. No.	5062116831
description	cross flow fan QLN65/2400A17-3030L roller ø 65mm roller length 240mm laminated core thickness 29mm motor position right 230V/50Hz 22W refrigeration bearing silicone connection F 6.3 0 up to +60°C 230V throughput 200m³/h 50Hz		
For models:	IHE-40, IHE-45		

electrodes

			
1			
GEV No.	400130	Ref. No.	R65320010
description	level electrode M14x1.25 total length 220mm probe L 194mm insulated probe length 26mm connection male faston 6.3mm ø 2.5mm		

hot air motors

			
1			
GEV No.	550857	Ref. No.	R58003870
description	counterflange for fan motor ED ø 50mm int. ø 1 25mm int. ø 2 16mm thickness 6mm brass		

fans

axial fans

ebm-papst

			
1			
GEV No.	601030 ¹	Ref. No.	R65060050
description	axial fan L 119mm W 119mm H 38mm 230VAC 50Hz 18W bearing ball bearing manuf. no. 4656Z metal connection male faston 2.8mm ebm-papst fan wheel ø 110mm temp.-resist. 75°C		
accessories for	601030		
	GEV No.	550898	Ref. No. —
	connecting cable cable length 2000mm connection F 2.8 connection distance 7.9mm for axial flow fan		
	GEV No.	692497	Ref. No. —
	guard ø 105mm mounting distance 150mm for axial fan ebm-papst-mm		

			
1			
GEV No.	550859	Ref. No.	R58003850
description	counterflange for fan motor ED ø 60mm int. ø 1 34mm int. ø 2 25mm thickness 6mm brass		

			
1			
GEV No.	500135	Ref. No.	R65040031
description	fan motor 200-240V 1 phase 50Hz 0.185/0.55kW 900/1400rpm speeds 2 L1 195mm L2 45mm L3 47mm D1 ø 24mm D2 ø 20mm M12L IT 3.6/2A suitable capacitor 16µF-450V/12.5µF-450V at 50Hz 900/1400rpm type 1063D2250		

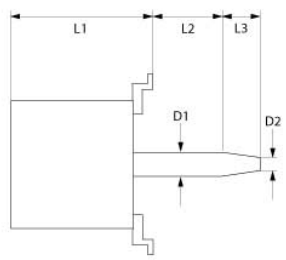

¹with ball bearings





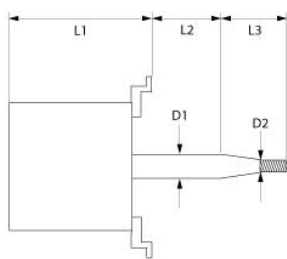

1

GEV No.	501587	Ref. No.	LAR65040051
description	fan motor 220-240V 1 phase 50/60Hz 0.55kW 1400/1700rpm L1 190mm L2 45mm L3 47mm D1 ø 24mm D2 ø 20mm M12L IT 3.6A type 1063A2250		



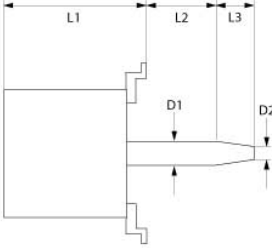

1

GEV No.	500659	Ref. No.	R65040550
description	fan motor 230V 1 phase 50/60Hz 0.55kW 1400/1700rpm speeds 1 L1 150mm L2 52mm L3 45mm D1 ø 24mm D2 ø 20mm M12L IT 3A suitable capacitor 20µF/450V Cos(φ) 0.9 at 50Hz 1400rpm at 60Hz 1700rpm type 3042A2350		
spare parts for	500659		
	GEV No.	Ref. No.	R70020050
	shaft sealing ID ø 24mm ED ø 29mm thickness 3mm		



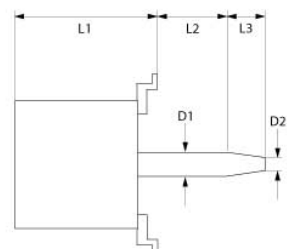

1

GEV No.	500136	Ref. No.	R65040041
description	fan motor 220-240V 1 phase 50/60Hz 0.55kW 1400rpm speeds 1 L1 190mm L2 47mm L3 47mm D1 ø 24mm D2 ø 20mm M12L IT 3.6A suitable capacitor 16µF/450V Cos(φ) 0.9 at 50Hz 1400rpm at 60Hz 1700rpm type 1063/4M		
accessories for	500136		
	GEV No.	Ref. No.	R70020050
	shaft sealing ID ø 24mm ED ø 29mm thickness 3mm		

1

GEV No.	500657	Ref. No.	R65040540
description	fan motor 230V 1 phase 50Hz 0.15/0.55kW 900/1400rpm speeds 2 L1 150mm L2 45mm L3 47mm D1 ø 24mm D2 ø 20mm M12L IT 1.3/3.0A suitable capacitor 20/10µF Cos(φ) 0.98 at 50Hz 900/1400rpm at 60Hz 1100/1700rpm 4P/6P type LM/FB 100L no. 472986		
spare parts for	500657		
	GEV No.	Ref. No.	R70020050
	shaft sealing ID ø 24mm ED ø 29mm thickness 3mm		

1

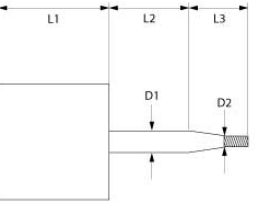
GEV No.	500661	Ref. No.	R65040431
description	fan motor 220-240V 1 phase 50Hz 0.03/0.2kW 0.05/0.25HP 1400/2700rpm speeds 2 L1 123mm L2 77mm L3 30mm D1 ø 15mm D2 ø 12mm M10L ET 1.6/0.6A suitable capacitor 10µF/450V at 50Hz 1400/2700rpm type 1057D1901		

1

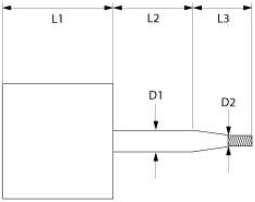
GEV No.	500663	Ref. No.	R65040421
description	fan motor 230V 1 phase 50Hz 0.18kW 0.25HP 2800rpm speeds 1 L1 123mm L2 77mm L3 30mm D1 ø 15mm D2 ø 12mm M10L ET 1.6A suitable capacitor 10µF/400V Cos(φ) 0.95 at 50Hz 2800rpm type 1057C2401		



hot air fans

miscellaneous

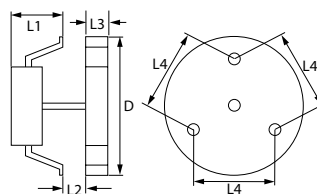

1



GEV No.	601054	Ref. No.	5062114289
description	hot air fan 220-240V 32W 50/60Hz L1 60mm L2 10mm L3 25mm L4 87mm fan wheel ø 150mm FIME type C20X0E01/46		
For models:	EBMC-40, EBMC-80, EBMC-80-L, EBMC-80-R, UBW-45II, UBW-45II-D, UBW-90II, UBW-90II-D		
spare parts for	601054		
	GEV No.	601441	Ref. No. —
	fan wheel ø 150mm W 25mm shaft intake ø 6x5mm stainless steel blades 7		
accessories for	601054		
	GEV No.	550879	Ref. No. —
	insulation ø 130mm thickness 3mm hole ø 20mm for hot air fan		

radial fans

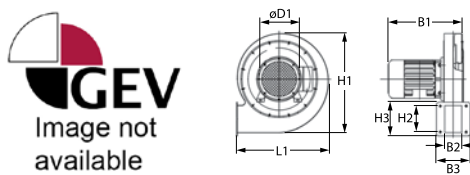

1

GEV No.	601245	Ref. No.	R63130010
description	radial fan 24V voltage DC 50Hz 45W H1 170mm L1 170mm D1 ø 50mm W1 90mm W2 44mm H2 57mm W3 83mm H3 83mm		
accessories for	601245		
	GEV No.	104309	Ref. No. —
	gasket L 106mm W 100mm H 3mm 4 holes		



1

GEV No.	601243	Ref. No.	R75400400
description	fan wheel D1 ø 220mm H1 78mm blades 12 D2 ø 11mm D3 ø 16mm H2 29mm		



1

GEV No.	601244	Ref. No.	R75400440
description	fan wheel D1 ø 350mm H1 114mm blades 12 D2 ø 19.5mm D3 ø 23mm H2 45mm		



1

GEV No.	550856	Ref. No.	LA58003860 R58003860
description	flange for fan motor ED ø 50mm int. ø 1 19.5mm int. ø 2 16mm thickness 3mm brass		



1

GEV No.	550858	Ref. No.	R58003840
description	flange for fan motor ED ø 60mm int. ø 1 28.5mm int. ø 2 25mm thickness 4mm brass		



1

GEV No.	511171	Ref. No.	R70020040
description	shaft seal ID ø 14.5mm ED ø 20mm thickness 3mm		



1

GEV No.	511172	Ref. No.	R70020050
description	shaft sealing ID ø 24mm ED ø 29mm thickness 3mm		



motors

gear motors

for tilting bratt pans



1

GEV No.	501500	Ref. No.	AM0161227928
description	gear motor 90W 230/400V 50Hz 1340rpm shaft ø 24mm L 300mm W 120mm H 245mm tilting bratt pan		



1

GEV No.	500617	Ref. No.	5061211730
description	gear motor for tilting bratt pan		
For models:	EKM-90, GKM-90		



1

GEV No.	500615	Ref. No.	5061207235 5061211730
description	gear motor type 156B4 90/110W 230/400V 50/60Hz 3 phase 0.48/0.58rpm shaft ø 24mm L 260mm W 130mm H 270mm for tilting bratt pan		

spindle motors

MAGNETIC



1

GEV No.	500612	Ref. No.	5061207233
description	spindle motor type WSP2650-150-01 230W 230V 50Hz 1 phase shaft ø 30mm for tilting bratt pan L 420mm W 110mm H 190mm hub 150mm MAGNETIC		
For models:	KME-50, KMG-50		

SKF/ATB



1

GEV No.	500613	Ref. No.	5061214801
description	spindle motor type SRBFU0,09/2-B31R/0310 230V 50Hz shaft ø 12mm for tilting bratt pan hub 155mm SKF/ATB		
For models:	EKM-50, GKM-50		



1

GEV No.	500614	Ref. No.	5061214601
description	spindle motor type SRBFU0,09/2-B31R/0311 40W 230V 50Hz shaft ø 12mm for tilting bratt pan hub 200mm SKF/ATB		
For models:	EKB-120, EKB-120E, EKB-120EII, EKB-120EII-BF, EKB-150, EKB-150E, EKB-150EII, EKB-150EII-BF, EKBD-125EII, EKBD-125EII-BF, EKBD-160EII, EKBD-160EII-BF, EKK-100, EKK-100-BF, EKK-100E, EKK-40, EKK-40-BF, EKK-40E, GBK120E, GKB-120, GKB-120-BF, GKB-120EII, GKB-150, GKB-150-BF, GKB-150EII		



1



GEV No.	500638	Ref. No.	5061214563
description	spindle motor type SRBFU0,09/2-B31R/X07 230V 50Hz shaft ø 12mm for tilting kettle L 500mm W 100mm H 150mm SKF/ATB		
For models:	EKK-150, EKK-150-BF		

pumps

vibration pumps



1

GEV No.	500568	Ref. No.	R65110600	
description	vibration pump 230V 32W 50Hz inlet ø 7 outlet ø 1/8" IT CEME type E512/A32			
spare parts for	500568			
	GEV No.	390698	Ref. No.	—
	thermal fuse switch-off temp. 110°C suitable for ULKA pump			
	GEV No.	520153	Ref. No.	—
	bracket rubber dimensions 53x34x28mm			

condensators & interference suppression filters

operating capacitors

plastic



GEV No.	365034	Ref. No.	R65190090
description	operating capacitor capacity 12µF with plastic sheathing		



GEV No.	365021	Ref. No.	R65190030
description	operating capacitor capacity 16µF 425V tolerance 5% 50/60Hz ambient temperature max. -25 to +85°C ø 35mm L 73mm single M8 plastic connection male faston 6.3mm 416.10.99 protection		



GEV No.	365203	Ref. No.	5061211324 AM5061211324
description	operating capacitor capacity 6.3µF 250V tolerance 10% 50Hz cable length 190mm		
For models:	EKB-120, EKB-120E, EKB-120EII, EKB-120EII-BF, EKB-150, EKB-150E, EKB-150EII, EKB-150EII-BF, EKBD-125EII, EKBD-125EII-BF, EKBD-160EII, EKBD-160EII-BF, EKK-100, EKK-100-BF, EKK-100E, EKK-150, EKK-150-BF, EKK-40, EKK-40-BF, EKK-40E, EKM-50, GBK120E, GKB-120, GKB-120-BF, GKB-120EII, GKB-150, GKB-150-BF, GKB-150EII, GKM-50		

filters

RC circuits



GEV No.	380272	Ref. No.	5050912346
description	RC circuit for contactors type 910-304-585-50 130-250V 50-60Hz conductor 2 connection cable plastic Qty 1 pcs for contactors LS4_LS15K type AEG LR2K A250 type GE BS2R2R		
For models:	BUE-40, BUE-70, EF1-40, EF1-45, EF1-45-D, EF2-40, EF2-45-BF, EKB-120, EKB-120E, EKB-120EII, EKB-120EII-BF, EKB-150, EKB-150E, EKB-150EII, EKB-150EII-BF, EKBD-125EII, EKBD-125EII-BF, EKBD-160EII, EKBD-160EII-BF, EKH-90, EKK-100, EKK-100-BF, EKK-100E, EKK-150, EKK-150-BF, EKK-40, EKK-40-BF, EKK-40E, EKM-50, EKM-90, ESK-100-80II-BF, ESK150, ESK-150II-BF, ESK-40, ESK-40E, ESK60, ESK-60-40II-BF, ESK-80, ESK-80E, EUB-40, EUB-45-TB, EUB-45-TB-BF, EUB-45-TB-D, EUB-60-ECO, EUB-60-TB, EUB-60-TB-BF, EUB-60-TB-D, EY1-40M, EY2-40M, EY-35M... (Other models you can see in the webshop)		

fuses

fine fuses



GEV No.	358533	Ref. No.	5061807231
description	fine fuse size ø5x20mm 6.3A fast-acting rated 250V Qty 10 pcs		
For models:	EKB-120E, EKB-150E, EKH-90, EKK-100E, EKK-40E, EKM-50, EKM-90, ESK-40E, ESK-80E, GBK120E, GKB-120EII, GKB-150EII, GKM-50, GKM-90, GSK100, GSK-100-80, GSK-100-80-BF, GSK-150, GSK-150-BF, GSK-40, GSK60, GSK-60-40, GSK-60-40-BF, GSK-80, KME-50, KMG-50, TPE-80, TPG-80		



GEV No.	358678	Ref. No.	5061809773
description	fine fuse size ø5x20mm 8A fast-acting rated 250V Qty 10 pcs		
For models:	EKB-120, EKB-120E, EKB-120EII, EKB-120EII-BF, EKB-150, EKB-150E, EKB-150EII, EKB-150EII-BF, EKK-100, EKK-100-BF, EKK-100E, EKK-150, EKK-150-BF, EKK-40, EKK-40-BF, EKK-40E, ESK-100-80II-BF, ESK150, ESK-150II-BF, ESK-40, ESK-40E, ESK60, ESK-60-40II-BF, ESK-80, ESK-80E, GBK120E, GKB-120, GKB-120-BF, GKB-120EII, GKB-150, GKB-150-BF, GKB-150EII, GNKE-100, GNKE-150, GNKE-230		

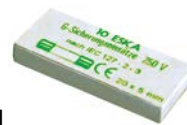

GEV No.	358600	Ref. No.	5061818831
description	fine fuse size ø5x20mm 1A slow-acting rated 250V Qty 10 pcs		
For models:	IHF-60, IHF-60-BF, IHF-60-D, IHF-90, IHF-90-BF, IHF-90-D, IWOK-45II, IWOK-45II-BF, IWOK-45II-D		

fine fuse holders





GEV No.	358512	Ref. No.	5061807908
description	fuse holder		
For models:	BUE-40, BUE-70, EKB-120, EKB-120E, EKB-120EII, EKB-120EII-BF, EKB-150, EKB-150E, EKB-150EII, EKB-150EII-BF, EKBD-125EII, EKBD-125EII-BF, EKBD-160EII, EKBD-160EII-BF, EKH-90, EKK-100, EKK-100-BF, EKK-100E, EKK-150, EKK-150-BF, EKK-40, EKK-40-BF, EKK-40E, EKM-50, EKM-90, ESK-100-80II-BF, ESK150, ESK-150II-BF, ESK-40, ESK-40E, ESK60, ESK-60-40II-BF, ESK-80, ESK-80E, EUB-40, EUB-45-TB, EUB-45-TB-BF, EUB-45-TB-D, EUB-60-ECO, EUB-60-TB, EUB-60-TB-BF, EUB-60-TB-D, GBK120E, GF1-45, GF1-45-BF, GF1-45-D, GF2-60, GF2-60-BF, GF2-60-D, GKB-120...(Other models you can see in the webshop)		



overload switches

			
1			
GEV No.	358514	Ref. No.	R65160300
description	overload switch drop-away current 0.8A		

			
1			
GEV No.	358513	Ref. No.	5060909759 5060927014
description	overload switch drop-away current 1A		
For models:	EKB-120, EKB-120E, EKB-120EII, EKB-120EII-BF, EKB-150, EKB-150E, EKB-150EII, EKB-150EII-BF, EKBD-125EII, EKBD-125EII-BF, EKBD-160EII, EKBD-160EII-BF, EKK-100, EKK-100-BF, EKK-100E, EKK-150, EKK-150-BF, EKK-40, EKK-40-BF, EKK-40E, EKM-90, GBK120E, GKB-120, GKB-120-BF, GKB-120EII, GKB-150, GKB-150-BF, GKB-150EII, GKM-90		

			
1			
GEV No.	358516	Ref. No.	65160320
description	overload switch drop-away current 2A		

electric accessories

terminals

rail-mounted terminals

rail-mounted terminal blocks

			
1			
GEV No.	550421 ¹	Ref. No.	R65220090
description	rail-mounted terminal block 5-pole contacts 3P+N+E cross section 1.0-10mm ²		

¹with fused terminal block

			
1			
GEV No.	550420	Ref. No.	R65220080
description	rail-mounted terminal block 5-pole contacts 3P+N+E cross section 1.5-16mm ²		

			
1			
GEV No.	550422	Ref. No.	R65220130
description	rail-mounted terminal block 9-pole		

gas taps

PEL

20S series

			
1			
GEV No.	101069	Ref. No.	5018904111 5018904112
description	gas tap PEL type 20S gas inlet M16x1.5 (tube ø 10mm) bypass nozzle ø 0.35mm gas outlet M10x1 IT (tube ø 6mm) thermocouple connection M8x1 pilot connection shaft ø 8x6.5mm shaft L 22/15mm shaft flat left conversion kit		
For models:	GHG-70		
spare parts for	101069		
	GEV No.	101205	Ref. No. —
	gas tap front part shaft ø 8x6.5mm shaft L 22/15mm shaft flat upper/lower suitable for PEL20		
	GEV No.	101230	Ref. No. —
	thermocouple nut T1: M8x1 T2: M18x1 aluminium		
	GEV No.	101260	Ref. No. —
	thermocouple fitting thread M8x1 Qty 1 pcs		
	GEV No.	101278	Ref. No. 5050503589
	olive for pipe ø 10mm Qty 1 pcs		
	GEV No.	101300	Ref. No. 5040603582
	union nut thread M16x1.5 tube ø 10mm		
accessories for	101069		
	GEV No.	110081	Ref. No. —
	knob ø 70mm shaft ø 8x6.5mm shaft flat universal		
	GEV No.	110083	Ref. No. —
	knob dial plate gas tap without ignition flame silver		



21S series

			
1			
GEV No.	101095	Ref. No.	5018905405 5018905406
description	gas tap PEL type 21S gas inlet M16x1.5 (tube ø 10mm) bypass nozzle ø 0.35mm gas outlet M16x1.5 (tube ø 10/8mm) thermocouple connection M8x1 pilot connection M10x1 shaft ø 8x6.5mm shaft L 22/15mm shaft flat lower		
For models:	GGG-80, GR-105, GR-35, GRE-105, GRE-70, GREC-105, GRG-105, GRG-70, GRGC-105, HGG-120, HGG-80, HGG-85, HGG-90, SI-105, SIE-105, SIEC-105, SIG-105, SIGC-105, ZGG-80		
spare parts for	101095		
	GEV No.	100408	Ref. No. 5017203034
bypass nozzle type PEL20/21 bore ø 0.35mm thread M5x0.5			
	GEV No.	101060	Ref. No. 5029703203
magnet unit standard L 39mm D1 ø 15.4mm D2 ø 11mm suitable for PEL20-21/JUNKERS/EGA			
	GEV No.	101206	Ref. No. —
gas tap front part shaft ø 8x6.5mm shaft L 22/15mm shaft flat upper/lower suitable for PEL21			
	GEV No.	101230	Ref. No. —
thermocouple nut T1: M8x1 T2: M18x1 aluminium			
accessories for	101095		
	GEV No.	100908	Ref. No. 5040603572
union screw thread M10x1 for pipe ø 4mm Qty 1 pcs			
	GEV No.	100909	Ref. No. —
union screw thread M10x1 for pipe ø 6mm Qty 1 pcs			
	GEV No.	101246	Ref. No. 5050503573
olive for pipe ø 4mm Qty 1 pcs			
	GEV No.	101278	Ref. No. 5050503589
olive for pipe ø 10mm Qty 1 pcs			
	GEV No.	101286	Ref. No. 5050503194
olive ID ø 6mm Qty 1 pcs			
	GEV No.	101300	Ref. No. 5040603582
union nut thread M16x1.5 tube ø 10mm			
	GEV No.	101450	Ref. No. —
olive for pipe ø 8mm L 12.7mm Qty 1 pcs ED ø 10mm			
	GEV No.	101451	Ref. No. —
union nut thread M16x1.5 tube ø 8mm			
	GEV No.	110081	Ref. No. —
knob ø 70mm shaft ø 8x6.5mm shaft flat universal			
	GEV No.	112206	Ref. No. —
knob dial plate silver gas tap PEL21/22/23 t.max.°C ED ø 63mm ID ø 45.5mm			

22S/O series



			
1			
GEV No.	101950	Ref. No.	3018916600 5018914348
description	gas tap PEL type 22S/O gas inlet M20x1.5 (tube ø 12mm) bypass nozzle ø 0.35mm gas outlet M20x1.5 (tube ø 12/10mm) thermocouple connection M9x1 pilot connection M10x1 shaft ø 10x8mm shaft L 25/17mm shaft flat right		
For models:	GH-45, GH-45-BF, GH-45-D, GH-45-G, GH-45-H, GH-45-H-BF, GH-45-H-D, GH-45-H-G, GH-90, GH-90-BF, GH-90G, GH-90-H, GH-90-H-BF, GH-90-HG, GH-90IV-D, GP-45, GP-45-BF, GP-45-D, GP-90, GP-90-BF, GP-90-D, GUK-45II, GUK-45II-BF, GUK-45II-D		
spare parts for	101950		
	GEV No.	101058	Ref. No. 5029711647
magnet unit L 39mm D1 ø 15.4mm D2 ø 13.5mm suitable for PEL22/EGA24197 standard			
	GEV No.	101231	Ref. No. —
thermocouple nut T1: M9x1 T2: M18x1			
	GEV No.	101235	Ref. No. —
gas connection thread M20x1.5 tube ø 12/10mm for PEL gas taps horizontal			
	GEV No.	101460	Ref. No. —
O-ring ø 12.37mm D1 ø 2.62mm suitable for PEL22			
	GEV No.	101461	Ref. No. —
screw kit suitable for PEL22 Qty 4 pcs			
accessories for	101950		
	GEV No.	100908	Ref. No. 5040603572
union screw thread M10x1 for pipe ø 4mm Qty 1 pcs			
	GEV No.	100909	Ref. No. —
union screw thread M10x1 for pipe ø 6mm Qty 1 pcs			
	GEV No.	101246	Ref. No. 5050503573
olive for pipe ø 4mm Qty 1 pcs			
	GEV No.	101248	Ref. No. 5050503001
olive for pipe ø 12mm Qty 1 pcs suitable for PEL			
	GEV No.	101249	Ref. No. —
olive for pipe ø 10mm Qty 1 pcs			
	GEV No.	101250	Ref. No. —
union nut thread M20x1.5 for pipe ø 10mm			
	GEV No.	101251	Ref. No. 5040603188
union nut thread M20x1.5 for pipe ø 12mm			
	GEV No.	101286	Ref. No. 5050503194
olive ID ø 6mm Qty 1 pcs			
	GEV No.	110080	Ref. No. —
knob ø 70mm shaft ø 10x8mm shaft flat universal			

Table continues overleaf



accessories for	101950			
	GEV No.	112206	Ref. No.	—
	knob dial plate silver gas tap PEL21/22/23 t.max.°C ED ø 63mm ID ø 45.5mm			





GEV No.	103210 ¹	Ref. No.	5018913513 AM5018913513	
----------------	---------------------	-----------------	----------------------------	--

description	gas tap PEL type 22S/O gas inlet M20x1.5 (tube ø 12mm) bypass nozzle ø 0mm gas outlet M20x1.5 (tube ø 12/10mm) thermocouple connection M9x1 pilot connection M10x1 shaft ø 10x8mm shaft L 25/17mm shaft flat left			
--------------------	-------------------------------------------------------------------------------------------------------------------------------------------------------------------------------------------------------------------	--	--	--

spare parts for	103210			
------------------------	--------	--	--	--

	GEV No.	100908	Ref. No.	5040603572
	union screw thread M10x1 for pipe ø 4mm Qty 1 pcs			

	GEV No.	101058	Ref. No.	5029711647
	magnet unit L 39mm D1 ø 15.4mm D2 ø 13.5mm suitable for PEL22/ EGA24197 standard			

	GEV No.	101202	Ref. No.	—
	gas tap front part shaft ø 8x10mm shaft L 25/17mm shaft flat right/ left suitable for PEL22			

	GEV No.	101230	Ref. No.	—
	thermocouple nut T1: M8x1 T2: M18x1 aluminium			

	GEV No.	101235	Ref. No.	—
	gas connection thread M20x1.5 tube ø 12/10mm for PEL gas taps horizontal			

	GEV No.	101246	Ref. No.	5050503573
	olive for pipe ø 4mm Qty 1 pcs			

	GEV No.	101248	Ref. No.	5050503001
	olive for pipe ø 12mm Qty 1 pcs suitable for PEL			

	GEV No.	101250	Ref. No.	—
	union nut thread M20x1.5 for pipe ø 10mm			

	GEV No.	101460	Ref. No.	—
	O-ring ø 12.37mm D1 ø 2.62mm suitable for PEL22			

	GEV No.	101461	Ref. No.	—
	screw kit suitable for PEL22 Qty 4 pcs			

	GEV No.	106191	Ref. No.	—
	bypass nozzle type PEL22 bore ø 0mm thread M6x0.5			

accessories for	103210			
------------------------	--------	--	--	--

	GEV No.	100909	Ref. No.	—
	union screw thread M10x1 for pipe ø 6mm Qty 1 pcs			

	GEV No.	101286	Ref. No.	5050503194
	olive ID ø 6mm Qty 1 pcs			

accessories for	101949			
------------------------	--------	--	--	--

	GEV No.	112206	Ref. No.	—
	knob dial plate silver gas tap PEL21/22/23 t.max.°C ED ø 63mm ID ø 45.5mm			

¹incl. union nuts and olives





GEV No.	101949	Ref. No.	5018909180	
----------------	--------	-----------------	------------	--

description	gas tap PEL type 22S/O gas inlet M20x1.5 (tube ø 12mm) bypass nozzle ø 0mm gas outlet M20x1.5 (tube ø 12/10mm) thermocouple connection M9x1 pilot connection M10x1 shaft ø 10x8mm shaft L 25/17mm shaft flat lower			
--------------------	--------------------------------------------------------------------------------------------------------------------------------------------------------------------------------------------------------------------	--	--	--

For models:	CPG-40, GK-70, GKE-70, GKG-70, GLG40CP, GLG70, GLG80, GLG-80-ECOII, GPK-40, GPS-80, GPSE-80, GPSG-80, GSPG80, SI-105, SIE-105, SIEC-105, SIG-105, SIGC-105			
--------------------	------------------------------------------------------------------------------------------------------------------------------------------------------------	--	--	--

spare parts for	101949			
------------------------	--------	--	--	--

	GEV No.	101058	Ref. No.	5029711647
	magnet unit L 39mm D1 ø 15.4mm D2 ø 13.5mm suitable for PEL22/ EGA24197 standard			

	GEV No.	101231	Ref. No.	—
	thermocouple nut T1: M9x1 T2: M18x1			

	GEV No.	101235	Ref. No.	—
	gas connection thread M20x1.5 tube ø 12/10mm for PEL gas taps horizontal			

	GEV No.	101460	Ref. No.	—
	O-ring ø 12.37mm D1 ø 2.62mm suitable for PEL22			

	GEV No.	101461	Ref. No.	—
	screw kit suitable for PEL22 Qty 4 pcs			

accessories for	101949			
------------------------	--------	--	--	--

	GEV No.	100908	Ref. No.	5040603572
	union screw thread M10x1 for pipe ø 4mm Qty 1 pcs			

	GEV No.	100909	Ref. No.	—
	union screw thread M10x1 for pipe ø 6mm Qty 1 pcs			

	GEV No.	101246	Ref. No.	5050503573
	olive for pipe ø 4mm Qty 1 pcs			

	GEV No.	101248	Ref. No.	5050503001
	olive for pipe ø 12mm Qty 1 pcs suitable for PEL			

	GEV No.	101249	Ref. No.	—
	olive for pipe ø 10mm Qty 1 pcs			

	GEV No.	101250	Ref. No.	—
	union nut thread M20x1.5 for pipe ø 10mm			

	GEV No.	101251	Ref. No.	5040603188
	union nut thread M20x1.5 for pipe ø 12mm			

	GEV No.	101286	Ref. No.	5050503194
	olive ID ø 6mm Qty 1 pcs			

	GEV No.	110080	Ref. No.	—
	knob ø 70mm shaft ø 10x8mm shaft flat universal			

	GEV No.	112206	Ref. No.	—
	knob dial plate silver gas tap PEL21/22/23 t.max.°C ED ø 63mm ID ø 45.5mm			



			
GEV No.	109510	Ref. No.	50189091180
description	gas tap PEL type 22S/O gas inlet M20x1.5 (tube ø 12mm) bypass nozzle ø 1.3mm gas outlet M20x1.5 (tube ø 12/10mm) thermocouple connection M8x1 pilot connection M10x1 shaft ø 10x8mm shaft L 25/17mm shaft flat right		
spare parts for	109510		
	GEV No.	100438	Ref. No. —
	bypass nozzle type PEL22 bore ø 1.2mm thread M6x0.5		
	GEV No.	101058	Ref. No. 5029711647
	magnet unit L 39mm D1 ø 15.4mm D2 ø 13.5mm suitable for PEL22/ EGA24197 standard		
	GEV No.	101202	Ref. No. —
	gas tap front part shaft ø 8x10mm shaft L 25/17mm shaft flat right/ left suitable for PEL22		
	GEV No.	101230	Ref. No. —
	thermocouple nut T1: M8x1 T2: M18x1 aluminium		
	GEV No.	101240	Ref. No. —
	gas connection thread M20x1.5 tube ø 12/10mm for PEL gas taps with gasket and screws horizontal		
	GEV No.	101460	Ref. No. —
	O-ring ø 12.37mm D1 ø 2.62mm suitable for PEL22		
	GEV No.	101461	Ref. No. —
	screw kit suitable for PEL22 Qty 4 pcs		
accessories for	109510		
	GEV No.	100908	Ref. No. 5040603572
	union screw thread M10x1 for pipe ø 4mm Qty 1 pcs		
	GEV No.	100909	Ref. No. —
	union screw thread M10x1 for pipe ø 6mm Qty 1 pcs		
	GEV No.	101241	Ref. No. —
	gas connection thread M20x1.5 tube ø 12/10mm for PEL gas taps vertical		
	GEV No.	101246	Ref. No. 5050503573
	olive for pipe ø 4mm Qty 1 pcs		
	GEV No.	101248	Ref. No. 5050503001
	olive for pipe ø 12mm Qty 1 pcs suitable for PEL		
	GEV No.	101249	Ref. No. —
	olive for pipe ø 10mm Qty 1 pcs		
	GEV No.	101250	Ref. No. —
	union nut thread M20x1.5 for pipe ø 10mm		
	GEV No.	101251	Ref. No. 5040603188
	union nut thread M20x1.5 for pipe ø 12mm		
	GEV No.	101286	Ref. No. 5050503194
	olive ID ø 6mm Qty 1 pcs		



			
GEV No.	101951	Ref. No.	5018914348
description	gas tap type 22S/O thermocouple connection M9x1		
For models:	GH-120, GH-40, GH-80, GHE-120, GHE-80, GHG-120, GHG-80, GLG-45II, GLG-45II-D, GLG-90-BF, GLG-90II-D		
spare parts for	101951		
	GEV No.	101058	Ref. No. 5029711647
	magnet unit L 39mm D1 ø 15.4mm D2 ø 13.5mm suitable for PEL22/ EGA24197 standard		
	GEV No.	101231	Ref. No. —
	thermocouple nut T1: M9x1 T2: M18x1		
	GEV No.	101235	Ref. No. —
	gas connection thread M20x1.5 tube ø 12/10mm for PEL gas taps horizontal		
	GEV No.	101460	Ref. No. —
	O-ring ø 12.37mm D1 ø 2.62mm suitable for PEL22		
	GEV No.	101461	Ref. No. —
	screw kit suitable for PEL22 Qty 4 pcs		
accessories for	101951		
	GEV No.	100908	Ref. No. 5040603572
	union screw thread M10x1 for pipe ø 4mm Qty 1 pcs		
	GEV No.	100909	Ref. No. —
	union screw thread M10x1 for pipe ø 6mm Qty 1 pcs		
	GEV No.	101246	Ref. No. 5050503573
	olive for pipe ø 4mm Qty 1 pcs		
	GEV No.	101248	Ref. No. 5050503001
	olive for pipe ø 12mm Qty 1 pcs suitable for PEL		
	GEV No.	101249	Ref. No. —
	olive for pipe ø 10mm Qty 1 pcs		
	GEV No.	101250	Ref. No. —
	union nut thread M20x1.5 for pipe ø 10mm		
	GEV No.	101251	Ref. No. 5040603188
	union nut thread M20x1.5 for pipe ø 12mm		
	GEV No.	101286	Ref. No. 5050503194
	olive ID ø 6mm Qty 1 pcs		
	GEV No.	110080	Ref. No. —
	knob ø 70mm shaft ø 10x8mm shaft flat universal		
	GEV No.	112206	Ref. No. —
	knob dial plate silver gas tap PEL21/22/23 t.max.°C ED ø 63mm ID ø 45.5mm		



22S/V series



GEV No.	101087	Ref. No.	5018903683
description	gas tap PEL type 22S/V gas inlet M20x1.5 (tube ø 12mm) bypass nozzle ø 0.35mm gas outlet M20x1.5 (tube ø 12/10mm) thermocouple connection M9x1 pilot connection M10x1 shaft ø 10x8mm shaft L 25/17mm shaft flat upper		
spare parts for	101087		
	GEV No.	100259	Ref. No. —
	bypass nozzle type PEL22 bore ø 0.35mm thread M6x0.5		
	GEV No.	101058	Ref. No. 5029711647
	magnet unit L 39mm D1 ø 15.4mm D2 ø 13.5mm suitable for PEL22/EGA24197 standard		
	GEV No.	101201	Ref. No. —
	gas tap front part shaft ø 10x8mm shaft L 25/17mm shaft flat upper/lower suitable for PEL22		
	GEV No.	101231	Ref. No. —
	thermocouple nut T1: M9x1 T2: M18x1		
	GEV No.	101241	Ref. No. —
	gas connection thread M20x1.5 tube ø 12/10mm for PEL gas taps vertical		
	GEV No.	101460	Ref. No. —
	O-ring ø 12.37mm D1 ø 2.62mm suitable for PEL22		
	GEV No.	101461	Ref. No. —
	screw kit suitable for PEL22 Qty 4 pcs		
accessories for	101087		
	GEV No.	100908	Ref. No. 5040603572
	union screw thread M10x1 for pipe ø 4mm Qty 1 pcs		
	GEV No.	100909	Ref. No. —
	union screw thread M10x1 for pipe ø 6mm Qty 1 pcs		
	GEV No.	101240	Ref. No. —
	gas connection thread M20x1.5 tube ø 12/10mm for PEL gas taps with gasket and screws horizontal		
	GEV No.	101246	Ref. No. 5050503573
	olive for pipe ø 4mm Qty 1 pcs		
	GEV No.	101248	Ref. No. 5050503001
	olive for pipe ø 12mm Qty 1 pcs suitable for PEL		
	GEV No.	101249	Ref. No. —
	olive for pipe ø 10mm Qty 1 pcs		
	GEV No.	101250	Ref. No. —
	union nut thread M20x1.5 for pipe ø 10mm		
	GEV No.	101251	Ref. No. 5040603188
	union nut thread M20x1.5 for pipe ø 12mm		

accessories for	101087		
	GEV No.	101286	Ref. No. 5050503194
	olive ID ø 6mm Qty 1 pcs		
	GEV No.	110080	Ref. No. —
	knob ø 70mm shaft ø 10x8mm shaft flat universal		
	GEV No.	112206	Ref. No. —
	knob dial plate silver gas tap PEL21/22/23 t.max.°C ED ø 63mm ID ø 45.5mm		

	GEV No.	101952	Ref. No.	5018903683
description	gas tap type PEL22S bypass nozzle ø 1mm thermocouple connection M8x1 pipe outlet vertical			
For models:	GPG-80, GPG-85, GPG-90, KBHG-70-R			
spare parts for	101952			
	GEV No.	100407	Ref. No.	—
	bypass nozzle type PEL22 bore ø 1mm thread M6x0.5			
	GEV No.	100908	Ref. No.	5040603572
	union screw thread M10x1 for pipe ø 4mm Qty 1 pcs			
	GEV No.	101058	Ref. No.	5029711647
	magnet unit L 39mm D1 ø 15.4mm D2 ø 13.5mm suitable for PEL22/EGA24197 standard			
	GEV No.	101200	Ref. No.	—
	gas tap front part shaft ø 10mm shaft L 25mm shaft flat suitable for 22S/O			
	GEV No.	101230	Ref. No.	—
	thermocouple nut T1: M8x1 T2: M18x1 aluminium			
	GEV No.	101241	Ref. No.	—
	gas connection thread M20x1.5 tube ø 12/10mm for PEL gas taps vertical			
	GEV No.	101246	Ref. No.	5050503573
	olive for pipe ø 4mm Qty 1 pcs			
	GEV No.	101460	Ref. No.	—
	O-ring ø 12.37mm D1 ø 2.62mm suitable for PEL22			
	GEV No.	101461	Ref. No.	—
	screw kit suitable for PEL22 Qty 4 pcs			
accessories for	101952			
	GEV No.	101248	Ref. No.	5050503001
	olive for pipe ø 12mm Qty 1 pcs suitable for PEL			
	GEV No.	101249	Ref. No.	—
	olive for pipe ø 10mm Qty 1 pcs			
	GEV No.	101250	Ref. No.	—
	union nut thread M20x1.5 for pipe ø 10mm			





Table continues overleaf

accessories for	101952		
	GEV No.	101251	Ref. No. 5040603188
	union nut thread M20x1.5 for pipe ø 12mm		





23S/O series



GEV No.	101954	Ref. No.	5018907198
description	gas tap PEL type 23S/O gas inlet M28x1.5 (tube ø 20mm) bypass nozzle ø 1.7mm gas outlet M24x1.5 (tube ø 16/12mm) thermocouple connection M10x1 pilot connection M10x1 shaft ø 10x8mm shaft L 25/17mm shaft flat left		
For models:	KKG100		

spare parts for	101954		
	GEV No.	100263	Ref. No. —
	bypass nozzle type PEL23/24 bore ø 1.7mm thread M8x0.5		
	GEV No.	101059	Ref. No. —
	magnet unit T1: M10x1 T2: M22x1 L 46mm ø 18mm suitable for PEL23S M10x1		
	GEV No.	101244	Ref. No. —
	gas connection thread M24x1.5 tube ø 12/16mm horizontal for PEL gas taps		
	GEV No.	101463	Ref. No. —
	screw suitable for PEL23S Qty 4 pcs		
	GEV No.	528455	Ref. No. —
	O-ring Viton thickness 2.62mm ID ø 18.72mm Qty 1 pcs		

accessories for	101954		
	GEV No.	100908	Ref. No. 5040603572
	union screw thread M10x1 for pipe ø 4mm Qty 1 pcs		
	GEV No.	100909	Ref. No. —
	union screw thread M10x1 for pipe ø 6mm Qty 1 pcs		
	GEV No.	101246	Ref. No. 5050503573
	olive for pipe ø 4mm Qty 1 pcs		
	GEV No.	101252	Ref. No. —
	union nut thread M24x1.5 for pipe ø 12mm		
	GEV No.	101253	Ref. No. —
	union nut thread M24x1.5 PEL for pipe ø 16mm		
	GEV No.	101254	Ref. No. —
	union nut thread M28x1.5 tube ø 20mm		
	GEV No.	101255	Ref. No. —
	olive for pipe ø 12mm Qty 1 pcs		
	GEV No.	101256	Ref. No. —
	olive for pipe ø 16mm Qty 1 pcs		

accessories for	101954		
	GEV No.	101257	Ref. No. —
	olive for pipe ø 20mm Qty 1 pcs		
	GEV No.	101286	Ref. No. 5050503194
	olive ID ø 6mm Qty 1 pcs		
	GEV No.	110080	Ref. No. —
	knob ø 70mm shaft ø 10x8mm shaft flat universal		
	GEV No.	112206	Ref. No. —
	knob dial plate silver gas tap PEL21/22/23 t.max.°C ED ø 63mm ID ø 45.5mm		

23S/V series



GEV No.	101953	Ref. No.	5018907199
description	gas tap PEL type 23S/V gas inlet M28x1.5 (tube ø 20mm) bypass nozzle ø 1.15mm gas outlet M24x1.5 (tube ø 16mm) thermocouple connection M10x1 pilot connection M10x1 shaft ø 10x8mm shaft L 25/17mm shaft flat upper		
For models:	K7G-35, K7G-50		

spare parts for	101953		
	GEV No.	100655	Ref. No. —
	bypass nozzle type PEL23/24 bore ø 1.15mm thread M8x0.5		
	GEV No.	101059	Ref. No. —
	magnet unit T1: M10x1 T2: M22x1 L 46mm ø 18mm suitable for PEL23S M10x1		
	GEV No.	101204	Ref. No. —
	gas tap front part shaft ø 10x8mm shaft L 25/17mm shaft flat upper/lower suitable for PEL23S		
	GEV No.	101245	Ref. No. —
	gas connection thread M24x1.5 tube ø 12/16mm vertical for PEL gas taps		
	GEV No.	101463	Ref. No. —
	screw suitable for PEL23S Qty 4 pcs		
	GEV No.	528455	Ref. No. —
	O-ring Viton thickness 2.62mm ID ø 18.72mm Qty 1 pcs		



accessories for	101953		
	GEV No.	100908	Ref. No. 5040603572
	union screw thread M10x1 for pipe ø 4mm Qty 1 pcs		
	GEV No.	100909	Ref. No. —
	union screw thread M10x1 for pipe ø 6mm Qty 1 pcs		
	GEV No.	101246	Ref. No. 5050503573
	olive for pipe ø 4mm Qty 1 pcs		

Table continues overleaf



accessories for		101953		
	GEV No.	101252	Ref. No.	—
union nut thread M24x1.5 for pipe ø 12mm				
	GEV No.	101253	Ref. No.	—
union nut thread M24x1.5 PEL for pipe ø 16mm				
	GEV No.	101254	Ref. No.	—
union nut thread M28x1.5 tube ø 20mm				
	GEV No.	101255	Ref. No.	—
olive for pipe ø 12mm Qty 1 pcs				
	GEV No.	101256	Ref. No.	—
olive for pipe ø 16mm Qty 1 pcs				
	GEV No.	101257	Ref. No.	—
olive for pipe ø 20mm Qty 1 pcs				
	GEV No.	101286	Ref. No.	5050503194
olive ID ø 6mm Qty 1 pcs				
	GEV No.	110080	Ref. No.	—
knob ø 70mm shaft ø 10x8mm shaft flat universal				
	GEV No.	112206	Ref. No.	—
knob dial plate silver gas tap PEL21/22/23 t.max.°C ED ø 63mm ID ø 45.5mm				

accessories for		101614		
	GEV No.	100908	Ref. No.	5040603572
union screw thread M10x1 for pipe ø 4mm Qty 1 pcs				
	GEV No.	100909	Ref. No.	—
union screw thread M10x1 for pipe ø 6mm Qty 1 pcs				
	GEV No.	100926	Ref. No.	—
centring piece thread M17x1				
	GEV No.	100942	Ref. No.	—
union nut thread M15x1 for pipe ø 10mm				
	GEV No.	100943	Ref. No.	—
union nut thread M17x1 tube ø 10mm				
	GEV No.	101246	Ref. No.	5050503573
olive for pipe ø 4mm Qty 1 pcs				
	GEV No.	101278	Ref. No.	5050503589
olive for pipe ø 10mm Qty 1 pcs				
	GEV No.	101286	Ref. No.	5050503194
olive ID ø 6mm Qty 1 pcs				
	GEV No.	110081	Ref. No.	—
knob ø 70mm shaft ø 8x6.5mm shaft flat universal				
	GEV No.	112206	Ref. No.	—
knob dial plate silver gas tap PEL21/22/23 t.max.°C ED ø 63mm ID ø 45.5mm				

alternatives to EGA

GPEL21 series

with pipe outlet

	1			
GEV No.	101614	Ref. No.	5018902393	
description	gas tap alternatives to EGA type GPEL21R with pipe outlet gas inlet M15x1 (tube ø 10mm) bypass nozzle ø 0.35mm gas outlet M17x1 (tube ø 10mm) thermocouple connection M8x1 pilot connection M10x1 shaft ø 8x6.5mm shaft L 22/15mm shaft flat right			
For models:	GZE-70			
spare parts for	101614			
	GEV No.	100408	Ref. No.	5017203034
bypass nozzle type PEL20/21 bore ø 0.35mm thread M5x0.5				
	GEV No.	101060	Ref. No.	5029703203
magnet unit standard L 39mm D1 ø 15.4mm D2 ø 11mm suitable for PEL20-21/JUNKERS/EGA				
	GEV No.	101206	Ref. No.	—
gas tap front part shaft ø 8x6.5mm shaft L 22/15mm shaft flat upper/lower suitable for PEL21				
	GEV No.	101230	Ref. No.	—
thermocouple nut T1: M8x1 T2: M18x1 aluminium				











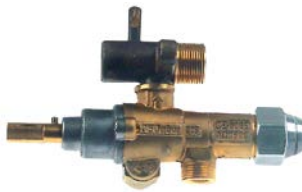

	1			
GEV No.	101640	Ref. No.	5018918655	
description	gas tap alternatives to EGA type GPEL21R with pipe outlet gas inlet M15x1 (tube ø 10mm) bypass nozzle ø 0.35mm gas outlet M17x1 (tube ø 10mm) thermocouple connection M8x1 pilot connection M10x1 shaft ø 8x6.5mm shaft L 31/23mm shaft flat right			
spare parts for	101640			
	GEV No.	100408	Ref. No.	5017203034
bypass nozzle type PEL20/21 bore ø 0.35mm thread M5x0.5				
	GEV No.	100908	Ref. No.	5040603572
union screw thread M10x1 for pipe ø 4mm Qty 1 pcs				
	GEV No.	101060	Ref. No.	5029703203
magnet unit standard L 39mm D1 ø 15.4mm D2 ø 11mm suitable for PEL20-21/JUNKERS/EGA				
	GEV No.	101230	Ref. No.	—
thermocouple nut T1: M8x1 T2: M18x1 aluminium				
	GEV No.	101246	Ref. No.	5050503573
olive for pipe ø 4mm Qty 1 pcs				

Table continues overleaf

spare parts for 101640	
	GEV No. 101807 Ref. No. — gas tap front part shaft ø 8x6.5mm shaft L 22/14.5mm shaft flat right/left
accessories for 101640	
	GEV No. 100909 Ref. No. — union screw thread M10x1 for pipe ø 6mm Qty 1 pcs
	GEV No. 100926 Ref. No. — centring piece thread M17x1
	GEV No. 100942 Ref. No. — union nut thread M15x1 for pipe ø 10mm
	GEV No. 100943 Ref. No. — union nut thread M17x1 tube ø 10mm
	GEV No. 101278 Ref. No. 505053589 olive for pipe ø 10mm Qty 1 pcs
	GEV No. 101286 Ref. No. 505053194 olive ID ø 6mm Qty 1 pcs
	GEV No. 110081 Ref. No. — knob ø 70mm shaft ø 8x6.5mm shaft flat universal
	GEV No. 112206 Ref. No. — knob dial plate silver gas tap PEL21/22/23 t.max.°C ED ø 63mm ID ø 45.5mm

alternatives to JUNKERS

	
1	
GEV No. 101952	Ref. No. 5018903683
description	gas tap type PEL22S bypass nozzle ø 1mm thermocouple connection M8x1 pipe outlet vertical
For models:	GPG-80, GPG-85, GPG-90, KBHG-70-R
spare parts for 101952	
	GEV No. 100407 Ref. No. — bypass nozzle type PEL22 bore ø 1mm thread M6x0.5
	GEV No. 100908 Ref. No. 5040603572 union screw thread M10x1 for pipe ø 4mm Qty 1 pcs
	GEV No. 101058 Ref. No. 5029711647 magnet unit L 39mm D1 ø 15.4mm D2 ø 13.5mm suitable for PEL22/EGA24197 standard
	GEV No. 101200 Ref. No. — gas tap front part shaft ø 10mm shaft L 25mm shaft flat suitable for 22S/O
	GEV No. 101230 Ref. No. — thermocouple nut T1: M8x1 T2: M18x1 aluminium
	GEV No. 101241 Ref. No. — gas connection thread M20x1.5 tube ø 12/10mm for PEL gas taps vertical

spare parts for 101952	
	GEV No. 101246 Ref. No. 5050503573 olive for pipe ø 4mm Qty 1 pcs
	GEV No. 101460 Ref. No. — O-ring ø 12.37mm D1 ø 2.62mm suitable for PEL22
	GEV No. 101461 Ref. No. — screw kit suitable for PEL22 Qty 4 pcs
accessories for 101952	
	GEV No. 101248 Ref. No. 5050503001 olive for pipe ø 12mm Qty 1 pcs suitable for PEL
	GEV No. 101249 Ref. No. — olive for pipe ø 10mm Qty 1 pcs
	GEV No. 101250 Ref. No. — union nut thread M20x1.5 for pipe ø 10mm
	GEV No. 101251 Ref. No. 5040603188 union nut thread M20x1.5 for pipe ø 12mm

EGA

26440 series

gas taps

	
1	
GEV No. 101144	Ref. No. 5018902393
description	gas tap EGA type 26440 series
spare parts for 101144	
	GEV No. 101060 Ref. No. 5029703203 magnet unit standard L 39mm D1 ø 15.4mm D2 ø 11mm suitable for PEL20-21/JUNKERS/EGA
	GEV No. 101230 Ref. No. — thermocouple nut T1: M8x1 T2: M18x1 aluminium
accessories for 101144	
	GEV No. 100926 Ref. No. — centring piece thread M17x1
	GEV No. 100942 Ref. No. — union nut thread M15x1 for pipe ø 10mm
	GEV No. 101278 Ref. No. 5050503589 olive for pipe ø 10mm Qty 1 pcs
	GEV No. 101284 Ref. No. 5050503209 olive for pipe ø 4mm Qty 1 pcs
	GEV No. 101285 Ref. No. — union screw thread M8x1 for pipe ø 4mm Qty 1 pcs JUNKERS

Table continues overleaf



accessories for	101144		
	GEV No.	101394	Ref. No. —
	nut thread M17x1 H 3mm WS 19 brass Qty 1 pcs		

gas thermostats





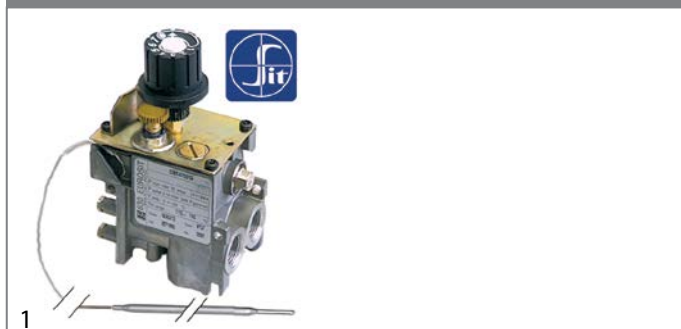





SIT













630 Eurosit series



GEV No.	101188	Ref. No.	5018916798
description	gas thermostat type 630 Eurosit series t.max. 190°C 110-190°C gas inlet 3/8" gas outlet 3/8" thermocouple connection M9x1 pilot connection M10x1 probe ø 4mm probe L 202mm capillary pipe 1050mm SIT		
For models:	GF1-40, GF2-60-ECO, GY1-40, GY2-70		
accessories for	101188		
	GEV No.	100904	Ref. No. —
	locking screw M10x1 for pipe ø 4mm Qty 1 pcs		
	GEV No.	100905	Ref. No. —
	locking screw M10x1 for pipe ø 6mm Qty 1 pcs		
	GEV No.	101273	Ref. No. —
	olive for pipe ø 12mm L 9.5mm brass Qty 1 pcs suitable for universal		
	GEV No.	101276	Ref. No. —
	union screw thread 3/8" tube ø 12mm Qty 1 pcs		
	GEV No.	101333	Ref. No. —
	plug thread 3/8" with O-ring		











GEV No.	101915	Ref. No.	3518912246 5018900942 AM3518912246
description	gas thermostat type 630 Eurosit series t.max. 320°C 80-320°C gas inlet 3/8" gas outlet 3/8" thermocouple connection M9x1 pilot connection M10x1 probe ø 4mm probe L 72mm capillary pipe 1050mm SIT		
For models:	GB-90, GBP-45-C, GBP-45-C-BF, GBP-45-C-D, GBP-45-L, GBP-45-L-BF, GBP-45-L-D, GBP-45-R, GBP-45-R-BF, GBP-45-R-D, GBP-90-1-2LR, GBP-90-1-2LR-BF, GBP-90-1-2LR-D, GBP-90-C, GBP-90-C-BF, GBP-90-C-D, GBP-90-L, GBP-90-L-BF, GBP-90-L-D, GBP-90-R, GBP-90-R-BF, GBP-90-R-D, GBR45R, GKM-50		
accessories for	101915		
	GEV No.	100825	Ref. No. —
	gas tap spindle shaft ø 8x6.5mm shaft L 22/14mm suitable for EUROSIT		
	GEV No.	100904	Ref. No. —
	locking screw M10x1 for pipe ø 4mm Qty 1 pcs		
	GEV No.	100905	Ref. No. —
	locking screw M10x1 for pipe ø 6mm Qty 1 pcs		
	GEV No.	100949	Ref. No. —
	gasket suitable for 630 Eurosit series		
	GEV No.	101273	Ref. No. —
	olive for pipe ø 12mm L 9.5mm brass Qty 1 pcs suitable for universal		
	GEV No.	101276	Ref. No. —
	union screw thread 3/8" tube ø 12mm Qty 1 pcs		
	GEV No.	101333	Ref. No. —
	plug thread 3/8" with O-ring		
	GEV No.	101390	Ref. No. —
	gas tap spindle shaft ø 6x4.6mm shaft L 32/15mm gas tap with ignition flame suitable for ZANUSSI, MARENO for gas thermostat EUROSIT		
	GEV No.	101392	Ref. No. —
	adapter suitable for 630 Eurosit series		
	GEV No.	110357	Ref. No. —
	gas tap spindle shaft ø 8x6.5mm shaft L 36/12mm suitable for 630 Eurosit series		
	GEV No.	110358	Ref. No. —
	adapter shaft ø 10x8mm shaft L 29/18mm suitable for 630 Eurosit series		

			
GEV No.	101916	Ref. No.	3518912730
description	gas thermostat type 630 Eurosit series t.max. 320°C 80-320°C SIT		
For models:	GB-90, GBP-40-C, GBP-40-L, GBP-40-R, GBP-45-C, GBP-45-C-BF, GBP-45-C-D, GBP-45-L, GBP-45-L-BF, GBP-45-L-D, GBP-45-R, GBP-45-R-BF, GBP-45-R-D, GBP-80-1-2LR, GBP-80-C, GBP-80-L, GBP-80-R, GBP-90-1-2LR, GBP-90-1-2LR-BF, GBP-90-1-2LR-D, GBP-90-C, GBP-90-C-BF, GBP-90-C-D, GBP-90-L, GBP-90-L-BF, GBP-90-L-D, GBP-90-R, GBP-90-R-BF, GBP-90-R-D, GBR45R, GHG-120, GHG-80, GKG-70, GPSG-80, GRG-105, GRG-70, GRGC-105, GSPG80, GUG-40, GUG-40-B, GUG-40-C, GUG-70, GUG-70-1-2LR, GUG-70-B, GUG-70-C, SIG-105, SIGC-105		
spare parts for	101916		
	GEV No.	101333	Ref. No. —
	plug thread 3/8" with O-ring		
accessories for	101916		
	GEV No.	100825	Ref. No. —
	gas tap spindle shaft ø 8x6.5mm shaft L 22/14mm suitable for EUROSIT		
	GEV No.	100904	Ref. No. —
	locking screw M10x1 for pipe ø 4mm Qty 1 pcs		
	GEV No.	100905	Ref. No. —
	locking screw M10x1 for pipe ø 6mm Qty 1 pcs		
	GEV No.	100949	Ref. No. —
	gasket suitable for 630 Eurosit series		
	GEV No.	101273	Ref. No. —
	olive for pipe ø 12mm L 9.5mm brass Qty 1 pcs suitable for universal		
	GEV No.	101276	Ref. No. —
	union screw thread 3/8" tube ø 12mm Qty 1 pcs		
	GEV No.	101333	Ref. No. —
	plug thread 3/8" with O-ring		
	GEV No.	101390	Ref. No. —
	gas tap spindle shaft ø 6x4.6mm shaft L 32/15mm gas tap with ignition flame suitable for ZANUSSI, MARENO for gas thermostat EUROSIT		
	GEV No.	101392	Ref. No. —
	adapter suitable for 630 Eurosit series		
	GEV No.	110357	Ref. No. —
	gas tap spindle shaft ø 8x6.5mm shaft L 36/12mm suitable for 630 Eurosit series		
	GEV No.	110358	Ref. No. —
	adapter shaft ø 10x8mm shaft L 29/18mm suitable for 630 Eurosit series		

			
GEV No.	107846	Ref. No.	5018919818 AM5018919818
description	gas thermostat type EUROSIT 80-320°C gas inlet 3/8" gas outlet 3/8" thermocouple connection M9x1 pilot connection M10x1 probe L 72mm capillary pipe 980mm SIT		

710 Minisit series

			
GEV No.	101114 ¹	Ref. No.	5018907490
description	gas thermostat with pressure controller SIT type MINISIT 710 t.max. 190°C 110-190°C gas inlet 1/2" gas outlet 3/8" thermocouple connection M9x1 pilot connection M10x1 probe ø 10.5mm probe L 26mm capillary pipe 1050mm probe type type F3 pressure controller yes pressure regulator 3-18mbar gland nut		
For models:	GY-40		
spare parts for	101114		
	GEV No.	101053	Ref. No. —
	magnet unit T1: M9x1 T2: M24x1 L 45mm ø 17mm suitable for Minisit		
	GEV No.	102104	Ref. No. —
	probe 110-190°C probe ø 11mm probe thread 1/4" probe L 26mm capillary pipe 1050mm t.max. 190°C fryer probe type type F3 suitable for MINISIT 710		
accessories for	101114		
	GEV No.	100809	Ref. No. —
	O-ring EPDM thickness 2mm ID ø 21mm Qty 1 pcs		
	GEV No.	100820	Ref. No. —
	gland duct ET M14x1.5 IT M10x0.75 probe ø max. 6.5mm WS 22		
	GEV No.	100904	Ref. No. —
	locking screw M10x1 for pipe ø 4mm Qty 1 pcs		
	GEV No.	100905	Ref. No. —
	locking screw M10x1 for pipe ø 6mm Qty 1 pcs		
	GEV No.	101054	Ref. No. —
	magnet unit T1: M10x1 T2: M24x1 L 45mm ø 17mm suitable for Minisit		
	GEV No.	101136	Ref. No. —
	piezoelectric igniter suitable for Minisit with cover cap ømm connection F6.3x0.8		

¹probe thread 1/4"
Table continues overleaf



accessories for		101114	
	GEV No.	101137	Ref. No. —
	cover cap without piezoelectric igniter		
	GEV No.	101267	Ref. No. —
	reducer IT 3/8" ET 1/2" L 21mm		
	GEV No.	101268	Ref. No. —
	gas connection thread 3/8" angled with O-ring MINISIT 710		
	GEV No.	101269	Ref. No. —
	gas connection thread 1/2" angled with O-ring MINISIT 710		
	GEV No.	101270	Ref. No. —
	screw connection IT 3/8" ET 3/8" L 28mm		
	GEV No.	101272	Ref. No. —
	screw connection IT 1/2" ET 3/8" L 57mm		
	GEV No.	101273	Ref. No. —
	olive for pipe ø 12mm L 9.5mm brass Qty 1 pcs suitable for universal		
	GEV No.	101274	Ref. No. —
	olive for pipe ø 16mm Qty 1 pcs		
	GEV No.	101275	Ref. No. —
	union screw thread 1/2" for pipe ø 16mm Qty 1 pcs		
	GEV No.	101276	Ref. No. —
	union screw thread 3/8" tube ø 12mm Qty 1 pcs		
	GEV No.	110068	Ref. No. —
	knob suitable for Minisit ø 37mm		
	GEV No.	361182	Ref. No. —
	nut thread 1/4" H 5mm nickel-plated brass WS 17 Qty 1 pcs		
	GEV No.	532520	Ref. No. —
	O-ring silicone thickness 2.62mm ID ø 15.08mm Qty 1 pcs		

spare parts for		101076	
	GEV No.	101058	Ref. No. 5029711647
	magnet unit L 39mm D1 ø 15.4mm D2 ø 13.5mm suitable for PEL22/EGA24197 standard		
	GEV No.	106200	Ref. No. —
	nut thread M9x1 suitable for PEL 24/25S		
accessories for		101076	
	GEV No.	100908	Ref. No. 5040603572
	union screw thread M10x1 for pipe ø 4mm Qty 1 pcs		
	GEV No.	100909	Ref. No. —
	union screw thread M10x1 for pipe ø 6mm Qty 1 pcs		
	GEV No.	101246	Ref. No. 5050503573
	olive for pipe ø 4mm Qty 1 pcs		
	GEV No.	101248	Ref. No. 5050503001
	olive for pipe ø 12mm Qty 1 pcs suitable for PEL		
	GEV No.	101249	Ref. No. —
	olive for pipe ø 10mm Qty 1 pcs		
	GEV No.	101250	Ref. No. —
	union nut thread M20x1.5 for pipe ø 10mm		
	GEV No.	101251	Ref. No. 5040603188
	union nut thread M20x1.5 for pipe ø 12mm		
	GEV No.	101286	Ref. No. 5050503194
	olive ID ø 6mm Qty 1 pcs		
	GEV No.	110079	Ref. No. —
	knob dial plate gas thermostat 1-8 silver		
	GEV No.	110080	Ref. No. —
	knob ø 70mm shaft ø 10x8mm shaft flat universal		

PEL

24ST series

	1		
GEV No.	101076	Ref. No.	5018908975
description	gas thermostat PEL type 24ST 120-320°C gas inlet M20x1.5 (tube ø 12mm) bypass nozzle ø 0.35mm gas outlet M20x1.5 (tube ø 12/10mm) thermocouple connection M9x1 pilot connection M10x1 capillary pipe 1200mm probe ø 6mm probe L 100mm shaft ø 10x8mm shaft L 27/17mm shaft flat upper		
For models:	GRG-70, GUG-40, GUG-70		
spare parts for	101076		
	GEV No.	100455	Ref. No. —
	bypass nozzle type PEL23/24 bore ø 0.35mm thread M8x0.5		

24STS series

	1		
GEV No.	107209	Ref. No.	5018920781
description	gas thermostat PEL type 24STS 100-300°C gas inlet M20x1.5 (tube ø 12/10mm) bypass nozzle ø 1.2mm gas outlet M20x1.5 (tube ø 12/10mm) thermocouple connection M9x1 pilot connection M10x1 capillary pipe 1200mm probe ø 6mm probe L 100mm shaft ø 10x8mm shaft L 27/17mm shaft flat upper		
spare parts for	107209		
	GEV No.	100659	Ref. No. —
	bypass nozzle type PEL23/24 bore ø 1.2mm thread M8x0.5		
	GEV No.	101058	Ref. No. 5029711647
	magnet unit L 39mm D1 ø 15.4mm D2 ø 13.5mm suitable for PEL22/EGA24197 standard		

Table continues overleaf



spare parts for 107209			
	GEV No.	101331	Ref. No. —
adapter suitable for PEL22 for flanged cable 10/12mm			
	GEV No.	101460	Ref. No. —
O-ring ø 12.37mm D1 ø 2.62mm suitable for PEL22			
	GEV No.	101461	Ref. No. —
screw kit suitable for PEL22 Qty 4 pcs			
	GEV No.	106165	Ref. No. —
gasket ø 27mm			
	GEV No.	106200	Ref. No. —
nut thread M9x1 suitable for PEL 24/25S			
accessories for 107209			
	GEV No.	101250	Ref. No. —
union nut thread M20x1.5 for pipe ø 10mm			
	GEV No.	101251	Ref. No. 5040603188
union nut thread M20x1.5 for pipe ø 12mm			



gas valves and ignition boxes

gas control valves

HONEYWELL



1

GEV No.	106012	Ref. No.	R63020170
description	gas valve type VK4115V 220-240V 50/60Hz gas inlet flange 32x32mm gas outlet flange 32x32mm thermocouple connection pilot connection pressure range 15-60mbar max 60mbar operator type HONEYWELL flange 32x32mm		
accessories for 106012			
	GEV No.	102845	Ref. No. —
gas connection angled 1/2" flange 32x32mm hole distance 24x24mm Tandem			
	GEV No.	102846	Ref. No. —
gas connection straight 1/2" flange 32x32mm hole distance 24x24mm suitable for Tandem			

SIT













ELETTROSIT









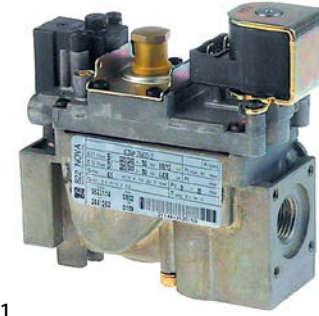

1

GEV No.	101126	Ref. No.	5018902787 5018907227
description	gas valve SIT type ELETTROSIT 230V gas inlet 1/2" gas outlet 1/2" thermocouple connection M9x1 pilot connection M10x1 bottom equiv. no. 0.810.136		
For models:	BPG-50, FG1-40		
spare parts for 101126			
	GEV No.	101312	Ref. No. 5060402366
microswitch			
	GEV No.	101352	Ref. No. —
solenoid coil 230V 50Hz suitable for ELETTROSIT			
accessories for 101126			
	GEV No.	100006	Ref. No. —
piezoelectric igniter suitable for ELETTROSIT body plastic blowing connection ø2.4mm ø 14mm			
	GEV No.	100904	Ref. No. —
locking screw M10x1 for pipe ø 4mm Qty 1 pcs			
	GEV No.	100905	Ref. No. —
locking screw M10x1 for pipe ø 6mm Qty 1 pcs			
	GEV No.	101301	Ref. No. —
gas connection thread 1/2" straight ELETTROSIT screw with O-ring			
	GEV No.	101303	Ref. No. —
gas connection straight thread 3/4" ELETTROSIT			
	GEV No.	101309	Ref. No. —
extension			



NOVASIT			
			
1			
GEV No.	101908	Ref. No.	5018900703
description	gas valve SIT series Novasit 820 230V 50Hz gas inlet 1/2" gas outlet 1/2" thermocouple connection M9x1 pilot connection M10x1 ignition pressurebar pressure regulator connection blind equiv. no. 0.820.018 output pilot burner M10x1 input pressure max. 60bar setting range 3-30bar		
For models:	GKS-100, GKS-150, GKS-60, GKS-80		
spare parts for	101908		
	GEV No.	101065	Ref. No. —
	magnet unit with cable L 44mm D1 ø 30mm D2 ø 20mm suitable for NOVASIT		
	GEV No.	101313	Ref. No. 5061516585
	solenoid coil 230V 50Hz		
accessories for	101908		
	GEV No.	100006	Ref. No. —
	piezoelectric igniter suitable for ELETTROSIT body plastic blowing connection ø2.4mm ø 14mm		
	GEV No.	101305	Ref. No. —
	gas connection straight 1/2" flange 45x45mm ELETTROSIT/V4400/4600/4605 suitable for SIT/HONEYWELL hole distance 36x36mm		
	GEV No.	101306	Ref. No. —
	gas connection angled flange 45x45mm hole distance 36x36mm 1/2" ELETTROSIT/V4400/4600/4605 screw with O-ring suitable for SIT/HONEYWELL		
	GEV No.	101307	Ref. No. —
	gas connection straight flange 45x45mm hole distance 36x36mm 3/4" ELETTROSIT/V4400/4600/4605 screw with O-ring suitable for SIT/HONEYWELL		
	GEV No.	101308	Ref. No. —
	gas connection angled flange 45x45mm hole distance 36x36mm 3/4" ELETTROSIT/V4400/4600/4605 screw with O-ring suitable for SIT/HONEYWELL		
	GEV No.	101312	Ref. No. 5060402366
	microswitch		
	GEV No.	101314	Ref. No. —
	solenoid coil 24V 50Hz		
	GEV No.	101317	Ref. No. —
	plug with cable L 1000mm suitable for NOVASIT		
	GEV No.	101318	Ref. No. —
	cover cap for solenoid coil suitable for NOVASIT		

			
1			
GEV No.	101914	Ref. No.	3518916399 5018909590
description	gas valve SIT series Novasit 822 230V 50Hz gas inlet 1/2" gas outlet 1/2" thermocouple connection pilot connection closed ignition pressurebar pressure range 3-30mbar pressure regulator connection blind equiv. no. 0.822.144		
For models:	GBK120E, GF1-45, GF1-45-BF, GF1-45-D, GF2-60, GF2-60-BF, GF2-60-D, GKB-120, GKB-120-BF, GKB-120EII, GKB-150, GKB-150-BF, GKB-150EII, GSK100, GSK-100-80, GSK-100-80-BF, GSK-150, GSK-150-BF, GSK-40, GSK60, GSK-60-40, GSK-60-40-BF, GSK-80, TPG-80		
spare parts for	101914		
	GEV No.	101313	Ref. No. 5061516585
	solenoid coil 230V 50Hz		
	GEV No.	101542	Ref. No. 5061516584
	solenoid coil 50Hz NOVA 822/826/827 suitable for NOVASIT 230V		
accessories for	101914		
	GEV No.	101305	Ref. No. —
	gas connection straight 1/2" flange 45x45mm ELETTROSIT/V4400/4600/4605 suitable for SIT/HONEYWELL hole distance 36x36mm		
	GEV No.	101306	Ref. No. —
	gas connection angled flange 45x45mm hole distance 36x36mm 1/2" ELETTROSIT/V4400/4600/4605 screw with O-ring suitable for SIT/HONEYWELL		
	GEV No.	101307	Ref. No. —
	gas connection straight flange 45x45mm hole distance 36x36mm 3/4" ELETTROSIT/V4400/4600/4605 screw with O-ring suitable for SIT/HONEYWELL		
	GEV No.	101308	Ref. No. —
	gas connection angled flange 45x45mm hole distance 36x36mm 3/4" ELETTROSIT/V4400/4600/4605 screw with O-ring suitable for SIT/HONEYWELL		
	GEV No.	101503	Ref. No. —
	O-ring EPDM thickness 2mm ID ø 32mm Qty 1 pcs		
	GEV No.	101924	Ref. No. —
	plug with cable L 1090mm suitable for NOVA 822/826/827		

ignition boxes

HONEYWELL



GEV No.	101165	Ref. No.	5060409599
description	ignition box HONEYWELL type S4560A 1008 equiv. no. S4560A 1008 electrodes 1 waiting time 0s safety time 10s 220-240V 10VA 50Hz		
For models:	TPG-80		
spare parts for	101165		
	GEV No.	358696	Ref. No. —
fine fuse size ø5x20mm 4A medium lag rated 250V Qty 10 pcs			



GEV No.	102367	Ref. No.	R63060120
description	ignition box HONEYWELL type S4565A 2092 1 electrodes 3 waiting times safety time 10s 220-240V 4VA 50/60Hz		

miscellaneous



GEV No.	101577	Ref. No.	5060409548 AM5060409548
description	ignition box BERTELLI type AM11 electrodes 2 waiting time 2s safety time 10s 230V 50Hz		
For models:	GBK120E, GF1-45, GF1-45-BF, GF1-45-D, GF2-60, GF2-60-BF, GF2-60-D, GKB-120, GKB-120-BF, GKB-120EII, GKB-150, GKB-150-BF, GKB-150EII, GSK100, GSK-100-80, GSK-100-80-BF, GSK-150, GSK-150-BF, GSK-40, GSK60, GSK-60-40, GSK-60-40-BF, GSK-80, TPG-80		

gas solenoid valves

BRAHMA



GEV No.	101948 ¹	Ref. No.	5018106116
description	solenoid valve 230VAC DN 15mm connection 1/2" L 72mm BRAHMA coil type 18811003 p max 0.5bar reg. no. 63AQ0626		
For models:	KKG100		
spare parts for	101948		
	GEV No.	101968	Ref. No. 5061507400
solenoid valve 230VAC 20VA seat ø 17mm coil type 13902001 BRAHMA			

¹aluminium housing

ignition parts

pilot burners

SIT











100 series















GEV No.	106902	Ref. No.	5024708693
description	pilot burner SIT type 100 series 2 flames nozzle ø 0.2mm gas connection 6mm		
spare parts for	106902		
	GEV No.	100245	Ref. No. 5017207634
pilot burner nozzle LPG code 20 bore ø 0.2mm Qty 1 pcs thread M8x0.75			
	GEV No.	100842	Ref. No. —
pilot burner cap 2 flames Qty 1 pcs			
	GEV No.	100885	Ref. No. —
air mixing sleeve for pilot burner Qty 1 pcs			
	GEV No.	100916	Ref. No. —
compression spring for pilot burner Qty 1 pcs			
	GEV No.	100917	Ref. No. —
gasket for pilot burner Qty 1 pcs aluminium			
	GEV No.	100918	Ref. No. —
screw for pilot burner			

Table continues overleaf



spare parts for 106902	
	GEV No. 107161 Ref. No. — pilot burner cap SIT 2 flames Hmm Lmm Qty 1 pcs
	GEV No. 107701 Ref. No. — pilot burner bottom part SIT 100 series nozzle ø 0.2mm
accessories for 106902	
	GEV No. 100246 Ref. No. 5017208682 pilot burner nozzle natural gas bore ø 0.35mm Qty 1 pcs thread M8x0.75
	GEV No. 100904 Ref. No. — locking screw M10x1 for pipe ø 4mm Qty 1 pcs
	GEV No. 100905 Ref. No. — locking screw M10x1 for pipe ø 6mm Qty 1 pcs
	GEV No. 102110 Ref. No. — pilot tube copper pipe ø 4mm thickness 1mm L 3000mm
	GEV No. 102111 Ref. No. — pilot tube copper pipe ø 6mm thickness 1mm L 3000mm
	GEV No. 107171 Ref. No. — pilot burner nozzle SIT natural/liquid gas bore ø 0.25mm Qty 1 pcs
	GEV No. 107700 Ref. No. — pilot burner bottom part SIT 100 series nozzle ø 0.25mm
	GEV No. 107702 Ref. No. — pilot burner bottom part SIT 100 series nozzle ø 0.35mm

			
1			
GEV No.	106906	Ref. No.	5024703475
description	pilot burner SIT type 100 series 3 flames nozzle ø 0.2mm gas connection 6mm		
For models:	GBP-70-V, GGG-80, GHG-120, GHG-70, GHG-80, GKG-70, GKH-90, GKM-90, GPG-80, GPG-85, GPG-90, GPSG-80, GRG-105, GRG-70, GRGC-105, GSPG80, GZE-70, HGG-120, HGG-80, HGG-85, HGG-90, KBHG-70-R, KHG-90, KMG-50, SIG-105, SIGC-105, ZGG-80		
spare parts for 106906			
	GEV No. 100245 Ref. No. 5017207634 pilot burner nozzle LPG code 20 bore ø 0.2mm Qty 1 pcs thread M8x0.75		
	GEV No. 100855 Ref. No. — pilot burner bracket triple		
	GEV No. 100885 Ref. No. — air mixing sleeve for pilot burner Qty 1 pcs		
	GEV No. 100916 Ref. No. — compression spring for pilot burner Qty 1 pcs		
	GEV No. 100917 Ref. No. — gasket for pilot burner Qty 1 pcs aluminium		

spare parts for 106906	
	GEV No. 100918 Ref. No. — screw for pilot burner
	GEV No. 107162 Ref. No. — pilot burner cap SIT 3 flames Hmm Lmm Qty 1 pcs
	GEV No. 107701 Ref. No. — pilot burner bottom part SIT 100 series nozzle ø 0.2mm
accessories for 106906	
	GEV No. 100245 Ref. No. 5017207634 pilot burner nozzle LPG code 20 bore ø 0.2mm Qty 1 pcs thread M8x0.75
	GEV No. 100246 Ref. No. 5017208682 pilot burner nozzle natural gas bore ø 0.35mm Qty 1 pcs thread M8x0.75
	GEV No. 100904 Ref. No. — locking screw M10x1 for pipe ø 4mm Qty 1 pcs
	GEV No. 100905 Ref. No. — locking screw M10x1 for pipe ø 6mm Qty 1 pcs
	GEV No. 102110 Ref. No. — pilot tube copper pipe ø 4mm thickness 1mm L 3000mm
	GEV No. 102111 Ref. No. — pilot tube copper pipe ø 6mm thickness 1mm L 3000mm
	GEV No. 107171 Ref. No. — pilot burner nozzle SIT natural/liquid gas bore ø 0.25mm Qty 1 pcs
	GEV No. 107700 Ref. No. — pilot burner bottom part SIT 100 series nozzle ø 0.25mm
	GEV No. 107702 Ref. No. — pilot burner bottom part SIT 100 series nozzle ø 0.35mm

accessories

pilot burner nozzles

1			
GEV No.	100245	Ref. No.	5017207634
description	pilot burner nozzle LPG code 20 bore ø 0.2mm Qty 1 pcs thread M8x0.75		

1			
GEV No.	100246	Ref. No.	5017208682
description	pilot burner nozzle natural gas bore ø 0.35mm Qty 1 pcs thread M8x0.75		



ignition electrodes



GEV No.	100706	Ref. No.	5062607632
description	ignition electrode connection M4 Qty 1 pcs		
For models:	GBP-70-V, GGG-80, GHG-120, GHG-70, GHG-80, GKG-70, GKH-90, GKM-90, GPG-80, GPG-85, GPG-90, GPSG-80, GRG-105, GRG-70, GRGC-105, GSPG80, GZE-70, HGG-120, HGG-80, HGG-85, HGG-90, KBHG-70-R, KHG-90, KMG-50, SIG-105, SIGC-105, ZGG-80		





140 - 145 -150 series













GEV No.	106943 ¹	Ref. No.	5024716410
description	pilot burner SIT type 140 series 1 flame nozzle 6mm gas connectionmm		
spare parts for	106943		
	GEV No.	100907	Ref. No. 5040306819 5040616958
	screw connection thread M10x1 Qty 1 pcs type SEF 1 6mm for thermocouple		

¹incl. thermocouple fitting



GEV No.	107132	Ref. No.	5024716410
description	pilot burner SIT type 140 series 2 flames nozzle 6mm gas connectionmm		
For models:	GLG40CP, GLG-45II, GLG-45II-D, GLG70, GLG80, GLG-80-ECOII, GLG-90-BF, GLG-90II-D		
accessories for	107132		
	GEV No.	100204	Ref. No. —
	pilot burner nozzle SIT LPG code 14 bore 0.18/0.20mm Qty 1 pcs suitable for 140 series		
	GEV No.	100205	Ref. No. —
	pilot burner nozzle SIT LPG code 19 bore 0.23/0.26mm Qty 1 pcs suitable for SIT 150 series		
	GEV No.	100206	Ref. No. —
	pilot burner nozzle SIT natural gas code 36 bore 0.60/0.55mm Qty 1 pcs suitable for SIT 150 series		
	GEV No.	100207	Ref. No. —
	pilot burner nozzle SIT natural gas code 27 bore 0.40/0.38mm suitable for SIT 140 series		

accessories for	107132		
	GEV No.	100216	Ref. No. —
	pilot burner nozzle SIT natural gas code 38 bore 0.45mm Qty 1 pcs suitable for SIT 150 series		
	GEV No.	100701	Ref. No. 5062606677
	ignition electrode connection M4 Qty 1 pcs		
	GEV No.	100897	Ref. No. —
	olive for pipe 4mm Qty 1 pcs for pilot burner		
	GEV No.	100898	Ref. No. —
	olive for pipe 6mm Qty 1 pcs for pilot burner		
	GEV No.	100906	Ref. No. 5040317235 5040616959
	screw connection thread M10x1 for ignition electrode brass Qty 1 pcs WS 10		
	GEV No.	100907	Ref. No. 5040306819 5040616958
	screw connection thread M10x1 Qty 1 pcs type SEF 1 6mm for thermocouple		
	GEV No.	100908	Ref. No. 5040603572
	union screw thread M10x1 for pipe 4mm Qty 1 pcs		
	GEV No.	100909	Ref. No. —
	union screw thread M10x1 for pipe 6mm Qty 1 pcs		
	GEV No.	102110	Ref. No. —
	pilot tube copper pipe 4mm thickness 1mm L 3000mm		
	GEV No.	102111	Ref. No. —
	pilot tube copper pipe 6mm thickness 1mm L 3000mm		

POLIDORO

pilot burners





GEV No.	100079	Ref. No.	5024706678 5024706878
description	pilot burner POLIDORO 3 flames code gas connectionmm		
For models:	7GBP-60-C, BPG-50, CPG-40, FG1-40, GB-90, GBP-40-C, GBP-40-L, GBP-40-R, GBP-45-C, GBP-45-C-BF, GBP-45-C-D, GBP-45-L, GBP-45-L-BF, GBP-45-L-D, GBP-45-R, GBP-45-R-BF, GBP-45-R-D, GBP-80-1-2LR, GBP-80-C, GBP-80-L, GBP-80-R, GBP-90-1-2LR, GBP-90-1-2LR-BF, GBP-90-1-2LR-D, GBP-90-C, GBP-90-C-BF, GBP-90-C-D, GBP-90-L, GBP-90-L-BF, GBP-90-L-D, GBP-90-R, GBP-90-R-BF, GBP-90-R-D, GBR45R, GF1-40, GF2-60-ECO, GF-40, GG-80-V, GGG-80, GKM-50, GKS-100, GKS-150, GKS-60, GKS-80, GP-45, GP-45-BF, GP-45-D, GP-90, GP-90-BF, GP-90-D...(Other models you can see in the webshop)		
accessories for	100079		
	GEV No.	100000	Ref. No. —
	pilot burner nozzle POLIDORO LPG code 22 bore 0.22mm Qty 1 pcs		
	GEV No.	100208	Ref. No. 5017207876
	pilot burner nozzle POLIDORO LPG code 20 bore 0.2mm Qty 1 pcs		
	GEV No.	100209	Ref. No. —
	pilot burner nozzle POLIDORO natural gas code 40 bore 0.4mm Qty 1 pcs		

Table continues overleaf



accessories for		100079	
	GEV No.	100701	Ref. No. 5062606677
ignition electrode connection M4 Qty 1 pcs			
	GEV No.	100906	Ref. No. 5040317235 5040616959
screw connection thread M10x1 for ignition electrode brass Qty 1 pcs WS 10			
	GEV No.	100907	Ref. No. 5040306819 5040616958
screw connection thread M10x1 Qty 1 pcs type SEF 1 ømm for thermocouple			
	GEV No.	100908	Ref. No. 5040603572
union screw thread M10x1 for pipe ø 4mm Qty 1 pcs			
	GEV No.	100909	Ref. No. —
union screw thread M10x1 for pipe ø 6mm Qty 1 pcs			
	GEV No.	102110	Ref. No. —
pilot tube copper pipe ø 4mm thickness 1mm L 3000mm			
	GEV No.	102111	Ref. No. —
pilot tube copper pipe ø 6mm thickness 1mm L 3000mm			
	GEV No.	102699	Ref. No. —
pilot burner nozzle POLIDORO natural gas code 25.2 bore ø 2x0.25mm Qty 1 pcs 2 bores			
	GEV No.	102795	Ref. No. —
olive for pipe ø 4mm Qty 1 pcs			
	GEV No.	102797	Ref. No. —
olive for pipe ø 6mm Qty 1 pcs			
	GEV No.	106703	Ref. No. 5017207877
pilot burner nozzle POLIDORO natural gas code 27.2 bore ø 2x0.27mm Qty 1 pcs			
	GEV No.	106704	Ref. No. —
pilot burner nozzle POLIDORO LPG code 16.2 bore ø 2x0.16mm Qty 1 pcs			
	GEV No.	106763	Ref. No. —
pilot burner nozzle POLIDORO natural gas code 27.2A bore ø 2x 0.27mm Qty 1 pcs			
	GEV No.	106859	Ref. No. 501720776
pilot burner nozzle POLIDORO LPG code 24 bore ø 0.24mm Qty 1 pcs			

1			
GEV No.	100972	Ref. No.	3524707258
description	pilot burner POLIDORO 3 flames code gas connectionmm		
For models:	GK-70, GKE-70, GKG-70, GPG-80, GPG-85, GPG-90, GPS-80, GPSE-80, GPSG-80, GSPG80, SI-105, SIE-105, SIEC-105, SIG-105, SIGC-105		
spare parts for	100972		
	GEV No.	100907	Ref. No. 5040306819 5040616958
screw connection thread M10x1 Qty 1 pcs type SEF 1 ømm for thermocouple			

accessories for		100972	
	GEV No.	100208	Ref. No. 5017207876
pilot burner nozzle POLIDORO LPG code 20 bore ø 0.2mm Qty 1 pcs			
	GEV No.	100209	Ref. No. —
pilot burner nozzle POLIDORO natural gas code 40 bore ø 0.4mm Qty 1 pcs			
	GEV No.	100701	Ref. No. 5062606677
ignition electrode connection M4 Qty 1 pcs			
	GEV No.	100906	Ref. No. 5040317235 5040616959
screw connection thread M10x1 for ignition electrode brass Qty 1 pcs WS 10			
	GEV No.	100908	Ref. No. 5040603572
union screw thread M10x1 for pipe ø 4mm Qty 1 pcs			
	GEV No.	100909	Ref. No. —
union screw thread M10x1 for pipe ø 6mm Qty 1 pcs			
	GEV No.	101280	Ref. No. —
olive for pipe ø 4mm Qty 1 pcs			
	GEV No.	101287	Ref. No. —
olive for pipe ø 6mm Qty 1 pcs			

producer-specific pilot burners

AMBACH

GRG_ series (version 2)

1			
GEV No.	100091	Ref. No.	5024708680
description	pilot burner without nozzle		
For models:	GH-120, GH-40, GH-45, GH-45-BF, GH-45-D, GH-45-G, GH-45-H, GH-45-H-BF, GH-45-H-D, GH-45-H-G, GH-80, GH-90, GH-90-BF, GH-90G, GH-90-H, GH-90-H-BF, GH-90-HG, GH-90IV-D, GHE-120, GHE-80, GHG-120, GHG-80, GR-105, GR-35, GRE-105, GRE-70, GREC-105, GRG-105, GRG-70, GRGC-105, SI-105, SIE-105, SIEC-105, SIG-105, SIGC-105		
accessories for	100091		
	GEV No.	100202	Ref. No. —
pilot burner nozzle natural gas code 41 Qty 1 pcs nozzle ø 0.41mm			
	GEV No.	100203	Ref. No. —
pilot burner nozzle LPG code 25 Qty 1 pcs nozzle ø 0.25mm			
	GEV No.	100908	Ref. No. 5040603572
union screw thread M10x1 for pipe ø 4mm Qty 1 pcs			
	GEV No.	100909	Ref. No. —
union screw thread M10x1 for pipe ø 6mm Qty 1 pcs			

Table continues overleaf



accessories for		100091		
	GEV No.	101282	Ref. No.	—
	olive for pipe ø 4mm L 7.4mm Qty 1 pcs			
	GEV No.	101287	Ref. No.	—
	olive for pipe ø 6mm Qty 1 pcs			
	GEV No.	107650	Ref. No.	5017208677
	pilot burner nozzle SIT LPG code 30 Qty 1 pcs			

electrodes

GEV No.	100701	Ref. No.	5062606677	
description	ignition electrode connection M4 Qty 1 pcs			
For models:	7GBP-60-C, BPG-50, CPG-40, FG1-40, GB-90, GBP-40-C, GBP-40-L, GBP-40-R, GBP-45-C, GBP-45-C-BF, GBP-45-C-D, GBP-45-L, GBP-45-L-BF, GBP-45-L-D, GBP-45-R, GBP-45-R-BF, GBP-45-R-D, GBP-80-1-2LR, GBP-80-C, GBP-80-L, GBP-80-R, GBP-90-1-2LR, GBP-90-1-2LR-BF, GBP-90-1-2LR-D, GBP-90-C, GBP-90-C-BF, GBP-90-C-D, GBP-90-L, GBP-90-L-BF, GBP-90-L-D, GBP-90-R, GBP-90-R-BF, GBP-90-R-D, GBR45R, GF1-40, GF2-60-ECO, GF-40, GG-80-V, GGG-80, GK-70, GKE-70, GKG-70, GKM-50, GKS-100, GKS-150, GKS-60, GKS-80, GLG40CP, GLG-45II, GLG-45II-D...(Other models you can see in the webshop)			
accessories for	100701			
	GEV No.	100906	Ref. No.	5040317235 5040616959
	screw connection thread M10x1 for ignition electrode brass Qty 1 pcs WS 10			

GEV No.	100706	Ref. No.	5062607632	
description	ignition electrode connection M4 Qty 1 pcs			
For models:	GBP-70-V, GGG-80, GHG-120, GHG-70, GHG-80, GKG-70, GKH-90, GKM-90, GPG-80, GPG-85, GPG-90, GPSG-80, GRG-105, GRG-70, GRGC-105, GSPG80, GZE-70, HGG-120, HGG-80, HGG-85, HGG-90, KBHG-70-R, KHG-90, KMG-50, SIG-105, SIGC-105, ZGG-80			

GEV No.	100715	Ref. No.	5062602389	
description	ignition electrode D1 ø 8mm D2 ø 7mm BL1 15mm BL2 35mm connection F 2.8x0.8mm			
For models:	GHG-70			

GEV No.	101789	Ref. No.	3562614388 AM3562614388	
description	ignition electrode flange length 23mm flange width 15mm D1 ø 7mm L1 10mm L2 50mm BL1 21mm BL2 25mm fixing dimensions ø5x4mm with flange connection ø 4mm			
For models:	GF1-45, GF1-45-BF, GF1-45-D, GF2-60, GF2-60-BF, GF2-60-D			

GEV No.	101788	Ref. No.	3562614387	
description	ignition electrode flange length 23mm flange width 15mm D1 ø 7mm L1 12mm L2 38mm L3 8mm BL1 21mm BL2 25mm fixing dimensions ø5x4mm with flange connection ø 6mm			
For models:	GF1-45, GF1-45-BF, GF1-45-D, GF2-60, GF2-60-BF, GF2-60-D			

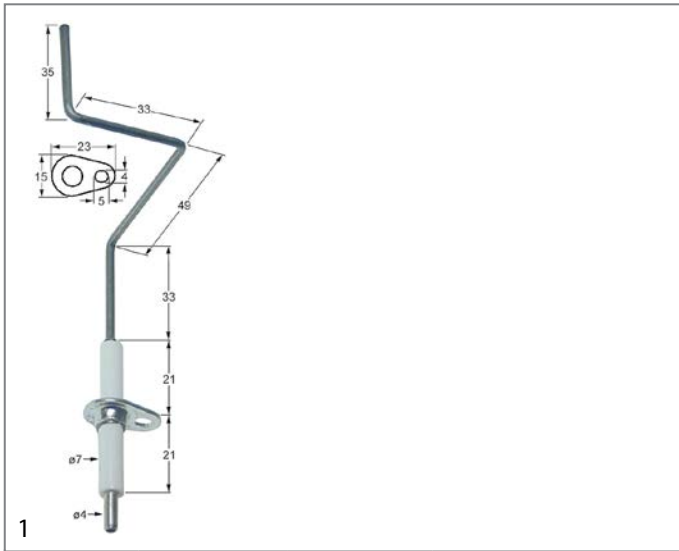

GEV No.	102168	Ref. No.	3562614698 AM3562614698
description	ignition electrode flange length 23mm flange width 15mm D1 ø 7mm L1 33mm L2 49mm L3 33mm L4 35mm BL1 21mm BL2 25mm fixing dimensions ø5x4mm with flange connection ø 4mm		
For models:	GBK120E, GKB-120, GKB-120-BF, GKB-120EII, GKB-150, GKB-150-BF, GKB-150EII		



GEV No.	102165	Ref. No.	3562615503
description	ignition electrode flange length 23mm flange width 15mm D1 ø 7mm L1 42mm L2 36mm L3 12mm BL1 21mm BL2 25mm fixing dimensions ø5x4mm with flange connection ø 6mm		
For models:	GSK100, GSK-100-80, GSK-100-80-BF, GSK-150, GSK-150-BF, GSK-40, GSK60, GSK-60-40, GSK-60-40-BF, GSK-80		

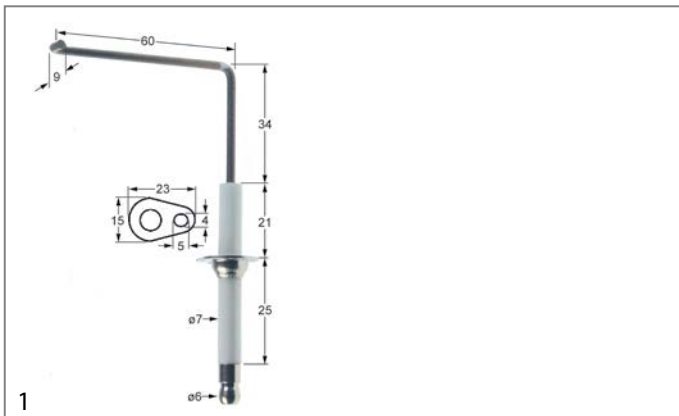

GEV No.	101790	Ref. No.	3562609588
description	ignition electrode flange length 23mm flange width 15mm D1 ø 7mm L1 34mm L2 60mm L3 9mm BL1 21mm BL2 25mm fixing dimensions ø5x4mm with flange connection ø 6mm		

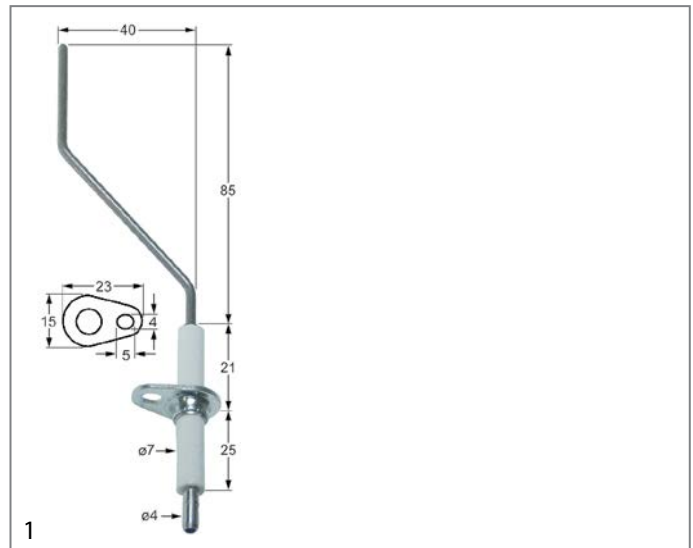

GEV No.	102166	Ref. No.	3562615504
description	ignition electrode flange length 23mm flange width 15mm D1 ø 7mm L1 85mm L2 40mm BL1 21mm BL2 25mm fixing dimensions ø5x4mm with flange connection ø 4mm		
For models:	GSK100, GSK-100-80, GSK-100-80-BF, GSK-150, GSK-150-BF, GSK-40, GSK60, GSK-60-40, GSK-60-40-BF, GSK-80		

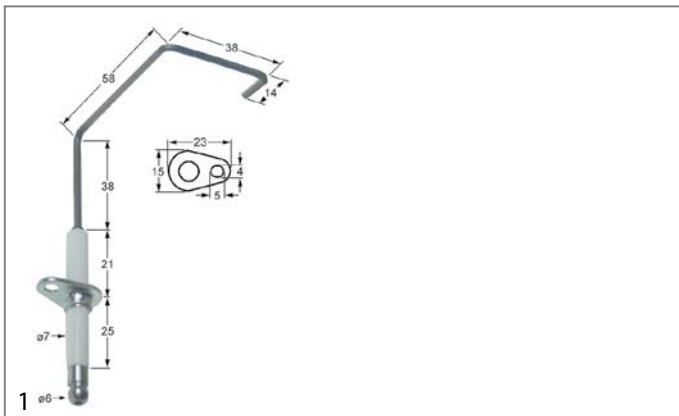

GEV No.	102167	Ref. No.	3562614697
description	ignition electrode flange length 23mm flange width 15mm D1 ø 7mm L1 38mm L2 58mm L3 38mm L4 14mm BL1 21mm BL2 25mm fixing dimensions ø5x4mm with flange connection ø 6mm		
For models:	GBK120E, GKB-120, GKB-120-BF, GKB-120EII, GKB-150, GKB-150-BF, GKB-150EII		

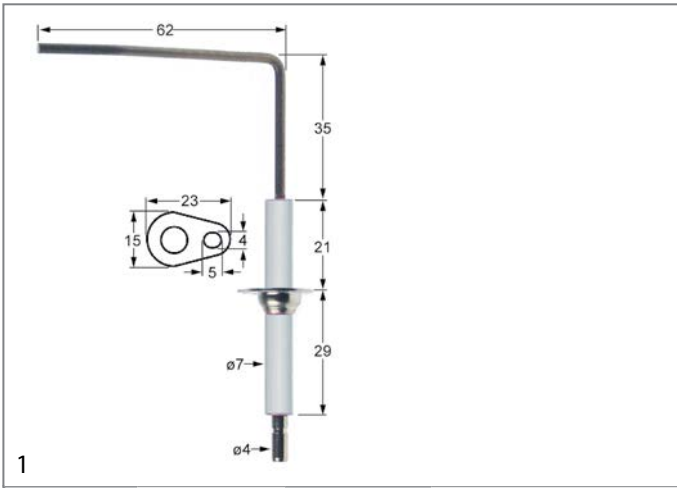

GEV No.	101791	Ref. No.	3562609589
description	monitoring electrode connection \varnothing 4mm flange length 23mm D1 \varnothing 7mm flange width 15mm L1 35mm L2 62mm BL1 21mm BL2 29mm with flange		
For models:	TPG-80		

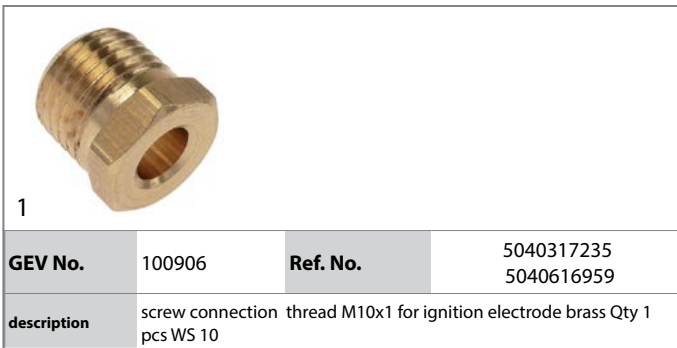

GEV No.	100906	Ref. No.	5040317235 5040616959
description	screw connection thread M10x1 for ignition electrode brass Qty 1 pcs WS 10		

ignition cables

pre-assembled cables

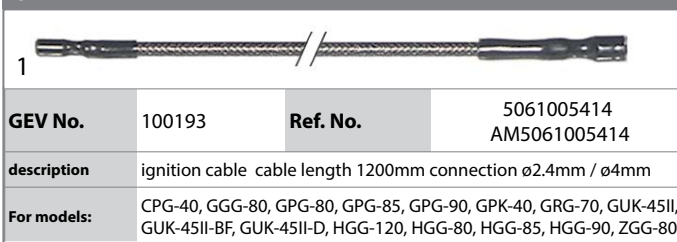

GEV No.	100193	Ref. No.	5061005414 AM5061005414
description	ignition cable cable length 1200mm connection \varnothing 2.4mm / \varnothing 4mm		
For models:	CPG-40, GGG-80, GPG-80, GPG-85, GPG-90, GPK-40, GRG-70, GUK-45II, GUK-45II-BF, GUK-45II-D, HGG-120, HGG-80, HGG-85, HGG-90, ZGG-80		



GEV No.	102270	Ref. No.	5061009890
description	ignition cable cable length 1500mm connection \varnothing 4mm / F6.3mm		
For models:	GF1-45, GF1-45-BF, GF1-45-D, GF2-60, GF2-60-BF, GF2-60-D		

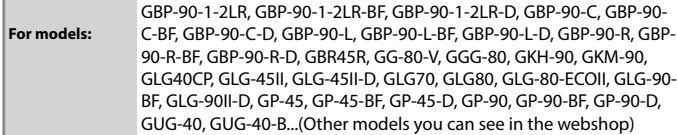

GEV No.	100140	Ref. No.	5061003549
description	ignition cable cable length 400mm connection \varnothing 2.4mm / \varnothing 4mm		
For models:	GBP-40-C, GBP-40-L, GBP-40-R, GBP-45-C, GBP-45-C-BF, GBP-45-C-D, GBP-45-L, GBP-45-L-BF, GBP-45-L-D, GBP-45-R, GBP-45-R-BF, GBP-45-R-D, GBP-70-V, GBP-80-1-2LR, GBP-80-C, GBP-80-L, GBP-80-R, GBP-90-1-2LR, GBP-90-1-2LR-BF, GBP-90-1-2LR-D, GBP-90-C, GBP-90-C-BF, GBP-90-C-D, GBP-90-L, GBP-90-L-BF, GBP-90-L-D, GBP-90-R, GBP-90-R-BF, GBP-90-R-D, GBR45R, GG-80-V, GGG-80, GKH-90, GKM-90, GLG40CP, GLG-45II, GLG-45II-D, GLG70, GLG80, GLG-80-ECOII, GLG-90-BF, GLG-90II-D, GP-45, GP-45-BF, GP-45-D, GP-90, GP-90-BF, GP-90-D, GUG-40, GUG-40-B...(Other models you can see in the webshop)		

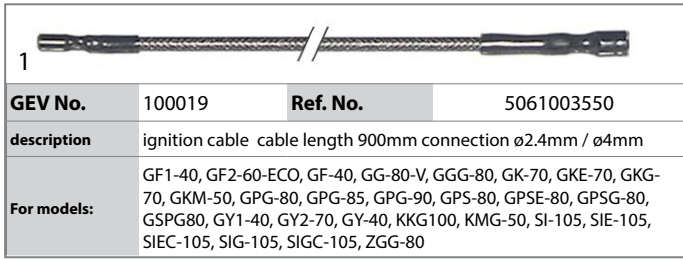

GEV No.	100019	Ref. No.	5061003550
description	ignition cable cable length 900mm connection \varnothing 2.4mm / \varnothing 4mm		
For models:	GF1-40, GF2-60-ECO, GF-40, GG-80-V, GGG-80, GK-70, GKE-70, GKG-70, GKM-50, GPG-80, GPG-85, GPG-90, GPS-80, GPSE-80, GPSG-80, GSPG80, GY1-40, GY2-70, GY-40, KKG100, KMG-50, SI-105, SIE-105, SIEC-105, SIG-105, SIGC-105, ZGG-80		

piezoelectric igniters

mounting diameter 18mm

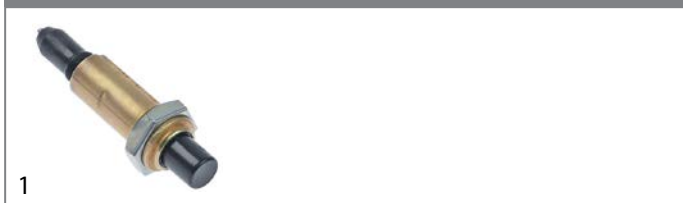

GEV No.	100003	Ref. No.	5060403707
description	piezoelectric igniter body metal blowing mounting \varnothing 18mm connection F2.8x0.8		
For models:	GBP-70-V, GF-40, GG-80-V, GGG-80, GPG-80, GPG-85, GPG-90, GZE-70, HGG-120, HGG-80, HGG-85, HGG-90, K7G-35, KBHG-70-R, KHG-90, KKG100, KMG-50, ZGG-80		

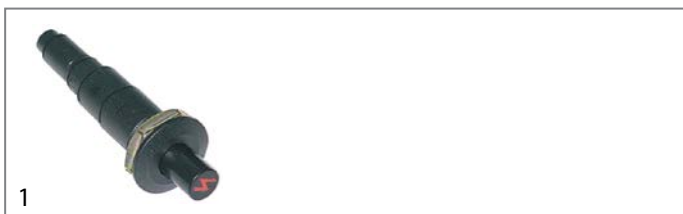

GEV No.	100009	Ref. No.	5060408640
description	piezoelectric igniter body plastic blowing mounting \varnothing 18mm connection \varnothing 2.4mm front measurements 26mm M18x1.5		
For models:	7GBP-60-C, CPG-40, GB-90, GBP-40-C, GBP-40-L, GBP-40-R, GBP-45-C, GBP-45-C-BF, GBP-45-C-D, GBP-45-L, GBP-45-L-BF, GBP-45-L-D, GBP-45-R, GBP-45-R-BF, GBP-45-R-D, GBP-80-1-2LR, GBP-80-C, GBP-80-L, GBP-80-R, GBP-90-1-2LR, GBP-90-1-2LR-BF, GBP-90-1-2LR-D, GBP-90-C, GBP-90-C-BF, GBP-90-C-D, GBP-90-L, GBP-90-L-BF, GBP-90-L-D, GBP-90-R, GBP-90-R-BF, GBP-90-R-D, GBR45R, GF1-40, GF2-60-ECO, GHG-120, GHG-80, GK-70, GKE-70, GKG-70, GKH-90, GKM-50, GKM-90, GKS-100, GKS-150, GKS-60, GKS-80, GLG40CP, GLG-45II, GLG-45II-D, GLG70...(Other models you can see in the webshop)		

accessories for	100009	GEV No.	101339	Ref. No.	—
					cover cap for piezoelectric igniter
		GEV No.	106869	Ref. No.	—
					cover cap for piezoelectric igniter ID \varnothing 22mm ED \varnothing 35mm H 25mm
		GEV No.	107931	Ref. No.	—
					cover cap for piezoelectric igniter ID \varnothing 21mm ED \varnothing 36mm



accessories			
1			
GEV No.	106993	Ref. No.	5060914259
description	igniter L 29mm head ø 6mm connection 2.4mm		
For models:	GB-90, GBP-45-C, GBP-45-C-BF, GBP-45-C-D, GBP-45-L, GBP-45-L-BF, GBP-45-L-D, GBP-45-R, GBP-45-R-BF, GBP-45-R-D, GBP-90-1-2LR, GBP-90-1-2LR-BF, GBP-90-1-2LR-D, GBP-90-C, GBP-90-C-BF, GBP-90-C-D, GBP-90-L, GBP-90-L-BF, GBP-90-L-D, GBP-90-R, GBP-90-R-BF, GBP-90-R-D, GBR45R, GLG-45II, GLG-45II-D, GLG-90-BF, GLG-90II-D, GP-45, GP-45-BF, GP-45-D, GP-90, GP-90-BF, GP-90-D, GUK-45II, GUK-45II-BF, GUK-45II-D		
accessories for	106993		
		GEV No.	106992 Ref. No. 5006814260
	insulating cover for piezoelectric igniter mounting ø 18mm PTFE		

accessories for 101943			
		GEV No.	106992 Ref. No. 5006814260
	insulating cover for piezoelectric igniter mounting ø 18mm PTFE		
		GEV No.	106993 Ref. No. 5060914259
	igniter L 29mm head ø 6mm connection 2.4mm		

1			
GEV No.	106992	Ref. No.	5006814260
description	insulating cover for piezoelectric igniter mounting ø 18mm PTFE		
For models:	GB-90, GBP-45-C, GBP-45-C-BF, GBP-45-C-D, GBP-45-L, GBP-45-L-BF, GBP-45-L-D, GBP-45-R, GBP-45-R-BF, GBP-45-R-D, GBP-90-1-2LR, GBP-90-1-2LR-BF, GBP-90-1-2LR-D, GBP-90-C, GBP-90-C-BF, GBP-90-C-D, GBP-90-L, GBP-90-L-BF, GBP-90-L-D, GBP-90-R, GBP-90-R-BF, GBP-90-R-D, GBR45R, GLG-45II, GLG-45II-D, GLG-90-BF, GLG-90II-D, GP-45, GP-45-BF, GP-45-D, GP-90, GP-90-BF, GP-90-D, GUK-45II, GUK-45II-BF, GUK-45II-D		
accessories for	106992		
		GEV No.	106993 Ref. No. 5060914259
	igniter L 29mm head ø 6mm connection 2.4mm		

ignition units			
1			
GEV No.	102485	Ref. No.	5060401734 5060402386
description	ignition unit outputs 2 220-240VAC 0.6VA 50-60Hz		
For models:	BPG-50, FG1-40		

1			
GEV No.	101014	Ref. No.	5060402388
description	ignition unit outputs 6		
For models:	GHG-70		

1			
GEV No.	101944	Ref. No.	5006314300
description	safety bar		
For models:	GBP-45-C, GBP-45-C-BF, GBP-45-C-D, GBP-45-L, GBP-45-L-BF, GBP-45-L-D, GBP-45-R, GBP-45-R-BF, GBP-45-R-D, GBP-90-1-2LR, GBP-90-1-2LR-BF, GBP-90-1-2LR-D, GBP-90-C, GBP-90-C-BF, GBP-90-C-D, GBP-90-L, GBP-90-L-BF, GBP-90-L-D, GBP-90-R, GBP-90-R-BF, GBP-90-R-D, GBR45R, GLG-45II, GLG-45II-D, GLG-90-BF, GLG-90II-D, GP-45, GP-45-BF, GP-45-D, GP-90, GP-90-BF, GP-90-D, GUK-45II, GUK-45II-BF, GUK-45II-D		

thermocouples

plug-in thermocouples

plug-in thermocouples standard

with barrel socket ø5mm - type Junkers with aluminised tip

1			
GEV No.	101943	Ref. No.	5006314278
description	sleeve for piezoelectric igniter		
For models:	GB-90, GBP-45-C, GBP-45-C-BF, GBP-45-C-D, GBP-45-L, GBP-45-L-BF, GBP-45-L-D, GBP-45-R, GBP-45-R-BF, GBP-45-R-D, GBP-90-1-2LR, GBP-90-1-2LR-BF, GBP-90-1-2LR-D, GBP-90-C, GBP-90-C-BF, GBP-90-C-D, GBP-90-L, GBP-90-L-BF, GBP-90-L-D, GBP-90-R, GBP-90-R-BF, GBP-90-R-D, GBR45R, GLG-45II, GLG-45II-D, GLG-90-BF, GLG-90II-D, GP-45, GP-45-BF, GP-45-D, GP-90, GP-90-BF, GP-90-D, GUK-45II, GUK-45II-BF, GUK-45II-D		
accessories for	101943		
		GEV No.	100009 Ref. No. 5060408640
	piezoelectric igniter body plastic blowing mounting ø 18mm connection ø2.4mm front measurements 26mm M18x1.5		
		GEV No.	101944 Ref. No. 5006314300
	safety bar		

1			
GEV No.	102020	Ref. No.	5024102013
description	thermocouple M8x1 L 320mm plug connection ø5.0mm		

1			
GEV No.	102202	Ref. No.	5024102013
description	thermocouple M8x1 L 320mm plug connection ø5.0mm		
For models:	GHG-70, GR-105, GR-35, GRE-105, GRE-70, GREC-105, GRG-105, GRG-70, GRGC-105, HGG-120, HGG-80, HGG-85, HGG-90, SI-105, SIE-105, SIEC-105, SIG-105, SIGC-105		
accessories for	102202		
		GEV No.	101260 Ref. No. —
	thermocouple fitting thread M8x1 Qty 1 pcs		

GEV No.	102251	Ref. No.	5024114591
description	thermocouple M9x1 L 750mm plug connection $\varnothing 5.0\text{mm}$		
For models:	7GH-80, GH-120, GH-40, GH-45, GH-45-BF, GH-45-D, GH-45-G, GH-45-H, GH-45-H-BF, GH-45-H-D, GH-45-H-G, GH-80, GH-90, GH-90-BF, GH-90G, GH-90-H, GH-90-H-BF, GH-90-HG, GH-90IV-D, GHE-120, GHE-80, GHG-120, GHG-80		

with barrel socket $\varnothing 6(6.5)\text{mm}$
thermocouples SIT

GEV No.	107604	Ref. No.	5024102066
description	thermocouple SIT M8x1 L 1200mm plug connection $\varnothing 6.0(6.5)\text{mm}$		
For models:	GGG-80, GHG-70, GPG-80, GPG-85, GPG-90, HGG-120, HGG-80, HGG-85, HGG-90, ZGG-80		

GEV No.	107600	Ref. No.	5024108059
description	thermocouple SIT M8x1 L 320mm plug connection $\varnothing 6.0(6.5)\text{mm}$		
For models:	GBP-70-V		

GEV No.	107601	Ref. No.	5024102394
description	thermocouple SIT M8x1 L 600mm plug connection $\varnothing 6.0(6.5)\text{mm}$		
For models:	GG-80-V, GGG-80, GLG80, GPG-80, GPG-85, GPG-90, GZE-70, KBHG-70-R, KHG-90, ZGG-80		

GEV No.	107613	Ref. No.	5024108855
description	thermocouple SIT M9x1 L 1200mm plug connection $\varnothing 6.0(6.5)\text{mm}$		
For models:	GHG-120, GHG-80, GKG-70, GPSG-80, GRG-105, GRG-70, GRGC-105, GSPG80, SIG-105, SIGC-105		

GEV No.	107608	Ref. No.	5024100057 5024107382 5024107489 5024110057
description	thermocouple SIT M9x1 L 500mm plug connection $\varnothing 6.0(6.5)\text{mm}$		
For models:	CPG-40, GBP-40-C, GBP-40-L, GBP-40-R, GBP-45-C, GBP-45-C-BF, GBP-45-C-D, GBP-45-L, GBP-45-L-BF, GBP-45-L-D, GBP-45-R, GBP-45-R-BF, GBP-45-R-D, GBP-80-1-2LR, GBP-80-C, GBP-80-L, GBP-80-R, GBP-90-1-2LR, GBP-90-1-2LR-BF, GBP-90-1-2LR-D, GBP-90-C, GBP-90-C-BF, GBP-90-C-D, GBP-90-L, GBP-90-L-BF, GBP-90-L-D, GBP-90-R, GBP-90-R-BF, GBP-90-R-D, GBR45R, GF1-40, GF2-60-ECO, GK-70, GKE-70, GKG-70, GKH-90, GKM-50, GKM-90, GLG40CP, GLG-45II, GLG-45II-D, GLG70, GLG80, GLG-80-ECOII, GLG-90-BF, GLG-90II-D, GP-45, GP-45-BF, GP-45-D, GP-90...(Other models you can see in the webshop)		

GEV No.	107611	Ref. No.	5024114564
description	thermocouple SIT M9x1 L 850mm plug connection $\varnothing 6.0(6.5)\text{mm}$		
For models:	GB-90		

threaded thermocouples (miscellaneous)

GEV No.	107461	Ref. No.	5024102012
description	thermocouple M8x1 L 600mm plug connection $\varnothing 5.0\text{mm}$		
For models:	7GBP-60-C, GHG-70, GR-105, GR-35, GRE-105, GRE-70, GREC-105, GRG-105, GRG-70, GRGC-105, HGG-120, HGG-80, HGG-85, HGG-90, SI-105, SIE-105, SIEC-105, SIG-105, SIGC-105		



plug-in thermocouples with interruption

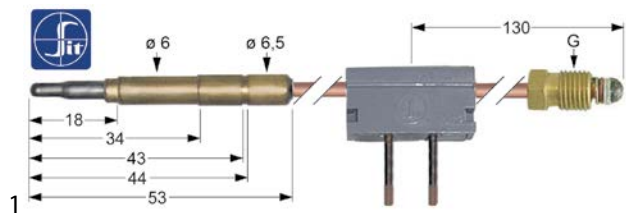

GEV No.	107164	Ref. No.	5024108078
description	thermocouple SIT with interrupter M9x1 L 1000mm plug connection $\varnothing 6.0(6.5)$ mm soldering connection		
For models:	BPG-50, GKS-100, GKS-150, GKS-60, GKS-80		

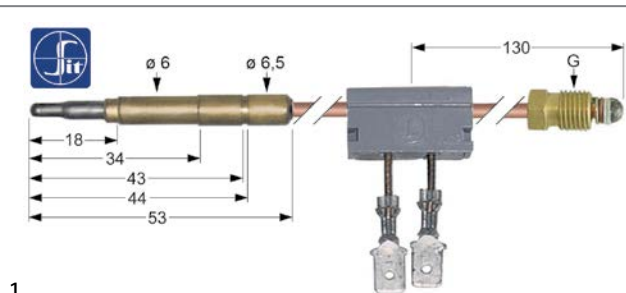

GEV No.	107177	Ref. No.	5024108086
description	thermocouple SIT with interrupter M9x1 L 600mm plug connection $\varnothing 6.0$ mm F 6.3mm		
For models:	BPG-50, FG1-40, GF-40, GY-40		

extensions



GEV No.	102013	Ref. No.	5024108084
description	thermocouple extension thread M9x1 L 500mm		
For models:	BPG-50, FG1-40, GF-40, GY-40		
accessories for	102013		



GEV No.	101261	Ref. No.	—
description	thermocouple fitting thread M9x1 Qty 1 pcs		

accessories

interrupters



GEV No.	101265	Ref. No.	5024105606 5024105819
description	interrupter thread M9x1		
For models:	K7G-35, K7G-50, KKG100		

ignition bridges



GEV No.	104124	Ref. No.	5020307627
description	ignition bridge L 230mm		
For models:	GBP-70-V, GBP-90-1-2LR, GBP-90-1-2LR-BF, GBP-90-1-2LR-D, GBP-90-C, GBP-90-C-BF, GBP-90-C-D, GBP-90-L, GBP-90-L-BF, GBP-90-L-D, GBP-90-R, GBP-90-R-BF, GBP-90-R-D, GGG-80, GHG-70, GP-90, GP-90-BF, GP-90-D, GPG-80, GPG-85, GPG-90, HGG-120, HGG-80, HGG-85, HGG-90, ZGG-80		



GEV No.	104404	Ref. No.	5020309395
description	ignition bridge L 260mm		
For models:	TPG-80		





GEV No.	104164	Ref. No.	5020305523
description	ignition bridge L 310mm for tilting bratt pan		
For models:	KBHG-70-R		







GEV No.	104408	Ref. No.	3520314587
description	ignition bridge L 532mm		
For models:	GBK120E, GKB-120, GKB-120-BF, GKB-120EII		





			
1			
GEV No.	104406	Ref. No.	5020311641
description	ignition bridge L 572mm		
For models:	GKM-50		

			
1			
GEV No.	104405	Ref. No.	5020306250
description	ignition bridge L 720mm		
For models:	GKH-90, GKM-90, KHG-90		

			
1			
GEV No.	104409	Ref. No.	3520314588
description	ignition bridge L 884mm		
For models:	GKB-150, GKB-150-BF, GKB-150EII		

			
1			
GEV No.	103040	Ref. No.	5018705710
description	burner cap C ø 90mm		
For models:	HGG-120, HGG-80, HGG-85, HGG-90		
accessories for	103040		
	GEV No.	104062	Ref. No. 2016905411
	GEV No.	104064	Ref. No. 2000605350
	GEV No.	104066	Ref. No. 3028604319

			
1			
GEV No.	104381	Ref. No.	5018705711
description	burner cap D ø 125mm		
For models:	HGG-120, HGG-80, HGG-85, HGG-90		
accessories for	104381		
	GEV No.	104065	Ref. No. 2000605351
	GEV No.	104066	Ref. No. 3028604319
	GEV No.	104382	Ref. No. 2016905412

			
1			
GEV No.	103041	Ref. No.	5018705859
description	burner cap E ø 125mm		
accessories for	103041		
	GEV No.	104063	Ref. No. 2016905418
	GEV No.	104065	Ref. No. 2000605351
	GEV No.	104066	Ref. No. 3028604319





gas burners

hob burners





producer-specific hob burners





AMBACH

85/90 series

			
1			
GEV No.	104066	Ref. No.	3028604319
description	air mixing sleeve		
For models:	HGG-120, HGG-80, HGG-85, HGG-90		
accessories for	104066		
	GEV No.	104062	Ref. No. 2016905411
	GEV No.	104063	Ref. No. 2016905418
	GEV No.	104064	Ref. No. 2000605350







 1			
GEV No.	104062	Ref. No.	2016905411
description	burner head C for burner cap ø 90mm		
For models:	HGG-120, HGG-80, HGG-85, HGG-90		
accessories for	104062		
	GEV No.	103040	Ref. No. 5018705710
	burner cap C ø 90mm		
	GEV No.	104064	Ref. No. 2000605350
	burner lower part C for burner cap ø 90mm		
	GEV No.	104066	Ref. No. 3028604319
	air mixing sleeve		

 1			
GEV No.	104064	Ref. No.	2000605350
description	burner lower part C for burner cap ø 90mm		
For models:	HGG-120, HGG-80, HGG-85, HGG-90		
accessories for	104064		
	GEV No.	103040	Ref. No. 5018705710
	burner cap C ø 90mm		
	GEV No.	104062	Ref. No. 2016905411
	burner head C for burner cap ø 90mm		
	GEV No.	104066	Ref. No. 3028604319
	air mixing sleeve		

 1			
GEV No.	104382	Ref. No.	2016905412
description	burner head D for burner cap ø 125mm		
For models:	HGG-120, HGG-80, HGG-85, HGG-90		
accessories for	104382		
	GEV No.	104065	Ref. No. 2000605351
	burner lower part D/E for burner cap ø 125mm		
	GEV No.	104066	Ref. No. 3028604319
	air mixing sleeve		
	GEV No.	104381	Ref. No. 5018705711
	burner cap D ø 125mm		

 1			
GEV No.	104065	Ref. No.	2000605351
description	burner lower part D/E for burner cap ø 125mm		
For models:	HGG-120, HGG-80, HGG-85, HGG-90		
accessories for	104065		
	GEV No.	103041	Ref. No. 5018705859
	burner cap E ø 125mm		
	GEV No.	104063	Ref. No. 2016905418
	burner head E for burner cap ø 125mm		
	GEV No.	104066	Ref. No. 3028604319
	air mixing sleeve		
	GEV No.	104381	Ref. No. 5018705711
	burner cap D ø 125mm		
	GEV No.	104382	Ref. No. 2016905412
	burner head D for burner cap ø 125mm		

 1			
GEV No.	104063	Ref. No.	2016905418
description	burner head E for burner cap ø 125mm		
accessories for	104063		
	GEV No.	103041	Ref. No. 5018705859
	burner cap E ø 125mm		
	GEV No.	104065	Ref. No. 2000605351
	burner lower part D/E for burner cap ø 125mm		
	GEV No.	104066	Ref. No. 3028604319
	air mixing sleeve		

old series			
 1			
GEV No.	103038	Ref. No.	3018703054
description	burner cap B ø 65mm		
For models:	GHG-70		
accessories for	103038		
	GEV No.	104060	Ref. No. 2016902026
	burner head B for burner cap ø 65mm		



1

GEV No.	103039	Ref. No.	3018702019
description	burner cap ø 80mm		
For models:	GHG-70		
accessories for	103039		
	GEV No.	104061	Ref. No. 2016902017
burner head C for burner cap ø 80mm			



1

GEV No.	104060	Ref. No.	2016902026
description	burner head B for burner cap ø 65mm		
For models:	GHG-70		





1

GEV No.	104061	Ref. No.	2016902017
description	burner head C for burner cap ø 80mm		
For models:	GHG-70		

Compact Plus series





1

GEV No.	103042	Ref. No.	5018708871 5018709571
description	burner cap C ø 70mm		
For models:	7GH-80, GR-105, GR-35, GRE-105, GRE-70, GREC-105, GRG-105, GRG-70, GRGC-105, SI-105, SIE-105, SIEC-105, SIG-105, SIGC-105		
accessories for	103042		
	GEV No.	104067	Ref. No. 5016908861 5016909391
burner head C for burner cap ø 70mm			
	GEV No.	105264	Ref. No. 5017308860
O-ring Viton thickness 3.53mm ID ø 94.84mm Qty 1 pcs			







1

GEV No.	103043	Ref. No.	5018708872 5018709572
description	burner cap D ø 84mm		
For models:	7GH-80, GR-105, GR-35, GRE-105, GRE-70, GREC-105, GRG-105, GRG-70, GRGC-105, SI-105, SIE-105, SIEC-105, SIG-105, SIGC-105		
accessories for	103043		
	GEV No.	104068	Ref. No. 5016908863 5016909392
burner head D for burner cap ø 84mm			
	GEV No.	105264	Ref. No. 5017308860
O-ring Viton thickness 3.53mm ID ø 94.84mm Qty 1 pcs			



1

GEV No.	104067	Ref. No.	5016908861 5016909391
description	burner head C for burner cap ø 70mm		
For models:	GR-105, GR-35, GRE-105, GRE-70, GREC-105, GRG-105, GRG-70, GRGC-105, SI-105, SIE-105, SIEC-105, SIG-105, SIGC-105		
accessories for	104067		
	GEV No.	103042	Ref. No. 5018708871 5018709571
burner cap C ø 70mm			
	GEV No.	105264	Ref. No. 5017308860
O-ring Viton thickness 3.53mm ID ø 94.84mm Qty 1 pcs			
	GEV No.	697872	Ref. No. 3006308928
catch ø 95/117mm suitable for Ambach			



1

GEV No.	104068	Ref. No.	5016908863 5016909392
description	burner head D for burner cap ø 84mm		
For models:	GR-105, GR-35, GRE-105, GRE-70, GREC-105, GRG-105, GRG-70, GRGC-105, SI-105, SIE-105, SIEC-105, SIG-105, SIGC-105		















			
1			
GEV No.	697872	Ref. No.	3006308928
description	catch ø 95/117mm suitable for Ambach		
For models:	GR-105, GR-35, GRE-105, GRE-70, GREC-105, GRG-105, GRG-70, GRGC-105, SI-105, SIE-105, SIEC-105, SIG-105, SIGC-105		

			
1			
GEV No.	105264	Ref. No.	5017308860
description	O-ring Viton thickness 3.53mm ID ø 94.84mm Qty 1 pcs		
For models:	GR-105, GR-35, GRE-105, GRE-70, GREC-105, GRG-105, GRG-70, GRGC-105, SI-105, SIE-105, SIEC-105, SIG-105, SIGC-105		

			
1			
GEV No.	103063	Ref. No.	5016908870
description	venturi ø 26mm		
For models:	GR-105, GR-35, GRE-105, GRE-70, GREC-105, GRG-105, GRG-70, GRGC-105, SI-105, SIE-105, SIEC-105, SIG-105, SIGC-105		









Ecoline, System 900 series









				
1				
GEV No.	104383	Ref. No.	5018714245	
description	burner cap C ø 75mm			
For models:	GH-120, GH-40, GH-45, GH-45-BF, GH-45-D, GH-45-G, GH-80, GH-90, GH-90-BF, GH-90G, GH-90IV-D, GHE-120, GHE-80, GHG-120, GHG-80			
accessories for	104383			
	GEV No.	104384	Ref. No.	5016914265
	burner head C for burner cap ø 75mm			
	GEV No.	104385	Ref. No.	5017314079
	gasket for burner head			
	GEV No.	104386	Ref. No.	5006314268
	flange for burner head			
	GEV No.	104387	Ref. No.	5050120709
	burner lower part thread 1¼" curved C/E			
	GEV No.	104388	Ref. No.	5016914238
	venturi C for burner cap ø 75mm			







				
1				
GEV No.	104389	Ref. No.	5018714247	
description	burner cap E ø 125mm ID ø 46.5mm			
For models:	GH-120, GH-40, GH-45, GH-45-BF, GH-45-D, GH-45-G, GH-45-H, GH-45-H-BF, GH-45-H-D, GH-45-H-G, GH-80, GH-90, GH-90-BF, GH-90G, GH-90-H, GH-90-H-BF, GH-90-HG, GH-90IV-D, GHE-120, GHE-80, GHG-120, GHG-80			
accessories for	104389			
	GEV No.	104385	Ref. No.	5017314079
	gasket for burner head			
	GEV No.	104386	Ref. No.	5006314268
	flange for burner head			
	GEV No.	104387	Ref. No.	5050120709
	burner lower part thread 1¼" curved C/E			
	GEV No.	104390	Ref. No.	5016914267
	burner head E for burner cap ø 125mm			
	GEV No.	104391	Ref. No.	5016914240
	venturi E for burner cap ø 125mm			

				
1				
GEV No.	104384	Ref. No.	5016914265	
description	burner head C for burner cap ø 75mm			
For models:	GH-120, GH-40, GH-45, GH-45-BF, GH-45-D, GH-45-G, GH-80, GH-90, GH-90-BF, GH-90G, GH-90IV-D, GHE-120, GHE-80, GHG-120, GHG-80			
accessories for	104384			
	GEV No.	104383	Ref. No.	5018714245
	burner cap C ø 75mm			
	GEV No.	104385	Ref. No.	5017314079
	gasket for burner head			
	GEV No.	104386	Ref. No.	5006314268
	flange for burner head			
	GEV No.	104387	Ref. No.	5050120709
	burner lower part thread 1¼" curved C/E			
	GEV No.	104388	Ref. No.	5016914238
	venturi C for burner cap ø 75mm			

			
1			
GEV No.	104390	Ref. No.	5016914267
description	burner head E for burner cap ø 125mm		
For models:	GH-120, GH-40, GH-45, GH-45-BF, GH-45-D, GH-45-G, GH-45-H, GH-45-H-BF, GH-45-H-D, GH-45-H-G, GH-80, GH-90, GH-90-BF, GH-90G, GH-90-H, GH-90-H-BF, GH-90-HG, GH-90IV-D, GHE-120, GHE-80, GHG-120, GHG-80		
accessories for	104390		
	GEV No.	104385	Ref. No. 5017314079
gasket for burner head			
	GEV No.	104386	Ref. No. 5006314268
flange for burner head			
	GEV No.	104387	Ref. No. 5050120709
burner lower part thread 1 1/4" curved C/E			
	GEV No.	104389	Ref. No. 5018714247
burner cap E ø 125mm ID ø 46.5mm			
	GEV No.	104391	Ref. No. 5016914240
venturi E for burner cap ø 125mm			



			
1			
GEV No.	104387	Ref. No.	5050120709
description	burner lower part thread 1 1/4" curved C/E		
For models:	GH-120, GH-40, GH-45, GH-45-BF, GH-45-D, GH-45-G, GH-45-H, GH-45-H-BF, GH-45-H-D, GH-45-H-G, GH-80, GH-90, GH-90-BF, GH-90G, GH-90-H, GH-90-H-BF, GH-90-HG, GH-90IV-D, GHE-120, GHE-80, GHG-120, GHG-80, GNKD100, GNKD-150II, GNKD-150II-BF, GNKD-90II-BF		
accessories for	104387		
	GEV No.	104383	Ref. No. 5018714245
burner cap C ø 75mm			
	GEV No.	104384	Ref. No. 5016914265
burner head C for burner cap ø 75mm			
	GEV No.	104385	Ref. No. 5017314079
gasket for burner head			
	GEV No.	104386	Ref. No. 5006314268
flange for burner head			
	GEV No.	104388	Ref. No. 5016914238
venturi C for burner cap ø 75mm			
	GEV No.	104389	Ref. No. 5018714247
burner cap E ø 125mm ID ø 46.5mm			
	GEV No.	104390	Ref. No. 5016914267
burner head E for burner cap ø 125mm			

			
1			
GEV No.	104386	Ref. No.	5006314268
description	flange for burner head		
For models:	GH-120, GH-40, GH-45, GH-45-BF, GH-45-D, GH-45-G, GH-45-H, GH-45-H-BF, GH-45-H-D, GH-45-H-G, GH-80, GH-90, GH-90-BF, GH-90G, GH-90-H, GH-90-H-BF, GH-90-HG, GH-90IV-D, GHE-120, GHE-80, GHG-120, GHG-80		
accessories for	104386		
	GEV No.	104383	Ref. No. 5018714245
burner cap C ø 75mm			
	GEV No.	104384	Ref. No. 5016914265
burner head C for burner cap ø 75mm			
	GEV No.	104385	Ref. No. 5017314079
gasket for burner head			
	GEV No.	104387	Ref. No. 5050120709
burner lower part thread 1 1/4" curved C/E			
	GEV No.	104388	Ref. No. 5016914238
venturi C for burner cap ø 75mm			
	GEV No.	104389	Ref. No. 5018714247
burner cap E ø 125mm ID ø 46.5mm			
	GEV No.	104390	Ref. No. 5016914267
burner head E for burner cap ø 125mm			

			
1			
GEV No.	104385	Ref. No.	5017314079
description	gasket for burner head		
For models:	GH-120, GH-40, GH-45, GH-45-BF, GH-45-D, GH-45-G, GH-45-H, GH-45-H-BF, GH-45-H-D, GH-45-H-G, GH-80, GH-90, GH-90-BF, GH-90G, GH-90-H, GH-90-H-BF, GH-90-HG, GH-90IV-D, GHE-120, GHE-80, GHG-120, GHG-80		
accessories for	104385		
	GEV No.	104383	Ref. No. 5018714245
burner cap C ø 75mm			
	GEV No.	104384	Ref. No. 5016914265
burner head C for burner cap ø 75mm			
	GEV No.	104386	Ref. No. 5006314268
flange for burner head			
	GEV No.	104387	Ref. No. 5050120709
burner lower part thread 1 1/4" curved C/E			
	GEV No.	104388	Ref. No. 5016914238
venturi C for burner cap ø 75mm			





			
GEV No.	104388	Ref. No.	5016914238
description	venturi C for burner cap ø 75mm		
For models:	GH-120, GH-40, GH-45, GH-45-BF, GH-45-D, GH-45-G, GH-80, GH-90, GH-90-BF, GH-90G, GHE-120, GHE-80, GHG-120, GHG-80		
accessories for	104388		
	GEV No.	104383	Ref. No. 5018714245
	burner cap C ø 75mm		
	GEV No.	104384	Ref. No. 5016914265
	burner head C for burner cap ø 75mm		
	GEV No.	104385	Ref. No. 5017314079
	gasket for burner head		
	GEV No.	104386	Ref. No. 5006314268
	flange for burner head		
	GEV No.	104387	Ref. No. 5050120709
	burner lower part thread 1¼" curved C/E		

			
GEV No.	104391	Ref. No.	5016914240
description	venturi E for burner cap ø 125mm		
For models:	GH-120, GH-40, GH-45, GH-45-BF, GH-45-D, GH-45-G, GH-45-H, GH-45-H-BF, GH-45-H-D, GH-45-H-G, GH-80, GH-90, GH-90-BF, GH-90G, GH-90-H, GH-90-H-BF, GH-90-HG, GHE-120, GHE-80, GHG-120, GHG-80		
accessories for	104391		
	GEV No.	104385	Ref. No. 5017314079
	gasket for burner head		
	GEV No.	104386	Ref. No. 5006314268
	flange for burner head		
	GEV No.	104387	Ref. No. 5050120709
	burner lower part thread 1¼" curved C/E		
	GEV No.	104389	Ref. No. 5018714247
	burner cap E ø 125mm ID ø 46.5mm		
	GEV No.	104390	Ref. No. 5016914267
	burner head E for burner cap ø 125mm		

pan supports

			
GEV No.	210133	Ref. No.	5010101970 5010108970
description	pan support W 320mm L 320mm for gas range		
For models:	GHG-70		

			
GEV No.	210134	Ref. No.	5010108830 5010108970
description	pan support W 320mm L 325mm SS		
For models:	GR-105, GR-35, GRE-105, GRE-70, GREC-105, GRG-105, GRG-70, GRGC-105, SI-105, SIE-105, SIEC-105, SIG-105, SIGC-105		

			
GEV No.	210106	Ref. No.	5010104350 5010110315
description	pan support W 325mm L 395mm H 40mm SS for 850		
For models:	HGG-120, HGG-80, HGG-85, HGG-90		

reducers for pan supports

			
GEV No.	210007	Ref. No.	5010104372
description	reducer for pan support L 205mm W 205mm		
For models:	HGG-120, HGG-80, HGG-85, HGG-90		

			
GEV No.	210008	Ref. No.	5010108996
description	reducer for pan support L 205mm W 205mm		
For models:	GR-105, GR-35, GRE-105, GRE-70, GREC-105, GRG-105, GRG-70, GRGC-105, SI-105, SIE-105, SIEC-105, SIG-105, SIGC-105		



accessories

reducers for pan supports



1

GEV No.	210007	Ref. No.	5010104372
----------------	--------	-----------------	------------

description	reducer for pan support L 205mm W 205mm
--------------------	-----------------------------------------

For models:	HGG-120, HGG-80, HGG-85, HGG-90
--------------------	---------------------------------



1

GEV No.	210008	Ref. No.	5010108996
----------------	--------	-----------------	------------

description	reducer for pan support L 205mm W 205mm
--------------------	-----------------------------------------

For models:	GR-105, GR-35, GRE-105, GRE-70, GREC-105, GRG-105, GRG-70, GRGC-105, SI-105, SIE-105, SIEC-105, SIG-105, SIGC-105
--------------------	-------------------------------------------------------------------------------------------------------------------

pan supports



1

GEV No.	210133	Ref. No.	5010101970 5010108970
----------------	--------	-----------------	--------------------------

description	pan support W 320mm L 320mm for gas range
--------------------	-------------------------------------------

For models:	GHG-70
--------------------	--------



1

GEV No.	210134	Ref. No.	5010108830 5010108970
----------------	--------	-----------------	--------------------------

description	pan support W 320mm L 325mm SS
--------------------	--------------------------------

For models:	GR-105, GR-35, GRE-105, GRE-70, GREC-105, GRG-105, GRG-70, GRGC-105, SI-105, SIE-105, SIEC-105, SIG-105, SIGC-105
--------------------	-------------------------------------------------------------------------------------------------------------------



1

GEV No.	210106	Ref. No.	5010104350 5010110315
----------------	--------	-----------------	--------------------------

description	pan support W 325mm L 395mm H 40mm SS for 850
--------------------	-----------------------------------------------

For models:	HGG-120, HGG-80, HGG-85, HGG-90
--------------------	---------------------------------

air mixers



1

GEV No.	104658	Ref. No.	5028614258 AM5028614258
----------------	--------	-----------------	----------------------------

description	air mixing sleeve H 30mm ED ø 34mm ID ø 30mm thickness 2mm aluminium suitable for Ambach
--------------------	------------------------------------------------------------------------------------------

For models:	GH-120, GH-40, GH-45, GH-45-BF, GH-45-D, GH-45-G, GH-45-H, GH-45-H-BF, GH-45-H-D, GH-45-H-G, GH-80, GH-90, GH-90-BF, GH-90G, GH-90-H, GH-90-H-BF, GH-90-HG, GH-90IV-D, GHE-120, GHE-80, GHG-120, GHG-80
--------------------	---------------------------------------------------------------------------------------------------------------------------------------------------------------------------------------------------------



1

GEV No.	699341	Ref. No.	3028608964
----------------	--------	-----------------	------------

description	air mixing sleeve H 36mm ED ø 30mm ID ø 27mm
--------------------	----------------------------------------------

For models:	GR-105, GR-35, GRE-105, GRE-70, GREC-105, GRG-105, GRG-70, GRGC-105, SI-105, SIE-105, SIEC-105, SIG-105, SIGC-105
--------------------	-------------------------------------------------------------------------------------------------------------------

bar burners

bar burners



1

GEV No.	104165	Ref. No.	5016901907
----------------	--------	-----------------	------------

description	bar burner 1-row ømm W 28mm H 42mm L 500mm flange width 35mm flange length 68mm griddle
--------------------	-----------------------------------------------------------------------------------------

For models:	GG-80-V, GKH-90, GKM-50, GKM-90, KHG-90
--------------------	-----------------------------------------



1

GEV No.	104156	Ref. No.	5016911984
----------------	--------	-----------------	------------

description	bar burner 2 row L 445mm W 200mm ømm H 50mm chargrill stainless steel
--------------------	-----------------------------------------------------------------------

For models:	GLG40CP, GLG-45II, GLG-45II-D, GLG70, GLG80, GLG-80-ECOII, GLG-90-BF, GLG-90II-D
--------------------	----------------------------------------------------------------------------------





			
1			
GEV No.	104407	Ref. No.	5016914273
description	bar burner ø 40mm Wmm Hmm L 500mm tilting bratt pan flange ø 61mm		
For models:	GBK120E, GKB-120, GKB-120-BF, GKB-120EII, GKB-150, GKB-150-BF, GKB-150EII		

			
1			
GEV No.	104400	Ref. No.	5016914275
description	bar burner ø 50mm Wmm Hmm L 465mm flange width 71mm pasta cooker flange ø 75mm		
For models:	CPG-40, GPK-40, GUK-45II, GUK-45II-BF, GUK-45II-D		

			
1			
GEV No.	104410	Ref. No.	5016914561
description	bar burner ø 50mm Wmm Hmm L 370mm flange width 57mm flange length 57mm kettle		
For models:	GKS-60, GSK100, GSK-40, GSK60, GSK-60-40, GSK-60-40-BF		

			
1			
GEV No.	104411	Ref. No.	5016914562
description	bar burner ø 50mm Wmm Hmm L 520mm 12kW kettle		
For models:	GKS-100, GKS-150, GKS-80, GSK100, GSK-100-80, GSK-100-80-BF, GSK-150, GSK-150-BF, GSK-80		

			
1			
GEV No.	104395	Ref. No.	5016914204
description	bar burner ø 50mm Wmm Hmm L 370mm flange width 72mm flange ø 75mm total length 460mm solid top GP45		
For models:	GP-45, GP-45-BF, GP-45-D		

			
1			
GEV No.	104397	Ref. No.	5016914274
description	bar burner ø 50mm Wmm Hmm L 530mm flange width 71mm oven flange ø 75mm		
For models:	GB-90		

			
1			
GEV No.	104167	Ref. No.	5016908868
description	bar burner ø 50mm Wmm Hmm L 428mm flange width 71mm griddle		
For models:	GBP-40-C, GBP-40-L, GBP-40-R, GBP-80-1-2LR, GBP-80-C, GBP-80-L, GBP-80-R, GUG-40, GUG-40-B, GUG-40-C, GUG-40-V, GUG-70, GUG-70-1-2LR, GUG-70-B, GUG-70-C, GUG-70-V, TPG-80		

			
1			
GEV No.	104398	Ref. No.	5016914276
description	bar burner ø 50mm Wmm Hmm L 565mm flange width 71mm griddle flange ø 75mm		
For models:	GBP-90-1-2LR, GBP-90-1-2LR-BF, GBP-90-1-2LR-D, GBP-90-C, GBP-90-C-BF, GBP-90-C-D, GBP-90-L, GBP-90-L-BF, GBP-90-L-D, GBP-90-R, GBP-90-R-BF, GBP-90-R-D		

			
1			
GEV No.	104396	Ref. No.	5016914277
description	bar burner ø 50mm Wmm Hmm L 460mm flange width 71mm solid top flange ø 75mm GP90		
For models:	GP-90, GP-90-BF, GP-90-D		

			
1			
GEV No.	104139	Ref. No.	5016908867
description	bar burner ø 50mm Wmm Hmm L 568mm flange width 71mm oven		
For models:	GHG-120, GHG-80, GKG-70, GPSG-80, GRG-105, GRG-70, GRGC-105, GSPG80, SIG-105, SIGC-105		



			
1			
GEV No.	104168	Ref. No.	5016907365
description	bar burner ømm W 28mm H 42mm L 250mm flange width 35mm flange length 68mm kettle		
For models:	K7G-35, K7G-50, KKG100		

			
1			
GEV No.	104149	Ref. No.	5016907865
description	bar burner ømm W 28mm H 42mm L 430mm flange width 35mm flange length 68mm griddle		
For models:	GBP-70-V, GGG-80, GZE-70, KBHG-70-R, ZGG-80		

			
1			
GEV No.	104393	Ref. No.	5016907623
description	bar burner ømm W 29mm H 43mm L 570mm gas range		
For models:	GGG-80, GHG-70, GPG-80, GPG-85, GPG-90, HGG-120, HGG-80, HGG-85, HGG-90, ZGG-80		

tube burners

			
1			
GEV No.	104403	Ref. No.	5016914328 5016917788
description	tubular burner ø 74mm L 180mm H 60mm round for fryer		
For models:	GF1-40, GF1-45, GF1-45-BF, GF1-45-D, GF2-60, GF2-60-BF, GF2-60-D, GF2-60-ECO, GY1-40, GY2-70		

solid top burners

			
1			
GEV No.	104148	Ref. No.	3516911678 5016907861
description	solid top burner ø 120mm H 102mm L 340mm		
For models:	BPG-50, GK-70, GPG-80, GPG-85, GPG-90		

			
1			
GEV No.	104394	Ref. No.	3516911678
description	solid top burner ø 120mm H 102mm L 340mm		
For models:	GK-70, GKE-70, GKG-70, GPS-80, GPSE-80, GPSG-80, GSPG80, SI-105, SIE-105, SIEC-105, SIG-105, SIGC-105		

surface burners

			
1			
GEV No.	104401	Ref. No.	5016908866
description	surface burner L 245mm W 154mm H 75mm firing range 195x140mm burner rows 10 for fryer		
For models:	GY-40		

			
1			
GEV No.	104402	Ref. No.	5016906679
description	surface burner L 245mm W 175mm H 75mm firing range 195x160mm burner rows 10 for fryer		
For models:	FG1-40, GF-40		



accessories

nozzle holders



1			
GEV No.	101369	Ref. No.	5051304317
description	nozzle holder ET 3/8" IT M10x1 WS 19		
For models:	GRG-70, HGG-120, HGG-80, HGG-85, HGG-90		

miscellaneous



1			
GEV No.	101367	Ref. No.	5006304316
description	connection angle for gas burner		
For models:	GGG-80, GR-105, GR-35, GRE-105, GRE-70, GREC-105, GRG-105, GRG-70, GRGC-105, HGG-120, HGG-80, HGG-85, HGG-90, SI-105, SIE-105, SIEC-105, SIG-105, SIGC-105, ZGG-80		

accessories for	101367		
	GEV No.	101369	Ref. No. 5051304317
	nozzle holder ET 3/8" IT M10x1 WS 19		



1			
GEV No.	101927	Ref. No.	5051204360 5051216065
description	connection angle for gas burner		
For models:	CPG-40, GBP-45-C, GBP-45-C-BF, GBP-45-C-D, GBP-45-L, GBP-45-L-BF, GBP-45-L-D, GBP-45-R, GBP-45-R-BF, GBP-45-R-D, GBP-70-V, GBR45R, GGG-80, GPK-40, HGG-120, HGG-80, HGG-85, HGG-90, KSKE-100, KSKE-50, ZGG-80		



1			
GEV No.	104386	Ref. No.	5006314268
description	flange for burner head		
For models:	GH-120, GH-40, GH-45, GH-45-BF, GH-45-D, GH-45-G, GH-45-H, GH-45-H-BF, GH-45-H-D, GH-45-H-G, GH-80, GH-90, GH-90-BF, GH-90G, GH-90-H, GH-90-H-BF, GH-90-HG, GH-90IV-D, GHE-120, GHE-80, GHG-120, GHG-80		

accessories for	104386		
	GEV No.	104383	Ref. No. 5018714245
	burner cap C ø 75mm		
	GEV No.	104384	Ref. No. 5016914265
	burner head C for burner cap ø 75mm		
	GEV No.	104385	Ref. No. 5017314079
	gasket for burner head		
	GEV No.	104387	Ref. No. 5050120709
	burner lower part thread 1¼" curved C/E		

accessories for	104386		
	GEV No.	104388	Ref. No. 5016914238
	venturi C for burner cap ø 75mm		
	GEV No.	104389	Ref. No. 5018714247
	burner cap E ø 125mm ID ø 46.5mm		
	GEV No.	104390	Ref. No. 5016914267
	burner head E for burner cap ø 125mm		

1			
GEV No.	101368	Ref. No.	5051203262
description	tube connector for pipe ø 10/10mm		
For models:	GP-90-D, HGG-120, HGG-80, HGG-85, HGG-90, KSKE-100, KSKE-50		

gas nozzles

main nozzles

gas nozzles M6x0.75



1			
GEV No.	102768	Ref. No.	5017203175
description	gas injector thread M6x0.75 WS 7 bore ø 0.5mm		
For models:	FG1-40, GF-40		



1			
GEV No.	102769	Ref. No.	5017203176
description	gas injector thread M6x0.75 WS 7 bore ø 0.9mm		
For models:	FG1-40, GF-40		

gas nozzles M10x1





1			
GEV No.	100631	Ref. No.	5017203086
description	gas injector thread M10x1 WS 11 bore ø 0.65mm inner peaked		
For models:	GGG-80, ZGG-80		





1			
GEV No.	100633	Ref. No.	5017203119
description	gas injector thread M10x1 WS 11 bore ø 0.75mm inner peaked		
For models:	KBHG-70-R		

			
1			
GEV No.	100632	Ref. No.	5017203110
description	gas injector thread M10x1 WS 11 bore ø 0.7mm inner peaked		
For models:	GG-80-V, GHG-70		

			
1			
GEV No.	100634	Ref. No.	5017203116
description	gas injector thread M10x1 WS 11 bore ø 0.8mm inner peaked		
For models:	GZE-70, KMG-50		

			
1			
GEV No.	100650	Ref. No.	5017207624
description	gas injector thread M10x1 WS 11 bore ø 0.8mm inner peaked		
For models:	GGG-80, GHG-70, GPG-80, GPG-85, GPG-90, HGG-120, HGG-80, HGG-85, HGG-90, KHG-90, ZGG-80		

			
1			
GEV No.	100636	Ref. No.	5017203121
description	gas injector thread M10x1 WS 11 bore ø 0.9mm inner peaked		
For models:	GBP-70-V		

			
1			
GEV No.	100651	Ref. No.	5017207183
description	gas injector thread M10x1 WS 11 bore ø 1.05mm inner flat		
For models:	GKB-70, K7G-35, K7G-50		

			
1			
GEV No.	100652	Ref. No.	5017207366
description	gas injector thread M10x1 WS 11 bore ø 1.15mm inner flat		
For models:	KKG100		

			
1			
GEV No.	100639	Ref. No.	5017203106
description	gas injector thread M10x1 WS 11 bore ø 1.25mm inner peaked		
For models:	GHG-70, KBHG-70-R		

			
1			
GEV No.	100641	Ref. No.	5017203105
description	gas injector thread M10x1 WS 11 bore ø 1.35mm inner peaked		

			
1			
GEV No.	100642	Ref. No.	5017202639
description	gas injector thread M10x1 WS 11 bore ø 1.4mm inner peaked		
For models:	KMG-50		

			
1			
GEV No.	100653	Ref. No.	5017203108 5017207186
description	gas injector thread M10x1 WS 11 bore ø 1.5mm inner flat		
For models:	GBP-70-V, GG-80-V, GGG-80, GHG-70, GKB-70, GPG-80, GPG-85, GPG-90, GZE-70, HGG-120, HGG-80, HGG-85, HGG-90, K7G-35, K7G-50, KBHG-70-R, KHG-90, KKG100, KMG-50, ZGG-80		

			
1			
GEV No.	100643	Ref. No.	5017203112
description	gas injector thread M10x1 WS 11 bore ø 1.5mm inner peaked		
For models:	GBP-70-V, GHG-70		

			
1			
GEV No.	100973	Ref. No.	5017214899
description	gas injector thread M10x1 bore ø 0.8mm L 30mm WS 12		

			
1			
GEV No.	100670	Ref. No.	5017207866
description	gas injector thread M10x1 bore ø 0.9mm L 30mm WS 12		
For models:	HGG-120, HGG-80, HGG-85, HGG-90		

			
1			
GEV No.	106400	Ref. No.	5017208672
description	gas injector thread M10x1 bore ø 1.1mm L 30mm WS 12		

			
1			
GEV No.	100671	Ref. No.	5017208072
description	gas injector thread M10x1 bore ø 1.25mm L 30mm WS 12		
For models:	HGG-120, HGG-80, HGG-85, HGG-90		

			
1			
GEV No.	100155	Ref. No.	5017208702
description	gas injector thread M10x1 bore ø 1.45mm L 30mm WS 12		



			
1			
GEV No.	100675	Ref. No.	5017207480
description	gas injector thread M10x1 bore ø 1.4mm L 30mm WS 12		

			
1			
GEV No.	100672	Ref. No.	5017203088
description	gas injector thread M10x1 bore ø 1.7mm L 30mm WS 12		
For models:	GRG-70, HGG-120, HGG-80, HGG-85, HGG-90		

			
1			
GEV No.	102791	Ref. No.	5017214902 AM5017214902
description	gas injector thread M10x1 bore ø 1.95mm L 30mm WS 12		

			
1			
GEV No.	106403	Ref. No.	5017203090 AM5017203090
description	gas injector thread M10x1 bore ø 1.9mm L 30mm WS 12		
For models:	HGG-120, HGG-80, HGG-85, HGG-90		

			
1			
GEV No.	100673	Ref. No.	5017208833
description	gas injector thread M10x1 bore ø 2.05mm L 30mm WS 12		
For models:	GRG-70		

gas nozzles M11x1

			
1			
GEV No.	106642	Ref. No.	5017214703
description	gas injector thread M11x1 WS 13 bore ø 1.05mm		

			
1			
GEV No.	100686	Ref. No.	5017207878
description	gas injector thread M11x1 WS 13 bore ø 1.7mm		
For models:	GPG-80, GPG-85, GPG-90		

			
1			
GEV No.	100688	Ref. No.	5017208753
description	gas injector thread M11x1 WS 13 bore ø 1.8mm		

			
1			
GEV No.	100690	Ref. No.	5017207882
description	gas injector thread M11x1 WS 13 bore ø 1.9mm		
For models:	GRG-70, GUG-40, GUG-40-V, GUG-70, GUG-70-V		

			
1			
GEV No.	100696	Ref. No.	5017207879
description	gas injector thread M11x1 WS 13 bore ø 3mm		
For models:	BPG-50, GPG-80, GPG-85, GPG-90		

pilot burner nozzles

pilot burner nozzles POLIDORO

			
1			
GEV No.	100208	Ref. No.	5017207876
description	pilot burner nozzle POLIDORO LPG code 20 bore ø 0.2mm Qty 1 pcs		

			
1			
GEV No.	106859	Ref. No.	501720776
description	pilot burner nozzle POLIDORO LPG code 24 bore ø 0.24mm Qty 1 pcs		

			
1			
GEV No.	106703	Ref. No.	5017207877
description	pilot burner nozzle POLIDORO natural gas code 27.2 bore ø 2x0.27mm Qty 1 pcs		
For models:	FG1-40, GF-40, GG-80-V, GGG-80, GPG-80, GPG-85, GPG-90, K7G-35, K7G-50, KKG100, ZGG-80		

pilot burner nozzles SIT

100 series



GEV No.	100245	Ref. No.	5017207634
description	pilot burner nozzle LPG code 20 bore \varnothing 0.2mm Qty 1 pcs thread M8x0.75		



GEV No.	100246	Ref. No.	5017208682
description	pilot burner nozzle natural gas bore \varnothing 0.35mm Qty 1 pcs thread M8x0.75		

160 series



GEV No.	107649	Ref. No.	5017214033
description	pilot burner nozzle SIT LPG code 20 Qty 1 pcs		



GEV No.	107650	Ref. No.	5017208677
description	pilot burner nozzle SIT LPG code 30 Qty 1 pcs		
For models:	GRG-70		

pilot burner nozzles (other)

AMBACH



GEV No.	106748	Ref. No.	5017203104
description	pilot burner nozzle code 30 bore \varnothing 0.3mm WS 12 Qty 1 pcs T1: M10x1 T2: M10x0.75		
For models:	GBP-70-V, GGG-80, GHG-70, GPG-80, GPG-85, GPG-90, GZE-70, HGG-120, HGG-80, HGG-85, HGG-90, K7G-35, K7G-50, KKG100, ZGG-80		



GEV No.	100256	Ref. No.	5017202875
description	pilot burner nozzle code 40 bore \varnothing 0.4mm thread M10x1 - 3/8" UNEF WS 12 Qty 1 pcs suitable for Ambach T1: M10x1 T2: M10x0.75		
For models:	HGG-120, HGG-80, HGG-85, HGG-90		



GEV No.	106749	Ref. No.	5017203133
description	pilot burner nozzle code 45 bore \varnothing 0.45mm WS 12 Qty 1 pcs T1: M10x1 T2: M10x0.75		
For models:	KMG-50		



GEV No.	106750	Ref. No.	5017202878
description	pilot burner nozzle code 60 bore \varnothing 0.6mm WS 12 Qty 1 pcs T1: M10x1 T2: M10x0.75		
For models:	GBP-70-V, GGG-80, GHG-70, ZGG-80		



GEV No.	107351	Ref. No.	5017207481
description	pilot burner nozzle code 80 bore \varnothing 0.8mm WS 12 Qty 1 pcs suitable for Ambach T1: M10x1 T2: M10x0.75		
For models:	GG-80-V, GPG-80, GPG-85, GPG-90, KKG100		



GEV No.	102770	Ref. No.	5017203103
description	pilot burner nozzle LPG bore \varnothing 0.25mm WS 12 Qty 1 pcs suitable for Ambach T1: M10x1 T2: M10x0.75		
For models:	GGG-80, ZGG-80		



GEV No.	102555	Ref. No.	5017202865
description	pilot burner nozzle LPG bore \varnothing 0.2mm WS 12 Qty 5 pcs suitable for Ambach T1: M10x1 T2: M10x0.75		
For models:	HGG-120, HGG-80, HGG-85, HGG-90		



GEV No.	100252	Ref. No.	5017202871
description	pilot burner nozzle LPG bore \varnothing 0.35mm WS 12 Qty 1 pcs T1: M10x1 T2: M10x0.75		
For models:	GRG-70		



			
1			
GEV No.	100255	Ref. No.	5017202865
description	pilot burner nozzle LPG code 20 bore ø 0.2mm thread WS 12 Qty 1 pcs suitable for Ambach T1: M10x1 T2: M10x0.75		

bypass nozzles

bypass nozzles EGA

			
1			
GEV No.	106747	Ref. No.	5017203168
description	bypass nozzle bore ø 1mm LPG suitable for EGA		
For models:	KHG-90, KMG-50		

bypass nozzles PEL20/21

			
1			
GEV No.	100408	Ref. No.	5017203034
description	bypass nozzle type PEL20/21 bore ø 0.35mm thread M5x0.5		

			
1			
GEV No.	100550	Ref. No.	5017203166 AM5017203166
description	bypass nozzle type PEL20/21 bore ø 0.55mm thread M5x0.5		

			
1			
GEV No.	100526	Ref. No.	5017203035
description	bypass nozzle type PEL20/21 bore ø 0.5mm thread M5x0.5		
For models:	HGG-120, HGG-80, HGG-85, HGG-90		

bypass nozzles PEL22

			
1			
GEV No.	100392	Ref. No.	5017214713 AM5017214713
description	bypass nozzle type PEL22 bore ø 0.6mm thread M6x0.5		

			
1			
GEV No.	100433	Ref. No.	5017208741
description	bypass nozzle type PEL22 bore ø 0.9mm thread M6x0.5		

gas nozzles sets





			
1			
GEV No.	106706	Ref. No.	7903915334DE01
description	gas injector set LPG Ambach		

			
1			
GEV No.	106746	Ref. No.	7904912042DE01
description	gas injector set LPG Ambach		



auxiliary gas parts



screw connections





olives

				
1				
GEV No.	101278	Ref. No.	5050503589	
description	olive for pipe ø 10mm Qty 1 pcs			
For models:	GGG-80, GR-105, GR-35, GRE-105, GRE-70, GREC-105, GRG-105, GRG-70, GRGC-105, HGG-120, HGG-80, HGG-85, HGG-90, SI-105, SIE-105, SIEC-105, SIG-105, SIGC-105, ZGG-80			
accessories for	101278			
	GEV No.	100943	Ref. No.	—
	union nut thread M17x1 tube ø 10mm			
	GEV No.	101300	Ref. No.	5040603582
	union nut thread M16x1.5 tube ø 10mm			
	GEV No.	101478	Ref. No.	—
	union nut thread 3/8" for pipe ø 10mm			





			
1			
GEV No.	101248	Ref. No.	5050503001
description	olive for pipe ø 12mm Qty 1 pcs suitable for PEL		
For models:	CPG-40, GG-80-V, GH-120, GH-40, GH-45, GH-45-BF, GH-45-D, GH-45-G, GH-45-H, GH-45-H-BF, GH-45-H-D, GH-45-H-G, GH-80, GH-90, GH-90-BF, GH-90G, GH-90-H, GH-90-H-BF, GH-90-HG, GH-90IV-D, GHE-120, GHE-80, GHG-120, GHG-80, GK-70, GKE-70, GKG-70, GLG40CP, GLG-45II, GLG-45II-D, GLG70, GLG80, GLG-80-ECOII, GLG-90-BF, GLG-90II-D, GP-45, GP-45-BF, GP-45-D, GP-90, GP-90-BF, GP-90-D, GPG-80, GPG-85, GPG-90, GPK-40, GPS-80, GPSE-80, GPSG-80, GRG-70, GSPG80...(Other models you can see in the webshop)		
accessories for	101248		
	GEV No.	101251	Ref. No. 5040603188
union nut thread M20x1.5 for pipe ø 12mm			



			
1			
GEV No.	101246	Ref. No.	5050503573
description	olive for pipe ø 4mm Qty 1 pcs		
For models:	BPG-50, CPG-40, GBP-40-C, GBP-40-L, GBP-40-R, GBP-45-C, GBP-45-C-BF, GBP-45-C-D, GBP-45-L, GBP-45-L-BF, GBP-45-L-D, GBP-45-R, GBP-45-R-BF, GBP-45-R-D, GBP-80-1-2LR, GBP-80-C, GBP-80-L, GBP-80-R, GBP-90-1-2LR, GBP-90-1-2LR-BF, GBP-90-1-2LR-D, GBP-90-C, GBP-90-C-BF, GBP-90-C-D, GBP-90-L, GBP-90-L-BF, GBP-90-L-D, GBP-90-R, GBP-90-R-BF, GBP-90-R-D, GBR45R, GF1-40, GF2-60-ECO, GGG-80, GH-120, GH-40, GH-45, GH-45-BF, GH-45-D, GH-45-G, GH-45-H, GH-45-H-BF, GH-45-H-D, GH-45-H-G, GH-80, GH-90, GH-90-BF, GH-90G, GH-90-H, GH-90-H-BF...(Other models you can see in the webshop)		
accessories for	101246		
	GEV No.	100908	Ref. No. 5040603572
union screw thread M10x1 for pipe ø 4mm Qty 1 pcs			

			
1			
GEV No.	101284	Ref. No.	5050503209
description	olive for pipe ø 4mm Qty 1 pcs		
accessories for	101284		
	GEV No.	101259	Ref. No. —
union nut thread M8x1 for pipe ø 4mm			
	GEV No.	101285	Ref. No. —
union screw thread M8x1 for pipe ø 4mm Qty 1 pcs JUNKERS			
	GEV No.	101294	Ref. No. 5040603228
union nut thread M10x1 for pipe ø 4mm WS 14 L 12mm Qty 1 pcs			

			
1			
GEV No.	102584	Ref. No.	5050503209
description	olive for pipe ø 4mm Qty 10 pcs		
For models:	GRG-70, HGG-120, HGG-80, HGG-85, HGG-90		

			
1			
GEV No.	101286	Ref. No.	5050503194
description	olive ID ø 6mm Qty 1 pcs		
For models:	GBK120E, GBP-70-V, GBP-90-1-2LR, GBP-90-1-2LR-BF, GBP-90-1-2LR-D, GBP-90-C, GBP-90-C-BF, GBP-90-C-D, GBP-90-L, GBP-90-L-BF, GBP-90-L-D, GBP-90-R, GBP-90-R-BF, GBP-90-R-D, GG-80-V, GGG-80, GHG-70, GKB-120, GKB-120-BF, GKB-120EII, GKB-150, GKB-150-BF, GKB-150EII, GKH-90, GKM-50, GKM-90, GP-90, GP-90-BF, GP-90-D, GPG-80, GPG-85, GPG-90, GZE-70, HGG-120, HGG-80, HGG-85, HGG-90, KBHG-70-R, KHG-90, KKG100, KMG-50, TPG-80, ZGG-80		
accessories for	101286		
	GEV No.	100909	Ref. No. —
union screw thread M10x1 for pipe ø 6mm Qty 1 pcs			
	GEV No.	101464	Ref. No. —
union nut thread M12x1 for pipe ø 6mm			



union nuts

			
1			
GEV No.	101294	Ref. No.	5040603228
description	union nut thread M10x1 for pipe ø 4mm WS 14 L 12mm Qty 1 pcs		
For models:	GRG-70, HGG-120, HGG-80, HGG-85, HGG-90		
accessories for	101294		
	GEV No.	101284	Ref. No. 5050503209
olive for pipe ø 4mm Qty 1 pcs			

			
1			
GEV No.	101484	Ref. No.	5040603226 AM5040603226
description	union nut thread M10x1 WS 12 Qty 1 pcs for pipe ø 6mm		
For models:	GBK120E, GBP-70-V, GBP-90-1-2LR, GBP-90-1-2LR-BF, GBP-90-1-2LR-D, GBP-90-C, GBP-90-C-BF, GBP-90-C-D, GBP-90-L, GBP-90-L-BF, GBP-90-L-D, GBP-90-R, GBP-90-R-BF, GBP-90-R-D, GG-80-V, GGG-80, GHG-70, GKB-120, GKB-120-BF, GKB-120EII, GKB-150, GKB-150-BF, GKB-150EII, GKH-90, GKM-50, GKM-90, GP-90, GP-90-BF, GP-90-D, GPG-80, GPG-85, GPG-90, GZE-70, HGG-120, HGG-80, HGG-85, HGG-90, K7G-35, K7G-50, KBHG-70-R, KHG-90, KKG100, KMG-50, TPG-80, ZGG-80		

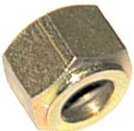







			
1			
GEV No.	101300	Ref. No.	5040603582
description	union nut thread M16x1.5 tube ø 10mm		
For models:	GGG-80, GR-105, GR-35, GRE-105, GRE-70, GREC-105, GRG-105, GRG-70, GRGC-105, HGG-120, HGG-80, HGG-85, HGG-90, SI-105, SIE-105, SIEC-105, SIG-105, SIGC-105, ZGG-80		
accessories for	101300		
		GEV No.	101278 Ref. No. 5050503589
	olive for pipe ø 10mm Qty 1 pcs		

			
1			
GEV No.	101251	Ref. No.	5040603188
description	union nut thread M20x1.5 for pipe ø 12mm		
For models:	CPG-40, GG-80-V, GH-120, GH-40, GH-45, GH-45-BF, GH-45-D, GH-45-G, GH-45-H, GH-45-H-BF, GH-45-H-D, GH-45-H-G, GH-80, GH-90, GH-90-BF, GH-90G, GH-90-H, GH-90-H-BF, GH-90-HG, GH-90IV-D, GHE-120, GHE-80, GHG-120, GHG-80, GK-70, GKE-70, GKG-70, GLG40CP, GLG-45II, GLG-45II-D, GLG70, GLG80, GLG-80-ECOII, GLG-90-BF, GLG-90II-D, GP-45, GP-45-BF, GP-45-D, GP-90, GP-90-BF, GP-90-D, GPG-80, GPG-85, GPG-90, GPK-40, GPS-80, GPSE-80, GPSG-80, GRG-70, GSPG80...(Other models you can see in the webshop)		
accessories for	101251		
		GEV No.	101248 Ref. No. 5050503001
	olive for pipe ø 12mm Qty 1 pcs suitable for PEL		

union screws

			
1			
GEV No.	100906	Ref. No.	5040317235 5040616959
description	screw connection thread M10x1 for ignition electrode brass Qty 1 pcs WS 10		

			
1			
GEV No.	100907	Ref. No.	5040306819 5040616958
description	screw connection thread M10x1 Qty 1 pcs type SEF 1 ømm for thermocouple		
For models:	CPG-40, GF1-40, GF2-60-ECO, GKM-50, GLG40CP, GLG-45II, GLG-45II-D, GLG70, GLG80, GLG-80-ECOII, GLG-90-BF, GLG-90II-D, GPK-40, GUK-45II, GUK-45II-BF, GUK-45II-D, GY1-40, GY2-70		

			
1			
GEV No.	100908	Ref. No.	5040603572
description	union screw thread M10x1 for pipe ø 4mm Qty 1 pcs		
For models:	BPG-50, CPG-40, GB-90, GBP-40-C, GBP-40-L, GBP-40-R, GBP-45-C, GBP-45-C-BF, GBP-45-C-D, GBP-45-L, GBP-45-L-BF, GBP-45-L-D, GBP-45-R, GBP-45-R-BF, GBP-45-R-D, GBP-80-1-2LR, GBP-80-C, GBP-80-L, GBP-80-R, GBP-90-1-2LR, GBP-90-1-2LR-BF, GBP-90-1-2LR-D, GBP-90-C, GBP-90-C-BF, GBP-90-C-D, GBP-90-L, GBP-90-L-BF, GBP-90-L-D, GBP-90-R, GBP-90-R-BF, GBP-90-R-D, GBR45R, GF1-40, GF2-60-ECO, GGG-80, GH-120, GH-40, GH-45, GH-45-BF, GH-45-D, GH-45-G, GH-45-H, GH-45-H-BF, GH-45-H-D, GH-45-H-G, GH-80, GH-90, GH-90-BF, GH-90G, GH-90-H...(Other models you can see in the webshop)		
accessories for	100908		
		GEV No.	100897 Ref. No. —
	olive for pipe ø 4mm Qty 1 pcs for pilot burner		
		GEV No.	101246 Ref. No. 5050503573
	olive for pipe ø 4mm Qty 1 pcs		
		GEV No.	101280 Ref. No. —
	olive for pipe ø 4mm Qty 1 pcs		
		GEV No.	101282 Ref. No. —
	olive for pipe ø 4mm L 7.4mm Qty 1 pcs		

accessories

			
1			
GEV No.	520561	Ref. No.	3522914349
description	butterfly handle for gas ball valve yellow metal L 45mm W 24mm H 20.5mm intake 5x8		
For models:	GB-90, GBK120E, GBP-45-C, GBP-45-C-BF, GBP-45-C-D, GBP-45-L, GBP-45-L-BF, GBP-45-L-D, GBP-45-R, GBP-45-R-BF, GBP-45-R-D, GBP-90-1-2LR, GBP-90-1-2LR-BF, GBP-90-1-2LR-D, GBP-90-C, GBP-90-C-BF, GBP-90-C-D, GBP-90-L, GBP-90-L-BF, GBP-90-L-D, GBP-90-R, GBP-90-R-BF, GBP-90-R-D, GBR45R, GF1-45, GF1-45-BF, GF1-45-D, GF2-60, GF2-60-BF, GF2-60-D, GH-45, GH-45-BF, GH-45-D, GH-45-G, GH-45-H, GH-45-H-BF, GH-45-H-D, GH-45-H-G, GH-90, GH-90-BF, GH-90G, GH-90-H, GH-90-H-BF, GH-90-HG, GH-90IV-D, GKB-120, GKB-120-BF, GKB-120EII, GKB-150, GKB-150-BF...(Other models you can see in the webshop)		

			
1			
GEV No.	107588	Ref. No.	5004714244 AM5004714244
description	spring holder for ignition gas line L 55mm plate suitable for Ambach GH90		
For models:	GH-120, GH-40, GH-45, GH-45-BF, GH-45-D, GH-45-G, GH-45-H, GH-45-H-BF, GH-45-H-D, GH-45-H-G, GH-80, GH-90, GH-90-BF, GH-90G, GH-90-H, GH-90-H-BF, GH-90-HG, GH-90IV-D, GHE-120, GHE-80, GHG-120, GHG-80		



1

GEV No.	107590	Ref. No.	5004703314 AM5004703314
description	spring holder for temperature probe L 29mm plate suitable for Ambach		
For models:	BEW-80, BEW-85, BEW-90, BMW-70, CHE-80, EBMC-40, EBMC-80, EBMC-80-L, EBMC-80-R, EHE-70, EHE-80, EKE-70, EPE-80, EPSE-80, ERE-105, ERE-70, EREC-105, GGG-80, GHE-120, GHE-80, GHG-70, GKE-70, GPG-80, GPG-85, GPG-90, GPSE-80, GRE-105, GRE-70, GREC-105, GZE-70, HEE-81, HGG-120, HGG-80, HGG-85, HGG-90, SIE-105, SIEC-105, UBE-90, UBE-90-D, UBW-45II, UBW-45II-D, UBW-90II, UBW-90II-D, ZGG-80		

gas ball valves

with DIN-DVGW approval



1

GEV No.	520897	Ref. No.	5018014350 AM5018014350
description	ball valve straight L 72mm brass shut-off valve H 48mm W 30.6mm standard IT 1/2" ET 1/2" DVGW		
For models:	GB-90, GBK120E, GBP-45-C, GBP-45-C-BF, GBP-45-C-D, GBP-45-L, GBP-45-L-BF, GBP-45-L-D, GBP-45-R, GBP-45-R-BF, GBP-45-R-D, GBP-90-1-2LR, GBP-90-1-2LR-BF, GBP-90-1-2LR-D, GBP-90-C, GBP-90-C-BF, GBP-90-C-D, GBP-90-L, GBP-90-L-BF, GBP-90-L-D, GBP-90-R, GBP-90-R-BF, GBP-90-R-D, GBR45R, GF1-40, GF1-45, GF1-45-BF, GF1-45-D, GF2-60, GF2-60-BF, GF2-60-D, GF2-60-ECO, GH-45, GH-45-BF, GH-45-D, GH-45-G, GH-45-H, GH-45-H-BF, GH-45-H-D, GH-45-H-G, GH-90, GH-90-BF, GH-90G, GH-90-H, GH-90-H-BF, GH-90-HG, GH-90IV-D, GKB-120, GKB-120-BF, GKB-120EII...(Other models you can see in the webshop)		
accessories for	520897		
	GEV No.	520561	Ref. No. 3522914349
	butterfly handle for gas ball valve yellow metal L 45mm W 24mm H 20.5mm intake 5x8		



1

GEV No.	520326	Ref. No.	5018009540
description	ball valve straight t-handle inlet 3/4" IT outlet 3/4" IT DN20 L 80mm approval DVGW gas technology operating p. 1bar		
For models:	EBM-45, EBM-45-BF, EBM-45-D, GBP-40-C, GBP-40-L, GBP-40-R, GBP-80-1-2LR, GBP-80-C, GBP-80-L, GBP-80-R, GH-120, GH-40, GH-80, GHE-120, GHE-80, GHG-120, GHG-80, GKH-90, GKM-50, GKM-90, GLG80, GLG-80-ECOII, GPK-40, GPS-80, GPSE-80, GPSG-80, GSPG80		

gas lines

pilot tubes

producer-specific

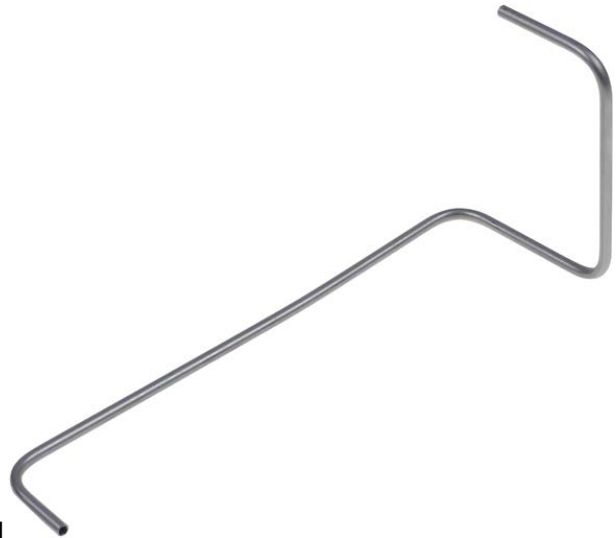

1

GEV No.	106896	Ref. No.	3000505444
description	pilot tube tube ø 4mm L 195mm SS		
For models:	HGG-120, HGG-80, HGG-85, HGG-90		

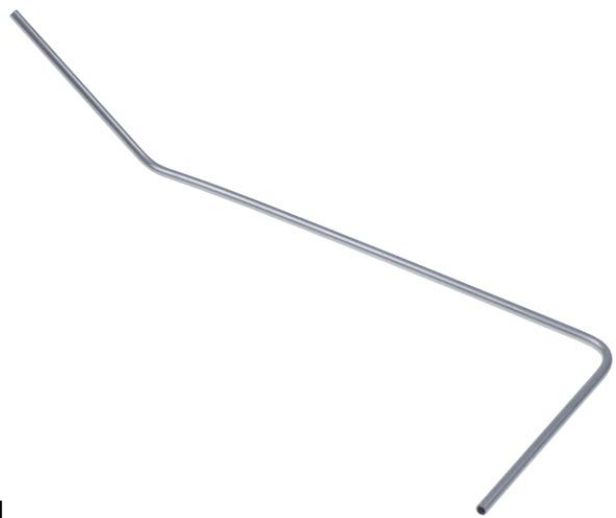

1

GEV No.	106865	Ref. No.	5000514941
description	pilot tube tube ø 4mm L 270mm SS curved		
For models:	GHG-120, GHG-80, GKG-70, GPS-80, GPSE-80, GPSG-80, GRG-105, GRG-70, GRGC-105, GSPG80, SIG-105, SIGC-105		

universal



1

GEV No.	102108	Ref. No.	3000505443
description	pilot tube SS pipe ø 4mm L 3000mm		
For models:	HGG-120, HGG-80, HGG-85, HGG-90		



pressure switches



1

GEV No.	541073	Ref. No.	5061309598 R63070010
description	pressure control ø 45mm pressure range adjustable 5-20mbar pressure connection vertical gas technology connection 1/4" pressure connection ø 1/4"mm		
For models:	GF1-45, GF1-45-BF, GF1-45-D, GF2-60, GF2-60-BF, GF2-60-D, GSK100, GSK-100-80, GSK-100-80-BF, GSK-150, GSK-150-BF, GSK-40, GSK60, GSK-60-40, GSK-60-40-BF, GSK-80, TPG-80		

equipment-specific units
for vegetable slicers

miscellaneous



1

GEV No.	110703	Ref. No.	5005607080
description	cylindrical handle thread M10 ø 28mm L 87mm		
For models:	DSK-100-80II-BF, DSK-150II, DSK-150II-BF, DSK-40, DSK-60-40II-BF, DSK-80, EKB-120, EKB-120E, EKB-120EII, EKB-120EII-BF, EKB-150, EKB-150E, EKB-150EII, EKB-150EII-BF, EKBD-125EII, EKBD-125EII-BF, EKBD-160EII, EKBD-160EII-BF, EKK-100, EKK-100-BF, EKK-100E, EKK-150, EKK-150-BF, EKK-40, EKK-40-BF, EKK-40E, ESK-100-80II-BF, ESK150, ESK-150II-BF, ESK-40, ESK-40E, ESK60, ESK-60-40II-BF, ESK-80, ESK-80E, GBK120E, GKB-120, GKB-120-BF, GKB-120EII, GKB-150, GKB-150-BF, GKB-150EII, GKS-100, GKS-150, GKS-60, GKS-80, GNKE-100, GNKE-150, GNKE-230, GSK100...(Other models you can see in the webshop)		

for cheese graters

miscellaneous



1

GEV No.	110703	Ref. No.	5005607080
description	cylindrical handle thread M10 ø 28mm L 87mm		
For models:	DSK-100-80II-BF, DSK-150II, DSK-150II-BF, DSK-40, DSK-60-40II-BF, DSK-80, EKB-120, EKB-120E, EKB-120EII, EKB-120EII-BF, EKB-150, EKB-150E, EKB-150EII, EKB-150EII-BF, EKBD-125EII, EKBD-125EII-BF, EKBD-160EII, EKBD-160EII-BF, EKK-100, EKK-100-BF, EKK-100E, EKK-150, EKK-150-BF, EKK-40, EKK-40-BF, EKK-40E, ESK-100-80II-BF, ESK150, ESK-150II-BF, ESK-40, ESK-40E, ESK60, ESK-60-40II-BF, ESK-80, ESK-80E, GBK120E, GKB-120, GKB-120-BF, GKB-120EII, GKB-150, GKB-150-BF, GKB-150EII, GKS-100, GKS-150, GKS-60, GKS-80, GNKE-100, GNKE-150, GNKE-230, GSK100...(Other models you can see in the webshop)		

for deep fryers

housing and bezels



1

GEV No.	697874	Ref. No.	5000811199
description	cap L 69mm W 61mm H 13mm rectangular plastic		
For models:	EF1-40, EF1-45, EF1-45-BF, EF1-45-D, EF2-40, EF2-45, EF2-45-BF, EF2-45-D, EY1-40M, EY2-40M, EY-35M		



1

GEV No.	697875	Ref. No.	5000811198
description	cap ø 54mm H 10mm plastic		
For models:	EF1-40, EF1-45, EF1-45-BF, EF1-45-D, EF2-40, EF2-45, EF2-45-BF, EF2-45-D, EY1-40M, EY2-40M, EY-35M		

for griddles

sumps



1

GEV No.	696598	Ref. No.	3512611800 AM3512611800
description	grease collecting tray L 150mm W 180mm H 113mm		
For models:	EBP-45-C, EBP-45-C-BF, EBP-45-C-D, EBP-45-L, EBP-45-L-BF, EBP-45-L-D, EBP-45-R, EBP-45-R-BF, EBP-45-R-D, EBP-90-1-2LR, EBP-90-1-2LR-BF, EBP-90-C, EBP-90-C-BF, EBP-90-C-D, EBP-90-L, EBP-90-L-BF, EBP-90-L-D, EBP-90-LR, EBP-90-R, EBP-90-R-BF, EBP-90-R-D, EP-45, EP-45-BF, EP-90, EP-90-BF, EP-90-D, GBP-45-C, GBP-45-C-BF, GBP-45-C-D, GBP-45-L, GBP-45-L-BF, GBP-45-L-D, GBP-45-R, GBP-45-R-BF, GBP-45-R-D, GBR45R, GP-45, GP-45-BF, GP-45-D		

for convection ovens/combi-steamers

cleaning system

nozzles



GEV No.	550864	Ref. No.	R62210042
description	nozzle flow rate 0.56l/min for combi-steamer		



GEV No.	550865	Ref. No.	R62210032
description	nozzle flow rate 1.3l/min for combi-steamer		

coupling bushings



GEV No.	550863	Ref. No.	R58004980
description	bush for wash arm		

vibration pumps



GEV No.	500568	Ref. No.	R65110600
description	vibration pump 230V 32W 50Hz inlet \varnothing 7 outlet \varnothing 1/8" IT CEME type E512/A32		

spare parts for

GEV No.	390698	Ref. No.	—
description	thermal fuse switch-off temp. 110°C suitable for ULKA pump		

GEV No.	520153	Ref. No.	—
description	bracket rubber dimensions 53x34x28mm		

miscellaneous



GEV No.	690099	Ref. No.	R58002150
description	hinge pin mounting pos. upper for door		

for tilting bratt pans

gearboxes



GEV No.	693222	Ref. No.	5026905539 5026927019
description	gearbox		
For models:	KBHE-70-R, KBHG-70-R, TPE-80, TPG-80		



GEV No.	693223	Ref. No.	5026904330 5026927020 AM5026927020
description	gearbox transmission 1/80 type RMI 50I		
For models:	EKH-90, GKH-90, KHE-90, KHG-90, KSKE-100, KSKE-50		

miscellaneous



GEV No.	697876	Ref. No.	5014517336
description	handle L 100mm W 32mm square shaft 8x8mm		
For models:	EKBD-125EII, EKBD-125EII-BF, EKBD-160EII, EKBD-160EII-BF		



for boiling pans

gearboxes



1

GEV No.	693223	Ref. No.	5026904330 5026927020 AM5026927020
description	gearbox transmission 1/80 type RMI 501		
For models:	EKH-90, GKX-90, KHE-90, KHG-90, KSKE-100, KSKE-50		

miscellaneous



1

GEV No.	693252	Ref. No.	3501129637 5001109945
description	spindle for lid		
For models:	DSK-100-80II-BF, DSK-150II, DSK-150II-BF, DSK-40, DSK-60-40II-BF, DSK-80, EKK-150, EKK-150-BF, ESK-100-80II-BF, ESK150, ESK-150II-BF, ESK-40, ESK-40E, ESK60, ESK-60-40II-BF, ESK-80, ESK-80E, GKS-100, GKS-150, GKS-60, GKS-80, GNKD100, GNKD-150II, GNKD-150II-BF, GNKD-230II, GNKD-230II-BF, GNKD-90II-BF, GNKE-100, GNKE-150, GNKE-230, GSK100, GSK-100-80, GSK-100-80-BF, GSK-150, GSK-150-BF, GSK-40, GSK60, GSK-60-40, GSK-60-40-BF, GSK-80		

knobs

universal knobs



1

GEV No.	111860	Ref. No.	5022914334
description	knob thermostat t.max. 110°C ø 50mm shaft ø 6x4.6mm shaft flat upper black temperature range 30-110°C rotation 310°		
For models:	UBW-45II, UBW-45II-D		

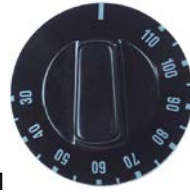

1

GEV No.	111581	Ref. No.	5022914334
description	knob thermostat t.max. 110°C ø 50mm shaft ø 6x4.6mm shaft flat upper black temperature range 30-110°C		

producer-specific knobs

AMBACH



1

GEV No.	110394	Ref. No.	5022908981
description	knob gas tap with ignition flame t.max.°C ø 52mm shaft ø 10x8mm shaft flat left black		
For models:	GK-70, GKE-70, GKG-70		



1

GEV No.	110350	Ref. No.	5022908971
description	knob gas tap with ignition flame t.max.°C ø 52mm shaft ø 8x6.5mm shaft flat left black		
For models:	GR-105, GR-35, GRE-105, GRE-70, GREC-105, GRG-105, GRG-70, GRGC-105, SI-105, SIE-105, SIEC-105, SIG-105, SIGC-105		



1

GEV No.	110351	Ref. No.	5022908973
description	knob gas thermostat 1-8 t.max.°C ø 52mm shaft ø 10x8mm shaft flat right black		
For models:	GRG-70, GUG-40, GUG-40-V, GUG-70, GUG-70-V		



1

GEV No.	110356	Ref. No.	5022901044
description	knob switch 4-position t.max.°C°C ø 52mm shaft ø 6x4.6mm shaft flat lower black		
For models:	BPE-50, CPE-35, CPE-70, ER-105, ER-35, ER-70, ERE-105, ERE-70, EREC-105		



1

GEV No.	110369	Ref. No.	5022901048
description	knob thermostat t.max. 300°C 50-300°C ø 52mm shaft ø 6x4.6mm shaft flat lower black temperature range 50-300°C		
For models:	EKE-70, ERE-105, ERE-70, EREC-105, GKE-70, GRE-105, GRE-70, GREC-105, GUE-40, GUE-40-B, GUE-40-C, GUE-70, GUE-70-1-2LR, GUE-70-B, GUE-70-C, GUE-S-40, GUE-S-70, SIE-105, SIEC-105, TPE-80, TPG-80		



1

GEV No.	110359	Ref. No.	5022901045
description	knob switch 7-position t.max.°C°C ø 52mm shaft ø 6x4.6mm shaft flat lower black		
For models:	ER-105, ER-70, ERE-105, ERE-70, EREC-105		



1

GEV No.	110393	Ref. No.	5022902024
description	knob		
For models:	GHG-70, GZE-70		



1

GEV No.	110392	Ref. No.	5022908977
description	knob thermostat 1-8 t.max.°C°C ø 52mm shaft ø 6x4.6mm shaft flat lower black		
For models:	EK-40, EK-70, EKE-70		

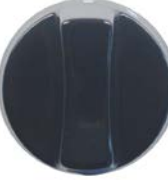

1

GEV No.	111570	Ref. No.	5022906228 5022908810
description	knob gas tap with ignition flame t.max.°C°C ø 64mm shaft ø 10x8mm shaft flat upper black		
For models:	CPG-40, GH-120, GH-40, GH-80, GHE-120, GHE-80, GHG-120, GHG-80, GLG40CP, GLG70, GLG80, GLG-80-ECOII, GPK-40, GPS-80, GPSE-80, GPSG-80, GSPG80, K7G-35, K7G-50, KKG100		



1

GEV No.	110367	Ref. No.	5022901046
description	knob thermostat t.max. 110°C 30-110°C ø 52mm shaft ø 6x4.6mm shaft flat lower		
For models:	BPE-50, BPG-50, BU-35, BU-70, BUC-35, BUC-70, BUC-70-L, BUC-70-R		



1

GEV No.	110051	Ref. No.	5022904344
description	knob gas tap with ignition flame t.max.°C°C ø 64mm shaft ø 8x6.5mm shaft flat left black		
For models:	GGG-80, HGG-120, HGG-80, HGG-85, HGG-90, ZGG-80		



1

GEV No.	110368	Ref. No.	5022901047
description	knob thermostat t.max. 200°C 110-200°C ø 52mm shaft ø 6x4.6mm shaft flat lower black temperature range 110-200°C rotation 270°		



1

GEV No.	110355	Ref. No.	5022904381
description	knob gas thermostat EGA 1-8 t.max.°C°C ø 64mm shaft ø 8x6.5mm shaft flat left black		
For models:	GBP-70-V, GG-80-V		



			
1			
GEV No.	110094	Ref. No.	5022904331
description	knob gas thermostat t.max. 300°C 160-300°C ø 64mm shaft ø 8x6.5mm shaft flat left black		
For models:	GGG-80, GPG-80, GPG-85, GPG-90, HGG-120, HGG-80, HGG-85, HGG-90, KHG-90, KMG-50, ZGG-80		

			
1			
GEV No.	111583	Ref. No.	5022909977
description	knob thermostat t.max. 190°C ø 63mm shaft ø 6x4.6mm shaft flat lower black temperature range 110-190°C rotation 270°		
For models:	EF1-40, EF2-40		

			
1			
GEV No.	110395	Ref. No.	5022902025 5022904345
description	knob switch 4-position t.max. °C ø 64mm shaft ø 6x4.6mm shaft flat lower black		
For models:	BMW-70, EF-40, EH-40, EH-80, EHE-70, EHE-80, EKP40, EPK-40, HEE-81, K7E-35, K7E-50, KKE-100, KSKE-100, KSKE-50		

			
1			
GEV No.	110106	Ref. No.	5022904314
description	knob thermostat t.max. 200°C ø 64mm shaft ø 6x4.6mm shaft flat lower black temperature range 110-200°C rotation 270°		
For models:	FE2-40, GF-40		

			
1			
GEV No.	110396	Ref. No.	5022904341
description	knob switch 7-position ø 64mm shaft ø 6x4.6mm shaft flat lower black		
For models:	EHE-70, HEE-81		

			
1			
GEV No.	110134	Ref. No.	5022904315
description	knob thermostat t.max. 300°C ø 64mm shaft ø 6x4.6mm shaft flat lower black temperature range 50-300°C		
For models:	BUE-40, BUE-70, CHE-80, EBP-40-C, EBP-40-L, EBP-40-R, EBP-80-1-2LR, EBP-80-C, EBP-80-L, EBP-80-R, EHE-80, EKH-90, EKM-50, EKM-90, EPE-80, EPSE-80, EUB-40, EUB-60-ECO, GHE-120, GHE-80, GPSE-80, GZE-70, HEE-81, KBHE-70-R, KHE-90, KME-50, TPE-80, TPG-80		

			
1			
GEV No.	111577	Ref. No.	5022908120
description	knob thermostat 1-8 ø 63mm shaft ø 6x4.6mm shaft flat lower black		
For models:	CH-40, CH-80, CHE-80, CHT-40, CHT-80, EPE-80, EPS-40, EPS-80, EPSE-80, IHE-40, IHF4-80		

			
1			
GEV No.	111575	Ref. No.	5022914032
description	knob without symbol ø 72mm shaft ø 10x8mm shaft flat left black		
For models:	GH-45, GH-45-BF, GH-45-D, GH-45-G, GH-45-H, GH-45-H-BF, GH-45-H-D, GH-45-H-G, GH-90, GH-90-BF, GH-90G, GH-90-H, GH-90-H-BF, GH-90-HG, GH-90IV-D, GLG-45II, GLG-45II-D, GLG-90-BF, GLG-90II-D, GP-45, GP-45-BF, GP-45-D, GP-90, GP-90-BF, GP-90-D, GUK-45II, GUK-45II-BF, GUK-45II-D		

			
1			
GEV No.	110099	Ref. No.	5022904313
description	knob thermostat t.max. 110°C 30-110°C ø 64mm shaft ø 6x4.6mm shaft flat lower black		
For models:	BEW-80, BEW-85, BEW-90, EBM-40, EBM-80, EBMC-40, EBMC-80, EBMC-80-L, EBMC-80-R, GKS-100, GKS-150, GKS-60, GKS-80, K7E-35, K7E-50		

1

GEV No.	111581	Ref. No.	5022914334
description	knob thermostat t.max. 110°C ø 50mm shaft ø 6x4.6mm shaft flat upper black temperature range 30-110°C		



1

GEV No.	111860	Ref. No.	5022914334
description	knob thermostat t.max. 110°C ø 50mm shaft ø 6x4.6mm shaft flat upper black temperature range 30-110°C rotation 310°		
For models:	UBW-45II, UBW-45II-D		



1

GEV No.	111448	Ref. No.	3522913488 5022914522
description	knob zero mark t.max. °C ø 36.5mm shaft ø 8mm shaft flat black		
For models:	GB-90, GBK120E, GBP-45-C, GBP-45-C-BF, GBP-45-C-D, GBP-45-L, GBP-45-L-BF, GBP-45-L-D, GBP-45-R, GBP-45-R-BF, GBP-45-R-D, GBP-90-1-2LR, GBP-90-1-2LR-BF, GBP-90-1-2LR-D, GBP-90-C, GBP-90-C-BF, GBP-90-C-D, GBP-90-L, GBP-90-L-BF, GBP-90-L-D, GBP-90-R, GBP-90-R-BF, GBP-90-R-D, GBR45R, GF1-45, GF1-45-BF, GF1-45-D, GF2-60, GF2-60-BF, GF2-60-D, GH-45, GH-45-BF, GH-45-D, GH-45-G, GH-45-H, GH-45-H-BF, GH-45-H-D, GH-45-H-G, GH-90, GH-90-BF, GH-90G, GH-90-H, GH-90-H-BF, GH-90-HG, GH-90IV-D, GKB-120, GKB-120-BF, GKB-120EII, GKB-150, GKB-150-BF...(Other models you can see in the webshop)		

accessories

gaskets



1

GEV No.	550676	Ref. No.	5017314030
description	gasket knob D1 ø 64mm D2 ø 54mm equiv. no. 5017314030 suitable for Ambach		
For models:	7EBP-40-L, 7EBP-60-C, CH-45, CH-45-BF, CH-45-D, CH-45-T, CH-45-T-BF, CH-45-T-D, EBM-45, EBM-45-BF, EBM-45-D, EBP-45-C, EBP-45-C-BF, EBP-45-C-D, EBP-45-L, EBP-45-L-BF, EBP-45-L-D, EBP-45-R, EBP-45-R-BF, EBP-45-R-D, EBP-90-1-2LR, EBP-90-1-2LR-BF, EBP-90-C, EBP-90-C-BF, EBP-90-C-D, EBP-90-L, EBP-90-L-BF, EBP-90-L-D, EBP-90-LR, EBP-90-R, EBP-90-R-BF, EBP-90-R-D, EF1-45, EF1-45-BF, EF1-45-D, EF2-45, EF2-45-BF, EF2-45-D, EH-45, EH-45-BF, EH-45-D, EH-90, EH-90-BF, EH-90-D, EKB-120, EKB-150, EKK-100, EKK-100-BF, EKK-150, EKK-150-BF...(Other models you can see in the webshop)		

knob screws



1

GEV No.	110066	Ref. No.	3009600005
description	knob screw		
For models:	GPG-80, GPG-85, GPG-90, KBHG-70-R		

handles and hand wheels

hand wheels

hand wheels



1

GEV No.	690852	Ref. No.	2020100286 5020121470
description	hand wheel ø 175mm D1 ø 40mm bore ø 20mm depth of bore 30mm thread M8 hole distance 7mm groove widthmm L1 40mm L2 55mm handle length 82mm with folding handle		
For models:	EKH-90, GKH-90, KHE-90, KHG-90, KSKE-100, KSKE-50		
spare parts for	690852		
	GEV No.	Ref. No.	—
	 folding handle ø 28mm total length 110mm seat ø 26mm shaft ømm thread M6 with pin L 110mm		

cylindrical handles

fixed



1

GEV No.	111597	Ref. No.	5005607354
description	cylindrical handle thread M10 ø 23mm L 65mm		
For models:	BPE-50, BPG-50, KKE-100, KKG100		

			
1			
GEV No.	110703	Ref. No.	5005607080
description	cylindrical handle thread M10 ø 28mm L 87mm		
For models:	DSK-100-80II-BF, DSK-150II, DSK-150II-BF, DSK-40, DSK-60-40II-BF, DSK-80, EKB-120, EKB-120E, EKB-120EII, EKB-120EII-BF, EKB-150, EKB-150E, EKB-150EII, EKB-150EII-BF, EKBD-125EII, EKBD-125EII-BF, EKBD-160EII, EKBD-160EII-BF, EKK-100, EKK-100-BF, EKK-100E, EKK-150, EKK-150-BF, EKK-40, EKK-40-BF, EKK-40E, ESK-100-80II-BF, ESK150, ESK-150II-BF, ESK-40, ESK-40E, ESK60, ESK-60-40II-BF, ESK-80, ESK-80E, GBK120E, GKB-120, GKB-120-BF, GKB-120EII, GKB-150, GKB-150-BF, GKB-150EII, GKS-100, GKS-150, GKS-60, GKS-80, GNKE-100, GNKE-150, GNKE-230, GSK100...(Other models you can see in the webshop)		

door handles

door handles

			
1			
GEV No.	692751	Ref. No.	5005608875 AM5005608875
description	handle L 167mm W 60mm H 45mm M6 mounting distance 150mm		
For models:	BUC-70, CPE-70, EKE-70, ERE-70, EY2-40-E, GRG-70, GY-40		

hand cranks

			
1			
GEV No.	693221	Ref. No.	2005600284 5005622442
description	hand crank bore ø 12mm L 80mm with folding handle		
For models:	KBHE-70-R, KBHG-70-R, TPE-80, TPG-80		

miscellaneous

			
1			
GEV No.	697876	Ref. No.	5014517336
description	handle L 100mm W 32mm square shaft 8x8mm		
For models:	EKBD-125EII, EKBD-125EII-BF, EKBD-160EII, EKBD-160EII-BF		

accessories

extensions

			
1			
GEV No.	697949	Ref. No.	3001106215
description	extension for hood handle L 101mm thread M10x1.5		
For models:	BPE-50, BPG-50, DSK-100-80II-BF, DSK-150II, DSK-150II-BF, DSK-40, DSK-60-40II-BF, DSK-80, EKK-100E, EKK-150, EKK-150-BF, EKK-40, EKK-40-BF, EKK-40E, ESK-100-80II-BF, ESK150, ESK-150II-BF, ESK-40, ESK60, ESK-60-40II-BF, ESK-80, GKS-100, GKS-150, GKS-60, GKS-80, GSK100, GSK-100-80, GSK-100-80-BF, GSK-150, GSK-150-BF, GSK-40, GSK60, GSK-60-40, GSK-60-40-BF, GSK-80, KKE-100, KKG100		

locks

handle latches

producer-specific

AMBACH

			
1			
GEV No.	690337	Ref. No.	R69010630
description	cover L 39.5mm ø 55.5mm		

			
1			
GEV No.	694067	Ref. No.	R69010260
description	door catch with spigot 1-stage L 26mm total length 51mm thread M8		



			
1			
GEV No.	690339	Ref. No.	R69010270
description	door catch with spigot 2-stage L 30mm H 17mm H1 18mm total length 55mm thread M8 thread L 20mm stainless steel		

			
1			
GEV No.	690336	Ref. No.	LA69010440 R69010250
description	door handle L 195mm H 60mm mounting distance 40mm spring length 46mm ø 60mm black plastic round		
spare parts for	690336		
	GEV No.	514390	Ref. No. R61620132
	spring for door handle ø 6mm L 54mm W 27.5mm		
	GEV No.	691666	Ref. No. —
	catch clamp length 46mm BL 31mm for off-set 59-69mm		
accessories for	690336		
	GEV No.	690337	Ref. No. R69010630
	cover L 39.5mm ø 55.5mm		
	GEV No.	690339	Ref. No. R69010270
	door catch with spigot 2-stage L 30mm H 17mm H1 18mm total length 55mm thread M8 thread L 20mm stainless steel		
	GEV No.	694067	Ref. No. R69010260
	door catch with spigot 1-stage L 26mm total length 51mm thread M8		

			
1			
GEV No.	514390	Ref. No.	R61620132
description	spring for door handle ø 6mm L 54mm W 27.5mm		

hinges

spring assisted hinges

producer-specific

AMBACH

			
1			
GEV No.	700653	Ref. No.	2012000292
description	spring assisted hinge L 71mm mounting distance 25mm mounting measurements 22x22mm mounting pos. right/left		
For models:	BEW-80, BEW-85, BEW-90, EF1-45, EF1-45-D, EF2-45, EF2-45-D, FE2-40, FE2-40-E, FE2-80-E, FG1-40, GF1-45, GF1-45-D, GF2-60, GF2-60-BF, GF2-60-D, UBW-45II, UBW-45II-D, UBW-90II, UBW-90II-D		

oven hinges

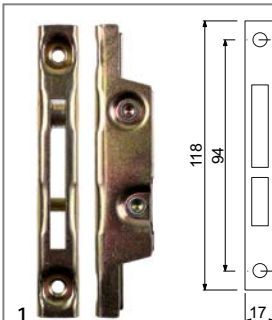

			
1			
GEV No.	700401	Ref. No.	3512016350
description	bearing left oven hinge		
For models:	GB-90, UBE-90, UBE-90-D, UBED-90-D		

			
1			
GEV No.	700400	Ref. No.	3512016349
description	bearing right oven hinge		
For models:	GB-90, UBE-90, UBE-90-D, UBED-90-D		





GEV No.	700001	Ref. No.	5006302092
description	opposite support L 118mm W 17mm mounting distance 94mm		
For models:	CHE-80, EHE-70, EHE-80, EKE-70, EPE-80, EPSE-80, ERE-105, ERE-70, EREC-105, GGG-80, GHE-120, GHE-80, GHG-120, GHG-70, GHG-80, GKE-70, GKG-70, GPG-80, GPG-85, GPG-90, GPSE-80, GPSG-80, GRE-105, GRE-70, GREC-105, GRG-105, GRG-70, GRGC-105, GSPG80, GZE-70, HEE-81, HGG-120, HGG-80, HGG-85, HGG-90, SIE-105, SIEC-105, SIG-105, SIGC-105, ZGG-80		

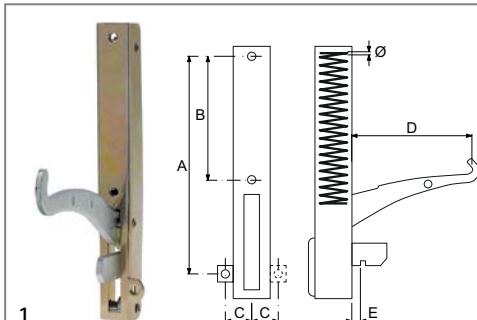

GEV No.	700006	Ref. No.	5012002196
description	oven hinge mounting distance 173mm mounting distance 2 105mm lug mounting 14mm lever length 120mm groove distance 11mm spring thickness 3.5mm mounting ear position left spring length 112mm W 25mm		
For models:	CHE-80, EHE-70, EHE-80, EKE-70, EPE-80, EPSE-80, ERE-105, ERE-70, EREC-105, GGG-80, GHE-120, GHE-80, GHG-120, GHG-70, GHG-80, GKE-70, GKG-70, GPG-80, GPG-85, GPG-90, GPSE-80, GPSG-80, GRE-105, GRE-70, GREC-105, GRG-105, GRG-70, GRGC-105, GSPG80, GZE-70, HEE-81, HGG-120, HGG-80, HGG-85, HGG-90, SIE-105, SIEC-105, SIG-105, SIGC-105, ZGG-80		
accessories for	700006		
		GEV No.	700001
		Ref. No.	5006302092
	opposite support L 118mm W 17mm mounting distance 94mm		
		GEV No.	700007
		Ref. No.	5012002108
	oven hinge mounting distance 173mm mounting distance 2 105mm lug mounting 14mm lever length 120mm groove distance 11mm spring thickness 3.5mm mounting ear position right spring length 112mm W 25mm		



GEV No.	700007	Ref. No.	5012002108
description	oven hinge mounting distance 173mm mounting distance 2 105mm lug mounting 14mm lever length 120mm groove distance 11mm spring thickness 3.5mm mounting ear position right spring length 112mm W 25mm		
For models:	CHE-80, EHE-70, EHE-80, EKE-70, EPE-80, EPSE-80, ERE-105, ERE-70, EREC-105, GGG-80, GHE-120, GHE-80, GHG-120, GHG-70, GHG-80, GKE-70, GKG-70, GPG-80, GPG-85, GPG-90, GPSE-80, GPSG-80, GRE-105, GRE-70, GREC-105, GRG-105, GRG-70, GRGC-105, GSPG80, GZE-70, HEE-81, HGG-120, HGG-80, HGG-85, HGG-90, SIE-105, SIEC-105, SIG-105, SIGC-105, ZGG-80		
accessories for	700007		
		GEV No.	700001
		Ref. No.	5006302092
	opposite support L 118mm W 17mm mounting distance 94mm		



GEV No.	700402	Ref. No.	3031414396
description	spacer ring for pivot bearing		
For models:	GB-90, UBE-90, UBE-90-D, UBED-90-D		

door bearing



GEV No.	690586	Ref. No.	R11200560
description	hinge bearing mounting pos. upper left without bolt		



GEV No.	690099	Ref. No.	R58002150
description	hinge pin mounting pos. upper for door		



accessories

miscellaneous



1

GEV No.	690595	Ref. No.	R58002550
description	bush for door hinge		



1

GEV No.	690592	Ref. No.	R58002540
description	pin for hinge		



1

GEV No.	690593	Ref. No.	R58002570
description	plain washer ID ø 15mm ED ø 30mm thickness 3mm Qty 1 pcs for door hinge		



1

GEV No.	690594	Ref. No.	R58002560
description	pressure screw for door hinge		

fittings for catering equipment

aerators and air bleeders

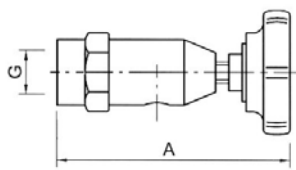
1

GEV No.	540013	Ref. No.	5018107460	
description	aerator and air bleeder thread 3/8" ET WS 27 chrome-plated L 86mm			
For models:	KSKE-100, KSKE-50			
spare parts for	540013			
	GEV No.	112777	Ref. No.	—
	star handle shaft 6x6mm ø 50mm L 18mm black plastic			
	GEV No.	540365	Ref. No.	—
	star handle shaft 6x6mm ø 50mm L 18mm black thermoplastic			



1

GEV No.	540011	Ref. No.	5018107456
description	aerator and air bleeder thread 1/2" ET chrome-plated brass metal seated L 42mm ø 26mm		
For models:	BPE-50, BPG-50, GKS-100, GKS-150, GKS-60, GKS-80		



1

GEV No.	540949	Ref. No.	5018117691 5018118130
description	aerator and air bleeder thread 1/2" ET chrome-plated with O-ring L 15mm ø 25mm		
For models:	EKBD-125EII, EKBD-125EII-BF, EKBD-160EII, EKBD-160EII-BF		

drain taps

brass

drain taps



1

GEV No.	548001	Ref. No.	5018007363 5018013159 5018019217	
description	drain tap 1 1/2" IT O-ring seal kettle connection with union nut A 80mm B1 68mm B2 132mm			
spare parts for	548001			
	GEV No.	505092	Ref. No.	5017319224
	O-ring EPDM thickness 5.34mm ID ø 43.82mm Qty 1 pcs			
	GEV No.	540213	Ref. No.	—
	handle ID ø 5mm L 117mm			





1

GEV No.	540267	Ref. No.	5018016320 5018018815
description	drain tap connection with union nut thread 2"		
For models:	GNKD100, GNKD-150II, GNKD-150II-BF, GNKD-230II, GNKD-230II-BF, GNKD-90II-BF, GNKE-100, GNKE-150, GNKE-230		
spare parts for	540267		
	GEV No.	505517	Ref. No. —
	O-ring EPDM thickness 5.34mm ID ø 53.34mm Qty 1 pcs		
	GEV No.	540214	Ref. No. —
	handle ID ø 6mm L 145mm		



1

GEV No.	540925	Ref. No.	5018013159
description	drain tap IT 1 1/2" connection fixed		
spare parts for	540925		
	GEV No.	505092	Ref. No. 5017319224
	O-ring EPDM thickness 5.34mm ID ø 43.82mm Qty 1 pcs		
	GEV No.	540213	Ref. No. —
	handle ID ø 5mm L 117mm		

steam traps

steam traps

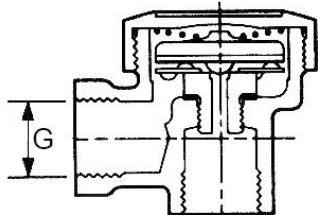



1

GEV No.	540779	Ref. No.	5018117567
description	thermostatic steam trap thread 1/2" type BPT13AX brass		
For models:	DSK-100-80II-BF, DSK-150II, DSK-150II-BF, DSK-40, DSK-60-40II-BF, DSK-80, EKK-100, EKK-100-BF, EKK-100E, EKK-150, EKK-150-BF, EKK-40, EKK-40-BF, EKK-40E, ESK-100-80II-BF, ESK150, ESK-150II-BF, ESK-40, ESK-40E, ESK60, ESK-60-40II-BF, ESK-80, ESK-80E, GNKD100, GNKD-150II, GNKD-150II-BF, GNKD-230II, GNKD-230II-BF, GNKD-90II-BF, GNKE-100, GNKE-150, GNKE-230, GSK100, GSK-100-80, GSK-100-80-BF, GSK-150, GSK-150-BF, GSK-40, GSK60, GSK-60-40, GSK-60-40-BF, GSK-80		

test taps

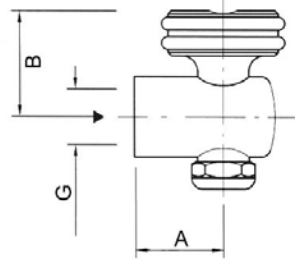
test taps

1

GEV No.	540080	Ref. No.	5018000055
description	test tap thread 3/8" IT W 40mm W1 30mm		
For models:	BPE-50, BPG-50, GKS-100, GKS-150, GKS-60, GKS-80, K7E-35, K7E-50, K7G-35, K7G-50, KKE-100, KKG100, KSKE-100, KSKE-50		
spare parts for	540080		
	GEV No.	505152	Ref. No. —
	O-ring EPDM thickness 3.53mm ID ø 29mm Qty 1 pcs		



safety fittings

safety fittings



1				
GEV No.	540920	Ref. No.	5018007443	
description	safety fitting thread 1" 0.5bar 140kg/h thread size manometer 1/4"-1/2" w/ bleeder/aerator on the right, funnel left chrome-plated H 188mm W 175mm			
For models:	GKS-100, GKS-150, GKS-60, GKS-80, K7E-35, K7E-50, K7G-35, K7G-50, KKE-100, KKG100			
spare parts for	540920			
	GEV No.	540011	Ref. No.	5018107456
	aerator and air bleeder thread 1/2" ET chrome-plated brass metal seated L 42mm ø 26mm			
	GEV No.	540320	Ref. No.	—
	ball handle thread M5 ø 20mm with metal bush			
	GEV No.	540322	Ref. No.	—
	ball handle thread M8 ø 32mm with metal bush			
	GEV No.	540926	Ref. No.	5018107459
	filling funnel thread 3/8" for safety fitting			
accessories for	540920			
	GEV No.	541062	Ref. No.	5027207356 5027213795
	manometer ø 63mm pressure range 0 up to 1bar connection marking adjustable kettle thread 1/4"			



1				
GEV No.	540911	Ref. No.	5018017524 5018018147	
description	safety fitting thread 1 1/2" 0.5bar			
For models:	EKBD-125EII, EKBD-125EII-BF, EKBD-160EII, EKBD-160EII-BF			
spare parts for	540911			
	GEV No.	540949	Ref. No.	5018117691 5018118130
	aerator and air bleeder thread 1/2" ET chrome-plated with O-ring L 15mm ø 25mm			



1				
GEV No.	540921	Ref. No.	5018015600	
description	safety fitting thread 3/4" 0.5bar 130kg/h with connecting thread 1/8" for filling device brass H 137mm			
For models:	EKK-100, EKK-100-BF, EKK-100E, EKK-150, EKK-150-BF, EKK-40, EKK-40-BF, EKK-40E, ESK-100-80II-BF, ESK150, ESK-150II-BF, ESK-40, ESK-40E, ESK60, ESK-60-40II-BF, ESK-80, ESK-80E, GNKE-100, GNKE-150, GNKE-230, GSK100, GSK-100-80, GSK-100-80-BF, GSK-150, GSK-150-BF, GSK-40, GSK60, GSK-60-40, GSK-60-40-BF, GSK-80			

accessories



1				
GEV No.	540926	Ref. No.	5018107459	
description	filling funnel thread 3/8" for safety fitting			
For models:	KSKE-100, KSKE-50			

safety valves



1				
GEV No.	540923	Ref. No.	5018107454	
description	safety valve T1: 1/2" T2: 1" angled			
For models:	BPE-50, BPG-50, KSKE-100, KSKE-50			

baskets

fryer baskets

AMBACH



1				
GEV No.	970382	Ref. No.	5020811177	
description	fryer basket L1 330mm W1 140mm H1 125mm L2 500mm H3 300mm chrome-plated steel			
For models:	EF1-40, EF1-45, EF1-45-BF, EF1-45-D, EF2-40, EF2-45, EF2-45-BF, EF2-45-D, EY1-40M, EY2-40M, EY-35M, GF1-40, GF1-45, GF1-45-BF, GF1-45-D, GY1-40			



1

GEV No.	970383	Ref. No.	5020810956
description	fryer basket L1 330mm W1 220mm H1 140mm L2 500mm H2 170mm H3 300mm chrome-plated steel		
For models:	GF2-60, GF2-60-BF, GF2-60-D, GF2-60-ECO, GY2-70		



1

GEV No.	970381	Ref. No.	5020804334
description	fryer basket L1 360mm W1 140mm H1 110mm		
For models:	FE2-40, FE2-40-E, FE2-80-E, FG1-40, GF-40, GY-40		



1

GEV No.	970146	Ref. No.	5020802413
description	fryer basket L1 360mm W1 145mm H1 110mm chrome-plated steel angled		
For models:	EF2-40-E, EF-40, EY2-40-E		

pasta baskets

AMBACH



1

GEV No.	970379	Ref. No.	5020800296
description	pasta basket L1 160mm W1 140mm H1 175mm size GN 1/6 H3 287mm stainless steel left		
For models:	CPE-35, CPE-70, CPG-40, EKP40, EPK-40, GPK-40, GUK-45II, GUK-45II-BF, GUK-45II-D		



1

GEV No.	970378	Ref. No.	5020801594
description	pasta basket L1 160mm W1 290mm H1 175mm size GN 1/3 H3 280mm stainless steel		
For models:	CPE-35, CPE-70, CPG-40, EKP40, EPK-40, EUK-45II, EUK-45II-BF, EUK-45II-D, GPK-40, GUK-45II, GUK-45II-BF, GUK-45II-D		

crumb screens

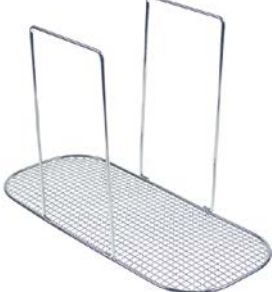

1

GEV No.	970922	Ref. No.	5010111158 AM5010111158
description	crumb screen L 350mm W 150mm H 235mm suitable for Ambach		
For models:	EF1-45-BF, EF2-40, EF2-45, EF2-45-BF, EF2-45-D, EY2-40M, EY-35M		



1

GEV No.	970923	Ref. No.	5010111159 AM5010111159
description	crumb screen L 350mm W 334mm H 235mm suitable for Ambach		
For models:	EF1-40, EF1-45, EF1-45-D, EY1-40M		



gaskets

refrigeration gaskets

screw-in gaskets

profile 9955

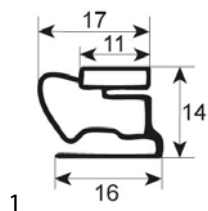

GEV No.	900535	Ref. No.	5017301890
description	refrigeration gasket profile 9955 W 207mm L 388mm external size		

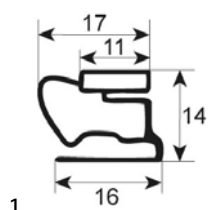

GEV No.	900534	Ref. No.	5017301889
description	refrigeration gasket profile 9955 W 317mm L 388mm external size		

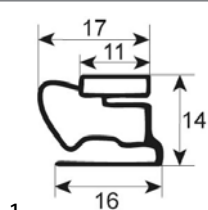

GEV No.	900533	Ref. No.	5017301887
description	refrigeration gasket profile 9955 W 388mm L 647mm external size		

profile 9207

We offer custom-made gaskets for this profile

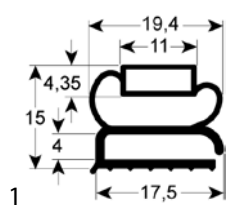

GEV No.	900538	Ref. No.	5017304542
description	refrigeration gasket profile 9207 W 210mm L 373mm external size		

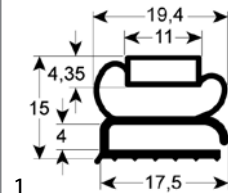

GEV No.	900537	Ref. No.	5017304541
description	refrigeration gasket profile 9207 W 373mm L 430mm external size		

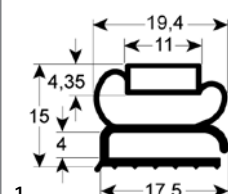

GEV No.	900536	Ref. No.	5017304540
description	refrigeration gasket profile 9207 W 373mm L 650mm external size		

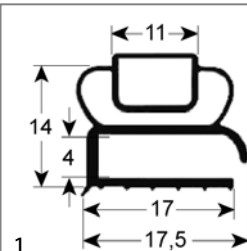

GEV No.	902277	Ref. No.	N/A
description	refrigeration gasket profile 9207 Wmm L 2500mm		

gaskets for heated units

window seals

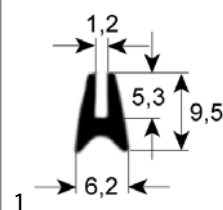

GEV No.	900483	Ref. No.	R70044150
description	window gasket profile 1530 L 2400mm Qty 1		

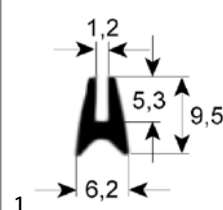

GEV No.	900484	Ref. No.	R70044160
description	window gasket profile 1530 L 3720mm Qty 1		

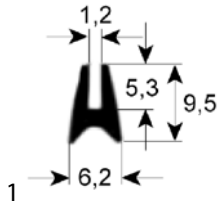

GEV No.	900637	Ref. No.	R70040640
description	window gasket profile 1530 Qty supplied by meter		

door seals



GEV No.	900494	Ref. No.	R70044140
description	door seal profile 2770/2771 H 1550mm W 700mm outer plug size Qty 1		



GEV No.	900492	Ref. No.	R70044120
description	door seal profile 2770/2771 H 800mm W 700mm outer plug size Qty 1		

O-rings

EPDM



GEV No.	532027	Ref. No.	5017311179
description	O-ring EPDM thickness 1.78mm ID ø 50.52mm Qty 10 pcs		
For models:	EF1-40, EF1-45, EF1-45-BF, EF1-45-D, EF2-40, EF2-45, EF2-45-D, EY1-40M, EY2-40M, EY-35M		

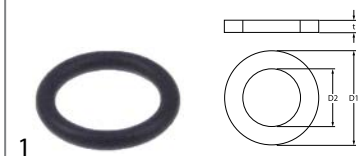

GEV No.	525109	Ref. No.	5017312815
description	O-ring EPDM thickness 2.7mm ID ø 13.6mm Qty 1 pcs		
For models:	BPE-50, BPG-50, CPE-35, CPE-70, CPG-40, EKH-90, EKM-90, GKH-90, GKM-90		

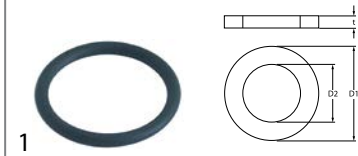

GEV No.	505092	Ref. No.	5017319224
description	O-ring EPDM thickness 5.34mm ID ø 43.82mm Qty 1 pcs		

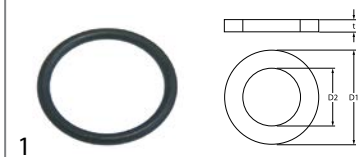

GEV No.	510408	Ref. No.	5017303768 5017313781
description	O-ring EPDM thickness 5.34mm ID ø 47mm Qty 1 pcs		
For models:	BPE-50, CPE-35, CPE-70, EKK-100, EKK-100-BF, EKK-100E, EKK-40, EKK-40-BF, EKK-40E, EKP40, EPK-40, ESK-100-80II-BF, ESK150, ESK-150II-BF, ESK-40, ESK-40E, ESK60, ESK-60-40II-BF, ESK-80, ESK-80E, EUK-45II, EUK-45II-BF, EUK-45II-D, GNKE-100, GNKE-150, GNKE-230, KKE-100, KSKE-100, KSKE-50		

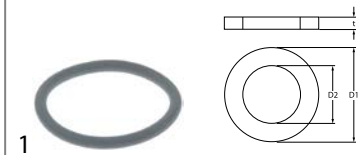

GEV No.	532688	Ref. No.	5017316974 AM5017316974
description	O-ring EPDM thickness 5.34mm ID ø 53.98mm Qty 1 pcs grey for drain tap		

Viton

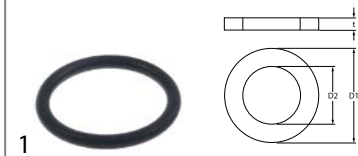



GEV No.	504799	Ref. No.	5017309115 AM5017309115
description	O-ring Viton thickness 2.2mm ID ø 18mm Qty 1 pcs		
For models:	BU-35, BU-70, BUC-35, BUC-70, BUC-70-L, BUC-70-R, EBM-40, EBM-80, EBMC-40, EBMC-80, EBMC-80-L, EBMC-80-R		

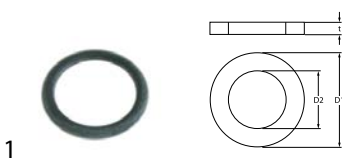

			
GEV No.	528293	Ref. No.	AM5017321026
description	O-ring Viton thickness 2.62mm ID ø 15.88mm Qty 1 pcs		

			
GEV No.	105264	Ref. No.	5017308860
description	O-ring Viton thickness 3.53mm ID ø 94.84mm Qty 1 pcs		
For models:	GR-105, GR-35, GRE-105, GRE-70, GREC-105, GRG-105, GRG-70, GRGC-105, SI-105, SIE-105, SIEC-105, SIG-105, SIGC-105		







			
GEV No.	520953	Ref. No.	5017319159 AM5017319159
description	flat gasket FIBER ED ø 45mm ID ø 38mm thickness 2mm		

<h3>rubber gaskets</h3>			
			
GEV No.	698998	Ref. No.	3017303860 AM3017303860
description	rubber gasket rubber ED ø 40mm ID ø 27mm thickness 1mm		
For models:	BMW-70, BU-35, BU-70, BUC-35, BUC-70, BUC-70-L, BUC-70-R, EBM-40, EBM-80, EBMC-40, EBMC-80, EBMC-80-L, EBMC-80-R		

<h3>sealing washers</h3>			
<h4>aluminium gaskets</h4>			
			
GEV No.	532620	Ref. No.	5017302635
description	flat gasket aluminium ED ø 14.8mm ID ø 11.3mm thickness 1.5mm Qty 1 pcs		
For models:	GF1-40, GF1-45, GF1-45-BF, GF1-45-D, GF2-60, GF2-60-BF, GF2-60-D, GF2-60-ECO, GK-70, GKE-70, GKG-70, GPG-80, GPG-85, GPG-90, GPS-80, GPSE-80, GPSG-80, GSPG80, GY1-40, GY2-70, SI-105, SIE-105, SIEC-105, SIG-105, SIGC-105, TPG-80		

			
GEV No.	101293	Ref. No.	5017302671
description	flat gasket aluminium ED ø 14mm ID ø 10.3mm for pilot burner Qty 1 pcs		
For models:	GBK120E, GBP-70-V, GG-80-V, GHG-70, GKB-120, GKB-120-BF, GKB-120EII, GKB-150, GKB-150-BF, GKB-150EII, GKH-90, GKM-50, GKM-90, GPG-80, GPG-85, GPG-90, GR-105, GR-35, GRE-105, GRE-70, GREC-105, GRG-105, GRG-70, GRGC-105, HGG-120, HGG-80, HGG-85, HGG-90, K7G-35, K7G-50, KBHG-70-R, KKG100, KMG-50, SI-105, SIE-105, SIEC-105, SIG-105, SIGC-105		

<h3>fibre gaskets</h3>			
			
GEV No.	504209	Ref. No.	5017313786
description	flat gasket FIBER ED ø 18.5mm ID ø 11mm thickness 2mm Qty 1 pcs		
For models:	BPE-50, BPG-50, DSK-100-80II-BF, DSK-150II, DSK-150II-BF, DSK-40, DSK-60-40II-BF, DSK-80, EKBD-125EII, EKBD-125EII-BF, EKBD-160EII, EKBD-160EII-BF, EKH-90, EKM-50, EKM-90, ESK-100-80II-BF, ESK150, ESK-150II-BF, ESK-40, ESK-40E, ESK60, ESK-60-40II-BF, ESK-80, ESK-80E, GKH-90, GKM-50, GKM-90, GNKE-100, GNKE-150, GNKE-230, GSK100, GSK-100-80, GSK-100-80-BF, GSK-150, GSK-150-BF, GSK-40, GSK60, GSK-60-40, GSK-60-40-BF, GSK-80		

<h3>silicone gaskets</h3>			
			
GEV No.	692502	Ref. No.	5017309716 AM5017309716
description	sealing ring silicone ED ø 18mm ID ø 16.5mm thickness 0.5mm Qty 1 pcs for pilot lamps		
For models:	BU-35, BU-70, BUC-35, BUC-70, BUC-70-L, BUC-70-R, BUE-40, BUE-70, CH-40, CH-45, CH-45-BF, CH-45-D, CH-45-T, CH-45-T-BF, CH-45-T-D, CH-80, CHE-80, CHT-40, CHT-80, CPE-35, CPE-70, EBM-40, EBM-45, EBM-45-BF, EBM-45-D, EBM-80, EBMC-40, EBMC-80, EBMC-80-L, EBMC-80-R, EBP-45-C, EBP-45-C-BF, EBP-45-C-D, EBP-45-L, EBP-45-L-BF, EBP-45-L-D, EBP-45-R, EBP-45-R-BF, EBP-45-R-D, EBP-90-1-2LR, EBP-90-1-2LR-BF, EBP-90-C, EBP-90-C-BF, EBP-90-C-D, EBP-90-L, EBP-90-L-BF, EBP-90-L-D, EBP-90-LR, EBP-90-R, EBP-90-R-BF...(Other models you can see in the webshop)		
accessories for	692502		
	GEV No.	357088	Ref. No. 5061119976
indicator light green LED ø 16mm 24VDC connection cable cable length 200mm temp.-resist. 150°C			
	GEV No.	357089	Ref. No. 5061119975
indicator light red LED ø 16mm 24VDC connection cable cable length 200mm temp.-resist. 150°C			
	GEV No.	359046	Ref. No. 5061111708 5061111709
indicator light ø 13mm 230V clear			
	GEV No.	359127	Ref. No. 5061108880
indicator light housings mounting measurements ø13mm yellow Qty 1 pcs			
	GEV No.	359225	Ref. No. 5061111119
indicator light housings mounting measurements ø13mm clear Qty 1 pcs			

shaft gaskets

shaft gaskets



1			
GEV No.	511171	Ref. No.	R70020040
description	shaft seal ID ø 14.5mm ED ø 20mm thickness 3mm		



1			
GEV No.	511172	Ref. No.	R70020050
description	shaft sealing ID ø 24mm ED ø 29mm thickness 3mm		

miscellaneous



1			
GEV No.	504481	Ref. No.	5017311175 AM5017311175
description	gasket for microswitch L 23.2mm W 0.95mm H 20mm Qty 1		
For models:	EF1-40, EF1-45, EF1-45-BF, EF1-45-D, EF2-40, EF2-45, EF2-45-BF, EF2-45-D, EY1-40M, EY2-40M, EY-35M		



1			
GEV No.	550862	Ref. No.	R70045090
description	gasket set for wash arm		

springs

torsion springs



1			
GEV No.	700405	Ref. No.	5004705386
description	torsion spring ø 23.7mm wire gauge ø 5.2mm L1 20mm L2 153mm L3 20mm		
For models:	KKE-100, KKG100, TPE-80, TPG-80		



1			
GEV No.	690512	Ref. No.	5004705253
description	torsion spring ø 24.4mm wire gauge ø 4.5mm L1 20mm L2 152mm L3 20mm		
For models:	KSKE-100, KSKE-50		



1			
GEV No.	700406	Ref. No.	5004707073
description	torsion spring ø 30mm wire gauge ø 6.1mm L1 16mm L2 510mm L3 16mm		
For models:	EKH-90, EKM-50, EKM-90, GKH-90, GKM-50, GKM-90, KHE-90, KHG-90, KME-50, KMG-50		



1			
GEV No.	690513	Ref. No.	5004714718
description	torsion spring ø 42.4mm wire gauge ø 5.2mm L1 27mm L2 145mm L3 27mm		
For models:	DSK-40, DSK-60-40II-BF, ESK-100-80II-BF, ESK150, ESK-150II-BF, ESK-40, ESK60, ESK-60-40II-BF, ESK-80, ESK-80E, GKS-100, GKS-150, GKS-60, GKS-80		



1			
GEV No.	690515	Ref. No.	5004714695
description	torsion spring ø 44.4mm wire gauge ø 6.7mm L1 26mm L2 138mm L3 26mm		
For models:	DSK-100-80II-BF, DSK-150II, DSK-150II-BF, DSK-80, GNKD100, GNKD-90II-BF, GNKE-100, GSK100, GSK-100-80, GSK-100-80-BF, GSK-150, GSK-150-BF, GSK-40, GSK60, GSK-60-40, GSK-60-40-BF, GSK-80		



1			
GEV No.	690514	Ref. No.	5004709717
description	torsion spring ø 44.6mm wire gauge ø 7.2mm L1 27mm L2 170mm L3 27mm		
For models:	EKK-150, EKK-150-BF, GNKD-150II, GNKD-150II-BF, GNKD-230II, GNKD-230II-BF, GNKE-150, GNKE-230		

compression springs





1			
GEV No.	690091	Ref. No.	R61620041
description	compression spring ø 12mm L 49mm wire gauge ø 1mm		



			
GEV No.	100919	Ref. No.	5004708809
description	compression spring ø 14mm L 40mm wire gauge ø 1.15mm		
For models:	CH-40, CH-45, CH-45-BF, CH-45-D, CH-45-T, CH-45-T-BF, CH-45-T-D, CH-80, CHE-80, CHT-40, CHT-80, GH-120, GH-40, GH-45, GH-45-BF, GH-45-D, GH-45-G, GH-45-H, GH-45-H-BF, GH-45-H-D, GH-45-H-G, GH-80, GH-90, GH-90-BF, GH-90G, GH-90-H, GH-90-H-BF, GH-90-HG, GH-90IV-D, GHE-120, GHE-80, GHG-120, GHG-80, GR-105, GR-35, GRE-105, GRE-70, GREC-105, GRG-105, GRG-70, GRGC-105, SI-105, SIE-105, SIEC-105, SIG-105, SIGC-105		

gas tension springs

			
GEV No.	700407	Ref. No.	5004714039
description	gas tension spring 400N hub 220mm D1 ø 8mm D2 ø 18mm hole distance 490mm hole ø 8mm L 500mm		
For models:	EKB-120, EKB-120E, EKB-150, EKB-150E, EKK-100, EKK-100-BF, EKK-100E, EKK-40, EKK-40-BF, EKK-40E, GBK120E, GKB-120, GKB-120-BF, GKB-120EII, GKB-150, GKB-150-BF, GKB-150EII		

			
GEV No.	700403	Ref. No.	5004714043
description	gas tension spring 700N hub 60mm D1 ø 19mm D2 ø 8mm hole distance 210mm hole ø 8mm L 225mm		
For models:	GB-90, UBE-90, UBE-90-D, UBED-90-D		



tilt springs

			
GEV No.	700408	Ref. No.	5004715273
description	tilt spring		
For models:	EKB-120, EKB-120E, EKB-120EII, EKB-120EII-BF, EKB-150EII, EKB-150EII-BF, EKBD-125EII, EKBD-125EII-BF, EKK-100, EKK-100-BF, EKK-100E, EKK-40, EKK-40-BF, EKK-40E, GBK120E, GKB-120, GKB-120-BF, GKB-120EII		

			
GEV No.	700409	Ref. No.	5004715274
description	tilt spring		
For models:	EKB-150, EKB-150E, EKBD-160EII, EKBD-160EII-BF, EKK-150, EKK-150-BF, GKB-150, GKB-150-BF, GKB-150EII		

manometers

			
GEV No.	541334	Ref. No.	3527217898 5027207762 5027209124 5027210517 5027213796
description	manometer ø 60mm pressure range 0 up to 1bar thread 1/8" marking 0.5 kettle connection on the backside		
For models:	BPE-50, BPG-50, DSK-100-80II-BF, DSK-150II, DSK-150II-BF, DSK-40, DSK-60-40II-BF, DSK-80, EKBD-125EII, EKBD-125EII-BF, EKBD-160EII, EKBD-160EII-BF, EKK-100, EKK-100-BF, EKK-100E, EKK-150, EKK-150-BF, EKK-40, EKK-40-BF, EKK-40E, ESK-100-80II-BF, ESK-150, ESK-150II-BF, ESK-40, ESK-40E, ESK60, ESK-60-40II-BF, ESK-80, ESK-80E, GNKD100, GNKD-150II, GNKD-150II-BF, GNKD-230II, GNKD-230II-BF, GNKD-90II-BF, GNKE-100, GNKE-150, GNKE-230, GSK100, GSK-100-80, GSK-100-80-BF, GSK-150, GSK-150-BF, GSK-40, GSK60, GSK-60-40, GSK-60-40-BF, GSK-80, KSKE-100, KSKE-50		

				
GEV No.	541062	Ref. No.	5027207356 5027213795	
description	manometer ø 63mm pressure range 0 up to 1bar connection marking adjustable kettle thread 1/4"			
For models:	GKS-100, GKS-150, GKS-60, GKS-80, K7E-35, K7E-50, K7G-35, K7G-50, KKE-100, KKG100			
spare parts for	541062			
	GEV No.	541130	Ref. No.	—
	 glass panel ø 58mm thickness 2mm			



dosing pumps

membrane dosing pumps

self-priming



LANG

accessories



1

GEV No.	101286	Ref. No.	5050503194
description	olive ID ø 6mm Qty 1 pcs		
For models:	GBK120E, GBP-70-V, GBP-90-1-2LR, GBP-90-1-2LR-BF, GBP-90-1-2LR-D, GBP-90-C, GBP-90-C-BF, GBP-90-C-D, GBP-90-L, GBP-90-L-BF, GBP-90-L-D, GBP-90-R, GBP-90-R-BF, GBP-90-R-D, GG-80-V, GGG-80, GHG-70, GKB-120, GKB-120-BF, GKB-120EII, GKB-150, GKB-150-BF, GKB-150EII, GKH-90, GKM-50, GKM-90, GP-90, GP-90-BF, GP-90-D, GPG-80, GPG-85, GPG-90, GZE-70, HGG-120, HGG-80, HGG-85, HGG-90, KBHG-70-R, KHG-90, KKG100, KMG-50, TPG-80, ZGG-80		

accessories for	101286		
	GEV No.	100909	Ref. No.
			—
		union screw thread M10x1 for pipe ø 6mm Qty 1 pcs	
	GEV No.	101464	Ref. No.
			—
		union nut thread M12x1 for pipe ø 6mm	

accessories

container filters with non-return valve



1

GEV No.	361058	Ref. No.	R65110650
description	container filter with non-return valve SS hose ø 4x6mm ø 20mm L 56mm		

fittings, hose and pipe connectors

fittings

reducers



1

GEV No.	550678	Ref. No.	3006315427
description	reducer thread 1/2" ET - M10x1 IT		
For models:	GSK100, GSK-100-80, GSK-100-80-BF, GSK-150, GSK-150-BF, GSK-40, GSK60, GSK-60-40, GSK-60-40-BF, GSK-80		

screw pipe fittings

with thread



1

GEV No.	698995	Ref. No.	5051220038 AM5051220038
description	screw pipe fitting thread 3/8" WS 19 ID ø 12mm thread L 10/12mm		
For models:	GB-90, GBP-45-C, GBP-45-C-BF, GBP-45-C-D, GBP-45-L, GBP-45-L-BF, GBP-45-L-D, GBP-45-R, GBP-45-R-BF, GBP-45-R-D, GBP-90-1-2LR, GBP-90-1-2LR-BF, GBP-90-1-2LR-D, GBP-90-C, GBP-90-C-BF, GBP-90-C-D, GBP-90-L, GBP-90-L-BF, GBP-90-L-D, GBP-90-R, GBP-90-R-BF, GBP-90-R-D, GBR45R, GF1-40, GF2-60-ECO, GF-40, GGG-80, GHG-120, GHG-80, GKG-70, GKH-90, GKM-50, GKM-90, GPG-80, GPG-85, GPG-90, GPGS-80, GRG-105, GRG-70, GRGC-105, GSPG80, GY1-40, GY2-70, GY-40, HGG-120, HGG-80, HGG-85, HGG-90, K7E-35, K7E-50...(Other models you can see in the webshop)		

valves and tank inlets

ball valves

universal

ball valves with lever handle



1

GEV No.	520282	Ref. No.	2018000301 5018007498
description	ball valve connection 1" IT - 1" IT DN25 total length 67mm with lever handle		
For models:	CPE-35, CPE-70, CPG-40, EF1-40, EF1-45, EF1-45-BF, EF1-45-D, EF2-40, EF2-40-E, EF2-45, EF2-45-BF, EF2-45-D, EF-40, EPK-40, EUK-45II, EUK-45II-BF, EUK-45II-D, EY1-40M, EY2-40-E, EY2-40M, EY-35M, FE2-40, FE2-40-E, FE2-80-E, FG1-40, GF1-40, GF1-45, GF1-45-BF, GF1-45-D, GF2-60, GF2-60-BF, GF2-60-D, GF2-60-ECO, GF-40, GPK-40, GUK-45II, GUK-45II-BF, GUK-45II-D, GY1-40, GY2-70, GY-40		

ball valves electric



1

GEV No.	401342	Ref. No.	R65110560 old Version
description	ball valve inlet 3/4" IT outlet 3/4" IT 230V IT 3/4"		





1

GEV No.	403042	Ref. No.	R65110560
description	ball valve inlet 3/4" IT outlet 3/4" IT 230V L 68mm closed off-current mode of operation electric connection cable 400mm		

shut-off valves

universal



1

GEV No.	514085	Ref. No.	5022213783
description	rosette connection 26x19G chrome-plated total lengthmm mounting pos.		



1

GEV No.	514085	Ref. No.	5022213783
description	rosette connection 26x19G chrome-plated total lengthmm mounting pos.		



1



GEV No.	540944	Ref. No.	5022213783
description	rosette connection 26x18G chrome-plated total lengthmm mounting pos.		
For models:	BPE-50, BPG-50, CPE-35, CPE-70, CPG-40, DSK-100-80II-BF, DSK-150II, DSK-150II-BF, DSK-40, DSK-60-40II-BF, DSK-80, EKH-90, EKM-90, ESK-100-80II-BF, ESK150, ESK-150II-BF, ESK-40, ESK60, ESK-60-40II-BF, ESK-80, GKH-90, GKM-90, GKS-100, GKS-150, GKS-60, GKS-80, GNKE-100, GNKE-150, GNKE-230, GSK100, GSK-100-80, GSK-100-80-BF, GSK-150, GSK-150-BF, GSK-40, GSK60, GSK-60-40, GSK-60-40-BF, GSK-80		



1

GEV No.	540942	Ref. No.	5018007357
description	shut-off valve connection 1/2" 1/2" cold total length 30mm mounting pos. left rosette thread G2 26x18G shaft ø M5x0.8mm		
For models:	BEW-80, BEW-85, BEW-90, BPE-50, BPG-50, CPE-35, CPE-70, CPG-40, DSK-100-80II-BF, DSK-150II, DSK-150II-BF, DSK-80, GNKD100, GNKD-150II, GNKD-150II-BF, GNKD-230II, GNKD-230II-BF, GNKD-90II-BF, K7E-35, K7E-50, K7G-35, K7G-50, KKE-100, KKG100		



spare parts for 540942

	GEV No.	540000	Ref. No.	5022913784
	description	star handle connection 7.5mm cold/warm total lengthmm mounting pos. Qty 1 set		
	GEV No.	540924	Ref. No.	5018007381
	description	tap head connection 1/2" total lengthmm mounting pos. Qty 2 pcs		
	GEV No.	540944	Ref. No.	5022213783
	description	rosette connection 26x18G chrome-plated total lengthmm mounting pos.		





1

GEV No.	540941	Ref. No.	5018003414	
description	shut-off valve connection 1/2" 1/2" cold total length 59mm mounting pos. rosette thread G2 26x18G shaft ø M5x0.8mm			
For models:	EKH-90, EKM-90, GKH-90, GKM-90, KHE-90, KHG-90, KSKE-100, KSKE-50			
spare parts for	540941			
	GEV No.	540000	Ref. No.	5022913784
	description	star handle connection 7.5mm cold/warm total lengthmm mounting pos. Qty 1 set		
	GEV No.	540924	Ref. No.	5018007381
	description	tap head connection 1/2" total lengthmm mounting pos. Qty 2 pcs		
	GEV No.	540944	Ref. No.	5022213783
	description	rosette connection 26x18G chrome-plated total lengthmm mounting pos.		

			
1			
GEV No.	540943	Ref. No.	5018003416 5018013782
description	shut-off valve connection 1/2" 1/2" hot total length 30mm mounting pos. right rosette thread G2 26x18G shaft ø M5x0.8mm		
For models:	BPE-50, BPG-50, DSK-100-80II-BF, DSK-150II, DSK-150II-BF, DSK-40, DSK-60-40II-BF, DSK-80, ESK-100-80II-BF, ESK150, ESK-150II-BF, ESK-40, ESK60, ESK-60-40II-BF, ESK-80, GKS-100, GKS-150, GKS-60, GKS-80, GNKD100, GNKD-150II, GNKD-150II-BF, GNKD-230II, GNKD-230II-BF, GNKD-90II-BF, GNKE-100, GNKE-150, GNKE-230, GSK100, GSK-100-80, GSK-100-80-BF, GSK-150, GSK-150-BF, GSK-40, GSK60, GSK-60-40, GSK-60-40-BF, GSK-80, K7E-35, K7E-50, K7G-35, K7G-50, KKE-100, KKG100		
spare parts for	540943		
	GEV No.	Ref. No.	
	540000		5022913784
	star handle connection 7.5mm cold/warm total lengthmm mounting pos. Qty 1 set		
	540924		5018007381
	tap head connection 1/2" total lengthmm mounting pos. Qty 2 pcs		
	540944		5022213783
	rosette connection 26x18G chrome-plated total lengthmm mounting pos.		

			
1			
GEV No.	540000	Ref. No.	5022913784
description	star handle connection 7.5mm cold/warm total lengthmm mounting pos. Qty 1 set		
spare parts for	540000		
	GEV No.	Ref. No.	
	540945		5031400110
	marker connection cold water total lengthmm mounting pos.		
	540946		5031400109
	marker connection hot water total lengthmm mounting pos.		
	540947		5025000108
	cover cap connection chrome-plated total lengthmm mounting pos.		
	540948		5040913785
	screw thread M5 L 10mm brass Qty 1 pcs		

			
1			
GEV No.	540924	Ref. No.	5018007381
description	tap head connection 1/2" total lengthmm mounting pos. Qty 2 pcs		
For models:	BPE-50, BPG-50, CPE-35, CPE-70, CPG-40, DSK-100-80II-BF, DSK-150II, DSK-150II-BF, DSK-40, DSK-60-40II-BF, DSK-80, EKH-90, EKM-90, ESK-100-80II-BF, ESK150, ESK-150II-BF, ESK-40, ESK60, ESK-60-40II-BF, ESK-80, GKH-90, GKM-90, GKS-100, GKS-150, GKS-60, GKS-80, GNKE-100, GNKE-150, GNKE-230, GSK100, GSK-100-80, GSK-100-80-BF, GSK-150, GSK-150-BF, GSK-40, GSK60, GSK-60-40, GSK-60-40-BF, GSK-80		

			
1			
GEV No.	514085	Ref. No.	5022213783
description	rosette connection 26x19G chrome-plated total lengthmm mounting pos.		

<p>producer-specific</p> <p>AMBACH</p>			
			
1			
GEV No.	540947	Ref. No.	5025000108
description	cover cap connection chrome-plated total lengthmm mounting pos.		
For models:	BPE-50, BPG-50, CPE-35, CPE-70, CPG-40, DSK-40, DSK-60-40II-BF, EKH-90, EKM-90, ESK-100-80II-BF, ESK150, ESK-150II-BF, ESK-40, ESK60, ESK-60-40II-BF, ESK-80, GKH-90, GKM-90, GKS-100, GKS-150, GKS-60, GKS-80, GNKE-100, GNKE-150, GNKE-230, GSK100, GSK-100-80, GSK-100-80-BF, GSK-150, GSK-150-BF, GSK-40, GSK60, GSK-60-40, GSK-60-40-BF, GSK-80		

			
1			
GEV No.	540951	Ref. No.	5022913784
description	handle connection without marking total lengthmm mounting pos.		
accessories for	540951		
	GEV No.	Ref. No.	
	540945		5031400110
	marker connection cold water total lengthmm mounting pos.		
	540946		5031400109
	marker connection hot water total lengthmm mounting pos.		
	540947		5025000108
	cover cap connection chrome-plated total lengthmm mounting pos.		
	540948		5040913785
	screw thread M5 L 10mm brass Qty 1 pcs		

1

GEV No.	540945	Ref. No.	5031400110
description	marker connection cold water total lengthmm mounting pos.		
For models:	BPE-50, BPG-50, CPE-35, CPE-70, CPG-40, DSK-100-80II-BF, DSK-150II, DSK-150II-BF, DSK-40, DSK-60-40II-BF, DSK-80, EKH-90, EKM-90, ESK-100-80II-BF, ESK150, ESK-150II-BF, ESK-40, ESK60, ESK-60-40II-BF, ESK-80, GKH-90, GKM-90, GKS-100, GKS-150, GKS-60, GKS-80, GNKE-100, GNKE-150, GNKE-230, GSK100, GSK-100-80, GSK-100-80-BF, GSK-150, GSK-150-BF, GSK-40, GSK60, GSK-60-40, GSK-60-40-BF, GSK-80		



1

GEV No.	540946	Ref. No.	5031400109
description	marker connection hot water total lengthmm mounting pos.		
For models:	BPE-50, BPG-50, DSK-100-80II-BF, DSK-150II, DSK-150II-BF, DSK-40, DSK-60-40II-BF, DSK-80, ESK-100-80II-BF, ESK150, ESK-150II-BF, ESK-40, ESK60, ESK-60-40II-BF, ESK-80, GKS-100, GKS-150, GKS-60, GKS-80, GNKE-100, GNKE-150, GNKE-230, GSK100, GSK-100-80, GSK-100-80-BF, GSK-150, GSK-150-BF, GSK-40, GSK60, GSK-60-40, GSK-60-40-BF, GSK-80		



1

GEV No.	540944	Ref. No.	5022213783
description	rosette connection 26x18G chrome-plated total lengthmm mounting pos.		
For models:	BPE-50, BPG-50, CPE-35, CPE-70, CPG-40, DSK-100-80II-BF, DSK-150II, DSK-150II-BF, DSK-40, DSK-60-40II-BF, DSK-80, EKH-90, EKM-90, ESK-100-80II-BF, ESK150, ESK-150II-BF, ESK-40, ESK60, ESK-60-40II-BF, ESK-80, GKH-90, GKM-90, GKS-100, GKS-150, GKS-60, GKS-80, GNKE-100, GNKE-150, GNKE-230, GSK100, GSK-100-80, GSK-100-80-BF, GSK-150, GSK-150-BF, GSK-40, GSK60, GSK-60-40, GSK-60-40-BF, GSK-80		



1

GEV No.	540948	Ref. No.	5040913785
description	screw thread M5 L 10mm brass Qty 1 pcs		



1

GEV No.	540942	Ref. No.	5018007357	
description	shut-off valve connection 1/2" 1/2" cold total length 30mm mounting pos. left rosette thread G2 26x18G shaft ø M5x0.8mm			
For models:	BEW-80, BEW-85, BEW-90, BPE-50, BPG-50, CPE-35, CPE-70, CPG-40, DSK-100-80II-BF, DSK-150II, DSK-150II-BF, DSK-80, GNKD100, GNKD-150II, GNKD-150II-BF, GNKD-230II, GNKD-230II-BF, GNKD-90II-BF, K7E-35, K7E-50, K7G-35, K7G-50, KKE-100, KKG100			
spare parts for	540942			
	GEV No.	540000	Ref. No.	5022913784
	star handle connection 7.5mm cold/warm total lengthmm mounting pos. Qty 1 set			
	GEV No.	540924	Ref. No.	5018007381
	tap head connection 1/2" total lengthmm mounting pos. Qty 2 pcs			
	GEV No.	540944	Ref. No.	5022213783
	rosette connection 26x18G chrome-plated total lengthmm mounting pos.			



1

GEV No.	540941	Ref. No.	5018003414	
description	shut-off valve connection 1/2" 1/2" cold total length 59mm mounting pos. rosette thread G2 26x18G shaft ø M5x0.8mm			
For models:	EKH-90, EKM-90, GKH-90, GKM-90, KHE-90, KHG-90, KSKE-100, KSKE-50			
spare parts for	540941			
	GEV No.	540000	Ref. No.	5022913784
	star handle connection 7.5mm cold/warm total lengthmm mounting pos. Qty 1 set			
	GEV No.	540924	Ref. No.	5018007381
	tap head connection 1/2" total lengthmm mounting pos. Qty 2 pcs			
	GEV No.	540944	Ref. No.	5022213783
	rosette connection 26x18G chrome-plated total lengthmm mounting pos.			

			
1			
GEV No.	540943	Ref. No.	5018003416 5018013782
description	shut-off valve connection 1/2" 1/2" hot total length 30mm mounting pos. right rosette thread G2 26x18G shaft ø M5x0.8mm		
For models:	BPE-50, BPG-50, DSK-100-80II-BF, DSK-150II, DSK-150II-BF, DSK-40, DSK-60-40II-BF, DSK-80, ESK-100-80II-BF, ESK150, ESK-150II-BF, ESK-40, ESK60, ESK-60-40II-BF, ESK-80, GKS-100, GKS-150, GKS-60, GKS-80, GNKD100, GNKD-150II, GNKD-150II-BF, GNKD-230II, GNKD-230II-BF, GNKD-90II-BF, GNKE-100, GNKE-150, GNKE-230, GSK100, GSK-100-80, GSK-100-80-BF, GSK-150, GSK-150-BF, GSK-40, GSK60, GSK-60-40, GSK-60-40-BF, GSK-80, K7E-35, K7E-50, K7G-35, K7G-50, KKE-100, KKG100		
spare parts for	540943		
	 GEV No. 540000 Ref. No. 5022913784 star handle connection 7.5mm cold/warm total lengthmm mounting pos. Qty 1 set		
	 GEV No. 540924 Ref. No. 5018007381 tap head connection 1/2" total lengthmm mounting pos. Qty 2 pcs		
	 GEV No. 540944 Ref. No. 5022213783 rosette connection 26x18G chrome-plated total lengthmm mounting pos.		

			
1			
GEV No.	540922	Ref. No.	5018013782
description	shut-off valve connection 1/2" IT angled		

			
1			
GEV No.	540000	Ref. No.	5022913784
description	star handle connection 7.5mm cold/warm total lengthmm mounting pos. Qty 1 set		
spare parts for	540000		
	 GEV No. 540945 Ref. No. 5031400110 marker connection cold water total lengthmm mounting pos.		
	 GEV No. 540946 Ref. No. 5031400109 marker connection hot water total lengthmm mounting pos.		
	 GEV No. 540947 Ref. No. 5025000108 cover cap connection chrome-plated total lengthmm mounting pos.		



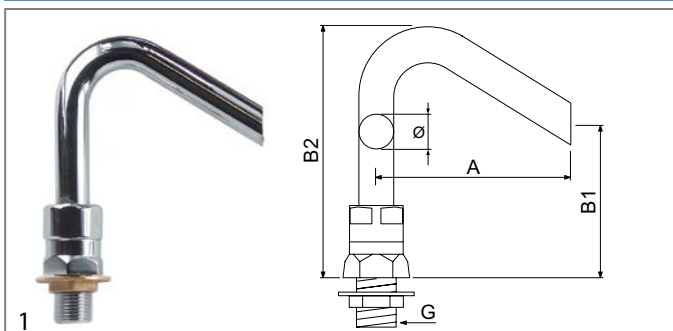

spare parts for	540000		
	 GEV No. 540948 Ref. No. 5040913785 screw thread M5 L 10mm brass Qty 1 pcs		

			
1			
GEV No.	540924	Ref. No.	5018007381
description	tap head connection 1/2" total lengthmm mounting pos. Qty 2 pcs		
For models:	BPE-50, BPG-50, CPE-35, CPE-70, CPG-40, DSK-100-80II-BF, DSK-150II, DSK-150II-BF, DSK-40, DSK-60-40II-BF, DSK-80, EKH-90, EKM-90, ESK-100-80II-BF, ESK150, ESK-150II-BF, ESK-40, ESK60, ESK-60-40II-BF, ESK-80, GKH-90, GKM-90, GKS-100, GKS-150, GKS-60, GKS-80, GNKE-100, GNKE-150, GNKE-230, GSK100, GSK-100-80, GSK-100-80-BF, GSK-150, GSK-150-BF, GSK-40, GSK60, GSK-60-40, GSK-60-40-BF, GSK-80		

inlet taps



1			
GEV No.	540950	Ref. No.	5000508009
description	inlet spout connection 1/2" ET tube ø 18mm projection 105mm overall height 130mm spout height 70mm rotation 90°		
For models:	BPE-50, BPG-50, CPE-35, CPE-70, CPG-40, DSK-100-80II-BF, DSK-150II, DSK-150II-BF, DSK-40, DSK-60-40II-BF, DSK-80, EKH-90, EKM-90, ESK-100-80II-BF, ESK150, ESK-150II-BF, ESK-40, ESK60, ESK-60-40II-BF, ESK-80, ESK-80E, GKH-90, GKM-90, GKS-100, GKS-150, GKS-60, GKS-80, GNKD100, GNKD-150II, GNKD-150II-BF, GNKD-230II, GNKD-230II-BF, GNKD-90II-BF, GNKE-100, GNKE-150, GNKE-230, GSK100, GSK-100-80, GSK-100-80-BF, GSK-150, GSK-150-BF, GSK-40, GSK60, GSK-60-40, GSK-60-40-BF, GSK-80, K7E-35, K7E-50, K7G-35, K7G-50...(Other models you can see in the webshop)		

spare parts for	540950		
	 GEV No. 511470 Ref. No. — nut thread 1/2" ø 40mm H 8mm WS 25 brass Qty 1 pcs		
	 GEV No. 512071 Ref. No. — O-ring EPDM thickness 2.62mm ID ø 22.22mm Qty 1 pcs		
accessories for	540950		
	 GEV No. 511474 Ref. No. — flat washer for thread 1/2"		
	 GEV No. 511477 Ref. No. — flat gasket rubber ED ø 42mm ID ø 21mm thickness 2mm Qty 1 pcs		

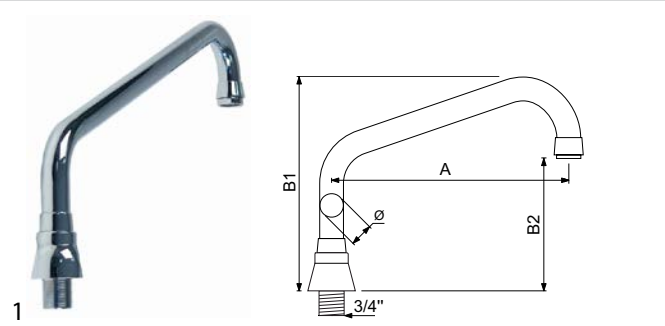
GEV No.	540778	Ref. No.	5000508247 5000510477 5000513764 5000518591
description	swivel tap connection 3/4" ET tube ø 20mm projection 400mm overall height 190mm spout height 150mm rotation 360°		
For models:	EKB-120E, EKB-120EII, EKB-120EII-BF, EKB-150E, EKB-150EII, EKB-150EII-BF, EKBD-125EII, EKBD-125EII-BF, EKBD-160EII, EKBD-160EII-BF, EKK-100E, EKK-40E, GBK120E, GKB-120EII, GKB-150EII		



GEV No.	540940	Ref. No.	5029406192
description	inlet spout connection 1/2" ET tube ø 18mm projection 95mm overall height 135mm spout height 90mm rotation°		
For models:	EKM-50, GKM-50, KHE-90, KHG-90, KME-50, KMG-50		

water cycle components

non-return valves



GEV No.	543006	Ref. No.	5018114399
description	non-return valve brass connection 1/2" IT - 1/2" IT total length 68mm DN15		
For models:	DSK-100-80II-BF, DSK-150II, DSK-150II-BF, DSK-40, DSK-60-40II-BF, DSK-80, EKK-100, EKK-100-BF, EKK-100E, EKK-150, EKK-150-BF, EKK-40, EKK-40-BF, EKK-40E, ESK-100-80II-BF, ESK150, ESK-150II-BF, ESK-40, ESK-40E, ESK-80, ESK-80E, GNKD100, GNKD-150II, GNKD-150II-BF, GNKD-230II, GNKD-230II-BF, GNKD-90II-BF, GNKE-100, GNKE-150, GNKE-230, GSK100, GSK-100-80, GSK-100-80-BF, GSK-150, GSK-150-BF, GSK-40, GSK60, GSK-60-40, GSK-60-40-BF, GSK-80		

ancillary products

clamps

hose clamps

DIN 3017 - W4



GEV No.	520120	Ref. No.	5028510569
description	hose clamp SS W4 ø 12-20mm width 9mm Qty 1 pcs DIN 3017		
For models:	DSK-100-80II-BF, DSK-150II, DSK-150II-BF, DSK-40, DSK-60-40II-BF, DSK-80, EKK-100, EKK-100-BF, EKK-100E, EKK-150, EKK-150-BF, EKK-40, EKK-40-BF, EKK-40E, ESK-100-80II-BF, ESK150, ESK-150II-BF, ESK-40, ESK-40E, ESK60, ESK-60-40II-BF, ESK-80, ESK-80E, GH-120, GH-40, GH-45, GH-45-BF, GH-45-D, GH-45-G, GH-45-H, GH-45-H-BF, GH-45-H-D, GH-45-H-G, GH-80, GH-90, GH-90-BF, GH-90G, GH-90-H, GH-90-H-BF, GH-90-HG, GH-90IV-D, GHE-120, GHE-80, GHG-120, GHG-80, GNKD100, GNKD-150II, GNKD-150II-BF, GNKD-230II, GNKD-230II-BF... (Other models you can see in the webshop)		

fastening material

screws

hexagonal screws



GEV No.	560351	Ref. No.	5041001249
description	hexagonal screw thread M5 thread L 12mm SS WS 10 Qty 1 pcs		



GEV No.	560594	Ref. No.	R61020562
description	hexagonal screw thread M6 thread L 20mm WS 10 total length 59mm		

cylinder head bolts

DIN 912/ISO 4762



1

GEV No.	560315	Ref. No.	5041400387
description	cylinder head bolt thread M5 thread L 12mm WS 4 SS Qty 20 pcs DIN 912/ISO 4762		
For models:	GB-90, GBK120E, GBP-45-C, GBP-45-C-BF, GBP-45-C-D, GBP-45-L, GBP-45-L-BF, GBP-45-L-D, GBP-45-R, GBP-45-R-BF, GBP-45-R-D, GBP-90-1-2LR, GBP-90-1-2LR-BF, GBP-90-1-2LR-D, GBP-90-C, GBP-90-C-BF, GBP-90-C-D, GBP-90-L, GBP-90-L-BF, GBP-90-L-D, GBP-90-R, GBP-90-R-BF, GBP-90-R-D, GBR45R, GF1-45, GF1-45-BF, GF1-45-D, GF2-60, GF2-60-BF, GF2-60-D, GH-45, GH-45-BF, GH-45-D, GH-45-G, GH-45-H, GH-45-H-BF, GH-45-H-D, GH-45-H-G, GH-90, GH-90-BF, GH-90G, GH-90-H, GH-90-H-BF, GH-90-HG, GH-90IV-D, GKB-120, GKB-120-BF, GKB-120EII, GKB-150, GKB-150-BF..(Other models you can see in the webshop)		

side bolts



1

GEV No.	560052	Ref. No.	5040913785
description	side bolts thread M5 L 10mm SS Qty 20 pcs intake slotted head ø 12.5mm		
For models:	BPE-50, BPG-50, CPE-35, CPE-70, CPG-40, DSK-100-80II-BF, DSK-150II, DSK-150II-BF, DSK-40, DSK-60-40II-BF, DSK-80, EKH-90, EKM-90, ESK-100-80II-BF, ESK150, ESK-150II-BF, ESK-40, ESK60, ESK-60-40II-BF, ESK-80, GKH-90, GKM-90, GKS-100, GKS-150, GKS-60, GKS-80, GNKE-100, GNKE-150, GNKE-230, GSK100, GSK-100-80, GSK-100-80-BF, GSK-150, GSK-150-BF, GSK-40, GSK60, GSK-60-40, GSK-60-40-BF, GSK-80		



1

GEV No.	540948	Ref. No.	5040913785
description	screw thread M5 L 10mm brass Qty 1 pcs		

grub screws

DIN 913/ISO 4026



1

GEV No.	560024	Ref. No.	R61090052
description	grub screw thread M6 L 16mm SS DIN 913/ISO 4026 intake internal hexagon WS 3 Qty 20 pcs		

DIN 914/ISO 4027



1

GEV No.	560175	Ref. No.	5040810578
description	grub screw thread M8 L 16mm DIN 914/ISO 4027 intake internal hexagon WS 4 Qty 1 pcs		
For models:	DSK-100-80II-BF, DSK-150II, DSK-150II-BF, DSK-40, DSK-60-40II-BF, DSK-80, EKH-90, ESK-100-80II-BF, ESK150, ESK-150II-BF, ESK-40, ESK60, ESK-60-40II-BF, ESK-80, GKH-90, GNKE-100, GNKE-150, GNKE-230		

miscellaneous



1

GEV No.	690594	Ref. No.	R58002560
description	pressure screw for door hinge		

nuts

hexagonal nuts

ISO 4033 / UNI5587



1

GEV No.	550866	Ref. No.	R58004020
description	nut thread M10x1.5 H 10mm SS WS 17 Qty 1 pcs DIN/ISO DIN 934 / ISO 4032/8673 left-hand thread		

washers

spring washers



1

GEV No.	697933	Ref. No.	R61420021
description	spring washer ID ø 13mm ED ø 24mm Qty 1 pcs		

washers

miscellaneous



1

GEV No.	690593	Ref. No.	R58002570
description	plain washer ID ø 15mm ED ø 30mm thickness 3mm Qty 1 pcs for door hinge		



fasteners

clamps

hose clamps

DIN 3017 - W4



GEV No.	520120	Ref. No.	5028510569
description	hose clamp SS W4 ø 12-20mm width 9mm Qty 1 pcs DIN 3017		
For models:	DSK-100-80II-BF, DSK-150II, DSK-150II-BF, DSK-40, DSK-60-40II-BF, DSK-80, EKK-100, EKK-100-BF, EKK-100E, EKK-150, EKK-150-BF, EKK-40, EKK-40-BF, EKK-40E, ESK-100-80II-BF, ESK150, ESK-150II-BF, ESK-40, ESK-40E, ESK60, ESK-60-40II-BF, ESK-80, ESK-80E, GH-120, GH-40, GH-45, GH-45-BF, GH-45-D, GH-45-G, GH-45-H, GH-45-H-BF, GH-45-H-D, GH-45-H-G, GH-80, GH-90, GH-90-BF, GH-90G, GH-90-H, GH-90-H-BF, GH-90-HG, GH-90IV-D, GHE-120, GHE-80, GHG-120, GHG-80, GNKD100, GNKD-150II, GNKD-150II-BF, GNKD-230II, GNKD-230II-BF... (Other models you can see in the webshop)		

GEV No.	358678	Ref. No.	5061809773
description	fine fuse size ø5x20mm 8A fast-acting rated 250V Qty 10 pcs		
For models:	EKB-120, EKB-120E, EKB-120EII, EKB-120EII-BF, EKB-150, EKB-150E, EKB-150EII, EKB-150EII-BF, EKK-100, EKK-100-BF, EKK-100E, EKK-150, EKK-150-BF, EKK-40, EKK-40-BF, EKK-40E, ESK-100-80II-BF, ESK150, ESK-150II-BF, ESK-40, ESK-40E, ESK60, ESK-60-40II-BF, ESK-80, ESK-80E, GBK120E, GKB-120, GKB-120-BF, GKB-120EII, GKB-150, GKB-150-BF, GKB-150EII, GNKE-100, GNKE-150, GNKE-230		

GEV No.	358600	Ref. No.	5061818831
description	fine fuse size ø5x20mm 1A slow-acting rated 250V Qty 10 pcs		
For models:	IHF-60, IHF-60-BF, IHF-60-D, IHF-90, IHF-90-BF, IHF-90-D, IWOK-45II, IWOK-45II-BF, IWOK-45II-D		

cotter pins



GEV No.	697873	Ref. No.	5042202927 5042213413
description	cotter pin ø 3.2mm L 40mm		
For models:	GB-90, UBE-90, UBE-90-D, UBED-90-D		

fine fuse holders



GEV No.	358512	Ref. No.	5061807908
description	fuse holder		
For models:	BUE-40, BUE-70, EKB-120, EKB-120E, EKB-120EII, EKB-120EII-BF, EKB-150, EKB-150E, EKB-150EII, EKB-150EII-BF, EKBD-125EII, EKBD-125EII-BF, EKBD-160EII, EKBD-160EII-BF, EKH-90, EKK-100, EKK-100-BF, EKK-100E, EKK-150, EKK-150-BF, EKK-40, EKK-40-BF, EKK-40E, EKM-50, EKM-90, ESK-100-80II-BF, ESK150, ESK-150II-BF, ESK-40, ESK-40E, ESK60, ESK-60-40II-BF, ESK-80, ESK-80E, EUB-40, EUB-45-TB, EUB-45-TB-BF, EUB-45-TB-D, EUB-60-ECCO, EUB-60-TB, EUB-60-TB-BF, EUB-60-TB-D, GBK120E, GF1-45, GF1-45-BF, GF1-45-D, GF2-60, GF2-60-BF, GF2-60-D, GKB-120...(Other models you can see in the webshop)		

consumables

fuses

fine fuses



GEV No.	358533	Ref. No.	5061807231
description	fine fuse size ø5x20mm 6.3A fast-acting rated 250V Qty 10 pcs		
For models:	EKB-120E, EKB-150E, EKH-90, EKK-100E, EKK-40E, EKM-50, EKM-90, ESK-40E, ESK-80E, GBK120E, GKB-120EII, GKB-150EII, GKM-50, GKM-90, GSK100, GSK-100-80, GSK-100-80-BF, GSK-150, GSK-150-BF, GSK-40, GSK60, GSK-60-40, GSK-60-40-BF, GSK-80, KME-50, KMG-50, TPE-80, TPG-80		

A			
alarm devices	29		
axial fans	38		
B			
ball valves	102		
ball valves electric	37, 102		
bar burners	72		
C			
cam switches	21		
clamps	107, 109		
condensators & interference suppression filters	42		
consumables	109		
contact heaters	8		
contactors	29		
container filters	102		
control equipment	23		
control thermostats	12, 17		
cotter pins	109		
cross flow fans	38		
cylinder head bolts	108		
D			
door seals	98		
dosing pumps	102		
E			
electric accessories	43		
electrodes	38		
electronic controllers	31		
energy regulators	12		
F			
fans	38		
fasteners	109		
fastening material	107		
filters	42		
fine fuses	109		
fittings	102		
fuses	42, 109		
G			
gas ball valves	82		
gas burners	66		
gas control valves	54		
gas lines	82		
gas nozzles	75		
gas solenoid valves	56		
gas taps	43		
gas thermostats	51		
gaskets for heated units	97		
		grub screws	108
H			
		halogen lamp	28
		heating elements	3
		heating elements for bain maries	4
		heating elements for convection	10
		heating elements for fryers	5
		heating elements for frying pans	5
		heating elements for griddles	6
		heating elements for large hobs	6
		heating elements for ovens	3
		heating elements for pasta cookers	8
		heating elements for salamanders/toasters	8
		heating elements for tilting bratt pan	7
		hexagonal nuts	108
		hexagonal screws	107
		hob burners	66
		hose clamps	107, 109
		hot air fans	40
		hot air motors	38
		hot plates	11
I			
		ignition boxes	56
		ignition bridges	65
		ignition cables	62
		ignition units	63
		immersion heating elements	9
		indicator lights	25
		indicator lights (complete)	26
		inlet spouts	106
		inlet taps	106
L			
		lamps	25
		LED	28
M			
		magnetic switches	23
		microswitches	20
		motors	41
N			
		neon light bulbs	25, 28
		non-return valves	107
		nuts	108
O			
		operating capacitors	42
		O-rings	98
		oven hinges	91
		oven lamps	28

P			
piezoelectric igniters	62		
pilot burners	56		
plunger sockets	19		
position switches	20		
pressure switches	37, 83		
probes	32		
programme timers	29		
pumps	41		
push/momentary push switches	19		
R			
radial fans	40		
radiation heaters	11		
reducers	102		
refrigeration gaskets	97		
relays	30		
rocker/momentary rocker switches	19		
S			
safety thermostats	15		
screw pipe fittings	102		
screw-in gaskets	97		
screws	107		
sealing washers	99		
shaft gaskets	100		
shut-off valves	103		
side bolts	108		
solenoid valves	35		
solid top burners	74		
spring assisted hinges	91		
spring washers	108		
surface burners	74		
switches and momentary switches	19		
T			
terminals	43		
thermocouples	63		
thermostats	12		
time relays	30		
timers	29		
toggle switches	20		
touch sensitive light switches	23		
transformers	31		
tube burners	74		
V			
valves and tank inlets	102		
vibration pumps	41		
W			
washers	108		
		water cycle components	107
		window seals	97