



GAS COMPONENTS



ELECTRIC COMPONENTS



WATER TECHNOLOGY



MECHANICAL COMPONENTS



TOOLS

Spare parts suitable for

AMATIS

Find the complete and up-to-date range of products in our GEV Webshop



Manufacturer catalogue

The most important spare parts and accessories arranged clearly for every manufacturer

- ✓ Complete product range and all appliance data always up to date in the GEV Webshop
- ✓ Alphabetical Index at the end of the catalogue

GEV Webshop

www.gev-online.co.uk

www.gev-online.com



- 🔍 Add to Favourites
- 🔍 Sign In with email address and usual password
- 🔍 Easy-order – place several items in your basket at the same time
- 🔍 Quick Item search – no login needed



heating elements

heating elements for ovens



GEV No.	418478	Ref. No.	65211001
description	heating element 1000W 230V heating circuits 1 L 420mm W 200mm connection male faston 6.3mm connection distance 194mm connection length 15mm tube ø 6.3mm dry heating element oven/bain marie H 47mm		



GEV No.	416018	Ref. No.	U803004 U803004000
description	heating element 1000W 230V L 515mm W 125mm L1 55mm L2 460mm W1 65mm W2 60mm flange length 80mm flange width 20mm tube ø 6.5mm connection length 50mm connection male faston 6.3mm heating circuits 1 rectangular flange dry heating element		

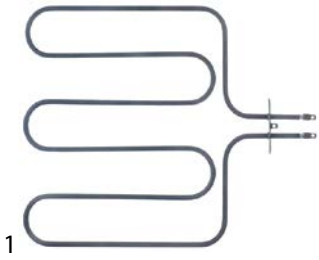

GEV No.	420040	Ref. No.	A0YXD4A40
description	heating element 2000W 230V heating circuits 1 L 330mm W 315mm L1 55mm L2 275mm W1 142mm W2 31mm flange length 70mm flange width 22mm hole distance 56mm hole ø 6mm tube ø 6.6mm connection male faston 6.3mm		

heating elements for bain maries

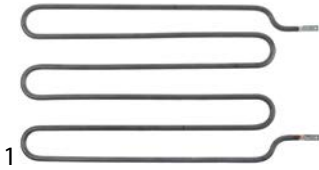



GEV No.	417559	Ref. No.	YFKO-003
description	heating element 1000W 230V heating circuits 1 L 330mm W 182mm connection male faston 6.3mm tube ø 6.5mm W2 125mm		



GEV No.	418478	Ref. No.	65211001
description	heating element 1000W 230V heating circuits 1 L 420mm W 200mm connection male faston 6.3mm connection distance 194mm connection length 15mm tube ø 6.3mm dry heating element oven/bain marie H 47mm		



GEV No.	420032	Ref. No.	24500040100541 PAMP541
description	heating element 2000W 230V heating circuits 1 L 385mm W 440mm connection M4 tube ø 8.5mm thread 1/4" dry heating element bain marie mounting distance 432mm		
accessories for	420032		
	GEV No.	361182	Ref. No. —
	nut thread 1/4" H 5mm nickel-plated brass WS 17 Qty 1 pcs		
	GEV No.	510414	Ref. No. —
	flat gasket copper ED ø 18mm ID ø 14mm thickness 1mm		

heating elements for crepes makers



GEV No.	419011	Ref. No.	010444611
description	heating element 3000W 230V L 307mm W 272mm H 50mm connection distance 260mm dry heating element heating circuits 1 for crepes maker		

heating elements for fryers

2 hole fixing

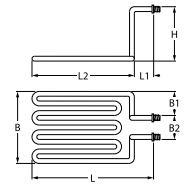
GEV No.	420018	Ref. No.	A040579
description	heating element 3250W 230V heating circuits 1 L 265mm W 185mm H 200mm 2 hole fixing connection M4 immersion heater L1 25mm L2 240mm W1 71mm W2 42mm tube ø 8.1mm thread M12x1 mounting distance 34mm windings 4		
spare parts for	420018		
	GEV No.	521131	Ref. No. 0800205
	nut thread M12x1 H 3.5mm WS 17 SS Qty 1 pcs		

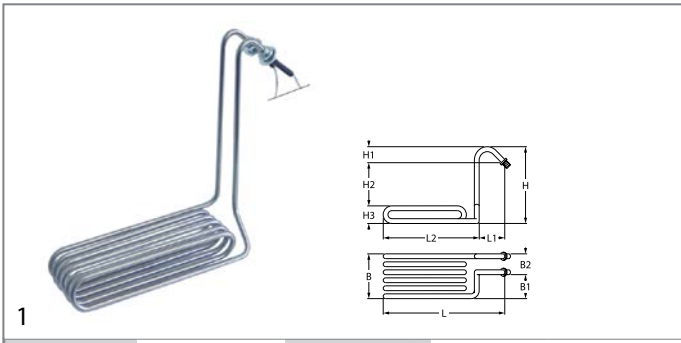

GEV No.	416603	Ref. No.	X323001
description	heating element 4000W 230V heating circuits 1 mounting pos. right + centre L 300mm W 85mm H 300mm L1 40mm L2 260mm W1 41mm W2 44mm H1 40mm H2 210mm H3 50mm mounting distance 35mm thread M14x1.25 tube ø 8.5mm 2 hole fixing connection M4 fryer connection length 27mm		
accessories for	416603		
	GEV No.	521103	Ref. No. —
	nut thread M4 H 3mm WS 7 brass Qty 20 pcs		
	GEV No.	521104	Ref. No. —
	washer ID ø 4.3mm ED ø 8mm thickness 0.5mm brass Qty 20 pcs for thread M4		
	GEV No.	528401	Ref. No. —
	flat gasket fibre ED ø 22mm ID ø 16mm thickness 2mm Qty 1 pcs		
	GEV No.	560111	Ref. No. —
	plain washer ID ø 4.3mm ED ø 9mm thickness 0.8mm SS Qty 20 pcs DIN 125A for thread M4		
	GEV No.	560131	Ref. No. —
	hexagonal nut thread M4 H 3.2mm WS 7 SS DIN/ISO DIN 934 / ISO 4032/8673 Qty 20 pcs		

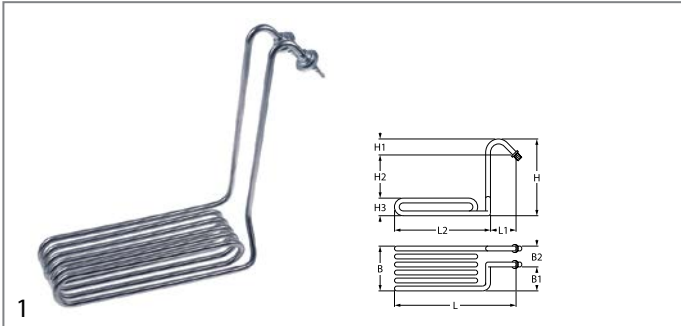

GEV No.	416548	Ref. No.	X613005000
description	heating element 4000W 230V heating circuits 1 mounting pos. right + centre L 300mm W 85mm H 300mm L1 40mm L2 260mm W1 41mm W2 44mm H1 40mm H2 210mm H3 50mm mounting distance 36mm thread M14x1.25 tube ø 8mm 2 hole fixing connection M4 immersion heater connection length 27mm windings 6 fryer		
accessories for	416548		
	GEV No.	401088	Ref. No. X323011000
	copper wire 2.5mm ² insulation glass fibre connection cable lug ø4mm L 1400mm		
	GEV No.	521103	Ref. No. —
	nut thread M4 H 3mm WS 7 brass Qty 20 pcs		
	GEV No.	521104	Ref. No. —
	washer ID ø 4.3mm ED ø 8mm thickness 0.5mm brass Qty 20 pcs for thread M4		
	GEV No.	560111	Ref. No. —
	plain washer ID ø 4.3mm ED ø 9mm thickness 0.8mm SS Qty 20 pcs DIN 125A for thread M4		

accessories for	416548		
	GEV No.	560131	Ref. No. —
	hexagonal nut thread M4 H 3.2mm WS 7 SS DIN/ISO DIN 934 / ISO 4032/8673 Qty 20 pcs		

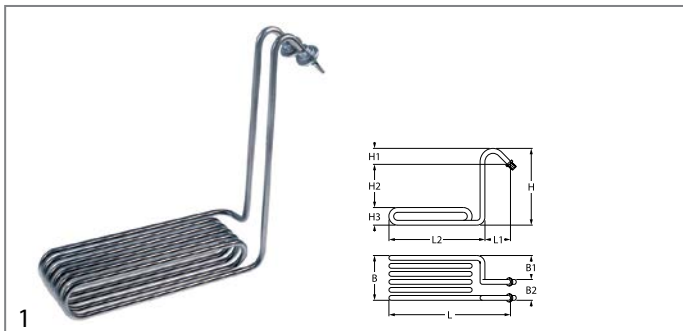

GEV No.	416604	Ref. No.	X323002 X613006000
description	heating element 4000W 230V heating circuits 1 mounting pos. left L 285mm W 85mm H 290mm L1 35mm L2 260mm W1 45mm W2 40mm H1 242mm H2 48mm H3 50mm mounting distance 26mm thread M14x1.25 tube ø 8mm 2 hole fixing cable length 1350mm connection M4 immersion heater connection length 26mm		
accessories for	416604		
	GEV No.	521103	Ref. No. —
	nut thread M4 H 3mm WS 7 brass Qty 20 pcs		
	GEV No.	521104	Ref. No. —
	washer ID ø 4.3mm ED ø 8mm thickness 0.5mm brass Qty 20 pcs for thread M4		
	GEV No.	528401	Ref. No. —
	flat gasket fibre ED ø 22mm ID ø 16mm thickness 2mm Qty 1 pcs		
	GEV No.	560111	Ref. No. —
	plain washer ID ø 4.3mm ED ø 9mm thickness 0.8mm SS Qty 20 pcs DIN 125A for thread M4		
	GEV No.	560131	Ref. No. —
	hexagonal nut thread M4 H 3.2mm WS 7 SS DIN/ISO DIN 934 / ISO 4032/8673 Qty 20 pcs		

heating elements for hot counters

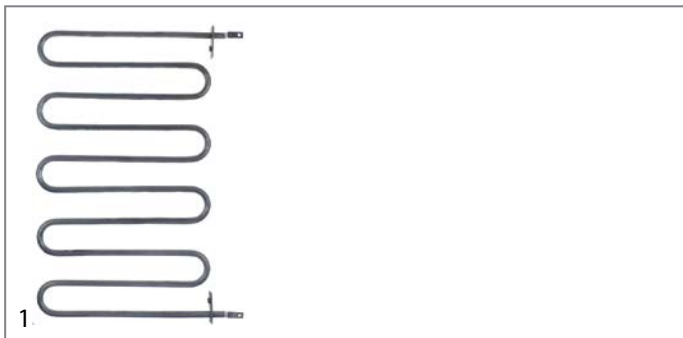

GEV No.	420039	Ref. No.	A02030937
description	heating element 260W 230V heating circuits 1 L 221mm W 363mm tube ø 8mm connection male faston 6.3mm screw lug length 40mm lug width 15mm		



heating elements for refrigeration

heating elements for defrosting



GEV No.	420024	Ref. No.	PADR660
description	heating element 150W 230V L 190mm W 215mm Hmm L1 30mm L2 160mm W1 180mm W2 35mm cable length 1500mm tube ø 6.5mm refrigeration		



GEV No.	420023	Ref. No.	24500040100600 PAER600
description	heating element 300W 230V L 405mm W 110mm L1 35mm L2 370mm W1 50mm W2 60mm cable length 700mm tube ø 6.5mm refrigeration for evaporator		



GEV No.	420150	Ref. No.	GN650BT.01
description	heating element 400W 230V L 290mm W 75mm H 90mm L1 60mm L2 230mm W1 16mm W2 43mm connection spate terminal M4 cable length 1200mm tube ø 10mm refrigeration for evaporator		

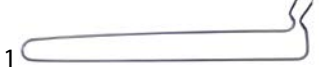

GEV No.	420021	Ref. No.	24500040100601 PAER601
description	heating element 420W 230V L 685mm W 120mm L1 35mm L2 650mm W1 50mm W2 70mm cable length 1500mm tube ø 6.5mm refrigeration for evaporator		



GEV No.	420020	Ref. No.	24500040100688 PAER688
description	heating element 700W 230V L 490mm W 100mm L1 28mm L2 462mm W1 70mm W2 30mm cable length 700mm tube ø 6.5mm refrigeration for evaporator		



GEV No.	420153	Ref. No.	GN1410BT.01
description	heating element 700W L 590mm W 75mm H 115mm L1 60mm L2 530mm W1 13.5mm W2 48mm connection spate terminal M4 cable length 1700mm tube ø 10mm immersion heater refrigeration		



GEV No.	420022	Ref. No.	24500040100689 PAER689
description	heating element 900W 230V L 685mm W 110mm L1 32mm L2 653mm W1 70mm W2 40mm cable length 700mm tube ø 6.5mm refrigeration for evaporator		



GEV No.	420025	Ref. No.	PADR191
description	heating element L 120mm W 320mm Hmm L1 30mm L2 90mm W1 280mm W2 40mm cable length 710/930mm tube ø 6.5mm refrigeration		

heating elements for tilting bratt pan



GEV No.	416607	Ref. No.	X273000
description	heating element 1500W 230V L 417mm W 95mm H 46mm connection M4 dry heating element heating circuits 1 tube ø 9mm connection distance 77mm		

heating elements for contact grills



GEV No.	419013	Ref. No.	A039855
description	heating element 1000W 230V L 178mm W 180mm H 40mm tube ø 6.25mm connection M4 connection length 22mm dry heating element windings 3 for contact grill		



GEV No.	419002	Ref. No.	A041537
description	heating element 1400W 230V heating circuits 1 L 175mm W 305mm H 20mm W1 40mm W2 325mm tube ø 6.3mm windings 5		



GEV No.	419003	Ref. No.	A041538
description	heating element 1550W 240V L 175mm W 305mm H 40mm tube ø 6.3mm connection M4 windings 5		



GEV No.	419012	Ref. No.	A039854
description	heating element 800W 230V heating circuits 1 L 175mm W 183mm H 15mm W1 40mm W2 102mm tube ø 6.6mm windings 3 connection M4 mounting pos. upper dry heating element for contact grill		

heating elements for pizza ovens

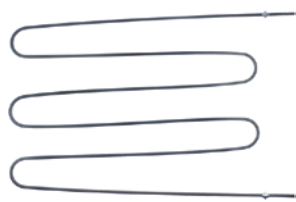

GEV No.	420041	Ref. No.	RESIS013
description	heating element 3000W 230V L 690mm W 460mm thread 1/4" mounting distance 452mm connection M5 tube ø 8.5mm heating circuits 1 for pizza oven mounting pos. upper/lower		

heating elements for pizza presses

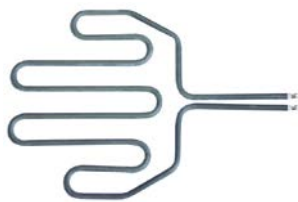

GEV No.	416458	Ref. No.	5590700
description	heating element 1500W 230V L 375mm W 268mm connection male faston 6.3mm L1 137mm L2 238mm W1 120mm W2 28mm dry heating element tube ø 8.5mm windings 4		



GEV No.	416309	Ref. No.	5590710
description	heating element 2000W 230V L 260mm W 260mm heating circuits 1 cable length 290mm connection length 10mm tube ø 6.2mm windings 8 connection distance 59mm		

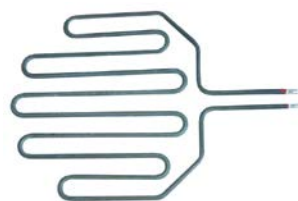

GEV No.	416459	Ref. No.	5590750
description	heating element 2500W 230V L 494mm W 335mm connection male faston 6.3mm connection length 22mm L1 160mm L2 334mm W1 155mm W2 34mm dry heating element tube ø 8.5mm windings 5		

heating elements for salamanders/toast-



GEV No.	418862	Ref. No.	EB-600-15
description	heating element 2000W 230V heating circuits 1 L 235mm W 215mm H 35mm thread M12x1 mounting distance 209mm connection length 48mm tube ø 6.3mm salamander grill		

1

GEV No.	420046	Ref. No.	A039856
description	heating element 2800W 230V heating circuits 1 L 240mm W 350mm H 25mm thread M12x1 mounting distance 342mm tube ø 8.5mm connection M4		

heating elements for heating bridges



1

GEV No.	420019	Ref. No.	A01140015
description	heating element 900W 230V heating circuits 1 L 335mm W 110mm connection M4 tube ø 9.7mm connection distance 100mm		

heating elements for heated cabinets

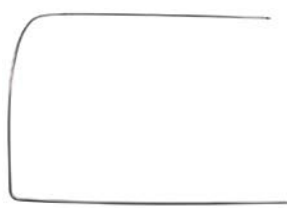

1

GEV No.	418743	Ref. No.	040576
description	heating element 1200W 230V L 220mm W 680mm H 700mm heated cabinet		



1

GEV No.	418742	Ref. No.	040577
description	heating element 750W 230V L 220mm W 360mm H 690mm heated cabinet		

heating cables

connection on both sides

with wire end ferrules



1

GEV No.	420027	Ref. No.	PAAE015
description	heating cable 19W 12V L 2500mm L1 (unheated) 1000mm L2 (heated) 1500mm for defrost drain ø 3mm		



1

GEV No.	420517	Ref. No.	PAPE340
description	heating cable 75W 12V L 6200mm L1 (unheated) 800mm L2 (heated) 5400mm door frame heating ø 3mm Qty 1		

heating plates



1

GEV No.	420053	Ref. No.	SHELRZ125000 SHELRZ1250000
description	hot plate 1250W heating circuits 1 cable length 1100mm H 3mm L 390mm W 190mm		
For models:	524056		

quartz heating elements



1

GEV No.	420048	Ref. No.	A015160016
description	quartz heating element 340W 76V L 385mm ø 11mm connection eye for model A151.600		



1



GEV No.	420047	Ref. No.	A041032
description	quartz heating element 425W 120V L 385mm ø 11mm connection eye for model A151.300		

immersion heating elements

3 hole flange ø47.5mm





1

GEV No.	417440	Ref. No.	230111	
description	heating element 4900W 230V mounting ø 47.5mm heating circuits 3 L 330mm W 32mm H 34mm number of thermostat sleeves 1 thermostat sleeves ø 7mm length thermostat sleeves 177mm thermostat sleeve not clinging tube ø 6.5mm hole distance 62mm hole ø 8mm connection M4 3 hole flange immersion heater			
accessories for	417440			
	GEV No.	510408	Ref. No.	456002
	O-ring EPDM thickness 5.34mm ID ø 47mm Qty 1 pcs			
	GEV No.	510562	Ref. No.	—
	O-ring silicone thickness 5.34mm ID ø 47mm Qty 1 pcs			





1

GEV No.	416240	Ref. No.	230083 230083C
description	heating element 6545W 230/400V mounting \varnothing 48mm heating circuits 3 L 355mm W 31mm H 37mm number of thermostat sleeves 1 thermostat sleeves \varnothing 7mm length thermostat sleeves 175mm thermostat sleeve upper centre not clinging tube \varnothing 6.5mm hole distance 63mm hole \varnothing 10mm connection M4 3 hole flange immersion heater		
accessories for	416240		
	GEV No.	510408	Ref. No. 456002
	O-ring EPDM thickness 5.34mm ID \varnothing 47mm Qty 1 pcs		
	GEV No.	510562	Ref. No. —
	O-ring silicone thickness 5.34mm ID \varnothing 47mm Qty 1 pcs		





1

GEV No.	419043	Ref. No.	230117
description	heating element 7600W 400V mounting \varnothing 47.5mm heating circuits 3 L 330mm W 40mm H 35mm number of thermostat sleeves 1 thermostat sleeves \varnothing 7.5mm length thermostat sleeves 180mm thermostat sleeve eccentric, non clinging tube \varnothing 8.5mm hole distance 63mm hole \varnothing 10mm connection length 25mm connection M4 3 hole flange immersion heater		
accessories for	419043		
	GEV No.	510408	Ref. No. 456002
	O-ring EPDM thickness 5.34mm ID \varnothing 47mm Qty 1 pcs		



1

GEV No.	416241	Ref. No.	230020C
description	heating element 8000W 230V mounting \varnothing 47.5mm heating circuits 3 L 355mm W 35mm H 35mm number of thermostat sleeves 1 thermostat sleeves \varnothing 7.5mm length thermostat sleeves 185mm thermostat sleeve not clinging tube \varnothing 6.3mm hole distance 64mm hole \varnothing 8mm connection M4 3 hole flange immersion heater		
spare parts for	416241		
	GEV No.	510408	Ref. No. 456002
	O-ring EPDM thickness 5.34mm ID \varnothing 47mm Qty 1 pcs		
accessories for	416241		
	GEV No.	510093	Ref. No. 69870
	protection cap		
	GEV No.	510408	Ref. No. 456002
	O-ring EPDM thickness 5.34mm ID \varnothing 47mm Qty 1 pcs		

accessories for 416241

	GEV No.	510562	Ref. No. —
	O-ring silicone thickness 5.34mm ID \varnothing 47mm Qty 1 pcs		



1

GEV No.	416242	Ref. No.	80398C
description	heating element 9500W 230V mounting \varnothing 47.5mm heating circuits 3 L 330mm W 35mm H 35mm number of thermostat sleeves 1 thermostat sleeves \varnothing 7mm length thermostat sleeves 175mm thermostat sleeve eccentric, non clinging tube \varnothing 8.5mm hole distance 72mm hole \varnothing 8/10mm connection M4 3 hole flange immersion heater		
spare parts for	416242		
	GEV No.	510408	Ref. No. 456002
	O-ring EPDM thickness 5.34mm ID \varnothing 47mm Qty 1 pcs		

3 hole flange \varnothing 57.5mm





1

GEV No.	416229	Ref. No.	0303001
description	heating element 2400W 230V mounting \varnothing 57.5mm heating circuits 2 L 235mm W 37mm H 35mm number of thermostat sleeves 1 thermostat sleeves \varnothing 7mm length thermostat sleeves 225mm thermostat sleeve not clinging tube \varnothing 8mm hole distance 75mm hole \varnothing 7.8mm connection length 29mm connection M5 3 hole flange immersion heater		



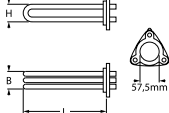

1

GEV No.	416230	Ref. No.	0300011
description	heating element 3000W 230V mounting \varnothing 57.5mm heating circuits 3 L 235mm W 34mm H 48mm number of thermostat sleeves 1 thermostat sleeves \varnothing 7mm length thermostat sleeves 215mm thermostat sleeve upper tube \varnothing 8.5mm hole distance 72mm hole \varnothing 10mm connection length 20mm connection M5 3 hole flange immersion heater		
spare parts for	416230		
	GEV No.	510409	Ref. No. 0200041
	O-ring EPDM thickness 5.34mm ID \varnothing 56.52mm Qty 1 pcs		



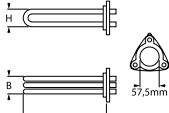

1

GEV No.	416231	Ref. No.	0300002
description	heating element 4500W 230V mounting \varnothing 57.5mm heating circuits 3 L 307mm W 45mm H 36mm number of thermostat sleeves 1 thermostat sleeves \varnothing 7mm length thermostat sleeves 210mm thermostat sleeve eccentric, non clinging tube \varnothing 8.5mm hole distance 74mm hole \varnothing 8/10mm connection M5 3 hole flange immersion heater		
spare parts for	416231		
	GEV No.	510409	Ref. No. 0200041
	O-ring EPDM thickness 5.34mm ID \varnothing 56.52mm Qty 1 pcs		
accessories for	416231		
	GEV No.	520258	Ref. No. 0301112
	protection cap		



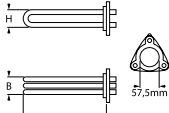

1

GEV No.	416232	Ref. No.	0300012
description	heating element 6000W 230V mounting \varnothing 57.5mm heating circuits 3 L 293mm W 40mm H 36mm number of thermostat sleeves 1 thermostat sleeves \varnothing 7mm length thermostat sleeves 280mm thermostat sleeve eccentric, non clinging tube \varnothing 8.5mm hole distance 74mm hole \varnothing 8x10mm connection M5 3 hole flange immersion heater		
spare parts for	416232		
	GEV No.	510409	Ref. No. 0200041
	O-ring EPDM thickness 5.34mm ID \varnothing 56.52mm Qty 1 pcs		



1

GEV No.	416233	Ref. No.	0300299
description	heating element 9000W 230V mounting \varnothing 57.5mm heating circuits 3 L 440mm W 42mm H 38mm number of thermostat sleeves 1 thermostat sleeves \varnothing 7.5mm length thermostat sleeves 290mm thermostat sleeve eccentric, non clinging tube \varnothing 8.5mm hole distance 73mm hole \varnothing 8/10mm connection M5 3 hole flange immersion heater		
accessories for	416233		
	GEV No.	520258	Ref. No. 0301112
	protection cap		

with compression flange 50 x 26mm



1

GEV No.	420331	Ref. No.	230112
description	heating element 1400W 230V compression flange flange 50x26mm L 160mm heating circuits 1 H 29mm W 190mm connection male faston 6.3mm immersion heater tube \varnothing 8.4mm		
spare parts for	420331		
	GEV No.	510387	Ref. No. 437086
	gasket L 46mm W 22mm \varnothing mm EPDM for heating element for flange 50x26mm		
	GEV No.	510388	Ref. No. —
	counterflange \varnothing mm hole distance mm perforation \varnothing mm L 43mm W 21mm SS for heating element for flange 50x26mm		

with expansion flange 70 x 18mm



1

GEV No.	416381	Ref. No.	R223005 R223005000
description	heating element 2000W 230V heating circuits 1 flange 70x18mm L 280mm W 78mm H 22mm connection M4 immersion heater expansion flange tube \varnothing 8.5mm		
accessories for	416381		
	GEV No.	510429	Ref. No. —
	gasket L 76mm W 23mm hole distance 25mm 3 holes for heating element type DB 70 without thermostat sensor hole		



1

GEV No.	416382	Ref. No.	Z203601000
description	heating element 2800W 230V heating circuits 1 flange 70x18mm L 370mm W 102mm H 27mm immersion heater tube \varnothing 8.5mm		

miscellaneous



GEV No.	417542	Ref. No.	AX24-0006
description	heating element 3x3000W 230V heating circuits 3 L 305mm W 68mm H 40mm number of thermostat sleeves 1 thermostat sleeves ø 3.3mm length thermostat sleeves 970mm thermostat sleeve upper right tube ø 8.5mm hole distance 77x67mm hole ø 7.9mm connection screw immersion heater flange width 95mm flange length 83mm with gasket		
accessories for	417542		
	GEV No.	Ref. No.	AX24-0002



GEV No.	417197	Ref. No.	T323006000
description	heating element 9000W 230V heating circuits 3 L 280mm W 78mm H 35mm hole distance 48mm hole ø 6mm tube ø 8.5mm flange length 105mm flange width 60mm immersion heater thermostat sleeves ø 3mm number of thermostat sleeves 1 length thermostat sleeves 115mm		
accessories for	417197		
	GEV No.	Ref. No.	T323007000

1 1/4"



GEV No.	416225	Ref. No.	0303042
description	heating element 2400W 230V heating circuits 3 thread 1 1/4 L 275mm W 90mm H 40mm L1 25mm L2 50mm L3 200mm W1 31mm W2 28mm H1 20mm H2 20mm connection M4 immersion heater tube ø 6.3mm flange with thread connection length 40mm WS 32		
spare parts for	416225		
	GEV No.	Ref. No.	—
accessories for	416225		
	GEV No.	Ref. No.	—
	GEV No.	Ref. No.	—
	GEV No.	Ref. No.	—



GEV No.	416227	Ref. No.	0303044
description	heating element 1000W 230V heating circuits 1 L 195mm W 40mm thread 1/4" mounting distance 32mm tube ø 8mm 2 hole fixing immersion heater connection male faston 6.3mm		
accessories for	416227		
	GEV No.	Ref. No.	—
	GEV No.	Ref. No.	—
	GEV No.	Ref. No.	—
	GEV No.	Ref. No.	—



GEV No.	416228	Ref. No.	0300067
description	heating element 2000W 230V heating circuits 1 L 197mm W 46mm H 33mm thread 1/4" mounting distance 38mm tube ø 8.5mm connection male faston 6.3mm immersion heater 2 hole fixing		
accessories for	416228		
	GEV No.	Ref. No.	—
	GEV No.	Ref. No.	—
	GEV No.	Ref. No.	—
	GEV No.	Ref. No.	—

heating elements for convection

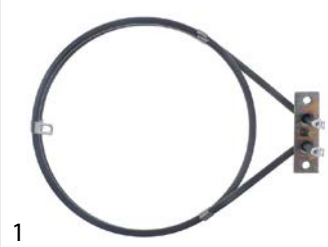

GEV No.	420038	Ref. No.	A0YXD1A4A16
description	heating element 1260W 230V heating circuits 1 ID ø 181mm ED ø 193mm L 240mm H 29mm L1 39mm W1 30mm H1 12mm H2 17mm flange length 70mm flange width 22mm hole distance 56mm connection male faston 6.3mm tube ø 6.6mm hole ø 6mm		

1

GEV No.	419004	Ref. No.	010578052
description	heating element 3100W 230V heating circuits 1 ID ø 223mm ED ø 239mm L 260mm H 60mm L1 20mm W1 23mm H1 20mm H2 40mm flange length 100mm flange width 22mm hole distance 86mm connection M4 tube ø 6.3mm hole ø 5.2mm		

1-circuit



1

GEV No.	490047	Ref. No.	65.32987
description	radiation heater ø 230mm 2100W 230V heating circuits 1 7-position control with temperature signalization connections 4+2 connection type male faston 6.3mm EGO		



1

GEV No.	417544	Ref. No.	AX00-0005
description	heating element 3x3000W 230V heating circuits 3 ID ø 375mm ED ø 400mm L 455mm H 200mm L1 45mm W1 160mm H1 20mm H2 110mm flange length 210mm flange width 25mm hole distance 30mm connection screw connection length 90mm tube ø 8.5mm convection heating element hole ø 7.6mm rectangular flange combi-steamer		
accessories for	417544		
	GEV No.	521127	Ref. No. AX00-0008
	gasket L 210mm W 24mm thickness 2mm for heating element		

2-circuit



1

GEV No.	490134	Ref. No.	65.35285
description	radiation heater ø 230mm 2200W 230V heating circuits 2		

hot plates

round

with radiused edge

for domestic and commercial kitchens



1

GEV No.	490012	Ref. No.	65.17745 U803002
description	hot plate ø 145mm 1500W 230V connection 4 screw clamps with 8mm spill ring		



1

GEV No.	490016	Ref. No.	65.50952
description	hot plate ø 180mm 2000W 230V connection 4 screw clamps with 8mm spill ring		

radiation heaters

square



1

GEV No.	490159	Ref. No.	65.35283
description	radiation heater L 300mm W 300mm 3500W 230V connections 3 square without pan detection EGO		
spare parts for	490159		
	GEV No.	499157	Ref. No. —
	protection pipe for temperature probe ceramic L 297mm ED ø 7mm ID ø 5mm		



1

GEV No.	490020	Ref. No.	U803000
description	hot plate ø 220mm 2600W 230V connection 4 screw clamps with 8mm spill ring		
accessories for	490020		
	GEV No.	550796	Ref. No.
	fixing plate for hot plate ø220mm		



1

GEV No.	416191	Ref. No.	HD-TW-022
description	hot plate ø 90mm 450W 230V connection 3 screw clamps with 8mm spill ring		
For models:	884904		

energy regulators

EGO

1-circuit



1

GEV No.	380016	Ref. No.	65.35287
description	energy regulator 230V 12A dual circuit turn direction right with operation switch 1-pole		



1

GEV No.	380015	Ref. No.	05057021010 HD-TW-010
description	energy regulator 230V 13A single-circuit turn direction right shaft ø 6x4.6mm shaft L 23mm mounting thread M4 power release 6-100% no. 50.57021.010		

DIAMOND



1

GEV No.	380032	Ref. No.	EB-600-08
description	energy regulator 230V 13.5A turn direction right shaft ø 6x4.6mm shaft L 23mm mounting thread M4 equiv. no. 45ER104C1		

thermostats

bi-metal thermostats

safety bi-metal thermostats



1

GEV No.	390708	Ref. No.	A039889
description	bi-metal safety thermostat hole distance 23.5mm switch-off temp. 180°C 1NC 1-pole 16A connection M3 mounting ø 15mm		





1

GEV No.	375913	Ref. No.	0300302
description	bi-metal safety thermostat hole distance 23.8mm switch-off temp. 105°C 1NC 1-pole 16A connection F6.3 2 hole fixing mounting ø 18mm		





1

GEV No.	390233	Ref. No.	926189
description	bi-metal safety thermostat hole distance 24mm switch-off temp. 110°C 1NC 1-pole 16A connection F6.3 2 hole fixing without holder		
accessories for	390233		
	GEV No.	504736	Ref. No.
	bracket for contact thermostat		
	GEV No.	550388	Ref. No.
	bracket for contact thermostat mounting distance 24.5mm mounting ø 3.8		





			
1			
GEV No.	390681	Ref. No.	0300301
description	bi-metal safety thermostat hole distance 40mm switch-off temp. 105°C 2NC 2-pole 16A 250V connection F6.3		

			
1			
GEV No.	390451	Ref. No.	R213004
description	bi-metal safety thermostat hole distance mm switch-off temp. 115°C 1NC 1-pole 16A connection F6.3		
accessories for	390451		
	GEV No.	505093	Ref. No.
			—
	 gasket for thermostat ED ø 35mm ID ø 24mm thickness 7mm equiv. no. N503017		

			
1			
GEV No.	390318	Ref. No.	236047
description	bi-metal safety thermostat switch-off temp. 95°C 1-pole 2 hole fixing		

bi-metal thermostats

			
1			
GEV No.	390301	Ref. No.	236035
description	bi-metal thermostat hole distance 23.8mm switch-off temp. 60°C 1NC 1-pole 16A connection F6.3 2 hole fixing		

			
1			
GEV No.	390680	Ref. No.	0300303
description	bi-metal thermostat hole distance 23.8mm switch-off temp. 65°C 1NC 1-pole 16A connection F6.3 2 hole fixing		

			
1			
GEV No.	390319	Ref. No.	236048
description	bi-metal thermostat hole distance 23.8mm switch-off temp. 80°C 1NC 1-pole 16A connection F6.3 2 hole fixing		

			
1			
GEV No.	390504	Ref. No.	236052
description	bi-metal thermostat hole distance 23.8mm switch-off temp. 90°C 1NO 1-pole 16A 250V connection F6.3 2 hole fixing probe ø 16mm		

			
1			
GEV No.	390397	Ref. No.	YFKO-025
description	bi-metal thermostat hole distance mm switch-off temp. 95°C 1NC 10A 250V connection F6.3		

control and safety thermostats

EGO

control thermostats

55.10/19_ series

			
1			
GEV No.	375273	Ref. No.	5320400
description	thermostat t.max. 200°C temperature range 60-200°C 1-pole 1NO 16A probe ø 6mm probe L 74mm capillary pipe 1500mm capillary pipe isolated mm gland nut shaft L 23mm shaft position upper rotation 270°		

			
1			
GEV No.	375270	Ref. No.	GH400-016
description	thermostat t.max. 295°C temperature range 45-295°C 1-pole 1NO 16A probe ø 4mm probe L 100mm capillary pipe 900mm capillary pipe isolated 350mm gland nut shaft L 23mm shaft position upper rotation 270°		

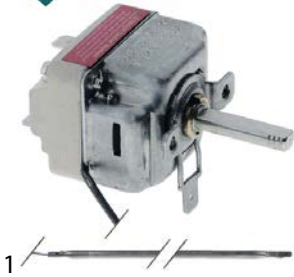

GEV No.	375247	Ref. No.	TERMO001
description	thermostat t.max. 500°C temperature range 75-500°C 1-pole 1NO 16A probe ø 4mm probe L 228mm capillary pipe 900mm capillary pipe isolatedmm gland nut shaft ø 6x4.6mm shaft L 23mm shaft position upper rotation 270°		

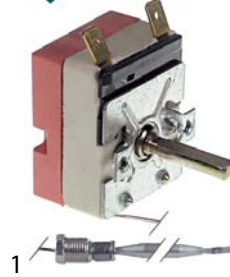

GEV No.	375788	Ref. No.	65.28980
description	thermostat t.max. 175°C temperature range 101-175°C 1-pole 1NO 16A probe ø 6mm probe L 98mm capillary pipe 870mm capillary pipe isolated 800mm gland nut shaft ø 6x4.6mm shaft L 23mm shaft position upper rotation 270°		

55.13_series



GEV No.	390719	Ref. No.	A02030935
description	thermostat t.max. 110°C temperature range 30-110°C 1-pole 1NC 16A probe ø 6mm probe L 115mm capillary pipe 830mm capillary pipe isolatedmm gland nut shaft ø 6x4.6mm shaft L 23mm shaft position left rotation 270°		



GEV No.	375517	Ref. No.	A039882
description	thermostat t.max. 190°C temperature range 60-190°C 1-pole 1NO 16A probe ø 6mm probe L 77mm capillary pipe 870mm capillary pipe isolatedmm gland nut shaft ø 6/4.6mm shaft L 23mm shaft position left* rotation 270°		

accessories for	375517			
	GEV No.	512205	Ref. No.	—
	gasket for temperature probe ED ø 15mm plastic Qty 1 pcs			



GEV No.	375007	Ref. No.	65.28195
description	thermostat t.max. 110°C temperature range 30-110°C 1-pole 1NO 16A probe ø 6mm probe L 113mm capillary pipe 870mm capillary pipe isolatedmm gland nut M9x1 shaft L 25mm shaft position upper rotation 270°		

accessories for 375007

	GEV No.	110119	Ref. No.	—
description	knob thermostat t.max. 110°C ø 50mm shaft ø 6x4.6mm shaft flat upper black temperature range 30-110°C rotation 270°			
	GEV No.	110241	Ref. No.	—
description	knob thermostat t.max. 110°C ø 50mm shaft ø 6x4.6mm shaft flat upper black temperature range 30-110°C			



GEV No.	375615	Ref. No.	0KG20509
description	thermostat t.max. 200°C temperature range 68-200°C 1-pole 1NO 16A probe ø 6mm probe L 78mm capillary pipe 870mm capillary pipe isolatedmm gland nut shaft ø 6x4.6mm shaft L 25mm shaft position left* rotation 270° probe material SS		

GEV No.	375087	Ref. No.	65.53670
description	thermostat t.max. 300°C temperature range 50-300°C 1-pole 1CO 16A probe ø 3.03mm probe L 160mm capillary pipe 1130mm capillary pipe isolated 1103mm gland nut shaft L 23mm shaft position upper rotation 270°		







GEV No.	375505	Ref. No.	01044465 A039884
description	thermostat t.max. 320°C temperature range 50-320°C 1-pole 1NO 16A probe ø 3mm probe L 160mm capillary pipe 870mm capillary pipe isolatedmm gland nut shaft ø 6x4.6mm shaft L 23mm shaft position upper rotation 270°		



GEV No.	375006	Ref. No.	040575
description	thermostat t.max. 85°C temperature range 30-85°C 1-pole 1CO 16A probe ø 6mm probe L 92mm capillary pipe 3150mm capillary pipe isolated 300mm gland nut shaft L 23mm shaft position upper rotation 270° probe material SS		



GEV No.	375005	Ref. No.	YFKO-018
description	thermostat t.max. 85°C temperature range 30-85°C 1-pole 1NO 16A probe ø 6mm probe L 92mm capillary pipe 830mm capillary pipe isolatedmm gland nut shaft L 23mm shaft position upper rotation 270° probe material SS		
accessories for	375005		
	GEV No.	110109	Ref. No. —
	knob thermostat t.max. 85°C ø 60mm shaft ø 6x4.6mm shaft flat upper silver temperature range 30-85°C rotation 270°		
	GEV No.	110133	Ref. No. —
	knob thermostat t.max. 85°C ø 50mm shaft ø 6x4.6mm shaft flat upper black temperature range 30-85°C rotation 270°		
	GEV No.	110240	Ref. No. —
	knob thermostat t.max. 85°C ø 50mm shaft ø 6x4.6mm shaft flat upper black temperature range 30-85°C		



GEV No.	375130	Ref. No.	Z203014
description	thermostat t.max. 90°C temperature range 32-90°C 1-pole 1CO 16A probe ø 6mm probe L 129mm capillary pipe 710mm capillary pipe isolated 500mm gland nut shaft ø 6x4.6mm shaft L 23mm shaft position upper rotation 270°		

55.17_series



GEV No.	390729	Ref. No.	SHELST01A100
description	thermostat t.max. 85°C 1-pole probe ø 6mm probe L 91mm capillary pipe 880mm capillary pipe isolatedmm gland nut shaft ø 6x4.6mm shaft L 16mm		



safety thermostats

55.11_series



GEV No.	375120	Ref. No.	X033001
description	safety thermostat switch-off temp. 245°C 1-pole 16A probe ø 6mm probe L 77mm capillary pipe 2290mm capillary pipe isolated 2260mm gland nut probe SS		

55.32_series



GEV No.	376047	Ref. No.	65.39942
description	safety rod thermostat switch-off temp. 368°C 3-pole 3NO 16A probe ø 3mm probe L 160mm capillary pipe 1490mm capillary pipe isolated 76mm		

55.33_series



GEV No.	375796	Ref. No.	65.37879
description	safety thermostat switch-off temp. 220°C 3-pole 3NC 20A probe ø 6mm probe L 107mm capillary pipe 870mm capillary pipe isolated 800mm gland nut probe		

control thermostats with operation switch

55.34_series



GEV No.	376050	Ref. No.	65.35284
description	thermostat t.max. 650°C temperature range 100-650°C 1-pole 1NO probe ø 3.9mm probe L 228mm capillary pipe 1110mm capillary pipe isolated 800mm gland nut shaft ø 6x4.6mm shaft L 24mm shaft position lower rotation 270° outer switch 2NO		

IMIT / TEMPOMATIC / ARATHERMO

control thermostats



GEV No.	390713	Ref. No.	24500040100152 PTMM152
description	thermostat t.max. 100°C temperature range 30-90°C 1-pole 1NC 16A probe ø 6mm probe L 98mm capillary pipe 900mm capillary pipe isolatedmm gland nut shaft ø 6x4.6mm shaft L 18mm shaft position upper rotation 270° probe material copper		

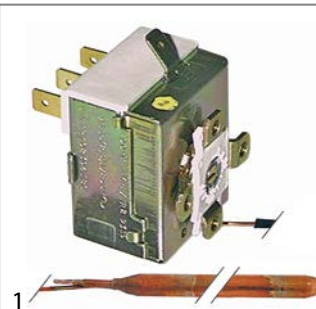

GEV No.	390460	Ref. No.	0300005
description	thermostat t.max. 90°C temperature range 30-90°C 1-pole 1CO 16A probe ø 6.5mm probe L 95mm capillary pipe 2000mm capillary pipe isolated 1950mm gland nut shaft ømm shaft Lmm shaft position rotation 270° probe material copper		





GEV No.	390718	Ref. No.	A0YXD1A4A11
description	thermostat temperature range 50-300°C 1-pole 1NO 20A probe ø 3mm probe L 190mm capillary pipe 900mm shaft ø 6x4.6mm shaft L 12.5mm shaft position upper rotation 270° 250V		

safety thermostats

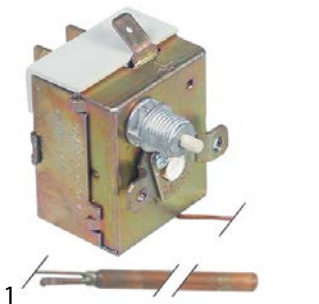

GEV No.	390751	Ref. No.	0300305
description	safety thermostat switch-off temp. 80°C 1-pole 1CO probe ø 5mm probe L 131mm capillary pipe 1000mm capillary pipe isolated 930mm gland nut probe		



GEV No.	390458	Ref. No.	0300004
description	safety thermostat switch-off temp. 90-110°C 1-pole 16A probe ø 6.5mm probe L 90mm capillary pipe 2000mm capillary pipe isolated 1950mm gland nut probe		



GEV No.	390770	Ref. No.	927057
description	safety thermostat switch-off temp. 90-110°C 1-pole 1CO 16/0.5A probe ø 6.5mm probe L 90mm capillary pipe 2000mm capillary pipe isolated 1950mm gland nut probe		

CAEM

control thermostats



GEV No.	390686	Ref. No.	236043
description	thermostat t.max. 83°C temperature range°C 1-pole 1CO 20A probe ø 6mm probe L 90mm capillary pipe 630mm capillary pipe isolated 550mm gland nut shaft ømm shaft Lmm shaft position rotation 270° probe material copper		

JUMO

safety thermostats



GEV No.	390922	Ref. No.	EA04-0011
description	safety thermostat switch-off temp. 140°C 1-pole 1CO 16A probe ø 5mm probe L 96mm capillary pipe 990mm capillary pipe isolated 880mm gland nut probe copper		



GEV No.	390923	Ref. No.	EA04-0012
description	safety thermostat switch-off temp. 365°C temperature range°C 1-pole 1CO 16A probe ø 4mm probe L 107mm capillary pipe 1190mm capillary pipe isolated 1015mm gland nut shaft ømm screw connection M14x1		



PRODIGY / FIRT

control thermostats



GEV No.	390733	Ref. No.	0300270
description	thermostat t.max. 90°C temperature range 30-90°C 1-pole 16A probe ø 6.5mm probe L 85mm capillary pipe 1350mm capillary pipe isolated 1325mm shaft ø 6x4.6mm shaft L 5mm rotation 270° 230V with knob		

various

safety thermostats



GEV No.	375523	Ref. No.	A039891
description	safety thermostat switch-off temp. 230°C 1-pole 1NC 16A probe ø 4mm probe L 100mm capillary pipe 900mm capillary pipe isolated 410mm gland nut probe		



GEV No.	390720	Ref. No.	A0YXD4A26
description	thermostat switch-off temp. 320°C 1-pole 1NC 16A probe ø 5mm probe L 57mm capillary pipe 870mm capillary pipe isolated 45mm screw connection M10x1		

accessories

probe clips

spring clips

for safety thermostat



GEV No.	551289	Ref. No.	65.35288
description	probe clip for probe ø 4mm metal Qty 1 pcs		

plunger sockets



GEV No.	506059	Ref. No.	0200270
description	thermowell double		



GEV No.	506130	Ref. No.	0300006
description	thermowell thread 1/2" L 107mm SS single ø 6.5mm		

switches and momentary switches

rocker/momentary rocker switches

30x11 mm



GEV No.	345382	Ref. No.	INTER001
description	rocker switch mounting measurements 30x11mm green 1NO/indicator light 250V 16A 0-I connection male faston 6.3mm ambient temperature max. 85°C protection IP40		





GEV No.	301010	Ref. No.	PC187B-026 PC188B-026 PC190B-026
description	rocker switch mounting measurements 30x11mm red 1NO/indicator light 250V 16A 0-I connection male faston 6.3mm ambient temperature max. 85/125°C protection IP40		
accessories for	301010		

	GEV No.	301035	Ref. No.	PC187B-036 PC188B-036 PC190B-036
protective cover mounting measurements 30x11mm				





			
1			
GEV No.	301038	Ref. No.	SHELSWAYA100
description	rocker switch mounting measurements 30x11mm green 1NO/indicator light 250V 16A connection male faston 6.3mm		



			
1			
GEV No.	301039	Ref. No.	24500040100295 PDOF295
description	rocker switch mounting measurements 30x11mm red 1NO/indicator light 250V 16A connection male faston 6.3mm		



			
1			
GEV No.	301035	Ref. No.	PC187B-036 PC188B-036 PC190B-036
description	protective cover mounting measurements 30x11mm		



30x22mm



			
1			
GEV No.	347791	Ref. No.	A040573 HD-TW-008 S900.01 SL0621
description	rocker switch mounting measurements 30x22mm green 2NO 230V 20A illuminated 0-I connection male faston 6.3mm ambient temperature max. 125/55°C protection IP65 with rubber collar		

			
1			
GEV No.	345641	Ref. No.	YFKO-021
description	rocker switch mounting measurements 30x22mm red 2NO 230V 16A illuminated 0-I connection male faston 6.3mm ambient temperature max. 125/55°C protection IP65 with rubber collar		

			
1			
GEV No.	301001	Ref. No.	PDMO290
description	rocker switch mounting measurements 30x22mm red 2NO 250V 16A illuminated 0-I connection male faston 6.3mm ambient temperature max. 125/55°C protection IP65		
accessories for	301001		
	GEV No.	301036	Ref. No. —
protective cover internal size 30x22mm for rocker switch mounting measurementsmm			

			
1			
GEV No.	345491	Ref. No.	Z213033
description	momentary rocker switch mounting measurements 30x22mm orange 1NO/indicator light 250V 16A connection male faston 6.3mm ambient temperature max. 100/55°C protection IP40		
accessories for	345491		
	GEV No.	301036	Ref. No. —
protective cover internal size 30x22mm for rocker switch mounting measurementsmm			

			
1			
GEV No.	301062	Ref. No.	65.40129 SHELSWONA100
description	rocker switch mounting measurements 30x22mm green 2NO 250V 16A illuminated connection male faston 6.3mm ambient temperature max. 100/55°C protection IP40		
accessories for	301062		
	GEV No.	301036	Ref. No. —
protective cover internal size 30x22mm for rocker switch mounting measurementsmm			

			
1			
GEV No.	345647	Ref. No.	RX230-040 RX330-040
description	rocker switch mounting measurements 30x22mm red/red 1NO/NO 250V 16A illuminated I/II connection male faston 6.3mm ambient temperature max. 100/55°C protection IP40		
accessories for	345647		
	GEV No.	301036	Ref. No. —
protective cover internal size 30x22mm for rocker switch mounting measurementsmm			

push/momentary push switches

19x13mm

			
1			
GEV No.	347167	Ref. No.	0301009
description	momentary push switch mounting measurements 19x13mm black 1NO 250V 16A non-illuminated connection male faston 4.8mm 1-pole		



1	GEV No.	359446 ¹	Ref. No.	0301003
description	push switch mounting measurements 19x13mm yellow 2NO 250V 16A illuminated connection male faston 6.3mm ambient temperature max. 125°C protection IP65 with cover cap			

¹illuminated

28.5x28.5mm



1	GEV No.	345498	Ref. No.	0301101
description	momentary push switch mounting measurements 28.5x28.5mm green 2NO 250V 16A connection male faston 6.3mm ambient temperature max. 150°C protection IP40			



1	GEV No.	345497	Ref. No.	0301005
description	push switch mounting measurements 28.5x28.5mm green 2CO 250V 16A connection male faston 6.3mm ambient temperature max. 150°C protection IP40			

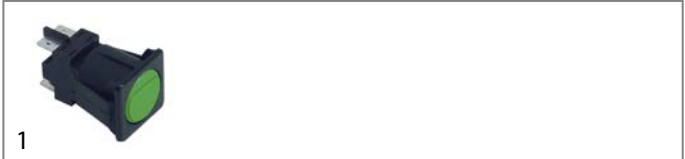

1	GEV No.	345565	Ref. No.	0301000
description	push switch mounting measurements 28.5x28.5mm green 2NO 250V 16A connection male faston 6.3mm ambient temperature max. 150°C protection IP40			



1	GEV No.	345499	Ref. No.	0301004
description	push switch mounting measurements 28.5x28.5mm grey 1CO/1NO 250V 16A connection male faston 6.3mm ambient temperature max. 150°C protection IP40			

30x22mm

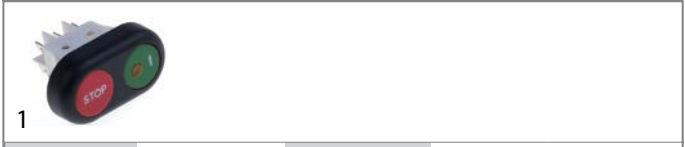

1	GEV No.	345712	Ref. No.	296
description	push switch mounting measurements 30x22mm red/green 2CO 250V 16A Stop / I connection male faston 6.3mm ambient temperature max. 85°C protection IP40 with indicator			

accessories for	345712			
	GEV No.	301127	Ref. No.	285
	protective cover internal size 30x55mm transparent			

ø16mm

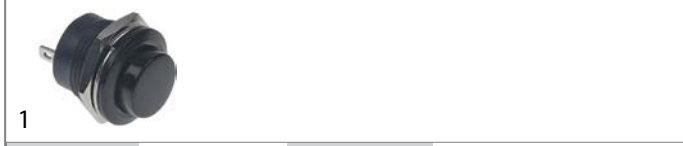

1	GEV No.	347363	Ref. No.	A038978
description	momentary push switch mounting ø 16mm black 1NO 250V 3A connection male faston 4.8mm ambient temperature max. 85°C protection IP40			

ø22mm



1	GEV No.	301058	Ref. No.	653
description	protective cover internal size 30x55mm			



1	GEV No.	301127	Ref. No.	285
description	protective cover internal size 30x55mm transparent			

accessories

fitting parts



1	GEV No.	401785	Ref. No.	S322613
description	mounting plate for switch			

toggle switches

M12x0.75





1	GEV No.	346526	Ref. No.	24500040100960 PDOF960
description	toggle switch thread M12x0.75 1CO 250V 15A ON-ON male faston 6.3mm			



1	GEV No.	347344	Ref. No.	24500040100161 PDOF161
description	toggle switch thread M12x0.75 1NO 250V 15A male faston ON-OFF			



			
1			
GEV No.	346842	Ref. No.	5320050
description	toggle switch thread M12x0.75 2NO 250V 15A male faston ON-OFF		

M12x1			
			
1			
GEV No.	347340	Ref. No.	A01140013
description	toggle switch thread M12x1 1NO 250V 15A ON-OFF screw		

microswitches

lever actuated			
			
1			
GEV No.	345125	Ref. No.	5400250 927246
description	microswitch with lever 250V 16A 1CO connection male faston 6.3mm ambient temperature max. 85°C mounting distance 25mm type C99ZP3 actuating force: 25g lever length 63.5mm		

			
1			
GEV No.	347346	Ref. No.	PTDR503
description	microswitch with lever 250V 16A 1CO connection screw ambient temperature max. 125°C lever length 147mm		

pin-plunger actuated

M10			
			
1			
GEV No.	347341	Ref. No.	A040031
description	microswitch with plunger thread M10x1 thread L 16mm 250V 10A 1NO connection male faston 6.3mm stroke 5mm mounting distance L 41mm ambient temperature max. 85°C type X3L502K6DD actuating force: 130g		

M12			
			
1			
GEV No.	345138	Ref. No.	010578032
description	microswitch with plunger mounting distance 25mm thread M12x1 thread L 12mm 250V 20A 1CO connection screw stroke 7mm L1 13mm ambient temperature max. 85°C type Z15G1307 actuating force: 250g		

with push button			
switches with snap-fit			
			
1			
GEV No.	346772	Ref. No.	GN650TN.48
description	microswitch with push button 250V 5A 1CO connection male faston 4.8mm L 24x27mm ambient temperature max. 85°C actuating force: 160g		

			
1			
GEV No.	347347	Ref. No.	PTDR729
description	microswitch with push button 250V 5A 1NO connection male faston 4.8mm L 29x25mm ambient temperature max. 85°C		

roller actuated

roller 0°			
			
1			
GEV No.	345639	Ref. No.	5400100
description	microswitch with roller plunger 230V 16A 1CO connection solder/ screw connection L1 49mm ambient temperature max. 125°C thread L 14mm thread M10 mounting distance 25mm actuating force: 300g type MS15-1		

roller 90°			
			
1			
GEV No.	347434	Ref. No.	8301380
description	microswitch with roller 250V 16A 1NO ambient temperature max. 85°C thread M12x1		

system switches (ROLD)

			
1			
GEV No.	345537	Ref. No.	0301051
description	element holder mounting measurements 20.6x16.4mm grey arched for push buttons 13x17mm		





			
1			
GEV No.	347151	Ref. No.	226121
description	element holder mounting measurements 23.6x14.6mm white arched for push buttons 11x21mm		

			
1			
GEV No.	345606	Ref. No.	226071
description	momentary switch unit 2CO 250V 16A connection male faston 6.3mm		

			
1			
GEV No.	347152	Ref. No.	227067
description	push button size 11x21mm blue		

			
1			
GEV No.	346810	Ref. No.	0301068
description	push button size 17x13mm blue		

			
1			
GEV No.	346809	Ref. No.	0301066
description	push button size 17x13mm green		

			
1			
GEV No.	345539	Ref. No.	0301069
description	push button size 17x13mm grey		

			
1			
GEV No.	346572	Ref. No.	0301067
description	push button size 17x13mm yellow		

			
1			
GEV No.	345605	Ref. No.	208010
description	switch 2CO 250V 16A connection male faston 6.3mm		

cam switches

on/off

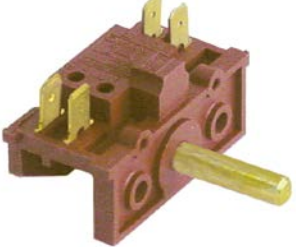
			
1			
GEV No.	345686	Ref. No.	R753000
description	cam switch 2 operating positions 2NO sequence 0-1 10A shaft ø 6x4.6mm shaft L 23mm connection male faston 6.3mm ON-OFF plastic		

7-position

			
1			
GEV No.	300031	Ref. No.	65.53435 U673007 U673007000
description	cam switch 7 operating positions 1NO/2CO sequence 0-1-2-3-4-5-6 16A shaft ø 6x4.6mm shaft L 23mm connection male faston 6.3mm 7-position plastic		

4 operating positions

			
1			
GEV No.	345409	Ref. No.	U673006 U673006000
description	cam switch 4 operating positions 8NO sequence 0-1-2-3 16A shaft ø 6x4.6mm shaft L 23mm connection male faston 6.3mm plastic		

1

GEV No.	347366	Ref. No.	A040081
description	rotary switch 4 operating positions 2NO sequence 0-1-2-3 16A shaft ø 6x4.6mm shaft L 23mm connection male faston 6.3mm 250V A040081 sets of contacts 2 plastic for oven		

operation switches

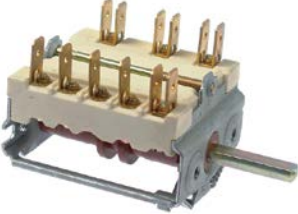

1

GEV No.	300209	Ref. No.	65.52194
description	cam switch 5 operating positions operation switch 16A sequence 0-1-2-3-4 shaft ø 6x4.6mm shaft L 23mm connection male faston ceramic 3-pole ambient temperature max. 330°C		



1

GEV No.	300200	Ref. No.	65.28979
description	operation switch 2 operating positions 2NO 16A sequence 0-1 shaft ø 6x4.6mm shaft L 23mm connection male faston 6.3mm operation switch ceramic		

rotary switches

BREMAS

A1200 series



1

GEV No.	345274	Ref. No.	5320010
description	rotary switch sets of contacts 4 2 0-1 type CA0120004 380V 12A shaft ø 5x5mm shaft L 23mm shaft square connection screw		

GIOVENZANA

rotary switches



1

GEV No.	347634	Ref. No.	5320080
description	rotary switch 2 0-1 sets of contacts 4 type A87AZ69004 690V 20A shaft ø 8x8mm shaft L 15mm shaft star-shaped connection screw		

KRAUS & NAIMER

rotary switches



1

GEV No.	345431	Ref. No.	8301310
description	rotary switch 2 0-1 sets of contacts 4 type 9A003PL-2V 400V 2A shaft ø 6mm shaft L 17mm shaft star-shaped connection screw		

LOVATO



1

GEV No.	347429 ¹	Ref. No.	0301022
description	rotary switch 3 0-1-2 sets of contacts 3 type GN209773U20 690V 20A shaft ø 6x6mm shaft L 15mm shaft square connection screw		
spare parts for	347429		
	GEV No.	112633	Ref. No. 0300352
	knob ø 33mm shaft ø 6x6mm grey		

¹incl. knob



1

GEV No.	345799	Ref. No.	0300206 0301025
description	rotary switch 4 1-2-3-4 sets of contacts 7 type GN20 9779 U20 690V 20A shaft ø 6x6mm shaft L 13.5mm shaft square connection screw		
accessories for	345799		
	GEV No.	112633	Ref. No. 0300352
	knob ø 33mm shaft ø 6x6mm grey		

miscellaneous



1

GEV No.	347367	Ref. No.	A040080
description	rotary switch sets of contacts 2 4 0-1-2-3 type A040080 250V 16A shaft \varnothing 6x4.6mm shaft L 22.5mm with knob connection male faston 6.3mm for oven		
accessories for	347367		
	GEV No.	112626	Ref. No. A040082
	knob oven t.max.°C 41mm shaft \varnothing 6x4.6mm shaft flat lower black		

accessories

levers



1

GEV No.	347168	Ref. No.	0301084
description	lever 0-I lever length 118mm L 90mm W 90mm shaft 8x8mm mounting distance 68x68mm		

magnetic switches

23x14mm



1

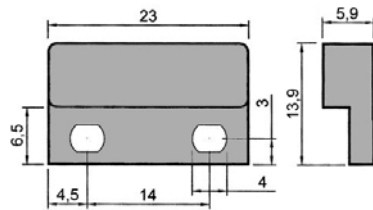



GEV No.	347995	Ref. No.	EA01-0015
description	magnetic switch L 23mm W 14mm 1NO 180V 0.5A P max. 10W connection cable cable length 500mm		

36x13mm

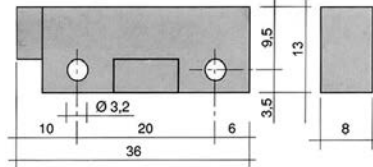

1



GEV No.	345118 ¹	Ref. No.	211002
description	magnetic switch L 36mm W 13mm 1NO 250V 1A P max. 50W connection cable cable length 980mm		
accessories for	345118		
	GEV No.	345399	Ref. No. 0800142 927088
	magnet \varnothing 3.3mm L 40mm H 8mm W 13mm hole distance 30mm M3		

¹with coded connector

40x13mm



1

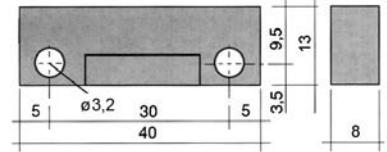

GEV No.	345504	Ref. No.	0300138
description	magnetic switch L 40mm W 13mm 1NO 250V 0.04A P max. 10W connection cable cable length 1000mm		
accessories for	345504		
	GEV No.	345399	Ref. No. 0800142 927088
	magnet \varnothing 3.3mm L 40mm H 8mm W 13mm hole distance 30mm M3		



65x20mm



1

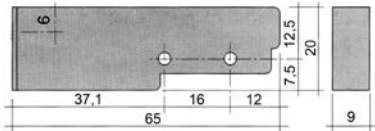

GEV No.	345116	Ref. No.	0300082
description	magnetic switch L 65mm W 20mm 1NO 250V 0.4A P max. 100W connection cable cable length 3000mm		
accessories for	345116		
	GEV No.	345399	Ref. No. 0800142 927088
	magnet ø 3.3mm L 40mm H 8mm W 13mm hole distance 30mm M3		

accessories

magnets



1

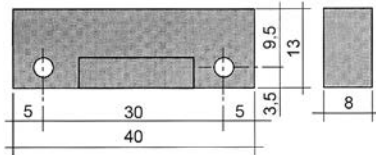

GEV No.	345399	Ref. No.	0800142 927088
description	magnet ø 3.3mm L 40mm H 8mm W 13mm hole distance 30mm M3		



1

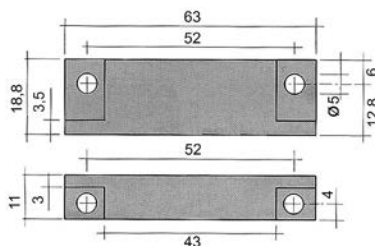

GEV No.	345336	Ref. No.	926014
description	magnet ø 4.8mm L 63mm H 11mm W 18.8mm hole distance 51mm M4		



1

GEV No.	347653	Ref. No.	0800139
description	magnet ø 8mm L 40mm		

magnetic holders



1

GEV No.	347943	Ref. No.	0200623
description	magnet holder H 75mm thread M10x1.5 ø 17mm		

miscellaneous



1

GEV No.	347938	Ref. No.	0406141
description	bracket L 86mm W 10mm H 12mm for magnetic switch SS		

control equipment

SIEMENS

3SB series ø22mm new

switches (complete)



1



GEV No.	347942	Ref. No.	0301010
description	momentary push switch mounting measurements ø22mm blue 1NO non-illuminated		

spare parts for	347942		
	GEV No.	346630	Ref. No. —
	contact block SIEMENS 3SB3400-0B 1NO max 400V 10A black		



1

GEV No.	347944	Ref. No.	0301011
description	momentary push switch mounting measurements ø22mm red 1NC/1NO OFF		

spare parts for	347944		
	GEV No.	346630	Ref. No. —
	contact block SIEMENS 3SB3400-0B 1NO max 400V 10A black		
	GEV No.	346631	Ref. No. —
	contact block SIEMENS 3SB3400-0C 1NC max 400V 10A black		

TELEMECANIQUE (EFA)

XA2 series

switches (complete)



1

GEV No.	345435	Ref. No.	8301060
description	momentary push switch mounting measurements ø22mm 1NO		



1

GEV No.	345461	Ref. No.	8301050
description	mushroom switch mounting measurements ø22mm 1NC EMERGENCY SHUT-DOWN		

spare parts for 345461



GEV No.	345221	Ref. No.	—
description	contact block EFA ZB2BE102 1NC max 230V 10(6)A black		



GEV No.	346660	Ref. No.	—
description	contact block holder		

accessories for 345461



GEV No.	345220	Ref. No.	—
description	contact block EFA ZB2BE101 1NO max 230V 10(6)A black		

miscellaneous



1

GEV No.	347939	Ref. No.	0300397
description	contact block red L 74mm 1NC 1-pole ø 22mm type ECX1030		

accessories for 347939



GEV No.	347940	Ref. No.	0301015
description	emergency stop switch mounting measurements ø22mm red		



1

GEV No.	347940	Ref. No.	0301015
description	emergency stop switch mounting measurements ø22mm red		

accessories for 347940



GEV No.	347939	Ref. No.	0300397
description	contact block red L 74mm 1NC 1-pole ø 22mm type ECX1030		

lamps



1

GEV No.	359807	Ref. No.	0300387
description	light bulb socket Ba9s 24V 2W ø 10mm L 28mm clear		

encoders and potentiometers



1

GEV No.	300225	Ref. No.	FT08060
description	potentiometer 10KOhm		

lamps

indicator lights

indicator lights 2-piece (lens and indicator lamp)

indicator lamps for socket type SA / SC / SD / SF / SR



1

GEV No.	359520	Ref. No.	LAMPA002
description	indicator lamp 400V green connection cable 400mm cable material silicone Qty 1 pcs		

indicator lights 3-piece (housing, lens and bulb)

lamps

light bulbs



1

GEV No.	359807	Ref. No.	0300387
description	light bulb socket Ba9s 24V 2W ø 10mm L 28mm clear		



1

GEV No.	359752	Ref. No.	24500040100158 PEL158
description	light bulb socket E10 220V ø 10mm L 26mm		



indicator lights (complete)

ø 6mm

1	
GEV No.	359005
Ref. No.	216025
description	indicator light ø 6mm 230V yellow cable length 400mm

1	
GEV No.	359434
Ref. No.	0300284
description	indicator light ø 6mm 230V green

ø 9mm

1	
GEV No.	359135
Ref. No.	65.37606
description	indicator light ø 9mm 230V red connection male faston 6.3mm temp.-resist. 120°C with lens

1	
GEV No.	359137
Ref. No.	65.37607
description	indicator light ø 9mm 230V yellow connection male faston 6.3mm temp.-resist. 120°C with lens

ø10mm

with screw socket

1	
GEV No.	359380
Ref. No.	PC187B-025 PC188B-025 PC190B-025
description	indicator light ø 10mm 230V red connection male faston 6.3mm socket screw base

1	
GEV No.	357023
Ref. No.	0301901
description	indicator light ø 10mm 24V green cable length 200mm

1	
GEV No.	360578
Ref. No.	0301907
description	indicator light ø 10mm white 24V connection cable cable length 200mm

1	
GEV No.	360579
Ref. No.	0301902
description	indicator light ø 10mm yellow 24V connection cable cable length 200mm

1	
GEV No.	360481
Ref. No.	SHELSELYSA100
description	indicator light ø 10mm 250V green cable length 300mm socket screw base

with plug-in socket

1	
GEV No.	359040
Ref. No.	YFKO-019
description	indicator light ø 10mm red 230V connection male faston 2.8mm Qty 1 pcs

1	
GEV No.	359138
Ref. No.	RX230-039 RX330-039
description	indicator light ø 10mm red 230V connection male faston 6.3mm Qty 1 pcs

1	
GEV No.	359263
Ref. No.	5371120
description	indicator light ø 10mm

ø12mm

with plug-in socket

1	
GEV No.	359846
Ref. No.	01044466 A039883 EB-600-09
description	indicator light ø 12mm green 230V connection male faston 6.3mm Sinus

1	
GEV No.	360509
Ref. No.	A039887 EB-600-06
description	indicator light ø 12mm yellow 230V connection male faston 6.3mm thermometer

			
1			
GEV No.	359571	Ref. No.	010578014
description	indicator light ø 13mm green 230V connection male faston 6.3mm steaming		

			
1			
GEV No.	359570	Ref. No.	010578012
description	indicator light ø 13mm green 230V connection male faston 6.3mm temperature		



			
1			
GEV No.	359572	Ref. No.	010578015
description	indicator light ø 13mm green 230V connection male faston 6.3mm timer		

			
1			
GEV No.	359898	Ref. No.	Z203004
description	indicator light ø 12mm 230V green connection male faston 6.3mm		

			
1			
GEV No.	505099	Ref. No.	Z203005
description	indicator light ø 12mm 230V yellow		

			
1			
GEV No.	360661	Ref. No.	65.40107
description	indicator light ø 12mm yellow 400V connection cable 700mm		

ø13mm
with screw socket



			
1			
GEV No.	359146	Ref. No.	65.40106
description	indicator light ø 13mm 230V yellow		
accessories for	359146		
	GEV No.	510302	Ref. No. 0200103
	O-ring EPDM ID ø 12.42mm thickness 1.78mm Qty 1 pcs		
	GEV No.	511505	Ref. No. —
	O-ring EPDM thickness 1.78mm ID ø 12.42mm Qty 10 pcs		

with plug-in socket

			
1			
GEV No.	359142	Ref. No.	GH400-015
description	indicator light ø 13mm green 230V connection male faston 6.3mm temp.-resist. 120°C Qty 1 pcs		

			
1			
GEV No.	359143	Ref. No.	EF6L-002 GH400-015A
description	indicator light ø 13mm yellow 230V connection male faston 6.3mm temp.-resist. 120°C Qty 1 pcs		

ø18mm

			
1			
GEV No.	359751	Ref. No.	24500040100155 PEL155
description	indicator light housings mounting measurements 18mm socket E10 red connection male faston 6.3mm/screw connection		
accessories for	359751		
	GEV No.	359752	Ref. No.
	light bulb socket E10 220V ø 10mm L 26mm		

screw-on/push-on fit

light bulbs

for ovens

			
1			
GEV No.	359610	Ref. No.	014034 A0YXD1A4A10
description	light bulb t.max. 300°C socket E14 15W 230V ø 22mm L 47mm lens L 20mm for oven lamp type Philips		

for indicator lights

			
1			
GEV No.	359807	Ref. No.	0300387
description	light bulb socket Ba9s 24V 2W ø 10mm L 28mm clear		

			
1			
GEV No.	359752	Ref. No.	24500040100158 PEL158
description	light bulb socket E10 220V ø 10mm L 26mm		

halogen lamp
for socket G4 / G6.35 / G9

			
1			
GEV No.	359599	Ref. No.	EA13-0100
description	halogen lamp socket G4 12V 20W temp.-resist. 500°C		

			
1			
GEV No.	359946	Ref. No.	A01140014
description	halogen lamp socket G9 230V 40W temp.-resist. 300°C		

linear lamps

<p>halogen lamps</p> 			
1			
GEV No.	359313	Ref. No.	24500040100040 PLH040
description	halogen lamp socket R7s L 117.6mm 230V 150W IMPORT		

sockets for linear lamps

<p>R7s</p> 			
1			
GEV No.	359753 ¹	Ref. No.	24500040100705 PREF705
description	lamp socket socket R7 mounting measurements 146x60mm ømm for length of lamp 117.6mm H 62mm connection cable 450mm mounting distance 175mm with glass plate hot bar 184		

¹only suitable for linear halogen lamps up to max. 160W

fluorescent lamps

<p>fluorescent lamps</p> <p>complete with holder</p> 			
1			
GEV No.	357115	Ref. No.	SHELAR36A100
description	fluorescent lamp L 1224mm W 23mm 28W 220/240V type TCH128 1xTL5-28W/830 HF		

accessories



<p>starter</p> 			
1			
GEV No.	380464	Ref. No.	24500040100166 PSTR166
description	starter 4-65W		

ballasts

			
1			
GEV No.	402563	Ref. No.	24500040100153 PML153
description	electrical ballast 40W 230V for fluorescent lamps		

oven lamps

universal oven lamps
mounting diameter 35.5mm

				
1				
GEV No.	359718	Ref. No.	A0YXD1A4A12	
description	oven lamp mounting ø 35.5mm 230V 15W socket E14 temp.-resist. 300°C connection male faston 6.3mm hard glas			
spare parts for	359718			
	GEV No.	359701	Ref. No.	—
	lamp socket socket E14 220-230V mounting ø 35.5mm connection male faston 6.3mm 15W			
	GEV No.	359740	Ref. No.	—
	light bulb t.max. 300°C socket E14 15W 230V ø 22mm L 48mm lens L 20mm for oven lamp IMPORT			



1

GEV No.	359660	Ref. No.	LAMPA010
description	oven lamp mounting ø 35.5mm 230V 25W socket E14 temp.-resist. 300°C connection male faston 6.3mm hard glas		



1

GEV No.	359661	Ref. No.	VETRO002
description	oven lamp glass thread 32.1 ø 58mm hard glas temp.-resist. 350°C		
accessories for	359661		
	GEV No.	359700	Ref. No. —
	gasket for pizza oven fibre glass ID ø 32.5mm ED ø 55mm thickness 5mm		

lamps

light bulbs



1

GEV No.	359610	Ref. No.	014034 A0YXD1A4A10
description	light bulb t.max. 300°C socket E14 15W 230V ø 22mm L 47mm lens L 20mm for oven lamp type Philips		

halogen lamps

for socket G4 / G6.35 / G9



1

GEV No.	359599	Ref. No.	EA13-0100
description	halogen lamp socket G4 12V 20W temp.-resist. 500°C		



1

GEV No.	359946	Ref. No.	A01140014
description	halogen lamp socket G9 230V 40W temp.-resist. 300°C		

sockets

G9



1

GEV No.	359742	Ref. No.	0200201013
description	lamp socket L 36mm mounting distance 28mm		

timers

programme timers





1

GEV No.	402949	Ref. No.	0300829
description	electronic timer 9.2.21.16G engines chambers operation time 230V shaft ømm shaft Lmm voltage 50/60		





1

GEV No.	360411	Ref. No.	0300818
description	timer CDC 11803 engines 1 chambers 3 operation time 120s 230V shaft ømm shaft Lmm motor type M48R ATS		
spare parts for	360411		
	GEV No.	360118	Ref. No. —
	motor CDC pinion ø 4.9mm teeth 10 230V voltage AC 50/60Hz turn direction right motor ø 47mm H 19.3mm motor type M48R ATS for timer cable length 260mm 1.9/2.5W		



1

GEV No.	360257	Ref. No.	0300117
description	timer CDC 4904F engines 1 chambers 4 operation time 6min 230V shaft ømm shaft Lmm manif. no. 4904F3 / 360257 motor type M48L ATS		
spare parts for	360257		
	GEV No.	360083	Ref. No. —
	motor CDC pinion ø 4.9mm teeth 10 230V turn direction left motor ø 47mm H 19.3mm motor type M48L ATS for timer		



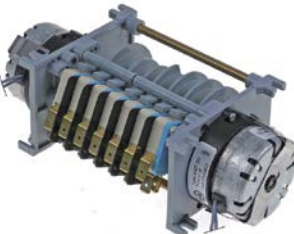

1

GEV No.	360393	Ref. No.	0300803
description	timer CDC 4905 engines 1 chambers 5 operation time 12min 230V shaft ømm shaft Lmm		
spare parts for	360393		
	GEV No.	360118	Ref. No. —
	motor CDC pinion ø 4.9mm teeth 10 230V voltage AC 50/60Hz turn direction right motor ø 47mm H 19.3mm motor type M48R ATS for timer cable length 260mm 1.9/2.5W		





1

GEV No.	360457	Ref. No.	0300822
description	timer CDC 4907DV engines 2 chambers 7 operation time 6s / 8min 24V		
spare parts for	360457		
	GEV No.	360323	Ref. No. —
	motor CDC pinion ø 4.9mm teeth 10 24V voltage AC turn direction left motor ø 47mm H 19.3mm motor type M48L ATS for timer		



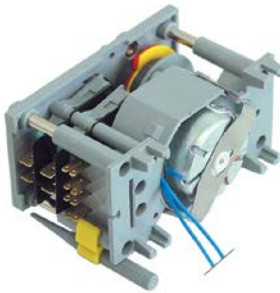

1

GEV No.	360255	Ref. No.	0300806 0300807
description	timer CDC 7003F engines 1 chambers 3 operation time 6min 230V shaft ø 6x4.6mm shaft L 20mm manif. no. 7003F3 / 360255 motor type M37LN		
spare parts for	360255		
	GEV No.	360131	Ref. No. —
	motor CDC pinion ø 5.4mm teeth 12 230V turn direction left motor ø 37mm motor type M37LN for timer		
accessories for	360255		
	GEV No.	110905	Ref. No. 0300049
	knob switch zero mark ø 42mm shaft ø 6x4.6mm shaft flat right black		





1

GEV No.	360254	Ref. No.	0300085
description	timer CDC 7802 engines 1 chambers 2 operation time 60s 230V manif. no. 7802M1 / 0300085 motor type M37RN		
spare parts for	360254		
	GEV No.	360119	Ref. No. —
	motor CDC pinion ø 5.4mm teeth 12 230V turn direction right motor ø 37mm motor type M37RN for timer		





1

GEV No.	360256	Ref. No.	0300143
description	timer CDC 7804F engines 1 chambers 4 operation time 120s 230V shaft ømm shaft Lmm manif. no. 7804F1 / 360256 motor type M37RN		
spare parts for	360256		
	GEV No.	360119	Ref. No. —
	motor CDC pinion ø 5.4mm teeth 12 230V turn direction right motor ø 37mm motor type M37RN for timer		



1

GEV No.	360253	Ref. No.	0300297
description	timer CDC 7804F engines 1 chambers 4 operation time 20min 230V manuf. no. 7804F1 / 0300297 motor type M37RN		
spare parts for	360253		
	GEV No.	360119	Ref. No. —
motor CDC pinion ø 5.4mm teeth 12 230V turn direction right motor ø 37mm motor type M37RN for timer			



1

GEV No.	360580	Ref. No.	0300821
description	timer CDC 7805F engines 1 chambers 5 operation time 120s 230V shaft ømm shaft Lmm manuf. no. 7805F1 motor type M37RN voltage AC		



1

GEV No.	360581	Ref. No.	0300805
description	timer CDC 7805F engines 1 chambers 5 operation time 150s 208V shaft ømm shaft Lmm manuf. no. 7805F1 motor type M37RS voltage AC		



1

GEV No.	360413	Ref. No.	010578024
description	timer FIBER P19 engines 1 chambers 2 operation time 4min 230V 50Hz shaft ømm shaft Lmm		

mechanical timers



1

GEV No.	360470	Ref. No.	010578022
description	timer C53 2-pole operation time 120min impulse mechanical 1NO/1NC at 250V 16A permanent position yes shaft ø 6x4.6mm shaft 6x4.6mm shaft L 23mm mounting distance 28mm		



1

GEV No.	360475	Ref. No.	A0YXD1A4A06
description	timer M11 with bell 1-pole operation time 120min impulse mechanical 1NO at 250V 16A permanent position no shaft ø 6x4.6mm shaft 6x4.6mm shaft L 21mm mounting distance 28mm		



1

GEV No.	360544	Ref. No.	A040897
description	timer M11 with bell 1-pole operation time 15min impulse mechanical 1NO at 250V 16A permanent position no shaft ø 6mm shaft 6x4.6mm shaft L 15mm mounting distance 24mm mounting thread M3 connection male faston 6.3mm		





1

GEV No.	350182	Ref. No.	A0AT93623
description	timer M11 with bell 1-pole operation time 15min impulse mechanical 1NO at 250V 16A permanent position no shaft ø 6x4.6mm shaft 6x4.6mm shaft L 15mm mounting distance 28mm		



			
1			
GEV No.	360510 ¹	Ref. No.	A040895
description	timer M11 with bell 2-pole operation time 15min 2NO at 250V 16A shaft ø 6mm shaft L 15mm connection male faston 6.3mm with knob		
spare parts for	360510		
	GEV No.	112624	Ref. No. A040898
	knob time 15min t.max.°Cø 41mm shaft ø 6mm shaft flat black rosette ø 58mm		
	GEV No.	360476	Ref. No. —
	timer M11 with bell 2-pole operation time 15min 2NO at 250V 16A shaft ø 6mm shaft L 15mm connection male faston 6.3mm		

¹incl. knob

			
1			
GEV No.	350124	Ref. No.	8301080
description	timer M12 1-pole operation time 30min impulse mechanical 1NO at 250V 10A permanent position no shaft ø 6mm shaft 6mm shaft L 15mm mounting distance 28mm		
accessories for	350124		
	GEV No.	110372	Ref. No. —
	dial plate graduation 30min permanent position no rotation 30-330° ø 60mm timers knob ø 45mm		

audible timers

			
1			
GEV No.	360630	Ref. No.	65.27739
description	timer operation time 15min ø 57.6mm shaft ø 6.4x4.8mm shaft L 22.4mm mounting distance 28.5mm		

alarm devices

loudspeakers

			
1			
GEV No.	350211	Ref. No.	EA13-0151
description	loudspeaker ø 50mm built-in depth 16mm 8Ohm 0.5W connection soldering connection cable lengthmm		

contactors

GENERAL ELECTRIC (AEG)

power contactors

			
1			
GEV No.	381345	Ref. No.	65.223002
description	power contactor resistive load 13A 400VAC (AC3/400V) 4A/2.2kW main contacts 4NO auxiliary contacts connection screw connection type 100275 type AEG type GE MC0A400ATU		

			
1			
GEV No.	380237	Ref. No.	0300392
description	power contactor resistive load 16A 230VAC (AC3/400V) 6A/3kW main contacts 3NO auxiliary contacts 1NC connection male faston 6.3mm type AEG LS0701F		

			
1			
GEV No.	380236	Ref. No.	0300059
description	power contactor resistive load 16A 230VAC (AC3/400V) 6A/3kW main contacts 3NO auxiliary contacts 1NO connection male faston 6.3mm type AEG LS0710F		



1

GEV No.	380238	Ref. No.	0300058
description	power contactor resistive load 20A 230VAC (AC3/400V) 8.4A/4kW main contacts 3NO auxiliary contacts 1NO connection screw connection type LS0510A type AEG LS0510A type GE MC1A 310A		



1

GEV No.	380837	Ref. No.	8301090
description	power contactor resistive load 20A 400VAC (AC3/400V) 9A/4kW main contacts 3NO auxiliary contacts 1NO connection screw connection type AEG LS0510A type GE MC1A 310A		



1

GEV No.	380244	Ref. No.	0300390 R663031
description	power contactor resistive load 25A 230VAC (AC3/400V) 9A/4kW main contacts 3NO auxiliary contacts 1NO connection screw connection type AEG LS4K 10A type GE CL00A 310		

SIEMENS

power contactors



1

GEV No.	380390	Ref. No.	80351
description	power contactor resistive load 40A 230VAC (AC3/400V) 12A/5.5kW main contacts 3NO auxiliary contacts connection screw connection type 3RT10-24-1AL20 50/60Hz		

motor protection circuit breakers



1

GEV No.	380541	Ref. No.	DEI35
description	motor protection circuit breaker type 3RV1011-0JA10 setting range 0.7-1A (AC3/400V) 0.25kW		

TELEMECANIQUE (Schneider Electric)

power contactors



1

GEV No.	380479	Ref. No.	0300050
description	power contactor resistive load 25A 230VAC (AC3/400V) 9A/4kW main contacts 3NO auxiliary contacts 1NO/1NC connection screw connection type LC1D09P7		



1

GEV No.	380979	Ref. No.	EA02-0004
description	power contactor resistive load 40A 230VAC (AC3/400V) 25A/11kW main contacts 3NO auxiliary contacts 1NO/1NC connection screw connection type LC1D25P7		



miscellaneous

power contactors



1

GEV No.	380915	Ref. No.	010578021
description	power contactor 230V resistive load 32A main contacts 3NO auxiliary contacts 1NO connection screw type CJX2-1810 SHAPU		

solid state relays

CELDUC



1

GEV No.	402974	Ref. No.	EA02-0203
description	solid state relay CELDUC 2 phase 50A 24-600V 10-30VDC L 58mm W 45mm plug screw type SOB965660		

relays

power relays

with flange mounting



1

GEV No.	380310	Ref. No.	0301745
description	power relays FINDER 230VAC 16A 2CO connection male faston 6.3mm screw mounting at 250VA manuf. no. 62.82.8.230.0000+062.10		

with bracket mounting

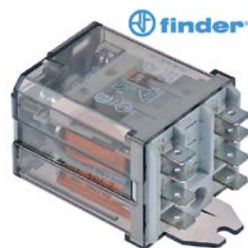

1

GEV No.	380139	Ref. No.	0301747 929115
description	power relays FINDER 230VAC 16A 2CO connection F6.3 bracket mounting dimensions 68x38.2x35.8mm manuf. no. 62.82.8.230.0000		



1

GEV No.	380808	Ref. No.	0301746
description	power relays FINDER 230VAC 16A 3CO connection male faston 6.3mm bracket mounting manuf. no. 62.83.8.230.0000		



1

GEV No.	380702	Ref. No.	229040
description	power relays FINDER 230VAC 16A 3NO connection male faston 6.3mm flange dimensions 36x38x68mm manuf. no. 62.83.8.230.0300 230V		



1

GEV No.	380185	Ref. No.	229029 DER111
description	power relays Italiana Relè 230VAC 30A 1NO connection F6.3 bracket mounting dimensions 36.5x32.2x51.8mm manuf. no. A10-230AC-FA		

1

GEV No.	380368	Ref. No.	RX230-046 RX330-046
description	power relays ZETTLER ELECTRONICS 230VAC 30A 1NO/1NC connection male faston 6.3mm bracket mounting manuf. no. AZ 2280-1A-240AF AZ2280-1C-240AF		

accessories



1

GEV No.	691697	Ref. No.	U805615
description	fastening angle for contactor suitable for		

transformers

open transformers

with cable connection



1

GEV No.	403094	Ref. No.	8301350
description	transformer primary 230/400VAC secondary 24VDC 18VA secondary 0.75A L 57mm W 26mm connection cable 50/60Hz with rectifier		

toroidal core transformers



1

GEV No.	403336	Ref. No.	EA13-0011
description	transformer primary 230VAC secondary 11.5VAC 40VA connection cable 200mm 50Hz		



1

GEV No.	401791	Ref. No.	R723063
description	transformer primary 230VAC secondary 12VAC 15/50VA secondary 2.1A 50/60Hz		

encapsulated transformers

with screw connection



1

GEV No.	403352	Ref. No.	EA13-0008
description	transformer primary 230VAC secondary 17VAC 20VA secondary 1.17A connection screw 50-60Hz type 704077 DIN rail temperature restriction 125°C ambient temperature max. 40°C		

PMA



1

GEV No.	379054	Ref. No.	PMET717
description	transformer primary 230VAC secondary 12VAC 3VA secondary 0.25A H 40mm L 45mm W 50mm connection screw 50/60Hz type 153/M		



electronic controllers

DIXELL

refrigeration controllers

built-in version



1

GEV No.	378256	Ref. No.	S900.02
description	electronic controller DIXELL XR02CX-5N0C0 mounting measurements 71x29mm built-in depth 56mm 230V voltage AC NTC relay outputs 1 CO-8A(4) NTC protection IP54 defrosting function/time control -40 up to +110°C display 2½ digit		
spare parts for	378256		
	GEV No.	Ref. No.	RC0321 S900.32
	temperature probe NTC 10kOhm cable thermoplastic probe -40 up to +110°C cable -40 up to +110°C probe ø6x14mm cable length 3m without screw connection 2-wire		
accessories for	378256		
	GEV No.	Ref. No.	—
	temperature probe NTC 10kOhm cable PVC probe -20 up to +80°C cable -10 up to 100°C probe ø7x24.5mm cable length 1.5m without screw connection 2-wire		
	GEV No.	Ref. No.	—
	temperature probe NTC 10kOhm cable PVC probe -20 up to +80°C cable -10 up to 100°C probe ø6x25mm cable length 3m 2-wire		
	GEV No.	Ref. No.	—
	temperature probe NTC 10kOhm cable thermoplastic probe -40 up to +110°C cable -40 up to +110°C probe ø6x14mm cable length 1.5m without screw connection 2-wire		
	GEV No.	Ref. No.	RC0321 S900.32
	temperature probe NTC 10kOhm cable thermoplastic probe -40 up to +110°C cable -40 up to +110°C probe ø6x14mm cable length 3m without screw connection 2-wire		
	GEV No.	Ref. No.	—
	temperature probe NTC 10kOhm cable silicone probe -40 up to +110°C cable -50 up to +180°C probe ø6x40mm cable length 3m 2-wire		
	GEV No.	Ref. No.	—
	temperature probe NTC 10kOhm cable silicone probe -40 up to +110°C cable -50 up to +180°C probe ø6x40mm cable length 1.5m without screw connection 2-wire		



1

GEV No.	378267	Ref. No.	PR-C153-082 PR-C200-082
description	electronic controller DIXELL XR02CX-5N0C1 mounting measurements 71x29mm built-in depth 56mm 230V voltage AC NTC relay outputs 1 NO-20A(8) NTC DI protection IP54 defrosting function/time control -40 up to +110°C display 2½ digit		
accessories for	378267		
	GEV No.	Ref. No.	RC0321 S900.32
	temperature probe NTC 10kOhm cable thermoplastic probe -40 up to +110°C cable -40 up to +110°C probe ø6x14mm cable length 3m without screw connection 2-wire		
	GEV No.	Ref. No.	—
	temperature probe NTC 10kOhm cable PVC probe -40 up to +110°C cable -10 up to 100°C connection 2-wire thread probe ø6x14mm cable length 3m		



1

GEV No.	378273	Ref. No.	GN650BT.16
description	electronic controller DIXELL XR06CX-5N0C1 mounting measurements 71x29mm 230V voltage AC NTC -40 up to +110°C display 2½ digit DEF Relay 8A fan relay 8A compressor relay 20A		

EKTRON

refrigeration controllers

built-in version



1

GEV No.	378034	Ref. No.	SL0531
description	electronic controller EKTRON type REK31ED-0021 mounting measurements 71x29mm 230V voltage AC NTC/PTC relay outputs 1 CO-8A(4) NTC/PTC NTC/PTC built-in depth 71mm defr. funct. yes -50 up to +95°C display 3 digits		
accessories for	378034		
	GEV No.	Ref. No.	—
	temperature probe PTC 1kOhm cable PVC probe -50 up to +150°C cable -10 up to 100°C probe ø6x30mm cable length 3m without screw connection 2-wire		

Table continues overleaf



accessories for	378034			
	GEV No.	379782	Ref. No.	—
	temperature probe PTC 1kOhm cable thermoplastic probe -50 up to +150°C cable -40 up to +110°C probe ø6x14mm cable length 3m 2-wire resistor 1kOhm			

EVCO - EVERY CONTROL

universal controllers

built-in version



1

GEV No.	379590	Ref. No.	5310060	
description	electronic controller EVERY CONTROL mounting measurements 71x29mm 12V voltage AC TC/J protection IP65 0-500°C type FK400A front measurements 33x75mm			
accessories for	379590			
	GEV No.	379051	Ref. No.	—
	temperature probe thermocouple J (Fe-CuNi) cable Vetrotex probe -50 up to +750°C cable -50 up to +350°C probe ø6x100mm cable length 3m without screw connection cable colours red/blue 2-wire			

KIOUR

universal controllers

built-in version



1

GEV No.	379491	Ref. No.	24500040100696 PKBM696
description	electronic controller KIOUR mounting measurements 71x29mm 230V voltage AC PTC relay outputs 2 -19 up to +99°C display 2 digit REF-BERI-SM V2 12A 30A		

refrigeration controllers

built-in version



1

GEV No.	379494	Ref. No.	PKUR714	
description	electronic controller KIOUR type REF-DF-SM V4.2 mounting measurements 71x29mm 230V voltage AC PTC relay outputs 3 NO-25A NO-5A NO-5A PTC level sensor front measurementsmm built-in depth 76mm protection IP44 accuracy 1% built-in version defr. funct. -19 up to +99°C display 2½ digit			
accessories for	379494			
	GEV No.	378067	Ref. No.	—
	temperature probe PTC 1kOhm cable silicone probe -50 up to +150°C cable -50 up to +180°C probe ø6x40mm cable length 2m without screw connection 2-wire			
	GEV No.	378068	Ref. No.	—
	temperature probe PTC 1kOhm cable silicone probe -50 up to +150°C cable -50 up to +180°C probe ø6x40mm cable length 7m without screw connection 2-wire			
	GEV No.	378069	Ref. No.	—
	temperature probe PTC 1kOhm cable silicone probe -50 up to +150°C cable -50 up to +180°C probe ø6x40mm cable length 15m without screw connection 2-wire			
	GEV No.	378070	Ref. No.	—
	temperature probe PTC 1kOhm cable silicone probe -50 up to +150°C cable -50 up to +180°C probe ø6x40mm cable length 30m without screw connection 2-wire			
	GEV No.	379052	Ref. No.	—
	temperature probe PTC 1kOhm cable silicone probe -50 up to +150°C cable -50 up to +180°C probe ø6x40mm cable length 1.5m without screw connection 2-wire			
	GEV No.	379064	Ref. No.	—
	temperature probe PTC 1kOhm cable silicone probe -50 up to +150°C cable -50 up to +180°C probe ø6x40mm cable length 3m without screw connection 2-wire			

1

GEV No.	379847 ¹	Ref. No.	PETS467 PLDU713
description	electronic controller KIOUR type REF-DF-SM V4.2 mounting measurements 71x29mm 230V voltage AC PTC relay outputs 3 NO-25A NO-5A NO-5A PTC level sensor front measurementsmm built-in depth 76mm protection IP54 accuracy 1% built-in version 1x PTC probe inclusive defr. funct. -19 up to +99°C display 2½ digit		

¹incl. 1x PTC probe





1

GEV No.	379493	Ref. No.	PKUR715
description	electronic controller KIOUR type REF-FR-SM V2.0 mounting measurements 71x29mm 12V voltage AC/DC PTC relay outputs 5 NO-25A NO-5A NO-5A NO-5A NO-5A PTC PTC DI level sensor front measurementsmm built-in depth 76mm protection IP44 accuracy 1% built-in version defr. funct. -19 up to +99°C display 2½ digit		



1

GEV No.	379495	Ref. No.	PBETF460
description	electronic controller KIOUR type REF-FR-SB V3.0 mounting measurements 165x80x52mm 230V voltage AC PTC relay outputs 5 NO-30A NO-10A NO-10A NO-10A NO-10A PTC PTC DI level sensor front measurements 165x80x52mm built-in depthmm protection IP54 accuracy 1% defr. funct. -50 up to +100°C display		
accessories for	379495		
	GEV No.	Ref. No.	—
	control element KIOUR type REF-FR-SP-TOUCH mounting measurements 71x29mmV voltage relay outputs front measurements 88x60mm defr. funct. °C display 3 digits		
	GEV No.	Ref. No.	PKAL465
	ribbon cable 16-pole L 460mm plug type 2 row Qty 1m		

built-in version 2-piece



71 x 29mm

1

GEV No.	379492	Ref. No.	24500029100459 PKUR459
description	control element KIOUR type REF-FR-SP mounting measurements 71x29mmV voltage relay outputs front measurementsmm built-in depth 76mm protection IP54 accuracy 1% built-in version defr. funct. °C display 3 digits		
accessories for	379492		
	GEV No.	Ref. No.	PKAL465
	ribbon cable 16-pole L 460mm plug type 2 row Qty 1m		

accessories



1

GEV No.	400339	Ref. No.	PKAL465
description	ribbon cable 16-pole L 460mm plug type 2 row Qty 1m		



71 x 29mm

1

GEV No.	379809	Ref. No.	PBETS468
description	electronic controller KIOUR type REF-FR-SB V2.0 mounting measurements 71x29mm 230V voltage AC PTC relay outputs 5 NO-25A NO-10A NO-10A NO-10A NO-10A PTC PTC DI level sensor front measurementsmm built-in depth 76mm protection IP54 accuracy 1% yes defr. funct. -50 up to +150°C display 2½ digit		

LAE

refrigeration controllers

built-in version 2-piece



165 x 125mm

1





GEV No.	379484	Ref. No.	PBETF649
description	electronic controller LAE type SSD90B35E-C mounting measurements 165x125mm 230V voltage AC PTC relay outputs 6 NO-20A(6) CO-12A(4) NO-8A(3) NO-8A(3) CO-8A(3) NO-7A(2) PTC PTC DI front measurementsmm built-in depthmm protection IP30 yes -50 up to +150°C display		
accessories for	379484		
	GEV No.	Ref. No.	—
	surface probe PTC 1kOhm cable silicone probe -50 up to +200°C cable -50 up to +180°C connection coded plug thread probe ø6x35mm cable length 2m		

Table continues overleaf



accessories for 379484			
GEV No.	379483	Ref. No.	—
	keypad unit LAE type SMD34RU mounting measurements 185x31mmV voltage relay outputs front measurementsmm built-in depthmm protection IP55°C display 3 digits		
GEV No.	403465	Ref. No.	—
	connection cable LAE type FC10-20M01		

			
1			
GEV No.	379498	Ref. No.	PETF427
description	electronic controller LAE type SMD12RU20 mounting measurements 71x29mm display 3 digits		

SHANGFANG

accessories			
			
1			
GEV No.	379054	Ref. No.	PMET717
description	transformer primary 230VAC secondary 12VAC 3VA secondary 0.25A H 40mm L 45mm W 50mm connection screw 50/60Hz type 153/M		

miscellaneous

speed controllers			
			
1			
GEV No.	401679	Ref. No.	5423300
description	speed controller voltage input 230V/50Hz 1PhV vottage output 0-208/230V 0-240Hz 3PhV 1500W max. 18.4A load current 8.1A length external size 145mm width external size 115mm D 125mm wall-mounted version		

probes

universal probes

temperature probes			
			
1			
GEV No.	379835	Ref. No.	PPRB447
description	temperature probe NTC 2kOhm cable thermoplastic probe -40 up to +110°C cable -40 up to +110°C probe ø6x20mm cable length 2m 2-wire		

			
1			
GEV No.	379161	Ref. No.	RC0321 S900.32
description	temperature probe NTC 10kOhm cable thermoplastic probe -40 up to +110°C cable -40 up to +110°C probe ø6x14mm cable length 3m without screw connection 2-wire		

producer-specific probes

probes			
			
Image not available			
1			
GEV No.	403942	Ref. No.	231016
description	temperature probe		

			
1			
GEV No.	402558	Ref. No.	PPRB478
description	temperature probe PTC cable PVC probe -50 up to +150°C cable -10 up to 100°C connection male faston thread probe ø6x30mm cable length 1.9m		

			
1			
GEV No.	402560	Ref. No.	24500040100168 PPRB168
description	temperature probe PTC cable silicone probe -50 up to +150°C cable -50 up to +180°C connection 2-wire thread probe ø6.5x30mm cable length 1.1m		

			
1			
GEV No.	381239	Ref. No.	EA10-0104
description	temperature probe thermocouple K (NiCr-Ni) cable PTFE probe -50 up to 1150°C cable -40 up to +250°C connection coded plug thread probe ø2x4mm cable length 1.5m		

			
1			
GEV No.	381238	Ref. No.	EA10-0103
description	temperature probe thermocouple K (NiCr-Ni) cable silicone probe -50 up to 1150°C cable -50 up to +180°C connection coded plug thread probe ø1.9x140mm cable length 1.4m		



core probes



1

GEV No.	381234 ¹	Ref. No.	EA10-0113
description	core temperature probe thermocouple K (NiCr-Ni) cable PTFE probe -40 up to +250°C cable -40 up to +250°C connection coded plug probe ø3.9x170mm thread M16x2 cable length 1.4m handle ømm handle length 50mm		

¹ multipoint probe



1

GEV No.	379552	Ref. No.	T113007
description	core temperature probe thermocouple K (NiCr-Ni) cable Vetrotex probe -40 up to +250°C cable -50 up to +350°C connection 2-wire probe ø3x90mm thread cable length 1.65m handle ø 8mm handle length 50mm		

electronics

frequency converters

accessories



1

GEV No.	403356	Ref. No.	EA16-0041
description	braking resistor for frequency converter L 78mm W 29mm H 16mm 20-60W cable length 170mm VW3TR342150RJ 150Ohm		

PCBs

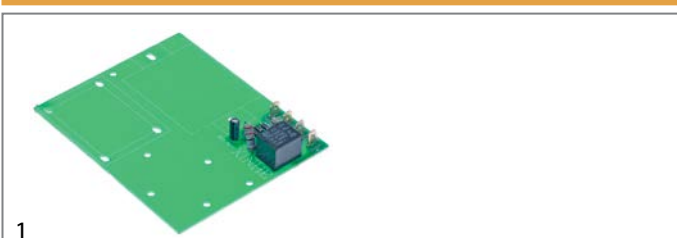

1

GEV No.	403208	Ref. No.	8301960
description	control PCB dough mixers TF17/22/30 TR17/22/30 L 124mm W 102mm 230/400V		

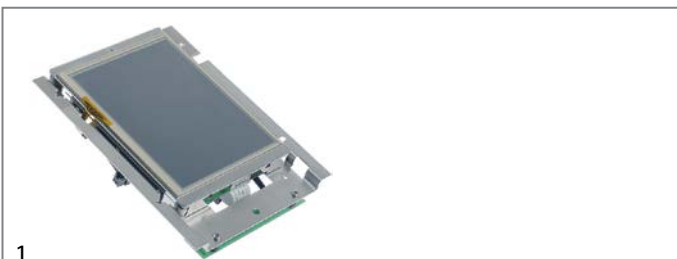

1

GEV No.	404013	Ref. No.	XC10-2000
description	display combi-steamer Blue FreeScale2011 L 170mm W 130mm suitable for RETIGO model XC10-2000-10 with control H 50mm type blue		

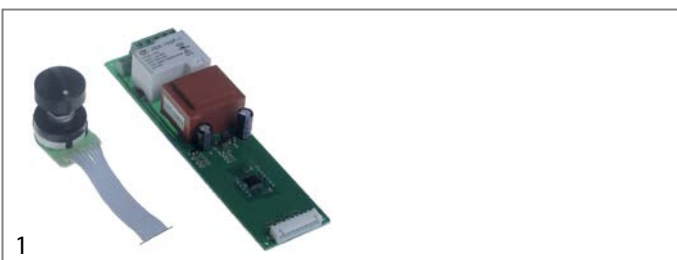

1

GEV No.	402813	Ref. No.	HR600.07
description	display PCB for fridge L 150mm W 37mm suitable for ER400/600 with potentiometer with thermostat type LTC-20HT		

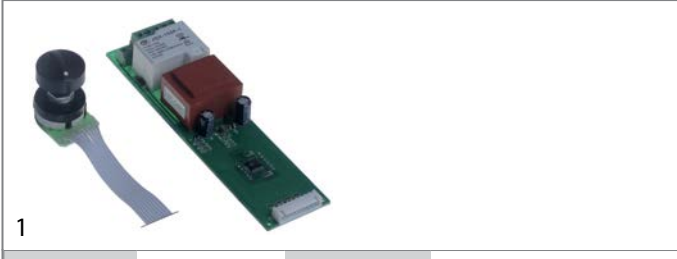

1

GEV No.	402812	Ref. No.	HF600.07
description	display PCB refrigerator EF400/600 L 150mm W 38mm with potentiometer with thermostat type LTC-24HT		



1

GEV No.	401897	Ref. No.	T333003000
description	keypad PCB combi-steamer HGP1021		



1

GEV No.	403102	Ref. No.	227074
description	keypad PCB dishwasher L 170mm W 35mm with display buttons 3		



1

GEV No.	403270	Ref. No.	227083
description	keypad PCB for dishwasher River 252/262 L 220mm W 40mm with display buttons 3		

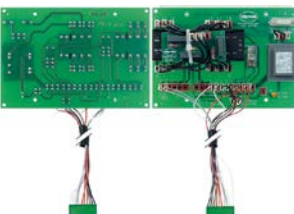

1

GEV No.	400731	Ref. No.	5310090
description	main PCB pizza press Pressy 33/45		



1

GEV No.	401721	Ref. No.	T353003 T353003000
description	PCB combi-steamer HEI 1021/HGV 1021		



1

GEV No.	402880	Ref. No.	215027
description	PCB dishwasher L 152mm W 80mm		



1

GEV No.	692027	Ref. No.	5310000
description	PCB dough rolling machine STP30/40 new edition 230V		



1

GEV No.	401900	Ref. No.	215029
description	PCB L 120mm W 80mm		



1

GEV No.	400785	Ref. No.	359
description	PCB slicer 300SCEP 230V		
accessories for	400785		
	GEV No.	Ref. No.	653
	protective cover internal size 30x55mm		



1

GEV No.	403045	Ref. No.	215032
description	PCB suitable for ELETTOBAR		

1

GEV No.	401290	Ref. No.	5310040
description	PCB time control		



1

GEV No.	404014	Ref. No.	EA14-0080
description	relay PCB combi-steamer B1011/B2011 L 200mm W 115mm model RP20B.15 with ribbon cable H 30mm		



1

GEV No.	401786	Ref. No.	R693058
description	temperatur p.c.b combi-steamer HMI1011		

central units



1

GEV No.	400788	Ref. No.	297
description	control box for slicer 230V		

keypads

front foils

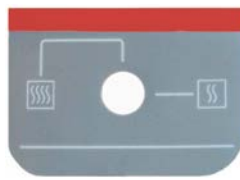

1

GEV No.	400869	Ref. No.	R693000
description	keypad foil combi-steamer HMI1011		



1

GEV No.	506152	Ref. No.	0500230
description	keypad foil dishwasher S200/240		



1

GEV No.	401587	Ref. No.	5800370
description	keypad foil dough rolling machine STP 30/40 P30/40/45/35 Start/ Stop L 100mm W 80mm		

control panel

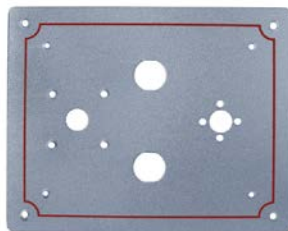

1

GEV No.	697351	Ref. No.	8301040
description	switch panel dough mixers TF17/22/30 TR17/22/30 L 200mm W 160mm		

solenoid valves

solenoid valves (water)

ELBI

straight



1

GEV No.	373017	Ref. No.	240016	
description	solenoid valve single straight 230VAC inlet 3/4" outlet 11.5mm DN10 ELBI			
spare parts for	373017			
	GEV No.	370467	Ref. No.	—
	solenoid valve filter suitable for ELBI			

			
1			
GEV No.	370315	Ref. No.	929172
description	solenoid valve double straight 230VAC inlet 3/4" outlet 11.5mm input 16l/min t.max. 90°C ELBI plastic flow regulating valve inlet black		

ROBERTSHAW/INVENSY

medium temperature: 90°C 90°C 60°C
 ambient temperature: 60°C 25°C 60°C
 duty cycle: 40% 100% 100%

			
1			
GEV No.	372021	Ref. No.	EA12-0050
description	solenoid valve double straight 230VAC inlet 3/4" outlet 11.5mm DN10 EATON (INVENSYS)		

			
1			
GEV No.	372025	Ref. No.	EA12-0056
description	solenoid valve triple straight 230VAC inlet 3/4" outlet 11.5mm DN10 EATON (INVENSYS)		

RPE

reducers

outlet side

			
1			
GEV No.	371247	Ref. No.	EA12-0303
description	reducer RPE flow rate 1-1.25l/min white		























TP			
			
			
1			
GEV No.	370017	Ref. No.	0300025 240011
description	solenoid valve single straight 230VAC inlet 3/4" outlet 11.5mm DN10 TP p max 10bar		
spare parts for	370017		
	GEV No.	371013	Ref. No. —
solenoid coil TP 230VAC 50/60Hz			
accessories for	370017		
	GEV No.	371220	Ref. No. —
reducer TP flow rate 3l/min red tolerance ±15%			
	GEV No.	371221	Ref. No. —
reducer TP flow rate 5.5l/min yellow tolerance ±15%			
	GEV No.	371222	Ref. No. —
reducer TP flow rate 6l/min grey tolerance ±15%			
	GEV No.	371223	Ref. No. —
reducer TP flow rate 10l/min white tolerance ±15%			
	GEV No.	371224	Ref. No. —
reducer TP flow rate 12l/min bronze tolerance ±15%			
	GEV No.	371225	Ref. No. —
reducer TP flow rate 16l/min light brown tolerance ±15%			
	GEV No.	371226	Ref. No. —
reducer TP flow rate 20l/min red tolerance ±15%			
	GEV No.	371230	Ref. No. —
reducer TP flow rate 0.25l/min red tolerance ±25%			
	GEV No.	371231	Ref. No. —
reducer TP flow rate 0.35l/min violet tolerance ±25%			
	GEV No.	371232	Ref. No. —
reducer TP flow rate 0.5l/min orange tolerance ±25%			
	GEV No.	371233	Ref. No. —
reducer TP flow rate 0.8l/min white tolerance ±25%			
	GEV No.	371234	Ref. No. —
reducer TP flow rate 1l/min light blue tolerance ±25%			
	GEV No.	371235	Ref. No. —
reducer TP flow rate 1.2l/min brown tolerance ±25%			
	GEV No.	371236	Ref. No. —
reducer TP flow rate 1.5l/min light brown tolerance ±25%			



Table continues overleaf





accessories for 370017	
	GEV No. 371237 Ref. No. — reducer TP flow rate 2.5l/min yellow tolerance ±25%
	GEV No. 371238 Ref. No. — reducer TP flow rate 3.4l/min dark green tolerance ±25%
	GEV No. 371239 Ref. No. — reducer TP flow rate 5l/min black tolerance ±25%
	GEV No. 371240 Ref. No. — reducer TP flow rate 8l/min blue tolerance ±20%



various	
	
1	
GEV No. 370241	Ref. No. 0301149
description	solenoid valve 2-fold, with reducer straight 230VAC suitable for Lamber

	
1	
GEV No. 370726	Ref. No. 999288
description	solenoid valve double straight 220-240VAC inlet 11mm outlet 11mm MILANO plastic output B red

	
1	
GEV No. 370636	Ref. No. 240020
description	solenoid valve single CO 230VAC outlet 10.5mm MILANO 00168401 plastic 3-ways inlet 10.5mm 50/60Hz male faston 6.3mm
accessories for 370636	
	GEV No. 371142 Ref. No. 133009 reducer for solenoid valve ø 8.2mm

	
1	
GEV No. 370589	Ref. No. A0YXD4A39
description	solenoid valve single straight inlet 3/4" ET outlet 11.5mm male faston 6.3mm

metal	
BÜRKERT	
solenoid valves (various)	
	
1	
GEV No. 370544	Ref. No. 0300173
description	solenoid valve 2-ways 24VAC inlet 1/2" outlet 1/2" L 65mm DN 13mm BÜRKERT membranes NBR 24V brass

SIRAI	
2-way	
L180-B series	
	
1	
GEV No. 370391	Ref. No. 0300070
description	solenoid valve 2-ways 24VAC connection 3/4" L 79mm DN 18mm -10 up to +90°C coil type Z610A membranes NBR (water) p max 12bar p min 0.35bar
accessories for 370391	
	GEV No. 371091 Ref. No. — power socket plug type DIN 43650B cable lengthmm small



solenoid valves (refrigeration)

CASTEL

valves



1

GEV No.	370588	Ref. No.	PELV457
description	solenoid valve NC type 1028/2 S 230V connection 1/4" soldering connection -35 up to +105°C CASTEL refrigeration straight		

Solenoid valve - accessories



1

GEV No.	371142	Ref. No.	133009
description	reducer for solenoid valve ø 8.2mm		

pressure switches

for warewashing

ø 58mm with male faston 6.3mm

with connection horizontal



1

GEV No.	541842	Ref. No.	0301503
description	pressure control pressure range 100/40mbar connection 6mm ø 58mm pressure connection horizontal warewashing pressure connection ø 5.5mm		

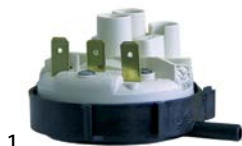

1

GEV No.	541011	Ref. No.	0301501
description	pressure control pressure range 110/70mbar connection 6mm ø 58mm pressure connection horizontal warewashing		



1

GEV No.	541899	Ref. No.	224025
description	pressure control pressure range 125/105mbar connection 6mm ø 58mm pressure connection horizontal warewashing pressure connection ø 6mm		



1

GEV No.	541898	Ref. No.	224023
description	pressure control pressure range 165/140mbar connection 6mm ø 58mm pressure connection horizontal warewashing pressure connection ø 6mm		



1

GEV No.	541105	Ref. No.	926049
description	pressure control pressure range 180/70mbar connection 6mm ø 58mm pressure connection horizontal warewashing		



1

GEV No.	541165	Ref. No.	0300026
description	pressure control pressure range 60/30mbar connection 6mm ø 58mm pressure connection horizontal warewashing pressure connection ø 6mm		



1

GEV No.	541017	Ref. No.	69850
description	pressure control with mounting strap pressure range 40/20mbar connection 6mm ø 58mm pressure connection horizontal warewashing		



for steam control



1

GEV No.	541769	Ref. No.	S093000
description	pressure control ø 45mm kettle pressure range up to 1.0bar connection 1/4" 250V 8A p max 1bar pressure connection 1/4"		

electrodes



1

GEV No.	403353	Ref. No.	AC24-0602
description	level electrode push-in total length 225mm probe L 185mm insulated probe length 170mm triple connection bullet connector ø 15mm level suitable for RETIGO for 611/1011/1221/2011 edition boiler		

compressors

ACC/ZEL

R134A

LBP monophase

Lower evaporation temperature below -20°C



1

GEV No.	605126	Ref. No.	RC0047 S900.41
description	compressor coolant R134a type OF1350A 220-240V 50Hz LBPkg 1/4HP power input 158W cylinder capacity 7.5cm ³ RSIR H 183mmWWWWWWWWW ZEL		

EMBRACO / ASPERA

R134A

LBP monophase

Lower evaporation temperature below -20°C



1

GEV No.	605129	Ref. No.	PR-C153-072 PR-C200-072 SHSGKM0104A2
description	compressor coolant R134a type FF 8.5HBK 220-240V 50Hz LMBP cylinder capacity 7.95cm ³		

HMBP monophase

High/Medium evaporation temperature above -20/-15 °C



1

GEV No.	605244	Ref. No.	GN1410TN.11
description	compressor coolant R134a type FF112HBK 220-240V 50Hz HMBP 10.8kg 1/3HP cylinder capacity 11.15cm ³ CSIR H 180mm 223W 304W 405W 527W 671W 836W 1024W 1236W 1471W test method EN 12900		



electric components

L'UNITE HERMETIQUE / TECUMSEH

R134A

HMBP monophase

High/Medium evaporation temperature above -20/-15 °C



GEV No.	605159	Ref. No.	PCOM529
description	compressor coolant R134a type AE4430Y-FZ1A 220-240V 50Hz HMBP 9.7kg 1/4HP power inputW cylinder capacity 8cm ³ CSIR H 200mmWWW 294W 382W 488W 613W 760W 930W 1127W		



GEV No.	605188	Ref. No.	PCOM424
description	compressor coolant R134a type AE4440Y-FZ 220-240V 50Hz HMBP 10kg 1/3HP cylinder capacity 10.33cm ³ CSIR H 200mmWWW 399W 508W 637W 790W 968W 1176W		



GEV No.	605160	Ref. No.	PCOM521
description	compressor coolant R134a type CAJ4461Y 220-240V 50Hz HMBP 20kg 1/2HP power input 728W cylinder capacity 18.3cm ³ CSIR H 258mmWWW 475W 642W 856W 1115W 1421WW		
For models:	524001		

R404A

LBP monophase

Lower evaporation temperature below -20°C



GEV No.	605134	Ref. No.	PCOM497
description	compressor coolant R404A type CAJ2446Z 220-240V 50Hz LBP 23kg 1.2HP cylinder capacity 26.1cm ³ CSR H 280mm 797W 1110W 1423W 1821W 2290WWWWW 549W		

evaporation and condensing trays

evaporation trays heated



GEV No.	750394	Ref. No.	PSEN100 PSEN802
description	evaporation tray complete with heating element and level electrode L 245mm W 30mm H 235mm 230V 150W		

fans

axial fans

import



GEV No.	601909 ¹	Ref. No.	ZA21-0007
description	axial fan L 119mm W 119mm H 38mm 220-240 50/60Hz 31/29W bearing ball bearing connection male faston 2.8mm		

¹with ball bearings



1

GEV No.	601604 ¹	Ref. No.	PR-C153-057 PR-C200-057 RC0011 S900.34
description	axial fan L 119mm W 119mm H 38mm 230VAC 50/60Hz 17/15W bearing slide bearing manuf. no. AA1282HS-AT connection cable 300mm fan wheel ø 110mm temp.-resist. 70°C input current 0.1A airflow 130m ³ /h 2600rpm		

¹with slide bearings



1

GEV No.	601510 ¹	Ref. No.	PFC523 PFC524
description	axial fan L 119mm W 119mm H 38mm 230VAC 50/60Hz 22/21W bearing ball bearing connection male faston 6.3mm SUNON temp.-resist. 70°C		

¹with ball bearings



1

GEV No.	601055 ¹	Ref. No.	GN2100TN.35
description	axial fan L 92mm W 92mm H 25mm 230VAC 50/60Hz 14.5/14W bearing ball bearing connection male faston 2.8mm metal ADDA fan wheel ø 85mm temp.-resist. 70°C		
accessories for	601055		
	GEV No.	550898	Ref. No. —
	connecting cable cable length 2000mm connection F 2.8 connection distance 7.9mm for axial flow fan		
	GEV No.	691103	Ref. No. —
	guard ø 90mm mounting distance 83mm for axial fan 92mm		

¹with ball bearings

refrigeration fans

refrigeration motors universal

ebm-papst

miscellaneous



1

GEV No.	601783	Ref. No.	GN650TN.34 S900.37
description	fan motor 10W 230V 50/60Hz L3 87mm W 67mm cable length 400mm 1300rpm ebm-papst M4Q045-CA03-51/C18 3 mounting options bearing slide bearing for refrigerated counters		
spare parts for	601783		
	GEV No.	601413	Ref. No. —
	fixing plate suitable for fanwheel ED ø 32mm shaft ø 7 mounting distance 26mm		
accessories for	601783		
	GEV No.	601385	Ref. No. —
	fan wheel sucking ø 172mm fan wheel mounting 25.4mm blade angle 34° W 42mm aluminium		

ELCO

N series - standard



1

GEV No.	601966 ¹	Ref. No.	PR-C153-068
description	fan motor ELCO 18W 230V 50/60Hz bearing slide bearing L1 91mm L2 83mm L3mm W 83mm cable lengthmm 1300/1550rpm 5 mounting options VNT18-30/517		
accessories for	601966		
	GEV No.	601892	Ref. No. —
	connector cable ELCO cable length 1500mm 0.75mm ² protection IP42 for Plug-In		

¹with coded connector

IMPORT

multi fit fan motors



GEV No.	601022	Ref. No.	PEM406
description	fan motor 10W 230V 50-60Hz L1 44mm L2 54mm L3 85mm W 84mm cable length 500mm 1300rpm YZF10-20-18/26 5 mounting options bearing slide bearing		



GEV No.	601023	Ref. No.	PEM624
description	fan motor 16W 230V 50-60Hz L1 45mm L2 61mm L3 92mm W 84mm cable length 500mm 1300rpm YZF16-25-18/26 5 mounting options bearing slide bearing		

accessories

fan wheels

aluminium

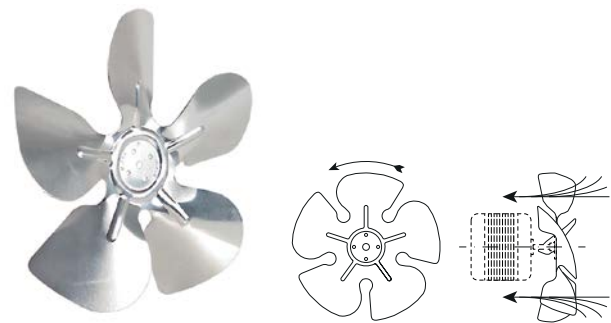

GEV No.	601283	Ref. No.	PFEM408 PFEM630
description	fan wheel sucking ø 230mm fan wheel mounting 25.4mm blade angle 28° W 41mm aluminium		

GEV No.	601284	Ref. No.	PR-C153-066 PR-C200-066
description	fan wheel sucking ø 254mm fan wheel mounting 25.4mm blade angle 28° W 42mm aluminium		

cooling motors (complete)

GEV No.	601739	Ref. No.	GN650BT.11 RC0229
description	fan 230V 10W 50Hz fan wheel ø 230mm shaft L 20mm L 86mm W 67mm blade angle 34° connection spate terminal M4 cable length 1100mm		
spare parts for	601739		
	GEV No.	601172	Ref. No. —
	fan wheel sucking ø 230mm fan wheel mounting 25.4mm blade angle 34° W 50mm aluminium		
	GEV No.	601757	Ref. No. —
	fan motor 10W 230V 50/60Hz L1 43.5mm L3 82mm W 67mm cable length 1500mm 1300/1550rpm ebm-papst M4Q045-CA03-75 5 mounting options bearing slide bearing		
	GEV No.	601783	Ref. No. GN650TN.34 S900.37
	fan motor 10W 230V 50/60Hz L3 87mm W 67mm cable length 400mm 1300rpm ebm-papst M4Q045-CA03-51/C18 3 mounting options bearing slide bearing for refrigerated counters		

GEV No.	601702	Ref. No.	SHSGFM53A100
description	fan 230V 10W 50Hz fan wheel ø 254mm feet depth 84mm blade angle 28°		

hot air motors



1

GEV No.	601690	Ref. No.	010578043
description	fan motor 230V 50Hz 0.09kW 2450rpm L1 80mm L2 20mm L3 35mm L4 20mm D1 ø 12mm D2 ø 8x6mm M5		

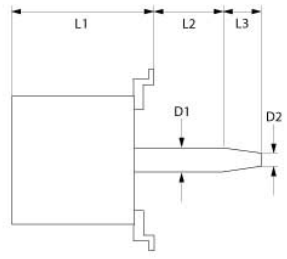
1

GEV No.	499311	Ref. No.	EA11-0014
description	fan motor 440V 3 phase 50Hz 0.3kW 1410rpm speeds 1 L1 130mm L2 22mm L3 38mm M10 1.2/0.7A at 50Hz 1410rpm D1 ø 17mm D2 ø 13.5mm		



1

GEV No.	601688	Ref. No.	010578050
description	fan wheel D1 ø 200mm H1 43mm blades 39 D2 ø 8x6mm D3 ø 8mm H2 29mm		



1

GEV No.	602001	Ref. No.	AX09-0001
description	fan wheel D1 ø 320mm H1 83mm blades 12 D2 ø 13mm D3 ø 16.4mm H2 12mm H3 18mm		



1

GEV No.	551259	Ref. No.	AX00-0006
description	gasket motor shaft gasket ID ø 16.5mm ED ø 29mm thickness 4.2mm		

hot air fans

miscellaneous



1

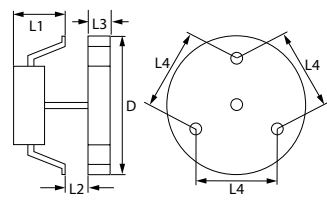

GEV No.	601125	Ref. No.	0A036410
description	hot air fan 220-240V 45W 50/60Hz L1 70mm L2 11mm L3 25mm L4 87mm fan wheel ø 150mm FIME type C30R0479CLF		
accessories for	601125		
GEV No.	550879	Ref. No.	—
description	insulation ø 130mm thickness 3mm hole ø 20mm for hot air fan		

speed controllers



1

GEV No.	401679	Ref. No.	5423300
description	speed controller voltage input 230V/50Hz 1PhV vottage output 0-208/230V 0-240Hz 3PhV 1500W max. 18.4A load current 8.1A length external size 145mm width external size 115mm D 125mm wall-mounted version		

motors

gear motors

for ovens

for flues



1

GEV No.	601912	Ref. No.	EA11-0012
description	gear motor FIBER type P245J01C128 230V voltage AC 50Hz shaft \varnothing 6.3mm L 71.5mm W 56.5mm H 46.5mm motor type M51BJ0L0000/ M51BJ0R0000		

for dishwashers



1

GEV No.	601861	Ref. No.	927105
description	gear motor FIR type 71-B5 180W 400V voltage AC 50/60Hz 3 phase 900/1100rpm shaft \varnothing 14mm L 227mm for transport system without gearbox		

motors

for slicers

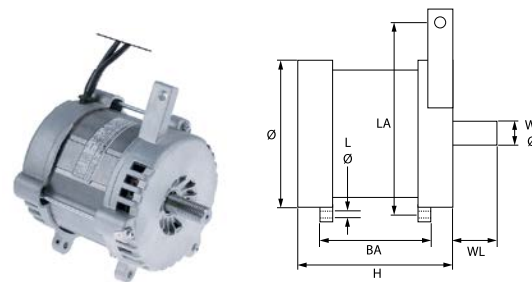

1

GEV No.	500973	Ref. No.	425
description	motor 230V 1 phase 180W 50Hz 1380rpm shaft \varnothing 15mm shaft length 28mm \varnothing 115mm H 112mm mounting distance 75mm hole distance 145mm hole \varnothing 6mm type H60-425 300 ELETTRMECANICA capacitor 10 μ F		

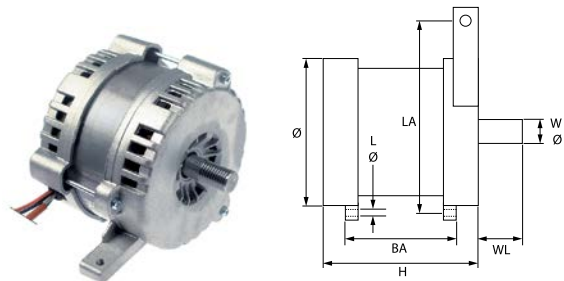

1

GEV No.	500912	Ref. No.	510
description	motor 230V 1 phase 50Hz 1380rpm shaft \varnothing 15mm shaft length 28mm \varnothing 115mm H 92mm mounting distance 49mm hole distance 145mm hole \varnothing 6mm type H40-510 250 ELETTRMECANICA		



universal



1

GEV No.	500471	Ref. No.	8300530
description	motor 1100W 400V 50/60Hz 3 phase shaft ø 19mm flange ø 120mm 1370/1700rpm type AT80C4 ø 160mm H 200mm L 250mm Lafert		



1

GEV No.	500903	Ref. No.	5420200
description	motor 250W 230V 50Hz 1 phase shaft ø 14mm flange ø 160mm 1400rpm type M71B4 ø 140mm H 180mm L 220mm ICME 0.25kW		



1

GEV No.	500821	Ref. No.	5420300
description	motor 370W 230V 50Hz 1 phase shaft ø 14mm flange ø 160mm 1400rpm ø 140mm H 180mm L 220mm ICME 0.37kW		



1

GEV No.	601179	Ref. No.	5420800
description	motor 550W 230/400V 50Hz 3 phase shaft ø 14mm flange ø 105mm 1400rpm type T71BX4 ø 140mm H 170mm L 220mm ICME 0.55kW		



1

GEV No.	601180	Ref. No.	5420900
description	motor 550W 230/400V 50Hz 3 phase shaft ø 19mm flange ø 120mm 1400rpm type AIS80A4 ø 160mm H 175mm L 230mm VELA 0.55kW		



1

GEV No.	500473	Ref. No.	PF08300
description	motor 750W 230/400V 50Hz 3 phase shaft ø 19mm flange ø 120mm 1400rpm type FS80B4 ø 150mm H 200mm L 240mm ICME 0.75kW		

pumps

wash and rinse pumps

ALBA (C&A)

pumps



1

GEV No.	500417	Ref. No.	0300252	
description	pump inlet ø 28mm outlet ø 28mm type C904 230V 50Hz 1 phase 0.15kW 0.2HP L 200mm rotation direction right capacitor 6.3µF ALBA PUMPS (C&A)			
spare parts for	500417			
	GEV No.	365012	Ref. No.	—
	operating capacitor capacity 6.3µF 450V tolerance 5% 50Hz ambient temperature max. -25 to +85°C ø 30mm L 61mm M8 plastic connection male faston 6.3mm protection			
	GEV No.	510693	Ref. No.	141002 80121
	mechanical shaft seal for shaft ø 12mm slide ring ext. ø 24mm slide ring H 15.5mm slide ring int. ø 11mm counter ring mounting ø 24mm height counter ring 8mm counter ring int. ø 13.5mm			
	GEV No.	532490	Ref. No.	—
	O-ring EPDM thickness 2.62mm ID ø 72.69mm Qty 1 pcs			



EBARA

pumps





1

GEV No.	499007	Ref. No.	0301249
description	pump inlet ø 63mm outlet ø 63mm type DWO150 230/400V 50Hz 3 phase 1.1kW 1.5HP L 360mm EBARA		



1

GEV No.	500357	Ref. No.	0301254	
description	pump inlet ø 63mm outlet ø 63mm type DWO150 230/400V 50Hz 3 phase 1.1kW 1.5HP L 360mm rotation direction left EBARA inlet ø 63mm outlet ø 63mm			
spare parts for	500357			
	GEV No.	503147	Ref. No.	—
	pump cover gasket thickness 3.53mm ID ø 148.8mm Qty 1 pcs			
	GEV No.	503148	Ref. No.	—
	mechanical shaft seal for shaft ø 18mm height counter ring 12.5mm ID ø 18.5mm ED ø 32mm H 31mm mounting ø 33mm int. ø 19mm			
	GEV No.	521270	Ref. No.	—
	impellor ø 88mm H 24mm with flute shaft intake ø 13mm rotation direction left blades 6 stainless steel			

FIR

pumps







1

GEV No.	499353	Ref. No.	T360715 T360715000
description	pump inlet ø 30mm outlet ø 26mm type 5213E2451 230V 50Hz 1 phase 0.22kW 0.1HP L 190mm rotation direction left capacitor 5µF FIR		



1

GEV No.	501513	Ref. No.	41990	
description	pump inlet ø 63mm outlet ø 47mm type 1227.2711M10 230/400V 50Hz 3 phase 1.7kW L 340mm rotation direction right FIR			
spare parts for	501513			
	GEV No.	510693	Ref. No.	141002 80121
	mechanical shaft seal for shaft ø 12mm slide ring ext. ø 24mm slide ring H 15.5mm slide ring int. ø 11mm counter ring mounting ø 24mm height counter ring 8mm counter ring int. ø 13.5mm			
	GEV No.	511667	Ref. No.	—
	fan wheel ø 123mm H 17mm shaft intake ø 15mm			
	GEV No.	521513	Ref. No.	—
	pump cover FIR inlet ø 63mm outlet ø 47mm turn direction right ID ø 150mm inner height 32mm			
	GEV No.	524416	Ref. No.	80120
	pump cover gasket thickness 4x4mm Qty 1 pcs			
	GEV No.	698772	Ref. No.	41991
	impellor ø 113mm H 34mm M10L pump type 1227.2711M10 rotation direction right suitable for FIR blades 6			



1

GEV No.	500570	Ref. No.	75175
description	pump inlet ø 63mm outlet ø 47mm type 422512725 230/400V 50Hz 3 phase 1.1kW 1.5HP L 285mm rotation direction right FIR		
spare parts for	500570		
	GEV No.	510693	Ref. No. 141002 80121
	mechanical shaft seal for shaft ø 12mm slide ring ext. ø 24mm slide ring H 15.5mm slide ring int. ø 11mm counter ring mounting ø 24mm height counter ring 8mm counter ring int. ø 13.5mm		
	GEV No.	521082	Ref. No. 80881
	impellor ø 96mm H 32mm rotation direction right thread M8L		
	GEV No.	521513	Ref. No. —
	pump cover FIR inlet ø 63mm outlet ø 47mm turn direction right ID ø 150mm inner height 32mm		
	GEV No.	524416	Ref. No. 80120
	pump cover gasket thickness 4x4mm Qty 1 pcs		



1

GEV No.	499280	Ref. No.	80115
description	pump inlet ø 63mm outlet ø 47mm type 5295.5050 230/400V 50Hz 3 phase 1.5kW L 300mm rotation direction right FIR		
spare parts for	499280		
	GEV No.	502277	Ref. No. 80119
	impellor ø 111mm H 31mm thread M8L		
	GEV No.	510693	Ref. No. 141002 80121
	mechanical shaft seal for shaft ø 12mm slide ring ext. ø 24mm slide ring H 15.5mm slide ring int. ø 11mm counter ring mounting ø 24mm height counter ring 8mm counter ring int. ø 13.5mm		

spare parts for	499280		
	GEV No.	521022	Ref. No. —
	fanwheel cover ID ø 137mm ED ø 142mm H 70mm for wash pump		
	GEV No.	524416	Ref. No. 80120
	pump cover gasket thickness 4x4mm Qty 1 pcs		
	GEV No.	698773	Ref. No. —
	pump cover inlet ø 63mm outlet ø 47mm turn direction right ø 194mm ID ø 158mm		

LGB









1

GEV No.	499100	Ref. No.	130982
description	pump inlet ø 42mm outlet ø 24/37mm type LA50 230V 50Hz 1 phase 0.47kW L 220mm rotation direction right capacitor 10µF LGB with flange and hoses		
spare parts for	499100		
	GEV No.	365015	Ref. No. 0300106 206002 633
	operating capacitor capacity 10µF 400V tolerance 5%Hz ambient temperature max. -25 to +85°C ø 35.5mm L 59mm M8 plastic connection male faston 6.3mm protection		
	GEV No.	510702	Ref. No. —
	mechanical shaft seal height counter ring 5.5mm ID ø 12mm		
	GEV No.	521024	Ref. No. 124057
	impellor ø 88mm H 30mm rotation direction right thread M7L shaft ø 12mm blades 6		
	GEV No.	698767	Ref. No. 335015
	fan blade ø 110mm H 18mm shaft intake ø 12mm plastic blades 6		
	GEV No.	698768	Ref. No. 480148
	pump cover LGB inlet ø 42mm pump type LA50 AP ø 115mm ID ø 36mm		
	GEV No.	698810	Ref. No. 456078
	O-ring EPDM thickness 3.56mm ID ø 112mm Qty 1 pcs		
	GEV No.	698827	Ref. No. 429074
	threaded ring LGB pump type LA50 ø 120mm ID ø 70mm		







1				
GEV No.	499190	Ref. No.	69120	
description	pump inlet ø 42mm outlet ø 24/37mm type LA50 230V 50Hz 1 phase 0.47kW L 225mm rotation direction right capacitor 10µF LGB			
spare parts for	499190			
	GEV No.	365015	Ref. No.	0300106 206002 633
	operating capacitor capacity 10µF 400V tolerance 5%Hz ambient temperature max. -25 to +85°C ø 35.5mm L 59mm M8 plastic connection male faston 6.3mm protection			
	GEV No.	510702	Ref. No.	—
	mechanical shaft seal height counter ring 5.5mm ID ø 12mm			
	GEV No.	521024	Ref. No.	124057
	impellor ø 88mm H 30mm rotation direction right thread M7L shaft ø 12mm blades 6			
	GEV No.	698767	Ref. No.	335015
	fan blade ø 110mm H 18mm shaft intake ø 12mm plastic blades 6			
	GEV No.	698768	Ref. No.	480148
	pump cover LGB inlet ø 42mm pump type LA50 AP ø 115mm ID ø 36mm			
	GEV No.	698793	Ref. No.	—
	pump cover outlet ø 24/36mm pump type LGB			
	GEV No.	698810	Ref. No.	456078
	O-ring EPDM thickness 3.56mm ID ø 112mm Qty 1 pcs			
	GEV No.	698827	Ref. No.	429074
	threaded ring LGB pump type LA50 ø 120mm ID ø 70mm			



1				
GEV No.	500355	Ref. No.	0301204	
description	pump inlet ø 45mm outlet ø 40mm type ZF320SX 230V 50Hz 1 phase 0.7kW 0.95HP L 200mm rotation direction right capacitor 12.5µF LGB			
spare parts for	500355			
	GEV No.	365014	Ref. No.	0300081
	operating capacitor capacity 12.5µF 450V tolerance 5%Hz ambient temperature max. -25 to +85°C ø 35mm L 70mm M8 plastic connection male faston 6.3mm 45S.C3DS.12.5 protection			
	GEV No.	510702	Ref. No.	—
	mechanical shaft seal height counter ring 5.5mm ID ø 12mm			
	GEV No.	512404	Ref. No.	—
	bracket mounting distance 130mm			
	GEV No.	521246	Ref. No.	—
	impellor ø 103mm H 26mm thread M8L shaft ø 20mm shaft length 7mm seat ø 8.2mm blades 6			
	GEV No.	521542	Ref. No.	—
	pump cover LGB inlet ø 45mm outlet ø 40mm auxiliary pressure connection 13mm supporting pressure open ø 150mm ID ø 120mm inner high 25mm			
	GEV No.	521714	Ref. No.	—
	pump cover gasket thickness 4x4mm Qty 1 pcs			







1

GEV No.	500361	Ref. No.	80112
description	pump inlet ø 60mm outlet ø 49mm type ZF400SX 230V 50Hz 1 phase 0.8kW 1HP L 210mm rotation direction right capacitor 16µF LGB		
spare parts for	500361		
	GEV No.	365021	Ref. No. —
	operating capacitor capacity 16µF 425V tolerance 5% 50/60Hz ambient temperature max. -25 to +85°C ø 35mm L 73mm single M8 plastic connection male faston 6.3mm 416.10.99 protection		
	GEV No.	509020	Ref. No. 124031
	impellor ø 104mm H 25mm M8L		
	GEV No.	510703	Ref. No. —
	mechanical shaft seal for shaft ø 13mm slide ring H 13mm height counter ring 5.5mm ED ø 26mm		
	GEV No.	521547	Ref. No. 116013
	pump cover LGB inlet ø 60mm outlet ø 50mm supporting pressure M8 turn direction right ø 160mm ID ø 127mm inner height 36mm		
	GEV No.	532623	Ref. No. 80844
	O-ring EPDM thickness 2.62mm ID ø 120.32mm Qty 1 pcs		



1

GEV No.	499282	Ref. No.	77553
description	pump inlet ø 60mm outlet ø 49mm type ZF400VSX 220-230/380-400V 50Hz 3 phase 0.7kW L 270mm rotation direction right LGB		
spare parts for	499282		
	GEV No.	502279	Ref. No. —
	impellor H 31mm ED ø 100mm blades 6		
	GEV No.	510702	Ref. No. —
	mechanical shaft seal height counter ring 5.5mm ID ø 12mm		

spare parts for	499282		
	GEV No.	521058	Ref. No. —
	fanwheel cover suitable for LGB ID ø 138mm ED ø 142mm H 59mm plastic		
	GEV No.	521547	Ref. No. 116013
	pump cover LGB inlet ø 60mm outlet ø 50mm supporting pressure M8 turn direction right ø 160mm ID ø 127mm inner height 36mm		
	GEV No.	532623	Ref. No. 80844
	O-ring EPDM thickness 2.62mm ID ø 120.32mm Qty 1 pcs		

booster pumps I



1

GEV No.	500060	Ref. No.	0300361
description	pump inlet ø 1" outlet ø 1" type PQM60 230V 50Hz 1 phase 0.37kW PEDRELLO		
accessories for	500060		
	GEV No.	365015	Ref. No. 0300106 206002 633
	operating capacitor capacity 10µF 400V tolerance 5%Hz ambient temperature max. -25 to +85°C ø 35.5mm L 59mm M8 plastic connection male faston 6.3mm protection		



1

GEV No.	499292	Ref. No.	0100631
description	pump inlet ø 1¼" IT outlet ø 1" IT type CDX/A 120/07 230-240V 50Hz 3 phase 0.55kW 0.75HP L 320mm rotation direction left EBARA		



1 electric components

drain pumps

HANNING



1

GEV No.	500363	Ref. No.	80117
description	drain pump 40W 230V		

PLASET



1

GEV No.	500354	Ref. No.	0300068
description	drain pump inlet ø 30mm outlet ø 22mm 230V 30W 50Hz PLASET type 64079		
accessories for	500354		
	GEV No.	506074	Ref. No. 0200521
	drain hose ID ø 32mm ED ø 41mm L 1m wire reinforced		
	GEV No.	506207	Ref. No. 0900006
	drain hose DN19 L 1500mm straight ø inside 19mm straight ext. ø 24mm elbow ø inside 21mm elbow ext. ø 27mm outer hose ø 25mm		



1

GEV No.	499312	Ref. No.	EA12-0001
description	pump inlet ø 30mm outlet ø 22mm 220/240V 34W 50Hz PLASET type 50763		

booster pumps II

accessories



1

GEV No.	365015	Ref. No.	0300106 206002 633
description	operating capacitor capacity 10µF 400V tolerance 5%Hz ambient temperature max. -25 to +85°C ø 35.5mm L 59mm M8 plastic connection male faston 6.3mm protection		



1

GEV No.	365017	Ref. No.	0300105
description	operating capacitor capacity 5µF 450V tolerance 5% 50/60Hz ambient temperature max. -25 to +85°C ø 28mm L 54mm M8 plastic connection male faston 6.3mm 16.10.08 protection		

condensators & interference suppression filters

operating capacitors

plastic



1

GEV No.	365015	Ref. No.	0300106 206002 633
description	operating capacitor capacity 10µF 400V tolerance 5%Hz ambient temperature max. -25 to +85°C ø 35.5mm L 59mm M8 plastic connection male faston 6.3mm protection		



1

GEV No.	365014	Ref. No.	0300081
description	operating capacitor capacity 12.5µF 450V tolerance 5%Hz ambient temperature max. -25 to +85°C ø 35mm L 70mm M8 plastic connection male faston 6.3mm 45S.C3DS.12.5 protection		



			
1			
GEV No.	365019	Ref. No.	206005
description	operating capacitor capacity 20µF 400V tolerance 5% 50/60Hz ambient temperature max. -25 to +85°C ø 39.5mm L 70mm M8 plastic connection male faston 6.3mm 16.10.25. protection		

			
1			
GEV No.	365028	Ref. No.	010578025
description	operating capacitor capacity 3µF 450V tolerance 5% 50/60Hz ambient temperature max. -25 to +85°C ø 35.5mm L 75mm M8 plastic connection male faston 6.3mm protection		

			
1			
GEV No.	365035	Ref. No.	T093005
description	operating capacitor capacity 30µF 400V tolerance 5% 50/60Hz ambient temperature max. -25 to +85°C ø 45mm L 95mm M8 plastic connection male faston 6.3mm protection		

			
1			
GEV No.	365017	Ref. No.	0300105
description	operating capacitor capacity 5µF 450V tolerance 5% 50/60Hz ambient temperature max. -25 to +85°C ø 28mm L 54mm M8 plastic connection male faston 6.3mm 16.10.08 protection		

			
1			
GEV No.	365013	Ref. No.	182
description	operating capacitor capacity 8µF 400V tolerance 5% 50/60Hz ambient temperature max. -25 to +85°C ø 31.5mm L 55mm M8 plastic connection male faston 6.3mm protection		

filters

interference suppression filters

			
1			
GEV No.	365046	Ref. No.	0300900
description	interference suppression filter type 10S7E-G1474253105-Q 115/250V 50/60Hz conductor 2 with E connection male faston 6.3mm L 40mm ø 40mm Hmm Wmm M8 plastic Qty 1 pcs		

line filters

with housing

			
1			
GEV No.	403358	Ref. No.	EA13-0057
description	line filter type FC61113 400V 50-60Hz three-phase connection cable cable length 500mm mounting DIN rail		

			
1			
GEV No.	365189	Ref. No.	EA13-0109
description	line filter type SKY2FN3 230V 50-60Hz conductor 2 with E connection spring terminal L 90mm ømm H 40mm W 52mm DIN rail plastic Qty 1 pcs		

fuses

fine fuses

			
1			
GEV No.	358677	Ref. No.	228004 228010
description	fine fuse size ø5x20mm 4A fast-acting rated 250V Qty 10 pcs		

			
1			
GEV No.	358594	Ref. No.	228012
description	fine fuse size ø5x20mm 0.16A slow-acting rated 250V Qty 10 pcs		

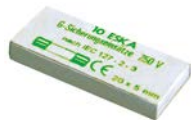

1

GEV No.	358603	Ref. No.	228011
description	fine fuse size ø5x20mm 2A slow-acting rated 250V Qty 10 pcs		

fine fuse holders



1

GEV No.	551234	Ref. No.	210010
description	fuse holder suitable fuse ø5x20mm 1-pole 6.3A rated 600V L 52mm W 8mm H 51mm connection screw clamp cross section 4mm ²		



1

GEV No.	550499	Ref. No.	H.228047
description	fuse holder suitable fuse ø5x20mm 6.3A rated 500V		



1

GEV No.	550519	Ref. No.	H.228048
description	cover plate suitable fuseA ratedV connection for fuse holder		

line circuit breakers

miscellaneous



1

GEV No.	381233	Ref. No.	EA03-0016
description	line circuit breaker 1-pole 6A tripping type D rated 230/400V connection screw mounting DIN rail 1 phase		



1

GEV No.	358146	Ref. No.	0301723
description	line circuit breaker 3-pole 16A tripping type C rated 400V connection screw		



1

GEV No.	358145	Ref. No.	0301729
description	line circuit breaker 3-pole 32A tripping type C rated 400V connection screw		



1

GEV No.	358144	Ref. No.	0301730
description	shunt release rated 12-24V Qty 1 pcs		

electric accessories

cables

power supply cables



1

GEV No.	551085	Ref. No.	9171
description	cable CEE7/7 type E+F 3-pole contacts P+N+E 1.5mm ² max. 16A max 230V 2m with plug H05VV-F 3G1.5		

spiral cables



1

GEV No.	550071	Ref. No.	PC187B-028 PC188B-028 PC190B-028
description	spiral cable plug type CEE7/7 type E+F 1.5mm ² 3-pole with plug L 500mm expansion 5:1 countries A/D/I black		

accessories

protection hoses

JOHN GUEST



1

GEV No.	550788	Ref. No.	X033027000
description	screw connection ID ø 14mm for protection hose plastic Qty 1 pcs thread PG11		



ribbon cables

group 1



GEV No.	403250	Ref. No.	80933
description	ribbon cable 10-pole L 3000mm plug type coded 2 row plug: number of poles 10		



GEV No.	400902	Ref. No.	80934
description	ribbon cable 10-pole L 750mm plug type FC-10P raster size 2.54mm		



GEV No.	400339	Ref. No.	PKAL465
description	ribbon cable 16-pole L 460mm plug type 2 row Qty 1m		

cable harnesses



GEV No.	550774	Ref. No.	T113075
description	cable harness		

miscellaneous



GEV No.	550773	Ref. No.	T113036
description	connecting cable L 1.9m		

terminals

connection terminals with screw/faston connections



GEV No.	550411	Ref. No.	220011 65.51785
description	power terminal block 6-pole max. 40A max 450V connection $\phi 6\text{mm}^2$ / F6.3 temp.-resist. 150°C cross section 6mm^2		

connection terminals with screw connection

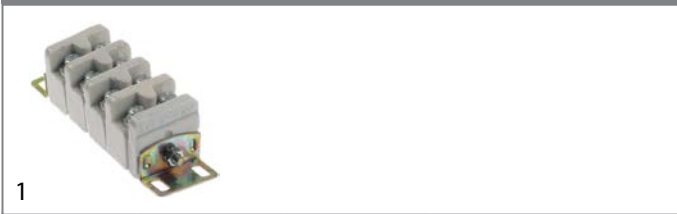

GEV No.	551109	Ref. No.	A01506752
description	connecting cable 4-pole max. 15A max 500V connection screw temp.-resist. 150°C		



GEV No.	551021	Ref. No.	A0AT93621
description	porcelain terminal block 3-pole max. 15A max 500V connection screw temp.-resist. 150°C with fastening angle t.max. 150°C Qty 1 pcs		

connection boxes

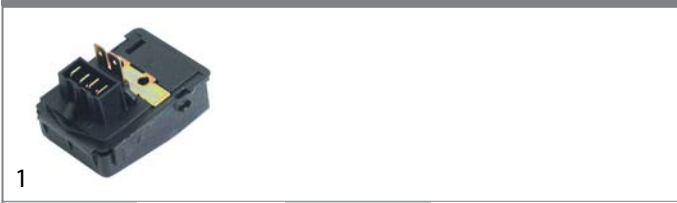

GEV No.	550670	Ref. No.	0300750
description	power terminal block 3-pole contacts P+N+E		



GEV No.	550671	Ref. No.	0300751
description	power terminal block 6-pole contacts 3P+N+E		

rail-mounted terminals

SIEMENS

feed-through terminals



GEV No.	551238	Ref. No.	0300405
description	rail-mounted terminal 16mm ² beige 1-pole		



miscellaneous



GEV No.	551234	Ref. No.	210010
description	fuse holder suitable fuse ϕ 5x20mm 1-pole 6.3A rated 600V L 52mm W 8mm H 51mm connection screw clamp cross section 4mm ²		

terminal boxes



GEV No.	551090	Ref. No.	GN650TN.16
description	terminal box 5-pole L 95mm W 63mm H 27mm		

DIN rails



GEV No.	551018	Ref. No.	Z103083
description	DIN rail W 35mm L 72mm hole distance 52mm		

gas taps

COPRECI

CAL-3200



GEV No.	109509	Ref. No.	R612100
description	gas tap COPRECI type CAL-3200 gas inlet M18x1.5 (tube ϕ 12mm) bypass nozzle ϕ 0.8mm gas outlet M18x1.5 (tube ϕ 12mm) thermocouple connection M8x1 pilot connection 1/8" shaft ϕ 10x8mm shaft flat right shaft L 29/12mm with pipe outlet		

spare parts for	109509			
	GEV No.	106173	Ref. No.	—
	magnet unit L 43mm D1 ϕ 19mm D2 ϕ 15.5mm suitable for COPRECI			

accessories for	109509			
	GEV No.	100944	Ref. No.	—
	union nut thread M18x1.5 for pipe ϕ 12mm			
	GEV No.	101273	Ref. No.	0200182
	olive for pipe ϕ 12mm L 9.5mm brass Qty 1 pcs suitable for universal			



GEV No.	109060	Ref. No.	T032103
description	gas tap COPRECI type CAL-3200 gas inlet M18x1.5 (tube ϕ 12mm) bypass nozzle ϕ 1.1mm gas outlet M18x1.5 (tube ϕ 12mm) thermocouple connection M8x1 pilot connection 1/8" shaft ϕ 10x8mm shaft flat right shaft L 29/12mm		

spare parts for	109060			
	GEV No.	106173	Ref. No.	—
	magnet unit L 43mm D1 ϕ 19mm D2 ϕ 15.5mm suitable for COPRECI			

accessories for	109060			
	GEV No.	100944	Ref. No.	—
	union nut thread M18x1.5 for pipe ϕ 12mm			
	GEV No.	101273	Ref. No.	0200182
	olive for pipe ϕ 12mm L 9.5mm brass Qty 1 pcs suitable for universal			

CAL-5200



GEV No.	106036	Ref. No.	65.39140
description	gas tap COPRECI type CAL-5200 gas inlet pipe flange ϕ 21mm bypass nozzle ϕ 0.35mm gas outlet M14x1.5 (tube ϕ 6mm) thermocouple connection M8x1 pilot connection shaft ϕ 6x4.6mm shaft L 25/16mm shaft flat lower with pipe outlet		

spare parts for	106036			
	GEV No.	101060	Ref. No.	65.51089
	magnet unit standard L 39mm D1 ϕ 15.4mm D2 ϕ 11mm suitable for PEL20-21/JUNKERS/EGA			



gas thermostats



SIT

710 Minisit series







GEV No.	101435	Ref. No.	U134316
----------------	--------	-----------------	---------

description gas thermostat SIT type MINISIT 710 t.max. 340°C 100-340°C gas inlet 1/2" gas outlet 3/8" thermocouple connection M9x1 pilot connection M10x1 probe ø 4mm probe L 72mm capillary pipe 1050mm probe type type C1 pressure controller no pressure regulator bar gland nut

spare parts for 101435			
	GEV No.	101053	Ref. No. U264399
magnet unit T1: M9x1 T2: M24x1 L 45mm ø 17mm suitable for Minisit			
	GEV No.	102107	Ref. No. —
probe 100-340°C probe ø 4mm probe L 72mm capillary pipe 1050mm t.max. 340°C oven/grill probe type type C1 suitable for MINISIT 710			





accessories for 101435			
	GEV No.	100809	Ref. No. —
O-ring EPDM thickness 2mm ID ø 21mm Qty 1 pcs			
	GEV No.	100904	Ref. No. —
locking screw M10x1 for pipe ø 4mm Qty 1 pcs			
	GEV No.	100905	Ref. No. —
locking screw M10x1 for pipe ø 6mm Qty 1 pcs			
	GEV No.	101054	Ref. No. —
magnet unit T1: M10x1 T2: M24x1 L 45mm ø 17mm suitable for Minisit			
	GEV No.	101136	Ref. No. —
piezoelectric igniter suitable for Minisit with cover cap ømm connection F6.3x0.8			
	GEV No.	101137	Ref. No. U134318
cover cap without piezoelectric igniter			
	GEV No.	101267	Ref. No. —
reducer IT 3/8" ET 1/2" L 21mm			
	GEV No.	101268	Ref. No. U264300
gas connection thread 3/8" angled with O-ring MINISIT 710			
	GEV No.	101269	Ref. No. —
gas connection thread 1/2" angled with O-ring MINISIT 710			
	GEV No.	101270	Ref. No. —
screw connection IT 3/8" ET 3/8" L 28mm			
	GEV No.	101272	Ref. No. —
screw connection IT 1/2" ET 3/8" L 57mm			

accessories for 101435			
	GEV No.	101273	Ref. No. 0200182
olive for pipe ø 12mm L 9.5mm brass Qty 1 pcs suitable for universal			
	GEV No.	101274	Ref. No. —
olive for pipe ø 16mm Qty 1 pcs			
	GEV No.	101275	Ref. No. —
union screw thread 1/2" for pipe ø 16mm Qty 1 pcs			
	GEV No.	101276	Ref. No. U264310000
union screw thread 3/8" tube ø 12mm Qty 1 pcs			
	GEV No.	110068	Ref. No. U134317
knob suitable for Minisit ø 37mm			



GEV No.	106332	Ref. No.	U264315
----------------	--------	-----------------	---------

description gas thermostat SIT type MINISIT 710 t.max. 340°C 100-340°C gas inlet 3/8" pipe input ø 12mm gas outlet 3/8" pipe output ø 12mm thermocouple connection M9x1 probe ø 4mm probe L 72mm pressure controller no

spare parts for 106332			
	GEV No.	100809	Ref. No. —
O-ring EPDM thickness 2mm ID ø 21mm Qty 1 pcs			
	GEV No.	101053	Ref. No. U264399
magnet unit T1: M9x1 T2: M24x1 L 45mm ø 17mm suitable for Minisit			
	GEV No.	101137	Ref. No. U134318
cover cap without piezoelectric igniter			
	GEV No.	101268	Ref. No. U264300
gas connection thread 3/8" angled with O-ring MINISIT 710			
	GEV No.	102107	Ref. No. —
probe 100-340°C probe ø 4mm probe L 72mm capillary pipe 1050mm t.max. 340°C oven/grill probe type type C1 suitable for MINISIT 710			
	GEV No.	110068	Ref. No. U134317
knob suitable for Minisit ø 37mm			







accessories for 106332			
	GEV No.	100904	Ref. No. —
locking screw M10x1 for pipe ø 4mm Qty 1 pcs			
	GEV No.	100905	Ref. No. —
locking screw M10x1 for pipe ø 6mm Qty 1 pcs			
	GEV No.	101054	Ref. No. —
magnet unit T1: M10x1 T2: M24x1 L 45mm ø 17mm suitable for Minisit			



Table continues overleaf



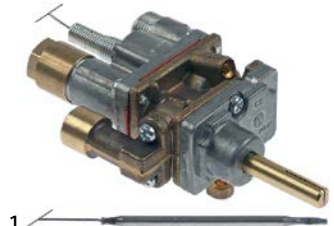

1 gas components





accessories for		106332		
	GEV No.	101136	Ref. No.	—
piezoelectric igniter suitable for Minisit with cover cap omm connection F6.3x0.8				
	GEV No.	101267	Ref. No.	—
reducer IT 3/8" ET 1/2" L 21mm				
	GEV No.	101269	Ref. No.	—
gas connection thread 1/2" angled with O-ring MINISIT 710				
	GEV No.	101270	Ref. No.	—
screw connection IT 3/8" ET 3/8" L 28mm				
	GEV No.	101272	Ref. No.	—
screw connection IT 1/2" ET 3/8" L 57mm				
	GEV No.	101273	Ref. No.	0200182
olive for pipe ø 12mm L 9.5mm brass Qty 1 pcs suitable for universal				
	GEV No.	101274	Ref. No.	—
olive for pipe ø 16mm Qty 1 pcs				
	GEV No.	101275	Ref. No.	—
union screw thread 1/2" for pipe ø 16mm Qty 1 pcs				
	GEV No.	101276	Ref. No.	U264310000
union screw thread 3/8" tube ø 12mm Qty 1 pcs				

accessories			
probes			
	1		
GEV No.	102102	Ref. No.	U264398
description probe 100-340°C probe ø 5mm probe L 68mm capillary pipe 1750mm t.max. 340°C oven/grill probe type type B1 suitable for MINISIT 710			

COPRECI				
	1			
GEV No.	109051	Ref. No.	R612101	
description gas thermostat COPRECI t.max. 300°C gas inlet pipe flange ø21mm bypass nozzle ø 0.6mm gas outlet 3/8" pilot connection 1/8" thermocouple connection M8x1 capillary pipe 1100mm probe ø 4mm probe L 84mm shaft ø 8x6.5mm shaft L 33/12mm shaft flat right				
spare parts for 109051				
	GEV No.	101060	Ref. No.	65.51089
magnet unit standard L 39mm D1 ø 15.4mm D2 ø 11mm suitable for PEL20-21/JUNKERS/EGA				
	GEV No.	101537	Ref. No.	—
gasket ID ø 8mm ED ø 11.5mm H 3mm Qty 1 pcs				

accessories for		109051		
	GEV No.	101376	Ref. No.	—
gasket ID ø 8mm ED ø 12mm H 3/5mm				
	GEV No.	101538	Ref. No.	—
clamp				

	1			
GEV No.	109534	Ref. No.	U742130	
description gas thermostat COPRECI type CAL-5200 t.max. 300°C gas inlet pipe flange ø21mm bypass nozzle ø 0.5mm gas outlet 3/8" pilot connection closed thermocouple connection M8x1 capillary pipe 1100mm probe ø 4mm probe L 82mm shaft ø 8x6.5mm shaft L 33/12mm shaft flat right				
spare parts for 109534				
	GEV No.	101060	Ref. No.	65.51089
magnet unit standard L 39mm D1 ø 15.4mm D2 ø 11mm suitable for PEL20-21/JUNKERS/EGA				
accessories for 109534				
	GEV No.	101537	Ref. No.	—
gasket ID ø 8mm ED ø 11.5mm H 3mm Qty 1 pcs				
	GEV No.	101538	Ref. No.	—
clamp				

	1			
GEV No.	109089	Ref. No.	65.51110	
description gas thermostat E.C.A./COPRECI 100-300°C gas inlet pipe flange ø21mm bypass nozzle ø 0.45mm gas outlet M14x1.5 pilot connection thermocouple connection M8x1 capillary pipe 840mm probe ø 4.5mm probe L 92mm shaft ø 6x4.6mm shaft L 27/14mm shaft flat lower				
spare parts for 109089				
	GEV No.	101060	Ref. No.	65.51089
magnet unit standard L 39mm D1 ø 15.4mm D2 ø 11mm suitable for PEL20-21/JUNKERS/EGA				
	GEV No.	101537	Ref. No.	—
gasket ID ø 8mm ED ø 11.5mm H 3mm Qty 1 pcs				
accessories for 109089				
	GEV No.	101538	Ref. No.	—
clamp				



gas valves and ignition boxes











gas control valves

SIT

NOVASIT



1

GEV No.	101908	Ref. No.	X16300000
description	gas valve SIT series Novasit 820 230V 50Hz gas inlet 1/2" gas outlet 1/2" thermocouple connection M9x1 pilot connection M10x1 ignition pressurebar pressure regulator connection blind equiv. no. 0.820.018 output pilot burner M10x1 input pressure max. 60bar setting range 3-30bar		
spare parts for	101908		
	GEV No.	101065	Ref. No. —
	magnet unit with cable L 44mm D1 ø 30mm D2 ø 20mm suitable for NOVASIT		
	GEV No.	101313	Ref. No. —
	solenoid coil 230V 50Hz		
accessories for	101908		
	GEV No.	100006	Ref. No. —
	piezoelectric igniter suitable for ELETTROSIT body plastic blowing connection ø2.4mm ø 14mm		
	GEV No.	101305	Ref. No. —
	gas connection straight 1/2" flange 45x45mm ELETTROSIT/V4400/4600/4605 suitable for SIT/HONEYWELL hole distance 36x36mm		
	GEV No.	101306	Ref. No. X153004
	gas connection angled flange 45x45mm hole distance 36x36mm 1/2" ELETTROSIT/V4400/4600/4605 screw with O-ring suitable for SIT/HONEYWELL		
	GEV No.	101307	Ref. No. —
	gas connection straight flange 45x45mm hole distance 36x36mm 3/4" ELETTROSIT/V4400/4600/4605 screw with O-ring suitable for SIT/HONEYWELL		
	GEV No.	101308	Ref. No. —
	gas connection angled flange 45x45mm hole distance 36x36mm 3/4" ELETTROSIT/V4400/4600/4605 screw with O-ring suitable for SIT/HONEYWELL		
	GEV No.	101312	Ref. No. R275027000
	microswitch		
	GEV No.	101314	Ref. No. —
	solenoid coil 24V 50Hz		
	GEV No.	101317	Ref. No. X163008000
	plug with cable L 1000mm suitable for NOVASIT		
	GEV No.	101318	Ref. No. —
	cover cap for solenoid coil suitable for NOVASIT		

accessories



1

GEV No.	101306	Ref. No.	X153004
description	gas connection angled flange 45x45mm hole distance 36x36mm 1/2" ELETTROSIT/V4400/4600/4605 screw with O-ring suitable for SIT/HONEYWELL		
spare parts for	101306		
	GEV No.	517104	Ref. No. —
	O-ring EPDM thickness 2.62mm ID ø 31.42mm Qty 1 pcs		



1

GEV No.	550896	Ref. No.	X163009000
description	gasket with screw gas valves NOVASIT		



1

GEV No.	101359	Ref. No.	X262100
description	knob extension L 75mm suitable for NOVASIT		



1

GEV No.	101312	Ref. No.	R275027000
description	microswitch		



1

GEV No.	101317	Ref. No.	X163008000
description	plug with cable L 1000mm suitable for NOVASIT		

ignition parts

pilot burners

SIT

100 series

accessories

pilot burner caps



1

GEV No.	100837	Ref. No.	X012117000
description	pilot burner cap 3 flames H 24mm L 48mm Qty 1 pcs		

pilot burner brackets

universal



1

GEV No.	100887	Ref. No.	X012114000
description	opposite support for pilot burner suitable for 100 series		



1

GEV No.	100886	Ref. No.	X012113000
description	pilot burner bracket suitable for 100 series 3-piece		



1

GEV No.	100888	Ref. No.	X012116
description	screw bolt for pilot burner		

electrodes

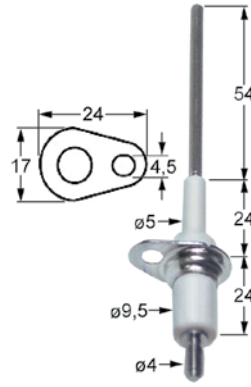

1

GEV No.	100759	Ref. No.	T135705
description	ignition electrode flange length 24mm flange width 17mm D1 ϕ 5mm D2 ϕ 9.5mm L1 54mm BL1 24mm BL2 24mm fixing dimensions ϕ 4.5mm with flange connection ϕ 4mm A1/B13/C2		

accessories for 100759

GEV No.	109065	Ref. No.	—
description	gasket hole ϕ 10mm L 27mm W 17mm		

ignition cables

pre-assembled cables



1

GEV No.	106265	Ref. No.	U323030
description	ignition cable cable length 985mm connection ϕ 2.4mm		

ignition units



1

GEV No.	101012	Ref. No.	X163014000
description	ignition unit outputs 2 230VAC dimensions 48x32x32mm mounting distance 56mm inlet F2.8x0.8 outlet F2.8x0.8 type ZIG2 50-60Hz		



1

GEV No.	102389	Ref. No.	65226007
description	ignition unit outputs 6 230VAC dimensions 135x23x34mm mounting distance 123mm inlet F6.3x0.8 outlet F2.8x0.8 0.6VA 50/60Hz		

thermocouples

plug-in thermocouples

plug-in thermocouples standard

with barrel socket $\varnothing 6(6.5)$ mm

thermocouples SIT

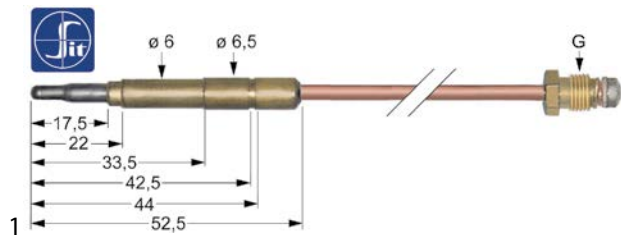

GEV No.	107605	Ref. No.	U322130
description	thermocouple SIT M8x1 L 1500mm plug connection $\varnothing 6.0(6.5)$ mm		

plug-in thermocouples with interruption

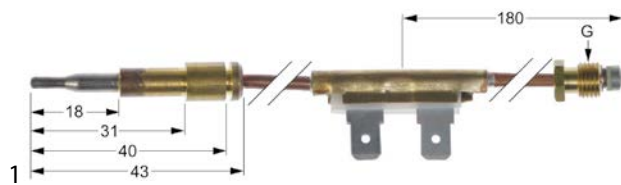

GEV No.	102269	Ref. No.	X022130
description	thermocouple with interrupter M9x1 L 850mm F 6.3mm		

threaded thermocouples

threaded thermocouples standard

with socket with thread M8x1

SIT

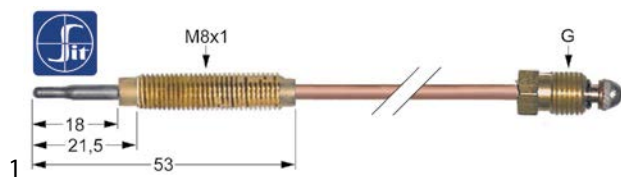

GEV No.	107633	Ref. No.	65.39896
description	thermocouple SIT M8x1 L 1200mm M8x1		

accessories for	107633		
	GEV No.	102067	Ref. No.
			—
	nut thread M8x1 H 3mm brass Qty 1 pcs type SEF 1		

type Junkers with aluminised tip

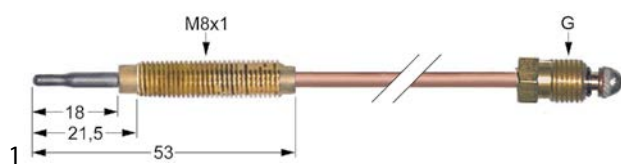

GEV No.	102233	Ref. No.	65.39895
description	thermocouple M8x1 L 750mm M8x1		

accessories for	102233		
	GEV No.	102067	Ref. No.
			—
	nut thread M8x1 H 3mm brass Qty 1 pcs type SEF 1		

accessories

miscellaneous



GEV No.	102449	Ref. No.	S223002
description	circuit breaker cable L 450mm Qty 2 pcs		

gas burners

hob burners

accessories

pan supports



GEV No.	210052	Ref. No.	88.37024
description	pan support W 263mm L 515mm H 44mm mounting pos. lateral		

bar burners

bar burners



GEV No.	109020	Ref. No.	T035700
description	bar burner 2 row L 530mm W 200mm \varnothing mm H 45mm chargrill		



GEV No.	211007	Ref. No.	T035455
description	chargrill grid L 570mm W 345mm H 75mm stainless steel chargrill		



GEV No.	211045	Ref. No.	T055462000
description	chargrill grid L 655mm W 411mm H 70mm stainless steel chargrill		

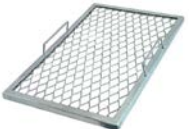

			
1			
GEV No.	109707	Ref. No.	T035406
description	lava rock grid L 480mm W 290mm H 20mm		

			
1			
GEV No.	109714	Ref. No.	T055405000
description	lava rock grid L 555mm W 350mm H 20mm		

chargrill grids

			
1			
GEV No.	211007	Ref. No.	T035455
description	chargrill grid L 570mm W 345mm H 75mm stainless steel chargrill		

			
1			
GEV No.	211045	Ref. No.	T055462000
description	chargrill grid L 655mm W 411mm H 70mm stainless steel chargrill		

lava rock grids

			
1			
GEV No.	109707	Ref. No.	T035406
description	lava rock grid L 480mm W 290mm H 20mm		

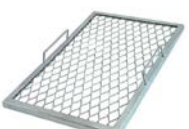
			
1			
GEV No.	109714	Ref. No.	T055405000
description	lava rock grid L 555mm W 350mm H 20mm		

tube burners

			
1			
GEV No.	109019	Ref. No.	X015700000
description	tubular burner L 340mm W 61mm H 58mm oval		

ring burners

			
1			
GEV No.	107742	Ref. No.	88.32998
description	ring burner L 357mm W 172mm		

accessories

gaskets

			
1			
GEV No.	109048	Ref. No.	R725052
description	gasket L 110mm W 110mm H 3.3mm hole ø 81mm graphite		

nozzle holders

			
1			
GEV No.	104724	Ref. No.	65.30915
description	nozzle holder		

			
1			
GEV No.	103255	Ref. No.	65.51764
description	nozzle holder L 29mm without nozzle ET M14x1.5 IT M9x1 WS 16		





miscellaneous			
			
1			
GEV No.	109043	Ref. No.	T035472000
description	bracket for burner L 480mm W 62mm H 20mm		

union screws			
			
1			
GEV No.	102454	Ref. No.	U322109
description	union screw thread 1/8" for pipe ø 4mm L 11mm brass Qty 1 pcs WS 10		

gas nozzles



main nozzles



gas nozzles M10x1			
			
1			
GEV No.	109439	Ref. No.	9101160
description	gas injector thread M10x1 WS 13 bore ø 2.25mm		

			
1			
GEV No.	109402	Ref. No.	9424600000
description	gas injector thread M10x1 WS 13 bore ø 4.25mm		

auxiliary gas parts

screw connections

olives			
			
1			
GEV No.	101273	Ref. No.	0200182
description	olive for pipe ø 12mm L 9.5mm brass Qty 1 pcs suitable for universal		
accessories for	101273		
	GEV No.	100944	Ref. No.
			—
	GEV No.	101276	Ref. No.
			U264310000

			
1			
GEV No.	101246	Ref. No.	U265026
description	olive for pipe ø 4mm Qty 1 pcs		
accessories for	101246		
	GEV No.	100908	Ref. No.
			—

gas lines

main gas lines

producer-specific			
			
1			
GEV No.	106339	Ref. No.	U565023
description	gas line tube ø 12mm SS without screw connection		

			
1			
GEV No.	109071	Ref. No.	T125026
description	gas line tube ø 14mm L 420mm WS 24		

1

GEV No.	106343	Ref. No.	S035025000
description	gas line tube ø 16mm L 150mm IT M14x1 ET 1/2"		



1

GEV No.	697439	Ref. No.	777
description	locking screw thread M6 L 155mm handle ø 40mm		

equipment-specific units

for slicers

covers



1

GEV No.	697749	Ref. No.	463 490
description	blade covering ø 209mm for knife ø 250mm mounting thread M6 fixing dimensions 12x12mm aluminium		



1

GEV No.	697744	Ref. No.	403
description	blade covering ø 248mm for knife ø 300mm mounting thread M6 fixing dimensions 12x12mm aluminium		

locking screws

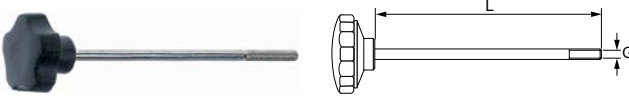

1

GEV No.	697438	Ref. No.	817
description	locking screw thread M6 L 145mm handle ø 40mm		

handles



1

GEV No.	697935	Ref. No.	378+371
description	star handle thread M8 ø 50mm L 29mm black with thread bolt		

adjustment knobs



1

GEV No.	697419	Ref. No.	130
description	adjusting knob 0-15 ø 55mm shaft ø 12mm shaft L 28mm handle ø 42mm 250		



1

GEV No.	698456	Ref. No.	631
description	adjusting knob 0-23 ø 68mm shaft ø 18mm shaft L 67mm handle ø 68mm		

eccentric disc for slice thickness



1

GEV No.	697471	Ref. No.	379
description	eccentrics for cutting thickness hole ø 12mm groove width 6mm ED ø 58mm thickness 21mm		

spring washers



1

GEV No.	697478	Ref. No.	671
description	spring washer ID ø 19mm ED ø 26mm Qty 1 pcs		



guiding pieces

bushes

1		
	GEV No.	698626
	Ref. No.	119
description		bush ED ø 18mm ID ø 16mm H 15mm

1		
	GEV No.	698627
	Ref. No.	611
description		bush ED ø 8mm ID ø 5mm H 10mm

spindles

1		
	GEV No.	697782
	Ref. No.	501
description		spindle for carriage ø 16mm L 390mm thread M8

housings

bottom parts

1		
	GEV No.	696345
	Ref. No.	516
description		bottom plate L 390mm W 190mm plastic 300

1		
	GEV No.	698389
	Ref. No.	768
description		cover L 447mm W 180mm plastic

hand guard

1		
	GEV No.	697754
	Ref. No.	784
description		hand protection for knife ø 300mm H 125mm W 60mm thickness 1.2mm hole ø 6.5mm mounting distance 84mm stainless steel

1		
	GEV No.	696511
	Ref. No.	197
description		wiper for knife ø 220/250mm stainless steel

1		
	GEV No.	697446
	Ref. No.	407
description		hand protection food holder 300 H 300mm W 163mm thickness 5.4mm mounting distance 110mm

1		
	GEV No.	697755
	Ref. No.	162
description		hand protection for carriage 300 H 180mm W 152mm thickness 5mm hole ø 10mm mounting distance 110mm plastic

1		
	GEV No.	697826
	Ref. No.	924
description		hand protection for slicer

accessories

1		
	GEV No.	697482
	Ref. No.	446
description		screw thread M5 ø 8mm L 15mm

1		
	GEV No.	697481
	Ref. No.	623
description		Thumb screw thread M6 thread L 8mm ø 14mm H 6mm SS

			
1			
GEV No.	697746	Ref. No.	9469
description	blade pulley with spindle D1 ø 40mm D2 ø 76mm shaft ø 16 L 40mm shaft length 157mm mounting thread M5 mounting ø 3-hole		
spare parts for	697746		
	GEV No.	514030	Ref. No. —
	retaining ring shaft ø 20mm thickness 1.3mm steel DIN 471		
	GEV No.	523512	Ref. No. 632
	deep-groove ball bearing type 6204-2RS shaft ø 20mm ED ø 47mm W 14mm with sealing discs deep-groove ball bearing DIN 625-1		
	GEV No.	692029	Ref. No. —
	retaining ring bore ø 47mm thickness 1.8mm steel DIN 472		

food holders

handles

			
1			
GEV No.	697431	Ref. No.	327
description	cone handle thread M6 ø 26mm plastic L 70mm black thread L 10mm		

			
1			
GEV No.	697432	Ref. No.	825
description	cone handle thread M6 ø 26mm plastic L 70mm thread L 6mm		

			
1			
GEV No.	111123	Ref. No.	452
description	handle thread M10 IT ø 30mm L 110mm D1 ø 65mm		

			
1			
GEV No.	697429	Ref. No.	298
description	handle thread M6 ø 25mm L 126mm with hand guard D1 ø 70mm		



food holders

			
1			
GEV No.	698644	Ref. No.	608 9608
description	food holder 300-350 L 290mm hole ø 12mm handle M10 CE		
accessories for	698644		
	GEV No.	110703	Ref. No. 627 IMPUG001
	cylindrical handle thread M10 ø 28mm L 87mm		

accessories

			
1			
GEV No.	698630	Ref. No.	827
description	spike food holder ø 3mm L 11.5mm		

			
1			
GEV No.	697480	Ref. No.	151
description	stop bolt food holder ø 7.5mm L 8mm plastic		

			
1			
GEV No.	696517	Ref. No.	800678
description	thread bolt for handle ø 12mm L 64mm thread M6/M10 stainless steel		
accessories for	696517		
	GEV No.	696515	Ref. No. —
	handle thread M10x1.5 ø 34mm L 88mm food holder		

blades

standard

			
1			
GEV No.	697365	Ref. No.	142
description	slicing machine blade ED ø 250mm seat ø 40mm 3-hole ID ø 210mm H 17.5mm C45 standard		





			
1			
GEV No.	697385	Ref. No.	636
description	slicing machine blade ED ø 300mm seat ø 40mm 3-hole ID ø 250mm H 20mm C45 standard		

			
1			
GEV No.	697445	Ref. No.	677
description	mushroom cap handle thread M6 handle ø 33mm L 26mm plastic black		

sharpener units

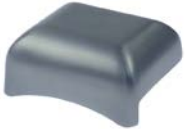
lids

			
1			
GEV No.	696514	Ref. No.	863
description	lid for sharpener units L 116mm W 100mm mounting distance 26mm		

			
1			
GEV No.	698643	Ref. No.	596
description	lid for sharpener units L 150mm W 120mm		

holders

			
1			
GEV No.	696493	Ref. No.	771
description	bracket for sharpener units L 60mm W 31mm H 78mm hole ø 12mm mounting thread M6 with fastening angle		



knobs

			
1			
GEV No.	697441	Ref. No.	854
description	locking screw thread M5 handle ø 25mm black L 30mm		

			
1			
GEV No.	697384	Ref. No.	734
description	locking screw thread M6 handle ø 25mm black L 54mm		

sharpener units

			
1			
GEV No.	697397	Ref. No.	9864
description	blade sharpener 220/250/275		

				
1				
GEV No.	697355	Ref. No.	9693	
description	blade sharpener 350			
spare parts for	697355			
	GEV No.	697377	Ref. No.	720
	grindstone ø 51mm thickness 12mm bore ø 8mm grained coarse without bevel			
	GEV No.	697378	Ref. No.	721
	grindstone ø 51mm thickness 7mm bore ø 8mm grained fine with bevel, without hub			

grindstones

			
1			
GEV No.	697378	Ref. No.	721
description	grindstone ø 51mm thickness 7mm bore ø 8mm grained fine with bevel, without hub		

grindstones with hub



1

GEV No.	697421	Ref. No.	641
description	grindstone ø 45mm thickness 8mm bore ø 6mm grained coarse with bevel, with hub		



1

GEV No.	697422	Ref. No.	642
description	grindstone ø 45mm thickness 8mm bore ø 6mm grained fine with bevel, with hub		

grindstones cup form



1

GEV No.	697377	Ref. No.	720
description	grindstone ø 51mm thickness 12mm bore ø 8mm grained coarse without bevel		

carrriages

handles



1

GEV No.	697442	Ref. No.	676
description	cylindrical handle thread M12 ø 28mm L 30mm		



1

GEV No.	697440	Ref. No.	432
description	handle thread M10 handle ø 66mm H 51mm black		



1

GEV No.	696556	Ref. No.	378 833
description	locking screw thread M8x1.25 thread L 23mm handle ø 50mm black plastic 250		
For models:	970702		



1

GEV No.	697935	Ref. No.	378+371
description	star handle thread M8 ø 50mm L 29mm black with thread bolt		

accessories



1

GEV No.	698631	Ref. No.	895
description	spindle for carriage thread M6 L 170mm ø 12mm		



1

GEV No.	697827	Ref. No.	678
description	spindle for slicer thread M10 L 95mm thread L 12/15mm total length 122mm ø 16mm stainless steel		

miscellaneous



1

GEV No.	697476	Ref. No.	509
description	bush ø 14mm L 88mm ID ø 12mm		





1

GEV No.	698419	Ref. No.	867
description	cover L 115mm W 100mm for motor plastic		



			
1			
GEV No.	698388	Ref. No.	765
description	mounting flange ø 18mm L 128mm W 28mm		

			
1			
GEV No.	698392	Ref. No.	828
description	thread bolt thread M6 ø 6mm L 35mm for slicer		

			
1			
GEV No.	698628	Ref. No.	774
description	threaded shaft thread M6 L 37mm for slicer		

for vegetable slicers

miscellaneous

			
1			
GEV No.	110703	Ref. No.	627 IMPUG001
description	cylindrical handle thread M10 ø 28mm L 87mm		

for cheese graters

miscellaneous

			
1			
GEV No.	110703	Ref. No.	627 IMPUG001
description	cylindrical handle thread M10 ø 28mm L 87mm		

for dough mixers

drive shafts

			
1			
GEV No.	697314	Ref. No.	8300460
description	drive shaft D1 ø 30mm for dough hook ø 25mm L 84mm IT M18x1.5		

lids

protective grid

			
1			
GEV No.	697320	Ref. No.	8300000
description	guard ø 340mm 17		

			
1			
GEV No.	697321	Ref. No.	8300010
description	guard ø 380mm 22		

flange bearings

			
1			
GEV No.	693112	Ref. No.	8300830
description	flange bearing type UCF204 shaft ø 20mm 4 hole flange hole distance 64mm H 33mm flange length 86mm flange width 86mm hole ø 12mm flange F204 ball bearing UC204G2 FH 25.5mm		

gearboxes

			
1			
GEV No.	697840	Ref. No.	8300590
description	gearbox motor shaft ø 25mm flange ø 120mm transmission 1/30 drive shaft ø 19mm type 50		

chains

roller chains 06B-1 single



GEV No.	697127	Ref. No.	8300870
description	roller chain DIN/ISO 06 B-1 splitting 3/8" / 9.525mm links 42 internal width 5.72mm rollerø 6.35mm single		



GEV No.	697126	Ref. No.	8300210
description	roller chain DIN/ISO 06 B-1 splitting 3/8" / 9.525mm links 63 internal width 5.72mm rollerø 6.35mm		

connectors



GEV No.	693276	Ref. No.	0813444
description	connector single DIN/ISO 08 B-1 splitting 1/2" links 1 L 23mm internal width 11.8mm rollerø 4.3mm metal		

dough hooks

with mounting thread



GEV No.	697316	Ref. No.	8300480
description	dough hook thread M18x1.5 usable height 220mm 17-22 TF-TR		

bearing blocks



GEV No.	697323	Ref. No.	8301480
description	bearing block for dough hook mounting pos. upper ø 107mm ID ø 52mm H 57mm 17-22 TF-TR		



GEV No.	697325	Ref. No.	8300200
description	bearing block for mixer bowl mounting pos. lower ø 148mm ID ø 52mm H 83mm		

dough separator



GEV No.	697339	Ref. No.	8301210
description	pastry rod L 330mm W 30mm thickness 10mm hole distance 60mm hole ø 11mm 17-22 TF-TR		

spindles

for lids



GEV No.	697136	Ref. No.	8300260
description	spindle for lid ø 15mm L 210mm		

for mixer bowls



GEV No.	697135	Ref. No.	8300250
description	spindle for mixer bowl ø 25mm D1 ø 30mm L 176mm		

gear wheels



GEV No.	697134	Ref. No.	8300710
description	sprocket-wheel DIN/ISO 06 B-1 splitting 3/8" teeth 14 shaft intake ø 22mm H 25mm 17-22 TF-TR		

accessories for	697134			
	GEV No.	560207	Ref. No.	8300280
	description	grub screw thread M8 L 10mm steel DIN 916/ISO 4029 intake internal hexagon WS 4 Qty 1 pcs		



GEV No.	697132	Ref. No.	8300410
description	sprocket-wheel DIN/ISO 06 B-1 splitting 3/8" teeth 15 shaft intake ø 25mm 17-22 TF-TR		



1 

GEV No.	697129	Ref. No.	8300850
description	sprocket-wheel DIN/ISO 06 B-1 splitting 3/8" teeth 29 shaft intake ø 20mm 17-22 TF-TR		

1 

GEV No.	697131	Ref. No.	8300230
description	sprocket-wheel DIN/ISO 06 B-1 splitting 3/8" teeth 72 shaft intake ø 60mm H 5mm 17-22 TF-TR		

miscellaneous

1 

GEV No.	697318	Ref. No.	8301590
description	flange for gearbox ø 100mm ID ø 70mm		

1 

GEV No.	697353	Ref. No.	8301270
description	stop bolt for lid ø 20mm L 15mm		

for dough roller

wipers

1 

GEV No.	693895	Ref. No.	4001020
description	wiper for dough roller L 330mm mounting pos. front P30		

1 

GEV No.	693898	Ref. No.	4001010
description	wiper for dough roller L 330mm mounting pos. rear P30		

1 

GEV No.	693896	Ref. No.	4001030
description	wiper for dough roller L 456mm mounting pos. front P40		

1 

GEV No.	693899	Ref. No.	4001040
description	wiper for dough roller L 456mm mounting pos. rear P40		

rollers

1 

GEV No.	693901	Ref. No.	3003100
description	roller L 167mm ø 48mm mounting pos. upper at the back		

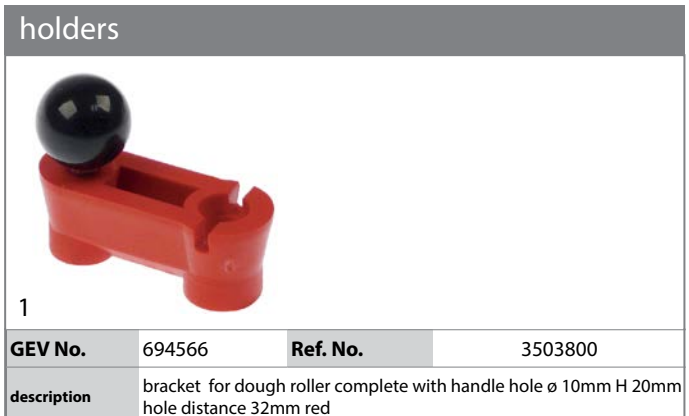
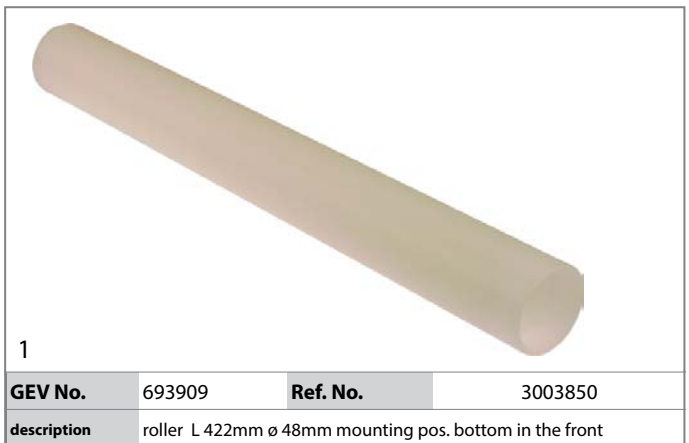
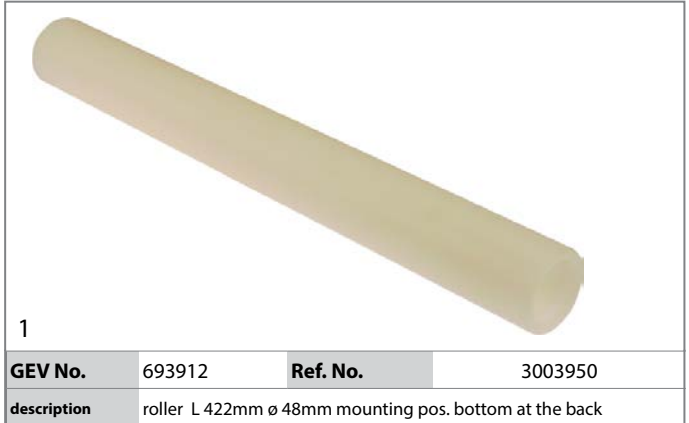
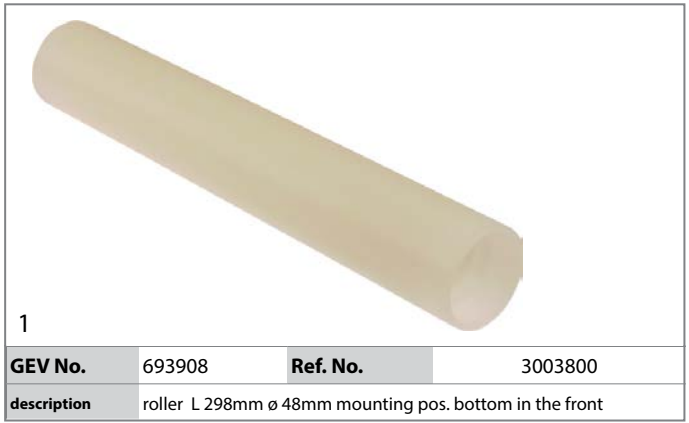
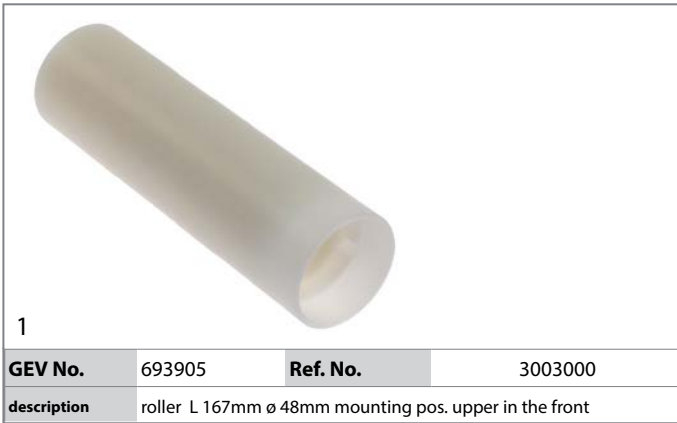



levers



1

GEV No.	700666	Ref. No.	3004500
description	lever for dough roller P30		



1

GEV No.	697338	Ref. No.	3004550
description	lever shaft intake ø 8.3mm L 230mm P40		

accessories



1

GEV No.	700667	Ref. No.	3004600
description	balance weight for dough roller ø 25mm L 15mm thread M5		



1

GEV No.	697348	Ref. No.	3004650
description	balance weight for dough roller ø 25mm L 20mm thread M5		

couplings



1

GEV No.	692011	Ref. No.	4203200	
description	coupling ø 41.5mm ID ø 25mm H 12mm			
accessories for	692011			
	GEV No.	692012	Ref. No.	—
	coupling ø 35mm ID ø 25mm H 14mm			



1

GEV No.	693646	Ref. No.	4203250
description	coupling set ø 42.8mm ID ø 25mm H 21mm		



1

GEV No.	693919	Ref. No.	4203300
description	mixer coupling		

pulleys



1

GEV No.	693927 ¹	Ref. No.	3150050
description	round belt pulley disc ø 70mm double shaft intake ø 14mm groove depth 3mm disc width 28mm groove width 9mm overall width 30mm metal P45		

¹double



1

GEV No.	693926 ¹	Ref. No.	3150080
description	round belt pulley disc ø 76mm double shaft intake ø 14mm groove depth 6mm disc width 29mm groove width 10mm overall width 32mm plastic P30-P40		

¹double



1

GEV No.	697285 ¹	Ref. No.	3150030
description	round belt pulley disc ø 96mm double shaft intake ø 14mm type 14x11 groove depth 6mm disc width 29mm groove width 10mm overall width 31mm plastic P30-P40 shaft ø 24mm		

¹double

pinions

rear mounting



1

GEV No.	697109	Ref. No.	3203510
description	pinion ø 47.5mm H 35mm mounting pos. rear ID ø 25mm for dough roller		

front mounting



1

GEV No.	697108	Ref. No.	3203410
description	pinion ø 47.5mm H 35mm mounting pos. front ID ø 14mm for dough roller		

springs



1

GEV No.	693920	Ref. No.	5003010
description	spring for pinion ø 49mm thickness 1.5mm Qty 2 pcs		

roller covers

upper

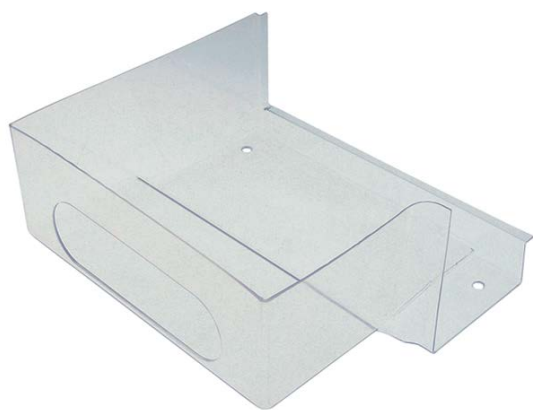

1

GEV No.	697307	Ref. No.	4100400
description	hand protection mounting pos. upper L 290mm W 250mm H 125mm		



1

GEV No.	697342	Ref. No.	4100060
description	hand protection mounting pos. upper P30		

bottom



1

GEV No.	697341	Ref. No.	4100070
description	hand protection mounting pos. lower P30		

side parts



1

GEV No.	697332	Ref. No.	3003400
description	side panel for dough roller mounting pos. upper right W 40mm L 125mm H 100mm P30-P40 bore ø 14.3mm depth of bore 19mm		



1

GEV No.	693922	Ref. No.	3004200
description	side panel for dough roller mounting pos. upper/lower right W 40mm L 125mm H 100mm P30-P40		



1

GEV No.	691911	Ref. No.	3004300
description	side panel for dough roller mounting pos. bottom left W 20mm L 115mm H 80mm P30-P40		





			
1			
GEV No.	692040	Ref. No.	3003410
description	side panel for dough roller mounting pos. upper left W 20mm L 115mm H 80mm P30-P40		

spindles

			
1			
GEV No.	693923	Ref. No.	3003650
description	spindle ø 22mm L 156mm		

bars

			
1			
GEV No.	693915	Ref. No.	3100400
description	bar ø 5mm L 315mm P30		

			
1			
GEV No.	693916	Ref. No.	3100500
description	bar ø 5mm L 440mm P40		

spindles

eccentric

			
1			
GEV No.	693890	Ref. No.	3003200
description	spindle ø 25mm L 244mm mounting pos. upper in the front eccentric		

			
1			
GEV No.	693891	Ref. No.	3003250
description	spindle ø 25mm L 293mm mounting pos. upper in the front eccentric		

			
1			
GEV No.	693892	Ref. No.	3004000
description	spindle ø 25mm L 373mm mounting pos. upper in the front eccentric		

			
1			
GEV No.	693893	Ref. No.	3004050
description	spindle ø 25mm L 499mm mounting pos. bottom in the front eccentric		

cylindric

			
1			
GEV No.	693885	Ref. No.	3003300
description	spindle ø 25mm L 212mm mounting pos. upper at the back cylindrical		

			
1			
GEV No.	693886	Ref. No.	3004150
description	spindle ø 25mm L 262mm mounting pos. upper at the back cylindrical		

			
1			
GEV No.	693887	Ref. No.	3004100
description	spindle ø 25mm L 342mm mounting pos. bottom at the back cylindrical		

			
1			
GEV No.	693888	Ref. No.	3003350
description	spindle ø 25mm L 467mm mounting pos. bottom at the back cylindrical		

miscellaneous

			
1			
GEV No.	697346	Ref. No.	5873100
description	ball handle thread M4 ø 20mm black		

			
1			
GEV No.	697328	Ref. No.	5163010
description	compression spring ø 7mm L 19.5mm wire gauge ø 0.6mm		

1			
GEV No.	697344	Ref. No.	4203000
description	lever for dough roller		

1			
GEV No.	693921	Ref. No.	4203100
description	lid for side part ø 30.5mm H 11mm		

1			
GEV No.	697345	Ref. No.	3003700
description	screw for lever L 37mm		

1			
GEV No.	697859	Ref. No.	3002460
description	spacer piece for dough roller ø 10.5mm L 37mm		

1			
GEV No.	697774	Ref. No.	3002470
description	spacer piece for dough roller ø 10mm L 43mm		

for pizza press

gearboxes

1			
GEV No.	601182	Ref. No.	5424300
description	gearbox motor shaft ø 14mm flange ø 105mm transmission 1/80 drive shaft ø 25mm fixing dimensions 86-110mm type MV 63A		

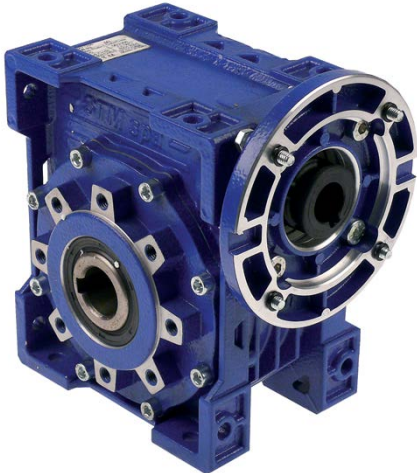
1			
GEV No.	697326	Ref. No.	PF08410
description	gearbox motor shaft ø 19mm flange ø 120mm transmission 1/70 drive shaft ø 25mm type UMI 63		

1		Image not available	
GEV No.	601183	Ref. No.	5424260
description	gearbox type 1/64		

for fridges

housing and bezels

lids

1			
GEV No.	694671	Ref. No.	PEPC003
description	cover for evaporator grey L 775mm W 175mm H 435mm Qty 1 pcs		



holders



1

GEV No.	700930	Ref. No.	PSEL004
description	bracket for evaporator flap plastic L 33mm W 25mm H 8mm ID ø 8mm ext. ø 12 mounting pos. rear		

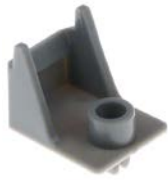

1

GEV No.	700929	Ref. No.	PSEL005
description	bracket for evaporator flap plastic L 35mm W 27mm H 27mm ID ø 8mm ext. ø 12.5 mounting pos. front		

caps



1

GEV No.	692372	Ref. No.	RC0736
description	cap grey ø 16.5mm mounting ø 12.5mm H 7mm Qty 1 pcs		

doors



1

GEV No.	195004	Ref. No.	PPLR032
description	door right W 710mm H 1664mm thickness 60mm		

miscellaneous



1

GEV No.	696413	Ref. No.	GN650TN.01
description	screw thread M6 L 18mm		

for refrigerated counters

lid hinges



1

GEV No.	700947	Ref. No.	PHFB354
description	lid hinge SS for saladette		

for espresso machines

brewing units

filter holder gaskets

O-rings



1

GEV No.	510409	Ref. No.	0200041
description	O-ring EPDM thickness 5.34mm ID ø 56.52mm Qty 1 pcs		

for pour machines

drain taps



1

GEV No.	531151	Ref. No.	PC187B-019 PC188B-019 PC188B-033 PC190B-019 PC190B-033
description	outlet tap tube ø 22.5mm pipe length 52mm thread M16 black		

liquid level pipes

liquid level pipes



1

GEV No.	531130	Ref. No.	PC187B-037 PC188B-037 PC190B-018
----------------	--------	-----------------	--

description water level tube ED ø 12mm ID ø 10mm H 262mm for coffee machine

accessories for 531130



GEV No.	504297	Ref. No.	—
----------------	--------	-----------------	---

description gasket for water level tube ED ø 13mm ID ø 6mm silicone



1

GEV No.	525418	Ref. No.	PC187B-018 PC188B-018
----------------	--------	-----------------	--------------------------

description water level tube ED ø 12mm ID ø 9mm H 244mm

accessories for 525418



GEV No.	525269	Ref. No.	—
----------------	--------	-----------------	---

description end cap for water level tube ø 9mm H 15mm

for bain marie

drain systems



1

GEV No.	694305	Ref. No.	2450002800001 BAPM001
----------------	--------	-----------------	--------------------------

description drain fitting thread 1/2" H 14mm ID ø 15mm ED ø 32mm

for crepes makers

accessories



1

GEV No.	697850	Ref. No.	010444614
----------------	--------	-----------------	-----------

description batter spreader for crepes maker L 320mm W 275mm wood



1

GEV No.	694339	Ref. No.	010444615
----------------	--------	-----------------	-----------

description crêpe spatula L 430mm W 57mm thickness 4mm wood

for deep fryers

miscellaneous



1

GEV No.	692498	Ref. No.	A040572
----------------	--------	-----------------	---------

description mounting set fryer

for grills

spare parts and accessories



1

GEV No.	691871	Ref. No.	T052603000
----------------	--------	-----------------	------------

description cover L 73mm H 33mm W 30mm



sumps



1			
GEV No.	692237	Ref. No.	A041541
description	grease collecting tray L 357mm W 37mm H 29mm		

for griddles

griddles



1			
GEV No.	691902	Ref. No.	R065407000
description	griddle L 875mm W 720mm H 80mm stainless steel		

for convection ovens/combi-steamers

drain units

accessories



1			
GEV No.	694681	Ref. No.	AC02-2202
description	strainer insert ED ø 118mm H 13.5mm spring holder SS		

steam generators

steam generators



1			
GEV No.	691849	Ref. No.	R145001
description	steam generator L 425mm W 110mm H 530mm		

injection pipes





1			
GEV No.	692482	Ref. No.	AC12-0700
description	injection pipe L 243mm H 115mm ID ø 8mm ED ø 12mm		

front panels



1

GEV No.	694702	Ref. No.	AC21-1205/S/CH1
description	front panel for combi-steamer L 700mm W 190mm H 60mm SS with accessories RETIGO for touch screen		
accessories for	694702		
	GEV No.	360594	Ref. No. EA05-0052
	USB cable A mounting screw mounting bush 1.5m		
	GEV No.	360607	Ref. No. SP21-0001
	USB cover plastic A mounting screw mounting bush grey		
	GEV No.	404013	Ref. No. XC10-2000
	display combi-steamer Blue FreeScale2011 L 170mm W 130mm suitable for RETIGO model XC10-2000-10 with control H 50mm type blue		

cleaning system

nozzles



1

GEV No.	694682	Ref. No.	AT32-0052
description	nozzle hole \varnothing 6.45mm H 17.8mm metal ED \varnothing 52mm ID \varnothing 44.6mm		

door mechanics

accessories



1

GEV No.	694683	Ref. No.	AX03-0076
description	stop \varnothing 14mm rubber ID \varnothing 7.5mm H 14mm		



1

GEV No.	694680	Ref. No.	ZA13-0516
description	stop \varnothing 22.25mm rubber ID \varnothing 14.75mm H 7.3mm		

miscellaneous



1

GEV No.	698467	Ref. No.	AT00-0002
description	bracket plastic for spray gun \varnothing 21.5mm		





1

GEV No.	691878	Ref. No.	R722629
description	cover L 150mm		



1

GEV No.	601913	Ref. No.	AC25-0100
description	flap kit for combi-steamer with cover cap		
spare parts for	601913		
	GEV No.	602072	Ref. No. —
	gear motor 5W 220-240V voltage AC 50/60Hz 3/3.6rpm shaft ømm L 84mm W 70mm H 54.4mm		
	GEV No.	750400	Ref. No. AC25-0105
	pressure compensation valve for combi-steamer D1 ø 50mm D2 ø 84.5mm hole ø 50mm H 55mm		



1

GEV No.	696592	Ref. No.	AC00-2500
description	hose connector bore ø 10mm D1 ø 10mm D2 ø 25mm SS thread M16		



1

GEV No.	691857	Ref. No.	T325077000
description	level tank L 178mm ø 75mm		



1

GEV No.	750400	Ref. No.	AC25-0105
description	pressure compensation valve for combi-steamer D1 ø 50mm D2 ø 84.5mm hole ø 50mm H 55mm		



1

GEV No.	692481	Ref. No.	AX04-0002
description	rubber gasket rubber W 9.7mm ø 65mm hole ø 48mm H 15mm		



1

GEV No.	698636	Ref. No.	50.38147
description	spacer piece SS thread 3/4" thickness 5mm H 70mm Qty 1 pcs		



1

GEV No.	691884	Ref. No.	R685003
description	water pipe L 860mm		

for hot dog machines

glass cylinders



1

GEV No.	693190	Ref. No.	HD-TW-016
description	glass cylinder ø 207mm with bottom H 240mm		

for tilting bratt pans

sumps

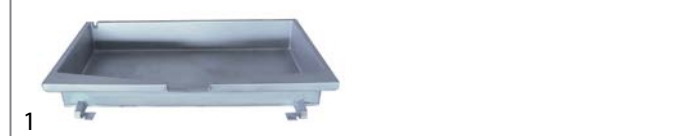

1

GEV No.	691900	Ref. No.	X286111000
description	sump for tilting bratt pan L 1260mm W 700mm H 200mm stainless steel		



1

GEV No.	691897	Ref. No.	X146133000 X156168000
description	sump for tilting bratt pan L 840mm W 700mm stainless steel		

miscellaneous



1

GEV No.	523510	Ref. No.	860
description	deep-groove ball bearing type 6202-2RS shaft \varnothing 15mm ED \varnothing 35mm W 11mm with sealing discs deep-groove ball bearing DIN 625-1		



1

GEV No.	514427	Ref. No.	X152679
description	fastening angle L 46mm for tilting bratt pan W 24mm H 25mm thickness 2mm		

for panini grill

guiding pieces



1

GEV No.	699289	Ref. No.	A042575
description	support bracket mounting pos. rear L 35mm W 14mm H 12.5mm		

for boiling pans

sumps



1

GEV No.	691896	Ref. No.	S226102000
description	sump for kettle ID \varnothing 680mm H 550mm L 850mm W 750mm stainless steel		

for contact grills

miscellaneous



1

GEV No.	701381	Ref. No.	A041543
description	handle L 350mm W 406mm H 20mm Panini		



1

GEV No.	692239	Ref. No.	A040548
description	spindle for contact grill L 404mm \varnothing 12mm		

for ovens

housing and bezels

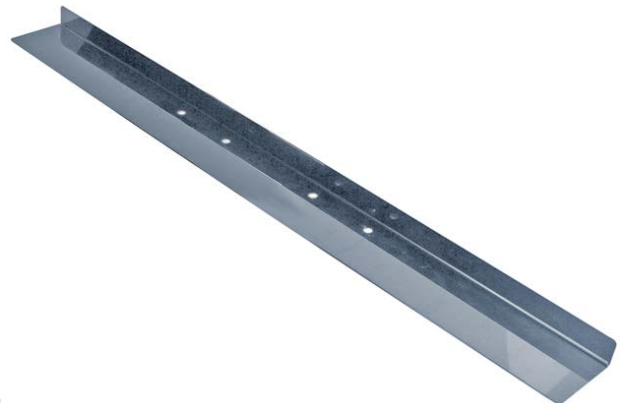

1

GEV No.	550769	Ref. No.	U805616
description	cover plate for switch		



1

GEV No.	691724	Ref. No.	R942800
description	front panel		

for salamander grills



1

GEV No.	697836	Ref. No.	A039868
description	gear wheel teeth 16 shaft intake ø 8mm ø 35mm tooth width 3mm W 18mm for toaster		

for pizza ovens

glass panels



1

GEV No.	700962	Ref. No.	VETRO005
description	glass panel L 415mm W 108mm thickness 5mm rectangular for door		
accessories for	700962		
	GEV No.	901400	Ref. No. GUARN003
description	window gasket suitable for GGF L 416mm external weith 113mm Qty 1m thickness 2.5mm		

for dishwashers

containers

salt tanks



1

GEV No.	524177	Ref. No.	480005
description	lid ø 69mm H 20mm for salt tank ID ø 50mm		
accessories for	524177		
	GEV No.	524148	Ref. No. —
description	O-ring EPDM thickness 3.53mm ID ø 40.86mm Qty 1 pcs		



1

GEV No.	510018	Ref. No.	429011
description	nut ø 92mm H 10.5mm for salt tank ID ø 64mm		

firebricks









1

GEV No.	850109	Ref. No.	TAVEL011
description	firebrick L 718mm W 359mm H 17mm delivery freight forwarding company only		







1

GEV No.	510929	Ref. No.	0200149
description	salt tank ø 120mm H 117mm hose ø 10mm mounting ø 70mm overall height 157mm		
spare parts for	510929		
	GEV No.	506015	Ref. No. 0200056 456052
	O-ring EPDM thickness 3.53mm ID ø 39.69mm Qty 1 pcs		
	GEV No.	510018	Ref. No. 429011
	nut ø 92mm H 10.5mm for salt tank ID ø 64mm		
	GEV No.	524177	Ref. No. 480005
	lid ø 69mm H 20mm for salt tank ID ø 50mm		
accessories for	510929		
	GEV No.	510071	Ref. No. 437034
	flat gasket rubber ED ø 81mm ID ø 68mm thickness 3mm for salt tank Qty 1 pcs		
	GEV No.	510654	Ref. No. —
	gasket H 6mm D1 ø 82mm D2 ø 68mm		
	GEV No.	510883	Ref. No. —
	gasket rubber ED ø 86mm ID ø 66mm thickness 2mm for salt tank Qty 1 pcs		



1

GEV No.	510032	Ref. No.	406998
description	salt tank without gasket new model		
spare parts for	510032		
	GEV No.	506015	Ref. No. 0200056 456052
	O-ring EPDM thickness 3.53mm ID ø 39.69mm Qty 1 pcs		
	GEV No.	510018	Ref. No. 429011
	nut ø 92mm H 10.5mm for salt tank ID ø 64mm		

spare parts for	510032		
	GEV No.	510071	Ref. No. 437034
	flat gasket rubber ED ø 81mm ID ø 68mm thickness 3mm for salt tank Qty 1 pcs		
	GEV No.	524177	Ref. No. 480005
	lid ø 69mm H 20mm for salt tank ID ø 50mm		

accessories



1

GEV No.	510071	Ref. No.	437034
description	flat gasket rubber ED ø 81mm ID ø 68mm thickness 3mm for salt tank Qty 1 pcs		

boilers

boilers for dishwashers



1

GEV No.	506142	Ref. No.	0400268
description	boiler		

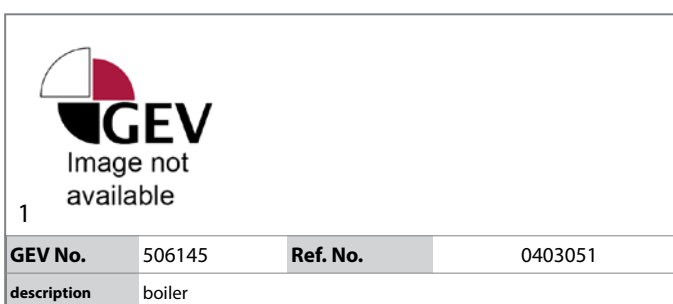

1

GEV No.	506145	Ref. No.	0403051
description	boiler		

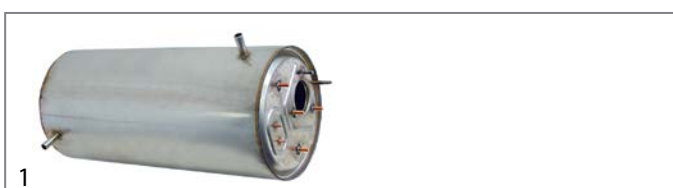

1

GEV No.	513243	Ref. No.	80389
description	boiler		



			
1			
GEV No.	506139	Ref. No.	0400262
description	boiler capacity 5l		

			
1			
GEV No.	506262	Ref. No.	0400261
description	boiler capacity 8l		

			
1			
GEV No.	518235	Ref. No.	104060
description	boiler ø 145mm L 405mm flange 3 hole flange		

gaskets			
			
1			
GEV No.	698802	Ref. No.	35510
description	gasket L 65mm W 10mm H 4mm thickness 4mm		

softener cartridges			
softening columns			
			
1			
GEV No.	530000	Ref. No.	0200011
description	softener 4-fold L 380mm W 180mm		

			
1			
GEV No.	524534	Ref. No.	117006
description	softener 6-fold L 380mm W 260mm		

housing and bezels			
flanges			
			
1			
GEV No.	699252	Ref. No.	75057
description	flange H 40mm ø 130mm mounting pos. lower		

			
1			
GEV No.	699251	Ref. No.	75141
description	flange H 65mm ø 130mm mounting pos. upper		

gearboxes			
			
1			
GEV No.	518634	Ref. No.	927102
description	gearbox motor shaft ø 14mm flange ø 160mm drive shaft ø 25mm type VF49A60		

hood mechanics for dishwashers			
bolts			
			
1			
GEV No.	506171	Ref. No.	0800117
description	screw bolt for grab handle hood mechanics		

			
1			
GEV No.	506206	Ref. No.	0899999
description	screw bolt for grab handle hood mechanics		

bushes



1			
GEV No.	506190	Ref. No.	0800497
description	bush for grab handle hood mechanics		



1			
GEV No.	506188	Ref. No.	0800418
description	bush for roller hood mechanics		



1			
GEV No.	506211	Ref. No.	0800108
description	bush hood mechanics		



1			
GEV No.	506212	Ref. No.	0800109
description	spacer bush hood mechanics		



1			
GEV No.	506213	Ref. No.	0800110
description	spacer bush hood mechanics		

springs



1			
GEV No.	517448	Ref. No.	926108
description	tension spring ø 30mm total length 505mm wire gauge ø 5.5mm for hood mechanics Qty 1 pcs		

guide bars



1			
GEV No.	506436	Ref. No.	0800116
description	guide bar L 1115mm ø 31.5mm		



1			
GEV No.	513724	Ref. No.	80068
description	guide bar L 590mm hood mechanics		



1			
GEV No.	698803	Ref. No.	41038
description	sliding rail L 458mm mounting pos. rear W 21mm H 20mm		

linkage



1			
GEV No.	506426	Ref. No.	0800701
description	linkage L 602mm hood mechanics for dishwasher		



1			
GEV No.	506228	Ref. No.	0800702
description	linkage L 635mm hood mechanics for dishwasher		
accessories for	506228		



GEV No.	560475	Ref. No.	0800144
hexagonal nut thread M10 H 11.5mm zinc-coated steel WS 17 Qty 1 pcs DIN/ISO DIN 982			

hood handles



1			
GEV No.	506176	Ref. No.	0800241
description	hood handle		



1			
GEV No.	506201	Ref. No.	0800750
description	hood handle		

1

GEV No.	506202	Ref. No.	0800751
description	hood handle		

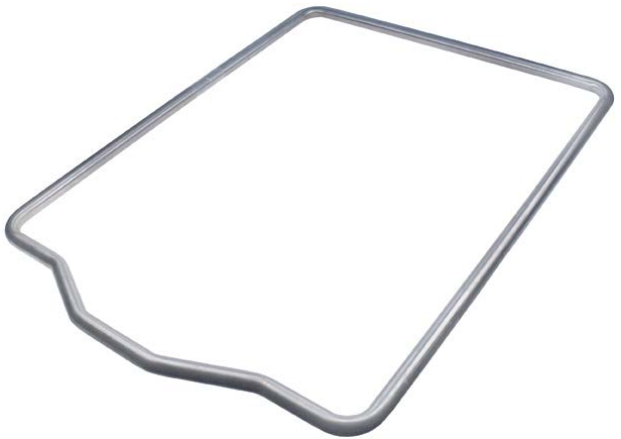

2

GEV No.	513719	Ref. No.	80027
description	hood handle		

rollers



1

GEV No.	506163	Ref. No.	0800048
description	roller hood mechanics dimensions 23x9.4/8mm		



1

GEV No.	506178	Ref. No.	0800244
description	roller hood mechanics dimensions 35x12mm PVC		

miscellaneous



1

GEV No.	508375	Ref. No.	80105
description	fixing support		



1

GEV No.	506023	Ref. No.	0200099
description	gasket hood mechanics thread M8		



1

GEV No.	513274	Ref. No.	80998
description	hexagonal screw thread M4 plastic WS 7 thread L 6mm		



1

GEV No.	506170	Ref. No.	0800115
description	hinge pine hood mechanics		



1

GEV No.	524791	Ref. No.	0200650
description	plate for hood mechanics L 39mm thread M10 zinc-coated steel H 10mm W 21mm		



1

GEV No.	506159	Ref. No.	0800020 GA0150007
description	rod guide hood mechanics with rollers		



1

GEV No.	506177	Ref. No.	0800242
----------------	--------	-----------------	---------

description	spacer piece hood mechanics		
--------------------	-----------------------------	--	--



1

GEV No.	506189	Ref. No.	0800420
----------------	--------	-----------------	---------

description	spacer piece hood mechanics L 18mm thread M16		
--------------------	---	--	--

basket guides

guide bars



1

GEV No.	506439	Ref. No.	0400156
----------------	--------	-----------------	---------

description	guide bar for warewashing basket mounting pos. left		
--------------------	---	--	--



1

GEV No.	506438	Ref. No.	0400157
----------------	--------	-----------------	---------

description	guide bar for warewashing basket mounting pos. right		
--------------------	--	--	--

basket holders



1

GEV No.	971148	Ref. No.	0400360
----------------	--------	-----------------	---------

description	basket support for dishwasher L 580m W 510mm H 75mm		
--------------------	---	--	--

accessories for	971148		
------------------------	--------	--	--

GEV No.	971151	Ref. No.	0400370
----------------	--------	-----------------	---------

description	mixer coupling L 450mm H 75mm		
--------------------	-------------------------------	--	--



1

GEV No.	699347	Ref. No.	75076
----------------	--------	-----------------	-------

description	buffer for basket transport L 25m ø 17.5mm		
--------------------	--	--	--



1

GEV No.	699344	Ref. No.	75058
----------------	--------	-----------------	-------

description	roller for basket H 35mm ø 45mm		
--------------------	---------------------------------	--	--

miscellaneous



1

GEV No.	512078	Ref. No.	0800094
----------------	--------	-----------------	---------

description	guide for dishwasher L 99mm W 45mm H 31.5mm		
--------------------	---	--	--









			
1			
GEV No.	971151	Ref. No.	0400370
description	mixer coupling L 450mm H 75mm		

air traps

air traps

			
1			
GEV No.	506221	Ref. No.	0201455
description	air trap L 40mm W 40mm H 85mm thread M12x1.75 ABS plastic		
accessories for	506221		
	GEV No.	506063	Ref. No. 0200295
	gasket suitable for Lamber equiv. no. 0200295 air trap ED ø 15.5mm ID ø 11.5mm Nyltite		
	GEV No.	506076	Ref. No. 0200638
	hose connector thread M12x1.75 hose ø 6mm		
	GEV No.	506220	Ref. No. 0200196
	gasket ø 4mm H 2.5mm nylon		
	GEV No.	560227	Ref. No. 0800652
	hexagonal nut thread M3 H 4mm SS WS 5.5 Qty 1 pcs self-locking		

			
1			
GEV No.	519499	Ref. No.	107012
description	air trap L 46mm W 35mm H 72mm thread 3/4" hose ø 5.5mm plastic		
accessories for	519499		
	GEV No.	516261	Ref. No. 437098
	flat gasket rubber ED ø 33mm ID ø 25mm thickness 2.5mm for air trap Qty 1 pcs		
	GEV No.	519498	Ref. No. 417120
	nut thread 3/4" H 10mm WS 30 plastic Qty 1 pcs		

			
1			
GEV No.	518200	Ref. No.	984005
description	air trap ø 34mm H 78mm hose ø 6mm plastic		
spare parts for	518200		
	GEV No.	504618	Ref. No. —
	O-ring EPDM thickness 2.62mm ID ø 15.54mm Qty 1 pcs		
	GEV No.	510075	Ref. No. —
	flat gasket rubber ED ø 22mm ID ø 13mm thickness 1.5mm Qty 1 pcs		

spare parts for	518200		
	GEV No.	510106	Ref. No. 468029
	hose connector for air trap		

			
1			
GEV No.	506414	Ref. No.	0200019
description	air trap ø 40mm H 100mm hose ø 10mm plastic		

			
1			
GEV No.	511959	Ref. No.	107014
description	air trap ø 42mm hose ø 6mm plastic		

			
1			
GEV No.	511993	Ref. No.	107013
description	air trap ø 43mm H 33mm hose ø 6mm plastic		

air trap accessories

			
1			
GEV No.	506429	Ref. No.	0200289
description	gasket for air trap		

			
1			
GEV No.	506220	Ref. No.	0200196
description	gasket ø 4mm H 2.5mm nylon		

			
1			
GEV No.	506431	Ref. No.	0200200
description	hose ED ø 10/15mm ID ø 4/10mm L 2200mm temp.-resist. 70°C for air trap		

			
1			
GEV No.	510106	Ref. No.	468029
description	hose connector for air trap		

			
1			
GEV No.	506040	Ref. No.	0200147
description	hose connector ø 4mm thread M12		

			
1			
GEV No.	506076	Ref. No.	0200638
description	hose connector thread M12x1.75 hose ø 6mm		

mechanics for flight type dishwashers



			
1			
GEV No.	524826	Ref. No.	0802051
description	bush for ratchet L 21mm ID ø 8mm ED ø 10mm suitable for Lamber		

			
1			
GEV No.	524789	Ref. No.	0800492
description	cable clamp wire gauge ø 5mm SS		

			
1			
GEV No.	504436	Ref. No.	0800407
description	coupling for transport system L 55mm ø 70mm ID ø 19mm suitable for Lamber		

			
1			
GEV No.	699351	Ref. No.	75231
description	cover for eccentrics plastic D1 ø 147mm D2 ø 32.6mm		

			
1			
GEV No.	524790	Ref. No.	0802048
description	distance washers for drive shaft H 10mm ID ø 12.4mm ED ø 22mm		

			
1			
GEV No.	529272	Ref. No.	0800123
description	drive shaft for transport system		
accessories for	529272		
	GEV No.	532144	Ref. No.
			—
	O-ring EPDM thickness 3.53mm ID ø 98.02mm Qty 10 pcs		
	GEV No.	694970	Ref. No.
			0802707
	gear wheel H 28mm ID ø 64mm ED ø 85mm hole ø 20mm		

			
1			
GEV No.	694970	Ref. No.	0802707
description	gear wheel H 28mm ID ø 64mm ED ø 85mm hole ø 20mm		

			
1			
GEV No.	524787	Ref. No.	0802046
description	thread bolt for drive shaft L 62mm ø 12mm suitable for Lamber thread M8x1.25		



backflow preventers

backflow preventers

			
1			
GEV No.	698703	Ref. No.	144995
description	air valve for drain hose D1 ø 21mm D2 ø 6mm ID ø 17mm		





			
1			
GEV No.	518486	Ref. No.	144010
description	backflow preventer connection 1/2" dishwasher hose ø 12mm		

			
1			
GEV No.	516101	Ref. No.	0500605
description	backflow preventer dishwasher hose ø 12mm		
spare parts for	516101		
		GEV No.	506367
		Ref. No.	—
	flat gasket rubber ED ø 40mm ID ø 28mm thickness 1.8mm Qty 1 pcs		

			
1			
GEV No.	524882	Ref. No.	H.324091
description	backflow preventer hose ø 12mm		

non-return valves			
			
1			
GEV No.	506073	Ref. No.	0200426
description	non-return valve plastic total length 26mm hose ø 11mm		

accessories			
			
1			
GEV No.	511997	Ref. No.	476008
description	ball for back flow restrictor ø 8mm plastic		

miscellaneous			
			
1			
GEV No.	698716	Ref. No.	CWP2
description	PCB support L 34mm		

			
1			
GEV No.	506160	Ref. No.	0800028
description	plain washer ID ø 8.6mm ED ø 16mm thickness 1.5mm SS Qty 1 pcs		

			
1			
GEV No.	343006	Ref. No.	214086
description	protective film for dishwasher self-adhesive L 485mm W 360mm Qty 1 pcs		

			
1			
GEV No.	698871	Ref. No.	419036
description	spacer for PCB L 18mm W 6mm D1 ø 6mm D2 ø 3mm		

door mechanics			
spare parts and accessories			
			
1			
GEV No.	507579	Ref. No.	75064
description	catch hook for door		

			
1			
GEV No.	507580	Ref. No.	75226
description	catch hook for door		

spring holders



1

GEV No.	551324	Ref. No.	307014
description	spring holder H 16mm L 17mm W 20mm		

springs

miscellaneous



1

GEV No.	698809	Ref. No.	449058
description	spring L 170mm W 75mm		

tension springs



1

GEV No.	701154	Ref. No.	449063
description	tension spring \varnothing 10.5mm total length 200mm wire gauge \varnothing 1.3mm for door mechanism		



1

GEV No.	519494	Ref. No.	0800714
description	tension spring \varnothing 9mm wire gauge \varnothing 1.5mm total length 168mm for door		

linkage



1

GEV No.	698800	Ref. No.	44593
description	bar L 670mm thread M6/M10 \varnothing 10mm		



1

GEV No.	506186	Ref. No.	0800408
description	door pin L 180mm door pin \varnothing 5mm		



1

GEV No.	506179	Ref. No.	0800400
description	door pin L 305mm door pin \varnothing 5mm		

threaded shafts



1

GEV No.	506180	Ref. No.	0800401
description	threaded part spigot		

sliding plates



1

GEV No.	517801	Ref. No.	307012
description	sliding plate L 75mm W 12mm H 10mm		



1

GEV No.	506182	Ref. No.	0800403
description	sliding plate plate		

hinges



1

GEV No.	506168	Ref. No.	0800099
description	door bolt door bearing		



1

GEV No.	504797	Ref. No.	35060
description	door hinge mounting pos. left \varnothing 10mm L 70mm		

door seals

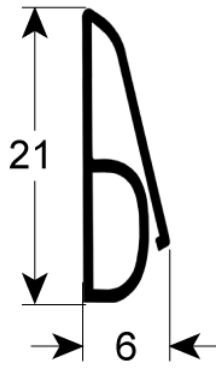

1

GEV No.	512472	Ref. No.	35017
description	door seal L 625mm W 21mm		



door guides



1

GEV No.	698744	Ref. No.	307015
description	door guides L 109mm W 24.5mm H 18mm mounting pos. left/right		



1

GEV No.	698797	Ref. No.	310013
description	guide L 30mm W 17mm H 17mm mounting pos. right/left		

door frames



1

GEV No.	901694	Ref. No.	41197
description	frame for door mounting pos. upper W 34mm L 595mm SS mounting distance 225mm		

door bumpers



1

GEV No.	506181	Ref. No.	0800402
description	door bumper hinge camp		



1

GEV No.	506185	Ref. No.	0800406
description	door bumper hinge camp brass		

locks



1

GEV No.	506157	Ref. No.	0800006
description	door catch catch		



1

GEV No.	506183	Ref. No.	0800404
description	door catch counterpart		

miscellaneous



1

GEV No.	513203	Ref. No.	80277
description	bracket for lever		



1

GEV No.	506173	Ref. No.	0800169
description	bush for door bolt		



1

GEV No.	524254	Ref. No.	0800480
description	hauling cable for door ø 3mm L 1800mm		



1

GEV No.	513204	Ref. No.	80275
description	opposite support for spring ø 28mm L 100mm		



1

GEV No.	698748	Ref. No.	35013
description	side panel for door L 235mm W 100mm thickness 2mm		

screw connections

			
1			
GEV No.	506196	Ref. No.	0800673
description	nut brass		

			
1			
GEV No.	506027	Ref. No.	0200114
description	nut thread 2" for intake body		

			
1			
GEV No.	519498	Ref. No.	417120
description	nut thread 3/4" H 10mm WS 30 plastic Qty 1 pcs		

			
1			
GEV No.	506132	Ref. No.	0300047
description	nut thread 3/8"		

			
1			
GEV No.	698874	Ref. No.	417119
description	nut thread M3 H 3.5mm plastic Qty 1 pcs for PCB		

			
1			
GEV No.	698705	Ref. No.	429075
description	screw H 14mm WS 22 Qty 1 pcs plastic for air valve		

			
1			
GEV No.	698876	Ref. No.	486078
description	screw thread M6x30mm Qty 1 pcs SS		

curtains

			
1			
GEV No.	533008	Ref. No.	75120
description	curtain W 540mm H 405mm plastic thickness 1.3mm		
accessories for	533008		
	GEV No.	533009	Ref. No.
			75121
	curtain rod L 545mm ø 8mm		

			
1			
GEV No.	533018	Ref. No.	77120
description	curtain W 585mm H 400mm		

			
1			
GEV No.	533007	Ref. No.	75123
description	curtain W 620mm H 250mm thickness 1.4mm		

curtain rods

			
1			
GEV No.	533009	Ref. No.	75121
description	curtain rod L 545mm ø 8mm		





			
1			
GEV No.	533019	Ref. No.	75124
description	curtain rod L 620mm ø 8mm		

washing and rinsing systems





			
1			
GEV No.	506012	Ref. No.	0200038
description	bearing rinse arm SS		





			
1			
GEV No.	506174	Ref. No.	0800175
description	bush for rinse arm mounting pos. lower		

			
1			
GEV No.	506193	Ref. No.	0800500
description	bush for rinse arm mounting pos. lower		

			
1			
GEV No.	506192	Ref. No.	0800499
description	bush for rinse arm ø 13.3mm		

			
1			
GEV No.	506191	Ref. No.	0800498
description	bush for rinse arm ø 16.2mm		

				
1				
GEV No.	517568	Ref. No.	41064	
description	counterflange for wash arm support ø 69mm ID ø 63mm H 35mm mounting distance 64mm hole ø 7mm			
accessories for	517568			
	GEV No.	531605	Ref. No.	42053
	extension for rinsing shaft ø 16mm H 122mm thread L 12mm WS 19			
	GEV No.	532603	Ref. No.	926252
	O-ring EPDM thickness 3.53mm ID ø 69.85mm Qty 1 pcs			
	GEV No.	698750	Ref. No.	41185
	throttle disc ø 71.5mm hole ø 17/22mm			

				
1				
GEV No.	517441	Ref. No.	41064CP	
description	counterflange for wash arm support with throttle disc ø 70mm ID ø 63mm L 110mm W 89mm H 35mm			
spare parts for	517441			
	GEV No.	698750	Ref. No.	41185
	throttle disc ø 71.5mm hole ø 17/22mm			
accessories for	517441			
	GEV No.	531605	Ref. No.	42053
	extension for rinsing shaft ø 16mm H 122mm thread L 12mm WS 19			
	GEV No.	532603	Ref. No.	926252
	O-ring EPDM thickness 3.53mm ID ø 69.85mm Qty 1 pcs			

			
1			
GEV No.	506198	Ref. No.	0800686
description	disc for wash arm ID ø 50mm ED ø 22mm thickness 2mm nylon		

			
1			
GEV No.	524264	Ref. No.	0800053
description	disc for wash arm support mounting pos. upper ø 50mm H 2mm		



1

GEV No.	506094	Ref. No.	0201458
----------------	--------	-----------------	---------

description	flange thread 1 1/4" ø 110mm
--------------------	------------------------------



1

GEV No.	518240	Ref. No.	437078
----------------	--------	-----------------	--------

description	flat gasket rubber ED ø 33mm ID ø 17mm thickness 1.5mm Qty 1 pcs
--------------------	--



1

GEV No.	507541	Ref. No.	437102
----------------	--------	-----------------	--------

description	flat gasket rubber ED ø 74mm ID ø 57mm thickness 2mm Qty 1 pcs
--------------------	--



1

GEV No.	524792	Ref. No.	0200259
----------------	--------	-----------------	---------

description	gasket for rinse arm mounting pos. upper/lower ø 22.5mm ID ø 13mm thickness 10mm
--------------------	--



1

GEV No.	524786	Ref. No.	0200400
----------------	--------	-----------------	---------

description	gasket for wash arm mounting pos. upper/lower ø 46mm ID ø 36mm
--------------------	--



1

GEV No.	518071	Ref. No.	80178
----------------	--------	-----------------	-------

description	gasket for wash arm support L 109mm W 68mm
--------------------	--



1

GEV No.	524258	Ref. No.	0201504
----------------	--------	-----------------	---------

description	gasket suitable for Lamber for wash arm support L 100mm W 100mm Qty 1m ID ø 61mm
--------------------	--

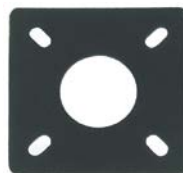

1

GEV No.	504440	Ref. No.	0201505
----------------	--------	-----------------	---------

description	gasket suitable for Lamber L 100mm W 100mm ID ø 43mm thickness 3mm
--------------------	--



1

GEV No.	504441	Ref. No.	0201503
----------------	--------	-----------------	---------

description	gasket suitable for Lamber L 100mm W 100mm Qty 1m ID ø 40mm thickness 3mm
--------------------	---



1

GEV No.	506127	Ref. No.	0221314
----------------	--------	-----------------	---------

description	hose connector thread 1 1/4" for hose ID 30mm curved plastic
--------------------	--



1

GEV No.	513158	Ref. No.	80365
----------------	--------	-----------------	-------

description	knurled nut
--------------------	-------------



1

GEV No.	518665	Ref. No.	454006
----------------	--------	-----------------	--------

description	knurled nut mounting pos. upper/lateral ø 19.65mm H 4mm thread M5
--------------------	---





1

GEV No.	518238	Ref. No.	143173
----------------	--------	-----------------	--------

description	manifold ø 12mm L 98mm
--------------------	------------------------





			
1			
GEV No.	518637	Ref. No.	429073
description	nut for wash arm support thread M56x2		

			
1			
GEV No.	518086	Ref. No.	80174
description	opposite support		

			
1			
GEV No.	518089	Ref. No.	80184
description	retaining ring for wash arm ID ø 40mm ED ø 44mm thickness 3mm		

			
1			
GEV No.	524811	Ref. No.	303037
description	ring for wash arm ID ø 41mm ED ø 45mm thickness 3mm plastic		

			
1			
GEV No.	506101	Ref. No.	0201820
description	rinse arm support mounting pos. lower		

			
1			
GEV No.	518443	Ref. No.	468165
description	rinse arm support mounting pos. upper		

			
1			
GEV No.	506020	Ref. No.	0200096
description	rinse pipe		

			
1			
GEV No.	506104	Ref. No.	0201836
description	rinse pipe		

			
1			
GEV No.	513286	Ref. No.	80281
description	screw connection		

			
1			
GEV No.	518288	Ref. No.	429069
description	screw connection		

			
1			
GEV No.	506200	Ref. No.	0800712
description	spring SS for rinse pipe		

			
1			
GEV No.	513270	Ref. No.	80316
description	throttle disc		

			
1			
GEV No.	506172	Ref. No.	0800130
description	Thumb screw thread M6 thread L 9mm ø 22mm H 6mm SS		

			
1			
GEV No.	506421	Ref. No.	0800043
description	wash pipe L 200mm nylon size inch 1¼"		

			
1			
GEV No.	518645	Ref. No.	115140
description	wash pipe L 690mm		

			
1			
GEV No.	519493	Ref. No.	75165
description	wash pipe ø 48mm L 617mm plastic		

gear wheels

			
1			
GEV No.	698414	Ref. No.	0802722
description	gear wheel splitting 1/2" teeth 22 shaft intake ø 45mm H 7mm		

for toasters



pliers



pliers

			
1			
GEV No.	690010	Ref. No.	A040894
description	plier for toaster H 180mm total length 100mm		

knobs

universal knobs

			
1			
GEV No.	110121	Ref. No.	65.27735
description	knob thermostat t.max. 200°C ø 50mm shaft ø 6x4.6mm shaft flat upper black temperature range 60-200°C rotation 270°		
accessories for	110121		
	GEV No.	110135	Ref. No.
			—
	rosette knob up to ø 52mm		

			
1			
GEV No.	111533	Ref. No.	MANOP003
description	knob thermostat t.max. 500°C ø 50mm shaft ø 6x4.6mm shaft flat upper black temperature range 0-500°C rotation 270°		
accessories for	111533		
	GEV No.	110135	Ref. No.
			—
	rosette knob up to ø 52mm		

accessories

rosettes

			
1			
GEV No.	111897	Ref. No.	65.043001
description	rosette knob		

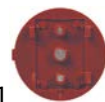
			
1			
GEV No.	112049	Ref. No.	65.043002
description	rosette knob		

handles and hand wheels

cylindrical handles

fixed

			
1			
GEV No.	110703	Ref. No.	627 IMPUG001
description	cylindrical handle thread M10 ø 28mm L 87mm		

			
1			
GEV No.	698472	Ref. No.	327
description	cylindrical handle thread M6 ø 24mm L 76mm black internal thread		

1

GEV No.	697442	Ref. No.	676
description	cylindrical handle thread M12 ø 28mm L 30mm		

cone handles



1

GEV No.	697431	Ref. No.	327
description	cone handle thread M6 ø 26mm plastic L 70mm black thread L 10mm		



1

GEV No.	697432	Ref. No.	825
description	cone handle thread M6 ø 26mm plastic L 70mm thread L 6mm		



1

GEV No.	697834	Ref. No.	A040576
description	cone handle thread M6x1 ø 13mm plastic L 53mm black thread L 6mm		

mushroom cap handles



1

GEV No.	697445	Ref. No.	677
description	mushroom cap handle thread M6 handle ø 33mm L 26mm plastic black		

ball handles



1

GEV No.	697346	Ref. No.	5873100
description	ball handle thread M4 ø 20mm black		

handle bars

handle bars



1

GEV No.	692128	Ref. No.	010578060	
description	handle rod tube ø 19mm L 690mm stainless steel			
accessories for	692128			
	GEV No.	694306	Ref. No.	A0308983
	console for handle rod tube ø 17mm plastic mounting pos. left/right Qty 1 pcs			



1

GEV No.	694307	Ref. No.	A0YXD1A34
description	handle rod tube ø 19mm thickness 1mm L 453mm SS		

consoles



1

GEV No.	694306	Ref. No.	A0308983	
description	console for handle rod tube ø 17mm plastic mounting pos. left/right Qty 1 pcs			
accessories for	694306			
	GEV No.	692128	Ref. No.	010578060
	handle rod tube ø 19mm L 690mm stainless steel			

handle rails

handle rails



GEV No.	508399	Ref. No.	0500017
description	handle rail L 310mm W 25mm H 30mm grey hole distance 180mm Qty 1 pcs		

bracket handles



GEV No.	506147	Ref. No.	0500045 0500049
description	pull handle		



GEV No.	691510	Ref. No.	A040575
description	pull handle L 130mm H 44mm mounting distance 112mm		



GEV No.	700965	Ref. No.	A039859 EB-600-18
description	pull handle L 275mm H 60mm mounting distance 197mm thread M8x1.25		

folding grill handles



GEV No.	692149	Ref. No.	A0GH81334
description	handle L 155mm ø 30mm seat ø 10mm for contact grill		

hinges

spring assisted hinges

universal

INTERKLIMAT

hinges

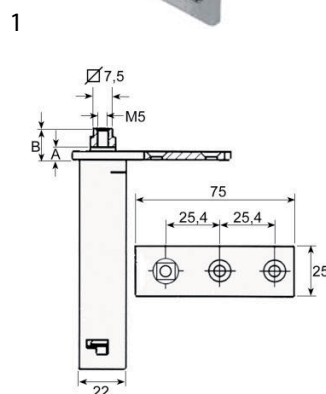

GEV No.	690622	Ref. No.	GN650TN.14
description	spring assisted hinge series 28L mounting pos. left/right L 75mm W 25mm H 103mm A 13mm B 18mm mounting measurements 22x22mm intake 7.5x7.5 refrigeration units		

producer-specific

INOMAK



GEV No.	700959	Ref. No.	PAMR101
description	hinge new edition L 190mm W 30mm H 116mm shaft length 11mm mounting distance 76mm mounting pos. upper		



1

GEV No.	700958	Ref. No.	PAMR360
description	hinge old edition L 195mm W 30mm H 116mm shaft length 11mm mounting distance 76mm mounting pos. upper		

IZMAK



1

GEV No.	700980	Ref. No.	PR-C153-030 PR-C200-030
description	spring assisted hinge left/right L 81mm W 25mm H 116mm for door mounting distance 30mm		

oven hinges



1

GEV No.	701380	Ref. No.	0A0YXD4A42
description	hinge mounting distance 142mm lever length 116mm groove distance 7mm spring thickness 3.5mm mounting ear position L 155mm W 19mm		



1

GEV No.	694789	Ref. No.	65.32729
description	opposite support mounting distance 94mm L 118mm W 17mm cut-out 8x59mm		



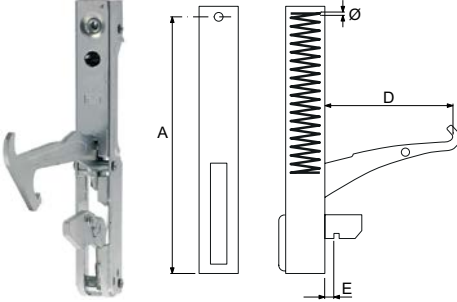

1

GEV No.	701404	Ref. No.	65.32728
description	oven hinge mounting distance 118mm mounting distance 2mm lug mounting 14mm lever length 117mm groove distance 11mm spring thickness 4mm mounting ear position left/right spring length 55mm L 155mm mounting pos. W 22mm		



1

GEV No.	700000	Ref. No.	01057803	
description	oven hinge mounting distance 142mm mounting distance 2mm lug mountingmm lever length 127mm groove distance 10mm spring thickness 3.7mm mounting ear position L 155mm mounting pos. left/right			
accessories for	700000			
	GEV No.	693045	Ref. No.	—
	opposite support L 110mm W 12mm mounting distance 94mm			
	GEV No.	700707	Ref. No.	—
	opposite support mounting distance 94mm L 140mm mounting pos. left W 13mm with welded metal sheet H 110mm for hinge			

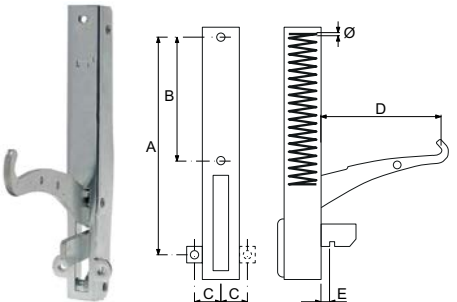



1

GEV No.	700820	Ref. No.	U020528000	
description	oven hinge mounting distance 173mm mounting distance 2mm lug mounting 14mm lever length 119mm groove distance 11mm spring thickness 3.5mm mounting ear position left/right spring length 112mm L 207mm W 25mm			
accessories for	700820			
	GEV No.	700001	Ref. No.	—
	opposite support L 118mm W 17mm mounting distance 94mm			

door bearing

			
1			
GEV No.	700975	Ref. No.	HF600.19
description	bolt L 20mm mounting pos. upper/lower thread M5 ø 7mm for hinge		

			
1			
GEV No.	701257	Ref. No.	S900.06
description	bolt L 25mm mounting pos. upper thread M5 ø 7mm complete for door hinge Qty 1 pcs		

			
1			
GEV No.	701032	Ref. No.	GN2100TN.03 GN2100TN.06 RC0175
description	bolt L 32.4mm mounting pos. upper thread M8x1.25 ø 5/7mm with nut for door		

			
1			
GEV No.	700981	Ref. No.	PR-C153-093 PR-C200-093
description	bush H 17mm mounting pos. lower ø 12mm ID ø 8mm grey for door hinge		

			
1			
GEV No.	700933	Ref. No.	PKPC572
description	bush H 18mm mounting pos. lower ø 18mm ID ø 8mm grey mounting measurements 22x22mm for hinge external size 25x25mm		

			
1			
GEV No.	700928	Ref. No.	PPLAC226
description	bush L 15mm mounting pos. upper ø 12mm ID ø 6.5mm for hinge external size 16mm		

			
1			
GEV No.	700976	Ref. No.	RC0176
description	bush L 20mm ø 9mm ID ø 7.1mm for hinge		

			
1			
GEV No.	700955	Ref. No.	PAMC103
description	hinge L 101mm W 40mm H 2mm mounting pos. upper left new edition		

			
1			
GEV No.	700954	Ref. No.	PAMC104
description	hinge L 101mm W 40mm H 2mm mounting pos. upper right new edition		

			
1			
GEV No.	700948	Ref. No.	PKMC361
description	hinge L 132mm W 38mm H 6mm mounting pos. bottom left old edition		

			
1			
GEV No.	700949	Ref. No.	PKMC363
description	hinge L 132mm W 38mm H 6mm mounting pos. bottom right old edition		

			
1			
GEV No.	700951	Ref. No.	PKMC105
description	hinge L 140mm W 40mm H 19mm mounting pos. bottom left new edition		

			
1			
GEV No.	700950	Ref. No.	PKMC106
description	hinge L 140mm W 40mm H 19mm mounting pos. bottom right new edition		





			
1			
GEV No.	700957	Ref. No.	PKMR102
description	hinge L 190mm W 32mm H 13.5mm mounting distance 76mm mounting pos. lower new edition shaft ø 8mm		

			
1			
GEV No.	700956	Ref. No.	PKMR036
description	hinge L 195mm W 30mm H 5mm mounting distance 76mm mounting pos. lower old edition shaft ø 8mm		

			
1			
GEV No.	700997	Ref. No.	PR-C153-021 PR-C200-021
description	hinge L 40mm W 39mm H 18mm mounting pos. left/right upper set		

			
1			
GEV No.	700974	Ref. No.	HF600.08
description	hinge L 49mm W 40mm H 43mm mounting pos. lower thickness 4mm		

			
1			
GEV No.	700973	Ref. No.	HF600.01
description	hinge L 51mm W 40mm mounting pos. upper thickness 3mm		

			
1			
GEV No.	700983	Ref. No.	PR-C153-022 PR-C200-022
description	hinge L 73mm W 40mm H 17mm mounting pos. bottom right thickness 3mm		

			
1			
GEV No.	700982	Ref. No.	PR-C153-036 PR-C200-036
description	hinge L 73mm W 40mm mounting pos. bottom left thickness 3mm		

			
1			
GEV No.	701038	Ref. No.	GN650TN.15
description	hinge camp mounting pos. upper right L 99mm W 64mm H 30mm hole distance 60mm shaft diameter 8x8mm		

miscellaneous

			
1			
GEV No.	700926	Ref. No.	040607
description	door hinge L 75mm W 60mm mounting distance 48mm		

pullouts

rollers

rollers

accessories

			
1			
GEV No.	560133	Ref. No.	0800063 0800656
description	hexagonal nut thread M6 H 5mm WS 10 SS DIN/ISO DIN 934 / ISO 4032/8673 Qty 20 pcs		

fittings for catering equipment

outlet taps

universal

			
1			
GEV No.	697834	Ref. No.	A040576
description	cone handle thread M6x1 ø 13mm plastic L 53mm black thread L 6mm		

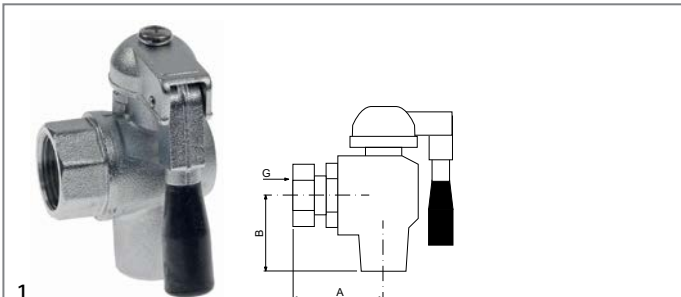

1

GEV No.	541540	Ref. No.	A040578
description	outlet tap stainless steel W 38mm H 40mm thread 3/4" IT		
spare parts for	541540		
	GEV No.	697834	Ref. No.
			A040576
	cone handle thread M6x1 ø 13mm plastic L 53mm black thread L 6mm		



1

GEV No.	692499	Ref. No.	A041308
description	reducer L 46mm thread 1/2" ET / 3/4" ET ø 26mm		



1

GEV No.	541749	Ref. No.	016210830
description	rosette for outlet tap thread D1 ø 63mm D2 ø 25mm		

aerators and air bleeders



1

GEV No.	540827	Ref. No.	S022103
description	aerator and air bleeder thread 3/4" ET chrome-plated L 45mm ø 36mm		

safety fittings

accessories



1

GEV No.	540832	Ref. No.	S332100
description	fitting support thread 1/2" ET suitable for manometer		
accessories for	540832		
	GEV No.	510166	Ref. No.
			—
	flat gasket fibre ED ø 31.3mm ID ø 26.3mm thickness 1.2mm Qty 1 pcs		

filters

grease filters



1

GEV No.	970831	Ref. No.	ZA17-0010
description	grease filter W 135mm H 155mm thickness 9mm SS layers 7 outer grids 2 inner grids 5		

equipment feet and end caps

equipment feet



1

GEV No.	701309	Ref. No.	AA00-0026
description	equipment foot tube ø 52mm thread M10 thread Lmm H 86-110mm SS size 2" Qty 1 pcs		



1

GEV No.	513287	Ref. No.	926117
description	equipment foot tube ø 60mm thread M12 thread L 33mm H 155-235mm SS size 2" Qty 1 pcs		



with fixing plate



1

GEV No.	700709	Ref. No.	PPR001
description	equipment foot tube \varnothing 64mm plate size 80x100mm hole distance 60x80mm H 115-170mm SS size 2 2/3" Qty 1 pcs		



1

GEV No.	701007	Ref. No.	PR-C153-035 PR-C200-035
description	equipment foot tube \varnothing 64mm plate size 82x82mm hole distance 68x68mm H 100-150mm SS size 2 1/2" Qty 1 pcs		
For models:	524060, 524062		

screw-in feet



1

GEV No.	700966	Ref. No.	A038973
description	equipment foot thread L 20mm \varnothing 37mm H 20mm Qty 1 pcs		



1

GEV No.	700972	Ref. No.	S900.13 SL0494
description	equipment foot thread M10 thread L 16mm \varnothing 29mm H 11.5mm Qty 1 pcs for fridge		



1

GEV No.	701006	Ref. No.	24500026000004 PPS105
description	equipment foot thread M10 thread L 27mm \varnothing 29mm H 41mm plastic WS 30 Qty 1 pcs		



1

GEV No.	697331	Ref. No.	5874000
description	equipment foot thread M10 thread L 32mm \varnothing 34mm H 12mm Qty 1 pcs		



1

GEV No.	697770	Ref. No.	628
description	equipment foot thread M8 thread L 12mm \varnothing 47mm H 35mm Qty 1 pcs		



1

GEV No.	513284	Ref. No.	461019
description	equipment foot thread M8 thread L 20mm \varnothing 30mm H 12mm Qty 1 pcs		

bolting feet



1

GEV No.	697849	Ref. No.	01044461
description	equipment foot H 28mm thread M8 D1 \varnothing 50mm D2 \varnothing 38mm thread L 10mm		



1



GEV No.	691509	Ref. No.	A042567 A0AT93602 EB-600-04
description	equipment foot \varnothing 28mm H 17.5mm rubber bore \varnothing 6mm Qty 1 pcs		





1

GEV No.	697433	Ref. No.	140
description	equipment foot \varnothing 35mm H 26mm bore \varnothing 5mm Qty 1 pcs		

equipment feet with stem

			
1			
GEV No.	697330	Ref. No.	8301340
description	equipment foot ø 35mm H 38mm bore ø 20mm rubber Qty 1 pcs		
accessories for	697330		
	GEV No.	697329	Ref. No.
			8301560
	bolt for equipment foot thread M12 ø 20mm H 30mm thread L 38mm		

miscellaneous

			
1			
GEV No.	697329	Ref. No.	8301560
description	bolt for equipment foot thread M12 ø 20mm H 30mm thread L 38mm		
accessories for	697329		
	GEV No.	697330	Ref. No.
			8301340
	equipment foot ø 35mm H 38mm bore ø 20mm rubber Qty 1 pcs		

miscellaneous

with fixing plate

ø100mm

			
1			
GEV No.	700960	Ref. No.	PRRW609
description	swivel castor ø 100mm plate fixing housing chrome-plated steel plate size 105x85mm hole distance 79mm capacity 80kg bearing slide bearing wheel body PVC tread PVC H 125mm wheel width 32mm Qty 1 pcs		

			
1			
GEV No.	700978	Ref. No.	SHSMTKFR0100
description	swivel castor ø 100mm plates fixing 70x80mm hole distance 50/60mm bearing ball bearing H 135mm wheel width 31.5mm		

			
1			
GEV No.	700961 ¹	Ref. No.	PRRB608
description	swivel castor with brake ø 100mm plates fixing 105x85mm hole distance 79mm bearing ball bearing H 125mm wheel width 32mm		

¹with swivel brake

			
1			
GEV No.	700979	Ref. No.	SHSMTKFZ0100
description	swivel castor with swivel brake ø 100mm plates fixing 70x80mm hole distance 50/60mm bearing ball bearing H 135mm wheel width 31mm		

with spigot

ø75mm

			
1			
GEV No.	700206	Ref. No.	8301580
description	swivel castor ø 75mm with thread bolt housing chrome-plated steel thread L 30mm thread ø M12x1.5mm capacity 100kg bearing ball bearing wheel body polyamide tread PVC H 100mm wheel width 35mm -20 up to +60°C Qty 1 pcs		

			
1			
GEV No.	700195 ¹	Ref. No.	8301570
description	swivel castor with brake ø 75mm with thread bolt housing chrome-plated steel thread L 30mm thread ø M12x1.5mm capacity 100kg bearing ball bearing wheel body polyamide tread PVC H 100mm wheel width 35mm -20 up to +60°C Qty 1 pcs		

¹with swivel brake



baskets

crumb screens



1

GEV No.	970743	Ref. No.	A041310
description	crumb screen L 245mm W 205mm H 5mm chrome-plated steel for fryer		



1

GEV No.	691007	Ref. No.	X316502
description	crumb screen L 332mm W 277mm suitable for fryer		

warewashing baskets

accessories

sliding corners



1

GEV No.	970820	Ref. No.	75075
description	sliding corner L 44mm W 44mm H 17mm		

shelves and shelf rails

grates

universal

without upstand



1

GEV No.	970725	Ref. No.	PR-C153-094 PR-C200-094
description	grate W 400mm D 630mm H 10mm plastic-coated steel wire gauge frame 6.6mm lengthwise wires gauge 4.5mm crossing wires 1 grey suitable for PRC153		



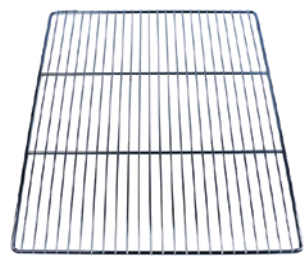

1

GEV No.	970650	Ref. No.	U135635
description	grate W 650mm D 530mm GN 2/1 chrome-plated steel wire gauge frame 8mm lengthwise wires gauge 3mm crossing wires 2		



1

GEV No.	970123	Ref. No.	GN650TN.08	
description	grate W 650mm D 530mm GN 2/1 stainless steel wire gauge frame 7.8mm lengthwise wires gauge 3.8mm crossing wires 2 suitable for refrigerator			
accessories for	970123			
	GEV No.	690330	Ref. No.	—
	rack L 1000mm W 22mm H 4mm aperture 3x8mm hole distance 12.5mm stainless steel			
	GEV No.	694700	Ref. No.	—
	shelf support L 31/28mm W 22mm H 18mm SS Qty 12 pcs			
	GEV No.	694701	Ref. No.	—
	shelf support L 31/28mm W 22mm H 17mm SS with hook Qty 12 pcs			

producer-specific

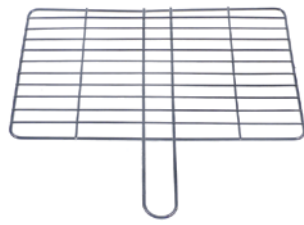

1

GEV No.	970715	Ref. No.	A040581
description	chargrill grid W 223mm D 352mm H 9mm chrome-plated steel with handle for toaster wire gauge frame 4mm lengthwise wires gauge 2.5mm crossing wires 4 BARTSCHER		

grid attachments



1	GEV No.	691918	Ref. No.	T122616
	description	rack support mounting pos. left L 585mm H 635mm W 40mm stainless steel suitable for 10/21		



1	GEV No.	691919	Ref. No.	T122614
	description	rack support mounting pos. right L 585mm H 635mm W 40mm stainless steel suitable for 10/21		

shelf rails and supports

producer-specific



1	GEV No.	700986	Ref. No.	PR-C153-088 PR-C200-088
	description	guide L-shape L 635mm W 18.5mm H 26mm mounting pos. left		



1	GEV No.	700987	Ref. No.	PR-C153-089 PR-C200-089
	description	guide L-shape L 635mm W 18.5mm H 26mm mounting pos. right		

SHELVES AND SHELF RAILS/GASKETS AMATIS



1	GEV No.	700937	Ref. No.	3400000090074 PPXM074
	description	guide U-shape L 508mm W 12mm mounting pos. right/left inner height 19mm		



1	GEV No.	696388	Ref. No.	CG11 GN2100TN.31
	description	pair of setting bar U-shape L 550mm W 20mm H 17mm mounting pos. left/right		



1	GEV No.	700934	Ref. No.	PPSO641
	description	pin for setting bar L 27mm W 13mm bore ø 4.5mm		

gaskets

refrigeration gaskets

plug-in gaskets

profile 9049

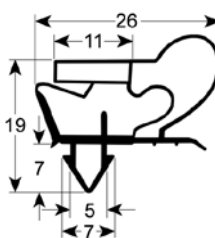

1	GEV No.	901284	Ref. No.	PR-C153-026 PR-C200-026
	description	refrigeration gasket profile 9049 W 475mm L 640mm plug size PRC153		

profile 9796

We offer custom-made gaskets for this profile

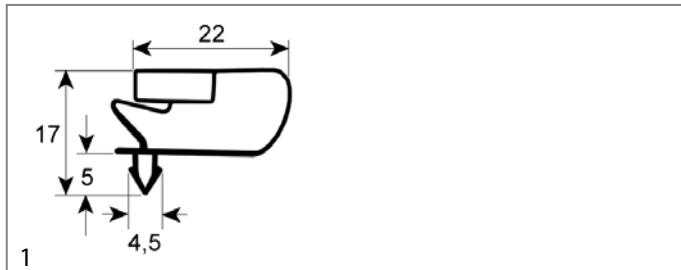

GEV No.	900895	Ref. No.	24500057100433 24500057100577 PLLC433 PLLC577
description	refrigeration gasket profile 9796 W 405mm L 480mm plug size		

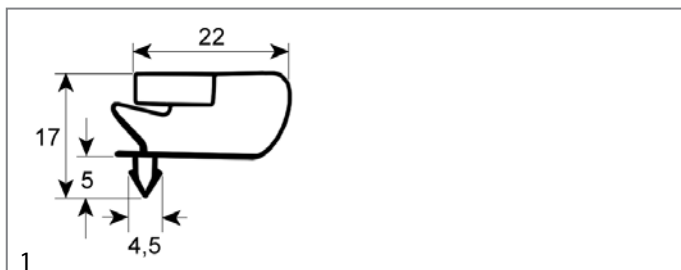

GEV No.	900896	Ref. No.	PLMC087 PLMC504
description	refrigeration gasket profile 9796 W 405mm L 650mm plug size		

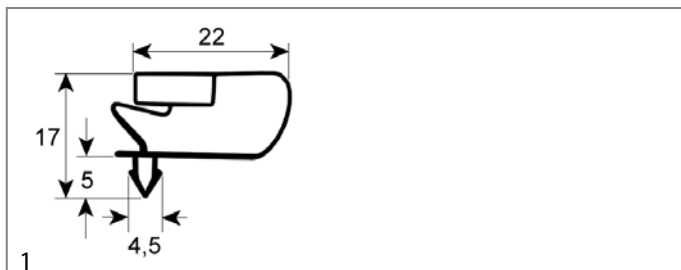

GEV No.	900900	Ref. No.	PLLR086
description	refrigeration gasket profile 9796 W 650mm L 1595mm plug size		

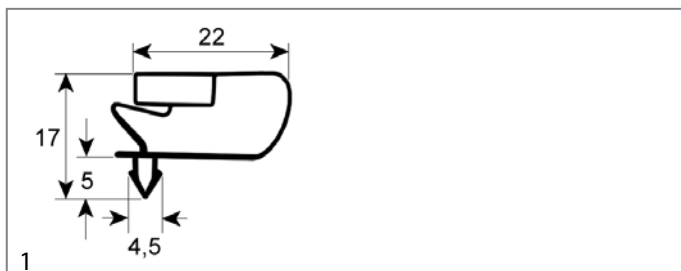

GEV No.	900898	Ref. No.	PLLR084 PLLR090
description	refrigeration gasket profile 9796 W 670mm L 1620mm plug size		

profile 9150

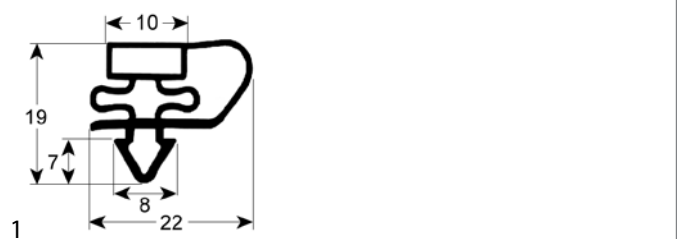

GEV No.	901279	Ref. No.	RC0072
description	refrigeration gasket profile 9150 W 395mm L 490mm plug size		

profile 9157

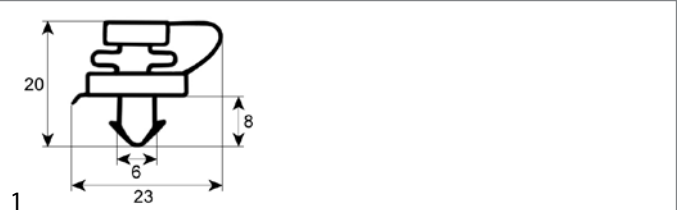

GEV No.	901281	Ref. No.	HF400.03
description	refrigeration gasket profile 9157 W 570mm L 1650mm plug size Qty 1		

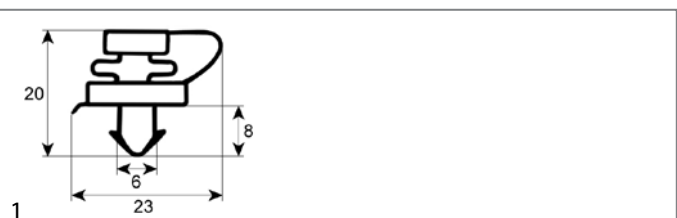

GEV No.	901333	Ref. No.	GN650TN.13
description	refrigeration gasket profile 9157 W 695mm L 1477mm plug size L1 1467mm W1 685mm external size		

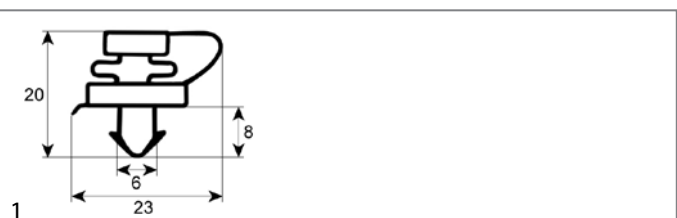

GEV No.	901282	Ref. No.	HF600.06
description	refrigeration gasket profile 9157 W 750mm L 1700mm plug size		

profile 9041

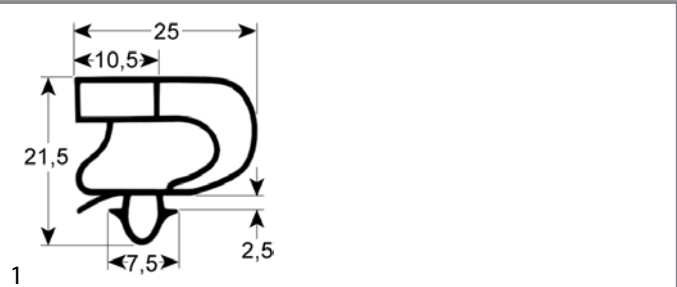

GEV No.	901957	Ref. No.	GN2100TN.33
description	refrigeration gasket profile 9041 W 385mm L 595mm plug size		

gaskets for heated units

door seals

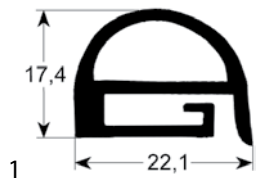

GEV No.	691062	Ref. No.	R140506
description	door seal profile 2270 W 775mm L 1300mm external size Qty 1		

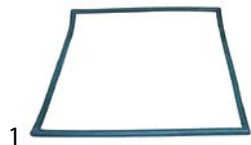

GEV No.	691069	Ref. No.	R680500
description	door seal profile 2270 W 775mm L 705mm external size Qty 1		

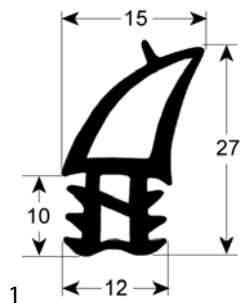

GEV No.	901721	Ref. No.	AX00-0035
description	door seal profile 2729 W 620mm L 490mm external size Qty 1 suitable for RETIGO		

door seals with fixing hook



GEV No.	901178	Ref. No.	010578049
description	door seal L 330mm W 680mm with 12 holes type series until 03/2013		



GEV No.	902003 ¹	Ref. No.	65.111002
description	door seal L 410mm W 230mm 3-sided long side open with 4 mounting clips		

¹3-sided, long side open

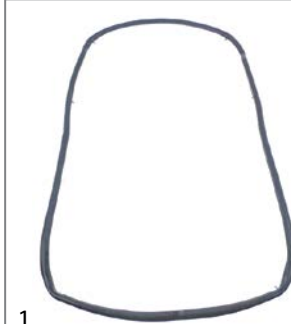

GEV No.	901842	Ref. No.	0105780491
description	door seal W 680mm H 330mm type series since 03/2013 16 holes		



GEV No.	901961	Ref. No.	65.111008
description	oven gasket L 220mm Wmm with 2 mounting clips		



GEV No.	901354	Ref. No.	A038980
description	oven gasket L 430mm W 330mm with 8 mounting clips		



GEV No.	901962	Ref. No.	65.111010
description	oven gasket L 875mm Wmm with 2 mounting clips		

O-rings

EPDM



GEV No.	510302	Ref. No.	0200103
description	O-ring EPDM ID ø 12.42mm thickness 1.78mm Qty 1 pcs		

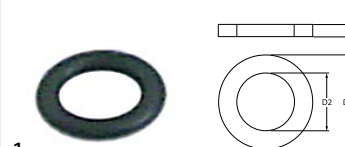

GEV No.	505045	Ref. No.	0200303
description	O-ring EPDM thickness 1.78mm ID ø 5.28mm Qty 1 pcs		

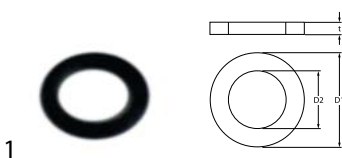
GEV No. 528485 **Ref. No.** 456060
description O-ring EPDM thickness 1.78mm ID ϕ 6.07mm Qty 1 pcs



GEV No. 504561 **Ref. No.** 456073
description O-ring EPDM thickness 2.62mm ID ϕ 29.82mm Qty 1 pcs



GEV No. 510177 **Ref. No.** 0200239
description O-ring EPDM thickness 1.78mm ID ϕ 7.66mm Qty 1 pcs

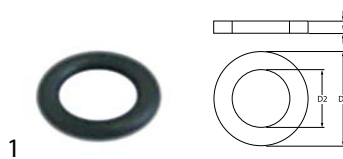

GEV No. 532047 **Ref. No.** 0200211
description O-ring EPDM thickness 2.62mm ID ϕ 7.59mm Qty 10 pcs



GEV No. 518227 **Ref. No.** 456020
description O-ring EPDM thickness 2.62mm ID ϕ 12.37mm Qty 1 pcs

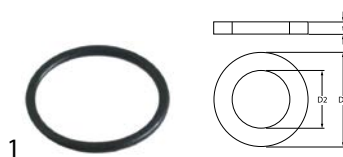

GEV No. 506015 **Ref. No.** 0200056
 456052
description O-ring EPDM thickness 3.53mm ID ϕ 39.69mm Qty 1 pcs

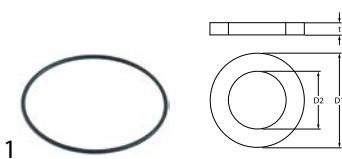

GEV No. 532623 **Ref. No.** 80844
description O-ring EPDM thickness 2.62mm ID ϕ 120.32mm Qty 1 pcs



GEV No. 532547 **Ref. No.** 0203009
description O-ring EPDM thickness 3.53mm ID ϕ 44.45mm Qty 1 pcs



GEV No. 511510 **Ref. No.** 456070
description O-ring EPDM thickness 2.62mm ID ϕ 15.54mm Qty 10 pcs



GEV No. 532603 **Ref. No.** 926252
description O-ring EPDM thickness 3.53mm ID ϕ 69.85mm Qty 1 pcs

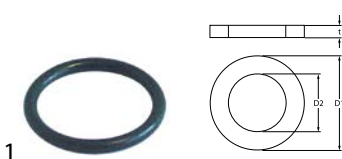

GEV No. 505073 **Ref. No.** Q307041
description O-ring EPDM thickness 2.62mm ID ϕ 20.63mm Qty 1 pcs



GEV No. 890224 **Ref. No.** 0203004
description O-ring EPDM thickness 3.53mm ID ϕ 98.02mm Qty 1 pcs



GEV No. 532058 **Ref. No.** 456071
description O-ring EPDM thickness 2.62mm ID ϕ 23.81mm Qty 10 pcs



GEV No. 698810 **Ref. No.** 456078
description O-ring EPDM thickness 3.56mm ID ϕ 112mm Qty 1 pcs

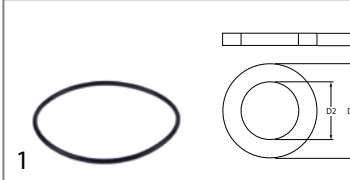

GEV No.	532543	Ref. No.	456076
description	O-ring EPDM thickness 5.34mm ID ø 136.5mm Qty 1 pcs		

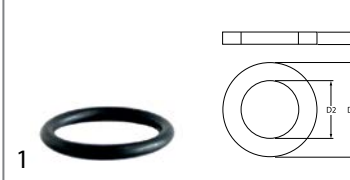

GEV No.	532577	Ref. No.	0203011
description	O-ring EPDM thickness 5.34mm ID ø 40.65mm Qty 1 pcs		

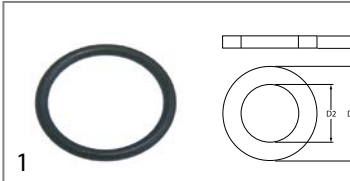

GEV No.	510408	Ref. No.	456002
description	O-ring EPDM thickness 5.34mm ID ø 47mm Qty 1 pcs		

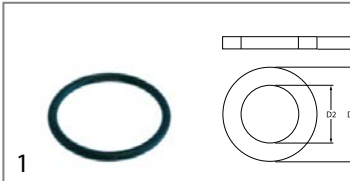

GEV No.	510409	Ref. No.	0200041
description	O-ring EPDM thickness 5.34mm ID ø 56.52mm Qty 1 pcs		

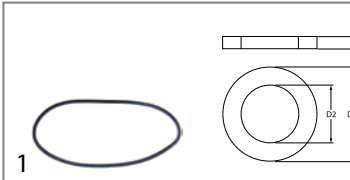

GEV No.	510551	Ref. No.	456023
description	pump cover gasket ID ø 158.3mm pump type 1214/1293/1225/2243/1226/1204/3473/1241 thickness 3.53mm EPDM Qty 1 pcs		

silicone



GEV No.	532584	Ref. No.	PC187B-034 PC188B-034 PC190B-034
description	O-ring silicone thickness 3mm ID ø 12mm Qty 1 pcs		

Viton



GEV No.	532625	Ref. No.	456081
description	O-ring Viton thickness 2.62mm ID ø 28.25mm Qty 1 pcs		

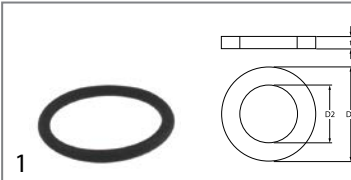

GEV No.	528155	Ref. No.	CGR4131NT
description	O-ring Viton thickness 3.53mm ID ø 32.93mm Qty 1 pcs		

PTFE



GEV No.	696591	Ref. No.	ZA13-1549
description	O-ring silicone thickness 5.5mm ID ø 48.75mm		

sealing washers

fibre gaskets



GEV No.	506046	Ref. No.	0200178
description	flat gasket FIBER ED ø 19.5mm ID ø 13mm thickness 2mm Qty 1 pcs		





GEV No.	506071	Ref. No.	0200402
description	flat gasket FIBER ED ø 25mm ID ø 18mm thickness 2mm Qty 1 pcs		





GEV No.	506042	Ref. No.	0200171
description	flat gasket FIBER ED ø 27mm ID ø 17mm thickness 2mm Qty 1 pcs		





			
1			
GEV No.	506025	Ref. No.	0200110
description	flat gasket FIBER ED ø 31mm ID ø 21mm thickness 2mm Qty 1 pcs		

			
1			
GEV No.	515018	Ref. No.	Q307032
description	flat gasket rubber ED ø 32mm ID ø 21mm thickness 3mm Qty 1 pcs		

			
1			
GEV No.	510164	Ref. No.	Q306052000
description	flat gasket fibre ED ø 24mm ID ø 16mm thickness 3mm Qty 1 pcs		

			
1			
GEV No.	518240	Ref. No.	437078
description	flat gasket rubber ED ø 33mm ID ø 17mm thickness 1.5mm Qty 1 pcs		

			
1			
GEV No.	529160	Ref. No.	004652632
description	flat gasket fibre ED ø 32mm ID ø 26mm thickness 1.5mm for drain tap suitable for 541540 Qty 1 pcs		

			
1			
GEV No.	516261	Ref. No.	437098
description	flat gasket rubber ED ø 33mm ID ø 25mm thickness 2.5mm for air trap Qty 1 pcs		

			
1			
GEV No.	506072	Ref. No.	0200403
description	flat gasket fibre ED ø 38mm ID ø 27mm thickness 2mm outflow for thread 1¼" Qty 1 pcs		

			
1			
GEV No.	518205	Ref. No.	437079 80182
description	flat gasket rubber ED ø 61mm ID ø 47mm thickness 2mm Qty 1 pcs		

rubber gaskets

			
1			
GEV No.	519547	Ref. No.	437041
description	flat gasket rubber ED ø 14.4mm ID ø 15.5mm thickness 2mm Qty 1 pcs size 3/4"		

			
1			
GEV No.	516254	Ref. No.	0201500
description	flat gasket rubber ED ø 66mm ID ø 46mm thickness 2.1mm Qty 1 pcs		

			
1			
GEV No.	506051	Ref. No.	0200188
description	flat gasket rubber ED ø 25mm ID ø 16mm thickness 2mm Qty 1 pcs		

			
1			
GEV No.	506121	Ref. No.	0201524
description	flat gasket rubber ED ø 68mm ID ø 41mm thickness 2mm Qty 1 pcs		

			
1			
GEV No.	505397	Ref. No.	437083
description	flat gasket rubber ED ø 32mm ID ø 19.5mm thickness 1.5mm Qty 1 pcs		

			
1			
GEV No.	507541	Ref. No.	437102
description	flat gasket rubber ED ø 74mm ID ø 57mm thickness 2mm Qty 1 pcs		

			
1			
GEV No.	506043	Ref. No.	0200173
description	flat gasket rubber ED ø 75mm ID ø 58.5mm thickness 2mm Qty 1 pcs		

			
1			
GEV No.	510071	Ref. No.	437034
description	flat gasket rubber ED ø 81mm ID ø 68mm thickness 3mm for salt tank Qty 1 pcs		

			
1			
GEV No.	518060	Ref. No.	456040
description	gasket rubber ED ø 132mm ID ø 122mm thickness 5mm		

			
1			
GEV No.	696658	Ref. No.	65.52845
description	rubber gasket rubber ED ø 11.5mm ID ø 8mm thickness 1.9mm Qty 1 pcs		

PTFE gaskets			
			
1			
GEV No.	513725	Ref. No.	437100
description	flat gasket PTFE ED ø 21.2mm ID ø 19mm thickness 0.5mm Qty 1 pcs		

			
1			
GEV No.	506164	Ref. No.	0800052
description	flat gasket PTFE ED ø 57mm ID ø 41mm thickness 2mm Qty 1 pcs		

			
1			
GEV No.	506058	Ref. No.	0200268
description	gasket PTFE ED ø 15mm ID ø 12.2mm thickness 9mm beveled size 3/8" Qty 1 pcs		

silicone gaskets			
			
1			
GEV No.	516255	Ref. No.	0200304
description	gasket silicone ED ø 45mm ID ø 35mm thickness 6mm Qty 1 pcs		

shaft gaskets			
shaft gaskets			
			
1			
GEV No.	697121	Ref. No.	0800080
description	shaft seal ID ø 17mm ED ø 40mm thickness 7mm		

			
1			
GEV No.	697475	Ref. No.	12671
description	shaft seal ID ø 20mm ED ø 30mm thickness 5mm		

			
1			
GEV No.	698001	Ref. No.	0800078
description	shaft seal ID ø 20mm ED ø 35mm thickness 7mm		

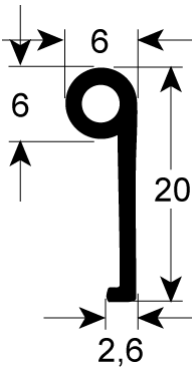
special gaskets			
door seals for dishwashers			
			
1			
GEV No.	518123	Ref. No.	41247
description	door seal L 1050mm W 6mm H 20mm Qty 1		

1

GEV No.	518613	Ref. No.	437103
description	door seal L 555mm W 395mm for dishwasher 3-sided		

miscellaneous

1

GEV No.	506044	Ref. No.	0200175
description	gasket		

1

GEV No.	506039	Ref. No.	0200145
description	gasket ED ø 7mm ID ø 5mm thickness 3mm		

1

GEV No.	506429	Ref. No.	0200289
description	gasket for air trap		

1

GEV No.	511999	Ref. No.	75168
description	gasket for flange ED ø 123mm ID ø 46mm rubber thickness 3mm hole distance 53mm		

1

GEV No.	524792	Ref. No.	0200259
description	gasket for rinse arm mounting pos. upper/lower ø 22.5mm ID ø 13mm thickness 10mm		

1

GEV No.	524786	Ref. No.	0200400
description	gasket for wash arm mounting pos. upper/lower ø 46mm ID ø 36mm		

1

GEV No.	506063	Ref. No.	0200295
description	gasket suitable for Lamber equiv. no. 0200295 air trap ED ø 15.5mm ID ø 11.5mm Nyltite		

1

GEV No.	506097	Ref. No.	0201506
description	gasket suitable for Lamber equiv. no. 0201506 L 100mm W 100mm thickness 3mm		

1

GEV No.	524258	Ref. No.	0201504
description	gasket suitable for Lamber for wash arm support L 100mm W 100mm Qty 1m ID ø 61mm		



1

GEV No.	504440	Ref. No.	0201505
description	gasket suitable for Lamber L 100mm W 100mm ID ø 43mm thickness 3mm		

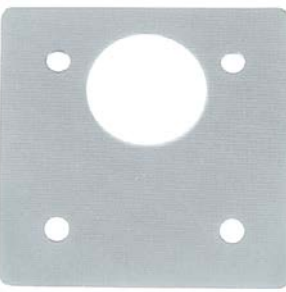

1

GEV No.	504441	Ref. No.	0201503
description	gasket suitable for Lamber L 100mm W 100mm Qty 1m ID ø 40mm thickness 3mm		



1

GEV No.	901400	Ref. No.	GUARN003
description	window gasket suitable for GGF L 416mm external weith 113mm Qty 1m thickness 2.5mm		

gaskets for wash arm support



1

GEV No.	506021	Ref. No.	0200097
description	gasket D1 ø 45mm D2 ø 105mm thickness 3.4mm rubber with 4 screw holes wash arm support equiv. no. 0200097 suitable for Lamber		



1

GEV No.	518339	Ref. No.	437064
description	gasket D2 ø 50mm thickness 2mm with 3 screw holes wash arm support equiv. no. 437064 suitable for COLGED hole ø 50mm hole distance 67mm		



1

GEV No.	518402	Ref. No.	437050
description	gasket with 3 screw holes wash arm support hole distance 61mm D2 ø 34mm thickness 2.5mm hole ø 34mm		

refrigeration cycle components

filter driers

CARLY



1

GEV No.	750288	Ref. No.	PFLK680
description	dryer type DCY052S ø 52mm L 112.5mm connection 1: 1/4"mm connection 2: 1/4"mm		

miscellaneous



1

GEV No.	750618	Ref. No.	GN1410TN.14
description	dryer size 15g ø 19mm L 114mm connection 2,7/6,5mm type XH9 Qty 1 pcs		



1

GEV No.	750254	Ref. No.	24500029100476 PFLP476
description	dryer size 20g ø 19mm L 138mm connection 2,5/6,2mm		



1

GEV No.	750324	Ref. No.	RC0066 S900.44
description	dryer size 20g ø 23mm L 117mm connection 4,8/8,3mm		



1

GEV No.	750291	Ref. No.	PFLR419
description	dryer size 50g ø 24mm L 373mm connection 2.4/4.8mm connection 3: 6.4		

refrigeration pipes

capillary pipes



1

GEV No.	694442	Ref. No.	S900.43
description	capillary pipe ED ø 2.1mm ID ø 1.15mm L 300mm copper Qty 1m refrigeration		



1

GEV No.	694443	Ref. No.	GN1410BT.05
description	capillary pipe ED ø 2.8mm ID ø 1.4mm L 2500mm copper Qty 1m refrigeration		



1

GEV No.	694444	Ref. No.	GN1410TN.13
description	capillary pipe ED ø 2.8mm ID ø 1.4mm L 3000mm copper Qty 1m refrigeration		

copper pipes uninsulated



1

GEV No.	694452	Ref. No.	GN2100TN.09
description	refrigeration pipe ED ø 6mm L 0.5m copper Qty 1m for evaporator		



1

GEV No.	694441	Ref. No.	GN650TN.40
description	refrigeration pipe ED ø 8mm ID ø 7mm L 1.8m copper insulated suction line		

evaporators for fridges

producer-specific



1

GEV No.	750309	Ref. No.	PEVR006
description	evaporator 743W VT -8°C heat output 563W L 738mm W 140mm H 430mm complete with fan		



1

GEV No.	750294	Ref. No.	HR400.07
description	evaporator for fridge ER400 L 1000mm W 440mm		



1

GEV No.	750295	Ref. No.	HR600.04
description	evaporator for fridge ER600 L 1000mm W 580mm		



1

GEV No.	750710	Ref. No.	PCOIL371 PCOIL373
description	evaporator for model CB,CB/SL,CZ L 410mm W 160mm H 167mm total length 440mm overall width 330mm overall height 210mm connection soldering connectionmm		



1

GEV No.	750410	Ref. No.	GN650TN.21
description	evaporator L 216mm W 130mm H 200mm total length 298mm overall width 130mm overall height 220mm		



1

GEV No.	750317	Ref. No.	GN650BT.02
description	evaporator L 298mm W 152mm H 220mm total length 518mm for fridge		





1

GEV No.	750296	Ref. No.	PR-C153-058 PR-C200-058
description	evaporator L 300mm W 75mm H 184mm		

1

GEV No.	750307	Ref. No.	PEVC016 PEVC223
description	evaporator L 385mm W 100mm H 390mm 224W with drain pan		
spare parts for	750307		
	GEV No.	750711	Ref. No. —
	drip tray for evaporator L 415mm W 110mm H 40mm		



1

GEV No.	750322	Ref. No.	GN2100TN.18 GN2100TN.21
description	evaporator L 505mm W 95mm H 265mm suitable for ER400/ER400G/ER400SS		



1

GEV No.	750308	Ref. No.	PEVR005
description	evaporator L 560mm W 123mm H 430mm suitable for INOMAK / up to SNR. 1294792 complete with fan		



1

GEV No.	750411	Ref. No.	PEVF347
description	evaporator L 560mm W 430mm H 140mm complete with fan		
For models:	524002		



1

GEV No.	750318	Ref. No.	GN1410TN.01
description	evaporator L 595mm W 130mm H 220mm for fridge		

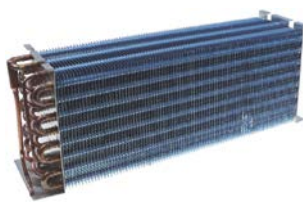

1

GEV No.	750321	Ref. No.	GN1410BT.08
description	evaporator L 595mm W 130mm H 220mm for fridge		



1

GEV No.	750396	Ref. No.	PCOIL377
description	evaporator L 715mm W 115mm H 160mm overall width 185mm overall height 330mm		

for saladettes



1

GEV No.	750433	Ref. No.	PEVC105
description	evaporator L 390mm W 100mm H 330mm		

accessories



1

GEV No.	750709	Ref. No.	PEPC002
description	cover for evaporator CA,CB,CZ,CA/SL,CB/SL L 475mm W 435mm H 185mm		

condensers

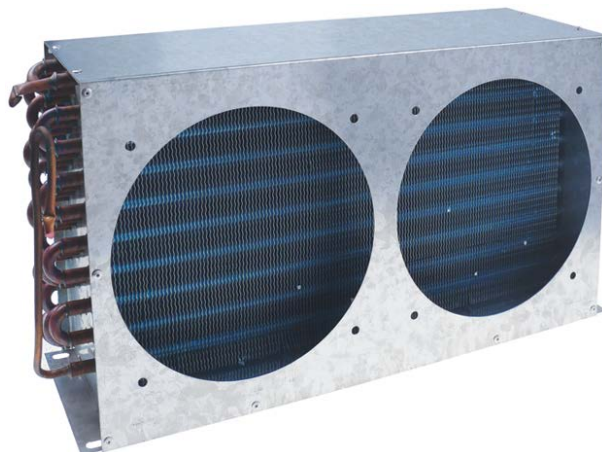

1

GEV No.	750323	Ref. No.	GN1410BT.06
description	condenser for fridge W 140mm H 271mm L 500mm		

condensers

filters



1

GEV No.	694446	Ref. No.	RC0122 S903.08
description	air filter for condenser L 218mm W 205mm thickness 6mm		



1

GEV No.	694445	Ref. No.	GN1410BT.07
description	air filter for condenser L 245mm W 215mm thickness 6mm		



1

GEV No.	694447	Ref. No.	GN2100TN.34
description	air filter for condenser W 175mm H 228mm thickness 6mm		



1

GEV No.	750320	Ref. No.	GN2100TN.08
description	condenser for pizza table W 280mm D 190mm H 230mm		

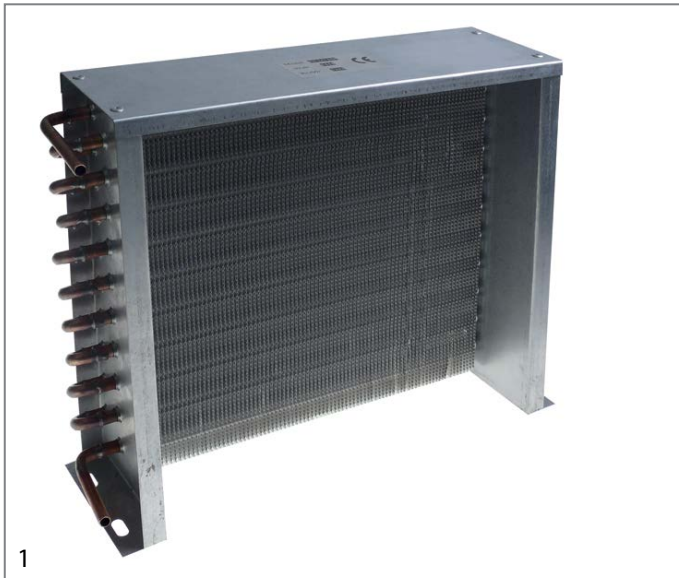

GEV No.	750297	Ref. No.	PR-C153-052 PR-C200-052 SHSGKD0103A1
description	condenser W 335mm D 100mm H 290mm		

transmission technology and ball bearings

ball bearings

deep-groove ball bearings 2RS



GEV No.	523551	Ref. No.	0802500
description	deep-groove ball bearing type 6003-2RS shaft \varnothing 17mm ED \varnothing 35mm W 10mm with sealing discs deep-groove ball bearing DIN 625-1		



GEV No.	523501	Ref. No.	637
description	deep-groove ball bearing type 608-2RS shaft \varnothing 8mm ED \varnothing 22mm W 7mm with sealing discs deep-groove ball bearing DIN 625-1		



GEV No.	523509	Ref. No.	0800131
description	deep-groove ball bearing type 6201-2RS shaft \varnothing 12mm ED \varnothing 32mm W 10mm with sealing discs deep-groove ball bearing DIN 625-1		



GEV No.	523510	Ref. No.	860
description	deep-groove ball bearing type 6202-2RS shaft \varnothing 15mm ED \varnothing 35mm W 11mm with sealing discs deep-groove ball bearing DIN 625-1		



GEV No.	523511	Ref. No.	0802501
description	deep-groove ball bearing type 6203-2RS shaft \varnothing 17mm ED \varnothing 40mm W 12mm with sealing discs deep-groove ball bearing DIN 625-1		



GEV No.	523512	Ref. No.	632
description	deep-groove ball bearing type 6204-2RS shaft \varnothing 20mm ED \varnothing 47mm W 14mm with sealing discs deep-groove ball bearing DIN 625-1		



GEV No.	523513	Ref. No.	8300190
description	deep-groove ball bearing type 6205-2RS shaft \varnothing 25mm ED \varnothing 52mm W 15mm with sealing discs deep-groove ball bearing DIN 625-1		

			
1			
GEV No.	523504	Ref. No.	862
description	deep-groove ball bearing type 626-2RS shaft \varnothing 6mm ED \varnothing 19mm W 6mm with sealing discs deep-groove ball bearing DIN 625-1		

deep-groove ball bearings 2Z

			
1			
GEV No.	523508	Ref. No.	5093000
description	deep-groove ball bearing shaft \varnothing 10mm ED \varnothing 30mm W 9mm type 6200-2Z DIN 625-1		

			
1			
GEV No.	692000	Ref. No.	5093100
description	deep-groove ball bearing shaft \varnothing 15mm ED \varnothing 35mm W 11mm type 6202-2Z DIN 625-1		

deep-groove ball bearings Z

			
1			
GEV No.	697842	Ref. No.	A039867
description	deep-groove ball bearing type 6203-Z shaft \varnothing 17mm ED \varnothing 40mm W 12mm DIN 625-1		

			
1			
GEV No.	697843	Ref. No.	A039869 EB-600-34
description	deep-groove ball bearing type 628-Z shaft \varnothing 8mm ED \varnothing 24mm W 8mm DIN 625-1		

flange bearings

			
1			
GEV No.	693112	Ref. No.	8300830
description	flange bearing type UCF204 shaft \varnothing 20mm 4 hole flange hole distance 64mm H 33mm flange length 86mm flange width 86mm hole \varnothing 12mm flange F204 ball bearing UC204G2 FH 25.5mm		

miscellaneous

			
1			
GEV No.	523021	Ref. No.	0800490
description	ball bearing shaft \varnothing 8mm ED \varnothing 27mm W 9.5mm plastic		

drive belts

poly-v belts

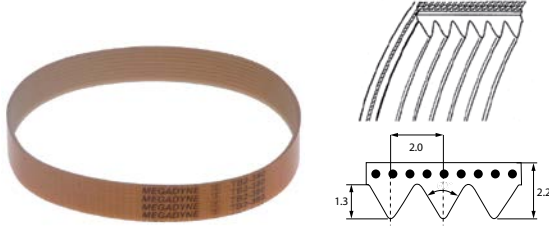
			
1			
GEV No.	698215	Ref. No.	635
description	poly-v belt grooves 10 W 20mm L 400mm profile TB2		

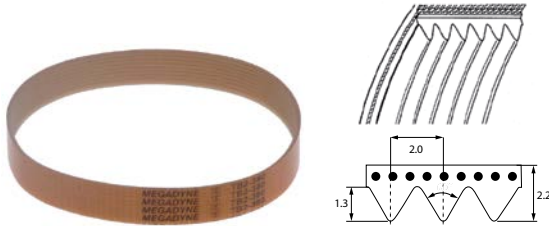
			
1			
GEV No.	698217	Ref. No.	861
description	poly-v belt grooves 7 W 14mm L 330mm profile TB2		



round belts



GEV No.	693701	Ref. No.	5070200
description	round belt ø 8mm L 540mm		



GEV No.	693873	Ref. No.	5070080
description	round belt ø 8mm L 560mm		



GEV No.	693875	Ref. No.	5070010
description	round belt ø 8mm L 784mm		

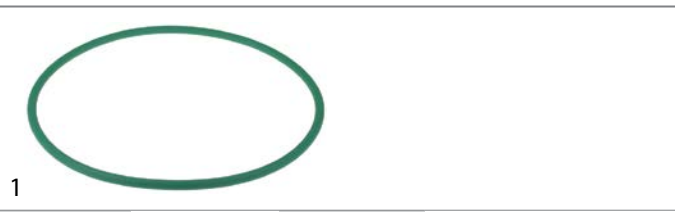

GEV No.	694578	Ref. No.	5070020
description	round belt ø 8mm L 805mm		

chains

roller chains 04B-1 single

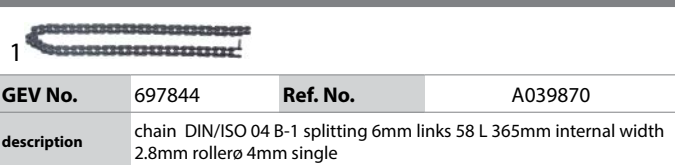

GEV No.	697844	Ref. No.	A039870
description	chain DIN/ISO 04 B-1 splitting 6mm links 58 L 365mm internal width 2.8mm rollerø 4mm single		

roller chains 06B-1 single

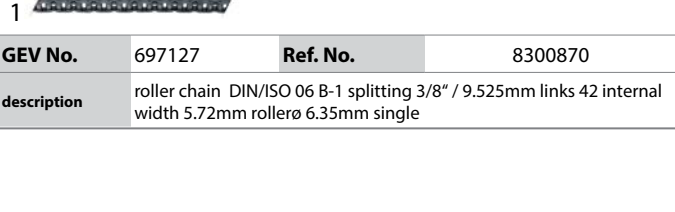

GEV No.	697127	Ref. No.	8300870
description	roller chain DIN/ISO 06 B-1 splitting 3/8" / 9.525mm links 42 internal width 5.72mm rollerø 6.35mm single		

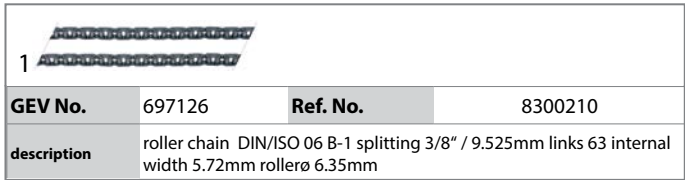

GEV No.	697126	Ref. No.	8300210
description	roller chain DIN/ISO 06 B-1 splitting 3/8" / 9.525mm links 63 internal width 5.72mm rollerø 6.35mm		

roller chains 08B-1 single

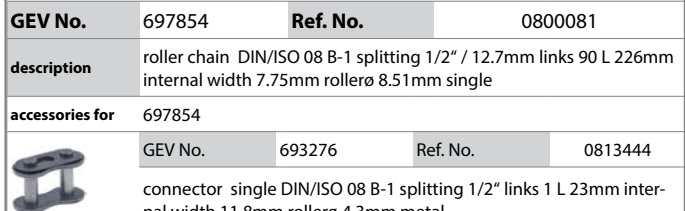

GEV No.	697854	Ref. No.	0800081
description	roller chain DIN/ISO 08 B-1 splitting 1/2" / 12.7mm links 90 L 226mm internal width 7.75mm rollerø 8.51mm single		



accessories for	697854		
GEV No.	693276	Ref. No.	0813444
description	connector single DIN/ISO 08 B-1 splitting 1/2" links 1 L 23mm internal width 11.8mm rollerø 4.3mm metal		

connectors

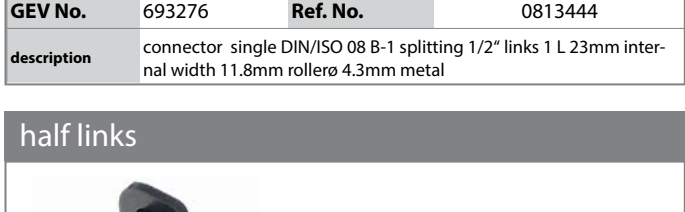

GEV No.	693276	Ref. No.	0813444
description	connector single DIN/ISO 08 B-1 splitting 1/2" links 1 L 23mm internal width 11.8mm rollerø 4.3mm metal		

half links

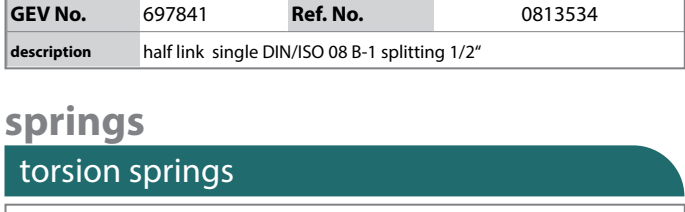

GEV No.	697841	Ref. No.	0813534
description	half link single DIN/ISO 08 B-1 splitting 1/2"		

springs

torsion springs



GEV No.	693789	Ref. No.	4000500
description	spring ø 12mm L2 70mm mounting pos. in the front/at the back wire gauge ø 1.5mm P30-P40 L1 3mm L3mm Qty 1 pcs		



GEV No.	700569	Ref. No.	A0GH81313
description	torsion spring ø 21.5mm L2 40mm wire gauge ø 3.3mm L1 100mm L3 45mm		

compression springs



GEV No.	696750	Ref. No.	CMT13
description	compression spring \varnothing 20mm L 89.5mm wire gauge \varnothing 2mm windings 14 zinc-coated steel		



GEV No.	697328	Ref. No.	5163010
description	compression spring \varnothing 7mm L 19.5mm wire gauge \varnothing 0.6mm		

spring compressors



GEV No.	513119	Ref. No.	926009
description	spring compressor		



GEV No.	517160	Ref. No.	0800210
description	spring compressor thread M10		

gas tension springs

gas tension springs



GEV No.	701299	Ref. No.	35070
description	gas tension spring 50N hub 150mm D1 \varnothing 15mm D2 \varnothing 6mm hole distance 365.5mm hole \varnothing 6.5mm L 380mm		

roller springs

roller springs



GEV No.	517449	Ref. No.	75271
description	roller spring L 95mm W 66mm		



GEV No.	517450	Ref. No.	77560
description	roller spring W 51mm ID \varnothing 31mm lug length 90mm		

tension springs



GEV No.	701154	Ref. No.	449063
description	tension spring \varnothing 10.5mm total length 200mm wire gauge \varnothing 1.3mm for door mechanism		



GEV No.	700730	Ref. No.	0800161
description	tension spring \varnothing 12mm total length 100mm wire gauge \varnothing 1mm		



GEV No.	697349	Ref. No.	PF08650
description	tension spring \varnothing 20mm wire gauge \varnothing 3mm L1 125mm L2 55mm		



GEV No.	517448	Ref. No.	926108
description	tension spring \varnothing 30mm total length 505mm wire gauge \varnothing 5.5mm for hood mechanics Qty 1 pcs		



GEV No.	506199	Ref. No.	0800711
description	tension spring \varnothing 40.5mm total length 355mm wire gauge \varnothing 5mm L1 220mm D1 \varnothing 40.5mm for hood H1 30mm L 355mm windings 42		



GEV No.	517451	Ref. No.	35020
description	tension spring \varnothing 8mm total length 150mm wire gauge \varnothing 1mm Qty 1 pcs		

kitchen accessories

gastronorm

bridges



GEV No.	700807	Ref. No.	R966104
description	bridge for Gastronorm container L1 327mm L2 307mm SS W 25mm H 15mm Qty 1 pcs		



manometers

 <p>1</p>			
GEV No.	541865	Ref. No.	0301152
description	manometer ø 51mm pressure range 0 up to 4bar thread 1/4" marking 3 connection on the backside		

hose reels and spray guns

spray guns

 <p>1</p>			
GEV No.	542038	Ref. No.	ZA15-0100
description	spray gun for appliances 3/8" IT L 135mm		

 <p>1</p>			
GEV No.	520892	Ref. No.	ZA11-0902
description	shower hose connections 3/8" L 1600mm EPDM t.max. 110°C burst p. 10bar for combi-steamer		

dosing pumps

peristaltic dosing pumps

SEKO

built-in version

with frequency control

 <p>1</p>			
GEV No.	361767 ¹	Ref. No.	209021
description	dosing pump SEKO 3l/h 230VAC detergent hose ø 4x6mm hose type K hose Santoprene suction level 1.5m type NBR 3 8W built-in version peristaltic pump		
spare parts for	361767		
GEV No.	361815	Ref. No.	—
description	pump hose detergent hose ø 6x10mm hose ø 4x6mm hose type K hose Santoprene type SEKO		

¹incl. inlet and conveyor hose

spare parts

 <p>1</p>			
GEV No.	698712	Ref. No.	143219
description	dosing hose SEKO detergent hose ø 4x8.6mm hose ø 4x6mm hose type H hose Santoprene		

various

built-in version

 <p>1</p>			
GEV No.	361299	Ref. No.	0500058
description	dosing pump hose ø 5x7mm		

piston pumps

spare parts

 <p>1</p>			
GEV No.	510298	Ref. No.	0200425
description	lip valve dosing pump suitable for DB2/DS5		

membrane dosing pumps

self-priming

LANG

 <p>1</p>			
GEV No.	361221	Ref. No.	0500057
description	dosing pump type N6 rinse aid pressure connection ø 4x6mm suction connection ø 6x8mm LANG		
spare parts for	361221		
GEV No.	361079	Ref. No.	—
description	spring for type N5/N6 for ball		
GEV No.	361080	Ref. No.	—
description	O-ring EPDM thickness 2mm ID ø 16mm Qty 1 pcs		

Table continues overleaf

spare parts for		361221		
	GEV No.	361085	Ref. No.	—
	O-ring EPDM thickness 2mm ID ø 8mm Qty 1 pcs			
	GEV No.	361309	Ref. No.	—
	ball for type N5/N6			
	GEV No.	361310	Ref. No.	—
	bracket for type N6 ball guide			
	GEV No.	361311	Ref. No.	—
	O-ring EPDM thickness 2mm ID ø 6mm Qty 1 pcs for type N6			
	GEV No.	361314	Ref. No.	—
	valve ring for type N6 holder for O-ring			
	GEV No.	361317	Ref. No.	—
	sealing disc for type N6			
	GEV No.	361886	Ref. No.	—
	non-return valve inletmm outletmm outlet ø 12.4mm L 12.7mm			
	GEV No.	505228	Ref. No.	—
	spacer bush ID ø 4.5mm ED ø 10mm L 16mm for dosing pump			





SEKO



1

GEV No.	361364 ¹	Ref. No.	209025	
description	dosing pump type DIB5E self-sucking rinse aid pump rate 0-5cm ³ per stroke pressure connection ø 4x6mm suction connection ø 4x6mm SEKO supporting pressure closed			
spare parts for	361364			
	GEV No.	361301	Ref. No.	—
	hose connector for type DIB3E/DIB5E			
	GEV No.	361302	Ref. No.	—
	valve bush for type DIB3E/DIB5E			
	GEV No.	361304	Ref. No.	—
	O-ring EPDM ID ø 11.11mm thickness 1.78mm Qty 1 pcs for type DIB3E/DIB5E			
	GEV No.	361305	Ref. No.	—
	valve disc for type DIB3E/DIB5E DIB3P/DIB5P			
	GEV No.	361306	Ref. No.	—
	membrane for type DIB3E/DIB5E ø 49mm hole ø 5mm			
	GEV No.	361307	Ref. No.	—
	membrane dosing pump ø 68mm hole ø 6mm for type DIB3P/DIB5P			



¹auxiliary pressure connection closed

spare parts for		361364		
	GEV No.	361459	Ref. No.	—
	hose connector ø 6mm for dosing pump			
	GEV No.	361481	Ref. No.	—
	lip valve for type DIB3P/DIB5P DIB3E/DIB5E			
accessories for	361364			
	GEV No.	361240	Ref. No.	—
	hose connector 1-way hose ø 6mm plastic connection M10x1			
	GEV No.	361241	Ref. No.	—
	hose connector 1-way hose ø 9mm plastic connection M10x1			

various



1

GEV No.	361015	Ref. No.	0599999	
description	dosing pump membrane dosing pump rinse aid inlet 6x8mm outlet 4x6mm pressure connection ø 4x6mm suction connection ø 6x8mm			
spare parts for	361015			
	GEV No.	361132	Ref. No.	0200428
	membrane dosing pump			
	GEV No.	510298	Ref. No.	0200425
	lip valve dosing pump suitable for DB2/DS5			

spare parts



1

GEV No.	510298	Ref. No.	0200425	
description	lip valve dosing pump suitable for DB2/DS5			



1

GEV No.	361132	Ref. No.	0200428	
description	membrane dosing pump			



self-priming with supporting pressure

ELETTROBAR

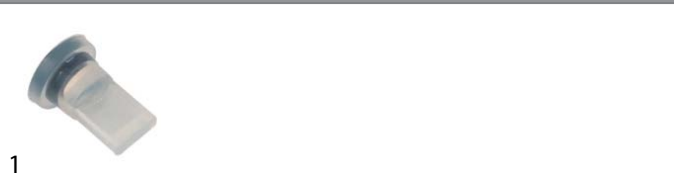

GEV No.	510298	Ref. No.	0200425
description	lip valve dosing pump suitable for DB2/DS5		

GERMAC

spare parts

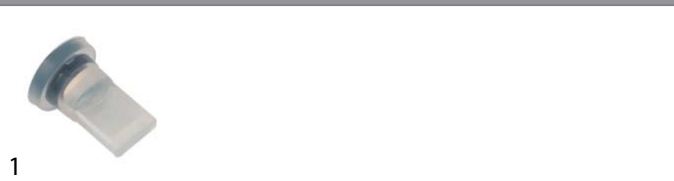

GEV No.	510298	Ref. No.	0200425
description	lip valve dosing pump suitable for DB2/DS5		

accessories

container filters

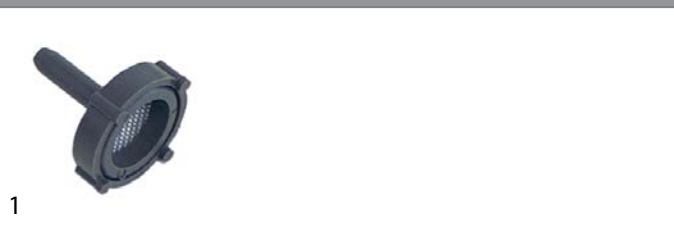

GEV No.	361062	Ref. No.	0200443
description	container filter hose ø 4mm		



GEV No.	513043	Ref. No.	121017
description	container filter hose ø 4mm		



GEV No.	361141	Ref. No.	121075
description	container filter with weight ceramic hose ø 4mm		



GEV No.	506095	Ref. No.	0201460
description	filter SS for rinse aid container		

hoses

dosing hoses



GEV No.	512477	Ref. No.	0200511
description	hose ED ø 6mm ID ø 4mm PVC		

silicone hoses



GEV No.	520242	Ref. No.	143235
description	silicone hose for peristaltic pump ID ø 4mm ED ø 7mm L 5m thickness 1.5mm t.max. 200°C Shore A 55° transparent dosing Qty 5m		

PVC hoses



GEV No.	520090	Ref. No.	0200091 143194
description	PVC hose ID ø 4mm ED ø 6mm L 2m thickness 1mm t.max. 60°C transparent		

accessories for	520090			
	GEV No.	361058	Ref. No.	—
	GEV No.	361066	Ref. No.	—
	GEV No.	361106	Ref. No.	—
	GEV No.	361141	Ref. No.	121075
	GEV No.	361230	Ref. No.	—
	GEV No.	361462	Ref. No.	—
	GEV No.	361728	Ref. No.	—

tank inlets



GEV No.	506150	Ref. No.	0500090
description	tank inlet		



GEV No.	361270	Ref. No.	468151
description	tank inlet SS M12 hose ø 4mm		

hoses

supply hoses

PVC supply hoses



GEV No.	520010	Ref. No.	Z602121
description	supply hose PVC straight-curved DN13 connections 3/4" L 1500mm operating p. 10bar burst p. 32bar t.max. 90°C blue approval VDE flat seal		

accessories for 520010



GEV No.	520053	Ref. No.	—
description	screen connection 3/4" D1 ø 26mm D2 ø 15mm Qty 10 pcs rubber thickness 8mm		



GEV No.	520054	Ref. No.	—
description	flat gasket rubber ED ø 23.5mm ID ø 14mm thickness 2.3mm Qty 10 pcs		



GEV No.	520011	Ref. No.	929169
description	supply hose PVC straight-curved DN13 connections 3/4" L 2000mm operating p. 10bar burst p. 32bar t.max. 90°C approval VDE flat seal		

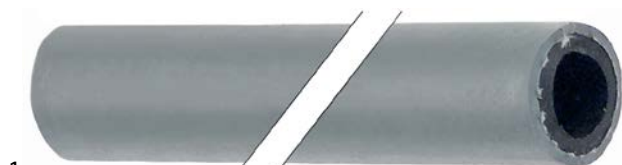

GEV No.	520015	Ref. No.	143004
description	supply hose ID ø 10mm ED ø 17mm L 5m operating p. 20bar burst p. 60bar t.max. 95°C grey Qty 5m		

accessories for 520015



GEV No.	504377	Ref. No.	—
description	hose connector grommet ø 23mm grommet length 25mm total length 55mm for water filling		



GEV No.	520017	Ref. No.	0200498
description	supply hose ID ø 13mm ED ø 20mm L 5m operating p. 20bar burst p. 60bar t.max. 95°C grey Qty 5m		

drain hoses



GEV No.	506214	Ref. No.	0200112
description	drain hose		

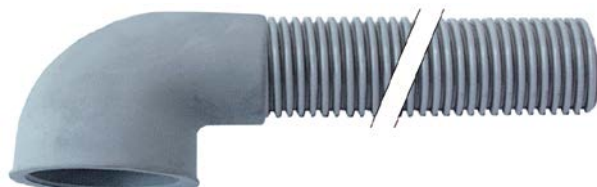

GEV No.	505082	Ref. No.	Z200910000
description	drain hose DN25 L 1500mm elbow ø inside 48mm elbow ext. ø 58mm outer hose ø 31mm		



GEV No.	518068	Ref. No.	143136
description	drain hose DN34 L 2000mm elbow ø inside 50mm elbow ext. ø 59mm inner hose ø 35mm outer hose ø 42mm PVC		



GEV No.	506060	Ref. No.	0200293
description	drain hose		

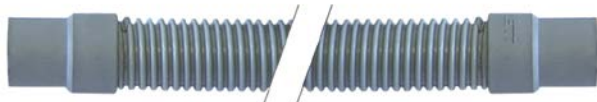

GEV No.	530616	Ref. No.	DZS151
description	drain hose L 1500mm A int. ø 25mm B int. ø 25mm outer hose ø 32mm		

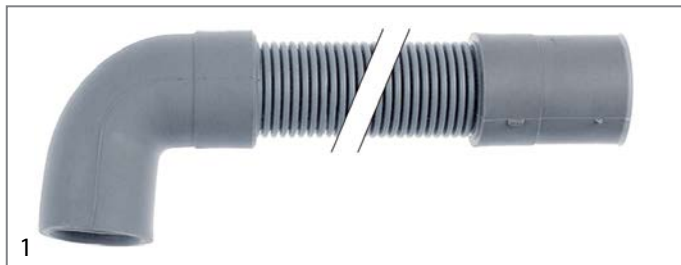

GEV No.	506207	Ref. No.	0900006
description	drain hose DN19 L 1500mm straight ø inside 19mm straight ext. ø 24mm elbow ø inside 21mm elbow ext. ø 27mm outer hose ø 25mm		

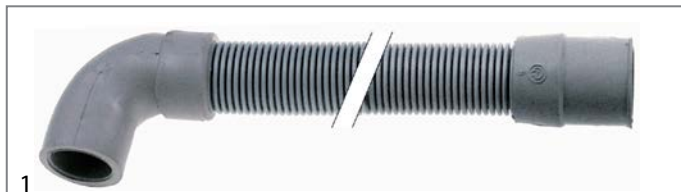

GEV No.	530819	Ref. No.	143137
description	drain hose DN20 L 2500mm straight ø inside 19mm straight ext. ø 24mm elbow ø inside 22mm elbow ext. ø 27mm outer hose ø 24mm		

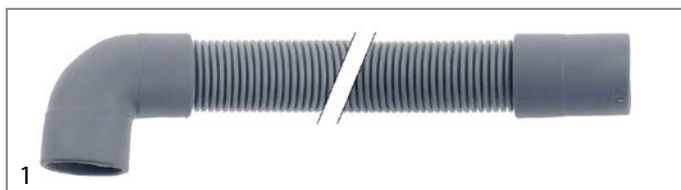

GEV No.	518638	Ref. No.	143252
description	drain hose DN24 L 1700mm straight ø inside 28mm straight ext. ø 34mm elbow ø inside 28mm elbow ext. ø 34mm outer hose ø 30mm		

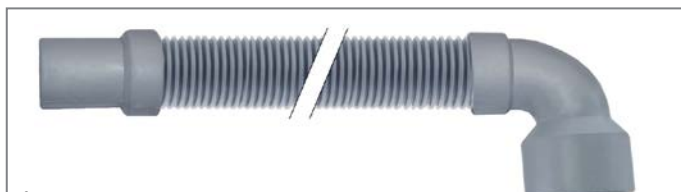

GEV No.	506208	Ref. No.	0900027
description	drain hose DN25 L 1500mm straight ø inside 25mm straight ext. ø 30mm elbow ø inside 40mm elbow ext. ø 46mm outer hose ø 32mm		

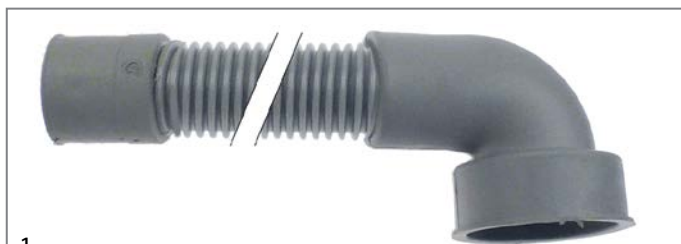

GEV No.	518654	Ref. No.	127056
description	drain hose DN34 L 600mm straight ø inside 30mm straight ext. ø 40mm elbow ø inside 51mm elbow ext. ø 61mm outer hose ø 34mm		
For models:	890509		

industrial hoses

Niplaflex hoses



GEV No.	530562	Ref. No.	143010
description	pressure hose ID ø 13mm ED ø 21mm L 5m operating p. 10bar burst p. 30bar t.max. 110°C		

pressure control hoses



GEV No.	530560	Ref. No.	143005 143131
description	pressure control hose ID ø 5mm ED ø 9mm L 5m operating p. 30bar burst p. 90bar temp.-resist. 60°C		



GEV No.	530068	Ref. No.	0200515
description	pressure hose ID ø 4mm ED ø 8.5mm L 1m operating p. 30bar burst p. 90bar temp.-resist. 60°C L 1000mm Qty 1m		

PVC hoses

PVC hoses without fabric

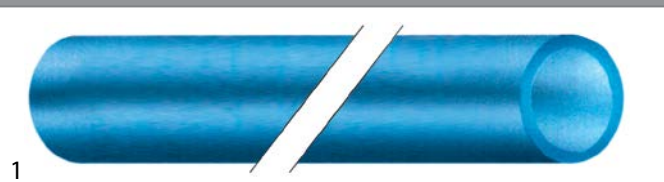



GEV No.	520383	Ref. No.	H.775601
description	PVC hose ID ø 4mm ED ø 6mm L 2m thickness 1mm t.max. 60°C blue		

accessories for	520383			
	GEV No.	361058	Ref. No.	—
	container filter with non-return valve SS hose ø 4x6mm ø 20mm L 56mm			
	GEV No.	361066	Ref. No.	—
	container filter straight SS hose ø 4x6mm L 37mm non return valve ball valve			
	GEV No.	361106	Ref. No.	—
	container filter with weight and non-return valve SS hose ø 4x6mm ø 21mm L 51mm non return valve lip valve			
	GEV No.	361141	Ref. No.	121075
	container filter with weight ceramic hose ø 4mm			

Table continues overleaf





accessories for	520383		
	GEV No.	361230	Ref. No. —
container filter with weight stainless steel hose ø 4x6mm			
	GEV No.	361462	Ref. No. —
container filter with weight SS hose ø 4x6mm			
	GEV No.	361728	Ref. No. —
container filter with 4m 4x6 hose SS hose ø 4x6mm hose length 4000mm			

	1		
GEV No.	520090	Ref. No.	0200091 143194
description	PVC hose ID ø 4mm ED ø 6mm L 2m thickness 1mm t.max. 60°C transparent		
accessories for	520090		
	GEV No.	361058	Ref. No. —
container filter with non-return valve SS hose ø 4x6mm ø 20mm L 56mm			
	GEV No.	361066	Ref. No. —
container filter straight SS hose ø 4x6mm L 37mm non return valve ball valve			
	GEV No.	361106	Ref. No. —
container filter with weight and non-return valve SS hose ø 4x6mm ø 21mm L 51mm non return valve lip valve			
	GEV No.	361141	Ref. No. 121075
container filter with weight ceramic hose ø 4mm			
	GEV No.	361230	Ref. No. —
container filter with weight stainless steel hose ø 4x6mm			
	GEV No.	361462	Ref. No. —
container filter with weight SS hose ø 4x6mm			
	GEV No.	361728	Ref. No. —
container filter with 4m 4x6 hose SS hose ø 4x6mm hose length 4000mm			

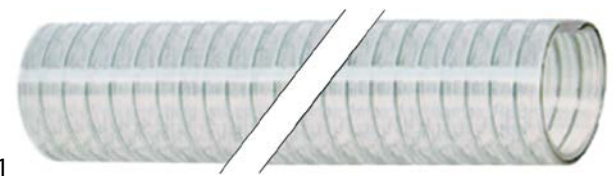
	1		
GEV No.	520027	Ref. No.	143013
description	PVC hose ID ø 4mm ED ø 7mm L 10m thickness 1.5mm t.max. 60°C transparent		

hoses wire reinforced			
	1		
GEV No.	506074	Ref. No.	0200521
description	drain hose ID ø 32mm ED ø 41mm L 1m wire reinforced		

silicone hoses			
without fabric			
	1		
GEV No.	520242	Ref. No.	143235
description	silicone hose for peristaltic pump ID ø 4mm ED ø 7mm L 5m thickness 1.5mm t.max. 200°C Shore A 55° transparent dosing Qty 5m		

	1		
GEV No.	520842	Ref. No.	143253
description	silicone hose ID ø 3mm ED ø 6mm L 1m thickness 1.5mm t.max. 200°C brown		

for peristaltic pumps			
	1		
GEV No.	520242	Ref. No.	143235
description	silicone hose for peristaltic pump ID ø 4mm ED ø 7mm L 5m thickness 1.5mm t.max. 200°C Shore A 55° transparent dosing Qty 5m		

formed hoses			
straight			
	1		
GEV No.	506218	Ref. No.	0201923
description	extraction hose		





1

GEV No.	506112	Ref. No.	0201914
description	formed hose dishwasher straight		



1

GEV No.	518380	Ref. No.	80189
description	formed hose ext. ø 53 ID ø 43mm L 65mm dishwasher straight mounting pos. upper equiv. no. 127036		



1

GEV No.	504160	Ref. No.	0201900
description	formed hose L 100mm dishwasher straight hose ext. ø 60mm equiv. no. 4085, 3927		



1

GEV No.	506036	Ref. No.	0200131
description	formed hose L 100mm dishwasher straight ø 30mm		



1

GEV No.	506113	Ref. No.	0201919
description	formed hose L 150mm dishwasher straight enlarged mounting pos. lower nominal-ø 60/43mm		



1

GEV No.	506423	Ref. No.	0201924
description	formed hose L 230mm dishwasher straight ø 40mm		

form L



1

GEV No.	513299	Ref. No.	127090
description	formed hose end piece A ext. ø 18mm end piece A int. ø 10mm AD2 ø 18mm ø end piece B 10mm L 435mm		



1

GEV No.	506107	Ref. No.	0201904
description	formed hose end piece A ext. ø 37mm AD2 ø 28mm warewashing L-shape equiv. no. 0201904		



1

GEV No.	506108	Ref. No.	0201905
description	formed hose end piece A ext. ø 38mm AD2 ø 29mm warewashing L-shape equiv. no. 0201905		



1

GEV No.	513305	Ref. No.	35603
description	formed hose end piece A ext. ø 51mm end piece A int. ø 44mm AD2 ø 42mm ø end piece B 33mm L 300mm		



1

GEV No.	513251	Ref. No.	80187
description	formed hose end piece A ext. ø 59mm end piece A int. ø 47mm AD2 ø 58mm ø end piece B 46mm warewashing L-shape equiv. no. 80187 mounting pos. upper		



1

GEV No.	503180	Ref. No.	41560
description	formed hose for drain pump warewashing		



1

GEV No.	503181	Ref. No.	127084
description	formed hose for drain pump warewashing		



1

GEV No.	513250	Ref. No.	80188
description	formed hose ID \varnothing 48mm ED \varnothing 60mm thickness 6mm L1 235mm L2 140mm L-shape		



1

GEV No.	513254	Ref. No.	80186
description	formed hose L 340mm warewashing L-shape equiv. no. 80186 ID \varnothing 60mm		



1

GEV No.	503176	Ref. No.	127098
description	formed hose warewashing		



1

GEV No.	506435	Ref. No.	0200124
description	formed hose warewashing L-shape		



1

GEV No.	513135	Ref. No.	926056
description	formed hose warewashing L-shape equiv. no. 926056, DZG461		



1

GEV No.	513075	Ref. No.	929164
description	formed hose warewashing L-shape equiv. no. DZG60, 929164		

form S



1

GEV No.	506217	Ref. No.	0201922
description	formed hose		



1

GEV No.	513300	Ref. No.	127093
description	formed hose ID \varnothing 30mm hose ext. \varnothing 35mm ED \varnothing 27mm hose int. \varnothing 21mm L 460mm		



1

GEV No.	506053	Ref. No.	0200232
description	formed hose S-shape warewashing equiv. no. 0200232		



			
1			
GEV No.	512449	Ref. No.	127092
description	formed hose warewashing		

form U

			
1			
GEV No.	513233	Ref. No.	127087
description	formed hose D1 ø 30mm D2 ø 30mm for drain pump rubber warewashing		

			
1			
GEV No.	698840	Ref. No.	44354
description	formed hose ext. ø 40.5 D1 ø 32.5mm D2 ø 42.5mm 1210 warewashing Qty 1		

			
1			
GEV No.	513314	Ref. No.	41554
description	formed hose ext. ø 52 D1 ø 46mm D2 ø 42mm L 1000mm		

miscellaneous

			
1			
GEV No.	513306	Ref. No.	127085
description	formed hose ext. ø 43 ID ø 34mm ED ø 23mm D1 ø 32mm L 140mm		

			
1			
GEV No.	698841	Ref. No.	69020
description	formed hose ext. ø 44.5 ID ø 34.5mm ED ø 53mm D1 ø 43mm		

			
1			
GEV No.	513307	Ref. No.	127082
description	formed hose ext. ø 47 ID ø 39mm ED ø 47mm D1 ø 39mm L 82mm		

			
1			
GEV No.	513169	Ref. No.	127091
description	formed hose warewashing		

			
1			
GEV No.	513239	Ref. No.	127099
description	formed hose warewashing		

for dishwashers

ventilation hoses

			
1			
GEV No.	506156	Ref. No.	0500600
description	ventilation hose warewashing		



miscellaneous



GEV No.	511642	Ref. No.	0200931
description	flex hose ET 1/2 IT 3/4 L 23mm SS ext. ø 18		



GEV No.	506431	Ref. No.	0200200
description	hose ED ø 10/15mm ID ø 4/10mm L 2200mm temp.-resist. 70°C for air trap		

fittings, hose and pipe connectors

fittings

double nipples



GEV No.	506013	Ref. No.	0200040
description	double nipple SS thread 1/4 - 3/8 Qty 1 pcs		

reducers



GEV No.	520879	Ref. No.	0200920
description	reducer thread 3/4 ET - 1/2 IT brass total length 17mm WS 26 Qty 1 pcs		



GEV No.	506083	Ref. No.	0200932
description	reducer thread 1 ET - 1/2 IT brass total length 22mm WS 34		

angle pieces



GEV No.	541675	Ref. No.	0200905
description	angle piece thread 1/2 ET - 1/2 IT brass		



GEV No.	540020	Ref. No.	0200910
description	angle piece thread 1/2 IT - 1/2 IT chrome-plated brass		



GEV No.	506041	Ref. No.	0200162
description	angle piece thread 3/8 polypropylene		

hose connectors

plastic



GEV No.	506122	Ref. No.	0221302
description	hose connector plastic straight thread 1/4 hose ø 31mm Qty 1 pcs		
accessories for	506122		



GEV No.	506072	Ref. No.	0200403
description	flat gasket fibre ED ø 38mm ID ø 27mm thickness 2mm outflow for thread 1/4 Qty 1 pcs		



GEV No.	506074	Ref. No.	0200521
description	drain hose ID ø 32mm ED ø 41mm L 1m wire reinforced		



GEV No.	506125	Ref. No.	0221310
description	hose connector plastic angled thread 3/8 hose ø 12mm Qty 1 pcs		
accessories for	506125		



GEV No.	506042	Ref. No.	0200171
description	flat gasket FIBER ED ø 27mm ID ø 17mm thickness 2mm Qty 1 pcs		

Table continues overleaf





accessories for	506125		
	GEV No.	506132	Ref. No. 0300047
	nut thread 3/8"		

nickel-plated brass			
	1		
GEV No.	520202	Ref. No.	927015
description	hose connector nickel-plated brass straight thread 3/8" hose ø 12mm Qty 1 pcs		

producer-specific			
	1		
GEV No.	506082	Ref. No.	0200906
description	hose connector angled brass ø 1/2"mm		

	1		
GEV No.	506052	Ref. No.	0200231
description	hose connector connection 3/4" hose ø 12mm		

	1		
GEV No.	506126	Ref. No.	0221313
description	hose connector curved plastic ø 3/4"mm		

	1		
GEV No.	506081	Ref. No.	0200903
description	hose connector straight ø 1/2"mm		

	1		
GEV No.	506415	Ref. No.	0221304
description	hose connector thread 2" for hose ø60mm		

	1		
GEV No.	505256	Ref. No.	0200646
description	hose connector thread M12 ø 13mm 1/2" ET		

	1		
GEV No.	506098	Ref. No.	0201804
description	T-piece		

valves and tank inlets

ball valves

universal

ball valves with lever handle

	1		
GEV No.	520280	Ref. No.	24500028100303 PBEM303
description	ball valve connection 1/2" IT - 1/2" IT DN15 total length 50mm with lever handle handle length 85mm		

	1		
GEV No.	520281	Ref. No.	SHGMVN0304A1
description	ball valve connection 3/4" IT - 3/4" IT DN20 total length 56mm with lever handle handle length 87mm		



drain systems and wash basins

U-bends



1

GEV No.	515113	Ref. No.	PDSF244
description	funnel ø 46mm plastic grey H 39mm L 71mm		



1

GEV No.	515111	Ref. No.	PRDS150
description	U-bend kit ø 18mm plastic grey		

spare parts for	515111		
------------------------	--------	--	--

	GEV No.	515112	Ref. No.	PDSP255
	description	U-bend tube ø 18mm plastic grey L 180mm		

	GEV No.	515113	Ref. No.	PDSF244
	description	funnel ø 46mm plastic grey H 39mm L 71mm		

	GEV No.	515114	Ref. No.	PDSP265
	description	U-bend tube ø 22.5mm plastic grey L 57mm		

	GEV No.	515115	Ref. No.	—
	description	drain connection ø 29mm plastic grey		



1

GEV No.	515112	Ref. No.	PDSP255
description	U-bend tube ø 18mm plastic grey L 180mm		



1

GEV No.	515114	Ref. No.	PDSP265
description	U-bend tube ø 22.5mm plastic grey L 57mm		

water cycle components

pressure reduction valves

pressure reduction valves

universal



1

GEV No.	520881	Ref. No.	0301151
description	pressure reduction valve DESBORDES series DN15 connection 1/2" default setting 3bar setting range 1-5.5bar EN1567 p max 25bar t.max. 80°C brass WRAS/ACS		



1

GEV No.	520868	Ref. No.	927150
description	pressure reduction valve OR series PN40 connection 1/2" setting range 1-7bar p max 40bar t.max. 80°C brass		

ancillary products

clamps

hose clamps

DIN 3017 - W2



1

GEV No.	520114	Ref. No.	Q881304000
description	hose clamp ø 20-32mm width 9mm Qty 10 pcs DIN 3017		

1

GEV No.	520115	Ref. No.	0200298
description	hose clamp ø 25-40mm width 9mm Qty 10 pcs DIN 3017		



1

GEV No.	520119	Ref. No.	0200248 0200713
description	hose clamp ø 60-80mm width 9mm Qty 5 pcs DIN 3017		



1

GEV No.	520117	Ref. No.	0200069 CFS1A
description	hose clamp stainless steel ø 40-60mm width 9mm Qty 5 pcs DIN 3017		

DIN 3017 - W4



1

GEV No.	520120	Ref. No.	0200190 0200300 927322
description	hose clamp SS W4 ø 12-20mm width 9mm Qty 1 pcs DIN 3017		

double wire clamps



1

GEV No.	560503	Ref. No.	CFF10073
description	hose clamp ø 8-10mm wire gauge ø 1mm Qty 1 pcs		

pipes

miscellaneous



1

GEV No.	691673	Ref. No.	R155010
description	drain pipe ø 38mm L 195mm		

tools

hand tools

wrenches

miscellaneous



1

GEV No.	801662	Ref. No.	0802792
description	adjusting spanner for clutch L 270mm		

measuring equipment

thermometers

built-in thermometers



1

GEV No.	541086	Ref. No.	0500005
description	thermometer mounting measurements 58x25.5mm 0 up to +120°C capillary pipe 2000mm probe ø 6mm probe L 23mm		

ø52mm



1

GEV No.	541065	Ref. No.	0500009
description	thermometer mounting ø 52mm t.max. 120°C 0 up to +120°C probe ø 6.5mm probe L 28mm capillary pipe 1500mm		

ø60mm



GEV No.	541900	Ref. No.	TERMOM001
description	thermometer mounting ø 60mm t.max. 500°C 0 up to +500°C probe ø 8mm probe L 145mm capillary pipe 450mm		

fastening material

screws

sheet metal screws



GEV No.	560108	Ref. No.	Q082005000
description	sheet metal screws ø 4.2mm L 13mm SS Qty 20 pcs DIN 7981/ISO 7049 head ø 8.2mm oval head		



GEV No.	560240	Ref. No.	0800001
description	sheet metal screws ø 3.9mm L 16mm SS Qty 20 pcs DIN 7982/ISO 7050 head ø 7.5mm sunk head		

hexagonal screws



GEV No.	560202	Ref. No.	8300610
description	hexagonal screw thread M10 thread L 25mm SS WS 17 Qty 1 pcs DIN 933 / ISO 4017		



GEV No.	506445	Ref. No.	0800228
description	hexagonal screw thread M10 thread L 35mm SS WS 17 Qty 1 pcs DIN 933 / ISO 4017		



GEV No.	560476	Ref. No.	0800661
description	hexagonal screw thread M10 thread L 40mm zinc-coated steel WS 17 Qty 1 pcs head thickness 6.4mm DIN 933 / ISO 4017		



GEV No.	560539	Ref. No.	0800667
description	hexagonal screw thread M10 thread L 42mm SS WS 17 Qty 1 pcs head thickness 6.5mm DIN 933 / ISO 4017		



GEV No.	560085	Ref. No.	0800648
description	hexagonal screw thread M5 thread L 20mm SS WS 8 Qty 20 pcs DIN 933 / ISO 4017		



GEV No.	560088	Ref. No.	0800062
description	hexagonal screw thread M6 thread L 20mm SS WS 10 Qty 20 pcs DIN 933 / ISO 4017		



GEV No.	506447	Ref. No.	0800009
description	hexagonal screw thread M8 thread L 16mm SS WS 13 Qty 1 pcs DIN 933 / ISO 4017		



GEV No.	560204	Ref. No.	8300380
description	hexagonal screw thread M8 thread L 25mm SS WS 13 Qty 1 pcs DIN 933 / ISO 4017		





GEV No.	560205	Ref. No.	8300290
description	hexagonal screw thread M8 thread L 30mm SS WS 13 Qty 1 pcs DIN 933 / ISO 4017		





			
1			
GEV No.	506446	Ref. No.	0800016 8301740
description	hexagonal screw thread M8 thread L 40mm SS WS 13 Qty 1 pcs DIN 933 / ISO 4017		

			
1			
GEV No.	696413	Ref. No.	GN650TN.01
description	screw thread M6 L 18mm		

cylinder head bolts DIN 912/ISO 4762			
			
1			
GEV No.	560225	Ref. No.	8301260
description	cylinder head bolt thread M4 L 30mm thread L 20mm WS 3 intake hexagonal SS Qty 1 pcs head ø 7mm head thickness 4mm DIN 912/ ISO 4762		

side bolts			
			
1			
GEV No.	560551	Ref. No.	615
description	side bolts thread M10 L 15mm SS Qty 1 pcs intake slotted head ø 24.5mm		

grub screws DIN 914/ISO 4027			
			
1			
GEV No.	560175	Ref. No.	0800682
description	grub screw thread M8 L 16mm DIN 914/ISO 4027 intake internal hexagon WS 4 Qty 1 pcs		

DIN 916/ISO 4029			
			
1			
GEV No.	560207	Ref. No.	8300280
description	grub screw thread M8 L 10mm steel DIN 916/ISO 4029 intake internal hexagon WS 4 Qty 1 pcs		

knurled screws			
			
1			
GEV No.	697481	Ref. No.	623
description	Thumb screw thread M6 thread L 8mm ø 14mm H 6mm SS		

			
1			
GEV No.	506172	Ref. No.	0800130
description	Thumb screw thread M6 thread L 9mm ø 22mm H 6mm SS		

nuts hexagonal nuts DIN 934 / ISO 4032/8673			
			
1			
GEV No.	560199	Ref. No.	0800082
description	hexagonal nut thread M10 H 8mm WS 17 SS DIN/ISO DIN 934 / ISO 4032/8673 Qty 10 pcs		

			
1			
GEV No.	560129	Ref. No.	0800257
description	hexagonal nut thread M5 H 4mm WS 8 SS DIN/ISO DIN 934 / ISO 4032/8673 Qty 1 pcs		

			
1			
GEV No.	560133	Ref. No.	0800063 0800656
description	hexagonal nut thread M6 H 5mm WS 10 SS DIN/ISO DIN 934 / ISO 4032/8673 Qty 20 pcs		

			
1			
GEV No.	560197	Ref. No.	0800106
description	nut thread M10 H 8mm WS 17 SS DIN/ISO DIN 934 / ISO 4032/8673 Qty 1 pcs		

			
1			
GEV No.	506166	Ref. No.	0800091
description	nut thread M12 H 10mm WS 19 SS DIN/ISO DIN 934 / ISO 4032/8673 Qty 1 pcs		

DIN 985

			
1			
GEV No.	560227	Ref. No.	0800652
description	hexagonal nut thread M3 H 4mm SS WS 5.5 Qty 1 pcs self-locking		

			
1			
GEV No.	560141	Ref. No.	0800653
description	hexagonal nut thread M5 H 5.4mm SS WS 8 Qty 20 pcs DIN/ISO DIN 985 self-locking		

			
1			
GEV No.	560142	Ref. No.	0800669
description	hexagonal nut thread M6 H 6mm SS WS 10 Qty 20 pcs DIN/ISO DIN 985 self-locking		

			
1			
GEV No.	560143	Ref. No.	0800093 0800657
description	hexagonal nut thread M8 H 8.5mm SS WS 13 Qty 20 pcs DIN/ISO DIN 985 self-locking		

DIN 982 (self-locking, tall version)

			
1			
GEV No.	560475	Ref. No.	0800144
description	hexagonal nut thread M10 H 11.5mm zinc-coated steel WS 17 Qty 1 pcs DIN/ISO DIN 982		

hexagonal nuts metric (without norm)

			
1	Image not available		
GEV No.	506162	Ref. No.	0800045
description	nut		

			
1			
GEV No.	521131	Ref. No.	0800205
description	nut thread M12x1 H 3.5mm WS 17 SS Qty 1 pcs		

			
1			
GEV No.	550261	Ref. No.	X163012000
description	nut thread M14x1 H 4mm WS 19 SS Qty 1 pcs		

hexagonal nuts inch thread

			
1			
GEV No.	506194	Ref. No.	0800655
description	nut thread 1/2" H 3mm nickel-plated brass WS 24 Qty 1 pcs		

			
1			
GEV No.	521102	Ref. No.	Q221401
description	nut thread 1/2" H 8mm SS WS 32 Qty 1 pcs		

			
1			
GEV No.	506024	Ref. No.	0200101
description	nut thread 3/8" H 6mm SS WS 22 Qty 1 pcs		

union nuts

			
1			
GEV No.	506196	Ref. No.	0800673
description	nut brass		



washers

spring rings

			
1			
GEV No.	560209	Ref. No.	8300620
description	lock washer ID ø 10.3mm ED ø 17.2mm SS Qty 1 pcs for thread M10		

			
1			
GEV No.	560123	Ref. No.	0800066
description	lock washer ID ø 6.3mm ED ø 11mm SS DIN127 Qty 20 pcs for thread M6		

			
1			
GEV No.	560208	Ref. No.	8300390
description	lock washer ID ø 8.3mm ED ø 15mm SS Qty 1 pcs		

spring washers

			
1			
GEV No.	697478	Ref. No.	671
description	spring washer ID ø 19mm ED ø 26mm Qty 1 pcs		

washers

DIN 125A

			
1			
GEV No.	560112	Ref. No.	0800256
description	plain washer ID ø 5.3mm ED ø 10mm thickness 1mm SS Qty 20 pcs DIN 125A for thread M5		

			
1			
GEV No.	560113	Ref. No.	0800004
description	plain washer ID ø 6.4mm ED ø 12mm thickness 1.6mm SS Qty 20 pcs DIN 125A for thread M6		

DIN 9021

			
1			
GEV No.	560210	Ref. No.	8300630
description	plain washer ID ø 11mm ED ø 30mm thickness 2mm SS Qty 1 pcs DIN 9021 for thread M10		

			
1			
GEV No.	528761	Ref. No.	0800064
description	plain washer ID ø 6.5mm ED ø 18mm thickness 1.5mm SS Qty 1 pcs		

miscellaneous

			
1			
GEV No.	506160	Ref. No.	0800028
description	plain washer ID ø 8.6mm ED ø 16mm thickness 1.5mm SS Qty 1 pcs		

			
1			
GEV No.	560214	Ref. No.	8300400
description	washer ID ø 8.5mm ED ø 31.5mm thickness 1mm SS Qty 1 pcs		

tooth lock washers

DIN 6798A

			
1			
GEV No.	560125	Ref. No.	0800101
description	tooth lock washer ID ø 4.2mm ED ø 8mm SS DIN/ISO DIN 6798A Qty 20 pcs for thread M4		

fasteners

slot nuts

			
1			
GEV No.	560287	Ref. No.	8301530
description	slot nut W 6mm H 6mm L 20mm		

			
1			
GEV No.	560268	Ref. No.	8300650
description	slot nut W 8mm H 7mm L 35mm		

clamps

hose clamps

DIN 3017 - W2



1

GEV No.	520114	Ref. No.	Q881304000
description	hose clamp ø 20-32mm width 9mm Qty 10 pcs DIN 3017		



1

GEV No.	520115	Ref. No.	0200298
description	hose clamp ø 25-40mm width 9mm Qty 10 pcs DIN 3017		



1

GEV No.	520119	Ref. No.	0200248 0200713
description	hose clamp ø 60-80mm width 9mm Qty 5 pcs DIN 3017		



1

GEV No.	520117	Ref. No.	0200069 CFS1A
description	hose clamp stainless steel ø 40-60mm width 9mm Qty 5 pcs DIN 3017		

DIN 3017 - W4



1

GEV No.	520120	Ref. No.	0200190 0200300 927322
description	hose clamp SS W4 ø 12-20mm width 9mm Qty 1 pcs DIN 3017		

double wire clamps



1

GEV No.	560503	Ref. No.	CFF10073
description	hose clamp ø 8-10mm wire gauge ø 1mm Qty 1 pcs		

cable clamps



1

GEV No.	524789	Ref. No.	0800492
description	cable clamp wire gauge ø 5mm SS		

retainer clips



1

GEV No.	694304	Ref. No.	PSPIN226
description	retainer clip L 16.5mm wire gauge ø 1mm SS Qty 2 pcs		

retaining rings

DIN 471



1

GEV No.	519248	Ref. No.	5203100
description	retaining ring shaft ø 10mm thickness 1mm SS DIN 471		



1

GEV No.	528689	Ref. No.	5203200
description	retaining ring shaft ø 15mm thickness 1mm steel DIN 471		

roll pins



1

GEV No.	692236	Ref. No.	A0GH81316
description	roll pin ø 4mm L 40mm		



screw caps

 <p>1</p>			
GEV No.	505257	Ref. No.	0802080
description	screw thread 1/8" with gasket thread L 15mm V2A WS 13 head thickness 4mm		

consumables

fuses

fine fuses

 <p>1</p>			
GEV No.	358677	Ref. No.	228004 228010
description	fine fuse size ø5x20mm 4A fast-acting rated 250V Qty 10 pcs		

 <p>1</p>			
GEV No.	358594	Ref. No.	228012
description	fine fuse size ø5x20mm 0.16A slow-acting rated 250V Qty 10 pcs		

 <p>1</p>			
GEV No.	358603	Ref. No.	228011
description	fine fuse size ø5x20mm 2A slow-acting rated 250V Qty 10 pcs		

fine fuse holders

 <p>1</p>			
GEV No.	550519	Ref. No.	H.228048
description	cover plate suitable fuseA ratedV connection for fuse holder		

A		F	
alarm devices	33	fans	48
audible timers	33	fasteners	147
axial fans	48	fastening material	144
B		filter driers	122
ball valves	141	filters	59
ballasts	29	fine fuses	149
bar burners	67	fittings	140
bi-metal thermostats	12, 13	fluorescent lamps	29, 29
booster pumps I	57	formed hoses	136
booster pumps II	58	fuses	59, 149
C		G	
cable clamps	148	gas burners	67
cables	60	gas control valves	65
cam switches	22	gas lines	69
capillary pipes	123	gas nozzles	69
castors and bumper angles	112	gas taps	62
clamps	142, 148	gas thermostats	63
compressors	47	gaskets for heated units	116
condensators & interference suppression filters	58	gaskets for wash arm support	122
consumables	149	gastronorm	130
contactors	33	grates	113
container filters	133	group 1	123
control equipment	25	grub screws	145
control thermostats	13, 16	H	
copper pipes uninsulated	123	halogen lamp	29
cylinder head bolts	145	hand tools	143
D		heating cables	7
DIN rails	62	heating elements	3
door seals	116	heating elements for bain maries	3
door seals for dishwashers	120	heating elements for contact grills	5
door seals with fixing hook	116	heating elements for convection	10
dosing hoses	133	heating elements for defrosting	5
dosing pumps	131	heating elements for fryers	3
double nipples	140	heating elements for heated cabinets	7
double wire clamps	143, 148	heating elements for heating bridges	7
drain hoses	134	heating elements for ovens	3
drain pumps	58	heating elements for pizza ovens	6
drain systems and wash basins	142	heating elements for pizza presses	6
E		heating elements for refrigeration	5
electric accessories	60	heating elements for salamanders/toasters	6
electrodes	47	heating elements for tilting bratt pan	5
electronic controllers	37	heating plates	7
energy regulators	12	hexagonal nuts	145
evaporation trays heated	48	hexagonal screws	144
evaporators	124	hob burners	67
		hose clamps	142, 148
		hose connectors	140
		hoses	134
		hoses wire reinforced	136

hot air fans	51	PVC supply hoses	134
hot air motors	51		
hot plates	11		
		Q	
I		quartz heating elements	7
ignition cables	66		
ignition units	66	R	
immersion heating elements	7	radiation heaters	11
indicator lights	26	reducers	140
indicator lights (complete)	27	refrigeration cycle components	122
industrial hoses	135	refrigeration fans	49
		refrigeration gaskets	114
K		refrigeration motors universal	49
knurled screws	145	refrigeration pipes	123
		relays	35
L		retainer clips	148
lamps	26	retaining rings	148
light bulbs	28	ribbon cables	61
linear lamps	29	ring burners	68
		rocker/momentary rocker switches	18
M		roll pins	148
magnetic switches	24	rotary switches	23
measuring equipment	143		
mechanical timers	32	S	
microswitches	21	safety bi-metal thermostats	12
motors	52	safety thermostats	16, 17, 17
		screw caps	149
N		screws	144
Niplaflex hoses	135	sealing washers	118
nuts	145	shaft gaskets	120
		sheet metal screws	144
O		shelves and shelf rails	113
operating capacitors	58	side bolts	145
O-rings	116	silicone hoses	133, 136
oven hinges	107	slot nuts	147
oven lamps	29	solenoid valves	43
		solid state relays	35
P		speed controllers	52
pilot burners	66	spiral cables	60
plug-in gaskets	114	spray guns	131
plunger sockets	18	spring assisted hinges	106
power supply cables	60	spring clips	18
pressure control hoses	135	spring rings	147
pressure reduction valves	142, 142	spring washers	147
pressure switches	46	starter	29
probe clips	18	supply hoses	134
probes	40	switches and momentary switches	18
programme timers	30	system switches (ROLD)	21
protection hoses	60		
pump hoses	133	T	
pumps	53	tank inlets	134
push/momentary push switches	19	temperature probes	40
PVC hoses	135	terminal boxes	62
		terminals	61

thermocouples	67
thermostats	12
timers	30
toggle switches	20
tools	143
tooth lock washers	147
transformers	36
tube burners	68

U

U-bends	142
union nuts	146
universal probes	40

V

valves and tank inlets	141
ventilation hoses	139

W

wash and rinse pumps	53
washers	147
water cycle components	142
wrenches	143