



**GAS COMPONENTS**



**ELECTRIC COMPONENTS**



**WATER TECHNOLOGY**



**MECHANICAL COMPONENTS**



**TOOLS**

Spare parts suitable for

**ALLPAX**

Find the complete and up-to-date range of products in our GEV Webshop



# Manufacturer catalogue

The most important spare parts and accessories arranged clearly for every manufacturer

- ✓ Complete product range and all appliance data always up to date in the GEV Webshop
- ✓ Alphabetical Index at the end of the catalogue

## GEV Webshop

[www.gev-online.co.uk](http://www.gev-online.co.uk)

[www.gev-online.com](http://www.gev-online.com)



- 🔍 Add to Favourites
- 🔍 Sign In with email address and usual password
- 🔍 Easy-order – place several items in your basket at the same time
- 🔍 Quick Item search – no login needed



## switches and momentary switches

### rocker/momentary rocker switches

28x13.5mm



1

<b>GEV No.</b>	347039	<b>Ref. No.</b>	0220010
<b>description</b>	rocker switch mounting measurements 27.4x12.4mm black/orange 2NO 250V 16A illuminated O connection male faston 6.3mm ambient temperature max. 100/55°C protection IP40		

### microswitches

#### lever actuated



1

<b>GEV No.</b>	347034	<b>Ref. No.</b>	0900465
<b>description</b>	microswitch with lever 30V 1A 1NO connection with cable L 18mm ambient temperature max. 85°C type D2FW-G 271M actuating force: 100g lever length 25mm		

### rotary switches

#### producer-specific rotary switches

#### DIHR / KROMO



1

<b>GEV No.</b>	345896	<b>Ref. No.</b>	0065736 0065788
<b>description</b>	O-ring EPDM thickness 1.5mm ID ø 37mm Qty 1 pcs		

### miscellaneous



1

<b>GEV No.</b>	347040	<b>Ref. No.</b>	0220060
<b>description</b>	rotary switch sets of contacts 3 2 0-1 momentary type 400V 32A shaft ø 5x5mm shaft Lmm connection screw		

### accessories

#### levers



1

<b>GEV No.</b>	347041	<b>Ref. No.</b>	0220065
<b>description</b>	knob 2 0-1 typeVA shaft ømm shaft Lmm connection for rotary switch		

## control equipment

### miscellaneous



1

<b>GEV No.</b>	347037	<b>Ref. No.</b>	0220005
<b>description</b>	push switch mounting measurements ø22mm black 2NO 10A		

## contactors

### LOVATO

#### power contactors



1

<b>GEV No.</b>	381102	<b>Ref. No.</b>	0221005
<b>description</b>	power contactor resistive load 20A 24VAC (AC3/400V) 9A/4kW main contacts 4NO auxiliary contacts connection screw connection type 11BG09T4A24		



1

<b>GEV No.</b>	381103	<b>Ref. No.</b>	0221106
<b>description</b>	power contactor resistive load 25A 24VAC (AC3/400V) 9A/4.2kW main contacts 4NO auxiliary contacts connection screw connection type BF09T4A024		



## transformers

### open transformers

#### with clamp terminal



1

<b>GEV No.</b>	402081	<b>Ref. No.</b>	0223032
<b>description</b>	transformer primary 220/380VAC secondary 0-21.4VAC 900VA connection screw connection 50/60Hz		

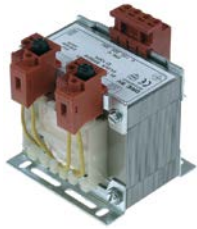

1

<b>GEV No.</b>	402086	<b>Ref. No.</b>	0223011
<b>description</b>	transformer primary 230/400VAC secondary 0-9/0-24VAC 64.5VA connection screw 50/60Hz		

### encapsulated transformers

#### multiple connections



1

<b>GEV No.</b>	402085	<b>Ref. No.</b>	0223004
<b>description</b>	transformer primary 230VAC secondary 24VAC 30VA secondary 1.25A connection male faston 6.3mm 50/60Hz type 65.16.230.323.224.05		

## electronics

### PCBs



1

<b>GEV No.</b>	402093	<b>Ref. No.</b>	0230040
<b>description</b>	PCB vacuum packing machine B35 / B-M 42/42XL H_HD4		
<b>spare parts for</b>	402093		
<b>GEV No.</b>	358596	<b>Ref. No.</b>	—
	fine fuse size ø5x20mm 0.25A slow-acting rated 250V Qty 10 pcs		



1

<b>GEV No.</b>	402095	<b>Ref. No.</b>	0230042
<b>description</b>	PCB vacuum packing machine B35 / B-M 42/42XL H_HD4 with sensor		



1

<b>GEV No.</b>	402092	<b>Ref. No.</b>	0230036
<b>description</b>	PCB vacuum packing machine JUMBO		

## keypads

### membrane keypads



1

<b>GEV No.</b>	402098	<b>Ref. No.</b>	0900102
<b>description</b>	membrane keypad vacuum packing machine B35-16 with frame		



1

<b>GEV No.</b>	402096	<b>Ref. No.</b>	0900100
<b>description</b>	membrane keypad with frame		

### control panel



1

<b>GEV No.</b>	692068	<b>Ref. No.</b>	0600020
<b>description</b>	switch panel vacuum packing machine JUMBO Combivac L 258mm W 55mm thickness 2.3mm		



			
1			
<b>GEV No.</b>	692069	<b>Ref. No.</b>	0600011
<b>description</b>	switch panel vacuum packing machine JUMBO L 288mm L 88mm thickness 20mm digital		

## solenoid valves

### solenoid valves (water)

metal

ASCO

2-way

			
1			
<b>GEV No.</b>	370509	<b>Ref. No.</b>	0280042
<b>description</b>	solenoid valve 2-ways 24VAC inlet 1/2" outlet 1/2" connection 1/2" L 52mm DN 12.5mm slide-on receptacle DIN -20° up to 85°C membranes NBR (water) p max 7bar 1/2" brass		

### Solenoid valve - accessories

			
1			
<b>GEV No.</b>	370516	<b>Ref. No.</b>	0280072
<b>description</b>	nut thread M8x0.75 for solenoid coil		

			
1			
<b>GEV No.</b>	370515	<b>Ref. No.</b>	0280071
<b>description</b>	solenoid coil 24V voltage AC seat ø 9mm		

			
1			
<b>GEV No.</b>	370508	<b>Ref. No.</b>	0280024
<b>description</b>	solenoid coil 3-way 24V 6mm		

			
1			
<b>GEV No.</b>	370517	<b>Ref. No.</b>	0280075
<b>description</b>	solenoid valve body nominal dimension 2.8mm		

			
1			
<b>GEV No.</b>	370519	<b>Ref. No.</b>	0280080
<b>description</b>	solenoid valve body nominal dimension 2.8mm		

			
1			
<b>GEV No.</b>	370518	<b>Ref. No.</b>	0280078
<b>description</b>	solenoid valve body nominal dimension 6mm		

### solenoid valves for vacuum machines

			
1			
<b>GEV No.</b>	370520	<b>Ref. No.</b>	0900858
<b>description</b>	solenoid valve 2-way 24VACV inlet 1/4" outlet ø4 vacuum packing machine		

			
1			
<b>GEV No.</b>	370507	<b>Ref. No.</b>	0280021
<b>description</b>	solenoid valve 2-ways 24VAC inlet 1/8" outlet 1/8" mm L 31mm DN 3.3mm 1/8" brass		





			
1			
<b>GEV No.</b>	370506	<b>Ref. No.</b>	0280010
<b>description</b>	solenoid valve 3-ways 24VAC inlet 1/8" outlet 1/8"mm L 35mm body inner cone DN 2.8mm 1/8" 24V brass		

			
1			
<b>GEV No.</b>	370787	<b>Ref. No.</b>	0280039
<b>description</b>	solenoid valve assembly 24VAC inlet 1/2" outlet 7.5mm 2 coils coil type VA12 thread 1/2" MJ		

			
1			
<b>GEV No.</b>	370513	<b>Ref. No.</b>	0280027
<b>description</b>	solenoid valve assembly 24VAC inlet 1/2" outlet 10.5mm 2 coils coil type VA12 thread 1/2" JP		

			
1			
<b>GEV No.</b>	370505	<b>Ref. No.</b>	0900836
<b>description</b>	solenoid valve assembly 3 coils 24V thread 1/2" hose ø 21mm coil type VA12 B42(XL)+SA		

			
1			
<b>GEV No.</b>	370800	<b>Ref. No.</b>	0280035
<b>description</b>	solenoid valve assembly 24VAC inlet 1/2" outlet 10.5mm 2 coils coil type VA12 thread 1/2" JP		

			
1			
<b>GEV No.</b>	370501	<b>Ref. No.</b>	0900831
<b>description</b>	solenoid valve assembly thread 1/2" hose ø 10mm 24V coil type VA12 JP		

			
1			
<b>GEV No.</b>	370816	<b>Ref. No.</b>	0280026
<b>description</b>	solenoid valve assembly 24VAC inlet 1/2" outlet 21mm 2 coils coil type VA12 24V thread 1/2" hose ø 21mm J35/J42/B35		

			
1			
<b>GEV No.</b>	370502	<b>Ref. No.</b>	0900832
<b>description</b>	solenoid valve assembly thread 1/2" hose ø 21mm 24V coil type VA12 J35		

			
1			
<b>GEV No.</b>	370511	<b>Ref. No.</b>	0280025
<b>description</b>	solenoid valve assembly 24VAC inlet 1/2" outlet 7.5mm 2 coils coil type VA12 thread 1/2" MJ		

			
1			
<b>GEV No.</b>	370503	<b>Ref. No.</b>	0900833
<b>description</b>	solenoid valve assembly thread 1/2" hose ø 21mm 24V coil type VA12 J42		





			
1			
<b>GEV No.</b>	692064	<b>Ref. No.</b>	0280032
<b>description</b>	solenoid valve assembly thread 1/2" hose ø 6mm 24V H200		

			
1			
<b>GEV No.</b>	370500	<b>Ref. No.</b>	0900830
<b>description</b>	solenoid valve assembly thread 1/2" hose ø 7.5mm 24V coil type VA12 MJ		

## pumps

### vacuum pumps

vacuum pumps			
			
1			
<b>GEV No.</b>	500987	<b>Ref. No.</b>	0430130
<b>description</b>	vacuum pump 4m <sup>3</sup> /h 230V 0.1kW 50Hz type PB 0004 B 000		
<b>spare parts for</b>	500987		
	<b>GEV No.</b>	500988	<b>Ref. No.</b>
			—
	level glass thread 1/2" plastic		

			
1			
<b>GEV No.</b>	499006	<b>Ref. No.</b>	0431300
<b>description</b>	vacuum pump 8m <sup>3</sup> /h 220/240V 0.35kW 50/60Hz type PB0008		

rotor vanes			
			
1			
<b>GEV No.</b>	691585	<b>Ref. No.</b>	0939065
<b>description</b>	rotor vane L 100mm W 40mm H 4mm		

			
1			
<b>GEV No.</b>	692070	<b>Ref. No.</b>	0939054
<b>description</b>	rotor vane L 28mm W 14mm H 3mm		

			
1			
<b>GEV No.</b>	691584	<b>Ref. No.</b>	0939060
<b>description</b>	rotor vane L 70mm W 18mm H 4mm		

level glasses			
			
1			
<b>GEV No.</b>	691561	<b>Ref. No.</b>	0438000
<b>description</b>	level glass thread 1/2"		

			
1			
<b>GEV No.</b>	691562	<b>Ref. No.</b>	0438005
<b>description</b>	level glass thread 3/4"		

## equipment-specific units

### for vacuum packers

air valves			
			
1			
<b>GEV No.</b>	691551	<b>Ref. No.</b>	0281005
<b>description</b>	air valve connection 1" 24VAC		



1

<b>GEV No.</b>	691555	<b>Ref. No.</b>	0900852
<b>description</b>	air valve connection 1¼"		

**lids**



1

<b>GEV No.</b>	692062	<b>Ref. No.</b>	0620010 0620011
<b>description</b>	lid with gasket L 475mm W 460mm H 75mm B42/J42/H-200		

**air cylinders**

**air cylinders**



1

<b>GEV No.</b>	691547	<b>Ref. No.</b>	0286015
<b>description</b>	air cylinder ø 110mm H 47mm shaft length 29mm		



1

<b>GEV No.</b>	691548	<b>Ref. No.</b>	N/A
<b>description</b>	air cylinder ø 110mm H 47mm shaft length 29mm		



1

<b>GEV No.</b>	691544	<b>Ref. No.</b>	0286000
<b>description</b>	air cylinder ø 50mm H 25mm		



1

<b>GEV No.</b>	691545	<b>Ref. No.</b>	0286005
<b>description</b>	air cylinder ø 80mm H 30mm		



1

<b>GEV No.</b>	691546	<b>Ref. No.</b>	0286010
<b>description</b>	air cylinder ø 80mm H 48mm		
<b>spare parts for</b>	691546		



<b>GEV No.</b>	691581	<b>Ref. No.</b>	0931405
<b>description</b>	membrane ø 80mm H 24mm		

**insert plates**



1

<b>GEV No.</b>	692063	<b>Ref. No.</b>	0307050
<b>description</b>	insert plate L 740mm W 490mm thickness 20mm F80 KL		





oil separator filters

with thread

1 

<b>GEV No.</b>	691534	<b>Ref. No.</b>	0939000 0939160
<b>description</b>	oil separator filter flow rate 4m <sup>3</sup> /h ø 35mm L 52mm thread 3/8"		

1 

<b>GEV No.</b>	691536	<b>Ref. No.</b>	0939001 0939161
<b>description</b>	oil separator filter flow rate 8m <sup>3</sup> /h ø 40mm L 70mm thread 1/2"		

without thread

1 

<b>GEV No.</b>	691540	<b>Ref. No.</b>	0939010 0939170
<b>description</b>	oil separator filter flow rate 100m <sup>3</sup> /h ø 72mm L 248mm		

1 

<b>GEV No.</b>	691537	<b>Ref. No.</b>	0939003 0939163
<b>description</b>	oil separator filter flow rate 16m <sup>3</sup> /h ø 52mm L 120mm		

1 

<b>GEV No.</b>	691538	<b>Ref. No.</b>	0939005 0939165
<b>description</b>	oil separator filter flow rate 21m <sup>3</sup> /h ø 72mm L 128mm		

1 

<b>GEV No.</b>	691539	<b>Ref. No.</b>	0939011 0939171
<b>description</b>	oil separator filter flow rate 63m <sup>3</sup> /h ø 72mm L 206mm		

membranes

1 

<b>GEV No.</b>	691582	<b>Ref. No.</b>	0931410
<b>description</b>	membrane ø 110mm H 34mm		

1 

<b>GEV No.</b>	691579	<b>Ref. No.</b>	0931226
<b>description</b>	membrane ø 48mm H 5mm		

1 

<b>GEV No.</b>	691580	<b>Ref. No.</b>	0931400
<b>description</b>	membrane ø 50mm H 19mm		

1 

<b>GEV No.</b>	691581	<b>Ref. No.</b>	0931405
<b>description</b>	membrane ø 80mm H 24mm		

oils

1 

<b>GEV No.</b>	890296	<b>Ref. No.</b>	0439510
<b>description</b>	oil type V32 1l for vacuum packing machine		



1

<b>GEV No.</b>	890253	<b>Ref. No.</b>	0439520
<b>description</b>	oil type VM100 1l for vacuum packing machine		



1

<b>GEV No.</b>	890247	<b>Ref. No.</b>	0439500
<b>description</b>	oil type VM22 0.05l for vacuum packing machine		



1

<b>GEV No.</b>	890248	<b>Ref. No.</b>	0439501
<b>description</b>	oil type VM22 1l for vacuum packing machine		



1

<b>GEV No.</b>	890200	<b>Ref. No.</b>	0439502
<b>description</b>	oil type VM32 0.25l for vacuum packing machine		



1

<b>GEV No.</b>	890250	<b>Ref. No.</b>	0439503
<b>description</b>	oil type VM32 0.3l for vacuum packing machine		



1

<b>GEV No.</b>	890251	<b>Ref. No.</b>	0439505
<b>description</b>	oil type VM32 0.5l for vacuum packing machine		

1

<b>GEV No.</b>	890252	<b>Ref. No.</b>	0439510 old version
<b>description</b>	oil type VM32 1l for vacuum packing machine		

### oil filter



1

<b>GEV No.</b>	691542	<b>Ref. No.</b>	0939090
<b>description</b>	oil filter size 63-100 ø 78mm L 78mm		

### PTFE tapes



1

<b>GEV No.</b>	691526	<b>Ref. No.</b>	0305505
<b>description</b>	PTFE tape W 15mm thickness 0.25mm Qty supplied by meter		



1

<b>GEV No.</b>	693842	<b>Ref. No.</b>	0305515
<b>description</b>	PTFE tape W 46mm thickness 0.1mm Qty supplied by meter		

### sealing bars



1

<b>GEV No.</b>	691632	<b>Ref. No.</b>	0300010 0300011
<b>description</b>	sealing bar L 277mm W 15mm H 31mm		



1

<b>GEV No.</b>	691997	<b>Ref. No.</b>	0300041
<b>description</b>	sealing bar L 280mm W 16mm H 34mm double		



1

<b>GEV No.</b>	692469	<b>Ref. No.</b>	0300116
<b>description</b>	sealing bar L 355mm W 15mm H 31mm double welding		



1

<b>GEV No.</b>	691998	<b>Ref. No.</b>	0300215
<b>description</b>	sealing bar L 425mm W 16mm H 34mm cut-off seal		



1

<b>GEV No.</b>	691816	<b>Ref. No.</b>	0300337
<b>description</b>	sealing bar L 500mm W 16mm H 34mm double		



1

<b>GEV No.</b>	692468	<b>Ref. No.</b>	0300320
<b>description</b>	sealing bar L 520mm W 15.5mm H 31mm		



1

<b>GEV No.</b>	691999	<b>Ref. No.</b>	0300332
<b>description</b>	sealing bar L 525mm W 16mm H 35mm double		

heating wires

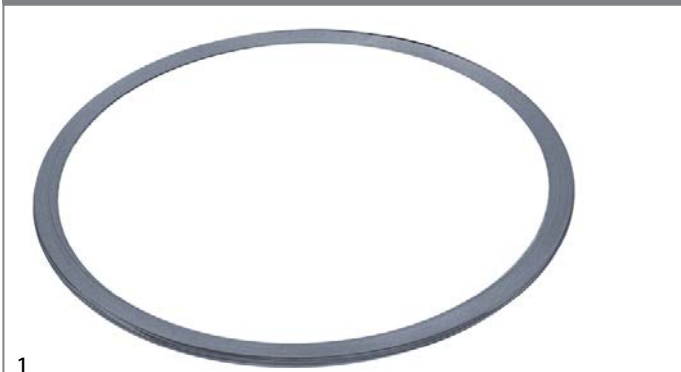

1

<b>GEV No.</b>	572020	<b>Ref. No.</b>	0305000 (3 meters)
<b>description</b>	heating wire W 3.5mm thickness 0.3mm Qty 3m		

service kits



1

<b>GEV No.</b>	890254	<b>Ref. No.</b>	0940100
<b>description</b>	service kit container capacity 0.05l for vacuum packing machine type MJ		



1

<b>GEV No.</b>	890255	<b>Ref. No.</b>	0940110
<b>description</b>	service kit container capacity 0.2l for vacuum packing machine type JP		



1

<b>GEV No.</b>	890262	<b>Ref. No.</b>	0940120
<b>description</b>	service kit for vacuum packing machine type B35 / B-M 42/42XL		



1

<b>GEV No.</b>	890261	<b>Ref. No.</b>	0940125
<b>description</b>	service kit for vacuum packing machine type B42 XL BA/Toucan BA		



1

<b>GEV No.</b>	890263	<b>Ref. No.</b>	0940140
<b>description</b>	service kit for vacuum packing machine type F80/P80 LL		



1

<b>GEV No.</b>	890256	<b>Ref. No.</b>	0940115
<b>description</b>	service kit for vacuum packing machine type J35/J42/B35		



1

<b>GEV No.</b>	890264	<b>Ref. No.</b>	0940130
<b>description</b>	service kit for vacuum packing machine type M46-M/F/P 52		



1

<b>GEV No.</b>	890265	<b>Ref. No.</b>	0940160
<b>description</b>	service kit for vacuum packing machine type P2-40/50/75		

### cut off wires



1

<b>GEV No.</b>	572018	<b>Ref. No.</b>	0305009
<b>description</b>	cut off wire $\varnothing$ 1.1mm Qty 3m		



1

<b>GEV No.</b>	572051	<b>Ref. No.</b>	0305010
<b>description</b>	cut off wire $\varnothing$ 1.1mm Qty supplied by meter		

### vacuum valves



1

<b>GEV No.</b>	691550	<b>Ref. No.</b>	0281000
<b>description</b>	vacuum valve connection 1"		



1

<b>GEV No.</b>	691554	<b>Ref. No.</b>	0900850
<b>description</b>	vacuum valve connection 1 1/4"		

### locking screws



1

<b>GEV No.</b>	691566	<b>Ref. No.</b>	0939110
<b>description</b>	locking screw thread 1/2" plastic		



1

<b>GEV No.</b>	691565	<b>Ref. No.</b>	0939105
<b>description</b>	locking screw thread 1/4" SS		





1

<b>GEV No.</b>	691564	<b>Ref. No.</b>	0939102
<b>description</b>	locking screw thread 1/8" SS		



1

<b>GEV No.</b>	691567	<b>Ref. No.</b>	0939113
<b>description</b>	locking screw thread 3/4" plastic		

## maintenance sets



1

<b>GEV No.</b>	691577	<b>Ref. No.</b>	0931225
<b>description</b>	maintenance set for air valve size 1"		



1

<b>GEV No.</b>	691575	<b>Ref. No.</b>	0900872
<b>description</b>	maintenance set for air valve size 1/4"		



1

<b>GEV No.</b>	691576	<b>Ref. No.</b>	0931220
<b>description</b>	maintenance set for vacuum valve size 1"		



1

<b>GEV No.</b>	691574	<b>Ref. No.</b>	N/A
<b>description</b>	maintenance set for vacuum valve size 1/4"		

## miscellaneous



1

<b>GEV No.</b>	691955	<b>Ref. No.</b>	0400735
<b>description</b>	flange ID ø 54mm L 80mm W 40mm H 14mm		



1

<b>GEV No.</b>	692470	<b>Ref. No.</b>	0380710
<b>description</b>	guide bar L 425mm W 25mm H 25mm for vacuum packing machine		



1

<b>GEV No.</b>	697921	<b>Ref. No.</b>	0330116
<b>description</b>	mounting clip set plastic for front panel		



1

<b>GEV No.</b>	692471	<b>Ref. No.</b>	0810112
<b>description</b>	non-return valve ID ø 8mm ED ø 10mm L 39.5mm for vacuum packing machine		



1

<b>GEV No.</b>	690977	<b>Ref. No.</b>	0380702
<b>description</b>	rail for gasket L 280mm aluminium		





			
1			
<b>GEV No.</b>	692065	<b>Ref. No.</b>	0065250
<b>description</b>	retaining ring for vacuum packing machine shaft $\phi$ 6mm thickness 0.7mm SS DIN 471		

			
1			
<b>GEV No.</b>	692066	<b>Ref. No.</b>	0390500
<b>description</b>	spindle ED $\phi$ 6mm L 127mm		

## gaskets

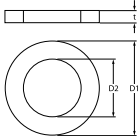
### O-rings

 			
1			
<b>GEV No.</b>	345896	<b>Ref. No.</b>	0065736 0065788
<b>description</b>	O-ring EPDM thickness 1.5mm ID $\phi$ 37mm Qty 1 pcs		

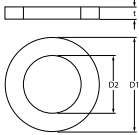
 			
1			
<b>GEV No.</b>	532672	<b>Ref. No.</b>	0065741
<b>description</b>	O-ring EPDM thickness 2mm ID $\phi$ 25mm Qty 1 pcs		

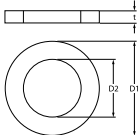
 			
1			
<b>GEV No.</b>	532671	<b>Ref. No.</b>	0065732
<b>description</b>	O-ring EPDM thickness 3mm ID $\phi$ 34mm Qty 1 pcs		

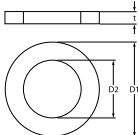
 			
1			
<b>GEV No.</b>	532670	<b>Ref. No.</b>	0065729
<b>description</b>	O-ring EPDM thickness 3mm ID $\phi$ 40mm Qty 1 pcs		

### NBR

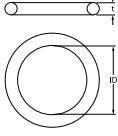
 			
1			
<b>GEV No.</b>	532692	<b>Ref. No.</b>	0065786
<b>description</b>	O-ring NBR thickness 1.5mm ID $\phi$ 52mm		

### foam rubber gaskets

			
1			
<b>GEV No.</b>	693787	<b>Ref. No.</b>	0320100
<b>description</b>	foam rubber gasket $\phi$ 6mm Qty supplied by meter		

### shaft gaskets

#### v-rings

			
1			
<b>GEV No.</b>	696559	<b>Ref. No.</b>	0065063
<b>description</b>	V-ring for shaft $\phi$ 32mm ID $\phi$ 31mm ED $\phi$ 39mm thickness 7mm		

			
1			
<b>GEV No.</b>	692067	<b>Ref. No.</b>	0065068
<b>description</b>	V-ring ID $\phi$ 45mm ED $\phi$ 55mm thickness 9mm		

### special gaskets

#### for vacuum packers

			
1			
<b>GEV No.</b>	693787	<b>Ref. No.</b>	0320100
<b>description</b>	foam rubber gasket $\phi$ 6mm Qty supplied by meter		

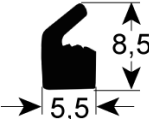
			
1			
<b>GEV No.</b>	900809	<b>Ref. No.</b>	0320215
<b>description</b>	lid gasket W 5.5mm H 9mm silicone Qty supplied by meter for vacuum packing machine		

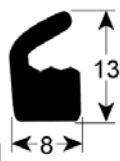

<b>GEV No.</b>	900807	<b>Ref. No.</b>	0320210
<b>description</b>	lid gasket W 8mm H 13mm silicone Qty supplied by meter for vacuum packing machine		

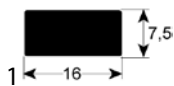

<b>GEV No.</b>	900806	<b>Ref. No.</b>	0320200
<b>description</b>	gasket W 16mm H 7.5mm silicone Qty supplied by meter for vacuum packing machine		

## springs

### gas tension springs

#### gas tension springs



<b>GEV No.</b>	701302	<b>Ref. No.</b>	0955003
<b>description</b>	gas tension spring 450N hub 90mm D1 ø 6mm D2 ø 15mm hole distance 230mm hole ø 6mm L 240mm		



<b>GEV No.</b>	691528	<b>Ref. No.</b>	0810200
<b>description</b>	gas tension spring for vacuum packing machine 370N hub 40mm D1 ø 18mm D2 ø 8mm hole distance 145mm hole ø 6.2mm L 155mm		



<b>GEV No.</b>	691529	<b>Ref. No.</b>	0810215
<b>description</b>	gas tension spring for vacuum packing machine 500N hub 65mm D1 ø 18mm D2 ø 8mm hole distance 225mm hole ø 6.3mm L 235mm		

### tension springs



<b>GEV No.</b>	504449	<b>Ref. No.</b>	0080107
<b>description</b>	tension spring ø 70mm total length 340mm wire gauge ø 8mm for vacuum packing machine Qty 1 pcs		

## manometers



<b>GEV No.</b>	541528	<b>Ref. No.</b>	0810101
<b>description</b>	manometer ø 40mm pressure range 0 up to 1bar connection angled connection ø 5mm		

## hoses

### industrial hoses

#### extraction and pressure hoses



<b>GEV No.</b>	570202 <sup>1</sup>	<b>Ref. No.</b>	0322052
<b>description</b>	pressure hose ID ø 7mm ED ø 13mm Lm operating p. 10bar burst p. 30bar temp.-resist. -30 up to +80°C		

<sup>1</sup>by the meter

## measuring equipment

### meters

#### pressure measurement

#### digital manometers

#### absolute-pressure measurement



<b>GEV No.</b>	800002	<b>Ref. No.</b>	0930300
<b>description</b>	pressure meter 0 up to 1300mbar type GMH 3161-12 vacuum + barometric pressure probe type absolute pressure sensor measurement unit mbar,bar,kPa,MPa,PSI,mmHg,mH2O connections 1 min/max value, tare, hold resolution 1mbar hose ø 4mm accuracy (temperature) ±0.4%FS accuracy (hysteresis) ±0.2%FS overload max. 4 bar interface serial (adapter not included) sensor piezoresistant gauge pressure sensor, int. dimensions 142x71x26mm incl. battery		

## fastening material

### fasteners

#### retaining rings

#### DIN 471



<b>GEV No.</b>	692065	<b>Ref. No.</b>	0065250
<b>description</b>	retaining ring for vacuum packing machine shaft ø 6mm thickness 0.7mm SS DIN 471		



			
1			
<b>GEV No.</b>	560302	<b>Ref. No.</b>	0065251
<b>description</b>	retaining ring shaft ø 8mm thickness 0.8mm SS DIN 471		

			
1			
<b>GEV No.</b>	890200	<b>Ref. No.</b>	0439502
<b>description</b>	oil type VM32 0.25l for vacuum packing machine		

## consumables

### lubricants

#### oils

#### for vacuum pumps

			
1			
<b>GEV No.</b>	890296	<b>Ref. No.</b>	0439510
<b>description</b>	oil type V32 1l for vacuum packing machine		

			
1			
<b>GEV No.</b>	890250	<b>Ref. No.</b>	0439503
<b>description</b>	oil type VM32 0.3l for vacuum packing machine		

			
1			
<b>GEV No.</b>	890253	<b>Ref. No.</b>	0439520
<b>description</b>	oil type VM100 1l for vacuum packing machine		

			
1			
<b>GEV No.</b>	890251	<b>Ref. No.</b>	0439505
<b>description</b>	oil type VM32 0.5l for vacuum packing machine		

			
1			
<b>GEV No.</b>	890252	<b>Ref. No.</b>	0439510 old version
<b>description</b>	oil type VM32 1l for vacuum packing machine		

			
1			
<b>GEV No.</b>	890247	<b>Ref. No.</b>	0439500
<b>description</b>	oil type VM22 0.05l for vacuum packing machine		

			
1			
<b>GEV No.</b>	890248	<b>Ref. No.</b>	0439501
<b>description</b>	oil type VM22 1l for vacuum packing machine		





**C**

consumables	17
contactors	3
control equipment	3

**E**

extraction and pressure hoses	16
-------------------------------	----

**F**

fasteners	16
fastening material	16
foam rubber gaskets	15

**H**

hoses	16
-------	----

**I**

industrial hoses	16
------------------	----

**L**

lubricants	17
------------	----

**M**

measuring equipment	16
meters	16
microswitches	3

**O**

oils	17
O-rings	15

**P**

pressure measurement	16
pumps	7

**R**

retaining rings	16
rocker/momentary rocker switches	3
rotary switches	3

**S**

shaft gaskets	15
solenoid valves	5
switches and momentary switches	3

**T**

transformers	4
--------------	---

**V**

vacuum pumps	7
--------------	---