

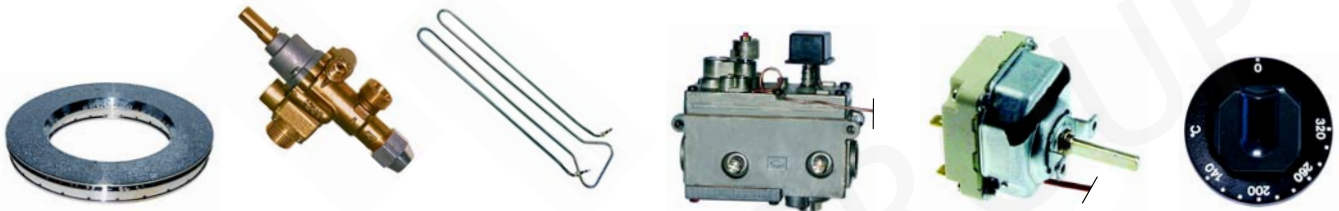

Ersatzteile passend für: ZANUSSI

Ersatzteile passend für Blockgeräte



Ersatzteile passend für Heißluftöfen und Combidämpfer



Ersatzteile passend für Einzelgeräte

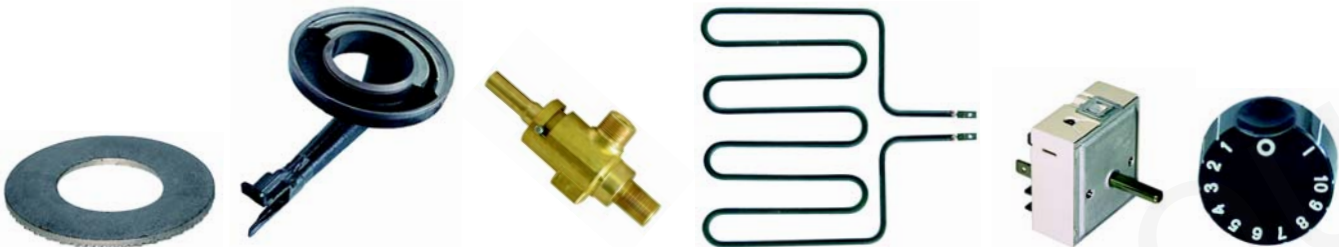

G.E.V. Großküchen-Ersatzteil-Vertrieb GmbH

Robert-Koch-Straße 3a
82152 Planegg/München
Deutschland

Telefon: +49 (0)89 745572-0
Telefax: +49 (0)89 745572-82

info@gev-online.de
www.gev-online.de



GEV GmbH Ersatzteile und Zubehör

Kanalstrasse 14
5745 Safenwil
Schweiz

Telefon: +41 (0)62 797 87 70
Telefax: +41 (0)62 797 25 07

info@gev.ch
www.gev.ch

Members of the GEV GROUP

INHALTSVERZEICHNIS

Offene Kochstellen (Gas/Elektro)



ab Seite 4

Backöfen (Gas/Elektro)

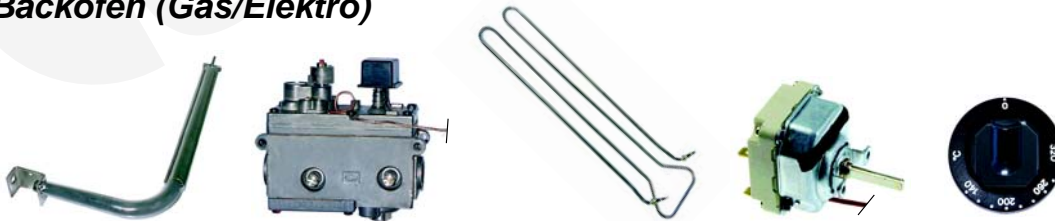

ab Seite 12

Wärmeschränke (Elektro)

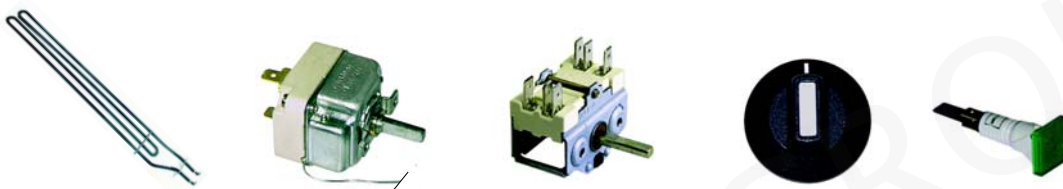

ab Seite 15

Grillplatten (Gas/Elektro)



ab Seite 15

Lavasteingrills (Gas), Grill (Elektro)



ab Seite 21

Multibräter (Gas)



ab Seite 24

INHALTSVERZEICHNIS

Nudelkocher (Gas/Elektro)



ab Seite 24

Backöfen (Gas/Elektro)

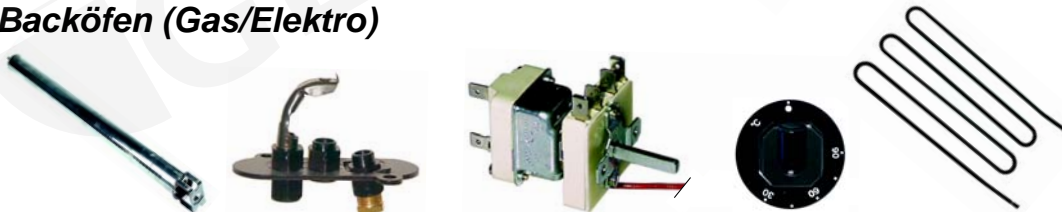

ab Seite 30

Frittenwärmer (Elektro), Friteusen (Gas/Elektro)



ab Seite 35

Kippbratpfannen (Gas/Elektro)

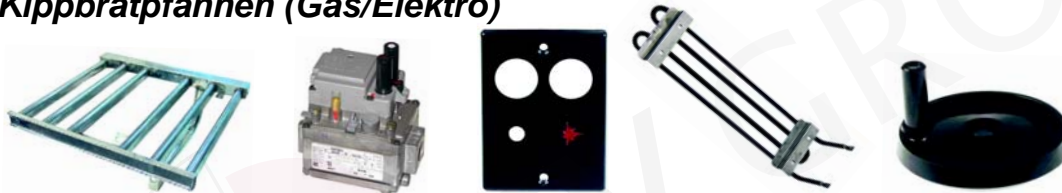

ab Seite 47

Kochkessel (Gas/Elektro)



ab Seite 57

Heißluftöfen + Combidämpfer (Gas/Elektro)

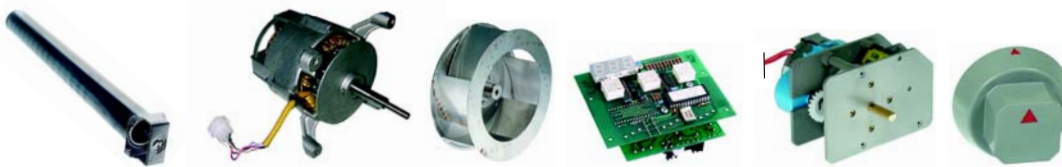

ab Seite 65

Klein- und Einzelgeräte (Gas/Elektro)



ab Seite 87

Offene Kochstellen (Gas)



Abb.	Bestell-Nr.	Beschreibung	Gerätetyp	Ver.-Nr.
1	104286	Brennerdeckel, 90mm		04973
2	104285	Brennergruppe, 90mm	SCG350/700 SCG1050	04972
3	104288	Brennerdeckel, 120mm	SCGFE700/1050	04975
4	104287	Brennergruppe, 120mm	SCGFE1051	04974
5	104289	Brennertasse		04977



Abb.	Bestell-Nr.	Beschreibung	Gerätetyp	Ver.-Nr.
1	101396	Gashahn		04956
2	110710	Knebel	SCG350/700 SCG1050	04957
3	102121	Thermoelement	SCGFE700/1050	04955
4	100009	Piezozünder	SCGFE1051	04944
5	100738	Zündkerze		04970



Abb.	Bestell-Nr.	Beschreibung	Gerätetyp	Vergleichs-Nr.
1	210155	Sternrost	SCG__	04976
2	210050	Reduzierstern	SCGFE__	

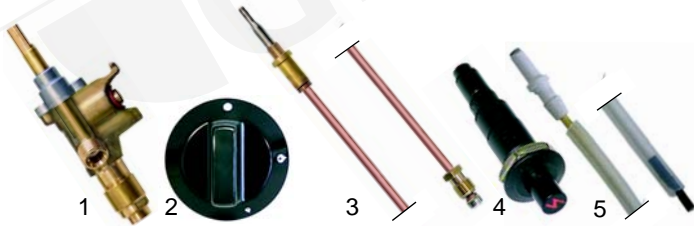

Abb.	Bestell-Nr.	Beschreibung	Gerätetyp	Vergl.-Nr.
1	105232	Brennerdeckel 70mm	RC/G_, RCF/G RCF/GE, RCV/G_	02442, 54097 55563, 58559
2	105008	Brennerring	RTF/G_, MC/G_, MCF/G_, MCF/GE,	54095, 56747
3	105231	Brennertulpe	MTF/G_, PCG_,	54091, 54164
4	105270	Dichtung	PCFG_, PCFGE_,	54093
5	105056	Mischhülse	PTFG_	53448



Abb.	Best.-Nr.	Beschreibung	Gerätetyp	Vergl.-Nr.
1	105012	Brennerdeckel 100mm	RC/G_, RCF/G RCF/GE, RCV/G_	02443, 54098 55562, 58560
2	105011	Brennerring	RTF/G_, MC/G_, MCF/G_, MCF/GE,	54096, 56748
3	105233	Brennertulpe	MTF/G_, PCG_,	54092, 54165
4	105271	Dichtung	PCFG_, PCFGE_, PTFG_	54094
5	105056	Mischhülse		53448



Abb.	Best.-Nr.	Beschreibung	Gerätetyp	Vergl.-Nr.
1	101094	Gashahn		54109, 54628 54629
2	102204	Thermoelement, 600mm	Geräte mit Züandsicherung	54102, 54103
2	102205	Thermoelement, 750mm		54104, 58332
3	101947	Halter	Geräte ohne Züandsicherung	58331
4	101398	Gashahn		54166, 54873 54874

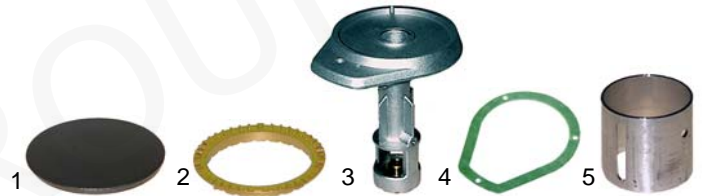

Abb.	Bestell-Nr.	Beschreib.	Gerätetyp	Ver.-Nr.
1	550677	Dichtung	RC/G_, RCF/G, RCF/GE, RCV/G, RTF/G	54108
2	111595	Knebel		54105
3	110289	Knebel	MC/G_, MCF/G, MCF/GE, MTF/G, MCV/G	58534
4	111596	Knebel	PCG_, PCFG_, PCFGE, PTFG	04329

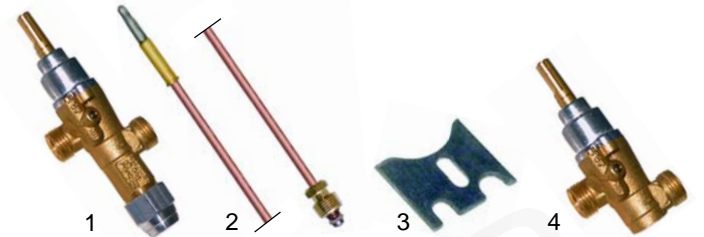

Abb.	Bestell-Nr.	Beschreibung	Gerätetyp	Vergl.-Nr.
1	100717	Zündkerze		54099
2	345038	Züandschalter	Universal	53978
3	345039	Schutzhaube		55979
4	301207	Schalter		04241
5	301208	Scheibe	PCG_, PCFG_, PCFGE_, PTFG_	04242
6	301209	Feder		04243

Z

Passend für Zanussi

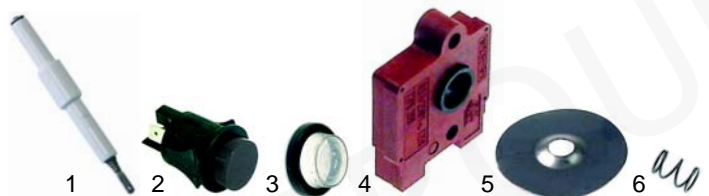

Abb.	Best.-Nr.	Beschreibung	Gerätetyp	Vergl.-Nr.
1	101002	Zündgruppe 2 Ausgänge	Universal	03376 04240, 51884 A2073, 53647
2	101003	Zündgruppe 4 Ausgänge		54134, A2097 03214
3	101004	Zündgruppe 6 Ausgänge		03552, 58826



Abb.	Best.-Nr.	Beschreibung	Gerätetyp	Vergl.-Nr.
1	105006	Brennerdeckel 122	HCS/G_	52121, 58187
2	105005	Brennerpfeife	HCF/G_ , HCF/GE_ , HTF/G_	52118, 58184
3	105055	Mischhülse		52116



Abb.	Bestell-Nr.	Beschreibung	Gerätetyp	Vergleichs-Nr.
1	210148	Sternrost		02446, 58575
2	210138	Sternrost		02436, 55064 55564, 58558



Abb.	Best.-Nr.	Beschreibung	Gerätetyp	Vergl.-Nr.
1	101087	Gashahn mit Züandsicherung	HCS/G_ , HCF/G_ , HCF/GE_ , HTF/G_	53202, 53203 52146, 53192 53196, 53199 53449
2	101690	Gashahn ohne Züandsicherung		52145
3	110045	Knebel		52138



Abb.	Bestell-Nr.	Beschreibung	Gerätetyp	Vergl.-Nr.
1	105002	Brennerdeckel	HCS/G_	521122, 58185
2	105001	Brennerpfeife	HCF/G_ , HCF/GE_ , HTF/G_	52119, 58182
3	105055	Mischhülse		52116



Abb.	Best.-Nr.	Beschreibung	Gerätetyp	Vergl.-Nr.
1	102008	Thermoelement		52163
2	102067	Mutter M8x1		55033
3	100048	Züandbrenner FG	HCS/G_ , HCF/G_ , HCF/GE_ , HTF/G_	52144
3	100113	Züandbrenner EG		56751
4	101342	Abdeckung		56580



Abb.	Best.-Nr.	Beschreibung	Gerätetyp	Vergl.-Nr.
1	105004	Brennerdeckel 102	HCS/G_	52123, 58186
2	105003	Brennerpfeife	HCF/G_ , HCF/GE_ , HTF/G_	52120, 58183
3	105055	Mischhülse		52116



Abb.	B.-Nr.	Beschreibung	Gerätetyp	Vergleichs-Nr.
1	210205	Auffangschale 83		52102, 52111, 55748
1	210206	Auffangschale 102		52103, 52112, 55749
1	210207	Auffangschale 122	HCS/G_ , HCF/G_ , HCF/GE_ , HTF/G_	52104, 52113, 55750
2	210139	Sternrost		58179, 56654, 53552
3	210001	Reduzierstern CNS		25056
3	210050	Reduzierstern Eisen VC		



Abb.	Bestell-Nr.	Beschreibung	Gerätetyp	Vergleichs-Nr.
1	105236	Brennerdeckel 83	HC/G_ HCF/G_ HCF/GE_ HTF/G_	59241, 59203
2	105235	Brennertasse		59201, 02461
3	105237	Brennerpfeife		59199, 02458
4	105055	Mischhülse		52116

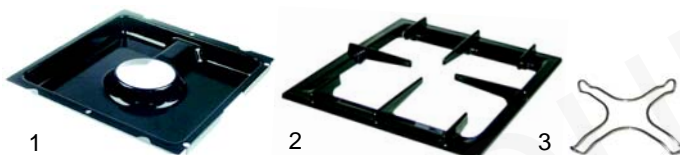

Abb.	Bestell-Nr.	Beschreibung	Gerätetyp	Vergleichs-Nr.
1	105239	Brennerdeckel 102	HC/G_ HCF/G_ HCF/GE_ HTF/G_	59242, 59204
2	105238	Brennertasse		59202, 02462
3	105240	Brennerpfeife		59200, 02459
4	105055	Mischhülse		52116



Abb.	Bestell-Nr.	Beschreibung	Gerätetyp	Vergleichs-Nr.
1	105242	Brennerdeckel 122		59253, 59213
2	105241	Brennertasse	HC/G_ HCF/G_ HCF/GE_ HTF/G_	59212, 02463
3	105243	Brennerpfeife		59211, 02460
4	105055	Mischhülse		52116
5	105244	Abstandshalter		02197



Abb.	Bestell-Nr.	Beschreibung	Gerätetyp	Vergleichs-Nr.
1	101095	Gashahn		59460, 59355 59353, 59361 59367, 59369
2	110348	Knebel	HC/G_ HCF/G_ HCF/GE_ HTF/G_	59206
3	102205	Thermoelement, 750mm		58332
4	100094	Zündbrenner		59214
5	100182	Abdeckung		03547



Abb.	Bestell-Nr.	Beschreibung	Gerätetyp	Vergl.-Nr.
1	210146	Sternrost	HC/G_ HCF/G_ HCF/GE_ HTF/G_	59208, 59245 02437
2	210001	Reduzierstern		25056



Abb.	Bestell-Nr.	Beschreibung	Gerätetyp	Vergleichs-Nr.
1	104554	Brennerdeckel, 6kW		0C0129
2	104555	Brennertulpe	NCG_ NCFG_ NCFGE_	0C0127
3	104556	Venturi		0C0125
4	104557	Brennerhalter	NTFG_	0C0124
5	532505	O-Ring		0C0188



Abb.	Bestell-Nr.	Beschreibung	Gerätetyp	Vergl.-Nr.
1	104558	Brennerdeckel, 10kW		0C0128
2	104559	Brennertulpe	NCG_ NCFG_ NCFGE_	0C0126
3	104560	Venturi		0C0133
4	104557	Brennerhalter	NTFG_	0C0124
5	532505	O-Ring		0C0188



Abb.	Bestell-Nr.	Beschreibung	Gerätetyp	Vergleichs-Nr.
1	101897	Gashahn		0C0205
2	111598	Knebel	NCG_ NCFG_ NCFGE_	0C0191
3	111632	Blende/vorne		0C0192
4	111633	Blende/hinten	NTFG_	0C0193
5	104563	Befestigung		69567



Abb.	B.-Nr.	Beschreibung	Gerätetyp	V.-Nr.
1	100879	Zündbrenner	NCG_ NCFG_ NCFGE_ NTFG_	0C0199
2	102035	Thermoelement, 850mm		0C0202

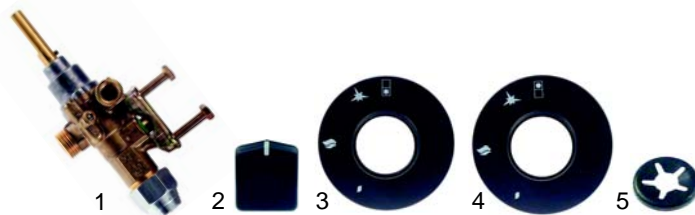

Abb.	Bestell-Nr.	Beschreibung	Gerätetyp	Vergl.-Nr.
1	210208	Sternrost	NCG_, NCFG_	0C0132
2	210209	Sternrost CNS	NCFG_., NTFG_	0C0130

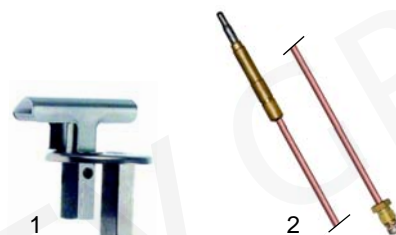

Abb.	Bestell-Nr.	Beschreibung	Gerätetyp	Vergleichs-Nr.
1	210210	Sternrost	CCAG_	0G2022
2	210211	Mittelrost	CCFG_	0G2033



Abb.	Bestell-Nr.	Beschreibung	Gerätetyp	Vergleichs-Nr.
1	103087	Brennerdeckel 90		0H6320
2	104028	Brennerunterteil	CCAG_	0H6340
3	104043	Brennerpfeife	CCFG_	0H7155
4	103007	O-Ring		



Abb.	Bestell-Nr.	Beschreibung	Gerätetyp	Vergleichs-Nr.
1	103088	Brennerdeckel 110		0H6321
2	104029	Brennerunterteil	CCAG_	0H6341
3	104044	Brennerpfeife	CCFG_	0G1811
4	103007	O-Ring		



Abb.	Bestell-Nr.	Beschreibung	Gerätetyp	Ver.-Nr.
1	101095	Gashahn		59460
2	110348	Knebel	CCAG_	59206
3	102038	Thermoelement, 1500mm	CCFG_	0G2023



Abb.	Bestell-Nr.	Beschreibung	Gerätetyp	Vergl.-Nr.
1	100853	Zündbrenneroberteil		0H6342
2	100847	Zündbrennermittelteil	CCAG_	0H6343
3	101598	Zündbrennerunterteil	CCFG_	0G2024
4	100806	Dichtung		0H6645

Offene Kochstellen (Glühplatte)

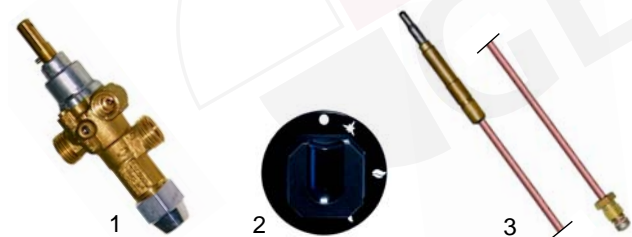

Abb.	Bestell-Nr.	Beschreibung	Gerätetyp	Vergl.-Nr.
1	104564	Brennerdeckel	RTV/G	54193
2	104565	Brennerpfeife	RTF/G	54246
3	104566	Abdeckung	MTV/G (1.Gen.)	54536
4	105055	Luftmischer	MT/G70_	52116

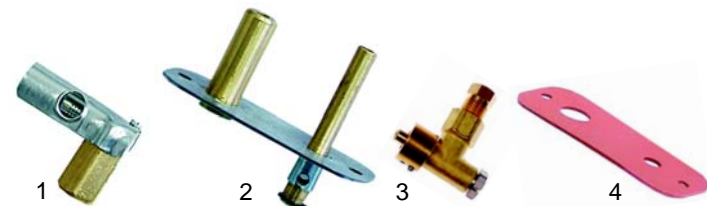

Abb.	Bestell-Nr.	Beschreibung	Gerätetyp	Vergl.-Nr.
1	104567	Brenner	MT/G35_	02528
2	104568	Brenner	MSV/G_, MSF/G_	04287
3	104569	Luftmischer		02527



Abb.	Bestell-Nr.	Beschreibung	Gerätetyp	Vergl.-Nr.
1	104570	Brennerdeckel		04280
2	104571	Brennerpfeife	MTV/G (2.Gen.)	04279
3	104566	Abdeckung	MTF/G (2.Gen.)	54536
4	105055	Luftmischer	MSF/G3	52116

Z

Passend für Zanussi

7



Abb.	Bestell-Nr.	Beschreibung	Gerätetyp	Vergleichs-Nr.
1	105026	Brennerdeckel	HTS/G_	52377, 0G2241
2	105024	Brennerpfeife	HTF/G, HT/G CTAG_, CTFG_	52374, 0G2245
3	105025	Abdeckung	NTG_, NTGF_	52376, 0G2244
4	104572	Halter		52500



Abb.	Bestell-Nr.	Beschreibung	Gerätetyp	Vergleichs-Nr.
1	101095	Gashahn PEL21		04282
2	110348	Knebel	MSV/G	59206
3	345777	Schalter	MSF/G	04288
4	301208	Scheibe		04242
5	301209	Feder		04243



Abb.	Bestell-Nr.	Beschreibung	Gerätetyp	Vergleichs-Nr.
1	101087	Gashahn PEL22		52146
2	111599	Knebel	RTV/G_	52604
3	550677	Dichtung	RTF/G_	54108
4	100007	Piezozünder		52539

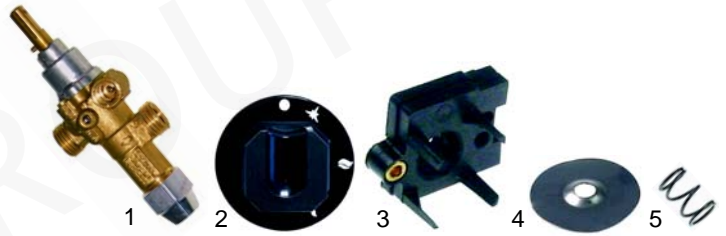

Abb.	Bestell-Nr.	Beschreibung	Gerätetyp	Vergleichs-Nr.
1	101087	Gashahn PEL22		56351
2	110045	Knebel	HTS/G HTF/G (1.Gen.)	52146, 53662
3	100007	Piezozünder		52138
				52539, 58225



Abb.	Bestell-Nr.	Beschreibung	Gerätetyp	Vergl.-Nr.
1	101087	Gashahn PEL22		52146
2	110309	Knebel	MTF/G (1.Gen.)	58597
3	100012	Piezozünder	MT/G	02605
4	101339	Abdeckhaube		02816



Abb.	Bestell-Nr.	Beschreibung	Gerätetyp	Vergleichs-Nr.
1	101087	Gashahn PEL22		52146
2	110448	Knebel	MT/G HTF/G (2.Gen.)	59378
3	100012	Piezozünder		02605
4	101339	Abdeckhaube		02816

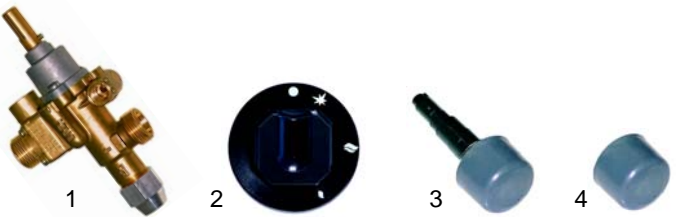

Abb.	Bestell-Nr.	Beschreibung	Gerätetyp	Vergl.-Nr.
1	101095	Gashahn PEL21		04282
2	110348	Knebel	MTFG/G	59206
3	100012	Piezozünder	MT/G (2.Gen.)	02605
4	101339	Abdeckhaube		02816



Abb.	Bestell-Nr.	Beschreibung	Gerätetyp	Vergleichs-Nr.
1	101087	Gashahn, PEL22		0G2251, 0K1347
2	111600	Knebel	CTAG_	0G2258, 59538
3	100012	Piezozünder	CTFG_	02605
4	101339	Abdeckhaube		02816



Abb.	Bestell-Nr.	Beschreibung	Gerätetyp	Vergleichs-Nr.
1	101897	Gashahn		0C0205
2	111598	Knebel	NTG_	0C0191
3	111633	Scheibe	NTGF_	0C0193
4	100012	Piezozünder		02605
5	101339	Abdeckhaube		02816S



Abb.	Bestell-Nr.	Beschreibung	Gerätetyp	V.-Nr.
1	100050	Zündbrenner	MTV/G	59379
2	100701	Zündkerze	MTF/G (2.Gen.)	59380
3	102038	Thermoelement, 1500mm	MSV/G, MSF/G_	51119

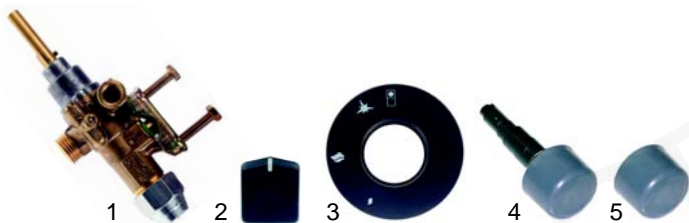

Abb.	Bestell-Nr.	Beschreibung	Gerätetyp	Vergl.-Nr.
1	100046	Zündbrenner		50813
2	100708	Zündkerze	RTV/G	51977
3	102041	Thermoelement, 600mm	RTF/G	57781



Abb.	Bestell-Nr.	Beschreibung	Gerätetyp	V.-Nr.
1	100106	Zündbrenner, 0,35		58329
1	100046	Zündbrenner, 0,20	HTS/G	50813
2	100708	Zündkerze	HTF/G (1.Gen.)	51977
3	102044	Thermoelement, 1200mm		20094



Abb.	Bestell-Nr.	Beschreibung	Gerätetyp	V.-Nr.
1	100106	Zündbrenner		58329
2	100706	Zündkerze	MTF/G (1.Gen.)	56754
3	102045	Thermoelement, 1500mm	MT/G70_	52814



Abb.	B.-Nr.	Beschreibung	Gerätetyp	Vergl.-Nr.
1	100050	Zündbrenner		59379, 0G2266
2	100701	Zündkerze	CTAG	59380, 0G2265
3	102044	Thermoelement, 1200mm	CTFG_	20094, 0G2065



Abb.	Bestell-Nr.	Beschreibung	Gerätetyp	V.-Nr.
1	100050	Zündbrenner	MT/G3S_	59379
2	100701	Zündkerze	HT/G	59380
3	102045	Thermoelement, 1500mm	HTF/G (2.Gen.)	52814



Abb.	Bestell-Nr.	Beschreibung	Gerätetyp	Vergl.-Nr.
1	100198	Zündbrenner		05503
2	100701	Zündkerze	NTG_	59380
3	102035	Thermoelement, 850mm	NTGF_	0C0202

Offene Kochstellen (Ceran/Gas)



Abb.	Bestell-Nr.	Beschreibung	Gerätetyp	Vergleichs-Nr.
1	101164	Gasregler		03040
2	100739	Elektrode	HI/G400	03041
3	375561	Thermostat	HI/G800	03047



Abb.	Bestell-Nr.	Beschreibung	Gerätetyp	Vergleichs-Nr.
1	380004	Energieregler		59046
2	110429	Knebel	HI/G400	59554
3	346287	Taster	HI/G800	02418
4	359364	Signallampe		58658

Offene Kochstellen (Elektro)

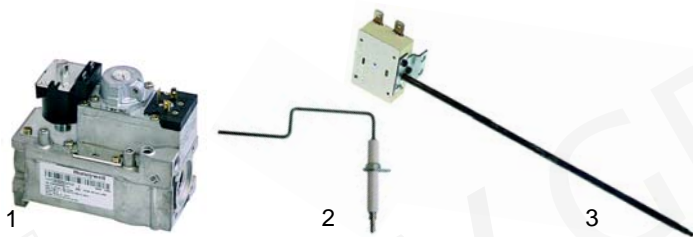

Abb.	Bestell-Nr.	Beschreibung	Gerätetyp	Vergl.-Nr.
1	490010	1500W/230V, 145mm	700-Serie (alt)	58104
2	490014	1500W/230V, 180mm	Universal	53607, 53406
2	490015	1500W/400V, 180mm	700-Serie	03930
2	490016	2000W/230V, 180mm	600-Serie	04914
3	490020	2600W/230V, 220mm	Universal	53606, 53407
3	490021	2600W/400V, 220mm	700-Serie	03931



Abb.	B.-Nr.	Beschreibung	Gerätetyp	Vergleichs-Nr.
1	490066	2600W/230V (220x220)	MCV/E2Q MCF/E2Q	06220 0A2198, 0A2199
2	490056	3000W/230V (300x300)		52198, 52196
2	490057	3000W/400V (300x300)	Universal	52197
2	490071	4000W/230V (300x300)	900-Serien	52199, 52201
2	490074	4000W/400V (300x300)		52200

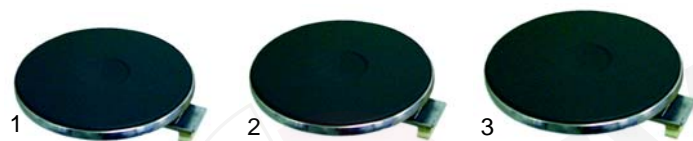

Abb.	Bestell-Nr.	Beschreibung	Gerätetyp	Vergleichs-Nr.
1	300004	Siebentaktschalter		04915
2	110711	Knebel	SCE350 SCE700	04913
3	359132	Signalelement	SCFE700	04895
4	359123	Einsteckfassung		04896

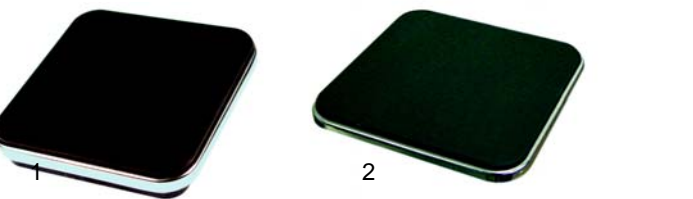

Abb.	Bestell-Nr.	Beschreibung	Gerätetyp	Vergleichs-Nr.
1	300004	Siebentaktschalter		53408
2	111601	Knebel	RCV/E 320	53403
3	359109	Signalelement	RCV/E 720	54150
4	359803	Linse	RCF/E 720	54151



Abb.	Best.-Nr.	Beschreibung	Gerätetyp	Vergleichs-Nr.
1	300004	Siebentaktschalter	MC/E350	53408
2	110317	Knebel	MC/E700	53547
3	359364	Signallampe/grün	MC/E1050 MCF/E700	05010, 58658
4	359365	Signallampe/gelb	MCF/E1050	05011, 58659

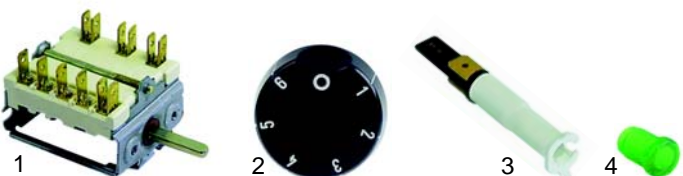

Abb.	Best.-Nr.	Beschreibung	Gerätetyp	Ver.-Nr.
1	300177	Siebentaktschalter	MC/E1, MC/E2	59238
2	110428	Knebel	MCV/E2, MCV/E3	59230
3	359364	Signallampe grün	MCF/E2, MC/E2Q	05010
4	359365	Signallampe gelb	MCF/E2Q	05011

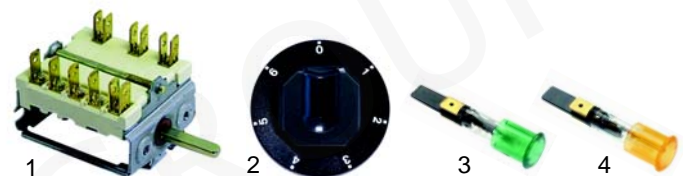

Abb.	Bestell-Nr.	Beschreibung	Gerätetyp	Vergleichs-Nr.
1	300075	Fünftaktschalter		25300
2	110398	Knebel/braun	HCS/E400	52184
3	110397	Knebel/schwarz	HCS/E800	52183
4	359150	Signallampe	HCF/E800	53153

Z

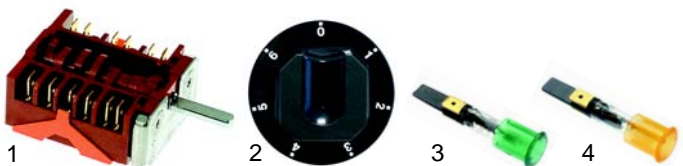
Passend für Zanussi



Abb.	Bestell-Nr.	Beschreibung	Gerätetyp	Vergleichs-Nr.
1	300177	Siebertaktschalter	HC/E400	59238
2	110428	Knebel	HC/E800	59230
3	359364	Signallampe	HCF/E800	58658, 05010



Abb.	Bestell-Nr.	Beschreibung	Gerätetyp	Vergleichs-Nr.
1	300177	Siebertaktschalter		59238
2	111605	Blende/vorne	NCE400	0C0304
3	111606	Blende/hinten	NCE800	0C0307
4	111602	Knebel	NCFE800	0C0257
5	359364	Signallampe/grün		05010
6	359365	Signallampe/gelb		05011

Offene Kochstellen (Ceran/Elektro)

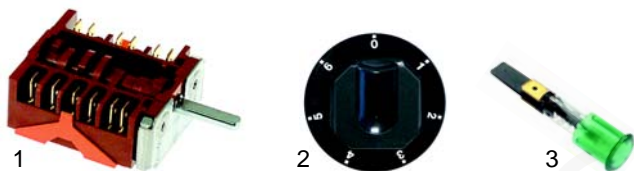

Abb.	B.-Nr.	Beschreibung	Gerätetyp	Ver.-Nr.
1	490134	2200W/230V (2-kreisig)	MI/E350	59432
2	490044	2200W/230V (2-kreisig)	MI/E700	A5299
3	490133	2100W/230V (2-kreisig)	MIF/E700	59043
4	490028	2100W/230V (2-kreisig)	MI/E1, MIF/E2	05008
5	490115	3400W/230V (2-kreisig)	HI/E400, HI/E800	02557
			NIE400, NIE800	

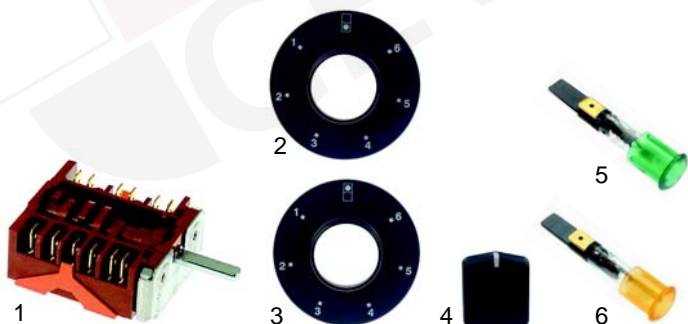

Abb.	Bestell-Nr.	Beschreibung	Gerätetyp	Vergleichs-Nr.
1	359326	Restwärmeanzeige		59047
2	359364	Signallampe/grün	Universal	05010, 58658
3	359365	Signallampe/gelb		05011, 58659
4	380004	Energierегler, 2-kr.		59046

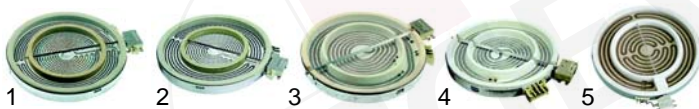

Abb.	Bestell-Nr.	Beschreibung	Gerätetyp	Vergl.-Nr.
1	110307	Knebel	HI/E350, MI/E700, MIF700	59042
2	111603	Knebel	MI/E1, MIF/E2, MI/E2, MIV/E2	05009
3	111604	Knebel	HI/E400, HI/E800	59554
4	111607	Dichtung	Universal	53816



Abb.	Bestell-Nr.	Beschreibung	Gerätetyp	Vergleichs-Nr.
1	111608	Blende/vorne		0C0317
2	111609	Blende/hinten	NIE400	0C0318
3	111602	Knebel	NIE800	0C0257
4	111607	Dichtung		53816

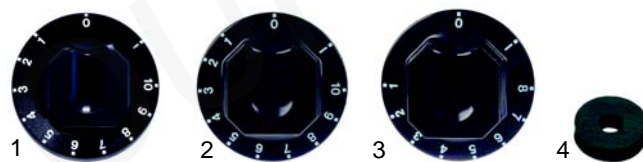

Abb.	Bestell-Nr.	Beschreibung	Gerätetyp	Vergleichs-Nr.
1	380244	Schütz	NIE400	88477
2	601130	Ventilator	NIE800	06125

Offene Kochstellen (Induktion)

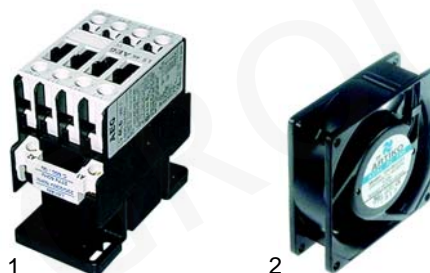

Abb.	Bestell-Nr.	Beschreibung	Gerätetyp	Vergleichs-Nr.
1	404001	Spule, 5kW/400W		0C0027
2	404002	Frequenzumsetzer	NINE400	0C0028
3	404003	Tastatur elektrisch	NINE800	0C0025
4	404004	Tastaturfolie	NINE400	0C0026
5	404005	Tastaturfolie	NINE800	0C0038

Backofen (Gas)



Abb.	Bestell-Nr.	Beschreibung	Gerätetyp	Vergl.-Nr.
1	104229	Brenner	RCF/G_, RTF/G	54117
2	104230	Abdeckung	MCF/G_	54119
3	104573	Brenner	MCF/G_	58979

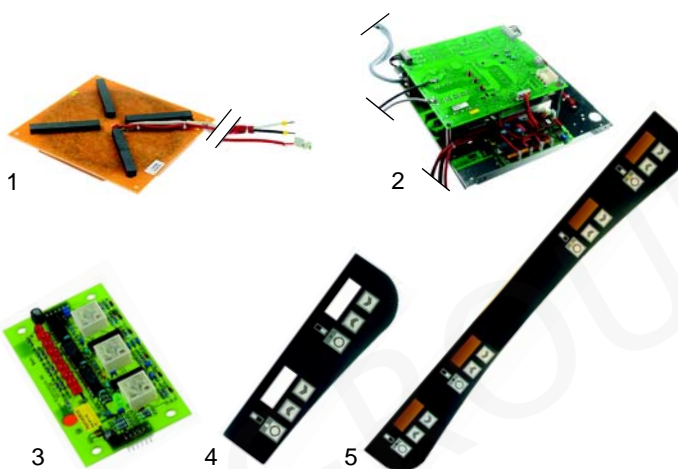

Abb.	Bestell-Nr.	Beschreibung	Gerätetyp	V.-Nr.
1	104574	Brenner	PCFG_	04258
2	104230	Abdeckung	MCF/G990, MCFG/095,	54119
3	104575	Brenner	PCFG900	02513



Abb.	Bestell-Nr.	Beschreibung	Gerätetyp	Vergl.-Nr.
1	105061	Brenner	HCF/G_(1.Gen.)	52717
2	104224	Abdeckung	HTF/G_(1.Gen.)	52048
3	104223	Brenner	HVCF/G (2.Gen.) HTFG (2.Gen.) NCFG_, NTFG_	59221
4	104576	Abdeckung	HCF/G_ HTF/G_	59596
5	104577	Abdeckung	NCFG_, NTFG_	0C0175



Abb.	Bestell-Nr.	Beschreibung	Gerätetyp	Vergleichs-Nr.
1	n.m.l.	Gasthermostat	RCF/G	54129
2	111610	Knebel	RTF/G	54126
3	550677	Dichtung	MTF/G	54108



Abb.	Bestell-Nr.	Beschreibung	Gerätetyp	Vergleichs-Nr.
1	n.m.l.	Gasthermostat	MCF/G	54635, 54129
2	110319	Knebel		58537



Abb.	Bestell-Nr.	Beschreibung	Gerätetyp	Vergl.-Nr.
1	101409	Eurositregler, 280°C		58772
2	110281	Knebel	MCF/G1090	59010
3	111611	Knebel	MCF/G1095	02130
4	101392	Adapter	MCF/G995	58773
5	110357	Achse		03654



Abb.	Bestell-Nr.	Beschreibung	Gerätetyp	Vergleichs-Nr.
1	101955	Thermostat PEL25	PCFG_	06597, 04257
2	111612	Knebel	PTFG_	04336



Abb.	Bestell-Nr.	Beschreibung	Gerätetyp	Vergl.-Nr.
1	101435	Minisitregler		52068
2	101137	Abdeckkappe	HCF/G (1.Gen.)	56577
3	110068	Knebel	HTF/G (1.Gen.)	54268

Z

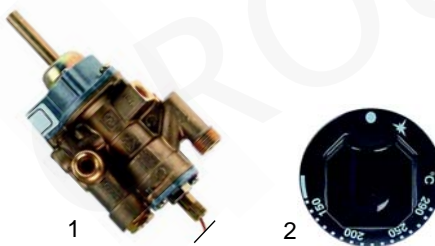
Passend für Zanussi

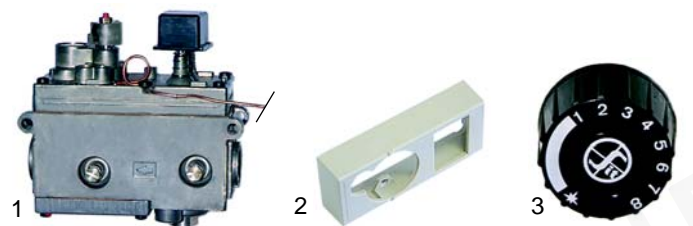

Abb.	Bestell-Nr.	Beschreibung	Gerätetyp	Vergl.-Nr.
1	101409	Eurositregler		58772
2	101392	Adapter	HCF/G (2.Gen.) HTF/G (2.Gen.)	58773
3	110357	Achse		02130
4	110349	Knebel		59220



Abb.	B.-Nr.	Beschreibung	Gerätetyp	V.-Nr.
1	415078	1500W/230V	RCF/E, MCF/GE, MCF/G, MTF/GE, PCFGE, PCFE	54634 54147
2	415071	1500W/230V	HCF/GE, HTF/GE, HCF/G	53405 53608
3	415378	950W/230V	HCF/GE (2.Gen.) HCF/E (2.Gen.)	59237
4	416977	1500W/230V	NCFGE, NCPE	0C0310



Abb.	Bestell-Nr.	Beschreibung	Gerätetyp	Vergleichs-Nr.
1	101960	Regler		0C0209
2	111613	Blende	NCFG_ NTFG_	0C0194
3	111614	Knebel		0C0189
4	111615	Knebel		0C0190

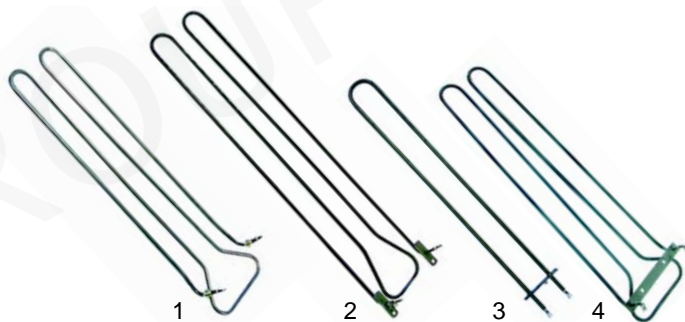

Abb.	Bestell-Nr.	Beschreibung	Gerätetyp	Vergleichs-Nr.
1	301090	Schalter		53866
2	111616	Knebel		53404
3	375424	Thermostat		52099
4	111617	Knebel		53867
5	359109	Signalelement/grün	RCF/E720	54150
5	359110	Signalelement/gelb		53811
6	359803	Linse grün		54151
7	359804	Linse gelb		53812

Backöfen (Elektro)



Abb.	Bestell-Nr.	Beschreibung	Gerätetyp	Vergl.-Nr.
1	415966	2500W/230V		04934
2	601011	Motor		04933
3	359132	Signalelement/grün	SCFE700	04895
3	359130	Signalelement/gelb		-
4	359123	Einsteckfassung/grün		04896
5	359124	Einsteckfassung/gelb		04928

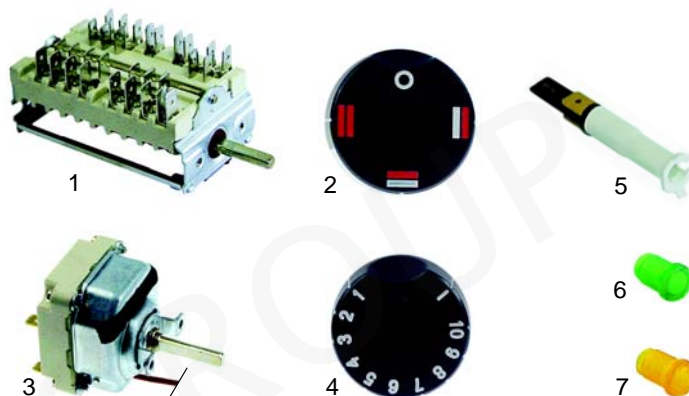

Abb.	Bestell-Nr.	Beschreibung	Gerätetyp	Vergleichs-Nr.
1	375002	Thermostat		05421
2	300001	Vorsatzschalter	SCFE700	04908
3	110707	Knebel		05432



Abb.	Bestell-Nr.	Beschreibung	Gerätetyp	Vergleichs-Nr.
1	301090	Schalter		53866
2	110278	Knebel	MCF/GE_ MTF/GE_	58541
3	375424	Thermostat		52099
4	110279	Knebel	MCF/E MTF/E	58542
5	359364	Signalelement/grün		58658
6	359365	Signalelement/gelb		58659

Z

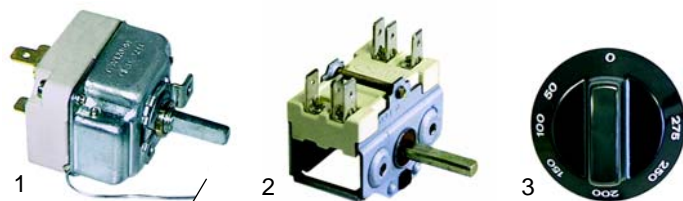
Passend für Zanussi

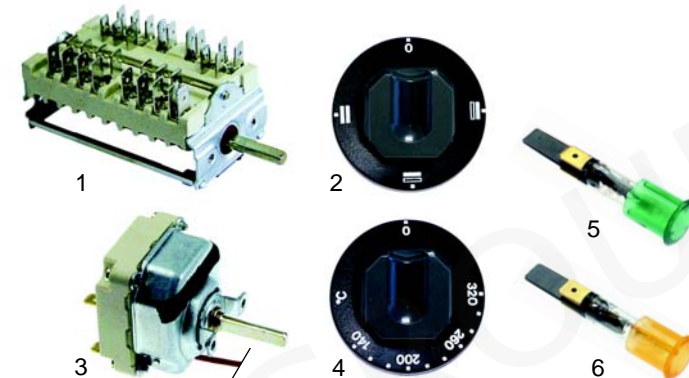

Abb.	Bestell-Nr.	Beschreibung	Gerätetyp	Vergleichs-Nr.
1	301211	Schalter		04268
2	111618	Knebel	PCFGE	04343
3	375424	Thermostat	PCFE	52099
4	111619	Knebel	PIFE	04330
5	359364	Signallampe/grün		05010
6	359365	Signallampe/gelb		05011



Abb.	Bestell-Nr.	Beschreibung	Gerätetyp	Vergleichs-Nr.
1	300013	Schalterkomb.		52721
2	110399	Knebel	HCF/GE,	52087
3	375424	Thermostat	HCF/GE,	52099
4	110046	Knebel	HCF/E	26915
5	359151	Signallampe/grün		53148
6	359152	Signallampe/gelb		53149

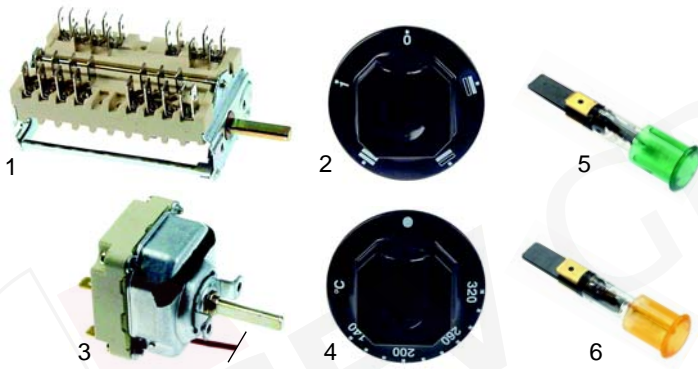

Abb.	Bestell-Nr.	Beschreibung	Gerätetyp	Vergleichs-Nr.
1	375587	Thermostat		59235
2	550060	Bügel	HCF/GE (2 Gen.), HCF/E (2 Gen.)	A2205
3	300002	Vorsatzschalter		A2134
4	110427	Knebel		59236

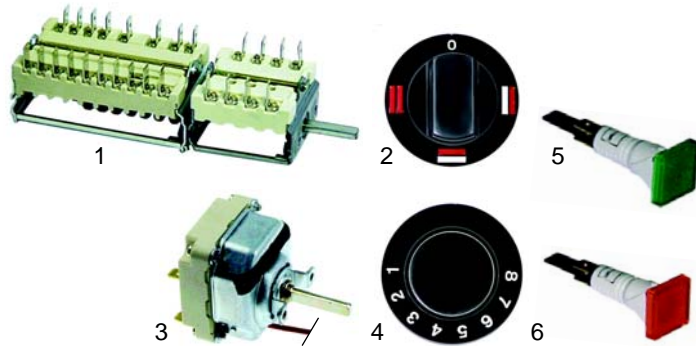

Abb.	Best.-Nr.	Beschreibung	Gerätetyp	Vergl.-Nr.
1	380017	Energiregler		53695
2	110426	Knebel		59850
3	375571	Sicherheitsthermostat	HCF/GE (2 Gen.), HCF/E (2 Gen.)	51454
4	359364	Signallampe/grün		58658
5	359365	Signallampe/gelb		58659

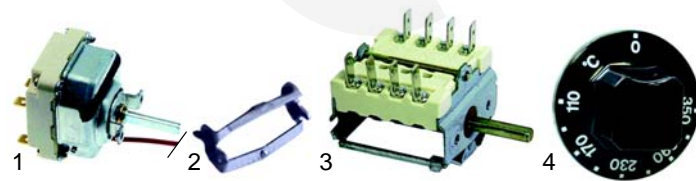

Abb.	Best.-Nr.	Beschreibung	Gerätetyp	Vergl.-Nr.
1	301215	Schalter		0C0320
2	375587	Thermostat		59235
3	375565	Sicherheitsthermostat	NCFGE, NCFE	0C0270
4	359364	Signallampe/grün		05010
5	359365	Signallampe/gelb		05011

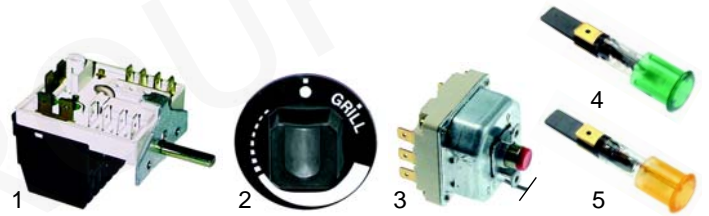

Abb.	Best.-Nr.	Beschreibung	Gerätetyp	Vergl.-Nr.
1	111620	Blende		0C0258
2	111621	Blende	NCFGE, NCFE	0C0259
3	111602	Knebel		0C0257

Backöfen (Mechanik)

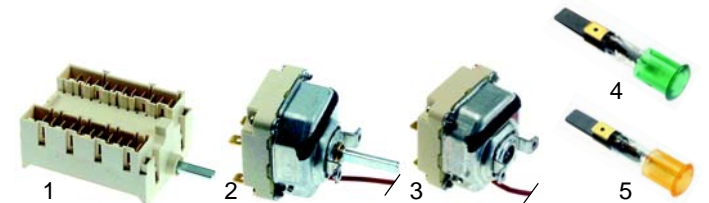

Abb.	Bestell-Nr.	Beschreibung	Gerätetyp	Vergleichs-Nr.
1	700010	Scharnier		50766, 59277, 0C0203
2	700001	Gegenstück	Universal	-
3	900397	Türdichtung/oben		54112, 54111

Wärmeschränke (Elektro)



Abb.	Bestell-Nr.	Beschreibung	Gerätetyp	Vergleichs-Nr.
1	416978	2500W/230V	700 Serie	A2201
2	415383	2500W/230V	HMA/E800	52416, 52429

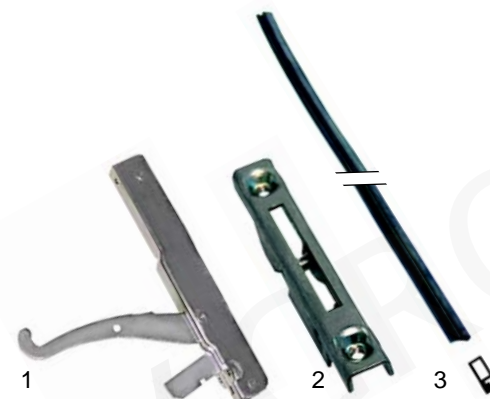

Abb.	Bestell-Nr.	Beschreibung	Gerätetyp	Vergleichs-Nr.
1	375055	Thermostat		52000
2	300001	Vorsatzschalter	700 Serie	A2036
3	110253	Knebel		A2269
4	359364	Signallampe		05010

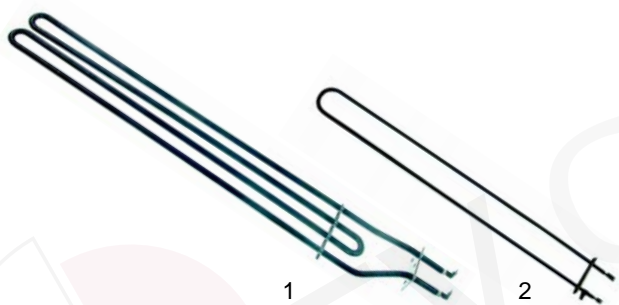

Abb.	Bestell-Nr.	Beschreibung	Gerätetyp	Vergleichs-Nr.
1	375411	Thermostat		52000
2	300080	Vorsatzschalter		26945
3	110046	Knebel	HMA/E800	26915
4	359151	Signallampe/grün		53148
5	359152	Signallampe/gelb		53149

Grillplatten (Gas)

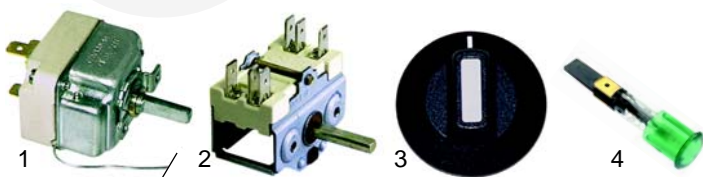

Abb.	Bestell-Nr.	Beschreibung	Gerätetyp	Vergleichs-Nr.
1	104290	Brenner	SRG350,	04954
2	101396	Gashahn	SRG360,	04956
3	110710	Knebel	SRG700,	04957
4	100855	Halter	SRG710	05618

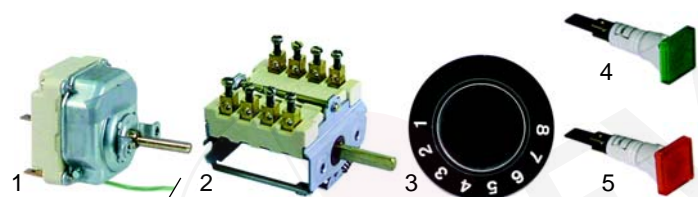

Abb.	Best.-Nr.	Beschreibung	Gerätetyp	Vergl.-Nr.
1	102121	Thermoelement, 600mm		04955
2	100009	Piezozünder	SRG350,	04944
3	100018	Zündkabel	SRG360,	
4	100706	Zündkerze	SRG700,	04943
			SRG710	56754

Grillplatten (Gas)

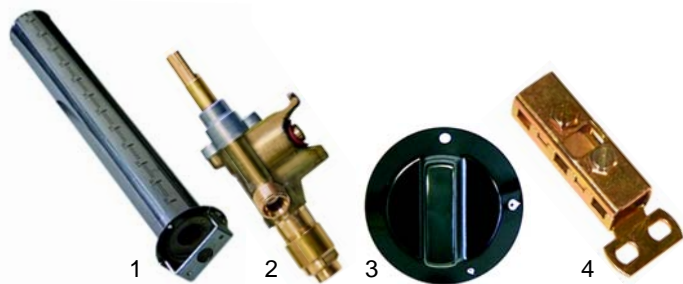

Abb.	B.-Nr.	Beschreibung	Gerätetyp	Vergl.-Nr.
1	104227	Brenner	RR/G_, RRV/G, MR/G_	53380, 58696
2	104226	Brenner	MR/G_ (verchromte Platte)	58770
3	104578	Brenner	MR/G1_, MR/G2, MRV/G1_, MRV/G1_, MRV/G2_	04591
4	104129	Brenner	HRS/G_	52912



Abb.	B.-Nr.	Beschreibung	Gerätetyp	Vergl.-Nr.
1	104579	Brenner	HRS/G_ (verchromte Platte)	56002
2	104580	Brenner	HR/G (1 Gen.), CRAG_	A5124, OG2270
3	104581	Brenner	HR/G (2 Gen.), NRG_	06650

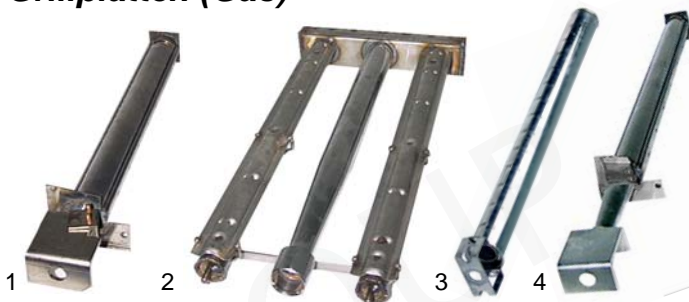

Abb.	Bestell-Nr.	Beschreibung	Gerätetyp	Vergl.-Nr.
1	101087	Gashahn	RR/G_, RRV/G_	52146, 53199
2	111599	Knebel		52604
3	100007	Piezozünder		52539



Abb.	Bestell-Nr.	Beschreibung	Gerätetyp	Vergleichs-Nr.
1	101409	Eurositregler	MR/G1_VC, MR/G2_VC	58772
2	110358	Adapter		03391
3	111623	Knebel		04658
4	100012	Piezozünder		02605
5	101339	Abdeckhaube		02816



Abb.	Bestell-Nr.	Beschreibung	Gerätetyp	Vergleichs-Nr.
1	101087	Gashahn	MR/G	52146
2	110309	Knebel		58597
3	100012	Piezozünder		02605
4	101339	Abdeckhaube		02816



Abb.	Bestell-Nr.	Beschreibung	Gerätetyp	Vergleichs-Nr.
1	101087	Gashahn	HRS/G	52146, 52921
2	110045	Knebel		52138
3	100007	Piezozünder		52539



Abb.	Bestell-Nr.	Beschreibung	Gerätetyp	Vergleichs-Nr.
1	101409	Eurositregler	MR/G_ (verchromte Platte)	58772
2	110308	Knebel		58776
3	100012	Piezozünder		02605
4	101339	Abdeckhaube		02816



Abb.	Bestell-Nr.	Beschreibung	Gerätetyp	Vergleichs-Nr.
1	101183	Compositventil	HBS/G_VC	53973
2	375574	Thermostat		55996
3	110046	Knebel		26915
4	101002	Zündgruppe		53643

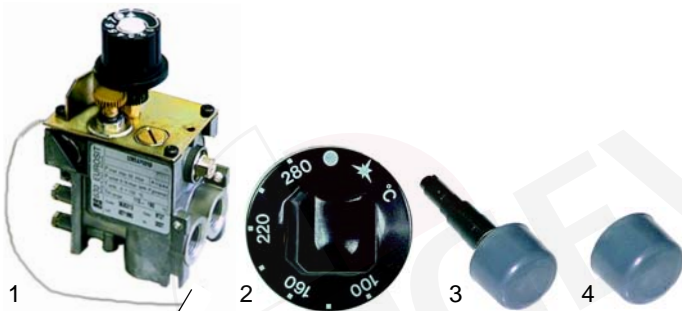

Abb.	Bestell-Nr.	Beschreibung	Gerätetyp	Vergl.-Nr.
1	101095	Gashahn	MR/G1, MR/G2	04282
2	110348	Knebel		59206
3	100012	Piezozünder		02605
4	101339	Abdeckhaube		02816

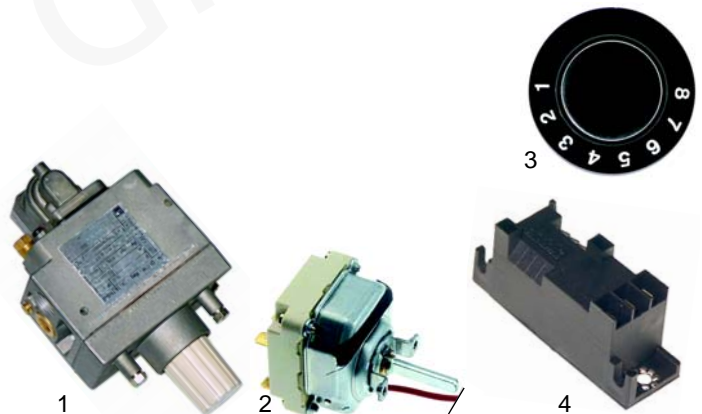

Abb.	Bestell-Nr.	Beschreibung	Gerätetyp	Vergleichs-Nr.
1	345038	Taster	HBS/G_VC	53978
2	345161	Schalter		54518
3	345039	Abdeckhaube		53979

Z

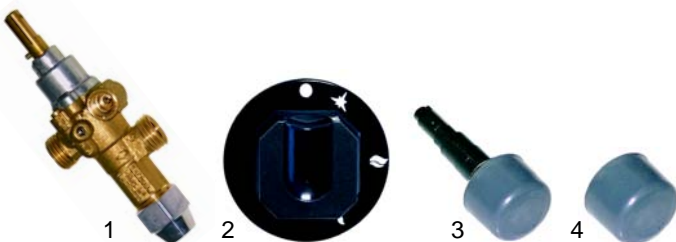
Passend für Zanussi



Abb.	Bestell-Nr.	Beschreibung	Gerätetyp	Vergleichs-Nr.
1	101435	Minisitregler		52068
2	101137	Abdeckhaube	HRS/G_VC	56577
3	110068	Knebel	(2 Gen.)	54268
4	100007	Piezozünder		58225



Abb.	Bestell-Nr.	Beschreibung	Gerätetyp	Vergleichs-Nr.
1	101409	Eurositregler		58772
2	101392	Adapter		58773
3	101390	Achse	HR/G_VC,	02130
4	111624	Knebel	CRAG_	59422
5	100012	Piezozünder		02605
6	101339	Abdeckhaube		02816

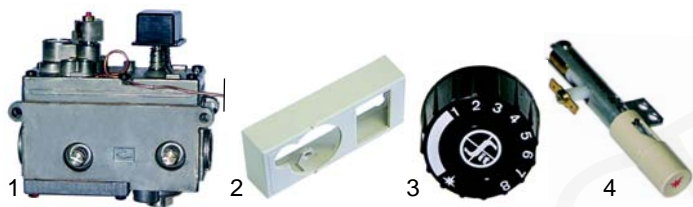

Abb.	Bestell-Nr.	Beschreibung	Gerätetyp	Vergleichs-Nr.
1	101095	Gashahn PEL21		59460
2	110348	Knebel	HR/G	59206
3	100012	Piezozünder		02605
4	101339	Abdeckhaube		02816

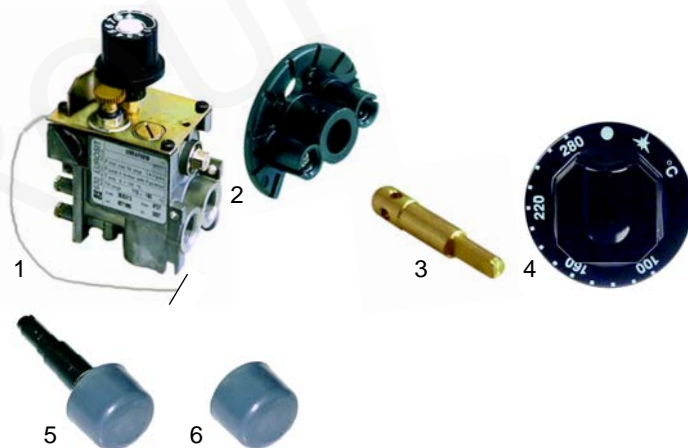

Abb.	Bestell-Nr.	Beschreibung	Gerätetyp	Vergleichs-Nr.
1	101957	Gasregler		06692
2	550679	Dichtung	HR/G	06465
3	111625	Knebel		06464



Abb.	Bestell-Nr.	Beschreibung	Gerätetyp	Vergl.-Nr.
1	n.m.l.	Gasthermostat		54129
2	110446	Knebel	HR/	59413
3	100012	Piezozünder	G_Thermostat	02605
4	101339	Abdeckhaube		02816



Abb.	Bestell-Nr.	Beschreibung	Gerätetyp	Vergleichs-Nr.
1	101897	Gashahn		0C0205
2	111633	Blende		0C0193
3	111598	Knebel	NRG_	0C0191
4	100012	Piezozünder		02605
5	101339	Abdeckhaube		02816



Abb.	Bestell-Nr.	Beschreibung	Gerätetyp	Vergl.-Nr.
1	101957	Gasregler		06692
2	111626	Blende	NRG_ (Thermostat), NRG_VC	0C0597
3	111614	Knebel		0C0189
4	111615	Knebel		0C0190

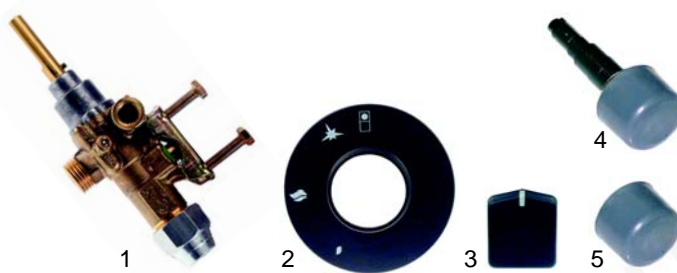

Abb.	Best.-Nr.	Beschreibung	Gerätetyp	V.-Nr.
1	100106	Zündbrenner EG	MR/G_VC	58329
2	100706	Zündkerze		56754
3	102250	Thermoelement, 1000mm		56914
4	375163	Sicherheitsthermostat		51643



Abb.	B.-Nr.	Beschreibung	Gerätetyp	V.-Nr.
1	100046	Zündbrenner FG	RR/G_, RRV/G_, HRS/G, HRS/G_VC (1 Gen.)	50813
2	100708	Zündkerze		51977
3	102041	Thermoelement, 600mm		57781



Abb.	Best.-Nr.	Beschreibung	Gerätetyp	V.-Nr.
1	100050	Zündbrenner	MR/G1, MR/G2, HR/G_, NRG_	59379
2	100701	Zündkerze		59380
3	102038	Thermoelement, 1500mm		51119



Abb.	B.-Nr.	Beschreibung	Gerätetyp	V.-Nr.
1	100106	Zündbrenner EG	MR/G, HRS/G_VC (2 Gen.)	58329
2	100706	Zündkerze		56754
3	102045	Thermoelement, 1500mm		52814



Abb.	Best.-Nr.	Beschreibung	Gerätetyp	V.-Nr.
1	100050	Zündbrenner	MR/G1_VC, MR/G2_VC, HR/G_VC, HR/G_ (2 Gen.), NRG_VC, CRAG_VC	59379
2	100701	Zündkerze		59380
3	102250	Thermoelement, 1000mm		56914

Z

Passend für Zanussi

Grillplatten (Elektro)



Abb.	Best.-Nr.	Beschreibung	Gerätetyp	Vergl.-Nr.
1	375563	Sicherheitsthermostat, 3-pol., 360°C	HR/G1_VC, HR/G2_VC	04600
2	375572	Sicherheitsthermostat, 1-pol., 360°C	HR/G_VC	53980
3	375562	Sicherheitsthermostat, 3-pol., 360°C	HR/G_ (2 Gen.), NRG_VC, CRAG_VC	04269



Abb.	Best.-Nr.	Beschreibung	Gerätetyp	V.-Nr.
1	100198	Zündbrenner	NRG_	05503
2	100701	Zündkerze	(Thermostat)	59380
3	102041	Thermoelement, 600mm		25031

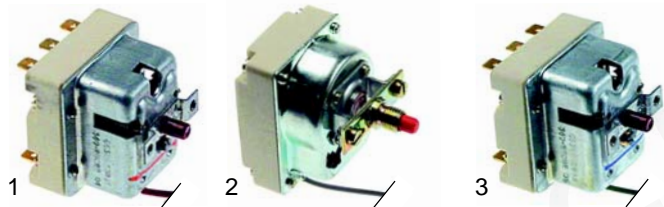

Abb.	Best.-Nr.	Beschreibung	Gerätetyp	V.-Nr.
1	100050	Zündbrenner		59375
2	100701	Zündkerze	CRAG_	59380
3	102044	Thermoelement, 1200mm		20094

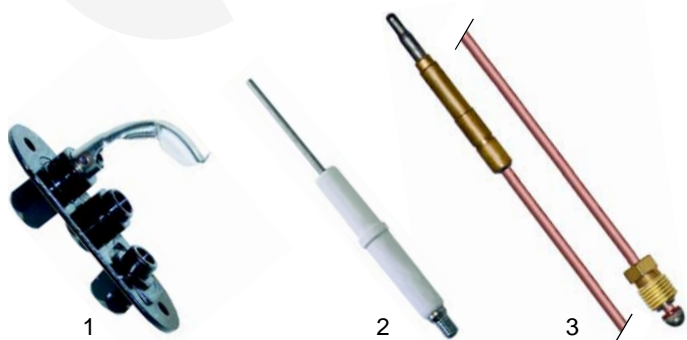

Abb.	Bestell-Nr.	Beschreibung	Gerätetyp	Vergl.-Nr.
1	415290	1300W/230V	SRE_	04918
2	415079	1250W/230V	RR/E_, RRV/E_, MR/E_	53393, 53614
3	416985	1250W/230V	PRE_, PREV_	04649
4	416986	1500W/230V	RRE_VC, PREV_VC	04671



Abb.	Bestell-Nr.	Beschreibung	Gerätetyp	Vergl.-Nr.
1	415382	2000W/230V	HRS/E_VC	55998
1	415380	1000W/230V	HRS/E	52919, 52920
2	415184	2200W/230V	HR/E_	59401
3	416987	2500W/230V	HR/E_, NRE_	06681

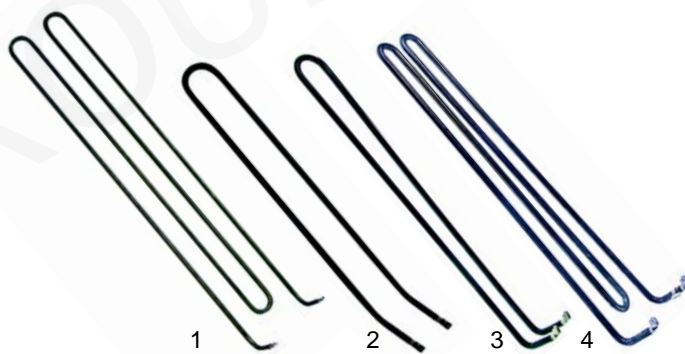

Abb.	Bestell-Nr.	Beschreibung	Gerätetyp	Vergl.-Nr.
1	375560	Thermostat		04363
2	300002	Vorsatzschalter		A2134
3	111627	Knebel	PRE_, RREV_, MR/E1, MR/E2, MRV/E1, MRV/E2	04710
4	359364	Signallampe/grün		05010
5	359365	Signallampe/gelb		05011

Z

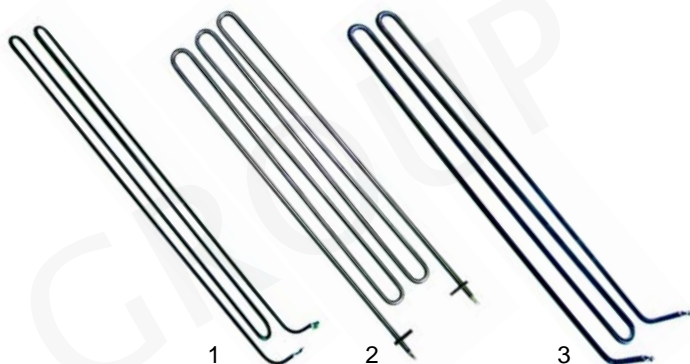
Passend für Zanussi

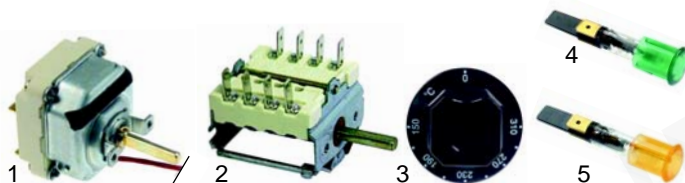

Abb.	Bestell-Nr.	Beschreibung	Gerätetyp	Vergleichs-Nr.
1	375038	Thermostat		52916
2	300080	Vorsatzschalter		26945
3	110046	Knebel	HRS/E	26915
4	359151	Signallampe/grün		53148
5	359152	Signallampe/gelb		53149



Abb.	Bestell-Nr.	Beschreibung	Gerätetyp	Vergleichs-Nr.
1	375587	Thermostat		599235
2	300180	Vorsatzschalter		06649
3	111628	Blende	NRE_, NRFE_	0C0466
4	111602	Knebel		0C0257
5	359364	Signallampe/grün		05010
6	359365	Signallampe/gelb		05011

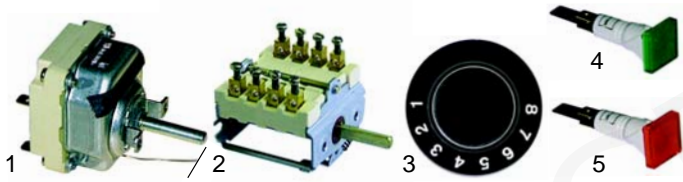

Abb.	Bestell-Nr.	Beschreibung	Gerätetyp	Vergleichs-Nr.
1	375574	Thermostat		55996
2	300080	Vorsatzschalter		26945
3	110046	Knebel	HRS/E_VC	26915
4	359151	Signallampe/grün		53148
5	359152	Signallampe/gelb		53149

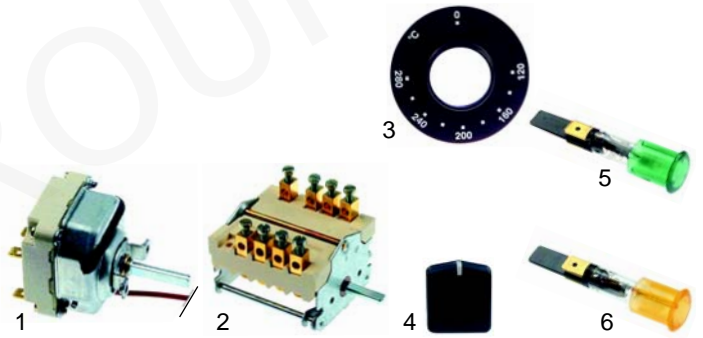

Abb.	B.-Nr.	Beschreibung	Gerätetyp	V.-Nr.
1	375557	Sicherheitsthermostat, 270°C	MR/E_VC, PRE_VC	06307
2	375571	Sicherheitsthermostat, 350°C	HR/E	51454
3	375562	Sicherheitsthermostat, 360°C	HR/E_VC, NRE_, NRFE_	04269



Abb.	Bestell-Nr.	Beschreibung	Gerätetyp	Vergleichs-Nr.
1	375587	Thermostat		59235
2	300002	Vorsatzschalter		A2134
3	110447	Knebel	HR/E	59403
4	359364	Signallampe/grün		58658
5	359365	Signallampe/gelb		58659



Abb.	Bestell-Nr.	Beschreibung	Gerätetyp	Vergleichs-Nr.
1	375183	Thermostat		04917
2	300001	Vorsatzschalter	SRE_	04908
3	110713	Knebel		04916

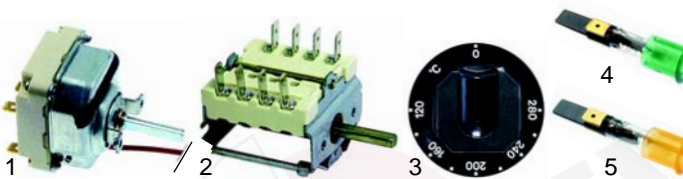

Abb.	Bestell-Nr.	Beschreibung	Gerätetyp	Vergleichs-Nr.
1	375587	Thermostat		59235
2	300180	Vorsatzschalter		06649
3	110447	Knebel	HR/E_VC	59403
4	359364	Signallampe/grün		05010
5	359365	Signallampe/gelb		05011

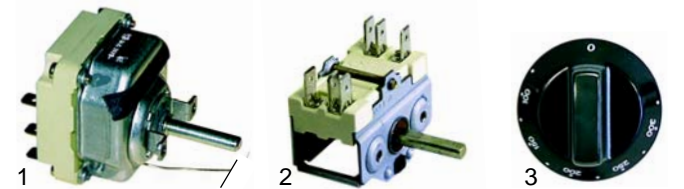

Abb.	Bestell-Nr.	Beschreibung	Gerätetyp	Vergl.-Nr.
1	390142	Sicherheitsthermostat		049919
2	359132	Signalelement	SRE_	04895
3	359123	Einsteckfassung		04896

Z

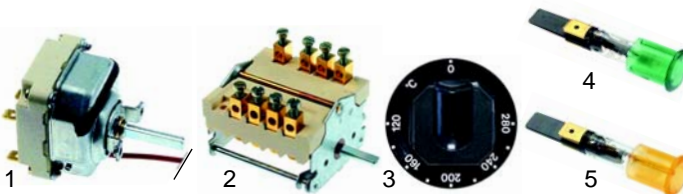
Passend für Zanussi



Abb.	Bestell-Nr.	Beschreibung	Gerätetyp	Vergleichs-Nr.
1	375038	Thermostat		52916
2	300080	Vorsatzschalter		26945
3	111629	Knebel	RR/E_, RRV/E_	26801
4	359110	Signalelement		53811
5	359804	Linse		53812



Abb.	Bestell-Nr.	Beschreibung	Gerätetyp	Vergl.-Nr.
1	101397	Gashahn		04961
2	110716	Knebel	SCG350, SCG700	04966
3	102041	Thermoelement, 600mm		04942

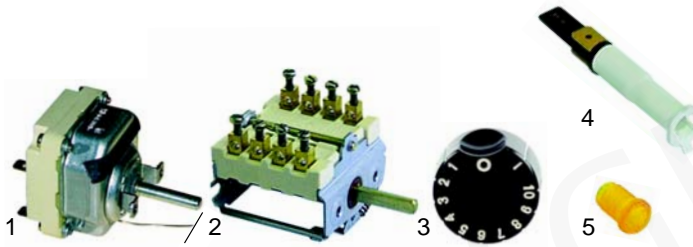

Abb.	Bestell-Nr.	Beschreibung	Gerätetyp	Vergleichs-Nr.
1	375038	Thermostat		52916
2	300080	Vorsatzschalter		26945
3	110342	Knebel	MR/E	58579
4	359364	Signallampe/grün		58658
5	359365	Signallampe/gelb		58659



Abb.	Bestell-Nr.	Beschreibung	Gerätetyp	Vergl.-Nr.
1	100043	Zündbrenner		04962
2	100706	Zündkerze	SCG350, SCG700	56754
3	100018	Zündkabel, 600mm		-
4	100009	Piezozünder		04944

Lavasteingrills (Gas)

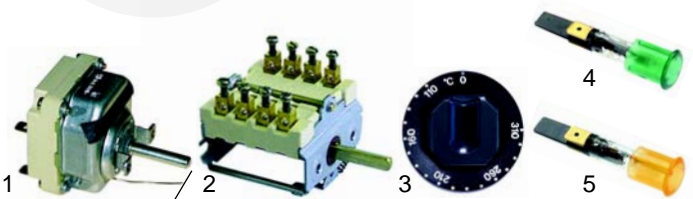

Abb.	Bestell-Nr.	Beschreibung	Gerätetyp	Vergleichs-Nr.
1	105483	Brenner		05656
2	211024	Lavasteinrost	SCG350, SCG700	04964
3	211025	Grillrost		04963



Abb.	Bestell-Nr.	Beschreibung	Gerätetyp	Vergl.-Nr.
1	104128	Brenner		52855, 56555
2	211051	Lavasteinrost	RG/G_, RGV/ G_, MG/G_	56657
3	211006	Lavasteinrost		54711
4	211034	Grillrost		53693

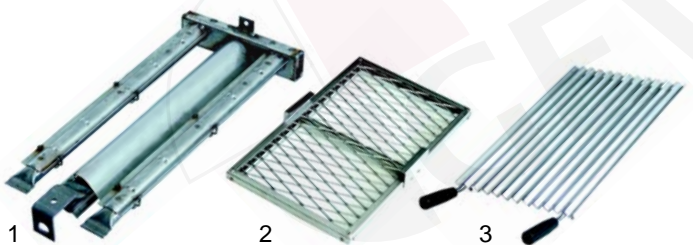

Abb.	Bestell-Nr.	Beschreibung	Gerätetyp	Vergl.-Nr.
1	104128	Brenner		56555
2	211035	Lavasteinrost (350)	SCG_, MG/G1,	06205
3	211036	Lavasteinrost (700)	MG/G2	06206
4	211034	Grillrost		53693

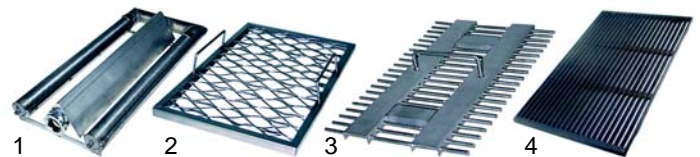

Abb.	Bestell-Nr.	Beschreibung	Gerätetyp	Vergl.-Nr.
1	104582	Brenner		02358
2	211059	Lavasteinrost (400)	HG/G400,	02385
3	211037	Lavasteinrost (800)	HG/G800	02395
4	211038	Grillrost		02389

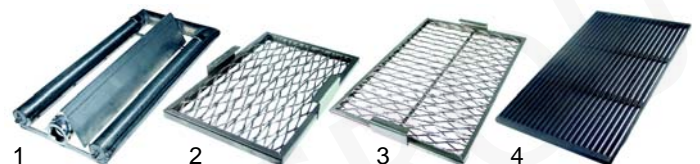

Abb.	Bestell-Nr.	Beschreibung	Gerätetyp	Vergleichs-Nr.
1	104583	Brenner		0C0490
2	211039	Lavasteinrost	NGG400,	0C0479
3	211041	Grillrost	NGG800	0C0424

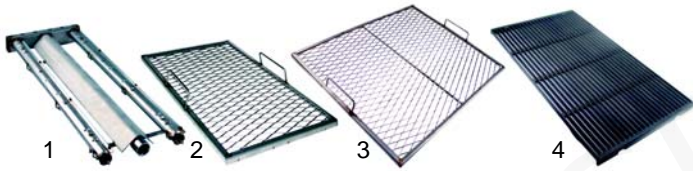

Abb.	Bestell-Nr.	Beschreibung	Gerätetyp	Vergleichs-Nr.
1	101087	Gashahn		52146
2	111599	Knebel	RG/G_,	52604
3	100007	Piezozünder	RGV/G_	52539



Abb.	Bestell-Nr.	Beschreibung	Gerätetyp	Ver.-Nr.
1	100046	Zündbrenner		50813
2	100708	Zündkerze	RG/G_,	51977
3	102045	Thermoelement, 1500mm	RGV/G_	52814



Abb.	Bestell-Nr.	Beschreibung	Gerätetyp	Vergleichs-Nr.
1	101087	Gashahn		52146
2	110309	Knebel	MG/G_	58597
3	100012	Piezozünder		02605
4	101339	Abdeckhaube		02816



Abb.	Best.-Nr.	Beschreibung	Gerätetyp	Vergl.-Nr.
1	100106	Zündbrenner		58329
2	100706	Zündkerze	MG/G_	56754
3	102045	Thermoelement, 1500mm		52814



Abb.	Bestell-Nr.	Beschreibung	Gerätetyp	Vergl.-Nr.
1	101095	Gashahn		59460
2	111630	Knebel	MG/G1, MG/G2,	04821
3	100012	Piezozünder	SCG350,	02605
4	101339	Abdeckhaube	SCG700	02816



Abb.	Best.-Nr.	Beschreibung	Gerätetyp	V.-Nr.
1	100109	Zündbrenner		A2472
2	100701	Zündkerze	MG/G1,	52610
3	102038	Thermoelement, 1500mm	MG/G2, SCG_	51119

Z

Passend für Zanussi



Abb.	Bestell-Nr.	Beschreibung	Gerätetyp	Vergleichs-Nr.
1	101087	Gashahn		52146
2	110448	Knebel	HG/G400, HG/G800	59378
3	100012	Piezozünder		02605
4	101339	Abdeckhaube		02816



Abb.	Bestell-Nr.	Beschreibung	Gerätetyp	Ver.-Nr.
1	100109	Zündbrenner	HG/G400, HG/G800	A2472
2	100701	Zündkerze		52610
3	102045	Thermoelement, 1500mm		52814



Abb.	Bestell-Nr.	Beschreibung	Gerätetyp	Vergleichs-Nr.
1	101981	Gashahn		0C0489
2	111632	Blende	NGG400, NGG800	0C0192
3	111631	Knebel		0C0465
4	100012	Piezozünder		02605
5	101339	Abdeckhaube		02816



Abb.	Best.-Nr.	Beschreibung	Gerätetyp	Vergl.-Nr.
1	100046	Zündbrenner	NGG400, NGG800	0C0494
2	100706	Zündkerze		0C0488
3	102045	Thermoelement, 1500mm		52814

Rost-Grills (Elektro)



Abb.	Bestell-Nr.	Beschreibung	Gerätetyp	Vergleichs-Nr.
1	415288	1350W/230V		04907
2	380204	Schütz	SGE350, SGE700	03027
3	345254	Mikroschalter		04904



Abb.	Bestell-Nr.	Beschreibung	Gerätetyp	Vergleichs-Nr.
1	380015	Energeregler		05270
2	110708	Knebel	SGE350, SGE700	04987
3	359132	Signalelement		04985
4	359123	Einsteckfassung		04986

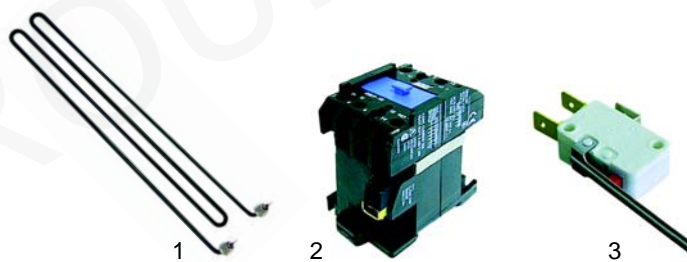

Abb.	B.-Nr.	Beschreibung	Gerätetyp	Vergl.-Nr.
1	415352	3000W/230V	RG/E300, RG/E700, MG/E350, MG/E700, MG/E1, MG/E2, SGE350, MG/E1, MGV/E2	53451, 53613
2	415376	1800W/230V	HG/E400, HG/E800	02403
3	416978	2500W/400V	NGE400, NGE800	0C0495



Abb.	B.-Nr.	Beschreibung	Gerätetyp	Vergl.-Nr.
1	380017	Energeregler		53695, 53697
2	110898	Knebel	RG/E350, RG/E700	53694
3	359109	Signalelement		54150
4	359803	Linse		54151

Z

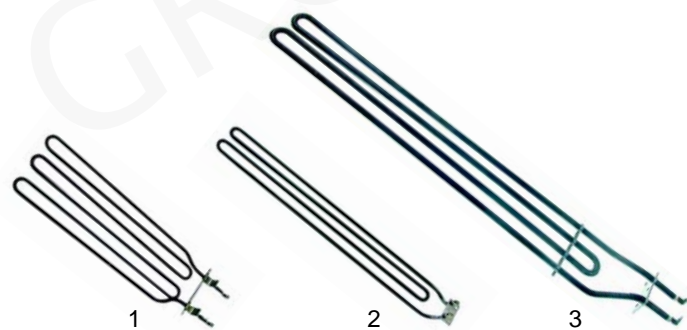
Passend für Zanussi

Multibräter (Gas)



Abb.	Bestell-Nr.	Beschreibung	Gerätetyp	Ver.-Nr.
1	375412	Thermostat	MG/350, MG700	A2206
2	300002	Vorsatzschalter		A2134
3	110342	Knebel		58579
4	359364	Signallampe		58658



Abb.	Best.-Nr.	Beschreibung	Gerätetyp	Ver.-Nr.
1	104584	Brenner	MMV/G1, PBRG360	06462
2	104585	Brenner	MMV/G2, PBRG710	06471

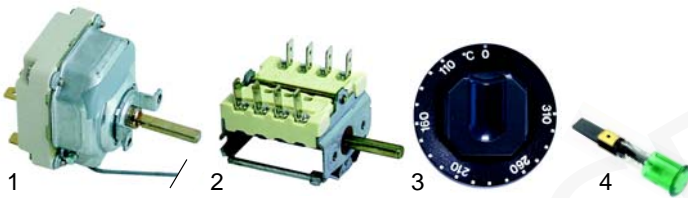

Abb.	Bestell-Nr.	Beschreibung	Gerätetyp	Vergl.-Nr.
1	375559	Thermostat	HG/E400, HG/E800	02402
2	110466	Knebel		02401
3	300017	Schalter		A2241
4	110449	Knebel		59333
5	359364	Signallampe/grün		58658
6	359365	Signallampe/gelb		58659



Abb.	B.-Nr.	Beschreibung	Gerätetyp	Ver.-Nr.
1	101959	Gasregler	MMV/G1, MMV/G2, PBRG360, PBRG710	06460
2	111625	Knebel		06464
3	550679	Dichtung		06465
4	375562	Sicherheitsthermostat		04269

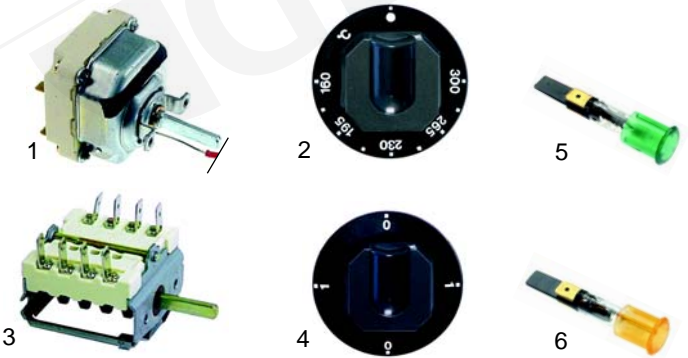

Abb.	Bestell-Nr.	Beschreibung	Gerätetyp	Ver.-Nr.
1	375560	Thermostat	MR/E1, MR/E2, MRV/E1, MRV/E2, SGE350	04363
2	300002	Vorsatzschalter		A2134
3	111627	Knebel		04710
4	359364	Signallampe/grün		05010
5	359365	Signallampe/gelb		05011

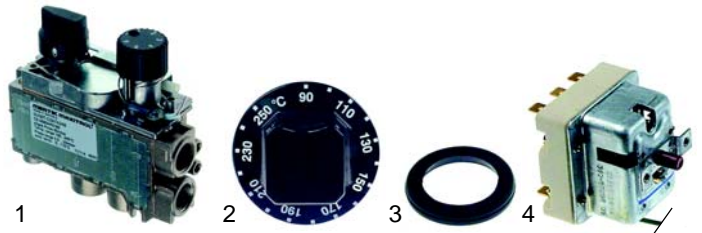

Abb.	B.-Nr.	Beschreibung	Gerätetyp	V.-Nr.
1	100051	Zündbrenner	MMV/G1, MMV/G2, PBRG360, PBRG710	54032
2	100701	Zündkerze		52610
3	102250	Thermoelement, 1000mm		59614

Nudelkocher (Gas)

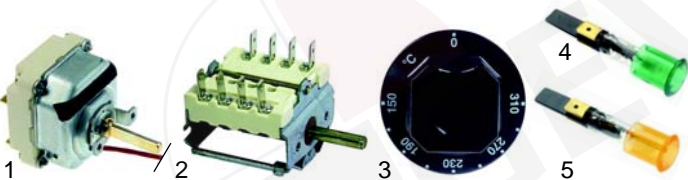

Abb.	Bestell-Nr.	Beschreibung	Gerätetyp	Vergleichs-Nr.
1	375559	Thermostat	NGE400, NGE800	02402
2	300180	Vorsatzschalter		06649
3	111628	Blende		0C0466
4	111602	Knebel		0C0257
5	359364	Signallampe/grün		05010



Abb.	B.-Nr.	Beschreibung	Gerätetyp	Ver.-Nr.
1	105407	Brenner	SCPG350	05794
2	105637	Brenner	MCP/G_, HCP/G_ (ab '95), CCPG_	59523
3	105638	Brenner	MCP/G1, MCP/G2, PCPG350, PCPG700	04726

Z

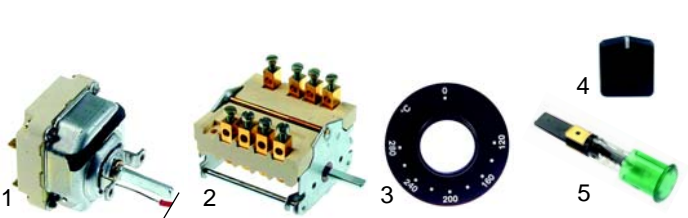
Passend für Zanussi



Abb.	B.-Nr.	Beschreibung	Gerätetyp	Ver.-Nr.
1	105639	Brenner	HCP/G400, HCP/G800	56638
2	105640	Brenner	HCP/G400, HCP/G800 (ab 20.01.'90)	56877
3	105641	Brenner	NCPG_	04847



Abb.	Bestell-Nr.	Beschreibung	Gerätetyp	Vergleichs-Nr.
1	101397	Gashahn		04961
2	110716	Knebel	SCPG350	-
3	100009	Piezozünder		04944

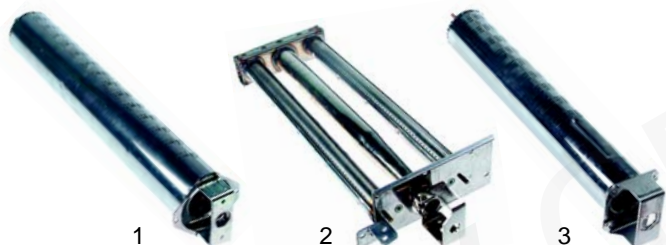

Abb.	Best.-Nr.	Beschreibung	Gerätetyp	Vergl.-Nr.
1	100046	Zündbrenner		04962
2	100706	Zündkerze	SCPG350	56754
3	102121	Thermoelement, 600mm		04955



Abb.	Bestell-Nr.	Beschreibung	Gerätetyp	Vergleichs-Nr.
1	101087	Gashahn		52146
2	110309	Knebel	MCP/G_	58597
3	100012	Piezozünder		02605
4	101339	Abdeckhaube		02816



Abb.	Best.-Nr.	Beschreibung	Gerätetyp	Vergl.-Nr.
1	100054	Zündbrenner		03204
2	100701	Zündkerze	MCP/G	52610
3	102041	Thermoelement, 600mm		25031



Abb.	Bestell-Nr.	Beschreibung	Gerätetyp	Vergleichs-Nr.
1	101087	Gashahn		52146
2	110448	Knebel	MCP/G	59378
3	100012	Piezozünder		02605
4	101339	Abdeckhaube		02816



Abb.	Best.-Nr.	Beschreibung	Gerätetyp	Vergl.-Nr.
1	100051	Zündbrenner		54032
2	100701	Zündkerze	MCP/G	52610
3	102041	Thermoelement, 600mm		25031



Abb.	Bestell-Nr.	Beschreibung	Gerätetyp	Vergleichs-Nr.
1	101103	Babysitventil	HCP/G	56630
2	100007	Piezozünder	(1 Gen.)	52539



Abb.	Best.-Nr.	Beschreibung	Gerätetyp	Vergl.-Nr.
1	100056	Zündbrenner		58146
2	100701	Zündkerze	HCP/G (1 Gen.)	56640
3	102045	Thermoelement, 1500mm		56631



Abb.	Bestell-Nr.	Beschreibung	Gerätetyp	Vergl.-Nr.
1	101087	Gashahn	HCP/G (2 Gen.)	52146
2	110045	Knebel		52138
3	345038	Taster		53978
4	345039	Schutzkappe		53979
5	101002	Zündgruppe		53647



Abb.	Bestell-Nr.	Beschreibung	Gerätetyp	Vergl.-Nr.
1	101956	Novasitventil	NCPG_	02903
2	111646	Knebel		03704
3	101312	Mikroschalter		54339
4	101002	Zündgruppe		04240



Abb.	Best.-Nr.	Beschreibung	Gerätetyp	Vergl.-Nr.
1	100106	Zündbrenner	HCP/G (2 Gen.)	58329
2	100706	Zündkerze		56754
3	102041	Thermoelement, 600mm		25031



Abb.	Best.-Nr.	Beschreibung	Gerätetyp	Vergl.-Nr.
1	100051	Zündbrenner	NCPG	54032
2	100706	Zündkerze		52610
3	102041	Thermoelement, 600mm		25031



Abb.	Bestell-Nr.	Beschreibung	Gerätetyp	Vergl.-Nr.
1	101087	Gashahn	HCP/G (3 Gen.), CCPG_	52146
2	110448	Knebel		59378
3	100012	Piezozünder		02605
4	101339	Abdeckhaube		02816



Abb.	Bestell-Nr.	Beschreibung	Gerätetyp	Vergl.-Nr.
1	301216	Schalter	NCPG	59544
2	111635	Blende		0C0560
3	111602	Knebel		0C0257

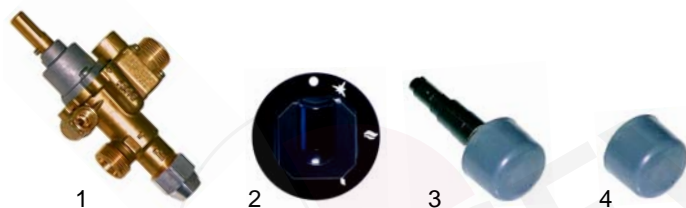

Abb.	Bestell-Nr.	Beschreibung	Gerätetyp	Vergl.-Nr.
1	380015	Energieregler	NCPG	55016
2	111609	Blende		0C0318
3	111602	Knebel		0C0257

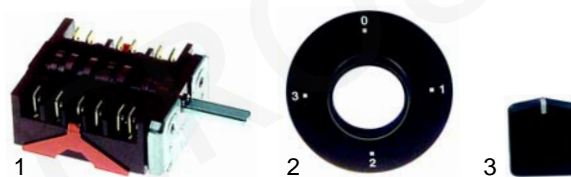

Abb.	Best.-Nr.	Beschreibung	Gerätetyp	Vergl.-Nr.
1	100109	Zündbrenner	HCP/G (3 Gen.), CCPG_	A2472
2	100701	Zündkerze		52610
3	102041	Thermoelement, 600mm		25031

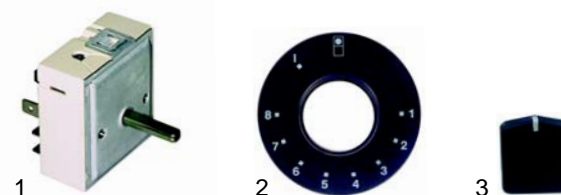

Abb.	Bestell-Nr.	Beschreibung	Gerätetyp	Vergl.-Nr.
1	370336	Magnetventil	NCPG	0C0561
2	541178	Pressostat		49620
3	359364	Signallampe/grün		05010

Z

Passend für Zanussi

Nudelkocher (Gas-Schnellgarsystem)



Abb.	Bestell-Nr.	Beschreibung	Gerätetyp	Vergl.-Nr.
1	415597	3000W/230V	MCP/G, HCP/ G (2 Gen.)	47505
2	510408	O-Ring		46213
3	390038	Thermostat		45169
4	370337	Magnetventil		56872



Abb.	Bestell-Nr.	Beschreibung	Gerätetyp	Vergl.-Nr.
1	301216	Schalter	MCP/G	59544
2	111636	Knebel		03323
3	359364	Signallampe/grün		58658

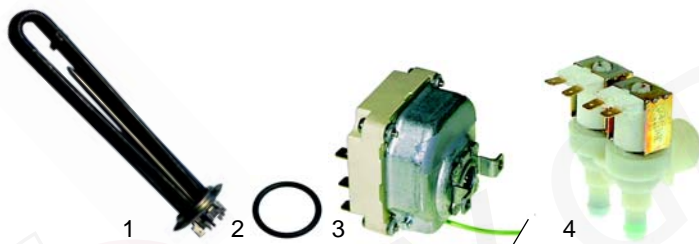

Abb.	Bestell-Nr.	Beschreibung	Gerätetyp	Vergl.-Nr.
1	346298	Schalter	HCP/G (2 Gen.)	56879
2	346297	Schalter		56880
3	345161	Schalter		54518
4	380312	Relais		56466



Abb.	Bestell-Nr.	Beschreibung	Gerätetyp	Vergl.-Nr.
1	301216	Schalter	HCP/G (3 Gen.)	59544
2	111637	Knebel		59546
3	359364	Signallampe/grün		05010



Abb.	Bestell-Nr.	Beschreibung	Gerätetyp	Vergl.-Nr.
1	400991	Niveauregler	Universal	59785
2	361642	Elektrode		59784

Nudelkocher (Elektro)

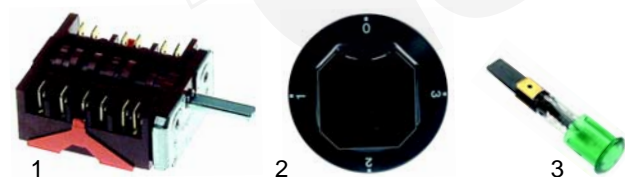

Abb.	B.-Nr.	Beschreibung	Gerätetyp	V.-Nr.
1	416619	1650W/230V	SCPE350	05816
2	415691	1450W/230V	RCP/E700, MCP/E700, MCP/E25, PCPE710, HCP/E400 (ab 01.'90), HCP/E800 (ab 01.'90)	56906
3	416979	1700W/230V	HCP/E400 (ab 03.'92) HCP/E800 (ab 03.'92)	06853
4	416980	1650W/230V	MCP/E25H, PCPE720	06853

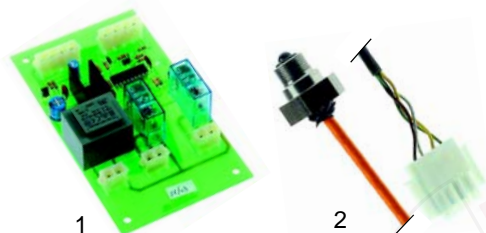

Abb.	B.-Nr.	Beschreibung	Gerätetyp	V.-Nr.
1	416981	1000W/230V	MCP/E1, MCP/E2P, PCPE350, PCPE700	A5492
2	416982	4000W/400V	HCP/E400 (1 Gen.), HCP/E800 (1 Gen.)	56618
3	416980	1650W/230V	NCPE	06853
4	415597	3000W/230V	Universal (Schnellgarsystem)	

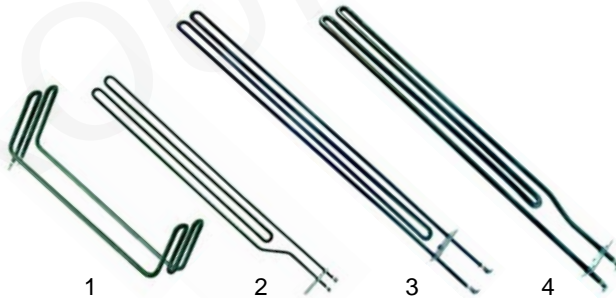

Abb.	Bestell-Nr.	Beschreibung	Gerätetyp	Vergleichs-Nr.
1	300102	Schalter	RCP/E700	50857
2	111638	Knebel		26797
3	301009	Schalter		51647
4	111639	Knebel		51697
5	359109	Signalelement		54150
6	359803	Linse		54151



Abb.	Bestell-Nr.	Beschreibung	Gerätetyp	Vergleichs-Nr.
1	300102	Schalter	MCP/E700	50857
2	110315	Knebel		58629
3	301009	Schalter		51647
4	110347	Knebel		58681
5	359139	Signallampe		58544

Z

Passend für Zanussi

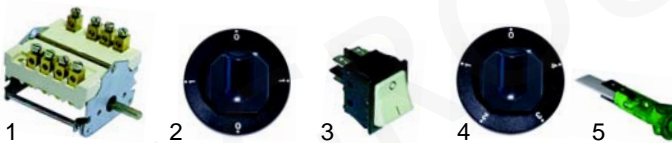

Abb.	B.-Nr.	Beschreibung	Gerätetyp	V.-Nr.
1	301210	Schalter		04741
2	110428	Knebel	MCP/E1S, MCP/E2D,	59230
3	359364	Signallampe	PCPE360, PCPE700	05010
4	375558	Sicherheitsthermostat		04742



Abb.	B.-Nr.	Beschreibung	Gerätetyp	V.-Nr.
1	345254	Mikroschalter		53671
2	601030	Lüfter	MCP/E25H, PCPE720	06878
3	500621	Spindelmotor		06690

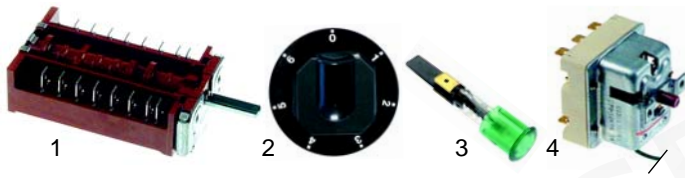

Abb.	B.-Nr.	Beschreibung	Gerätetyp	V.-Nr.
1	301216	Schalter		59544
2	111637	Knebel	MCP/E2S, PCPE710,	59546
3	380015	Energiregler	PCPE25M, PCPE720	55016
4	111640	Knebel		59779

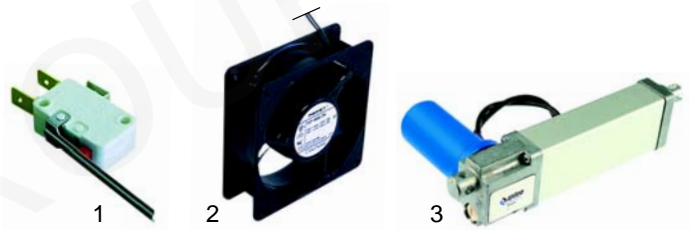

Abb.	B.-Nr.	Beschreibung	Gerätetyp	V.-Nr.
1	380015	Energiregler		55016
2	300002	Vorsatzschalter	HCP/E400 (ab 03.'92), HCP/E800 (ab 03.'92)	A2134
3	111641	Knebel		59067

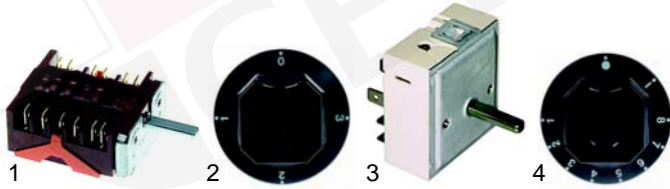

Abb.	B.-Nr.	Beschreibung	Gerätetyp	V.-Nr.
1	350071	Zeitschaltuhr	MCP/E2S, PCPE710	54504
2	350070	Alarmgeber		55368
3	345038	Taster		58274
4	345039	Schutzkappe	MCP/E2S, MCP/E25M, PCPE710, PCPE720	53979
5	359364	Signallampe		05010

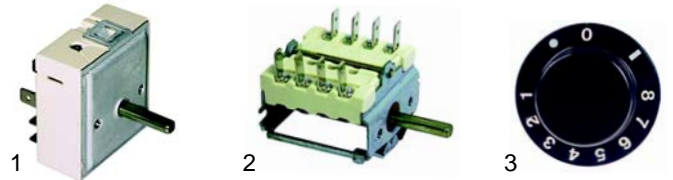

Abb.	B.-Nr.	Beschreibung	Gerätetyp	V.-Nr.
1	346298	Schalter		56879
2	346297	Schalter	HCP/E400 (ab 01.'90), HCP/E800 (ab 01.'90)	56880
3	380312	Relais		56466



Abb.	B.-Nr.	Beschreibung	Gerätetyp	V.-Nr.
1	379567	Elektronikregler		06154
2	379921	Fühler	MCP/E25H, PCPE720	58953
3	400992	PCC-Millennium		06880



Abb.	B.-Nr.	Beschreibung	Gerätetyp	V.-Nr.
1	300102	Schalter		50857
2	110043	Knebel		50341
3	301009	Schalter	HCP/E400 (bis 01.'90), HCP/E800 (bis 01.'90)	51647
4	110042	Knebel		51552
5	359151	Signallampe/grün		53148
6	359150	Signallampe/gelb		53150

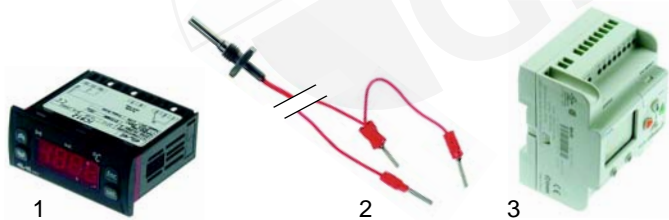

Abb.	B.-Nr.	Beschreibung	Gerätetyp	V.-Nr.
1	379054	Trafo, 230V/12V		A2497
2	379395	Trafo, 240V/24V (200VA)		06159
3	379396	Gleichrichter	MCP/E25H, PCPE720	06147
4	380636	Relais, 24V		56510

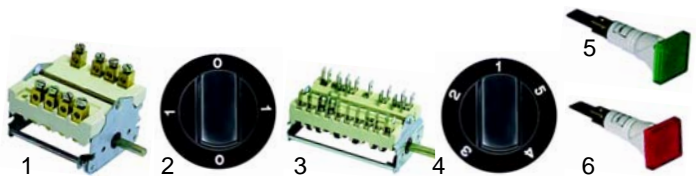

Abb.	B.-Nr.	Beschreibung	Gerätetyp	V.-Nr.
1	301217	Schalter	HCP/E400 (ab 01.'90), HCP/E800 (ab 01.'90)	56907
2	110397	Knebel		52183

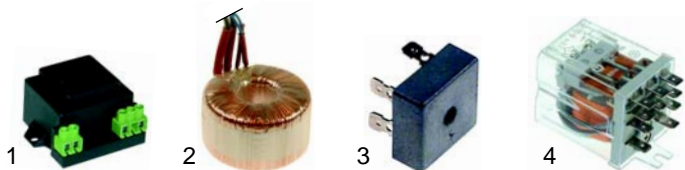

Abb.	Bestell-Nr.	Beschreibung	Gerätetyp	Ver.-Nr.
1	301216	Schalter		59544
2	111637	Knebel	HCP/E400 (ab '95),	59546
3	380015	Energieregler	HCP/E800 (ab '95)	55016
4	111640	Knebel		59779

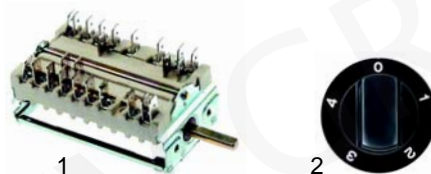

Abb.	Best.-Nr.	Beschreibung	Gerätetyp	Vergl.-Nr.
1	400991	Niveaugler	Universal	59785
2	361642	Elektrode		59784

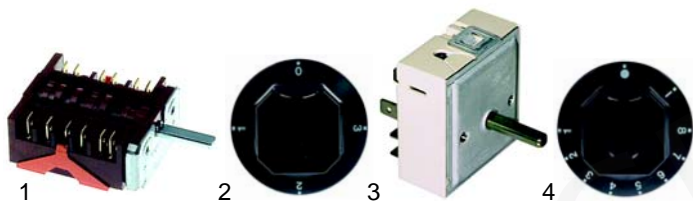

Abb.	B.-Nr.	Beschreibung	Gerätetyp	V.-Nr.
1	375573	Sicherheitsthermostat		59552
2	359364	Signallampe	HCP/E400 (ab '95),	05010
3	370337	Magnetventil	HCP/E800 (ab '95)	56872
4	390038	Thermostat		45169

Nudelkocher (Mechanik)



Abb.	Best.-Nr.	Beschreibung	Gerätetyp	Vergl.-Nr.
1	540927	Auslaufhahn	HCP_, RCPE700,	56885
2	540928	Verlängerung	MCP/G_, MCP/ E_, MCP/E2S,	56985
3	540929	Griff	MCP/E25H, PCPE710/720	56887



Abb.	Bestell-Nr.	Beschreibung	Gerätetyp	Vergl.-Nr.
1	301216	Schalter		59544
2	111635	Blende	NCPE400/410, NCPE800/810	0C0560
3	111602	Knebel		0C0257



Abb.	Best.-Nr.	Beschreibung	Gerätetyp	Vergl.-Nr.
1	540930	Einlaufhahn	MCP/G_ (alt)	03517
2	111642	Knebel		58632

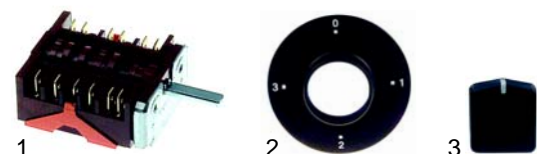

Abb.	Best.-Nr.	Beschreibung	Gerätetyp	Vergl.-Nr.
1	380015	Energieregler		55016
2	111609	Blende	NCPE400/410, NCPE800/810	0C0318
3	111602	Knebel		0C0257



Abb.	Best.-Nr.	Beschreibung	Gerätetyp	Vergl.-Nr.
1	540931	Einlaufhahn		56843
2	540932	Adapter	MCP/G1, MCP/ G2, MCP/E1S,	A2563
3	540933	Verlängerung	MCP/E2D,	A2135
4	111643	Knebel	PCPG350/700, PCPE350/700	04483
5	540934	Auslaufhahn		04729



Abb.	Best.-Nr.	Beschreibung	Gerätetyp	Vergl.-Nr.
1	370336	Magnetventil		0C0561
2	541178	Pressostat	NCPE400/410	49620
3	359364	Signallampe/grün		05010



Abb.	Best.-Nr.	Beschreibung	Gerätetyp	Vergl.-Nr.
1	540935	Einlaufhahn	HCP/_ (bis '90)	56616
2	110287	Knebel		25260
3	540936	Einlaufhahn		25733
4	110287	Knebel	HCP/_ (ab '90)	25260
5	110288	Deckel		54367



Abb.	Best.-Nr.	Beschreibung	Gerätetyp	Vergl.-Nr.
1	540930	Einlaufhahn	HCP/_ (ab '95)	03517
2	111644	Knebel		59531
3	540937	Auslaufhahn		05919
4	540938	Verlängerung		0C0563
5	540939	Griff		56887



Abb.	Best.-Nr.	Beschreibung	Gerätetyp	V.-Nr.
1	970385	145 x 145 x 200mm (1/6R)	SCP/_	05806
2	970386	145 x 145 x 200mm (1/6L)		05807
3	970387	145 x 290 x 200mm (1/3)		05808
4	970388	290 x 290 x 200 (2/3)		25809



Abb.	B.-Nr.	Beschreibung	Gerätetyp	Vergl.-Nr.
1	970392	150 x 275 x 180mm (1/3)	Universal	56915, 0C1340
2	970393	150 x 275 x 180mm (1/3)		56919
3	970394	230 x 275 x 180mm (2/3)		56916, 0C01339
4	970395	480 x 275 x 180mm (1/1)		56921, 56920, 0C1341



Abb.	Best.-Nr.	Beschreibung	Gerätetyp	Vergl.-Nr.
1	970396	Ø135 x 180mm	Universal	56918
2	970397	Ø170 x 180mm		56917
3	970398	165 x 105 x 125mm	MCPE25H, PCPE720	06886
4	970399	275 x 160 x 215mm	CCPG	0G2326



Abb.	Best.-Nr.	Beschreibung	Gerätetyp	Vergl.-Nr.
1	970400	105 x 155 x 265mm	MCP/_1S,	04872
2	970401	105 x 350 x 265mm	MCP/_2D,	04873
3	970402	220 x 350 x 265mm	PCP_350,	04874
4	970403	220 x 170 x 265mm	PCP_700	04875

Bainmarie (Gas)



Abb.	Best.-Nr.	Beschreibg.	Gerätetyp	Vergl.-Nr.
1	104291	Brenner	SMG350, SMG700	04971
2	104587	Brenner	RM/G700, RMV/G700, MM/G70_	50919
3	104588	Brenner	MM/G35_ , RM/G300, RMV/G300	58749, 50918

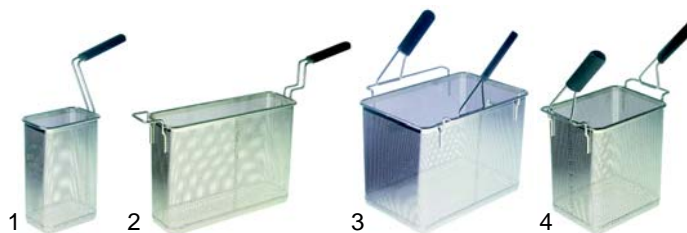

Abb.	Best.-Nr.	Beschreibung	Gerätetyp	Ver.-Nr.
1	104589	Brenner	MBV/G2, PMGV700	A5447
2	104590	Brenner	HMS/G400	51974
3	104591	Brenner	HM_/G800	51975

Z

Passend für Zanussi



Abb.	Best.-Nr.	Beschreibung	Gerätetyp	Ver.-Nr.
1	104592	Brenner	HM/G400, NMG400	59799
2	104593	Brenner	HM/G800, NMG800	59809



Abb.	Best.-Nr.	Beschreibung	Gerätetyp	Vergl.-Nr.
1	101396	Gashahn		04956
2	110710	Knebel	SMG350,	04957
3	100009	Piezozünder	SMG700	04944
4	101264	Unterbrecher, M8 x 1		04982

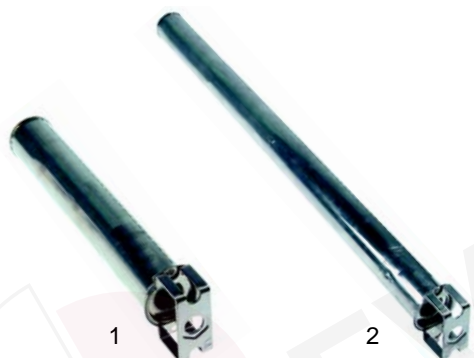

Abb.	Best.-Nr.	Beschreibung	Gerätetyp	Ver.-Nr.
1	100855	Zündbrennerhalter		05618
2	100706	Zündkerze		56754
3	102121	Thermoelement, 600mm	SMG350,	04955
4	375250	Sicherheitsthermostat	SMG700	04931



Abb.	Best.-Nr.	Beschreibung	Gerätetyp	Ver.-Nr.
1	101104	Babysitregler	HM_/G_, RM/G_, RMV/G_, MM/G_	53465
2	100007	Piezozünder	HM_/G_, RM/G_, RMV/G	52539
3	100012	Piezozünder	MM/G_	02605
4	101339	Abdeckhaube		02816

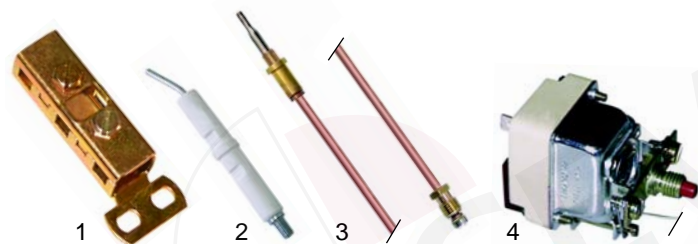

Abb.	Best.-Nr.	Beschreibung	Gerätetyp	Ver.-Nr.
1	100046	Zündbrenner FG		50764
1	100106	Zündbrenner EG	RM/G_, RMV/G_, MM/G_	58329
2	100706	Zündkerze		56754
3	102041	Thermoelement, 600mm		25031



Abb.	Best.-Nr.	Beschreibung	Gerätetyp	Ver.-Nr.
1	nml.	Gasthermostat		04536
2	111645	Knebel	MBV/G2,	04871
3	100012	Piezozünder	PMGV700	02605
4	101339	Abdeckhaube		02816



Abb.	Best.-Nr.	Beschreibung	Gerätetyp	Ver.-Nr.
1	nml.	Gasthermostat		59802
2	110286	Knebel	HM/G400,	59801
3	100012	Piezozünder	HM/G800	02605
4	101339	Abdeckhaube		02816



Abb.	Best.-Nr.	Beschreibung	Gerätetyp	Ver.-Nr.
1	101966	Gasregler		0C0444
2	111650	Blende	NMG400,	0C0503
3	111614	Knebel	NMG800	0C0189
4	111615	Knebel		0C0190

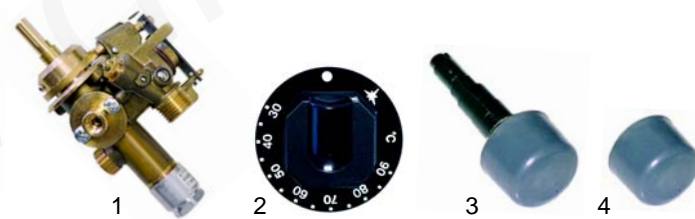

Abb.	Best.-Nr.	Beschreibung	Gerätetyp	Ver.-Nr.
1	100050	Zündbrenner	MBV/G2,	59379
2	100701	Zündkerze	PMGV700,	59380
3	102038	Thermoelement, 1500mm	HM/G ₁ , NMG ₁	51119



Abb.	Best.-Nr.	Beschreibung	Gerätetyp	Ver.-Nr.
1	300102	Schalter, 0 - I		50857
2	110043	Knebel		50341
3	375092	Thermostat, 90°C	HMS/800,	50200
4	110046	Knebel	HMA/800	26915
5	359151	Signallampe/grün		53148
6	359152	Signallampe/gelb		53149

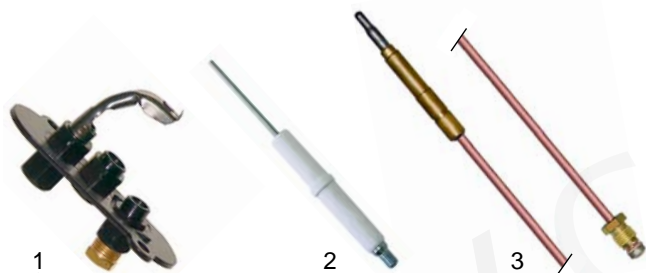

Abb.	Best.-Nr.	Beschreibung	Gerätetyp	Ver.-Nr.
1	300017	Schalter, 0 - I		A2241
2	111651	Knebel	MB/E2,	04566
3	375092	Thermostat, 90°C	MBV/E2,	52000
4	111652	Knebel	PMEV700	04565
5	359364	Signallampe		05010

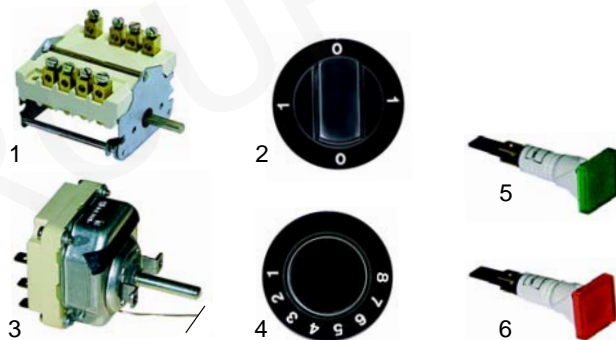

Abb.	Best.-Nr.	Beschreibung	Gerätetyp	Ver.-Nr.
1	390039	Thermostat m. Vorsatzschalter		51142
2	110467	Knebel	HM/E400	59491
3	390165	Sicherheitsthermostat		51644
4	359364	Signallampe		58658

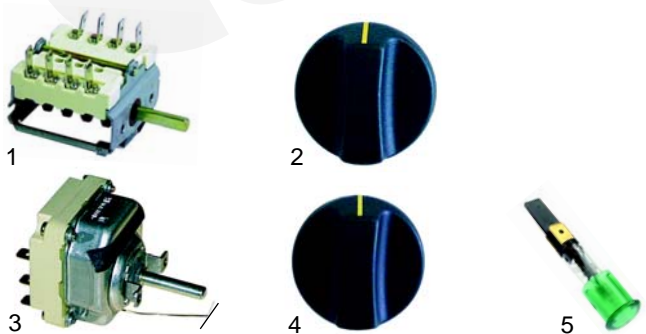

Abb.	Best.-Nr.	Beschreibung	Gerätetyp	Ver.-Nr.
1	300020	Schalter, 0 - I		28390
2	110043	Knebel		50341
3	390040	Thermostat, 90°C	HMS/400	51920
4	110046	Knebel		26915
5	359151	Signallampe/grün		53148
6	359152	Signallampe/gelb		53149

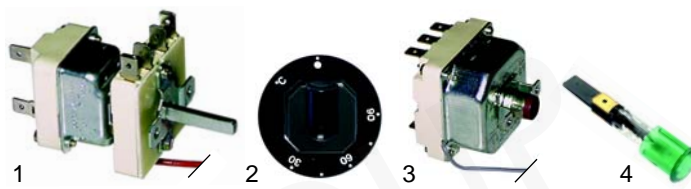

Abb.	Best.-Nr.	Beschreibung	Gerätetyp	Ver.-Nr.
1	300017	Schalter, 0 - I		A2241
2	110449	Knebel	HM/800	59333
3	375092	Thermostat, 90°C		52000
4	110467	Knebel		02386

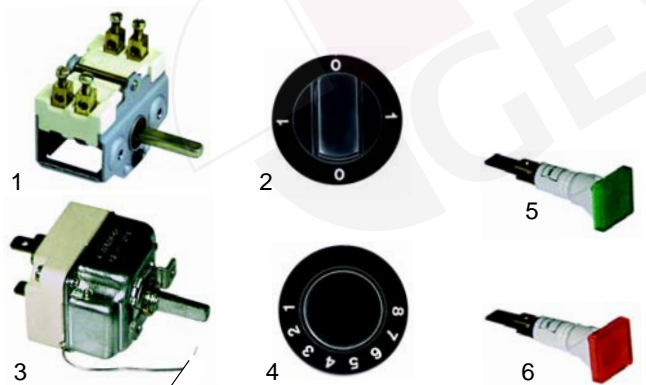

Abb.	Best.-Nr.	Beschreibung	Gerätetyp	Ver.-Nr.
1	390039	Thermostat m. Vorsatzschalter	CMAE400	51142
2	110467	Knebel		02386

Z

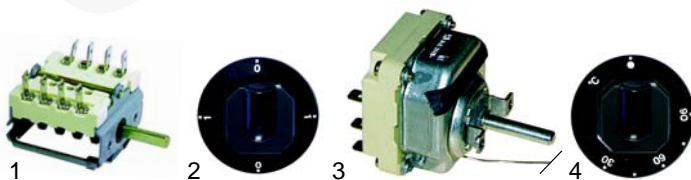
Passend für Zanussi

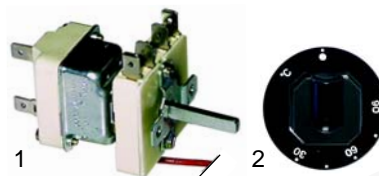

Abb.	Best.-Nr.	Beschreibung	Gerätetyp	Ver.-Nr.
1	390039	Thermostat, 90°C, mit Vorsatzschalter	NME400	51142
2	111653	Blende		0C0515
3	111602	Knebel		0C0257



Abb.	Best.-Nr.	Beschreibung	Gerätetyp	Ver.-Nr.
1	375143	Thermostat, 110°C	SME350, SME700	04911
2	300001	Vorsatzschalter		04908
3	110712	Knebel		04909

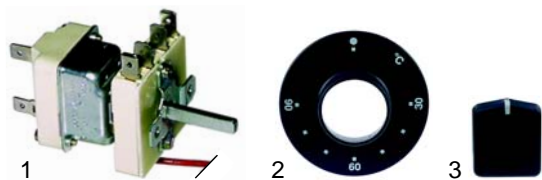

Abb.	Best.-Nr.	Beschreibung	Gerätetyp	Ver.-Nr.
1	300017	Schalter, 0 - I	NME800	A2241
2	111654	Blende		0C0518
3	111602	Knebel		0C0257

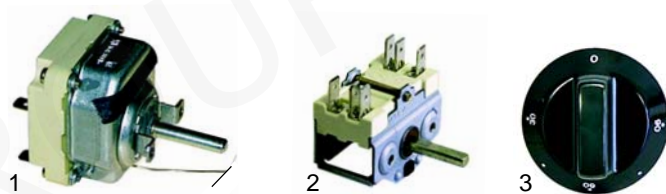

Abb.	Best.-Nr.	Beschreibung	Gerätetyp	Ver.-Nr.
1	375250	Sicherheitsthermostat	SME350, SME700	04912
2	359132	Signalelement		04895
3	359123	Einsteckfassung		04896

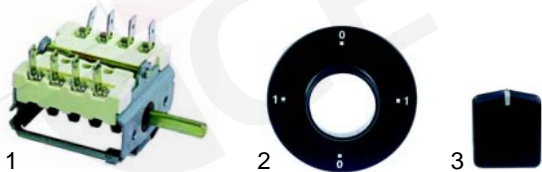

Abb.	Best.-Nr.	Beschreibung	Gerätetyp	Ver.-Nr.
1	375092	Thermostat, 90°C	NME800	52000
2	111653	Blende		0C0515
3	111602	Knebel		0C0257

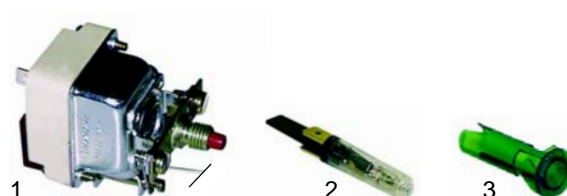

Abb.	Best.-Nr.	Beschreibung	Gerätetyp	Ver.-Nr.
1	390039	Thermostat, 90°C, mit Vorsatzschalter	RM/E300, RMV/E300	51142
2	375092	Thermostat, 90°C	RM/E700, RMV/E700, RMA/E700	52000
3	300080	Vorsatzschalter		26945
4	111629	Knebel		26801

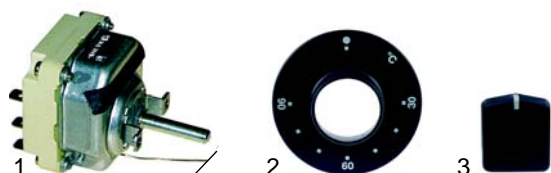

Abb.	Best.-Nr.	Beschreibung	Gerätetyp	Ver.-Nr.
1	375209	Sicherheitsthermostat	NME400, NME800	04862
2	359364	Signallampe		05010

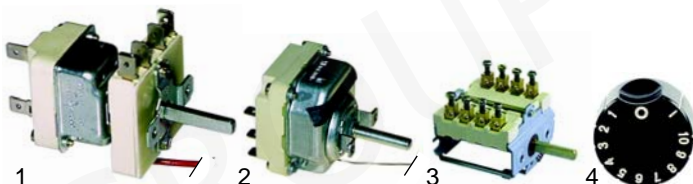

Abb.	Best.-Nr.	Beschreibung	Gerätetyp	Ver.-Nr.
1	359109	Signalelement/grün	RM/E300, RMV/E300, RMA/E300	54150
1	359110	Signalelement/gelb		53811
2	359803	Linse/grün	RMV/E700, RMA/E700	54151
3	359804	Linse/gelb		53812

Bainmarie (Elektro)

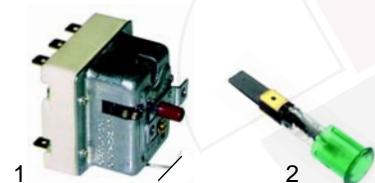

Abb.	Best.-Nr.	Beschreib.	Gerätetyp	Ver.-Nr.
1	415293	1300W/230V	SME350, SME700	04910
2	415353	1500W/230V	RM/E_, RM_/E, NM/E_, MB/E_, MBV/E_, PME700	50933, 50934
3	415074	2300W/230V	HMS/E_, HM/E_, NME/E	51998, 51999
4	415596	1500W/230V	CMAE400	0G2290



Abb.	Best.-Nr.	Beschreibung	Gerätetyp	Ver.-Nr.
1	390039	Thermostat, 90°C, mit Vorsatzschalter	MM/E350	51142
2	110344	Knebel		58651
3	359364	Signallampe		58658

Z

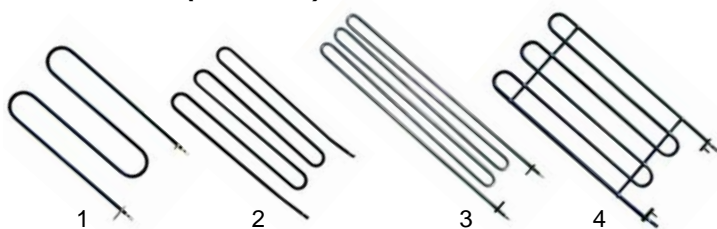
Passend für Zanussi

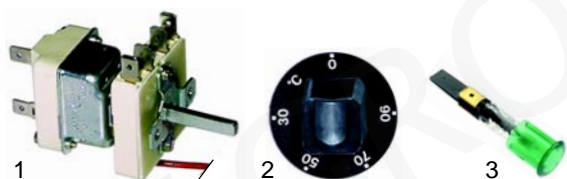

Abb.	Best.-Nr.	Beschreibung	Gerätetyp	Ver.-Nr.
1	375092	Thermostat, 90°C	MM/E700	52000
2	300002	Vorsatzschalter		A2134
3	110345	Knebel		02546
4	359364	Signallampe		58658



Abb.	B.-Nr.	Beschreibung	Gerätetyp	V.-Nr.
1	540963	Ablaufwinkel	MM/_ , MB/E_ , MBV/G2,	58654
2	540964	Auslaufhahn	MBV/E2, PMGV/700,	58647
3	540965	Auslaufrohr	PMEV700	02457

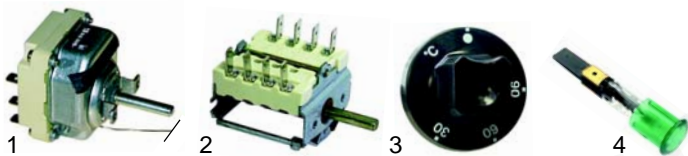

Abb.	Best.-Nr.	Beschreibung	Gerätetyp	Ver.-Nr.
1	390039	Thermostat, 90°C, mit Vorsatzschalter	MB/E1, PME350	51142
2	111652	Knebel		04565
3	359364	Signallampe/grün		05010



Abb.	Best.-Nr.	Beschreibung	Gerätetyp	Ver.-Nr.
1	540931	Einlaufhahn	MBV/G2, MBV/E2, PMGV700, PMEV700	56843
2	540932	Adapter		A2563
3	540933	Verlängerung		A2135
4	111643	Knebel		04483
5	540966	Einlaufrohr		04537

Bainmarie (Mechanik)



Abb.	Best.-Nr.	Beschreibung	Gerätetyp	Ver.-Nr.
1	540259	Auslaufhahn	SMG_ , SME_	05667
2	514027	Hebel		04906
3	110704	Griff		04903
4	514006	Auslaufrohr		05411



Abb.	Best.-Nr.	Beschreibung	Gerätetyp	Ver.-Nr.
1	540967	Überlaufrohr	HMS/E_ , HMS/G_	50301
2	517087	O-Ring		50292
3	540968	Ablaufventil		50288
4	514251	Dichtung		50295
5	514252	Mutter		50287



Abb.	Best.-Nr.	Beschreibung	Gerätetyp	Ver.-Nr.
1	540962	Auslaufhahn	RM/_ , RMV/_	53466
2	111655	Knebel		50908
3	514253	Mutter		51048



Abb.	Best.-Nr.	Beschreibung	Gerätetyp	Ver.-Nr.
1	540773	Einlaufhahn		25733
2	110287	Knebel		25260
3	110288	Deckel		54367



Abb.	Best.-Nr.	Beschreibung	Gerätetyp	Ver.-Nr.
1	540969	Überlaufrohr	HM/G_, HME_, NMG_, NME_	A5181
2	508204	Dichtung		A5182

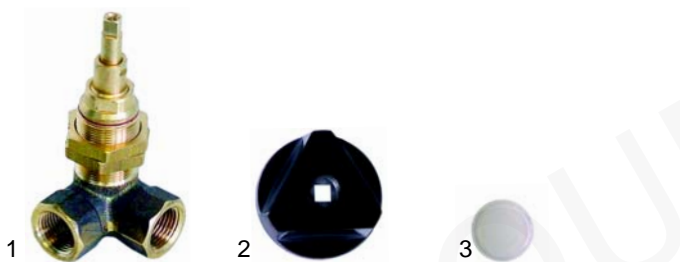

Abb.	Best.-Nr.	Beschreibung	Gerätetyp	Vergleichs-Nr.
1	540970	Auslaufhahn		0G2292, 33143
2	540971	Einlaufhahn	CMAE400	03516
3	111644	Knebel		59531
4	540966	Einlaufrohr		04537

Frittenwärmer (Elektro)

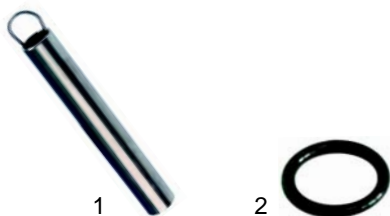

Abb.	B.-Nr.	Beschreib.	Gerätetyp	Ver.-Nr.
1	415103	650W/230V	SCCE350	04898
2	550541	Beschlag	MCC/350, MW/E1, PCCE350	02843



Abb.	Best.-Nr.	Beschreibung	Gerätetyp	Ver.-Nr.
1	380015	Energieregler		05270
2	110708	Knebel	SCCE/350	04897
3	359132	Signalelement		04895
4	359123	Einsteckfassung		04896



Abb.	Best.-Nr.	Beschreibung	Gerätetyp	Ver.-Nr.
1	300074	Schalter	MCC/E350, MW/E1, PCCE350	A2162
2	110315	Knebel	MCC/E350	58629
3	110449	Knebel	MW/E1, PCCE350	59333
4	359364	Signallampe/grün		58658

Friteusen (Gas)

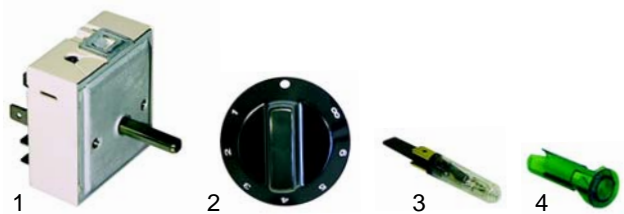

Abb.	B.-Nr.	Beschrbg.	Gerätetyp	V.-Nr.
1	104293	Brenner	SFRG (7 Liter)	04945
2	105642	Brenner	RF/G300 (7 L), MFR/G360 (7 L)	26864
3	105643	Brenner	MFR/G38 (7 L), MF/G_ (7 L), PFRG_ (7 L), MFR/G_ (7 L), CFRG_ (7 L)	03326
4	105644	Brenner	MFR/G_14 (15 L), PFRG (15 L)	05929

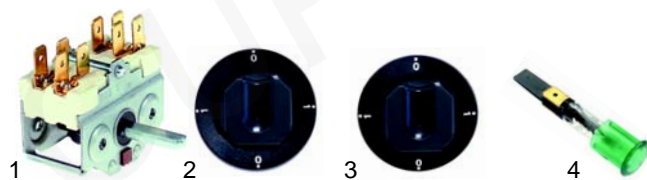

Abb.	B.-Nr.	Beschr.	Gerätetyp	V.-Nr.
1	104228	Brenner	MFR/G350, MFR/G700, HFR/G_ (1.Gen.)	52289
2	105071	Brenner	MFR/G_ (15 L), MFR/G7_ (15 L/40 L), MFR/G_12 (12 L), MFRG_40 (40 L), PFRG740 (40 L), HFR/G (2.Gen.)	59297
3	105645	Brenner	HFH/G_, HFRS/G_, HFR/G430, HFR/G830	06127



Abb.	B.-Nr.	Beschreibung	Gerätetyp	Vergl.-Nr.
1	101188	Eurositregler		04947
2	101711	Adapter	SFRG350, SFRG700	04948, 58773
3	110714	Knebel		05672
4	100009	Piezozünder		04944

Z

Passend für Zanussi



Abb.	Best.-Nr.	Beschreibung	Gerätetyp	Vergl.-Nr.
1	100046	Zündbrenner	SFRG350, SFRG700	04946
2	100706	Zündkerze		56754
3	102041	Thermoelement, 600mm		04942
4	101265	Unterbrecher, M9x1		05687
5	390060	Sicherheitsthermostat		04951



Abb.	Best.-Nr.	Beschreibung	Gerätetyp	Vergl.-Nr.
1	375586	Sicherheitsthermostat	RF/G300, MFR/G360	56435
2	101265	Unterbrecher, M9x1	RF/G300	
3	102040	Thermoelement, 500mm		25204



Abb.	Bestell-Nr.	Beschreibung	Gerätetyp	Vergl.-Nr.
1	101131	Minisitregler	RF/G300, MFR/G360	56434, 56688
2	101137	Abdeckkappe		56577
3	110068	Knebel		54268
4	100007	Piezozünder	RF/G300	52539



Abb.	B.-Nr.	Beschreibung	Gerätetyp	Vergl.-Nr.
1	101437	Minisitregler	RFR/G300	52952, 52685, 52689
2	101136	Piezozünder m. Abdeckkappe	RFR/G700	54269
3	110068	Knebel		54268

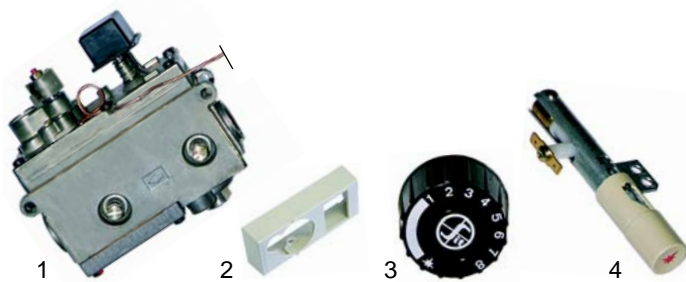

Abb.	B.-Nr.	Beschreibung	Gerätetyp	V.-Nr.
1	101183	Compositventil	RFR/G301, RFR/G701,	53973
2	101001	Zündgruppe, 1 Ausgang	MFR/G350, MFR/G700,	53647
2	101002	Zündgruppe, 2 Ausgänge	PFRG350/700	51884

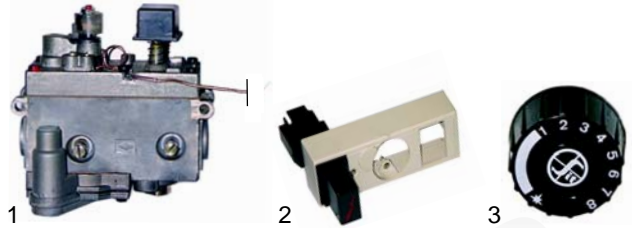

Abb.	Best.-Nr.	Beschreibung	Gerätetyp	Vergl.-Nr.
1	100012	Piezozünder	MFR/G360	02605
2	101339	Abdeckhaube		02816
3	100046	Zündbrenner FG	RF/G300	50813
3	100106	Zündbrenner EG	MFR/G360	58329
4	102250	Thermoelement, 1000mm		56914



Abb.	Best.-Nr.	Beschreibung	Gerätetyp	Vergl.-Nr.
1	345161	Schalter	RFR/G301, RFR/G701,	54518
2	345038	Taster	MFR/G350, MFR/G700,	53978
3	345039	Haube	PFRG350/700	53979



Abb.	Best.-Nr.	Beschreibung	Gerätetyp	Vergl.-Nr.
1	390053	Thermostat		50412
2	111629	Knebel	RFR/G301,	26801
3	359110	Signalelement	RFR/G701	53811
4	359804	Linse		53812



Abb.	Bestell-Nr.	Beschreibung	Gerätetyp	Vergl.-Nr.
1	390053	Thermostat	MFR/G350, MFR/G700, PFRG350/700	50412
2	110314	Knebel		58591
3	359365	Signallampe		58659



Abb.	Best.-Nr.	Beschreibung	Gerätetyp	Vergl.-Nr.
1	100836	Oberteil	RFR/G300, RFR/G700, RFR/G301,	52280
2	100855	Halter		52246+52256
3	100882	Unterteil 0,25	RFR/G701,	52281
3	100833	Unterteil 0,35	MFR/G350, MFR/G700,	52686
4	100708	Zündkerze	PFRG350/700	52610



Abb.	B.-Nr.	Beschreibung	Gerätetyp	Ver.-Nr.
1	102250	Thermoelement m. Unterbrechung	RFR/G300, RFR/G700	56914 51932
2	102070	Thermoelement m. Unterbrechung	RFR/G301, RFR/G701, MFR/G350, MFR/G700, PFRG350/700	54055
3	375108	Sich.-thermostat	RFR/G __, MFR/G350, MFR/G700, PFRG350/700	52331

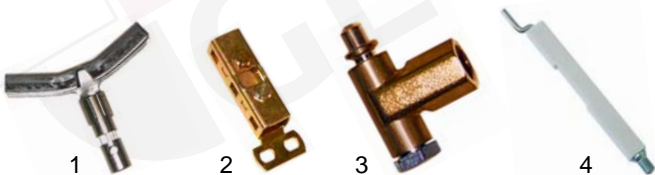

Abb.	B.-Nr.	Beschreibg.	Gerätetyp	Ver.-Nr.
1	101188	Eurositregler		03334
2	110358	Adapter	MFR/G380, MFR/G381, MFR/G350, MFR/G351,	03391
3	110282	Knebel	MFR/G700, MFRG701, PFRG350/381/700/731, CFRG40M/80M	03392
4	100012	Piezozünder		02605
5	101339	Abdeckhaube		02816

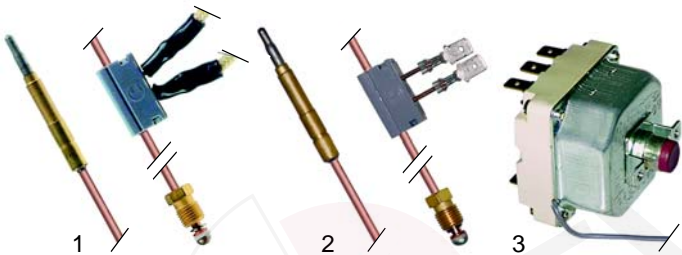

Abb.	B.-Nr.	Beschr.	Gerätetyp	Vergl.-Nr.
1	100836	Oberteil	MFR/G350, MFR/G700, MFR/G351, MFR/G701	52280
2	102662	Oberteil	MFR/G380, MFR/G381, PFRG381/731, CFRG40M/80M	03328
3	100855	Halter	MFR/G380, MFR/G381, MFR/G350, MFR/G351, MFR/G700, MFRG701,	52246+52256 52686
5	100706	Zündkerze	PFRG350/381/700/731, CFRG40M/80M	59380



Abb.	B.-Nr.	Beschreibg.	Gerätetyp	V.-Nr.
1	102250	Thermoelement m. Unterbrecher	MFR/G380, MFR/G381, PFRG381/731	56914
2	102070	Thermoelement m. Unterbrecher	MFR/G350, MFR/G351, MFR/G700, MFRG701, PFRG350/700, CFRG40M/80M	54055
3	390509	Sich.-thermostat	MFR/G __, PFRG __, CFRG __	03329



Abb.	Best.-Nr.	Beschreibung	Gerätetyp	Vergl.-Nr.
1	101187	Novasitventil (mV)		02606
2	101800	Verlängerung		02604
3	111656	Knebel	MFR/G740 PFRG740	02603
4	100012	Piezozünder		02605
5	101339	Abdeckhaube		02816

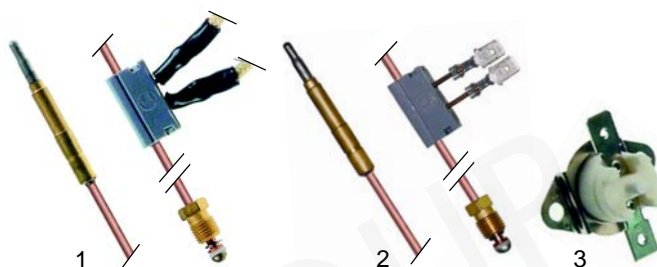

Abb.	Best.-Nr.	Beschreibung	Gerätetyp	Vergl.-Nr.
1	375583	Thermostat		02602
2	110314	Knebel	MFR/G740 PFRG740	58591
3	375108	Sich.-thermostat		52331



Abb.	Bestell-Nr.	Beschreibung	Gerätetyp	Vergl.-Nr.
1	102816	Oberteil	MFR/G740 PFRG740	03394
2	100855	Halter		52246+52256
3	100883	Unterteil		52686
4	100708	Zündkerze		52610



Abb.	B.-Nr.	Beschreibung	Gerätetyp	Vergl.-Nr.
1	375108	Sich.-thermostat	HFR/G420/421/840, HFR/G420D/840D	52331
2	101002	Zündgruppe		53647, 51884
3	102250	Thermoelement		51632, 56914

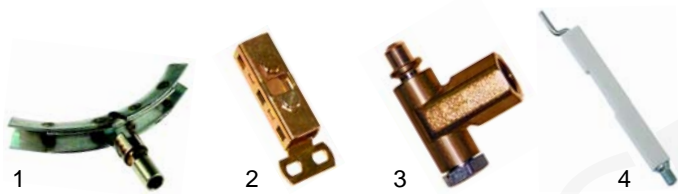

Abb.	Best.-Nr.	Beschreibung	Gerätetyp	Vergl.-Nr.
1	102070	Thermoelement	MFR/G740	54055
2	102116	Thermogenerator	PFRG740	02607

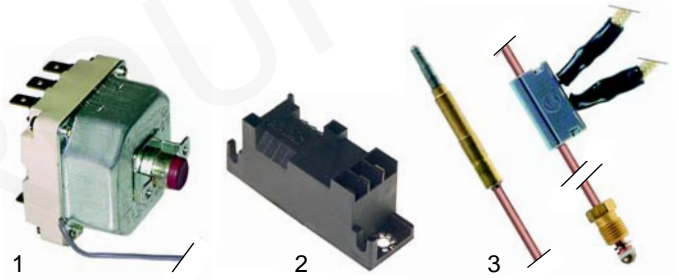

Abb.	B.-Nr.	Beschreibung	Gerätetyp	Vergl.-Nr.
1	100836	Oberteil	HFR/G420 HFR/G421 HFR/G840 HFR/G420D HFR/G840D	52280
2	100855	Halter		52246+52256
3	100882	Unterteil 0,25		52281
3	100883	Unterteil 0,35		52686
4	100708	Zündkerze		52610

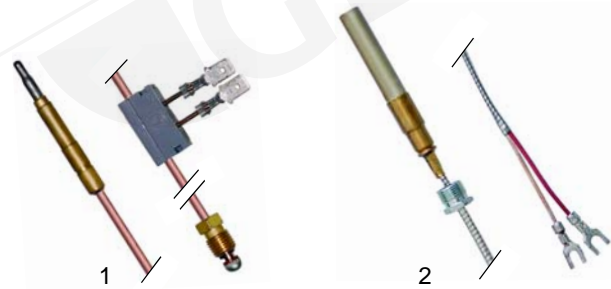

Abb.	B.-Nr.	Beschreibung	Gerätetyp	Ver.-Nr.
1	101127	Elettrosolenventil	HFR/G420/421/840, HFR/G420D/840D	57543
2	101309	Verlängerung		51281
3	111657	Blende	HFR/G420/421/840	52272
4	111658	Blende	HFR/G420D7=40D	53105

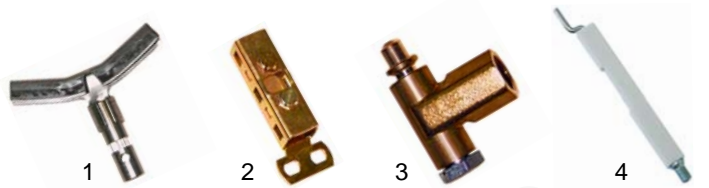

Sit 820031

Abb.	Best.-Nr.	Beschreibung	Gerätetyp	Ver.-Nr.
1	101956	Novasitventil	HFR/G410-412,	02903
2	101928	Adapter	HFR/G810, HFR/G410D	59305
3	111534	Knebel	HFR/G810D	59304
4	101312	Mikroschalter	HFH/G430, HFH/G435	54539
5	111646	Knebel	NFRG430/435/440	03704

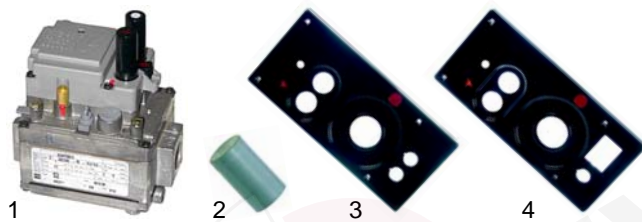

Abb.	B.-Nr.	Beschreibung	Gerätetyp	Ver.-Nr.
1	359151	Signallampe	HFR/G_	53148, 53154
2	359152	Signallampe	HFR/G420/421/840	53149, 53155
3	345983	Schalter	HFR/G_D	53810



Abb.	Bestell-Nr.	Beschreibung	Gerätetyp	Vergleichs-Nr.
1	390049	Thermostat	HFR/G_	52330
2	390056	Thermostat	HFR/G_D	51361
3	110046	Knebel		26915



Abb.	Best.-Nr.	Beschreibung	Gerätetyp	Vergl.-Nr.
1	101979	Gasregler		06574
2	111660	Knebel	HFR/G430 HFR/G830	06570
3	375585	Sich.-thermostat	HFRS/G430	06282
4	102070	Thermoelement		54055

Z

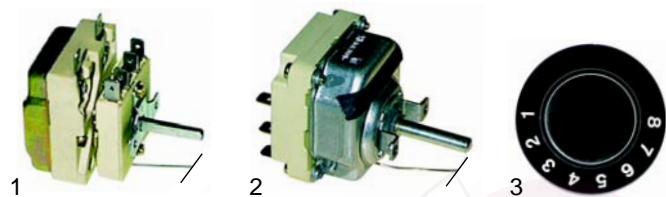
Passend für Zanussi

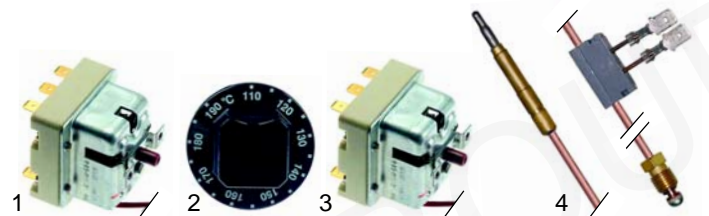

Abb.	Bestell-Nr.	Beschreibung	Gerätetyp	Vergl.-Nr.
1	101982	Gasregler		0C0624
2	111661	Blende	NFRG400/800	0C0623
3	111614	Knebel	NFRG420/820	0C0189
4	111615	Knebel		0C0190



Abb.	Bestell-Nr.	Beschreibung	Gerätetyp	Vergl.-Nr.
1	102664	Oberteil		59301
2	100855	Halter	HFR/G410-412 HFR/G810	52246+52256
3	100883	Unterteil 0,35	HFR/G410D	25686
4	100708	Zündkerze	HFR/G810D	52610



Abb.	Best.-Nr.	Beschreibung	Gerätetyp	Vergl.-Nr.
1	375585	Sich.-thermostat	NFRG400/800	06282
2	102070	Thermoelement	NFRG420/820	54055



Abb.	Best.-Nr.	Beschreibung	Gerätetyp	Vergl.-Nr.
1	379567	Elektr. Thermostat		06154
2	379924	Fühler	HFH/G430	06155
3	380380	Zeitrelais		06156



Abb.	B.-Nr.	Beschreibung	Gerätetyp	Ver.-Nr.
1	375584	Thermostat	HFR/G410-412, HFR/G810	03049
2	390049	Thermostat	HFR/G410D, HFR/G810D	52330
3	111659	Knebel	HFR/G410-412, HFR/G810,	59303
4	359364	Signallampe grün	HFR/G410D	05010
5	359365	Signallampe gelb	HFR/G810D	05011



Abb.	Best.-Nr.	Beschreibung	Gerätetyp	Vergl.-Nr.
1	301216	Schalter		59544
2	300001	Vorsatzschalter	HFH/G430	A2036
3	111662	Knebel		06144
4	359364	Signallampe/grün		05010
5	359365	Signallampe/gelb		05011

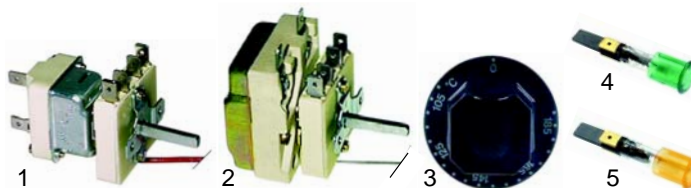

Abb.	B.-Nr.	Beschreibung	Gerätetyp	Ver.-Nr.
1	375586	Sich.-thermostat	HFR/G410-412, HFR/G810	A5435
2	375108	Sich.-thermostat	HFR/G410D, HFR/G810D	52331
3	102070	Thermoelement	HFR/G410-412, HFR/G810	54055
4	101002	Zündgruppe	HFR/G410D, HFR/G810D	033076 51884

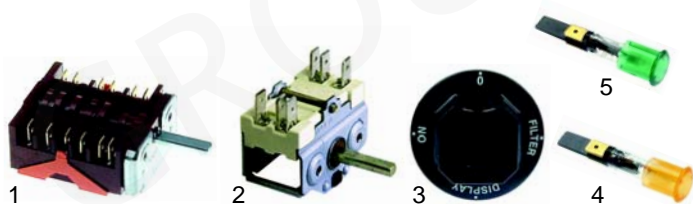

Abb.	Best.-Nr.	Beschreibung	Gerätetyp	Vergl.-Nr.
1	400994	Frontfolie		06608
2	400741	Elekt. Tastatur	HFH/G435	06644
3	400996	Hauptplatine		06624
4	379918	Fühler		06609
5	400997	Taste		02670

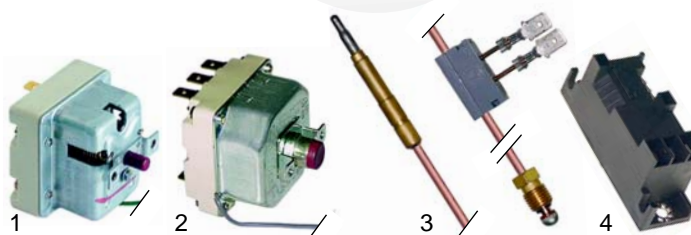

Abb.	Bestell-Nr.	Beschreibung	Gerätetyp	Vergl.-Nr.
1	400998	Frontfolie	NFRG430	0C1015
2	400999	Frontfolie	NFRG435	0C1016
3	400994	Frontfolie	NFRG440	06608

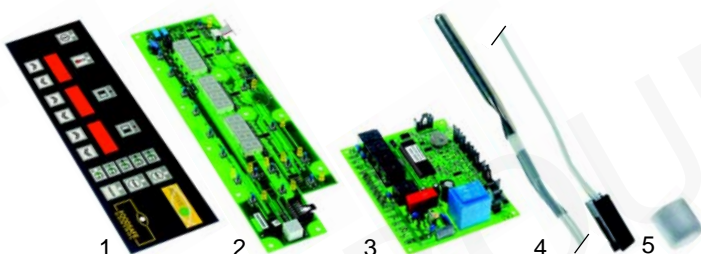

Abb.	Best.-Nr.	Beschreibung	Gerätetyp	Vergl.-Nr.
1	400741	Elektronik-Tastatur		06803
2	400996	Hauptplatine	NFRG430	06624
3	379918	Fühler	NFRG435	06609
4	400997	Taste	NFRG440	02670

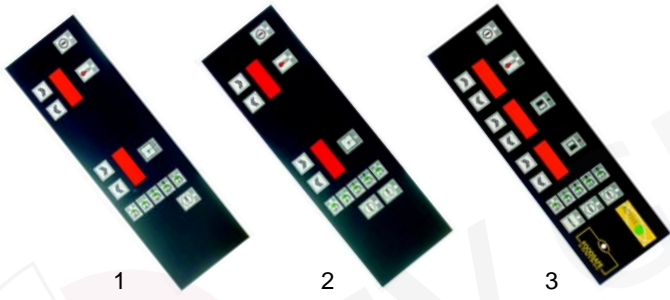

Abb.	Best.-Nr.	Beschreibung	Gerätetyp	Vergl.-Nr.
1	379395	Transformator	HFH/G430	06159
2	379396	Gleichrichter	HFH/G435	06147
3	380636	Relais	NFRG430	56510
4	601130	Ventilator	NFRG435	06125

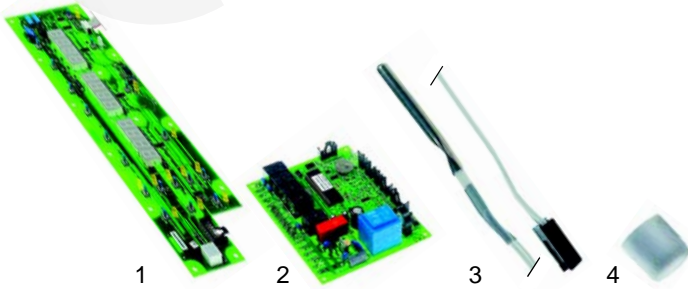

Abb.	Best.-Nr.	Beschreibung	Gerätetyp	Vergl.-Nr.
1	345254	Mikroschalter	HFH/G430	53671
2	375585	Sich.-thermostat	HFH/G435	06282
3	101002	Zündgruppe	NFRG430	04240
4	102070	Thermoelement	NFRG435	54055

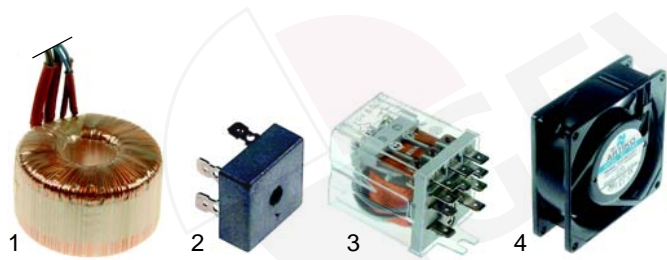

Abb.	B.-Nr.	Beschreibung	Gerätetyp	Vergl.-Nr.
1	102665	Oberteil	HFH/G430, HFH/G435	06128
2	100855	Halter	HFR/G430, HFR/G830	52246+52556
3	100880	Unterteil	HFRS/G430	06725
4	100708	Zündkerze	NFRG420/820	59380

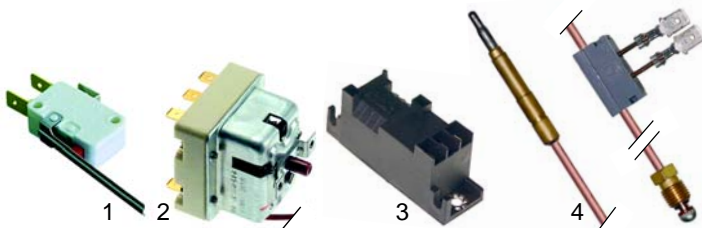

Abb.	Bestell-Nr.	Beschreibung	Gerätetyp	Vergl.-Nr.
1	102663	Oberteil		A5441
2	100855	Halter		52246+52556
3	100880	Unterteil	NFRG400/800	06725
4	100708	Zündkerze		59380

Friteusen (Elektro)

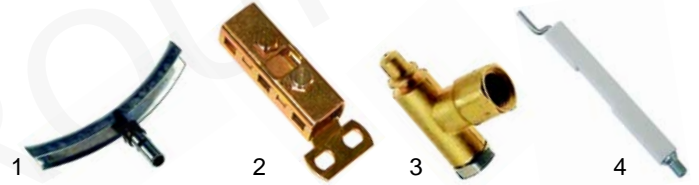

Abb.	B.-Nr.	Beschreibung	Gerätetyp	Vergl.-Nr.
1	415291	2000W/230V	SFRE350/700	04926
2	415354	1500W/230V	RFR/E302, RFR/E312, MFR/E370	54951 58612
3	415274	3000W/230V	RFR/E305, RFR/E701, RFR/E315, RFR/E711, MFR/E350, MFR/E700	54962 58615

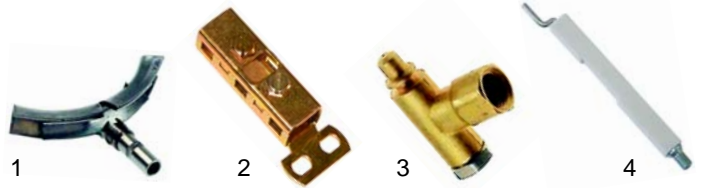

Abb.	Best.-Nr.	Beschreibg.	Gerätetyp	Ver.-Nr.
1	416992	9500W/230V	MFR/E305, MFR/E306, MFR/E705, MFR/E706, MFR/E740	54923
2	416993	1500W/230V	MF/1D05, PFRE370	04752
3	416994	2900W/230V	MF/E1S12, MF/E2D12, PFRE350/700	05964



Abb.	B.-Nr.	Beschreibg.	Gerätetyp	Ver.-Nr.
1	416995	2900W/230V	MFR/E1S12, MFR/E2D12, PRFE360/700	A5565
2	416996	2900W/230V	MFR/E2S40, PRFE740	04767
3	416997	4000W/230V	HFR/E420, HFR/E840	52326, 52327



Abb.	B.-Nr.	Beschreibg.	Gerätetyp	V.-Nr.
1	416998	2700W/230V	MF/E1S08, MF/E2D08, MF/E1S07, MF/E2D07, PFRE381T/731T, MFR/E1S07, MFR/E1S08, MFR/E2D07, MFR/E2D08, PFRE381/731	04755
2	416999	5000W/230V	MFR/E1S14, MFR/E2D14, PFRE355/705, NFRE400/800	05942
3	418000	5000W/400V	HFH/E430, HFH/E435, HFR/E430, HFR/830, NFRE420/820, NFRE430/435/440	06158

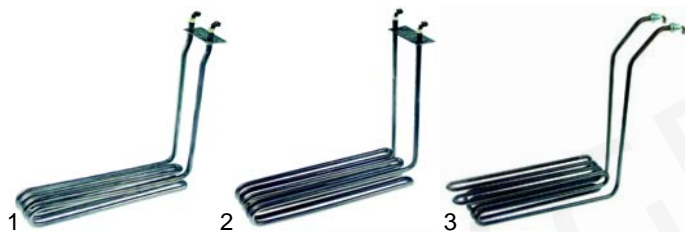

Abb.	B.-Nr.	Beschreibg.	Gerätetyp	V.-Nr.
1	418001	5000W/230V	HFR/E421	54650
2	415377	5500W/230V	HFR/E410-412/ HFR/E418/810/818	59563
3	418002	5500W/230V	HFR/E431/831, NFRE410/810	06571

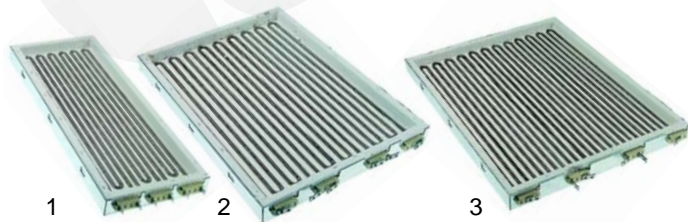

Abb.	Bestell-Nr.	Beschreibung	Gerätetyp	Vergl.-Nr.
1	390056	Thermostat		04925
2	300001	Vorsatzschalter	SFRE350 SFRE700	04908
3	110715	Knebel		04924



Abb.	B.-Nr.	Beschreibung	Gerätetyp	Vergl.-Nr.
1	390113	Sich.-thermostat		04921
2	345127	Mikroschalter		04927
3	359132	Signalelement/grün	SFRE350	04895
3	359130	Signalelement/gelb	SFRE700	-
4	359123	Einsteckfassung/grün		04896
5	359124	Einsteckfassung/gelb		04928

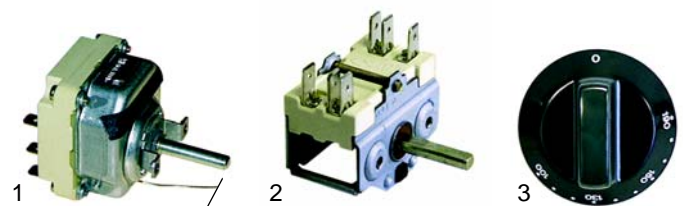

Abb.	B.-Nr.	Beschreibung	Gerätetyp	Vergl.-Nr.
1	390056	Thermostat		51361
2	111617	Knebel	RFR/E302, RFR/E305, RFR/E701, RFR/E312, RFR/E315, RFR/E711	53867
3	300102	Schalter		50857
4	111638	Knebel		26797

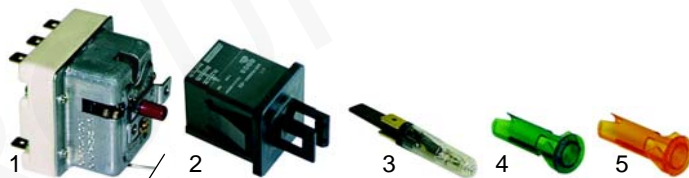

Abb.	B.-Nr.	Beschreibung	Gerätetyp	Vergl.-Nr.
1	375641	Sich.-thermostat		54932
2	345254	Mikroschalter		53671
3	380204	Schütz	RFR/E302, RFR/E305,	75796
4	359110	Signalelement/gelb	RFR/E701, RFR/E312,	53811
4	359109	Signalelement/grün	RFR/E315, RFR/E711	54150
5	359804	Linse/gelb		53812
6	359803	Linse/grün		54151

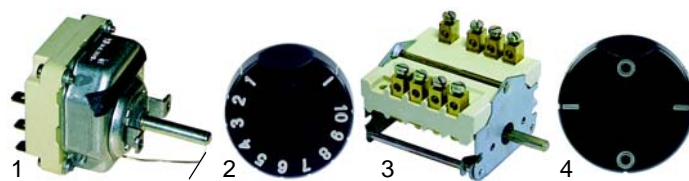

Abb.	Bestell-Nr.	Beschreibung	Gerätetyp	Vergl.-Nr.
1	390052	Thermostat	MFR/E350,	52330
2	110314	Knebel	MFR/E370,	58591
3	375641	Sich.-thermostat	MFR/E700	54932

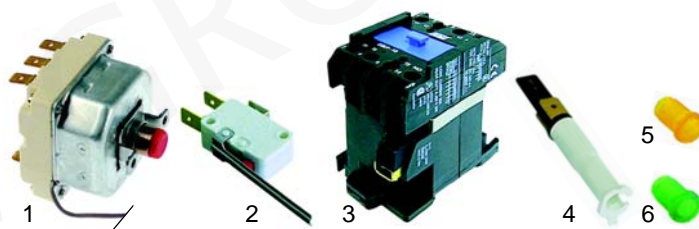

Abb.	Bestell-Nr.	Beschreibung	Gerätetyp	Vergleichs-Nr.
1	345254	Mikroschalter		53671
2	380204	Schutz	MFR/E350, MFR/E370,	75796
3	359364	Signallampe/grün	MFR/E700	58658
4	359365	Signallampe/gelb		58659

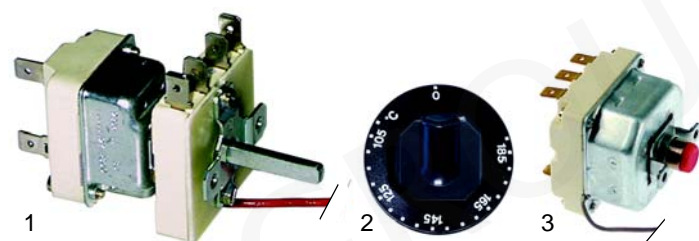

Abb.	B.-Nr.	Beschreibung	Gerätetyp	V.-Nr.
1	390052	Thermostat	MF/E1D05, MF/E1S12,	52330
2	111664	Knebel	MF/E2D12, MFR/E1S12,	04783
3	111659	Knebel	MFR/E2D12, MFR/E2S40,	59303
4	375578	Sich.-thermostat	PFRE370/350/700/360/710/740	04472

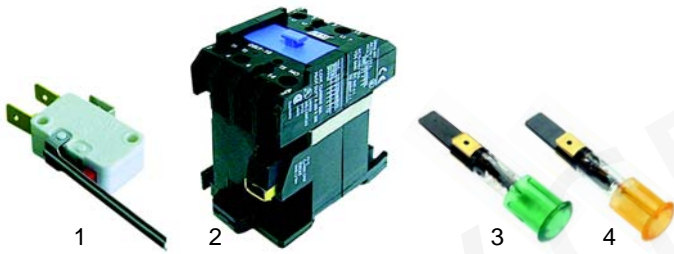

Abb.	Bestell-Nr.	Beschreibung	Gerätetyp	Vergleichs-Nr.
1	390056	Thermostat		51361
2	111663	Knebel	MFR/E355, MFR/E705	59196
3	300102	Schalter		50857
4	110315	Knebel		58629



Abb.	B.-Nr.	Beschreibung	Gerätetyp	V.-Nr.
1	345032	Mikroschalter	MF/E1D05, MF/E1S12,	02785
2	380204	Schütz	MF/E2D12, MFR/E1S12,	82986
3	359364	Signallampe/grün	PFRE370/350/700/360/710/740	05010
4	359365	Signallampe/gelb		05011



Abb.	Bestell-Nr.	Beschreibung	Gerätetyp	Vergleichs-Nr.
1	390052	Thermostat	MFR/E740	52330
2	110314	Knebel		58591

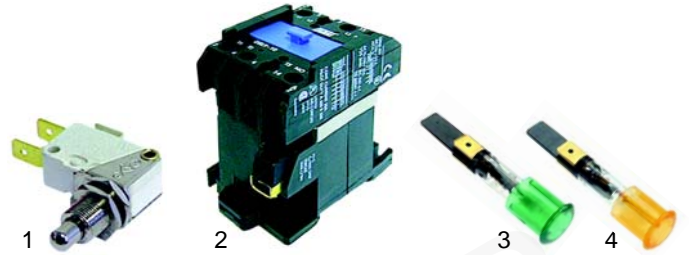

Abb.	B.-Nr.	Beschreibg.	Gerätetyp	V.-Nr.
1	375576	Thermostat	MF/E1S07, MF/E2D07,	05940
2	300001	Vorsatzschalter	MFR/E1S07, MFR/E2D07	A2036
3	111659	Knebel	MFR/E1S14, MFR/E2D14, PFRE381T/731T/381/731/355/705	59303

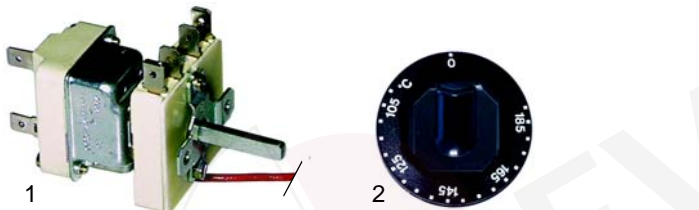

Abb.	Bestell-Nr.	Beschreibung	Gerätetyp	Vergleichs-Nr.
1	390087	Sich.-Thermostat	MFR/E355,	51369
2	359364	Signallampe/grün	MFR/E705, MFR/E740	58658
3	359365	Signallampe/gelb		58659
4	345032	Mikroschalter		02785
5	380637	Schütz		54928

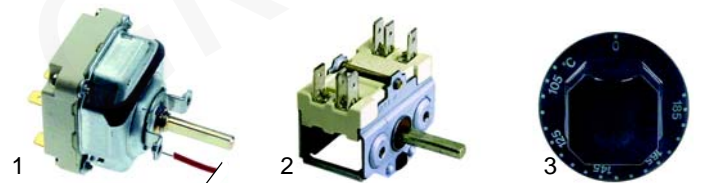

Abb.	B.-Nr.	Beschreibg.	Gerätetyp	V.-Nr.
1	375580	Sich.-thermostat	MF/E1S07, MF/E2D07,	05941
2	359364	Signallampe/grün	MFR/E1S07, MFR/E2D07	05010
3	359365	Signallampe/grün	MFR/E1S14, MFR/E2D14, PFRE381T/731T/381/731/ 355/705	05011



Abb.	B.-Nr.	Beschreibung	Gerätetyp	Ver.-Nr.
1	390056	Thermostat		51361
2	300001	Vorsatzschalter	MF/E1S08, MF/E2D08, MFR/E1S08, MFR/E2D02	A2036
3	111664	Knebel		04783



Abb.	B.-Nr.	Beschreibung	Gerätetyp	Ver.-Nr.
1	390509	Sich.-thermostat		03329
2	380204	Schütz	MF/E1S08, MF/E2D08, MFR/E1S08, MFR/E2D02	82986
3	359364	Signallampe/grün		05010
4	359365	Signallampe/gelb		05011

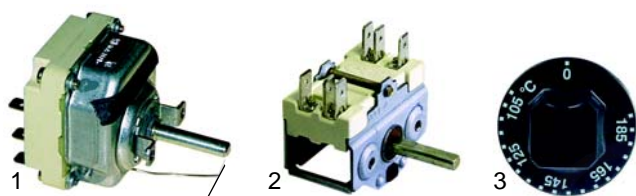

Abb.	Bestell-Nr.	Beschreibung	Gerätetyp	Vergleichs-Nr.
1	390052	Thermostat	HFR/E420,	52330
2	110046	Knebel	HFR/E421,	26915
3	390087	Sich.-thermostat	HFR/E840	51369

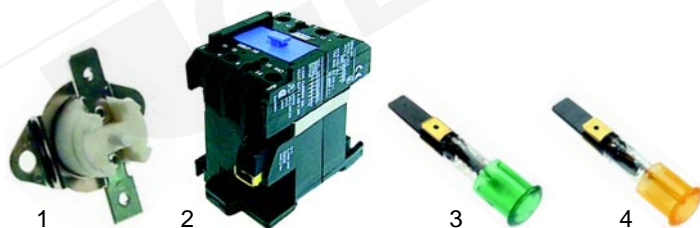

Abb.	Bestell-Nr.	Beschreibung	Gerätetyp	Vergleichs-Nr.
1	345254	Mikroschalter		53671
2	380637	Schütz	HFR/E420, HFR/E421,	54928
3	359151	Signallampe/grün	HFR/E840	53148
4	359152	Signallampe/gelb		53149

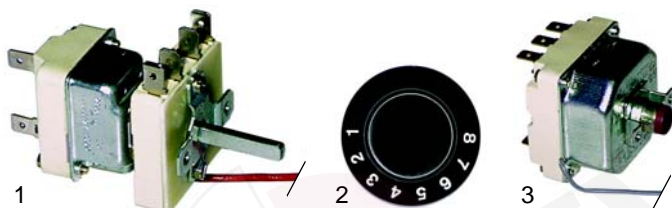

Abb.	Bestell-Nr.	Beschreibung	Gerätetyp	Vergleichs-Nr.
1	350071	Zeitschalter		54504
2	345038	Taster	HFR/G421	53978
3	345039	Haube		53979
4	359110	Signalelement		53811
5	359804	Linse		53812



Abb.	B.-Nr.	Beschreibg.	Gerätetyp	Ver.-Nr.
1	390052	Thermostat		52330
2	111659	Knebel	HFR/E410-412, HFR/E810, HFR/E418, HFR/E818,	59303
3	375578	Sich.-thermostat	HFR/E430, HFR/E830,	04472
4	359364	Signallampe/grün	HFRS/E430-431, HFRS/E831	05010
5	359365	Signallampe/gelb		05011



Abb.	B.-Nr.	Beschreibg.	Gerätetyp	Ver.-Nr.
1	345254	Mikroschalter	HFR/E410-412, HFR/E810, HFR/E418, HFR/E818,	53671
2	380244	Schütz	HFR/E410-412, HFR/E810	03598
3	380637	Schütz	HFR/E418, HFR/E818, HFR/ E430, HFR/E830, HFRS/E430-431, HFRS/E831	54928
4	601130	Ventilator	HFR/E430, HFR/E830, HFRS/E430-431, HFRS/E831	06125

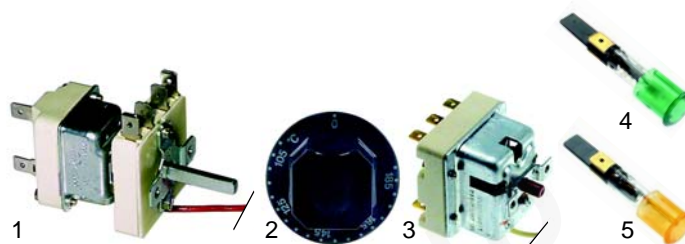

Abb.	Bestell-Nr.	Beschreibung	Gerätetyp	Ver.-Nr.
1	390052	Thermostat		52330
2	111665	Blende	NFRE400/410/420, NFRE800/810/820	0C0615
3	111602	Knebel		0C0257



Abb.	Bestell-Nr.	Beschreibung	Gerätetyp	Vergleichs-Nr.
1	379567	Elektr. Thermostat	HFH/E430	06154
2	379924	Fühler		06155

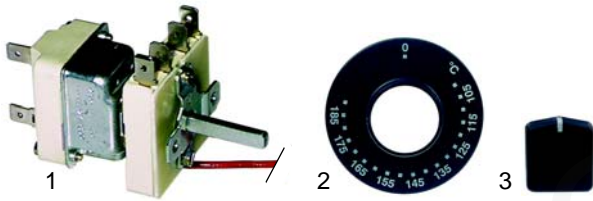

Abb.	Bestell-Nr.	Beschreibung	Gerätetyp	Ver.-Nr.
1	375580	Sich.-thermostat		05941
2	359364	Signallampe/grün	NFRE400/420, NFRE800/820	05010
3	359365	Signallampe/gelb		05011



Abb.	Bestell-Nr.	Beschreibung	Gerätetyp	Vergleichs-Nr.
1	301216	Schalter		59544
2	300001	Vorsatzschalter		A2036
3	111662	Knebel	HFH/E430	06144
4	359364	Signallampe/grün		05010
5	359365	Signallampe/grün		05011



Abb.	Bestell-Nr.	Beschreibung	Gerätetyp	Ver.-Nr.
1	375578	Sich.-thermostat		04472
2	345254	Mikroschalter	NFRE410/810	53671
3	359364	Signallampe/grün		05010
4	359365	Signallampe/gelb		05011

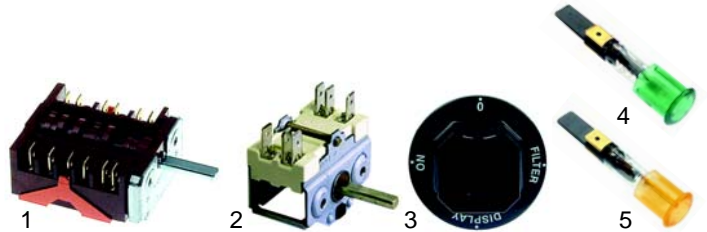

Abb.	Bestell-Nr.	Beschreibung	Gerätetyp	Vergleichs-Nr.
1	400994	Frontfolie		06608
2	400741	Elektr. Tastatur	HRFH/E435	06644
3	400996	Hauptplatine		06624
4	379918	Fühler		06609
5	400997	Taste		02670

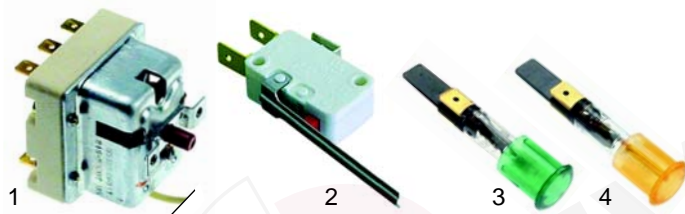

Abb.	Bestell-Nr.	Beschreibung	Gerätetyp	Ver.-Nr.
1	380261	Schütz	NFRE400/800	06879
2	380265	Schütz	NFRE420/820/410/810	07080
3	601130	Ventilator	NFRE420/820	06125

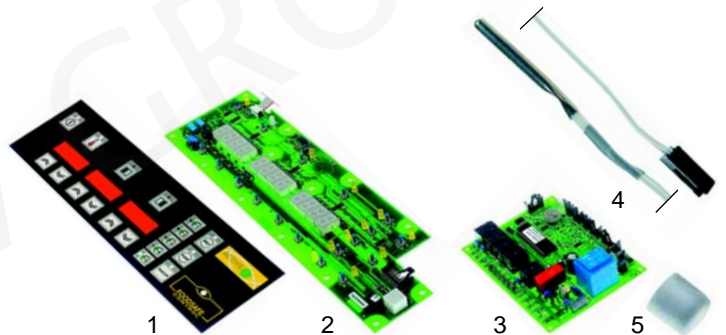

Abb.	Bestell-Nr.	Beschreibung	Gerätetyp	Vergleichs-Nr.
1	400998	Frontfolie	NFRE430	0C1015
2	400999	Frontfolie	NFRE435	0C1016
3	400994	Frontfolie	NFRE440	06608



Abb.	Bestell-Nr.	Beschreibung	Gerätetyp	Vergleichs-Nr.
1	400741	Elektr. Tastatur		06803
2	400996	Hauptplatine	NFRE430	06624
3	379918	Fühler	NFRE435	06609
4	400997	Druckknopf	NFRE440	02670

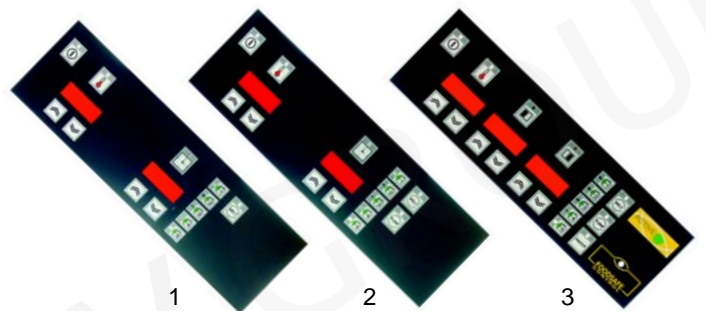

Abb.	Bestell-Nr.	Beschreibung	Gerätetyp	V.-Nr.
1	379395	Transformator		06159
2	379396	Gleichrichter	HFH/E430, HFH435, NFRE430/435/440	06147
3	380636	Relais		56510

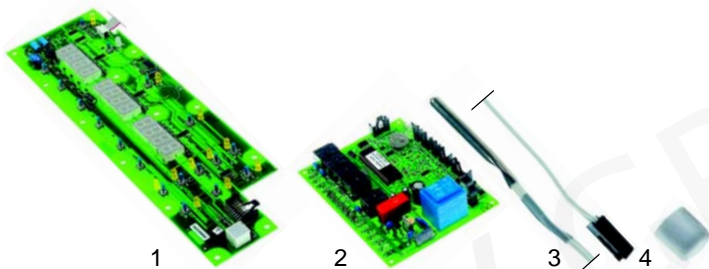

Abb.	Bestell-Nr.	Beschreibung	Gerätetyp	V.-Nr.
1	601130	Ventilator		06125
2	345254	Mikroschalter	HFH/E430, HFH435, NFRE430/435/440	53671
3	375585	Sich.-thermostat		06282



Abb.	Bestell-Nr.	Beschreibung	Gerätetyp	Ver.-Nr.
1	380637	Schütz	HFH/E430	06157
2	380204	Schütz	HFH/E435	82986
3	380261	Schütz	NFRE430/435/440	06879

Friteusen (Mechanik)

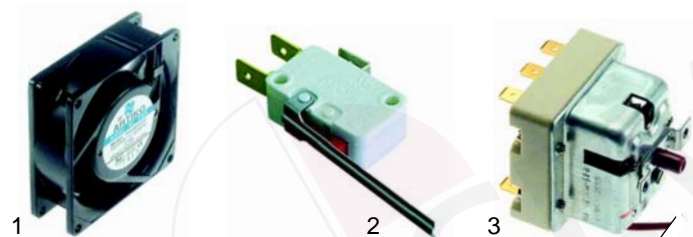

Abb.	Bestell-Nr.	Beschreibung	Gerätetyp	Vergleichs-Nr.
1	540259	Auslaufhahn		05667
2	514006	Auslaufrohr	SFRG_	05678
3	514027	Hebel	SFRE_	-
4	110704	Griff		04906

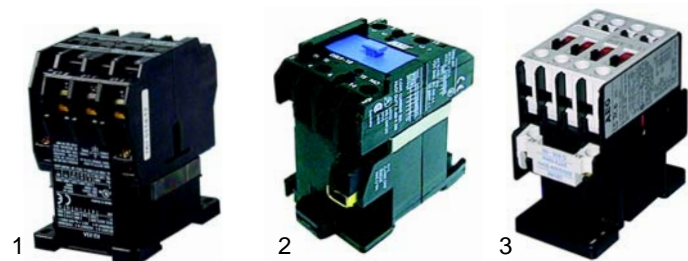

nicht mehr
lieferbar

Abb.	Best.-Nr.	Beschreibung	Gerätetyp	Ver.-Nr.
1	540972	Auslaufhahn	MFR/G (Stand), RFR/G (Stand), HFR/_	53108
2	n.m.l.	Auslaufhahn	RFR/E (Tisch)	55027
3	540974	Auslaufhahn	RFR/E (Stand)	54945



Abb.	B.-Nr.	Beschreibung	Gerätetyp	Ver.-Nr.
1	540975	Auslaufhahn	MFR/_ (Tisch)	58610
2	540965	Auslaufrohr	MF/_ (Tisch) PFR_ (Tisch)	02457
3	540976	Verlängerung	MF/_ (Tisch) PFR_ (Tisch)	04505



Abb.	Bestell-Nr.	Beschreibung	Gerätetyp	Vergl.-Nr.
1	540977	Auslaufhahn	MFR/_ (Stand)	56114
2	540978	Halteblech	PFR_ (Stand)	03378
3	540979	Griff	HFR/G	03377



Abb.	B.-Nr.	Beschreibg.	Gerätetyp	Ver.-Nr.
1	540980	Auslaufhahn	MF/__(Tisch), PFR__(Tisch)	05948
2	540981	Auslaufhahn	MFR/__(Stand), PFR__(Stand)	04486
3	540982	Auslaufhahn	MFR/__(Stand), PFR__(Stand)	05927



Abb.	B.-Nr.	Beschreibg.	Gerätetyp	Ver.-Nr.
1	540983	Auslaufhahn	MFR/___S40, PFR/___740, HFRE431/831	A5439
2	540986	Auslaufhahn	HFH/___	06688
3	540678	Griff		06689



Abb.	B.-Nr.	Beschreibg.	Gerätetyp	Ver.-Nr.
1	540986	Auslaufhahn	HFR/___430, HFR/___830	06123
2	540987	Griff	HFRS/___430	06142



Abb.	Bestell-Nr.	Beschreibung	Gerätetyp	Vergl.-Nr.
1	540977	Auslaufhahn		56114
2	540978	Halteblech	HFR/E410-412, HFR/E810	03378
3	540988	Verlängerung		59318
4	111666	Knebel		10142



Abb.	Bestell-Nr.	Beschreibung	Gerätetyp	Vergleichs-Nr.
1	693396	Dichtung	Universal	57402
2	693397	Glas		57400
3	693398	Rahmen		57382

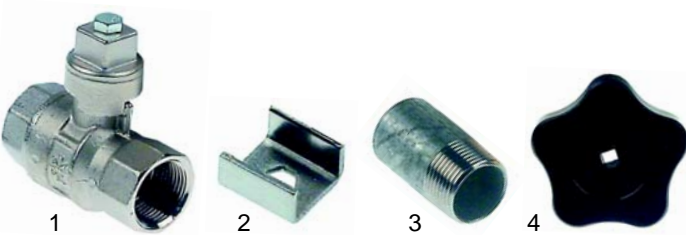

Abb.	Bestell-Nr.	Beschreibung	Gerätetyp	Vergleichs-Nr.
1	550138	Kapillarklemme	Universal	52262
2	550540	Fühlerklemme		52946
3	550403	Fühlerklemme		56330
4	550402	Fühlerklemme		52248



Abb.	Best.-Nr.	Beschreibung	Gerätetyp	Vergl.-Nr.
1	970139	270 x 210 x 100mm	SFR/___	05704
2	970141	285 x 115 x 100mm	RFR/G (Tisch), MFR/G (Tisch)	26820
3	970404	260 x 270 x 160mm	PRFR/G (Stand), MFR/	52683



Abb.	B.-Nr.	Beschreibung	Gerätetyp	Ver.-Nr.
1	970140	320 x 100 x 120mm	RFR (5L), MFR/E (5L), MF/E (5L), PFRE370	54948
2	970143	320 x 225 x 120mm	RFR/E, MER/___ (7L)	54960
3	970404	260 x 270 x 160mm	MFR/___ (15L)	52683

Z

Passend für Zanussi

Kippbratpfannen (Gas)



Abb.	B.-Nr.	Beschreibung	Gerätetyp	V.-Nr.
1	970406	305 x 225 x 90mm	MF/___ (7L/8L), PFR___	04492
2	970407	260 x 270 x 120mm	MF/___ (12L), PFR___	04499
3	970408	325 x 225 x 120mm	MF/___ (15L), PFR___, NFR___	05933



Abb.	B.-Nr.	Beschreibung	Gerätetyp	V.-Nr.
1	970143	320 x 225 x 120mm	MF/E (12L - Heizung außen), PFRE___	54960
2	970144	340 x 160 x 160mm	MFR/___420/421/820	52290
3	970410	325 x 225 x 90mm	CFRG___	0G2206



Abb.	B.-Nr.	Beschreibung	Gerätetyp	V.-Nr.
1	970145	330 x 160 x 120mm	HFR/___ 410-412,	59327
2	970411	340 x 335 x 120mm	HFR/___ 810	59307



Abb.	B.-Nr.	Beschreibung	Gerätetyp	V.-Nr.
1	970412	330 x 135 x 140mm	HFH/___, HFR/___430,	06133
2	970413	330 x 285 x 140mm	HFR/___830, HFRS/___, NFR___	06539

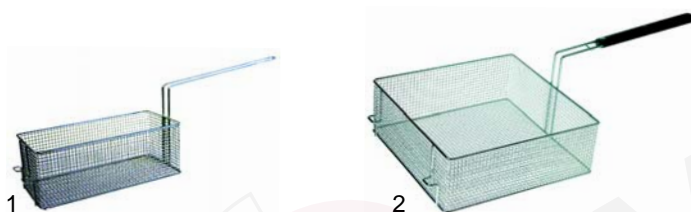

Abb.	B.-Nr.	Beschreibung	Gerätetyp	Ver.-Nr.
1	105646	Brenner	RBR/G, MBR/G	56796
2	105647	Brenner	MB___/G2, PBRG700/701	04353

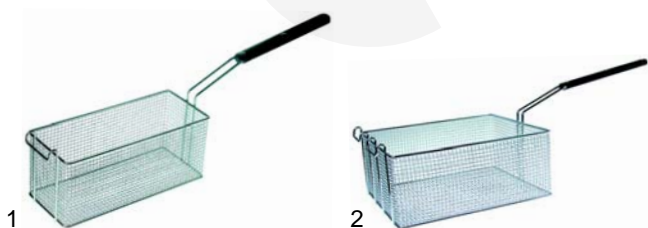
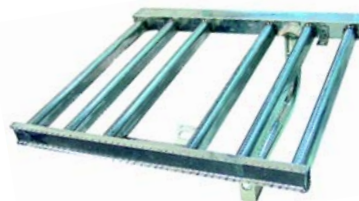

Pos.	B.-Nr.	Beschreib.	Gerätetyp	Ver.-Nr.
1	105648	Brenner	HBR/G803-804, HBR/G820/825	51296
2	105649	Brenner	HBR/G1003/1004/1013	51297

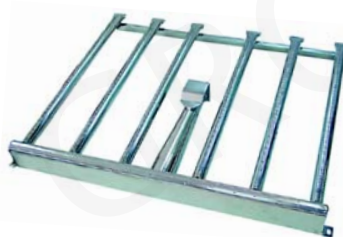

Pos.	B.-Nr.	Beschreib.	Gerätetyp	Ver.-Nr.
1	105650	Brenner	HBR/G800-801, HBR/G805-806	A5166
2	105651	Brenner	HBR/G810-811, HBR/G815-816	51624



Pos.	B.-Nr.	Beschreib.	Gerätetyp	Ver.-Nr.
1	105652	Brenner	NBR/G800/810	0C0700
2	105653	Brenner	NBR/G815/820	0C0701



Abb.	B.-Nr.	Beschreibung	Gerätetyp	Ver.-Nr.
1	101132	Minisiregler		56833
2	101136	Abdeckkappe m. Piezozünder	RBR/G MBR/G	54269
3	110068	Knebel		54268



Abb.	Bestell-Nr.	Beschreibung	Gerätetyp	Vergl.-Nr.
1	375579	Sich.-thermostat		03594
2	100012	Piezozünder	MB/_/G, PBRG700/701	02605
3	101339	Haube		02816

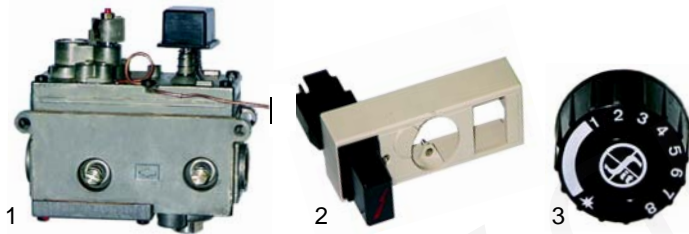

Abb.	B.-Nr.	Beschreibung	Gerätetyp	Vergl.-Nr.
1	100044	Zündbrenner		27073
2	100706	Zündkerze		56754
3	102045	Thermoelement, 1500mm	RBR/G MBR/G	56840, 52814
4	100026	Zündkabel, 1000mm		54273



Abb.	Bestell-Nr.	Beschreibung	Gerätetyp	Vergl.-Nr.
1	10207	Thermoelement		54055
2	100050	Zündbrenner	MB/_/G, PBRG700/701	59379
3	100701	Zündkerze		53380



Abb.	B.-Nr.	Beschreibung	Gerätetyp	Ver.-Nr.
1	102250	Thermoelement m. Unterbrecher	MBGR/G	56914
2	375572	Sich.-thermostat	(ab Nr.534...)	53980



Abb.	Bestell-Nr.	Beschreibung	Gerätetyp	Vergl.-Nr.
1	101127	Elettrositventil	HBR/G803-804,	57543
2	111668	Blende	HBR/G1003, HBR/G1004,	51280
3	101309	Verlängerung	HBR/G1013	51281
4	101312	Mikroschalter		54539

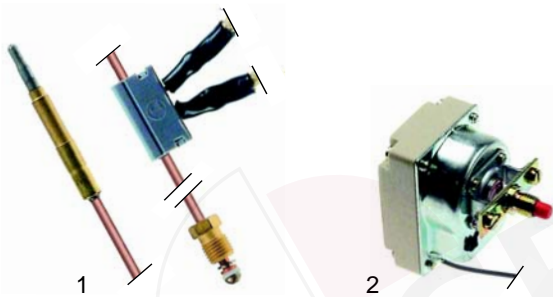

Abb.	Bestell-Nr.	Beschreibung	Gerätetyp	Vergl.-Nr.
1	101409	Eurosiregler		58772
2	110358	Adapter	MB/_/G, PBRG700/701	03391
3	111667	Knebel		04482



Abb.	B.-Nr.	Beschreib.	Gerätetyp	Ver.-Nr.
1	101002	Zündgruppe	HBR/G803-804,	51884
2	100052	Zündbrenner	HBR/G1003, HBR/G1004,	57411
3	100701	Zündkerze	HBR/G1013	52610

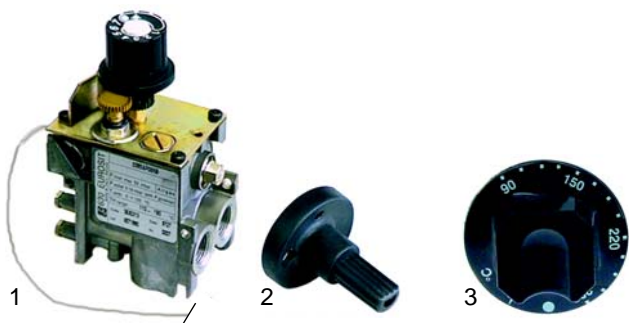

Abb.	B.-Nr.	Beschreibung	Gerätetyp	Vergl.-Nr.
1	375572	Sicherheitsthermostat	HBR/G803-804,	53980
2	102041	Thermoelement, 600mm	HBR/G1003, HBR/G1004, HBR/G1013	57781
3	101265	Unterbrecher	HBR/G_D	51643
4	375163	Sicherheitsthermostat	HBR/G_D	51643
5	102250	Thermoelement		51932, 56914



Abb.	Bestell-Nr.	Beschreibung	Gerätetyp	Ver.-Nr.
1	101967	Novasitventil	HBR/G800-801,	59473
2	102340	Feuerungsautomat	HBR/G805-806, HBR/G810-811,	A5167
3	541335	Druckschalter	HBR/G815-816	54540

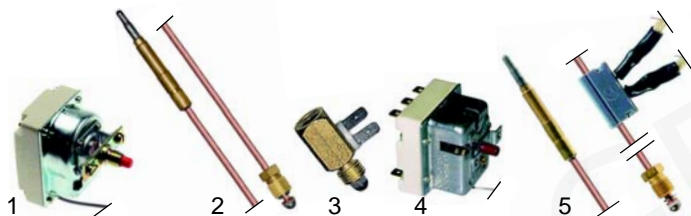

Abb.	Bestell-Nr.	Beschreibung	Gerätetyp	Vergl.-Nr.
1	390156	Thermostat	HBR/G803-804,	51360
2	110046	Knebel	HBR/G1003, HBR/G1004,	26915
3	300020	Schalter	HBR/G1013	28390
4	110043	Knebel		50341



Abb.	Best.-Nr.	Beschreibung	Gerätetyp	Vergl.-Nr.
1	102169	Elektrode		A5168
2	102170	Elektrode		A5169
3	375572	Sicherheitsthermostat	HBR/G800-801, HBR/G805-806, HBR/G810-811, HBR/G815-816	53980
4	359364	Signallampe/grün		58658
5	359365	Signallampe/gelb		58659
6	359366	Signallampe/rot		58712

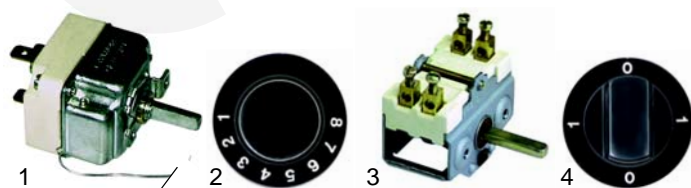

Abb.	Bestell.-Nr.	Beschreibung	Gerätetyp	Vergl.-Nr.
1	345254	Mikroschalter	HBR/G803-804,	53671
2	359151	Signallampe/grün	HBR/G1003,	53148
3	359152	Signallampe/gelb	HBR/G1004, HBR/G1013	53149
4	359150	Signallampe rot		53150

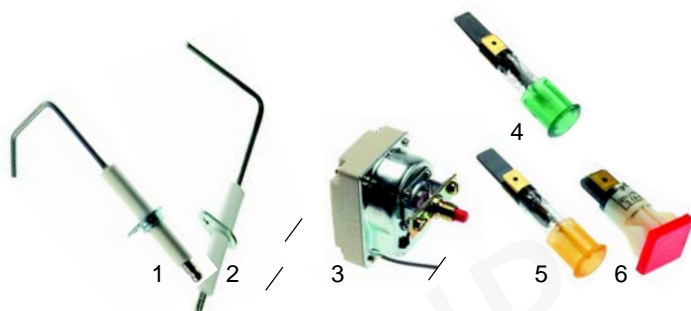

Abb.	Best.-Nr.	Beschreibung	Gerätetyp	Vergl.-Nr.
1	375581	Thermostat	HBR/G800-801,	02109
2	111669	Knebel	HBR/G805-806, HBR/G810-811,	59468
3	380015	Energieregler	HBR/G815-816	55016
4	111670	Knebel		59469

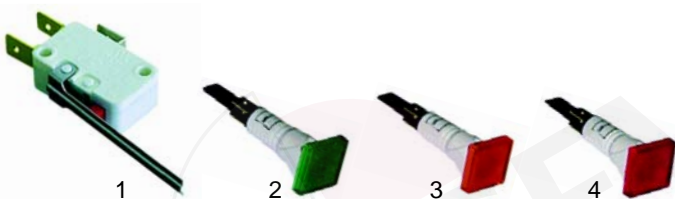

Abb.	Bestell-Nr.	Beschreibung	Gerätetyp	Vergleichs-Nr.
1	345038	Schalter	HBR/G	58274
2	345039	Haube	(ab 2/91)	53979
3	373017	Magnetventil		55132

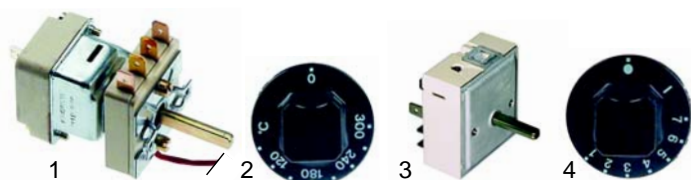

Abb.	B.-Nr.	Beschreibung	Gerätetyp	Ver.-Nr.
1	101956	Novasitventil	NBRG800/800H	02903
2	101799	Adapter	NBRG810/810H NBRG815/815H	04667
3	111631	Knebel	NBRG820/820H	0C0465

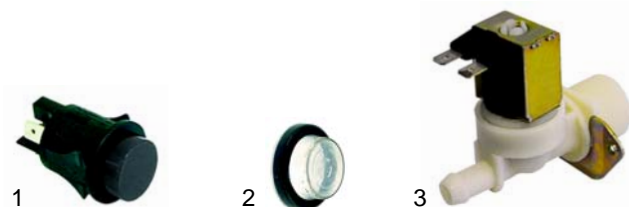

Abb.	B.-Nr.	Beschreibung	Gerätetyp	Ver.-Nr.
1	100050	Zündbrenner	NBRG800/800H	59379
2	100701	Zündkerze	NBRG810/810H	59380
3	102041	Thermoelement, 600mm	NBRG815/815H	025031
4	101002	Zündgruppe	NBRG820/820H	03376



Abb.	B.-Nr.	Beschreibung	Gerätetyp	Ver.-Nr.
1	345038	Schalter		58274
2	345039	Haube	NBRG800/800H	53979
3	359145	Signalelement grün	NBRG810/810H	05010
4	359146	Signalelement gelb	NBRG815/815H	05011
5	359144	Signalelement rot	NBRG820/820H	0C0687

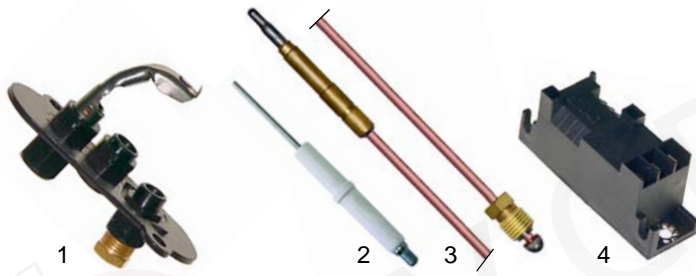

Abb.	Best.-Nr.	Beschreibung	Gerätetyp	Vergl.-Nr.
1	375581	Thermostat	NBRG800/800H	02109
2	111620	Blende	NBRG810/810H	0C0258
3	111602	Knebel	NBRG815/815H	0C0257



Abb.	B.-Nr.	Beschreibung	Gerätetyp	Ver.-Nr.
1	101187	Novasiventil mV.	HBR/G800-801,	02606
2	110358	Adapter	HBR/G805-806,	59305
3	111534	Knebel	HBR/G810-811,	59304
			HBR/G815-816	

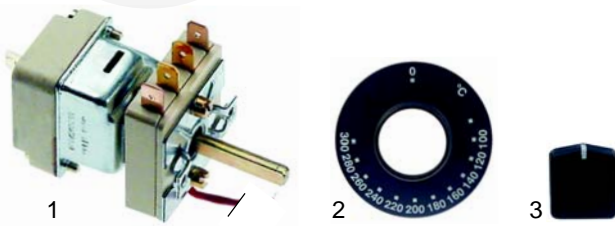

Abb.	B.-Nr.	Beschreibung	Gerätetyp	Ver.-Nr.
1	380015	Energieregler	NBRG800/800H	55016
2	111609	Blende	NBRG810/810H	0C0318
3	111602	Knebel	NBRG815/815H	0C0257



Abb.	B.-Nr.	Beschreibung	Gerätetyp	Ver.-Nr.
1	100110	Zündbrenner	HBR/G800-801,	02783
2	102116	Thermogenerator	HBR/G805-806,	02607
3	100701	Zündkerze	HBR/G810-811,	59380
			HBR/G815-816	



Abb.	B.-Nr.	Beschreibung	Gerätetyp	Ver.-Nr.
1	375565	Sich.-thermostat	NBRG800/800H	0C0270
2	345254	Mikroschalter	NBRG810/810H	53671
3	370015	Magnetventil	NBRG815/815H	0C0688



Abb.	B.-Nr.	Beschreibung	Gerätetyp	Ver.-Nr.
1	102252	Thermoelement	HBR/G800-801,	02784
2	100012	Piezozünder	HBR/G805-806,	02605
3	101339	Abdeckhaube	HBR/G810-811,	02816
			HBR/G815-816	

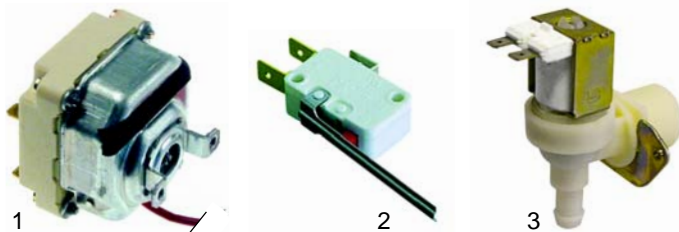

Abb.	Best.-Nr.	Beschreibung	Gerätetyp	Ver.-Nr.
1	375572	Sicherheitsthermostat	HBR/G800-801, HBR/G805-806, HBR/G810-811, HBR/G815-816	53980
2	359364	Signallampe		05010

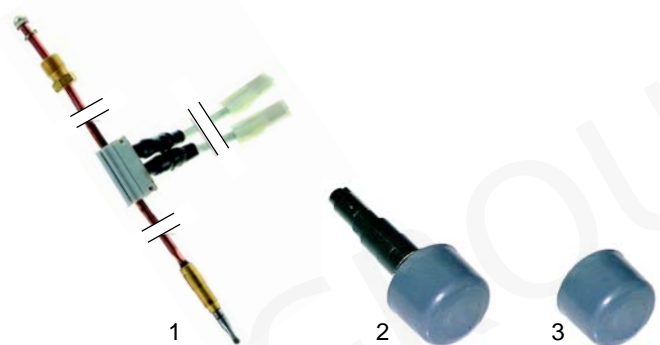

Abb.	B.-Nr.	Beschreibung	Gerätetyp	Ver.-Nr.
1	375581	Thermostat	HBR/G800-801, HBR/G805-806, HBR/G810-811, HBR/G815-816	02109
2	111669	Knebel		59468
3	380015	Energieregler		55016
4	111670	Knebel		59469

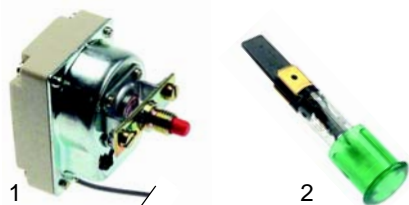

Abb.	B.-Nr.	Beschreibung	Gerätetyp	Ver.-Nr.
1	101956	Novasitventil		02903
2	101928	Adapter	HBR/G820, HBR/G825	59305
3	111534	Knebel		59304
4	101312	Mikroschalter		54539

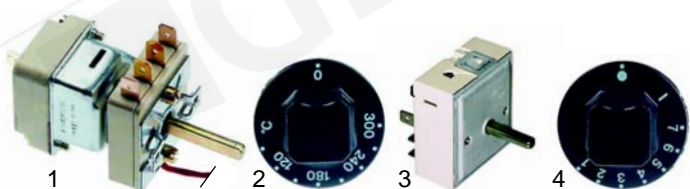

Abb.	B.-Nr.	Beschreibung	Gerätetyp	Ver.-Nr.
1	100052	Zündbrenner		57411
2	100701	Zündkerze		52610
3	102250	Thermoelment m. Unterbrecher	HBR/G820, HBR/G825	56914
4	101002	Zündgruppe		03376



Abb.	B.-Nr.	Beschreibung	Gerätetyp	Ver.-Nr.
1	375581	Thermostat		02109
2	111671	Knebel		02104
3	375163	Sich.-thermostat	HBR/G820, HBR/G825	51643
4	359364	Signallampe grün		58658
5	359365	Signallampe gelb		58659

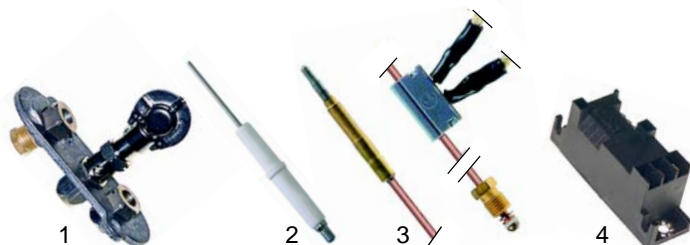

Abb.	B.-Nr.	Beschreibung	Gerätetyp	Ver.-Nr.
1	345038	Schalter		58274
2	345039	Haube	HBR/G820, HBR/G825	53979
3	345254	Mikroschalter		53671
4	373017	Magnetventil		55132

Kippbratpfannen (Elektro)

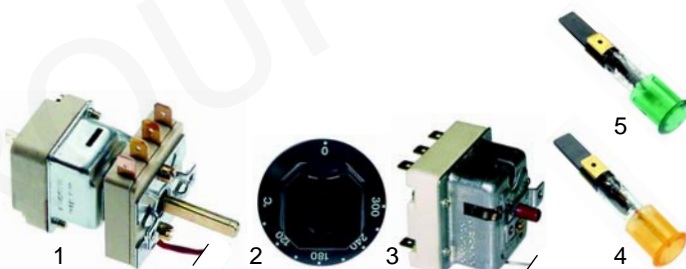

Abb.	Bestell-Nr.	Beschreibung	Gerätetyp	Vergl.-Nr.
1	415098	1500W/230V	RBR/E700	A2068
2	415273	1500W/230V	MBR/E7	58345 58349
3	418016	1500W/230V	MBK/E7 (2 Gen.)	02559
4	418003	3000W/230V	MBR/E2_ MBK/E2_ PBRE70_	04469

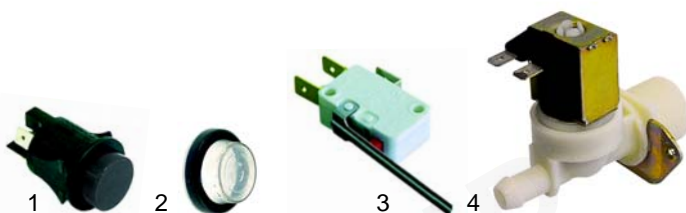

Abb.	B.-Nr.	Beschreibung	Gerätetyp	Ver.-Nr.
1	415381	1300W/230V	HBR/E803, HBR/E804, HBR/E820, HBR/E825, HBR/E1003, HBR/E1013	51355
2	418004	1500W/230V	HBR/E801	51356
3	415184	2200W/230V	HBR/E800, HBR/E805, HBR/E810-811, HBR/E815-816	59401
4	418005	2500W/230V	NBRE800, NBRE810, NBRE815, NBRE820	0C0685

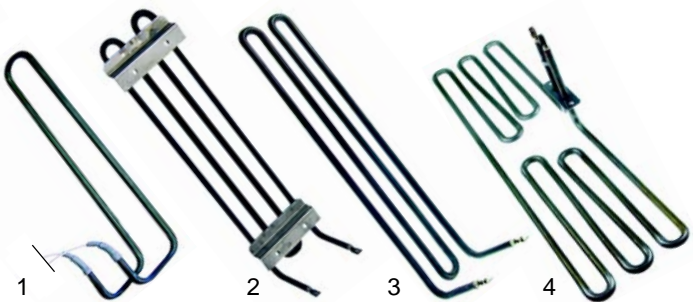

Abb.	B.-Nr.	Beschreibung	Gerätetyp	Ver.-Nr.
1	300074	Schalter	RBR/E	A2162
2	111638	Knebel		26797
3	359109	Signalelement		54150
4	359803	Linse		54151

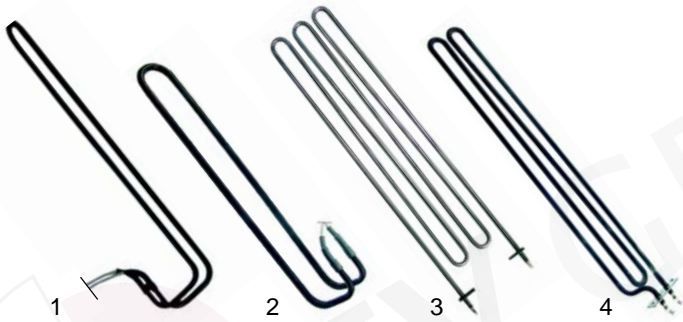

Abb.	B.-Nr.	Beschreibung	Gerätetyp	Vergleichs-Nr.
1	375642	Thermostat	RBR/E	A2012
2	111617	Knebel		53867
3	346362	Mikroschalter		A2145, A2194, 58344

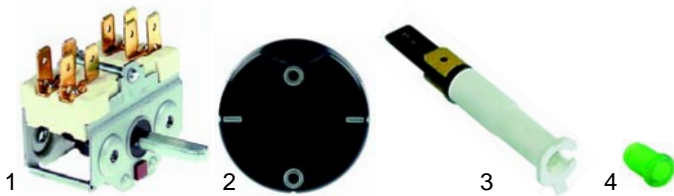

Abb.	B.-Nr.	Beschreibung	Gerätetyp	Vergleichs-Nr.
1	300129	Schalter	RBR/E	A2227
2	111672	Knebel		56871
3	370016	Magnetventil		47529



Abb.	B.-Nr.	Beschreibung	Gerätetyp	V.-Nr.
1	300074	Schalter	MBR/E700-.701, MBR/E706, MBR/E710-711, MBR/E716	A2162
2	110315	Knebel		58629
3	359364	Signallampe		58658

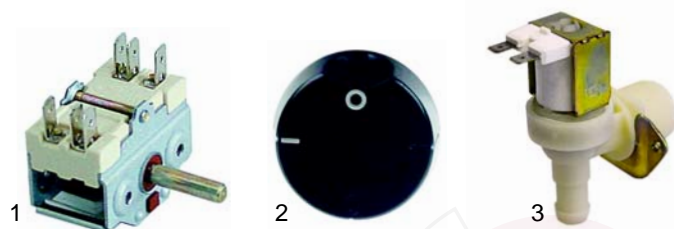

Abb.	B.-Nr.	Beschreibung	Gerätetyp	V.-Nr.
1	390156	Thermostat	MBR/E700-.701, MBR/E706, MBR/E710-711, MBR/E716	51360
2	111673	Knebel		02374
3	346362	Mikroschalter		58344
4	375571	Sicherheitsthermostat		51454



Abb.	B.-Nr.	Beschreibung	Gerätetyp	V.-Nr.
1	300129	Schalter	MBR/E700-.701, MBR/E706, MBR/E710-711, MBR/E716	A2227
2	111674	Knebel		58630
3	370339	Magnetventil		55350

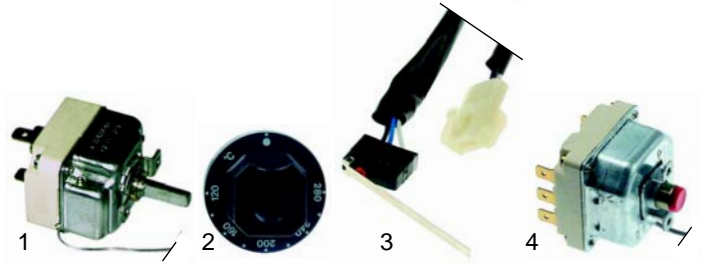

Abb.	Bestell-Nr.	Beschreibung	Gerätetyp	Vergleichs-Nr.
1	375581	Thermostat	MBR/E2_., MBK/E2_., PBR/E70_.	02109
2	110447	Knebel		59403
3	359364	Signallampe/grün		05010
4	359365	Signallampe/gelb		05011



Abb.	Bestell-Nr.	Beschreibung	Gerätetyp	Vergl.-Nr.
1	375562	Sicherheitsthermostat	MBR/E2_, MBK/E2_, PBRE70_	04269
2	345254	Mikroschalter		53671
3	380244	Schütz		03598

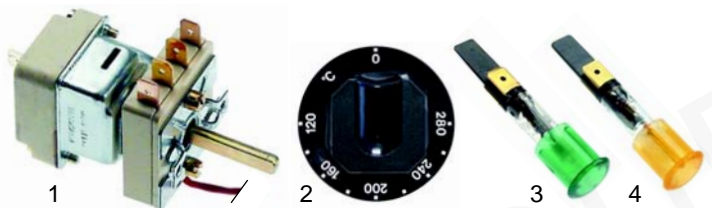

Abb.	Best.-Nr.	Beschreibung	Gerätetyp	Vergl.-Nr.
1	380015	Energieregler	HBR/E800-801,	55016
2	111670	Knebel	HBR/E805-806,	59469
3	345032	Mikroschalter	HBR/E810-811,	46063
4	375572	Sicherheitsthermostat	HBR/E815-816	53980

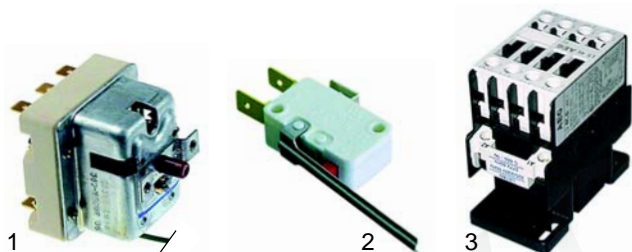

Abb.	Bestell-Nr.	Beschreibung	Gerätetyp	Vergl.-Nr.
1	300102	Schalter		50857
2	110043	Knebel	MBR/E801,	50341
3	359151	Signallampe/grün	MBR/E803, MBR/E1003,	53148, 53154
4	359152	Signallampe/gelb	MBR/E1013	53149, 53155
5	359150	Signallampe/rot		53150, 53153

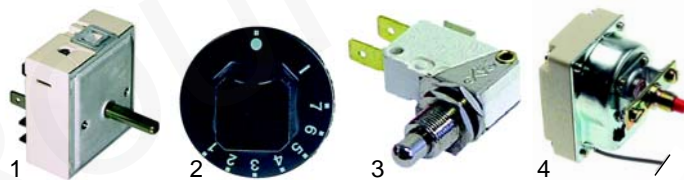

Abb.	Best.-Nr.	Beschreibung	Gerätetyp	Vergl.-Nr.
1	380261	Schütz	HBR/E800-801,	58805
2	380637	Schütz	HBR/E805-806	54928

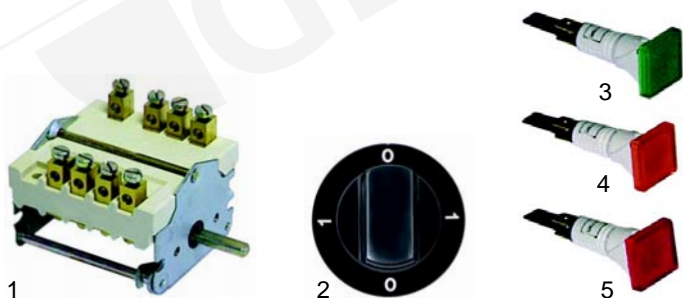

Abb.	Bestell-Nr.	Beschreibung	Gerätetyp	Vergl.-Nr.
1	390156	Thermostat		51360
2	110046	Knebel	MBR/E801, MBR/E803,	26915
3	375572	Sicherheitsthermostat	MBR/E1003, MBR/E1013	53980
4	380204	Schütz		75796

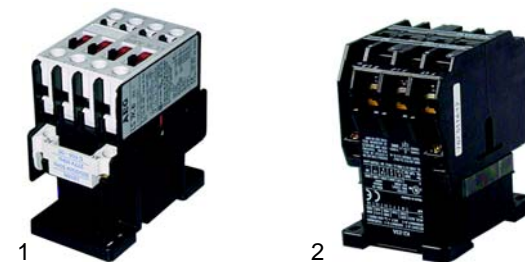

Abb.	Best.-Nr.	Beschreibung	Gerätetyp	Vergl.-Nr.
1	375581	Thermostat		02109
2	111671	Knebel	HBR/E820,	02104
3	359364	Signallampe/grün	HBR/E825	58658
4	359365	Signallampe/gelb		58659

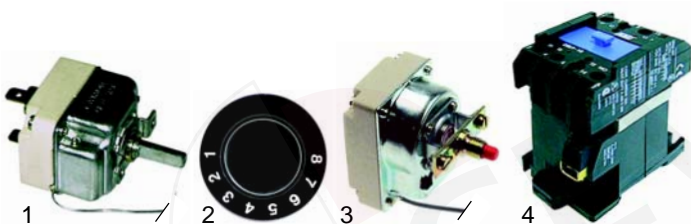

Abb.	Bestell-Nr.	Beschreibung	Gerätetyp	Vergl.-Nr.
1	375581	Thermostat		02109
2	111669	Knebel	HBR/E800-801,	59468
3	359364	Signallampe/grün	HBR/E805-806, HBR/E810-811,	58658
4	359365	Signallampe/gelb	HBR/E815-816	58659
5	359366	Signallampe/rot		58712



Abb.	Best.-Nr.	Beschreibung	Gerätetyp	Vergl.-Nr.
1	375571	Sicherheitsthermostat		51454
2	380244	Schütz	HBR/E820, HBR/E825	03598
3	345254	Mikroschalter		53671

Z

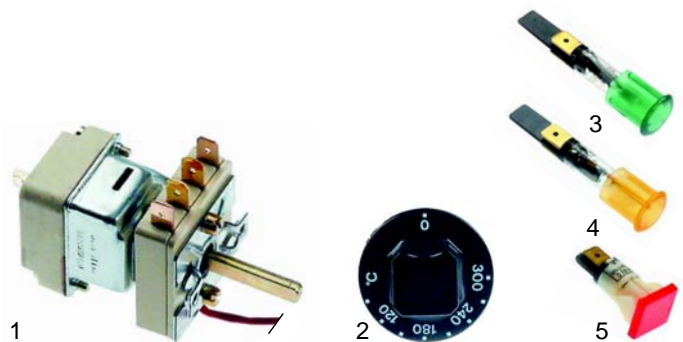
Passend für Zanussi

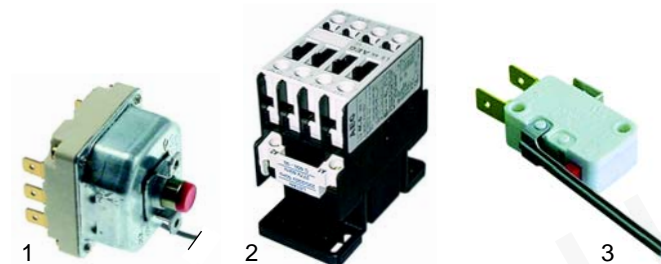

Abb.	Best.-Nr.	Beschreibung	Gerätetyp	Vergl.-Nr.
1	345038	Schalter	HBR/E820,	58274
2	345039	Haube	HBR/E825	53979
3	373017	Magnetventil		55132



Abb.	Bestell-Nr.	Beschreibung	Gerätetyp	Vergl.-Nr.
1	345038	Schalter		58274
2	345039	Schutzhaube	NBRE800,	53979
3	370015	Magnetventil	NBRE810,	0C0688
4	345254	Mikroschalter	NBRE815,	53671
			NBRE820	

Kippbratpfannen (Motorkippung)

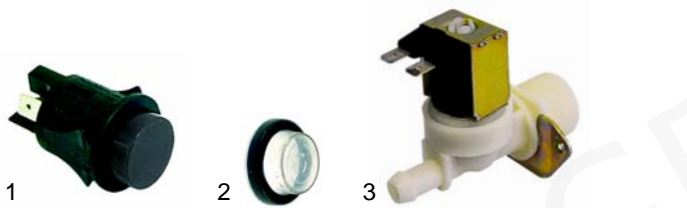

Abb.	Bestell-Nr.	Beschreibung	Gerätetyp	Vergl.-Nr.
1	375581	Thermostat	NBRE800,	02109
2	111620	Blende	NBRE810,	0C0258
3	111602	Knebel	NBRE815,	0C0257
			NBRE820	



Abb.	Bestell-Nr.	Beschreibung	Gerätetyp	Vergl.-Nr.
1	346340	Schalter/kpl.	RBR/E_	A2196
2	346362	Mikroschalter	RBR/G_	A2195, 58344
3	500626	Motor	MBR/G_	56980
			MBR/E_	



Abb.	Bestell-Nr.	Beschreibung	Gerätetyp	Vergl.-Nr.
1	380015	Energiregler	NBRE800,	55016
2	111609	Blende	NBRE810,	0C0318
3	111602	Knebel	NBRE815,	0C0257
			NBRE820	

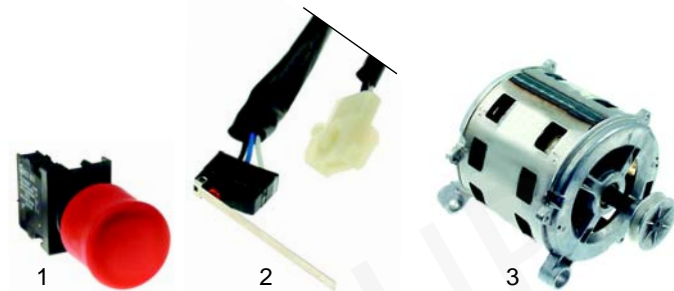

Abb.	Bestell-Nr.	Beschreibung	Gerätetyp	Vergl.-Nr.
1	693261	Keilriemenscheibe	RBR/E_	56976
2	693262	Keilriemen	RBR/G_	52804
3	700420	Feder/Motorspannung	MBR/G_	56975
4	700421	Feder/Fußschalter	MBR/E_	56977



Abb.	Bestell-Nr.	Beschreibung	Gerätetyp	Vergl.-Nr.
1	375565	Sicherheitsthermostat	NBRE800,	0C0270
2	380261	Schütz	NBRE810,	06879
3	359364	Signallampe/grün	NBRE815,	05010
4	359365	Signallampe/gelb	NBRE820	05011



Abb.	Bestell-Nr.	Beschreibung	Gerätetyp	Vergl.-Nr.
1	345254	Mikroschalter		53671
2	500823	Motor		52802
3	n.m.l.	Riemenscheibe	HBR/G1013	52784
4	693264	Riemenscheibe		52783
5	693262	Keilriemen		52804

Z

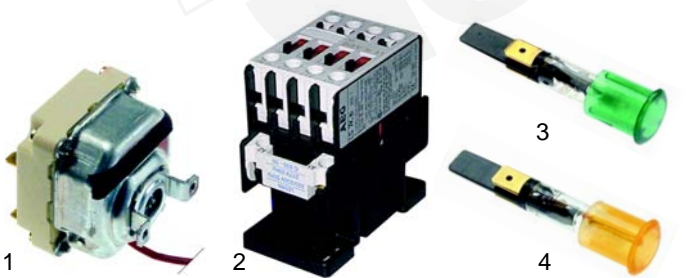
Passend für Zanussi

nicht mehr
lieferbar



Abb.	Bestell-Nr.	Beschreibung	Gerätetyp	Vergl.-Nr.
1	n.m.l.	Kugellager	HBR/G1013	52799
2	693266	Mutter		52800
3	693267	Welle		52803
4	523519	Kugellager		51298



Abb.	Bestell-Nr.	Beschreibung	Gerätetyp	Vergl.-Nr.
1	500628	Motor	HBR/_811,	02794
2	693270	Getriebe	HBR/_816	02795



Abb.	Bestell-Nr.	Beschreibung	Gerätetyp	Vergl.-Nr.
1	345038	Schalter	HBR/_811, HBR/_816	58274
2	345039	Haube		
3	345032	Mikroschalter		02785, 58926



Abb.	Bestell-Nr.	Beschreibung	Gerätetyp	Vergl.-Nr.
1	700422	Feder/Motorspannung	HBR/G1013	52789
2	700423	Feder/Fußschalter		52787

Kippbratpfannen (Mechanik)

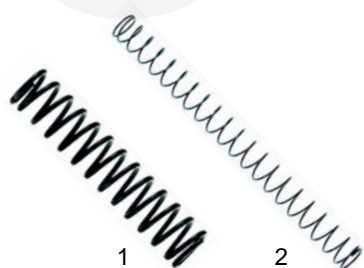

nicht mehr
lieferbar

Abb.	Best.-Nr.	Beschreibung	Gerätetyp	Vergl.-Nr.
1	523510	Kugellager	RBR/_ , MBR/_ , MBH/_	56820
2	523520	Kugellager		56821
3	693271	Welle		56823
4	693272	Buchse		56818
5	n.m.l.	Halter		56824
6	693274	Buchse		56825



nicht mehr
lieferbar

Abb.	Bestell-Nr.	Beschreibung	Gerätetyp	Vergl.-Nr.
1	500627	Motor/kpl.	HBR/_801, HBR/_806, HBR/_811, HBR/_816	02144
2	n.m.l.	Keilriemenscheibe		02146
3	693268	Keilriemenscheibe		02147
4	693269	Keilriemen		02148



Abb.	Best.-Nr.	Beschreibung	Gerätetyp	Vergl.-Nr.
1	693624	Handrad	RBR/_ , MBR/_ , MBH/_	56826
2	693275	Kette		56862
3	693276	Kettenschließglied		56863
4	693277	Kettenende		56827
5	693278	Kettenende		56830



Abb.	Bestell-Nr.	Beschreibung	Gerätetyp	Vergl.-Nr.
1	346309	Schalter	HBR/_801, HBR/_806, HBR/_811, HBR/_816	02149
2	301036	Schutzkappe		02150
3	345032	Mikroschalter		46063, 58926
4	380312	Relais		58857, 56466

Z

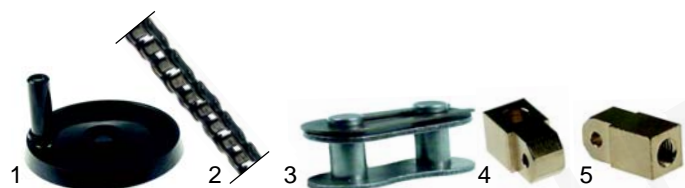
Passend für Zanussi

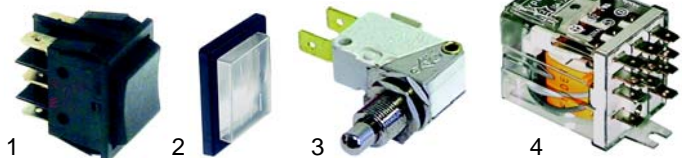

Abb.	Best.-Nr.	Beschreibung	Gerätetyp	Vergl.-Nr.
1	700424	Deckelfeder		56846
2	693279	Zugseil/kpl.	RBR/_ , MBR/_ , MBH/_	56852
3	516193	Klemme		56853



Abb.	Best.-Nr.	Beschreibung	Gerätetyp	Vergl.-Nr.
1	693291	Mutter		0C0675
2	693292	Welle	NBRG/_ , NBRE/_	0C0674
3	523510	Lager		0C0673
4	693399	Handrad		A5164
5	514250	Handkurbel		02276

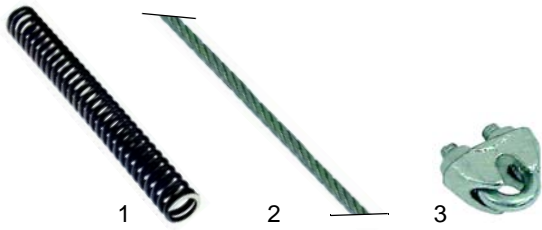

Abb.	Best.-Nr.	Beschreibung	Gerätetyp	Vergl.-Nr.
1	693318	Mutter		51264
2	693282	Ring		51277
3	693283	Welle	HBR/_801, HBR/_803, HBR/_804, HBR/_1003	51336
4	693284	Halter		51265
5	523519	Kugellager		51298
6	690858	Handrad		52392
7	690859	Griff		52393



Abb.	Best.-Nr.	Beschreibung	Gerätetyp	Vergl.-Nr.
1	693294	Feder Kippung	NBRG/_ , NBRE/_	0C0671
2	693295	Feder Deckel		0C0666



Abb.	Best.-Nr.	Beschreibung	Gerätetyp	Vergl.-Nr.
1	693285	Stellring	HBR/_801, HBR/_803, HBR/_804, HBR/_1003,	51266
2	693286	Feder		51268
3	693287	Federspanner		51267
4	693288	Scharnier	HBR/_820, HBR/_825	51260



Abb.	Best.-Nr.	Beschreibung	Gerätetyp	Vergl.-Nr.
1	540799	Wasserhahn	HBR/G, HBR/E	02322
2	540989	Einlaufrohr	NBRG/_ , NBRE/_	0C0689



Abb.	Best.-Nr.	Beschreibung	Gerätetyp	Vergl.-Nr.
1	693399	Handrad		A5164
2	514250	Handkurbel	HBR/_800-801, HBR/_805-806,	02276
3	693289	Feder	HBR/_810-811, HBR/_815-816	A5150
4	693290	Federspanner		A2551

Z

Passend für Zanussi

Kochkessel (Gas)



Abb.	Best.-Nr.	Beschreibung	Gerätetyp	Vergl.-Nr.
1	104157	Brenner	RPN/G_, RPN/G1_, MPN/G, MPN/G1_	51716
2	105641	Brenner	MPD/G2_, MPI/G2, PPNGD_, PPNG1_	04847
3	105654	Brenner	HQN/G917, HQN/G1 917	51563
3	105655	Brenner	HQN/G1225, HQN/G1 1225	51564



Abb.	Best.-Nr.	Beschreibung	Gerätetyp	Vergl.-Nr.
1	n.m.l.	Brenner/rechts	HPN/G810, HPN/G1 810, HPA/G810, HPA/G1 810	51799
2	n.m.l.	Brenner/links		51800
3	105658	Brenner/rechts	HPN/G815, HPN/G1 815, HPA/G815, HPA/G1 815	51797
4	n.m.l.	Brenner/links		51798



Abb.	Best.-Nr.	Beschreibung	Gerätetyp	Vergl.-Nr.
1	105660	Brenner	HPN/G0 810-811, HPN/G1 810-811, HPN/G0 815-816, HPN/G1 815-816	59506
2	104157	Brenner	HPN/G1 805-806	51716
3	105661	Brenner	NPGD_, NPG1_	0C0743

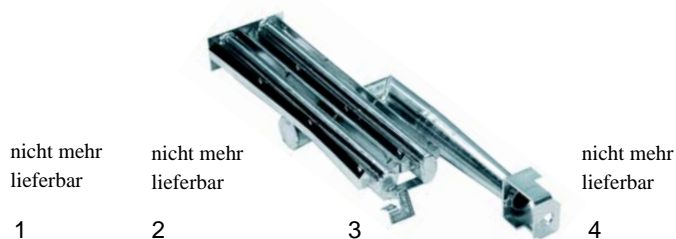

Abb.	Best.-Nr.	Beschreibung	Gerätetyp	Vergl.-Nr.
1	101091	Gashahn		54811
2	111599	Knebel	RPN/G760, RPN/G1 760	52604
3	100007	Piezozünder		52539

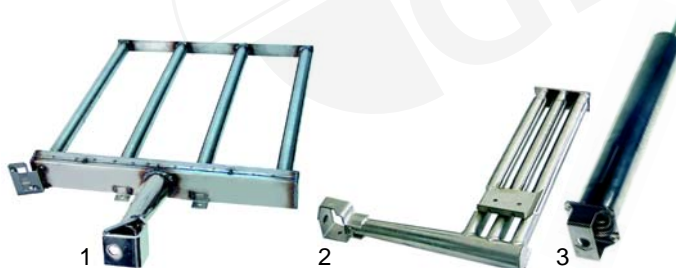

Abb.	Best.-Nr.	Beschreibung	Gerätetyp	Vergl.-Nr.
1	101091	Gashahn		54811
2	110309	Knebel	MPN/GD 760-761, MPN/G1 760	58597
3	100012	Piezozünder		02605
4	101339	Haube		02816



Abb.	Best.-Nr.	Beschreibung	Gerätetyp	Ver.-Nr.
1	100106	Zündbrenner	RPN/G760, RPN/G1 760, MPN/GD760, MPN/GD761, MPN/G1 760	57737, 58329, 58715
2	100706	Zündkerze		56754, 51565
3	102044	Thermoelement, 1200mm		20094

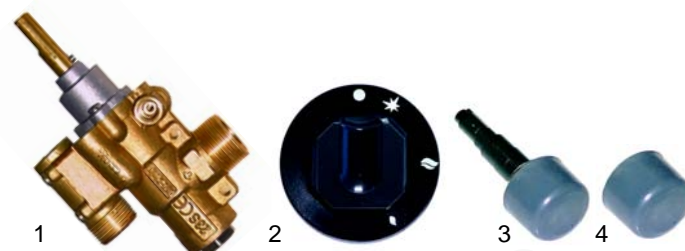

Abb.	Best.-Nr.	Beschreibung	Gerätetyp	Vergl.-Nr.
1	101087	Gashahn		52146
2	110448	Knebel	MPD/G2_, MPI/G2_	59378
3	100012	Piezozünder	PPNGD_, PPNG1_	02603
4	101339	Haube		02816

Z

Passend für Zanussi



nicht mehr
lieferbar

1 2 3

Abb.	Best.-Nr.	Beschreibung	Gerätetyp	Ver.-Nr.
1	100109	Zündbrenner	MPD/G2_	A2472
2	100701	Zündkerze	MPI/G2_	59988
3	102044	Thermoelement, 1200mm	PPNGD_	20094
			PPNGI_	

Abb.	Best.-Nr.	Beschreibung	Gerätetyp	Vergl.-Nr.
1	n.m.l.	VR8-Ventil	HPN/G810D,	37578
2	110070	Knebel	HPN/G815D,	51638
3	100001	Piezozünder	HPN/GI815D,	51567
			HQNI/GI_D	



Abb.	Best.-Nr.	Beschreibung	Gerätetyp	Vergl.-Nr.
1	102250	Thermoelement	MPD/G2_	56914
2	375586	Sicherheitsthermo- stat	MPI/G2_	A5435
			PPNGD_	
			PPNGI_	

Abb.	Bestell-Nr.	Beschreibung	Gerätetyp	Vergl.-Nr.
1	100106	Zündbrenner	HPN/G_	57737, 51624,
			HPN/GI_	58329
2	100706	Zündkerze	HPA/GI_	51565, 56754
3	102253	Thermoelement	HQN/G_	51635
4	390045	Sicherheitsthermostat	HQN/GI_	51637

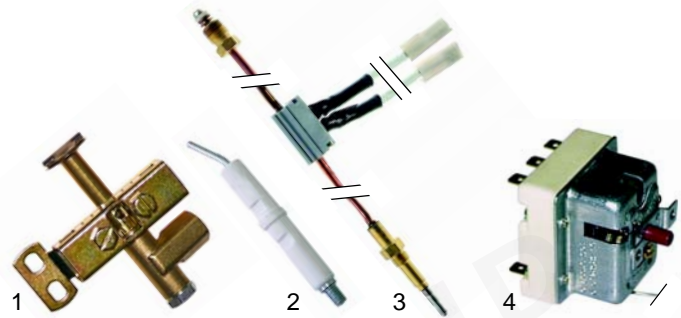
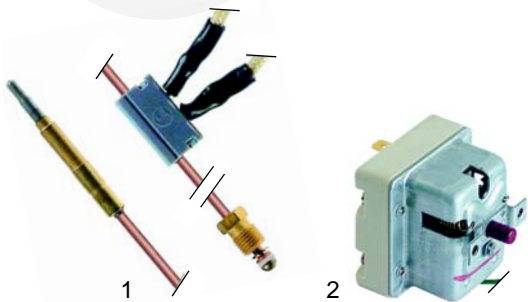

Abb.	Best.-Nr.	Beschreibung	Gerätetyp	Vergl.-Nr.
1	101091	Gashahn	HPN/G810,	54811
			HPN/G815,	
			HPN/GI 810,	
			HPN/GI 815,	
			HPA/GI 815,	
			HQN/G 917,	
			HQN/GI 917,	
			HQN/G 1225,	
			HQN/GI 1225	
2	110045	Knebel		52138
3	100007	Piezozünder		52539

Abb.	Bestell-Nr.	Beschreibung	Gerätetyp	Vergl.-Nr.
1	101091	Gashahn	HPN/GD_	59505, 54811
2	110448	Knebel	HPN/GI_	59378
3	100012	Piezozünder	HPA/GD_	02605
4	101339	Haube	HPA/G5	02605, 02816



Abb.	Bestell-Nr.	Beschreibung	Gerätetyp	Vergl.-Nr.
1	100050	Zündbrenner	HPN/GD_	59379
2	100701	Zündkerze	HPN/GI_	59380
3	102250	Thermoelement	HPA/G5	56914

Z

Passend für Zanussi



Abb.	Bestell-Nr.	Beschreibung	Gerätetyp	Vergl.-Nr.
1	375588	Sicherheitsthermostat 285°C/ bis Nr. 210_	HPN/GD, HPA/GI	53183
2	375589	Thermostat ab Nr. 211_		06709
3	375577	Sicherheitsthermostat 170°C	HPN/GI, HPA/GI	05295



Abb.	Bestell-Nr.	Beschreibung	Gerätetyp	Vergl.-Nr.
1	380015	Energieregler		55016
2	111608	Blende	NPG_	0C0317
3	111602	Knebel		0C0257

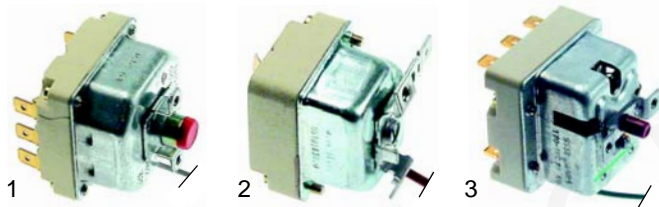

Abb.	Bestell-Nr.	Beschreibung	Gerätetyp	Vergl.-Nr.
1	300074	Schalter		A2162
2	110449	Knebel	HPN/GI 810, HPN/GI 815-816,	59333
3	101948	Magnetventil	HPN/GI 805, HPN/GI 806	59509
4	541350	Pressostat		A2480
5	359364	Signallampe		58658



Abb.	Bestell-Nr.	Beschreibung	Gerätetyp	Vergl.-Nr.
1	541350	Pressostat		A2480
2	373017	Magnetventil		55132
3	359364	Signallampe/grün	NPG_	05010
4	359367	Signallampe/rot		0C0687

Kochkessel (Elektro)



Abb.	Bestell-Nr.	Beschreibung	Gerätetyp	V.-Nr.
1	101898	Zündbrenner		0C0744
2	100701	Zündkerze	HPN/GI 810, HPN/GI 815-816,	59380
3	102250	Thermoelement	HPN/GI 805, HPN/GI 806	56914
4	375577	Sicherheitsthermostat	NPGI	05295
4	375675	Sicherheitsthermostat	NPGD	0C1000

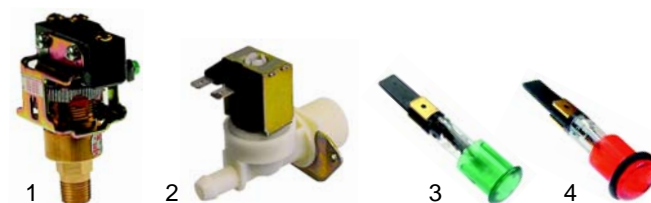

Abb.	Bestell-Nr.	Beschreibung	Gerätetyp	Vergl.-Nr.
1	418189	4700W/230V mit Tauchhülse	RPN/EI 660, MPN/EI 760,	49307, 02524, 26453, 57698
2	415069	4500W/230V ohne Tauchhülse	MPI/E 240, MPI/E260, MPI/E260P,	5557, 02523, 45518
3	510408	Dichtung	PPNEI 740, PPNEI 760,	46213
4	520236	Flansch	PPNEI 761, HPN/EI 805, HPN/EI 806	65558

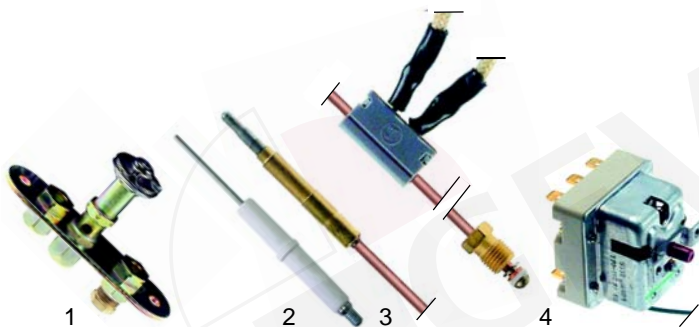

Abb.	Bestell-Nr.	Beschreibung	Gerätetyp	Vergl.-Nr.
1	301216	Schalter		59544
2	111675	Blende	NPG_	0C0711
3	111602	Knebel		0C0257



Abb.	Bestell-Nr.	Beschreibung	Gerätetyp	Vergl.-Nr.
1	418006	750V/230V	HPN/E810, HPN/E815,	59681, 51854, 51857
2	418007	1050W/230V	HPN/ED810, HPN/ED811,	59680, 51855, 51858
3	418008	1250W/230V	HPN/ED816, HPA/ED825	59679, 51856, 51859

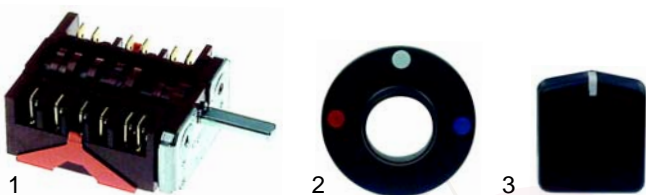

Abb.	Best.-Nr.	Beschreibung	Gerätetyp	Vergl.-Nr.
1	418190	6000W/230V		03409, 03410
2	550680	Flansch	HPN/EI 855, HPN/EI 1255	03534

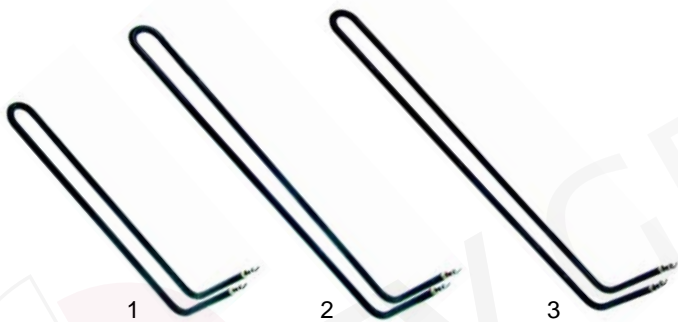

Abb.	Bestell-Nr.	Beschreibung	Gerätetyp	Vergl.-Nr.
1	415069	4500W/230V	HPN/EI 815	65557, 45518
2	415379	6000W/230V mit Tauchhülse	HPE/EI 815, HPN/EI 917, HPN/EI 1225, HQN/EI_	51632, 51633
3	415405	6000W/230V ohne Tauchhülse	HPN/EI 917, HPN/EI 1225, HQN/EI_	66110, 45559, 58011, 76035
4	510408	Dichtung		46213
5	520236	Flansch		65558



Abb.	Best.-Nr.	Beschreibung	Gerätetyp	V.-Nr.
1	300009	Schalter		51647
2	111639	Knebel	RPN/EI 760	51697
3	300102	Schalter		50857
4	111638	Knebel		26797



Abb.	Best.-Nr.	Beschreibung	Gerätetyp	V.-Nr.
1	390165	Sicherheitsthermostat		51644
2	359109	Signalelement/grün	RPN/EI 760	54150
2	359110	Signalelement/gelb		53811
3	359803	Linse/grün		54151
4	359804	Linse/gelb		75589

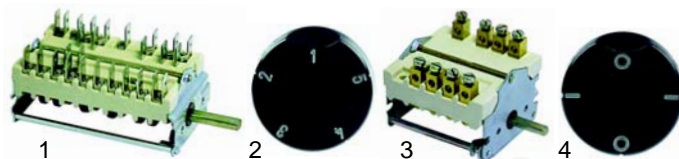

Abb.	Best.-Nr.	Beschreibung	Gerätetyp	Vergl.-Nr.
1	380015	Energeregler		55016
2	110346	Knebel	MPN/EI 760	02522
3	390165	Sicherheitsthermostat		51644
4	359364	Signallampe/grün		58658, 05010
5	359365	Signallampe/gelb		05012

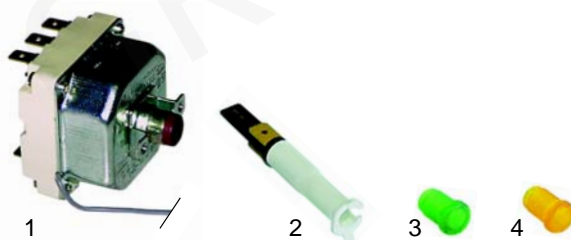

Abb.	Best.-Nr.	Beschreibung	Gerätetyp	V.-Nr.
1	418189	4700W/230V	NPEI 806	02524
2	418126	7500W/230V	NPN/EI_ (2 Gen.), HPNS/EI_ (2 Gen.), HPA/EI_ (2 Gen.),	59665
3	418017	10750W/230V	NPEI 810, NPEI 815	0C0715
4	510408	Dichtung		46213

Z

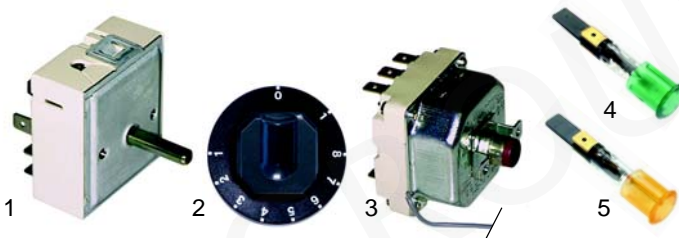
Passend für Zanussi



Abb.	Best.-Nr.	Beschreibung	Gerätetyp	Vergl.-Nr.
1	301210	Schalter	MPI/E 240,	04741
2	110428	Knebel	MPI/E 260,	59230
3	301216	Schalter	MPI/E 260P,	59544
4	111676	Knebel	PPNEI 740, PPNEI 760, PPNEI 761	04885



Abb.	Best.-Nr.	Beschreibung	Gerätetyp	Vergl.-Nr.
1	380015	Energiregler	HPN/EI (2.Gen.),	55016
2	110429	Knebel	HPN/ED_, MPA/ED_,	59554
3	359364	Signallampe grün	MPA/EL_	58658
4	541350	Pressostat	HPN/EI806	A2480

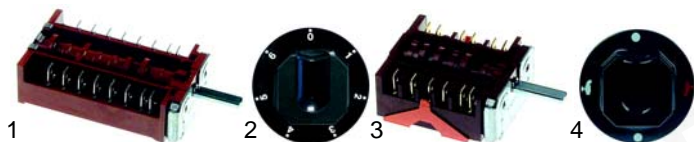

Abb.	Best.-Nr.	Beschreibung	Gerätetyp	Vergl.-Nr.
1	375209	Sicherheitsthermostat	MPI/E 240,	04862
2	373017	Magnetventil	MPI/E 260,	55132
3	359364	Signallampe/grün	MPI/E 260P	05010
4	541350	Pressostat	MPI/E 260P, PPNEI761	A2480

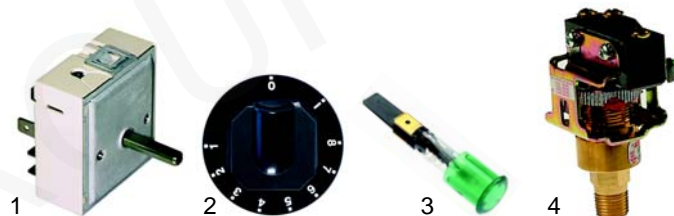

Abb.	B.-Nr.	Beschreibung	Gerätetyp	V.-Nr.
1	375571	Sicherheitsthermostat	HPN/E810, HPN/E815	51454
2	390044	Sicherheitsthermostat	HPN/EI_, HQN/EI_	51636
3	375563	Sicherheitsthermostat	HPN/ED	04600
4	375209	Sicherheitsthermostat	HPN/EI (2. Gen.)	04862



Abb.	Best.-Nr.	Beschreibung	Gerätetyp	Vergl.-Nr.
1	300009	Schalter		51647
2	110042	Knebel	HPN/E,	51552
3	300102	Schalter	HPN/EI	50857
4	110043	Knebel		50341

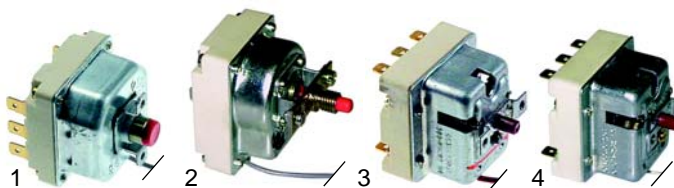

Abb.	Best.-Nr.	Beschreibung	Gerätetyp	Vergl.-Nr.
1	300008	Schalter		51634
2	110042	Knebel	HQN/EI917,	51552
3	300020	Schalter	HQN/EI1225	28390
4	110043	Knebel		50341



Pos.	B.-Nr.	Beschreibung	Gerätetyp	V.-Nr.
1	541349	Pressostat		55052



Abb.	Best.-Nr.	Beschreibung	Gerätetyp	Vergl.-Nr.
1	380015	Energiregler	NPEI806,	55016
2	111608	Blende	NPEI810,	0C0317
3	111602	Knebel	NPEI815	0C0257



Abb.	Best.-Nr.	Beschreibung	Gerätetyp	Vergl.-Nr.
1	301216	Schalter	NPEI806,	59544
2	111675	Blende	NPEI810,	0C0711
3	111602	Knebel	NPEI815	0C0257

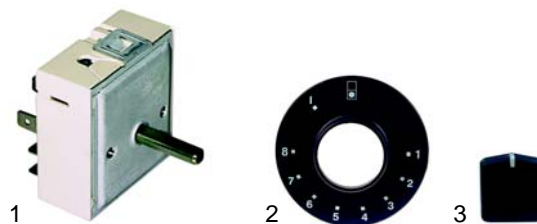

Abb.	Best.-Nr.	Beschreibung	Gerätetyp	Vergl.-Nr.
1	375209	Sicherheitsthermostat		04862
2	541350	Pressostat		A2480
3	373017	Magnetventil	NPEI806, NPEI810, NPEI815	55132
4	359364	Signallampe/grün		05010
5	359367	Signallampe/rot		0C0687

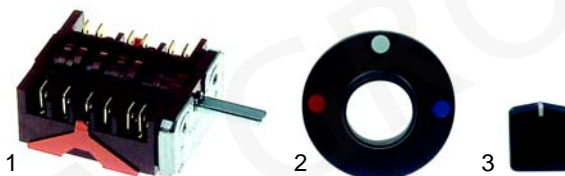

Abb.	Best.-Nr.	Beschreibung	Gerätetyp	Vergl.-Nr.
1	540991	Einlaufhahn		A5258
2	540933	Verlängerung	MPD/ MPI,	A2135
3	111643	Knebel	PPNG_ PPNE_	04483
4	111667	Knebel		04482
5	540966	Einlaufrohr		04537

Kochkessel (Mechanik)

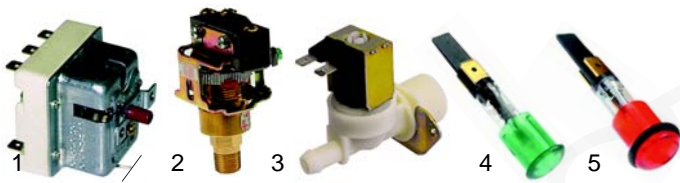

Abb.	Best.-Nr.	Beschreibung	Gerätetyp	Vergl.-Nr.
1	540971	Einlaufhahn/rechts		25733, 03516
2	540930	Einlaufhahn/links		26537, 03517
3	111642	Knebel	RPN/_	51694
4	111678	Knebel		51695
5	550843	Schraube		51675
6	540990	Einlaufrohr		51672



Abb.	Best.-Nr.	Beschreibung	Gerätetyp	Vergl.-Nr.
1	540971	Einlaufhahn/rechts		25733
2	540930	Einlaufhahn/links		26537
3	110287	Knebel/schwarz	HPN/_ (1 Gen.), HQN/_ (1 Gen.), HPA/_ (1 Gen.)	25260, 54254
4	110288	Deckel		54367
5	540992	Einlaufrohr		54521



Abb.	Best.-Nr.	Beschreibung	Gerätetyp	Vergl.-Nr.
1	540971	Einlaufhahn/rechts		03516
2	540930	Einlaufhahn/links		03517
3	111642	Knebel	MPN/	58632
4	111678	Knebel		58708
5	540990	Einlaufrohr		51672



Abb.	Best.-Nr.	Beschreibung	Gerätetyp	Vergl.-Nr.
1	540971	Einlaufhahn/rechts		03516
2	540930	Einlaufhahn/links		03517
3	111644	Knebel	HPN/_ (2 Gen.), HPA/_ (2 Gen.), HPNS/_ (2 Gen.)	59531
4	111680	Knebel		59516
5	540992	Einlaufrohr		51521

Z

Passend für Zanussi



nicht mehr
lieferbar

Abb.	Best.-Nr.	Beschreibung	Gerätetyp	Vergl.-Nr.
1	540822	Armaturenräger		54808
2	540823	Sicherheitsventil	RPN/_, MPN/_,	04863, 54806
3	540825	Ent- + Belüfter	MPI/_, PPN_I_	51566
4	540834	Deckel		27297
5	n.m.l.	Probierhahn		51568



Abb.	Best.-Nr.	Beschreibung	Gerätetyp	Vergl.-Nr.
1	540999	Entleerhahn, M68x3	RPN/_	52907, 050137
2	548001	Entleerhahn, M68x3	MPN/_ , MPD/_ , MPI/_ , PPN_	02520



nicht mehr
lieferbar

Abb.	Best.-Nr.	Beschreibung	Gerätetyp	Vergl.-Nr.
1	540721	Sicherheitsventil		57493, 56691
2	540993	Manometerträger	HPN/_ , HQN/_ , NPGI, NPEI	51642
3	540825	Ent- + Belüfter		51566
4	540834	Deckel		27297
5	n.m.l.	Probierhahn		51568



Abb.	Best.-Nr.	Beschreibung	Gerätetyp	Vergl.-Nr.
1	540157	Entleerhahn, M78x3mm	HPN/_ , HPA/_	53159, 050138
2	540275	Entleerhahn, 2"	HPN/_ , HPA/_	08027, 050135



Abb.	Best.-Nr.	Beschreibung	Gerätetyp	Vergl.-Nr.
1	541062	Manometer	HPN, HQN	17055
2	541334	Manometer	HPN (2 Gen.)	59515
3	541339	Manometer	NPGI_ , NPEI_	0C0712



Abb.	Best.-Nr.	Beschreibung	Gerätetyp	Vergl.-Nr.
1	693296	Adapter	MPN/__D	56923
2	693297	Adapter	HPN/__D	55403
3	540134	Entleerhahn	MPN/__D, HPN/__D	52882



Abb.	Best.-Nr.	Beschreibung	Gerätetyp	Vergl.-Nr.
1	540722	Sicherheitsventil	Autoclave-Geräte	52623
2	514304	Sicherheitsventil	MPN/__D	59663
3	540826	Ent- + Belüfter		59664



Abb.	Best.-Nr.	Beschreibung	Gerätetyp	Vergl.-Nr.
1	693298	Halter/links		52892
2	693299	Feder		52894
3	693300	Buchse	RPN/, MPN/	52897
4	693301	Halter/rechts		52891

Z

Passend für Zanussi



Abb.	Best.-Nr.	Beschreibung	Gerätetyp	Vergl.-Nr.
1	693302	Halter	MPI/_, MPD/_, PPN_	04849
2	693304	Feder		04850
3	693305	Spanner		A2612



Abb.	Best.-Nr.	Beschreibung	Gerätetyp	Vergl.-Nr.
1	693307	Halter	HPN/_ (2 Gen.)	02944
2	693308	Buchse		59864
3	693309	Buchse		59863
4	693310	Buchse		59865
5	693311	Schraube		59860
6	693312	Schraube		59859



Abb.	Best.-Nr.	Beschreibung	Gerätetyp	Vergl.-Nr.
1	693306	Halter/rechts	HPN/, HPA/, HQN/	02106, 51288
2	693285	Buchse/rechts		51266
3	693287	Buchse/links		51267
4	693288	Halter/links		51260, 02107



Abb.	Best.-Nr.	Beschreibung	Gerätetyp	Vergl.-Nr.
1	693313	Feder	HPN/_ (H900)	51527
2	693286	Feder	HQN/_ (H900)	51268
3	693314	Feder	HPN/_ (H0920), HPA/_ (H0920)	59528
4	693315	Feder	HPN/_825, HPA/_825	02981
5	693316	Feder	NPG_, NPI_	59518

Heißluftgeräte



Abb.	Best.-Nr.	Beschreibung	Gerätetyp	Vergl.-Nr.
1	375664	Thermostat	FCF/E4	54323
2	301095	Vorsatzschalter		54324
3	111684	Knebel		54278, 66204



Abb.	Best.-Nr.	Beschreibung	Gerätetyp	Vergl.-Nr.
1	375665	Thermostat	FCF/E4 (240271/2)	05207
2	111686	Knebel		05208
3	301229	Schalter		05213
4	111687	Knebel		05209

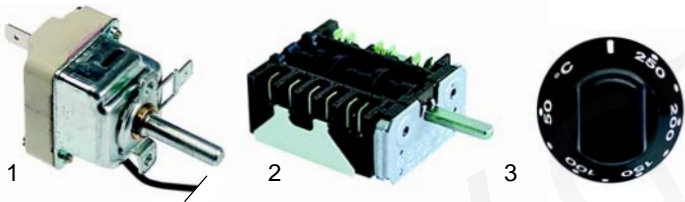

Abb.	Best.-Nr.	Beschreibung	Gerätetyp	Vergl.-Nr.
1	350008	Timer	FCF/E4	53817
2	110048	Knebel		53814
3	350162	Timer	FCF/E4 (Neu)	03431
4	n.m.l.	Knebel		55434

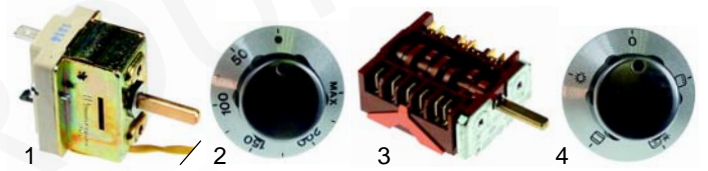

Abb.	Best.-Nr.	Beschreibung	Gerätetyp	Vergl.-Nr.
1	350163	Timer	FCF/E4 (240271/2)	05216
2	111688	Knebel		05210
3	359140	Signalelement, gelb		05215
4	359138	Signalelement, rot		05214
5	359845	Linse, gelb		05211
6	359844	Linse, rot		05212

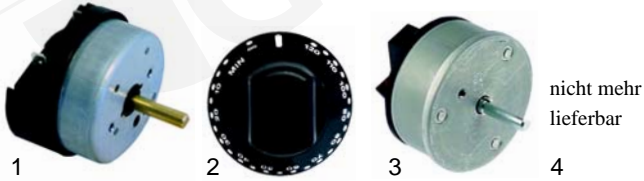

Pos.	Best.-Nr.	Beschreibung	Gerätetyp	Vergl.-Nr.
1	111770	Knebelset (3-teilig)	FCF/E4 (Neu)	06948

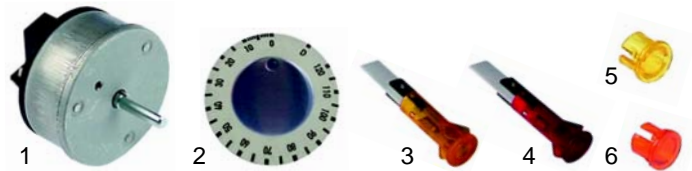
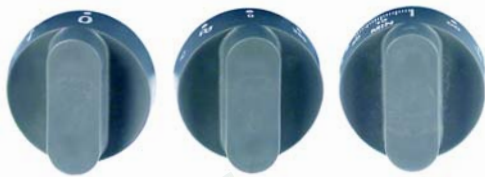

Abb.	Best.-Nr.	Beschreibung	Gerätetyp	Vergl.-Nr.
1	390068	Thermostat	FCF/_6, FCF/E2	57937
2	300001	Vorsatzschalter		54375
3	110472	Knebel		54594, 53813



Abb.	Best.-Nr.	Beschreibung	Gerätetyp	Vergl.-Nr.
1	390068	Thermostat	FCF/E3 (240270)	57937
2	300001	Vorsatzschalter		54375
3	111685	Knebel		03981

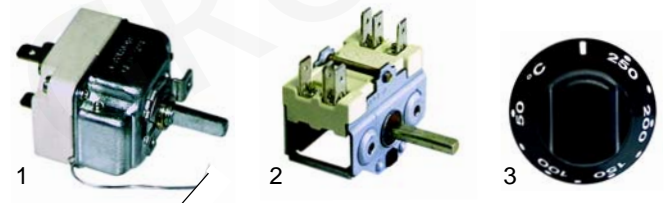

Abb.	Best.-Nr.	Beschreibung	Gerätetyp	Vergl.-Nr.
1	390068	Thermostat	FCF/_10, FCF/_20	57937
2	110472	Knebel		53813

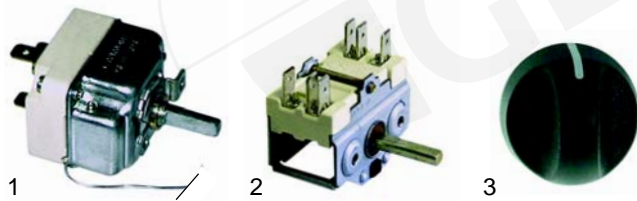

Abb.	Best.-Nr.	Beschreibung	Gerätetyp	Vergl.-Nr.
1	360341	Timer	FCF/E3 (240270)	03833
2	345161	Schalter		54518
3	345039	Schutzhaube		53979

Z

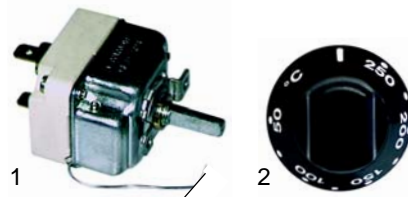
Passend für Zanussi

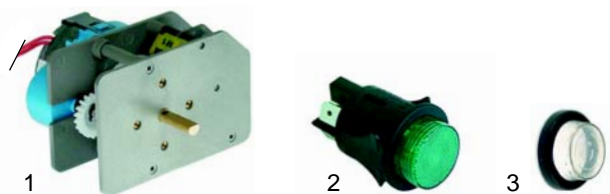

Abb.	Best.-Nr.	Beschreibung	Gerätetyp	Vergl.-Nr.
1	350008	Timer		53817, 03432
2	110048	Knebel	FCF/E2 (bis 91), FCF/_6 (bis 91), FCF/_10	53814, 03850
3	380017	Energieregler		53695
4	110473	Knebel		54595, 53815



Abb.	Best.-Nr.	Beschreibung	Gerätetyp	Vergl.-Nr.
1	359110	Signalelement/gelb		53811
2	359109	Signalelement/grün	Universal	54150
3	359804	Linse/gelb		53812
4	359803	Linse/grün		54151



Abb.	Best.-Nr.	Beschreibung	Gerätetyp	Vergl.-Nr.
1	350004	Timer		55366
2	110475	Knebel		55434, 55364
3	380015	Energieregler	FCF/E2 (ab 91), FCF/_6 (ab 91)	55016
4	110473	Knebel		54595, 53815



Abb.	Best.-Nr.	Beschreibung	Gerätetyp	Vergl.-Nr.
1	379060	Fühler	FCF/_6, FCFV/_61, FCF/_10	02673
2	379976	Fühler	FCF/_102	02821

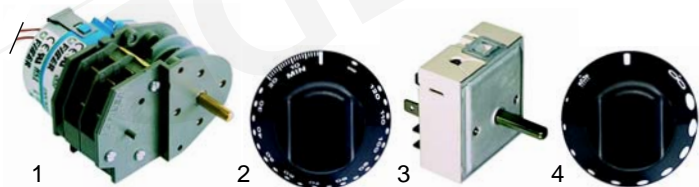

Abb.	Best.-Nr.	Beschreibung	Gerätetyp	Vergl.-Nr.
1	380015	Energieregler		55016
2	301094	Vorsatzschalter	FCF/_10 (ab 91)	55017
3	110474	Knebel		55026



Abb.	Best.-Nr.	Beschreibung	Gerätetyp	Ver.-Nr.
1	379061	Fühler	FCF/_20 (bis 039), FCF/_201 (bis 039), FCF/_202 (bis 039)	03853
2	379977	Fühler	FCF/_20 (ab 040), FCF/_201 (ab 040), FCF/_202 (ab 040)	06174

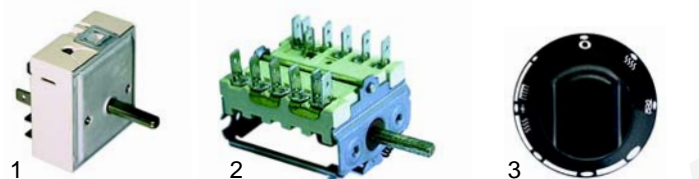

Abb.	Best.-Nr.	Beschreibung	Gerätetyp	Vergl.-Nr.
1	345983	Schalter 0-I		53810
2	346384	Schalter I-II	FCF/_10 (bis 91), FCF/_20 (bis 91)	53837
3	346385	Umschalter		54552



Abb.	Best.-Nr.	Beschreibung	Gerätetyp	Vergl.-Nr.
1	346386	Schalter	FCF/_10 (ab 91), FCF/_20 (ab 91)	58808
2	345390	Schalter	FCF/G20, FCF/G40	54547, 55014

Z

Passend für Zanussi



Abb.	Best.-Nr.	Beschreibung	Gerätetyp	Vergleichs-Nr.
1	401130	Frontfolie	FCF/_6	03689
2	401131	Frontfolie	FCF/_101, FCF/_102	03714
3	401132	Frontfolie	FCF/_201, FCF/_202	03838



Abb.	Best.-Nr.	Beschreibung	Gerätetyp	Vergleichs-Nr.
1	400744	Elektronik	FCF/_	03763
2	379060	Fühler/Kerntemperatur	FCF/_101	02673
2	379061	Fühler/Kerntemperatur	FCF/_201, FCF/_202	03853

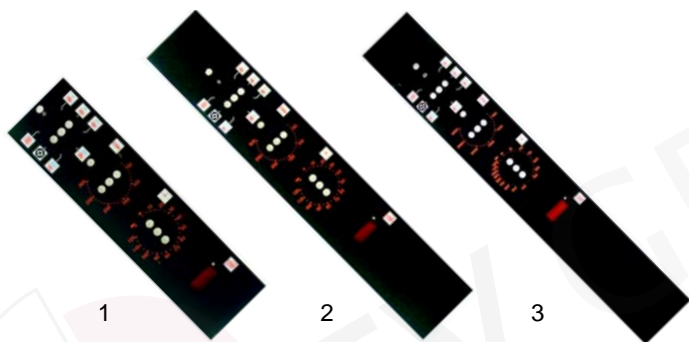

Abb.	Best.-Nr.	Beschreibung	Gerätetyp	Vergleichs-Nr.
1	111710	Knebel		02672
2	359139	Signallampe/grün	Universal	58544
3	359140	Signallampe/gelb		58522

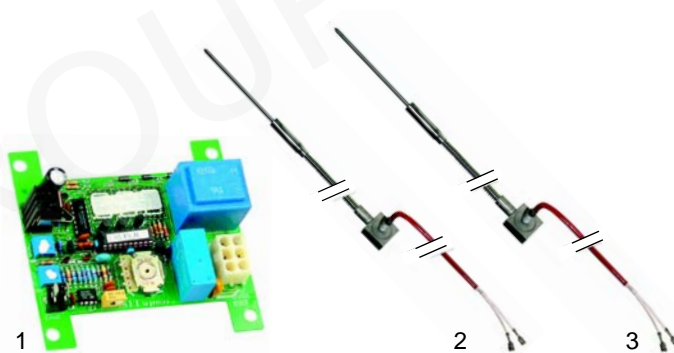

Abb.	Best.-Nr.	Beschreibung	Gerätetyp	Vergl.-Nr.
1	693429	Buchse		02662
2	693432	Dichtung	FCF/_ (Kerntemperatur-Elektronikregler)	02663
3	693430	Mutter		51263
4	693431	Scheibe		02727
5	111773	Knebel		02671



Abb.	Best.-Nr.	Beschreibung	Gerätetyp	Vergl.-Nr.
1	345651	Schalter		03766
2	346310	Elementträger	Kerntemperatur Zuschutz FCF/_	03767
3	346311	Taste		03768
4	345039	Schutzhaube		53979

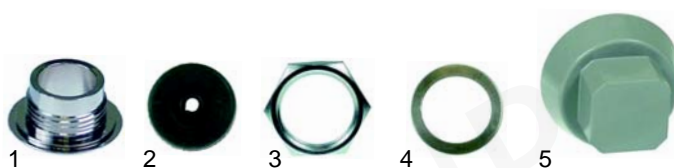

Abb.	Best.-Nr.	Beschreibung	Gerätetyp	Vergl.-Nr.
1	375572	Sicherheitsthermostat	FCF/G_ (bis '97)	53980
2	375579	Sicherheitsthermostat	FCF/G_ (ab '97), FCF/E2 (ab '91), FCF/E3	03594
3	375162	Sicherheitsthermostat	FCF/E2, FCF/E40	58198

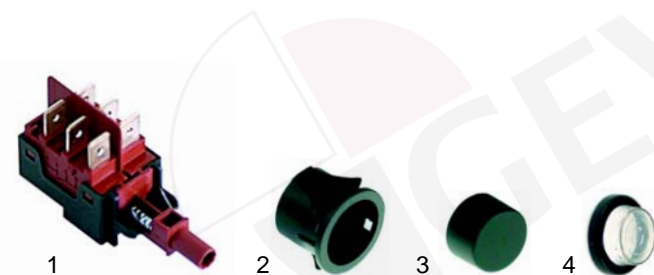

Abb.	Best.-Nr.	Beschreibung	Gerätetyp	Vergleichs-Nr.
1	375625	Anlegethermostat	FCF/E4 (bis '97)	54321
2	375170	Sicherheitsthermostat	FCF/E4 (ab '97)	02711
3	375624	Anlegesicherheits-thermostat	FCF/E4 (ab '00)	05206
4	375666	Anlegethermostat		05203

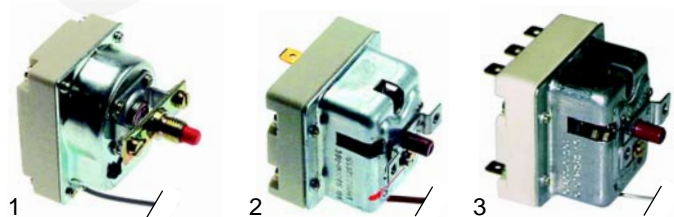

Abb.	Best.-Nr.	Beschreibung	Gerätetyp	Vergl.-Nr.
1	601199	Motor		05202
2	601200	Lüfterrad	FCF/E4 (ab '00)	05221
3	418083	3000W/230V		55503

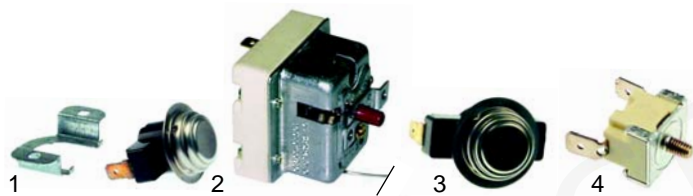

Abb.	Best.-Nr.	Beschreibung	Gerätetyp	Vergleichs-Nr.
1	375167	Sicherheitsthermostat	FCF/E__	02730
2	350070	Alarmgeber		55368
3	373017	Magnetventil	Universal	53827, 47533, 55132



Abb.	Best.-Nr.	Beschreibung	Gerätetyp	Vergl.-Nr.
1	418081	200W/230V	FCF/E4 (bis '00)	54326
2	418082	2550W/230V	FCF/E4 (ab '00)	05205
3	418078	1000W/230V		05218



Abb.	Best.-Nr.	Beschreibung	Gerätetyp	Vergl.-Nr.
1	601198	Motor/kpl.	FCF/E2, FCF/E3,	54842
2	415117	2500W/230V	FCF/E2	54317, 54843

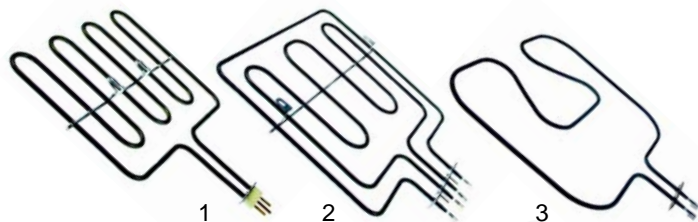

Abb.	Best.-Nr.	Beschreibung	Gerätetyp	Vergl.-Nr.
1	601040	Motor	FCF/_6	54829, 58587
2	601235	Lüfterrad		54585

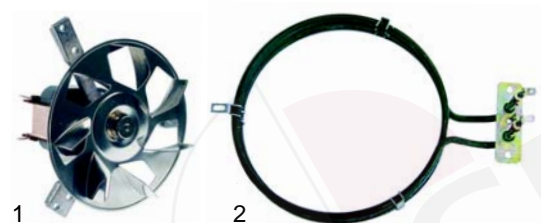

Abb.	Best.-Nr.	Beschreibung	Gerätetyp	Vergl.-Nr.
1	601201	Motor/kpl.	FCF/E4 (bis '00)	54314
2	418083	3000W/230V		55503
3	601004	Querstromlüfter	FCF/E4 (ab '00)	05204

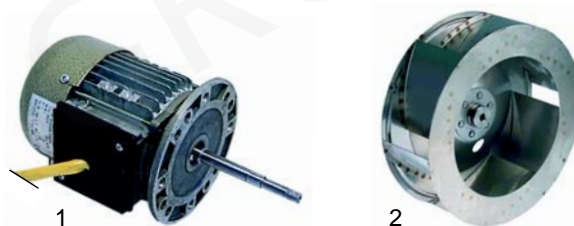

Abb.	Best.-Nr.	Beschreibung	Gerätetyp	Vergl.-Nr.
1	601041	Motor	FCF/_10	54836, 58667
2	601197	Lüfterrad		53782

Z

Passend für Zanussi



Abb.	Best.-Nr.	Beschreibung	Gerätetyp	Vergl.-Nr.
1	601042	Motor	FCF/_20, FCF/_40	54837, 58607
2	601218	Lüfterrad		54014



Abb.	Best.-Nr.	Beschreibung	Gerätetyp	Vergl.-Nr.
1	415391	8000W/230V	FCF/E20, FCF/E40	54051, 54289, 56929, 56934
2	415654	5660W/230V	FCF/E101, FCF/E201	02688

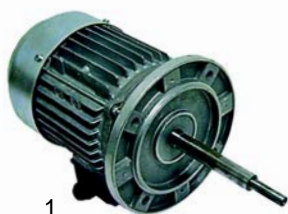

Abb.	Best.-Nr.	Beschreibung	Gerätetyp	Vergl.-Nr.
1	500141	Motor	FCF/_6 (ab '97), FCF/_101, FCF/ _201	02616, 0F0007
2	601220	Lüfterrad	FCF/_6 (ab '97)	03560
3	601197	Lüfterrad	FCF/_101	53782, 54890



Abb.	Best.-Nr.	Beschreibung	Gerätetyp	Vergl.-Nr.
1	415656	8000W/400V	FCF/E102, FCF/E202	A5330
2	550545	Dichtung	FCF/E6	57534
3	550546	Dichtung	FCF/E10, FCF/ E20, FCF/E40	53840
4	550547	Dichtung	FCF/E101	03726

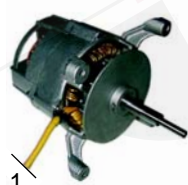

Abb.	Best.-Nr.	Beschreibung	Gerätetyp	Vergl.-Nr.
1	500143	Motor	FCF/_102, FCF/202	02739
2	601232	Lüfterrad		03715

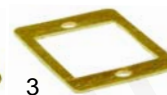

Abb.	Best.-Nr.	Beschreibung	Gerätetyp	Vergl.-Nr.
1	359376	Fassung		54320
2	359610	Lampe, 15W	FCF/E4	54319
3	359377	Linsennippel		54318

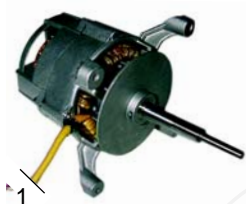

Abb.	Best.-Nr.	Beschreibung	Gerätetyp	Vergl.-Nr.
1	415351	2500W/230V	FCF/E6	54610, 54614, 56945, 58145
2	415389	5566W/230V	FCF/E10	58196, 58197, 53839



Abb.	Best.-Nr.	Beschreibung	Gerätetyp	Vergl.-Nr.
1	359375	Fassung	FCF/E3	03956
2	359612	Lampe, 25W		54840

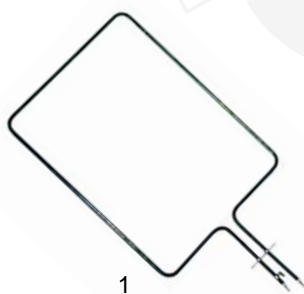

Abb.	Best.-Nr.	Beschreibung	Gerätetyp	Vergl.-Nr.
1	359713	Fassung		54991
2	359714	Dichtung		55022
3	359715	Glas	FCF/_40	
4	359716	Rahmen		
5	359612	Lampe		54840



Abb.	Best.-Nr.	Beschreibung	Gerätetyp	Vergl.-Nr.
1	359765	Flansch		02628
2	359764	Glas	FCF/_6 (ab '93), FCF/_101 (ab '93),	02627
3	359763	Dichtung	FCF/_102 (ab '93),	02626
4	359612	Lampe	FCF/_201 (ab '93),	54840
5	359701	Fassung	FCF/_202 (ab '93)	02625

Gaskomponenten

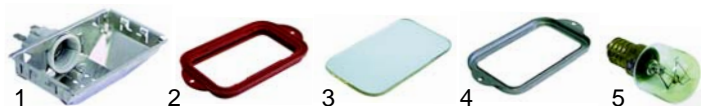

Abb.	Best.-Nr.	Beschreibung	Gerätetyp	Vergl.-Nr.
1	105764	Brenner	FCF/G6	54573
2	105765	Brenner	FCF/G10	53786



Abb.	Best.-Nr.	Beschreibung	Gerätetyp	Vergl.-Nr.
1	105766	Brenner	FCF/G20	54028
2	105767	Brenner	FCF/G40	55007
3	105768	Brenner	FCF/G6 (ab '97)	03677
4	105769	Brenner	FCF/G101, FCF/G102, FCF/G201	03709
5	105770	Brenner	FCF/G202	04831



Abb.	Best.-Nr.	Beschreibung	Gerätetyp	Vergl.-Nr.
1	101002	Zündgruppe		03376, 51884
2	100052	Zündbrenner	FCF/G6 FCF/G10	57411
3	100051	Zündbrenner	FCF/G20 FCF/G40 FCF/G6 (ab '97) FCF/G101, 102, 202	54032



Abb.	Best.-Nr.	Beschreibung	Gerätetyp	Vergl.-Nr.
1	100701	Zündkerze	Universal	52610
2	102070	Thermoelement		54055



Abb.	Best.-Nr.	Beschreibung	Gerätetyp	Vergl.-Nr.
1	101183	Compositventil	FCF/G6 (ab '97)	53973
2	101127	Elettrositventil	FCF/G10	57543
3	101312	Mikroschalter	FCF/G20 FCF/G40	54539



Abb.	Best.-Nr.	Beschreibung	Gerätetyp	Vergl.-Nr.
1	101761	Novasitventil	FCF/G6 (ab '97), FCF/G101, 201, 202	03719
2	101760	Novasitventil	FCF/G101	06182
3	111646	Knebel		03704



Abb.	Best.-Nr.	Beschreibung	Gerätetyp	Vergl.-Nr.
1	690874	Griff		02717
2	700470	Halter		03826
3	700471	Lager	FCF/___201 FCF/___202	03994
4	700472	Flansch		04098
5	700488	Getriebe		03824



Abb.	Best.-Nr.	Beschreibung	Gerätetyp	V.-Nr.
1	900187	Türdichtung, 585 x 395mm	FCF/___6 (bis'97)	55414
2	900190	Fensterdichtung		55412

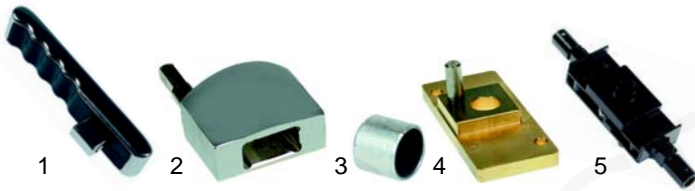

Abb.	B.-Nr.	Beschreibung	Gerätetyp	Vergl.-Nr.
1	900433	Türdichtung, 635 x 430mm	FCF/___6 (ab'97)	04226, 05713
2	900272	Fensterdichtung		03680

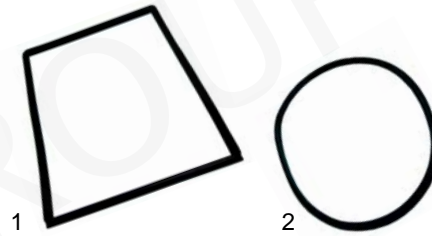

Abb.	Best.-Nr.	Beschreibung	Gerätetyp	Vergl.-Nr.
1	690869	Stange		03825
2	690041	Riegelstück		03822
3	690875	Konsole	FCF/___201 FCF/___202	04104
4	700491	Dichtung		03990
5	690040	Kloben		04232

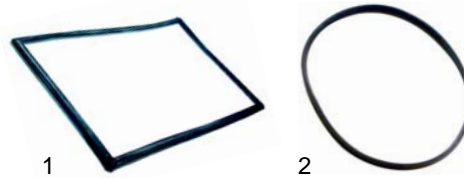

Abb.	Best.-Nr.	Beschreibung	Gerätetyp	Vergl.-Nr.
1	900188	Türdichtung, 640 x 720mm	FCF/___10 FCF/___20 (ab'86)	55315
2	900189	Türdichtung, 645 x 715mm	FCF/___20 (bis'86)	53751
3	900275	Türdichtung, 645 x 1380mm	FCF/___40	54986
4	900270	Fensterdichtung	Universal	53754, 57866

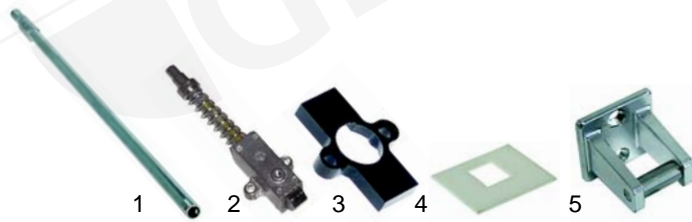

Abb.	Best.-Nr.	Beschreibung	Gerätetyp	Vergl.-Nr.
1	541090	Thermometer	FCF/___(ab'97)	56383
2	541353	Thermometer	FCF/___	53808
3	507317	Dichtung	Universal	53809

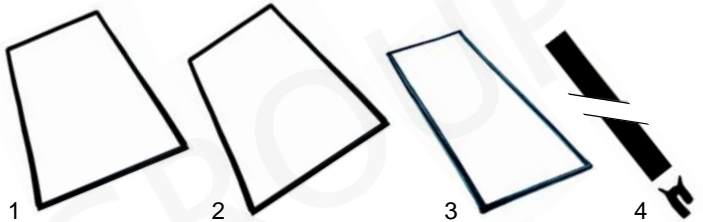

Abb.	Best.-Nr.	Beschreibung	Gerätetyp	Vergl.-Nr.
1	900160	Türdichtung, 660 x 730mm	FCF/___101 FCF/___102	04227, 05712
2	900434	Türdichtung, 660 x 1395mm	FCF/___201 FCF/___202	03955, 05711
3	900269	Fensterdichtung/innen	FCF/___101	03739
4	900186	Fensterdichtung /ußen	FCF/___102 FCF/___201 FCF/___202	02878



Abb.	Best.-Nr.	Beschreibung	Gerätetyp	Vergl.-Nr.
1	900273	Türdichtung	FCF/E2	54850
2	900270	Fensterdichtung	FCF/E2/ E3/ E4	57866

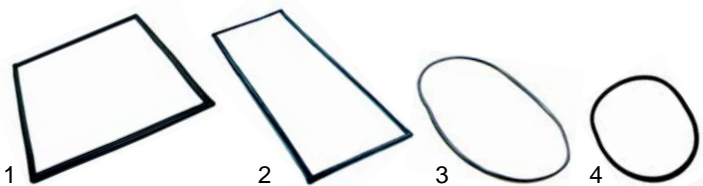

Abb.	Best.-Nr.	Beschreibung	Gerätetyp	Vergl.-Nr.
1	900277	Türdichtung		56341, 05885
2	900279	Fensterdichtung	FCF/E4 (ab '00)	05194

Combidämpfer

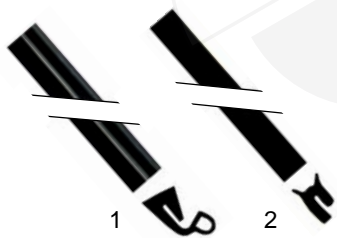
Frontblende

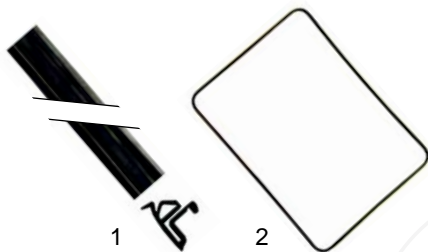

Abb.	Best.-Nr.	Beschreibung	Gerätetyp	Vergl.-Nr.
1	300014	Programmschalter	FCV/_6	55365
2	111761	Knebel	FCV/_10	55363, 56127
3	390068	Thermostat	FCV/_20	57937
4	110472	Knebel	FCV/_202V	53813



Abb.	Best.-Nr.	Beschreibung	Gerätetyp	Vergl.-Nr.
1	350004	Timer	FCV/_6	55366
2	111715	Knebel	FCV/_10	55434
3	380015	Energeregler	FCV/_20	55016
			FCV/_202V	

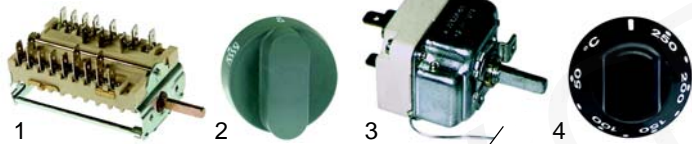

Abb.	Best.-Nr.	Beschreibung	Gerätetyp	Ver.-Nr.
1	359110	Signalelement/klar		55811
1	359109	Signalelement/grün	FCV/_6 (bis '91)	54150
2	359803	Linse grün	FCV/_10 (bis '91)	54151
3	359804	Linse gelb	FCV/_20 (bis '91)	53812
4	359805	Linse rot	FCV/_202V (bis '91)	75589



Abb.	Best.-Nr.	Beschreibung	Gerätetyp	Ver.-Nr.
1	359139	Signallampe/grün	FCV/_6 (ab '91)	58544
2	359140	Signallampe/gelb	FCV/_10 (ab '91)	58522
3	359138	Signallampe/rot	FCV/_20 (ab '91)	58605
			FCV/_202V (ab '91)	

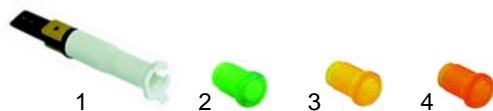

Abb.	Best.-Nr.	Beschreibung	Gerätetyp	Ver.-Nr.
1	301093	Programmschalter		56674
2	300020	Kerntemperaturschalter	FCV/E_CE	28390
3	111762	Dichtung		56500
4	111763	Knebel		56503



Abb.	Best.-Nr.	Beschreibung	Gerätetyp	Ver.-Nr.
1	359842	Signallampe	FCV/E_CE	56501
2	359843	Taster		56504



Abb.	B.-Nr.	Beschreibung	Gerätetyp	V.-Nr.
1	400026	Elektronik Timer Thermostat		58673
2	400025	Elektronik Kerntemperatur	FCV/E_CE	58674
3	379107	Fühler		58669



Abb.	B.-Nr.	Beschreibung	Gerätetyp	Ver.-Nr.
1	401210	Frontfolie	FCV/E6-3CE	56673
2	401215	Frontfolie	FCV/E10-3CE FCV/E20-3CE	56680



Abb.	B.-Nr.	Beschreibung	Gerätetyp	Ver.-Nr.
1	401253	Elektronik		59000
2	401217	Frontfolie	FCV/_10-P FCV/E20-P	59288
3	379107	Fühler		58669

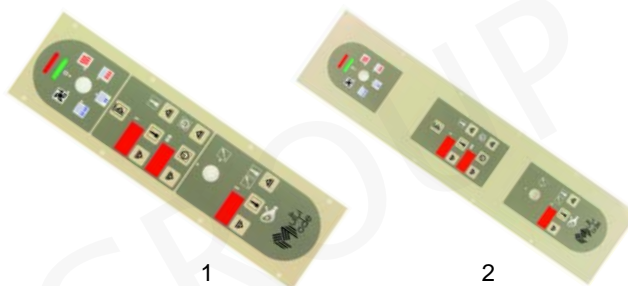

Abb.	B.-Nr.	Beschreibung	Gerätetyp	Ver.-Nr.
1	300068	Programmschalter		02661
2	360341	Timer	FCV/_-L2/L3	03833
3	111710	Knebel		02672

Z

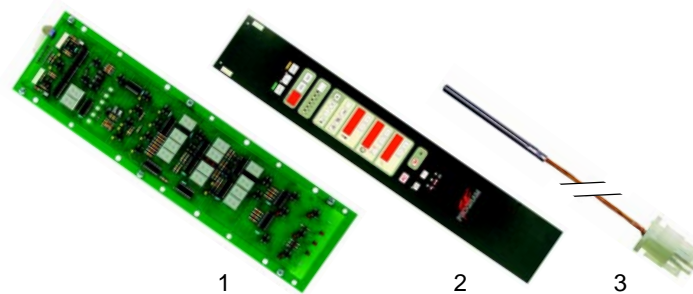
Passend für Zanussi

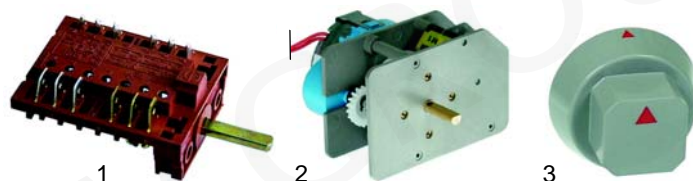

Abb.	Best.-Nr.	Beschreibung	Gerätetyp	Vergl.-Nr.
1	400179	Elektronik L3	FCV/___L2/L3	02665
2	400188	Elektronik L4	FCV/___L4	02725
3	400184	Elektronik L6	FCV/___L6	02720



Abb.	Best.-Nr.	Beschreibung	Gerätetyp	Vergl.-Nr.
1	401268	Elektronik	Active Line	06518
2	379100	Fühler	Universal	02615

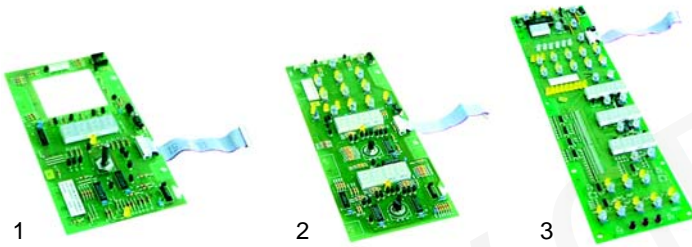

Abb.	Best.-Nr.	Beschreibung	Gerätetyp	Vergl.-Nr.
1	400745	Leistungsplatine	L2/L3	02684, 06715
2	400746	Leistungsplatine	L4/L6/ L4 Boiler/ L6 Boiler	04079, 06517, 03546
3	400748	Leistungsplatine	L3 Boiler	04105, 06716

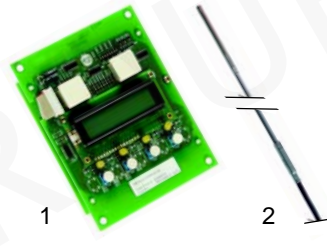

Abb.	Best.-Nr.	Beschreibung	Gerätetyp	Vergl.-Nr.
1	401212	Frontfolie	FCV/___6-L3	03834
2	401213	Frontfolie	FCV/___6-L4	03664
3	401249	Frontfolie	FCV/___6-L6	05623

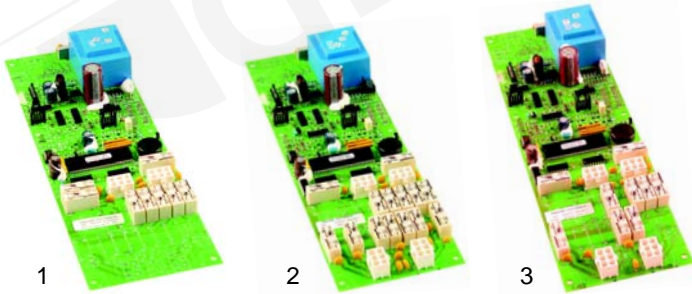

Abb.	Best.-Nr.	Beschreibung	Gerätetyp	Ver.-Nr.
1	401292	Elektronik Kerntemperatur	FCV/___L2	02683
1	400187	Elektronik Kerntemperatur		02666
2	693430	Mutter		51263
3	693431	Scheibe	FCV/___L3	02727
4	693429	Buchse	FCV/___L4	02662
5	693432	Dichtung		02663
6	111773	Knebel		02671



Abb.	Best.-Nr.	Beschreibung	Gerätetyp	Vergl.-Nr.
1	401216	Frontfolie	FCV/___10-L2	03835
2	401250	Frontfolie	FCV/___10-L3/ L4/ L6	03832
3	401247	Frontfolie		02719
4	401251	Frontfolie	FCV/___10-(Active)	06529



Abb.	Best.-Nr.	Beschreibung	Gerätetyp	Ver.-Nr.
1	400997	Druckknopf		02670
2	346287	Schalter		02418
3	345751	Schalter mit Druckknopf	Universal	05138
4	345753	Druckknopf		05137
5	345754	Schutzhaube		05109



Abb.	Best.-Nr.	Beschreibung	Gerätetyp	Vergl.-Nr.
1	400747	Tastatur Level A	AOS/___/A	0C0043
2	400751	Platine Level A		07047
3	400749	Tastatur Level B	AOS/___/B	0C0041



Abb.	Best.-Nr.	Beschreibung	Gerätetyp	Vergl.-Nr.
1	400750	Leistungsplatine	AOS___/_A AOS___/_B	0C0042
2	400752	Platine	AOS___/_G_	0C1071

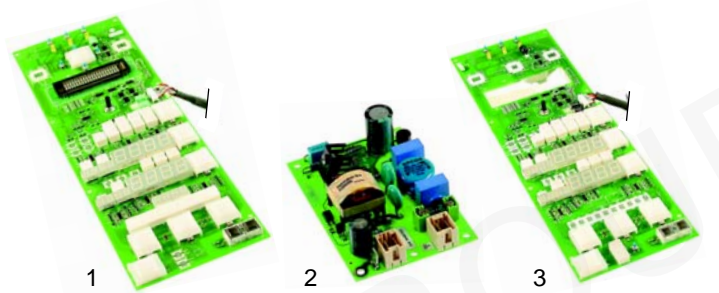

Abb.	Best.-Nr.	Beschreibung	Gerätetyp	Vergl.-Nr.
1	401211	Frontfolie	AOS___/_A	07057
2	401214	Frontfolie	AOS___/_B	07058

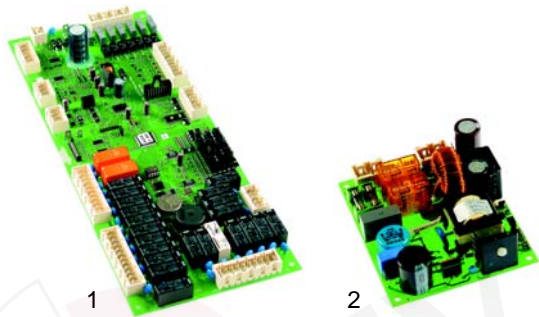

Abb.	Best.-Nr.	Beschreibung	Gerätetyp	Vergl.-Nr.
1	693431	Scheibe	AOS___/_	02727
2	693429	Buchse		02662
3	693430	Mutter		51263
4	111764	Knebel		07044

Kerntemperatur



Abb.	Best.-Nr.	Beschreibung	Gerätetyp	Vergl.-Nr.
1	301142	Schalter Kerntemperatur	FCV/_6	55473
2	111765	Knebel	FCV/_10 FCV/_20	55474
3	400190	Elektronik	FCV/_202V	55471



Abb.	Best.-Nr.	Beschreibung	Gerätetyp	V.-Nr.
1	379095	Fühler	FCV/_6 FCV/_10 (bis '91) FCV/_20 FCV/_20-P	55472
2	379037	Fühler	FCV/_10 (bis '91) FCV/_20-P	59002
3	379961	Fühler	FCV/_202V FCV/_202-P	58199 02330



Abb.	Best.-Nr.	Beschreibung	Gerätetyp	V.-Nr.
1	379969	Fühler (Mehrpunkt)	AOS061GA (ab Nr.340)	0C1164
2	379960	Fühler (Mehrpunkt)	AOS101GA (ab Nr.340)	0C0956

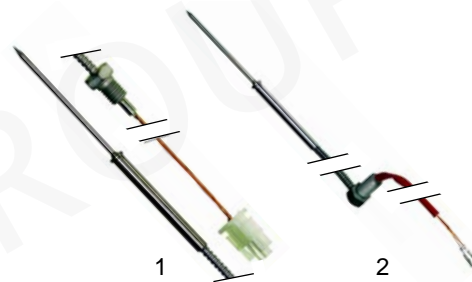

Abb.	Best.-Nr.	Beschreibung	Gerätetyp	Vergl.-Nr.
1	379968	Fühler (Einpunkt)	AOS201GA	0C1146
2	379970	Fühler (Mehrpunkt)	AOS202GA AOS202EA	0C1404

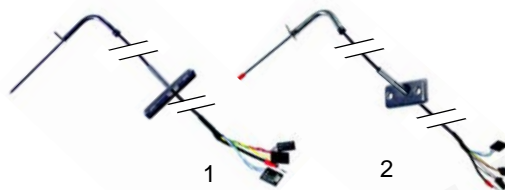

Abb.	Best.-Nr.	Beschreibung	Gerätetyp	Vergl.-Nr.
1	379967	Fühler (Einpunkt)	AOS201GB	0C0225
2	379959	Fühler (Einpunkt)	AOS202GB AOS202EB	0C1383

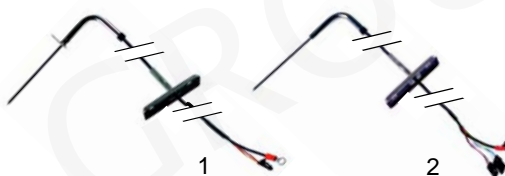

Abb.	Best.-Nr.	Beschreibg.	Gerätetyp	V.-Nr.
1	379956	Fühler (Mehrpunkt)	AOS061GA (bis Nr.339) AOS061EA AOS101GA (bis Nr.339)	006982
2	379958	Fühler (Einpunkt)	AOS061EB	006983

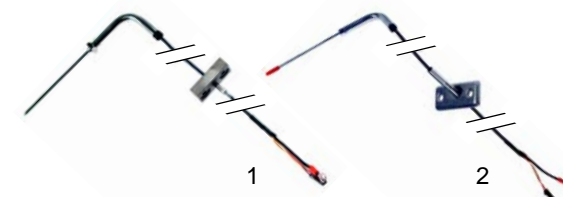

Abb.	Best.-Nr.	Beschreibung	Gerätetyp	Vergl.-Nr.
1	379955	Fühler (Mehrpunkt)	AOS101EA AOS201EA	007109
2	379957	Fühler (Einpunkt)	AOS101EB AOS201EB	007063

Türschalter

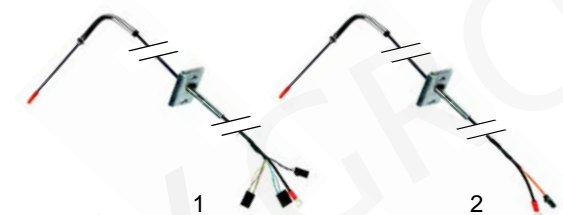

Abb.	Best.-Nr.	Beschreibung	Gerätetyp	Vergl.-Nr.
1	346376	Magnetschalter	FCV/_6 (bis 10/89)	26468
2	345254	Mikroschalter	FCV/_10 (bis 10/90) FCV/_20 (bis 10/90)	54550 53671

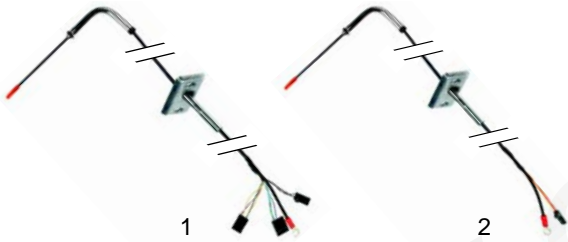

Abb.	Best.-Nr.	Beschreibg.	Gerätetyp	Vergl.-Nr.
1	345032	Mikroschalter	FCV/_6 (ab 10/89) FCV/_10 (ab 10/90) FCV/_61, FCV/_101, FCV/_201, FCV/_202	46063
2	346387	Mikroschalter	FCV/_20 (bis 4/90)	56944
3	345821	Magnetschalter	AOS___/___	49621

Niveauregelung



Abb.	B.-Nr.	Beschreibung	Gerätetyp	Vergl.-Nr.
1	400018	Niveauregler	Universal	56496, 55458
2	400120	Elektrode 94,5mm	FCV/G6	56449
3	400121	Elektrode 114,5mm	FCV/G6, FCV/E6 (bis 10/91), FCV/_10 (bis10/90) FCV/_20 (bis10/90)	55346

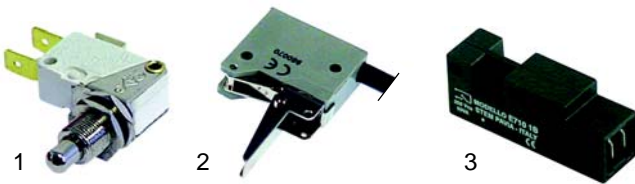

Abb.	B.-Nr.	Beschreibung	Gerätetyp	Vergl.-Nr.
1	401258	Elektrode 109mm	FCV/_10 (ab 10/90) FCV/_20 (ab 10/90)	12838
2	401259	Elektrode 143mm	FCV/G10 (ab 10/90) FCV/G20 FCV/EG (ab 10/91) FCV/EG202V	53909



Abb.	B.-Nr.	Beschreibung	Gerätetyp	Vergl.-Nr.
1	401255	Elektrode 50mm	FCV/G61	05765
2	401254	Elektrode 60mm		05766
3	401260	Elektrode 50mm	FCV/G101/G102 FCV/G201-G202	02632
4	400124	Elektrode Alt	FCV/E61	02694
5	401261	Elektrode Neu 100mm	FCV/E101-G102 FCV/E201-E202	03878



Abb.	B.-Nr.	Beschreibung	Gerätetyp	Vergl.-Nr.
1	401355	Elektrode, 50mm	AOS61G__	0C1086
2	401262	Elektrode, 147mm	AOS101G__ AOS102G__	0C1055
3	401263	Elektrode, 210mm	AOS6201G__ AOS202G__	0C1105

Z

Passend für Zanussi



Abb.	B.-Nr.	Beschreibung	Gerätetyp	Vergl.-Nr.
1	401264	Elektrode	AOS61E_ AOS101E_	07033
2	401345	Elektrode	AOS201E_	0C1201
3	401265	Elektrode	AOS6202E_	05879

Elektrokomponenten



Abb.	B.-Nr.	Beschreibung	Gerätetyp	Vergl.-Nr.
1	375113	Thermostat 55°C	FCV/_	55367
2	380015	Energieregler		55016
3	380312	Relais	FCV/_	56466
4	380315	Relais	FCV/_10 (bis 10/90)	46001

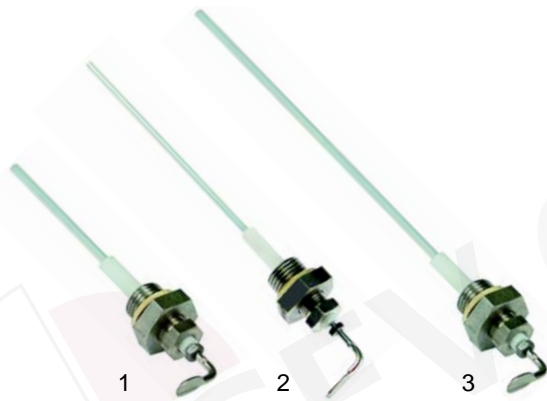

Abb.	B.-Nr.	Beschreibung	Gerätetyp	Vergl.-Nr.
1	375278	Sich.-thermostat 140°C	FCV/_	56745
2	375113	Thermostat		56671
3	350070	Alarmgeber		55368

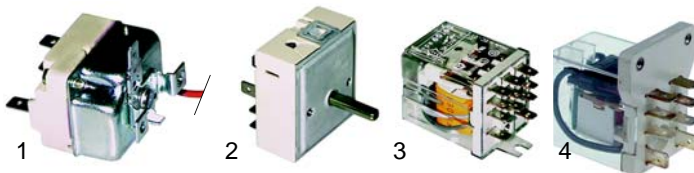

Abb.	B.-Nr.	Beschreibung	Gerätetyp	Vergl.-Nr.
1	375162	Sich.-thermostat 340°C	FCV/_D	58222
2	380204	Schütz	Universal	75796

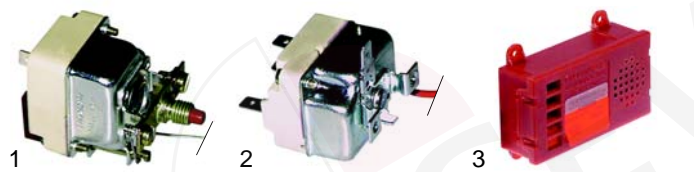

Abb.	B.-Nr.	Beschreibung	Gerätetyp	Vergl.-Nr.
1	350085	Alarmgeber	FCV/_10-P	59001
2	401266	Trafo		56512
3	401343	Platine		59033



Abb.	B.-Nr.	Beschreibung	Gerätetyp	Vergl.-Nr.
1	380636	Relais 24V	FCV/_10-P	56510
2	375209	Sich.-thermostat 140°C		59079
3	380665	Schütz		58670

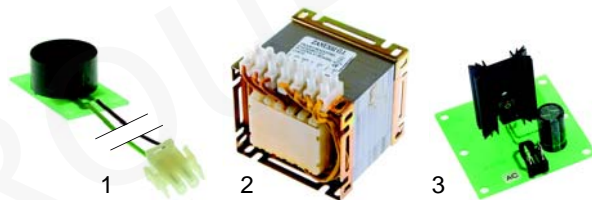

Abb.	B.-Nr.	Beschreibung	Gerätetyp	Vergl.-Nr.
1	375659	Sich.-thermostat 338°C	AOS_	07042
2	375657	Sich.-thermostat 150°C	AOS_G-	0C1147

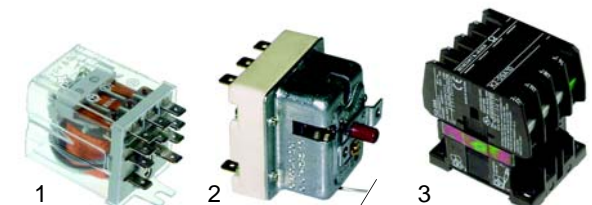

Abb.	B.-Nr.	Beschreibung	Gerätetyp	Vergl.-Nr.
1	380312	Relais	AOS_	058857
2	360342	Getriebemotor	AOS_	0C0883
3	601080	Lüfter	AOS_	002656

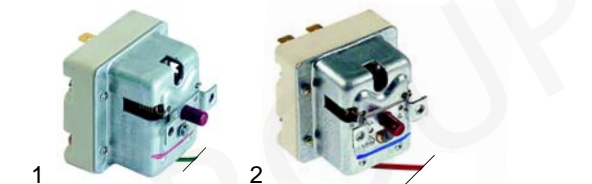

Abb.	B.-Nr.	Beschreibung	Gerätetyp	Vergl.-Nr.
1	401267	Trafo	AOS_	007045
2	379966	Fühler	AOS_	006995

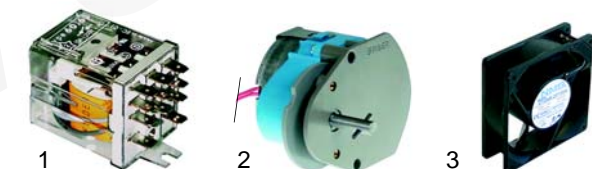

Abb.	B.-Nr.	Beschreibung	Gerätetyp	Vergl.-Nr.
1	359713	Fassung	FCV/	54991
2	359714	Dichtung		55022
3	359612	Lampe		54840

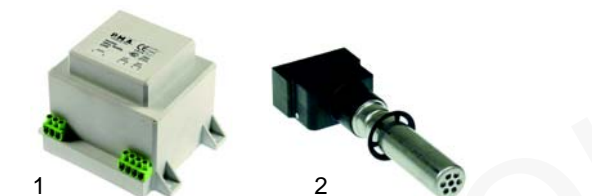

Abb.	B.-Nr.	Beschreibung	Gerätetyp	Vergl.-Nr.
1	359765	Flansch	FCV/_, AOS/_	02628
2	359764	Glas		02627
3	359763	Dichtung		02626
4	359599	Lampe		02956, 07056



Abb.	B.-Nr.	Beschreibung	Gerätetyp	Vergl.-Nr.
1	359762	Fassung	FCV	02709, 06106
2	359841	Fassung	AOS	07105



Abb.	B.-Nr.	Beschreibung	Gerätetyp	Vergl.-Nr.
1	601040	Motor	FCV/_6	54829, 58587
2	693410	Dichtungsring		55339
3	693404	Dichtung		55371
4	601220	Lüfterrad 280mm		55422

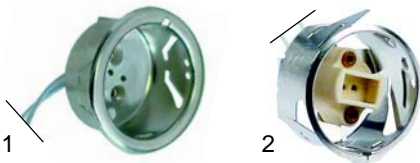

Abb.	B.-Nr.	Beschreibung	Gerätetyp	Vergl.-Nr.
1	601041	Motor	FCV/_202V, FCV/_10	54836, 58667
1	500815	Motor	FCV/_10-P, FCV/_202V-P	58994
2	693410	Dichtungsring	FCV/_10, FCV/_10-P	55339
3	693404	Dichtung		55371
4	601197	Lüfterrad 350mm		54890

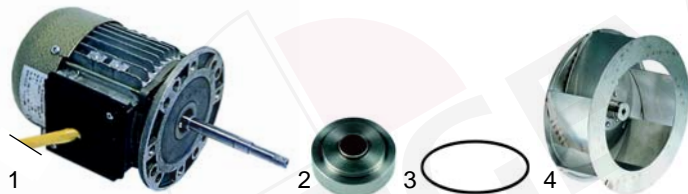

Abb.	B.-Nr.	Beschreibung	Gerätetyp	Vergl.-Nr.
1	601042	Motor	FCV/_20	54837, 58607
2	693411	Dichtungsring		55377
3	693404	Dichtung		55371
3	601218	Lüfterrad 440mm		55378

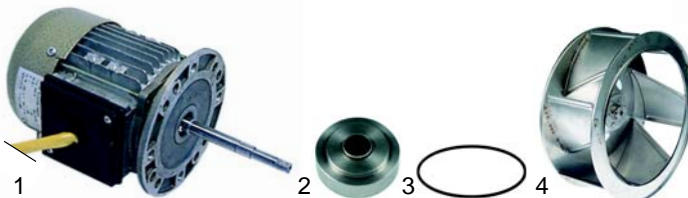

Abb.	Bestell-Nr.	Beschreibung	Gerätetyp	Vergl.-Nr.
1	500141	Motor/ 1 Drehzahl	FCV/_6L3, FCV/_10L2-3, FCV/_201-L3, FCV/_20L3	02616, 0F0007
1	500142	Motor/ 2 Drehzahlen	FCV/_6L4, FCV/_10L6, FCV/_101 Activ	02698
1	500814	Motor/ 1 Drehzahl	FCV/_61L3-4	05750
1	500653	Motor/ 2 Drehzahlen	FCV/_61L6	05748
1	500654	Motor/ 2 Drehzahlen	FCV/_20L6, FCV/_201 Active	05028
2	511301	Lager	Universal	02699
3	511300	Ring		02873
4	601220	Lüfterrad 280mm	FCV/_6, FCV/_61	02754
5	601197	Lüfterrad 350mm	FCV/_10, FCV/_101, FCV/_201, FCV/_20	02617



Abb.	Bestell-Nr.	Beschreibung	Gerätetyp	Vergl.-Nr.
1	500143	Motor/ 1 Drehzahl	FCV/_102 L3, FCV/_202 L3	02739
1	500144	Motor/ 2 Drehzahlen	FCV/_102 L6, FCV/_102 Active, FCV/_202 L6, FCV/_202 Active	02748, 05237
2	511301	Lager	FCV/_102, FCV/_202	02699
3	511300	Ring		02873
4	601218	Lüfterrad		02740



Abb.	Bestell-Nr.	Beschreibung	Gerätetyp	Vergl.-Nr.
1	601222	Motor	AOS061/_	006998
2	511301	Lager	AOS101/_	002699
3	511300	Ring	AOS201/_	002873
4	601236	Lüfterrad 280mm	AOS061/_	007000
5	601233	Lüfterrad 350mm	AOS101/_	OC1129



Abb.	Bestell-Nr.	Beschreibung	Gerätetyp	Vergl.-Nr.
1	500816	Motor		OC1171
2	511301	Lager	AOS202/_	02699
3	511300	Ring		02873
4	601234	Lüfterrad 380mm		OC1172

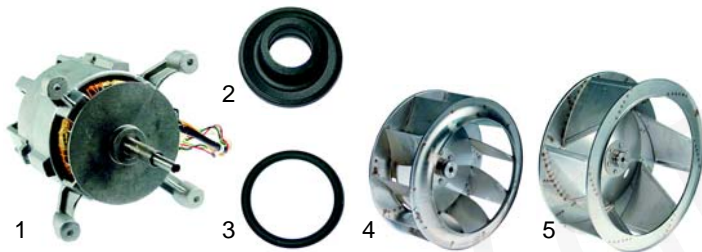

Abb.	Bestell-Nr.	Beschreibung	Gerätetyp	Vergl.-Nr.
1	415368	3750W/3x230V	FCV/E6	55439, 55462, 55930, 55949
2	415657	4500W/3x230V	FCV/E6 (ab '99)	02757
3	550256	Dichtung	FCV/E6	55327

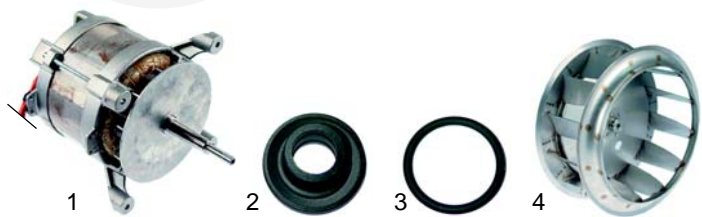

Abb.	B.-Nr.	Beschreibung	Gerätetyp	Vergl.-Nr.
1	415389	5566W/2x230V	FCV/E10	58196, 58197, 53839, 54620
1	415654	5666W/2x230V	FCV/E10 (ab '99), FCV/E20 (ab '99)	02688
2	550256	Dichtung	FCV/E10	55327
3	550257	Dichtung	FCV/E10 (ab '99), FCV/E20 (ab '99)	02689

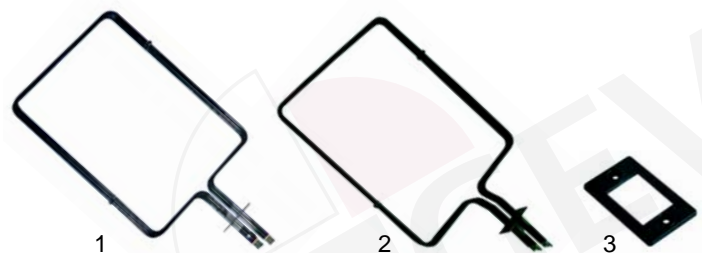

Abb.	B.-Nr.	Beschreibung	Gerätetyp	Vergl.-Nr.
1	415391	8000W/2x230V	FCV/E20 (bis '88)	56929, 54050, 54051
1	415393	8000W/2x400V	FCV/E20 (ab '88)	55481, 56970
2	415656	8000W/2x400V	FCV/E102, FCV/E202	A5330
3	550256	Dichtung	FCV/E20	55327
4	550257	Dichtung	FCV/E201, FCV/E202	A2689

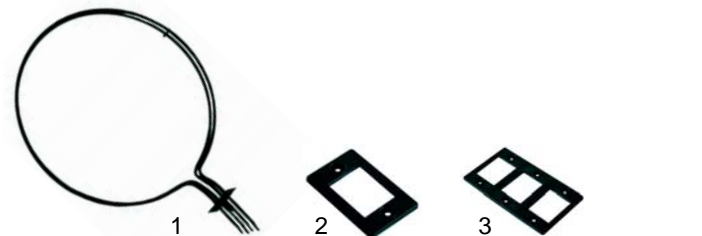

Abb.	B.-Nr.	Beschreibung	Gerätetyp	Vergl.-Nr.
1	418150	3200W/400V	AOS061E	006984
2	418151	5670W/400V	AOS101E, AOS201E	007064
3	418152	8000W/400V	AOS202E	OC1173
4	550257	Dichtung	AOS_E	002689



Abb.	B.-Nr.	Bschrbg.	Gerätetyp	Vergl.-Nr.
1	418188	7500W/230V	FCV/E-6 (bis '91)	56011, 55463
2	415394	7900W/230V	FCV/E-6 (von '91 bis '99)	58666, 58604
3	415690	9000W/230V	FCV/E-6 (ab '99), FCV/E10 (von '91 bis '99)	02835, 58672

Z

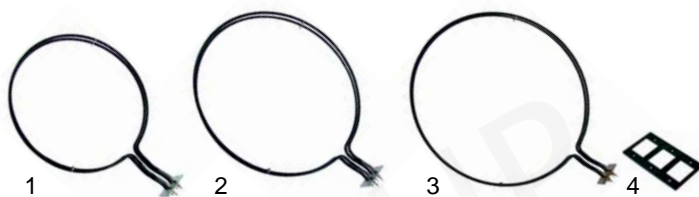
Passend für Zanussi

Geräte mit Zündbrenner

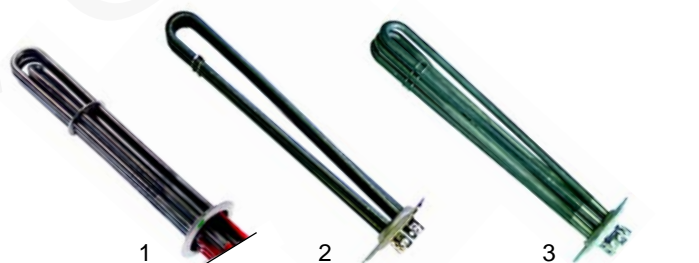

Abb.	B.-Nr.	Beschreibung	Gerätetyp	Vergl.-Nr.
1	418156	17000W/240V	FCV/E10 (bis '91)	56012, 55464
2	415063	17000W/240V	FCV/E10 (ab '99), FCV/E101	58995
3	415809	24000W/400V	FCV/E20 (bis '00)	56013, 55466
4	415652	24000W/400V	FCV/E102, FCV/E20 (ab '00), FCV/E201, FCV/E202	02751
5	510408	Dichtung		46213



Abb.	B.-Nr.	Beschreibung	Gerätetyp	Vergl.-Nr.
1	418153	9000W/400V	AOS61E	007030
2	418154	17000W/400V	AOS101E	007076
3	418155	24000W/400V	AOS201E, AOS202E	007101
4	510409	Dichtung		007029

Komponenten (Gas)



Abb.	B.-Nr.	Beschreibung	Gerätetyp	Ver.-Nr.
1	n.m.l.	Brenner (Heißluft)	FCV/G6 (bis '91)	56450
2	105814	Brenner (Heißluft)	FCV/G6 (von '91 bis '99)	02126
3	105813	Brenner (Heißluft)	FCV/G6 (ab '99)	02857
4	105784	Brenner (Dampf)	FCV/G6	56451



Abb.	Best.-Nr.	Beschreibung	Gerätetyp	Ver.-Nr.
1	105767	Brenner (Heißluft + Dampf)	FCV/G10	55007
2	105786	Brenner (Heißluft)	FCV/G20	55487
3	105785	Brenner (Dampf)	FCV/G20	55486

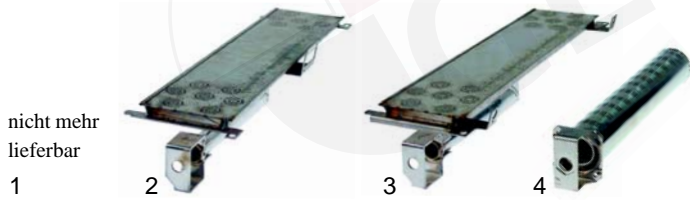

Abb.	B.-Nr.	Beschreibung	Gerätetyp	Vergl.-Nr.
1	101183	Compositventil	FCV/G6	53973
2	111766	Blende		55454
3	111767	Knebel		56452



Abb.	B.-Nr.	Beschreibung	Gerätetyp	Vergl.-Nr.
1	345038	Zündschalter	FCV/G6 (bis '99)	53978
2	345039	Schutzhaube		53979
3	100009	Piezozünder	FCV/G6 (ab '99)	59251
4	100012	Piezozünder		02605

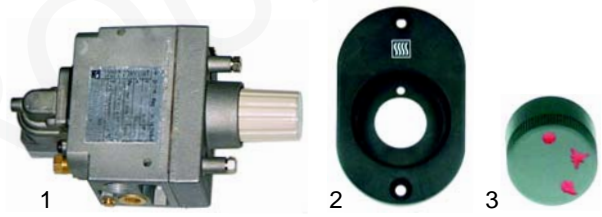

Abb.	B.-Nr.	Beschreibung	Gerätetyp	Vergl.-Nr.
1	101162	Novasitventil		55446
2	111766	Blende	FCV/G10, FCV/G20	55454
3	111768	Knebel		55447
4	101312	Mikroschalter		54539



Abb.	B.-Nr.	Beschreibung	Gerätetyp	Vergl.-Nr.
1	100046	Zündbrenner	FCV/G6, FCV/G10, FCV/G20	50813
2	100706	Zündkerze		56754
3	100050	Zündbrenner	FCV/G6 (ab '94) - nur Heißluft	59379
4	100701	Zündkerze		59380



Abb.	B.-Nr.	Beschreibung	Gerätetyp	Vergl.-Nr.
1	102044	Thermoelement, 1200mm	FCV/G6,	20094
2	102070	Thermoelement, 1000mm, mit Unterbrechung	FCV/G10, FCV/G20	54055
3	102265	Thermoelement-Verlängerung, 500mm	FCV/G10, FCV/G20	55032

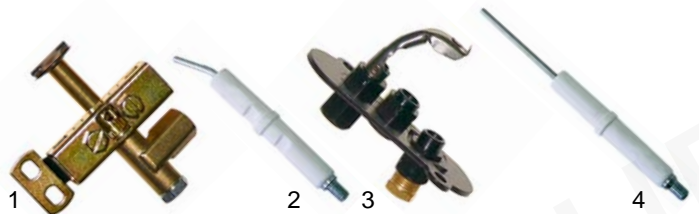

Abb.	Bestell-Nr.	Beschreibung	Gerätetyp	Vergl.-Nr.
1	102359	Elektrode	FCV/G6	02343
2	102360	Elektrode		02344
3	102361	Elektrode	FCV/G6, FCV/10, FCV/G102	02637
4	102175	Elektrode	FCV/G10, FCV/G101, FCV/G102	02638
5	102362	Elektrode	FCV/G201, FCV/G20, FCV/G202	0H6803

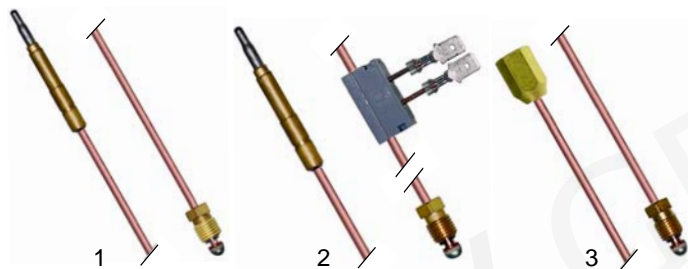

Abb.	Bestell-Nr.	Beschreibung	Gerätetyp	Vergl.-Nr.
1	693398	Rahmen	FCV/G6, FCV/G10, FCV/G20	57382
2	693396	Dichtung		57402
3	693397	Glas		57400



Abb.	Bestell-Nr.	Beschreibung	Gerätetyp	Vergl.-Nr.
1	101989	Ventil		05757
2	101990	Feuerungsautomat	FCV/G61 (bis Nr. 021)	05908
3	541352	Pressostat		05746

Geräte mit Feuerungsautomat



Abb.	Bestell-Nr.	Beschreibung	Gerätetyp	Vergl.-Nr.
1	101189	Tandemventil 830	FCV/G6, FCV/G10, FCV/G101, FCV/G102, FCV/G201, FCV/G20, FCV/G202	02340
2	101984	Tandemventil 836		02714
3	101379	Magnetspule		02452
4	401257	Stecker + Gleichrichter		02715

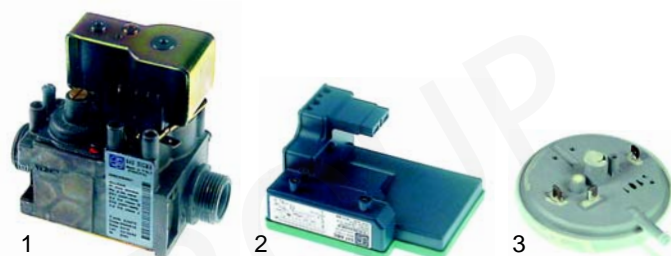

Abb.	B.-Nr.	Beschreibung	Gerätetyp	Vergl.-Nr.
1	106007	Ventil	FCV/G61 (ab Nr. 022),	05925
2	101184	Feuerungsautomat	FCV/G201 (level 3), FCV/G202 (level 3)	05924
3	541352	Pressostat		05746



Abb.	Bestell-Nr.	Beschreibung	Gerätetyp	Vergl.-Nr.
1	101165	Feuerungsautomat	FCV/G6	02351
2	102347	Feuerungsautomat	FCV/G10, FCV/G101, FCV/G102, FCV/201, FCV/G20, FCV/G202	02641
3	541075	Pressostat		03772

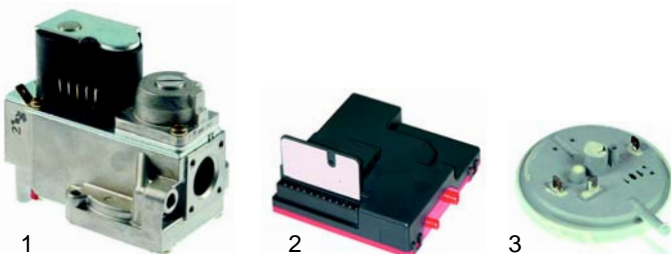

Abb.	B.-Nr.	Beschreibung	Gerätetyp	Vergl.-Nr.
1	106008	Ventil		06596
2	101184	Feuerungsautomat	FCV/G201 (Level 4), FCV/G202	05924
3	541352	Pressostat		05746

Z

Passend für Zanussi

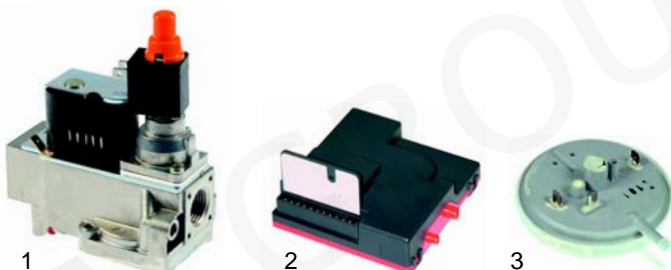

Abb.	B.-Nr.	Beschreibung	Gerätetyp	Vergl.-Nr.
1	102348	Elektrode		05910
2	102349	Elektrode	FCV/G61	05920
3	102350	Elektrode		05911
4	102175	Elektrode	FCV/G201, FCV/G202	02638
5	102362	Elektrode		0H6803



Abb.	Best.-Nr.	Beschreibung	Gerätetyp	Vergl.-Nr.
1	102351	Elektrode (Boiler)		0C1137
2	102344	Elektrode (Boiler)	AOS_G	0C1068
3	102352	Elektrode (Heißluft)		0C1134
4	102345	Elektrode (Heißluft)		0C1049

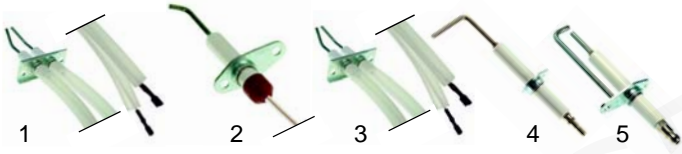

Abb.	Bestell-Nr.	Beschreibung	Gerätetyp	Vergl.-Nr.
1	541078	Pressostat	Universal	02635
2	601237	Lüftermotor	FCV/G61	05745
3	601238	Lüftermotor	alle FCV-Typen (außer G61)	02639

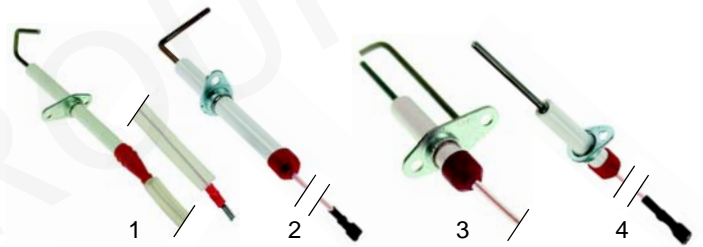

Abb.	Best.-Nr.	Beschreibung	Gerätetyp	Vergl.-Nr.
1	500818	Lüftermotor	AOS061G, AOS101G,	0C1051
2	500817	Lüftermotor	AOS201G (Heißluft)	0C1112



Abb.	Best.-Nr.	Beschreibung	Gerätetyp	Vergl.-Nr.
1	693402	Insulator-Boiler	Alle FCV-Geräte (außer FCV/G61)	02706
2	693403	Insulator-Heißlüfter		03874

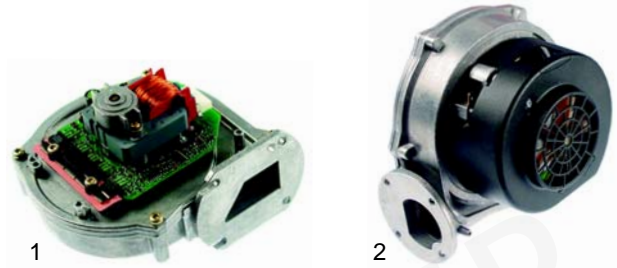

Abb.	Best.-Nr.	Beschreibung	Gerätetyp	Vergl.-Nr.
1	106009	Ventil	AOS_G	0C1057
2	102346	Feuerungsautomat		0C1059

Komponenten (Wasser)

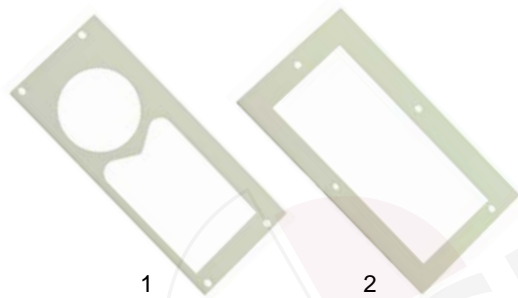

Abb.	Best.-Nr.	Beschreibung	Gerätetyp	Ve.-Nr.
1	370343	Magnetventil (2-fach) mit Reduzierung	FCV/G6, FCV/G10, FCV/G20	55444
2	370346	Magnetventil (3-fach) mit Reduzierung	FCV/G10-_-D, FCV/G20-_-D	58208

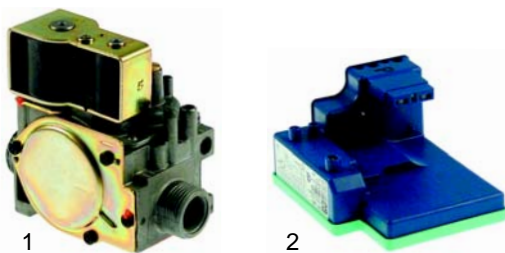

Abb.	Best.-Nr.	Beschreibung	Gerätetyp	Ve.-Nr.
1	370342	Magnetventil (2-fach) mit Reduzierung	FCV/G10ISG	47579
2	370017	Magnetventil (1-fach) Ablöschung		55132

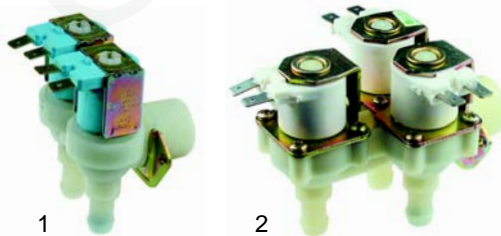

Abb.	B.-Nr.	Beschreibung	Gerätetyp	Vergl.-Nr.
1	370347	Magnetventil, 24V (3-fach) mit Reduzierung	FCV/G10-P, FCV/E10-P,	A2415
2	370029	Magnetventil, 24V (1-fach)	FCV/E20-P, FCV/E202-P	58996

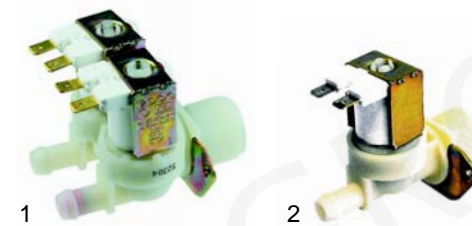

Abb.	B.-Nr.	Beschreibung	Gerätetyp	Vergl.-Nr.
1	370015	Magnetventil (1-fach)	FCV/_61L3-6	02613
2	370343	Magnetventil (2-fach) mit Reduzierung	FCV/_61L3	55444
3	370344	Magnetventil (3-fach) mit Reduzierung	FCV/61L4-6	02712



Abb.	B.-Nr.	Beschreibung	Gerätetyp	Vergl.-Nr.
1	370339	Magnetventil (1-fach) mit Reduzierung	FCV/E6, FCV/E10 (bis '91), FCV/E20 (bis '91)	55350
2	370343	Magnetventil (2-fach) mit Reduzierung	FCV/E10 (ab '91), FCV/E20 (ab '91), FCV/E202V	55444
3	370017	Magnetventil (1-fach)	FCV/E202V	55132



Abb.	Bestell-Nr.	Beschreibung	Gerätetyp	Vergl.-Nr.
1	370017	Magnetventil (1-fach)	AOS61_, AOS101_, AOS201_, AOS202_	55132
2	370345	Magnetventil (3-fach) mit Reduzierung	AOS201_, AOS202_	02859

Geräte (Reinigung)



Abb.	B.-Nr.	Beschreibung	Gerätetyp	Ver.-Nr.
1	370340	Magnetventil, 24V (2-fach) mit Reduzierung	FCV/E6-3CE	56513
2	370347	Magnetventil, 24V (3-fach) mit Reduzierung	FCV/E10-3CE, FCV/E20-3CE	A2415



Abb.	B.-Nr.	Beschreibung	Gerätetyp	Vergl.-Nr.
1	370348	Magnetventil, 1/2"	AOS61_, AOS101_	07015
2	370356	Magnetventil, 1/2"	AOS201_, AOS202_	0C1121
3	500566	Magnetpumpe	Universal	07018, 0C2341



Abb.	B.-Nr.	Beschreibung	Gerätetyp	Vergl.-Nr.
1	370341	Magnetventil (1-fach) mit Reduzierung	FCV/G6L3, FCV/E6L4	02753
2	370342	Magnetventil (2-fach) mit Reduzierung	FCV/G6L3/4, FCV/G61L3/L4, FCV/G10L2, FCV/E10L2	47579
3	370345	Magnetventil (3-fach) mit Reduzierung	FCV/G6L4	02859, 0C1934

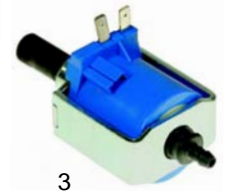

Abb.	B.-Nr.	Beschreibung	Gerätetyp	Vergl.-Nr.
1	370349	Magnetventil	AOS61_, AOS101_	07016
2	370350	Magnetventil	AOS101_	07017
3	370355	Magnetventil	AOS201_, AOS202_	0C1133, 0C1933



Abb. B.-Nr.	Beschreibung	Gerätetyp	Vergl.-Nr.
1	693405 Halter		07009
2	532506 Dichtung		07074
3	693406 Wasserstift	AOS61_	07025
4	693407 Buchse	AOS101_	07024
5	693408 Wascharm	AOS201_	07010
6	693409 Feder	AOS202	07026



Abb. B.-Nr.	Beschreibung	Gerätetyp	Vergl.-Nr.
1	400112 Auslassventil (Elektro), 3/4"	FCV/_10-P, FCV/Level6	59004, 02713
2	401140 Auslassventil (Elektro), 1"	Standgeräte, FCV/_	05026
3	401139 Auslassventil (Elektro) 3/4"	AOS_	0C882

Komponenten (Mechanik)

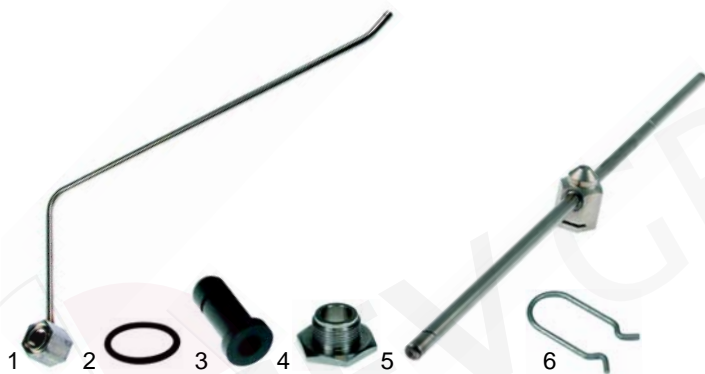

Abb. B.-Nr.	Beschreibung	Gerätetyp	Vergl.-Nr.
1	540977 Auslaufhahn	FCV/_	56114
2	514066 Verlängerung	FCV/G_, FCV/E (bis '91)	56116
3	514067 Verlängerung	FCV/E (ab '91)	56567



Abb. B.-Nr.	Beschreibung	Gerätetyp	Vergl.-Nr.
1	700081 Türgriff	FCV/6	56459
2	700082 Gegenstück		56464



Abb. B.-Nr.	Beschreibung	Gerätetyp	Vergl.-Nr.
1	514324 Hebel	FCV/_	55352
2	514322 Griff		29898
3	514069 Hebel	FCV/G6 (ab 99)	02881
4	514072 Hebel	FCV/E6 (ab 99)	02880
5	514070 Hebel	FCV/_061	05770
6	514068 Hebel	FCV/_10, FCV/_201	02883



Abb. B.-Nr.	Beschreibung	Gerätetyp	Vergl.-Nr.
1	700458 Türgriff		02085
2	700439 Feder	FCV/6	02088
3	700461 Kloben		02086



Abb. B.-Nr.	Beschreibung	Gerätetyp	Vergl.-Nr.
1	690840 Türgriff		56415
2	690836 Getriebe	FCV/10, FCV/20	56550
3	690837 Riegelstück		56551
4	690838 Kloben		56571

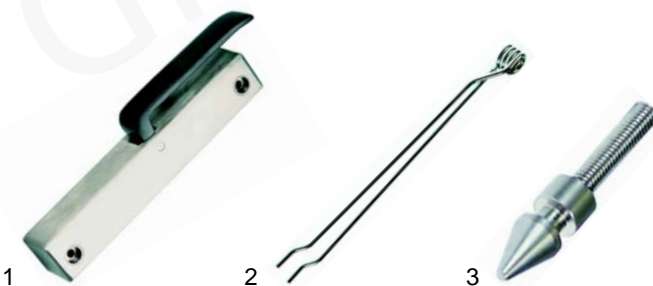

Abb.	B.-Nr.	Beschreibung	Gerätetyp	Vergl.-Nr.
1	700446	Druckknopf	FCV/10, FCV/20	53761
2	700444	Druckstift		53756
3	700445	Feder		53757
4	700450	Feder		54282
5	700447	Kloben		53766
6	700453	Griff		55057
7	700454	Schutz		55059
8	700460	Kappe		55043

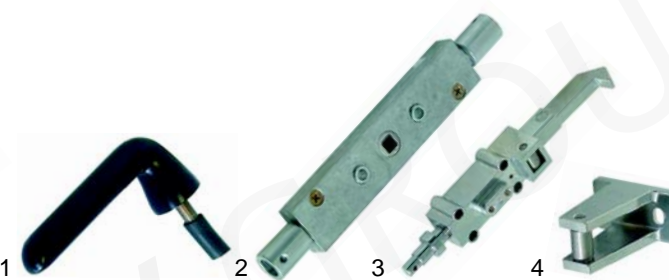

Abb.	Bestell-Nr.	Beschreibung	Gerätetyp	Vergleichs-Nr.
1	700488	Getriebe		03824
2	690041	Riegelstück	FCV/201, FCV/202	03822
3	700490	Kloben		0H6728
4	700489	Stange		05037

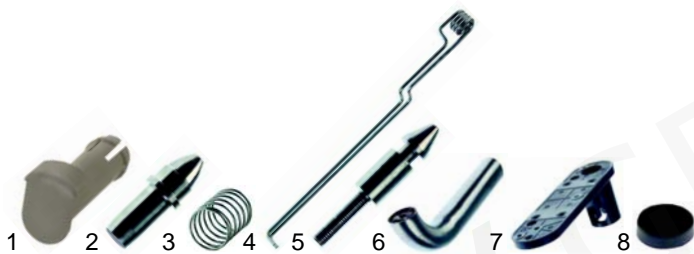

Abb.	B.-Nr.	Beschreibung	Gerätetyp	V.-Nr.
1	700462	Scharnier/oben	FCV/_6	55415
2	700463	Scharnier/oben	FCV/_10, FCV/_20	55316
3	700464	Stift	FCV/_6, FCV/_10, FCV/_20	55318
4	700465	Scharnier/unten		55317
5	700466	Stift	FCV/_ (ab '92)	59083

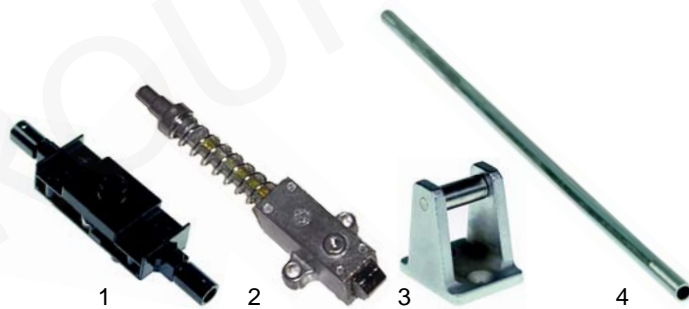

Abb.	Bestell-Nr.	Beschreibung	Gerätetyp	Vergl.-Nr.
1	700473	Türscharnier/oben	FCV/_6,	02651
2	700474	Wellenscheibe	FCV/_10,	02653
3	700475	Türscharnier/unten	FCV/_61,	02352
4	700469	Türfeder	FCV/_101	03773

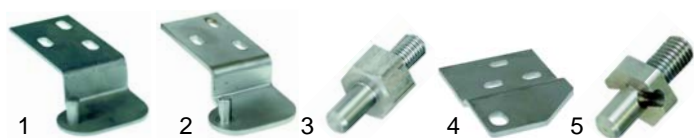

Abb.	Bestell-Nr.	Beschreibung	Gerätetyp	Vergleichs-Nr.
1	700467	Verschluss	FCV/_6,	02647
2	690874	Türgriff	FCV/_10,	02717
3	700468	Kloben	FCV/_61,	02650
4	700469	Türfeder	FCV/_102	03773

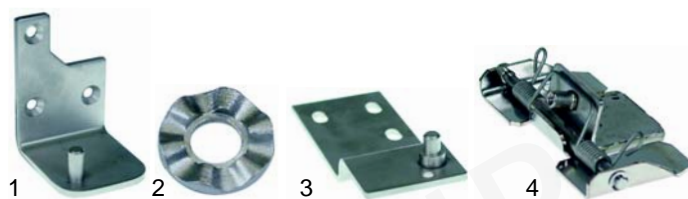

Abb.	Bestell-Nr.	Beschreibung	Gerätetyp	Vergl.-Nr.
1	690871	Türscharnier/oben		05041
2	700474	Wellenscheibe	FCV/_201, FCV/_202	02653
3	700476	Türscharnier/unten		05694
4	700469	Türfeder		03773

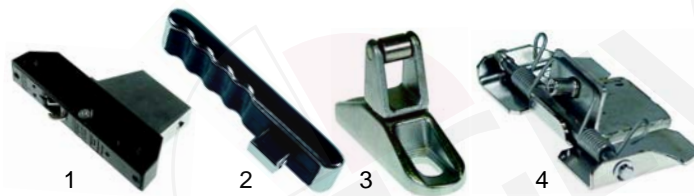

Abb.	Bestell-Nr.	Beschreibung	Gerätetyp	Vergleichs-Nr.
1	690874	Türgriff		02717
2	700470	Griffhalter	FCV/201, FCV/202	03826
3	700471	Lager		03994
4	700472	Flansch		04098

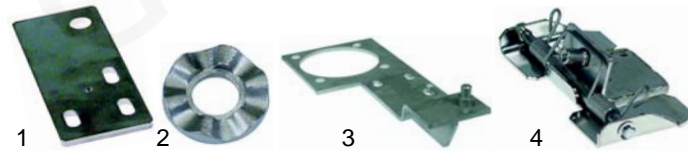

Abb.	Bestell-Nr.	Beschreibung	Gerätetyp	Ver.-Nr.
1	700477	Scharnier/Glasseite oben	FCV/_6,	02876
2	700478	Dichtung	FCV/_10, FCV/_61,	02645
3	700479	Platte	FCV/_101,	02877
4	700480	Scharnier/Glasseite unten	FCV/_101,	02875
5	690870	Verriegelung	FCV/_201, FCV/_202	04838

Z

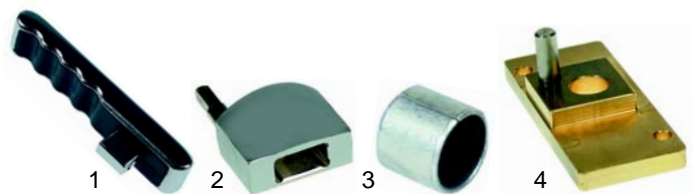
Passend für Zanussi

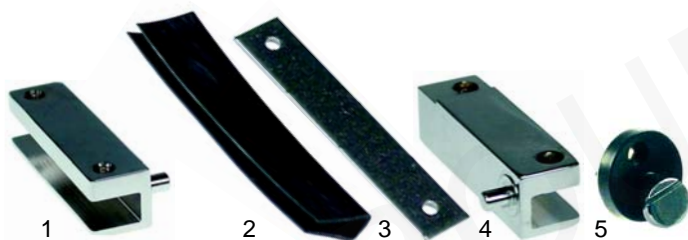

Abb.	Bestell-Nr.	Beschreibung	Gerätetyp	Ver.-Nr.
1	700481	Türgriff		06978
2	700482	Verschluss	AOS61_	06977
3	700483	Kloben	AOS101_	06981
4	690873	Türfeder		06979



Abb.	Bestell-Nr.	Beschreibung	Gerätetyp	Ver.-Nr.
1	690866	Türscharnier/oben		06972
2	700474	Wellenscheibe	AOS61_	02653
3	690867	Türscharnier/unten	AOS101_	06980
4	700484	Glasscheibe/Scharnier		07007



Abb.	Bestell-Nr.	Beschreibung	Gerätetyp	Ver.-Nr.
1	700481	Türgriff		06978
2	700485	Verschluss	AOS201_	07089
3	700486	Kloben	AOS202_	07092

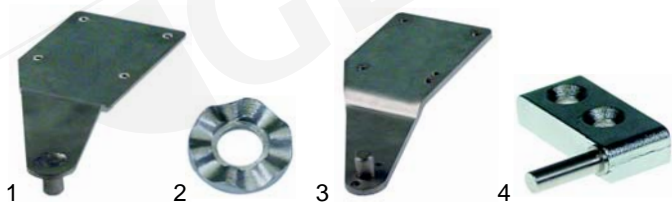

Abb.	Bestell-Nr.	Beschreibung	Gerätetyp	Ver.-Nr.
1	690868	Türscharnier/oben		07086
2	700474	Wellenscheibe	AOS201_	02653
3	700511	Türscharnier/unten	AOS202_	07091
4	700484	Glasscheibe/Scharnier		07007



Abb.	Bestell-Nr.	Beschreibung	Gerätetyp	Vergleichs-Nr.
1	900187	Türdichtung, 585x395mm	FCV/_6	55414
2	900188	Türdichtung, 640x720mm	FCV/_10, FCV/_20	55315
3	900275	Türdichtung, 645x1380mm	FCV/_202	54986



Abb.	Bestell-Nr.	Beschreibung	Gerätetyp	Vergleichs-Nr.
1	900190	Fensterdichtung, 190mm	FCV/_6	55412
2	900191	Fensterdichtung, 230mm	FCV/_10, FCV/_202	55314
3	900192	Fensterdichtung, Meterware	FCV/_20	54224

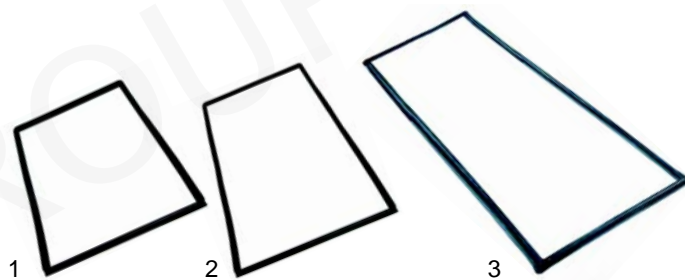

Pos.	Bestell-Nr.	Beschreibung	Gerätetyp	Vergl.-Nr.
1	900433	Türdichtung, 635x430mm	FCV/_6	05713, 02828
2	900162	Türdichtung, 610x435mm	FCV/_61	05707
3	900160	Türdichtung, 660x730mm	FCV/_10, FCV/_101, FCV/_102	02654, 05712
4	900161	Türdichtung, 635x1400mm	FCV/_20 1/1, FCV/_20 2/1	03088, 05705
5	900434	Türdichtung, 660x1395mm	FCV/_20, FCV/_201, FCV/_202	03995, 05711

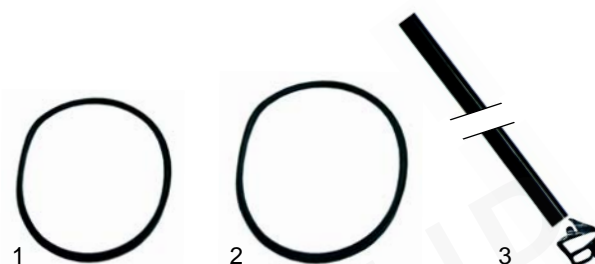
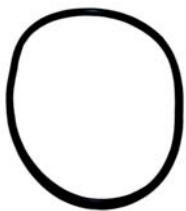

Pos.	Bestell-Nr.	Beschreibung	Gerätetyp	Vergl.-Nr.
1	900185	Fensterdichtung, 150mm	FCV/_6, FCV/_61	02837
2	900186	Fensterdichtung, 200mm	FCV/_10, FCV/_101, FCV/_102, FCV/_20, FCV/_201, FCV/_202	02878



Pos.	Bestell-Nr.	Beschreibung	Gerätetyp	Vergl.-Nr.
1	900278	Türdichtung, 485x510mm	AOS061_	06992
2	900268	Türdichtung, 485x755mm	AOS101_	07069
3	900276	Türdichtung, 485x1480mm	AOS201_	0C0881
4	900267	Türdichtung, 660x1480mm	AOS202_	0C1195



Abb.	Bestell-Nr.	Beschreibung	Gerätetyp	Ver.-Nr.
1	900295	Hordenwagendichtung	AOS201_	0C0899
2	900274	Hordenwagendichtung	AOS202_	0C1196

Hockerkocher (Gas)



Abb.	Best.-Nr.	Beschreibung	Gerätetyp	Vergl.-Nr.
1	105028	Brennerdeckel	FP/G1,	26643
2	105027	Brennerpfeife	FP/61D	26641
3	101100	Sicherheitsventil 1/2"		50106

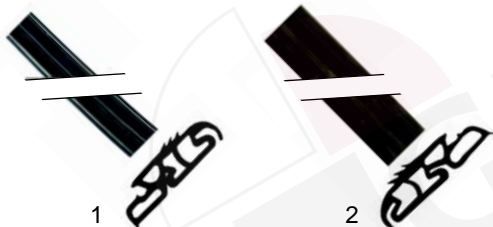

Abb.	Best.-Nr.	Beschreibung	Gerätetyp	Vergl.-Nr.
1	101083	Gashahn	FT/G2	25021
2	110047	Knebel	(253103) (2VV02B)	56016 26798



Abb.	Best.-Nr.	Beschreibung	Gerätetyp	Vergl.-Nr.
1	100043	Zündbrenner		51624
2	102041	Thermoelemente 600mm		25031
3	101083	Gashahn	FP/G1, FP/61D	25021
4	110047	Knebel		56016 26798



Abb.	Best.-Nr.	Beschreibung	Gerätetyp	Vergl.-Nr.
1	105236	Brennerdeckel 83mm	FT/G2	03733
2	105235	Brennertulpe	(253110)	02461
3	105237	Brennerfuß	FOTG02T (774100)	02458

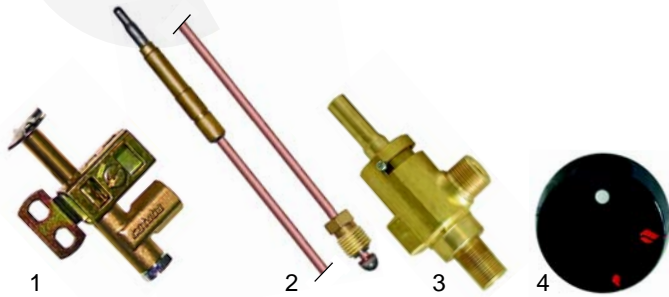

Abb.	Best.-Nr.	Beschreibung	Gerätetyp	Vergl.-Nr.
1	105242	Brennerdeckel 123	FT/G2	02441
2	105241	Brennertulpe	(253110)	02463
3	105243	Brennerfuß	FOTG02T (774100)	02460

Tischherde



Abb.	Best.-Nr.	Beschreibung	Gerätetyp	Vergl.-Nr.
1	105307	Brennerdeckel, 80mm		20985
2	105308	Brennerpfeife	FT/G2,	20984
3	105023	Brennerdeckel, 145mm	FT/G2V	20986
4	105022	Brennerpfeife		20954



Abb.	Best.-Nr.	Beschreibung	Gerätetyp	Vergl.-Nr.
1	100043	Zündbrenner		20152
2	102045	Thermoelement 1500mm	FT/G2V	52814
3	101087	Gashahn	(509474)	52146
4	110897	Knebel		54105



Abb.	Best.-Nr.	Beschreibung	Gerätetyp	Vergl.-Nr.
1	105309	Abdeckung	FT/G2	03547
2	100094	Zündbrenner	(253110)	59214
3	102205	Thermoelement 750mm	FOTG02T (774100)	58332

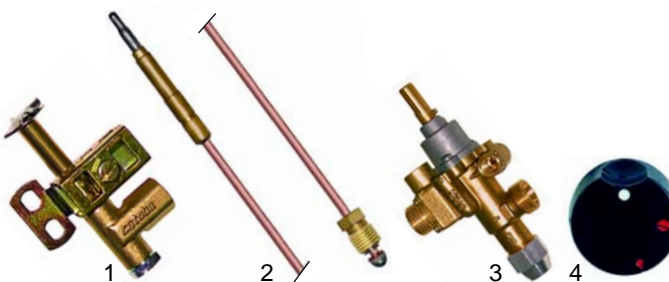

Abb.	Best.-Nr.	Beschreibung	Gerätetyp	Vergl.-Nr.
1	101095	Gashahn	FT/G2	59460
2	110348	Knebel	(253110) FOTG02T (774100)	59206

Salamander (Gas)

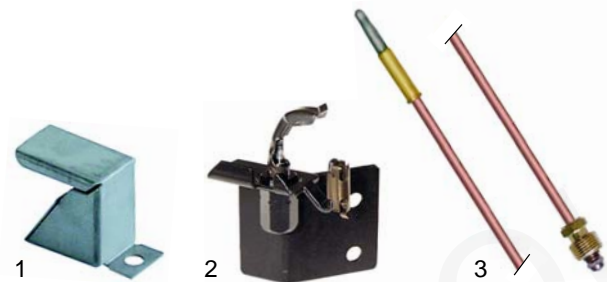

Abb.	Best.-Nr.	Beschreibung	Gerätetyp	Vergl.-Nr.
1	416578	Strahlungselemente		57730
2	100106	Zündbrenner		58329
3	100706	Zündkerze	SL/G802	56754
4	100025	Zündkabel		

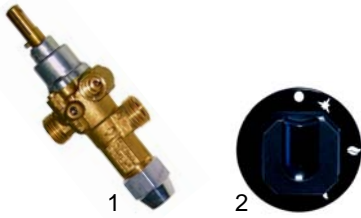

Abb.	Best.-Nr.	Beschreibung	Gerätetyp	Vergl.-Nr.
1	100007	Piezozünder		52539
2	102045	Thermoelement, 1500mm		52814
3	101087	Gashahn	SL/G802	52146
4	111599	Knebel		52604

Salamander (Elektro)



Abb.	Best.-Nr.	Beschreibung	Gerätetyp	Ver.-Nr.
1	416579	1900W/230V	SL/E901, SA2-E2, E901	56783
2	416580	2000W/230V	SL/E851, SAL-E1, E854	56782
3	416581	3000W/230V	SL/E802	SL/E802

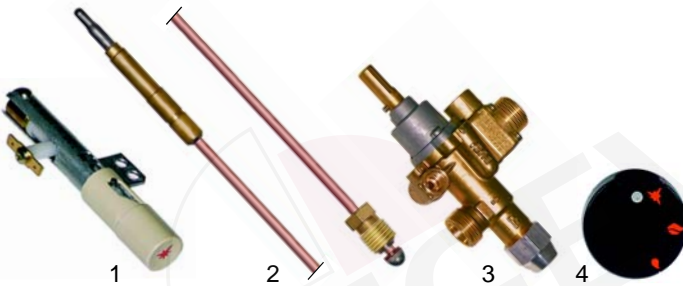

Abb.	Best.-Nr.	Beschreibung	Gerätetyp	Vergl.-Nr.
1	416653	2200W/230V	SE40	03016
2	416654	2200W/230V	SE60	03012
3	415625	1000W/230V	SE80	03014

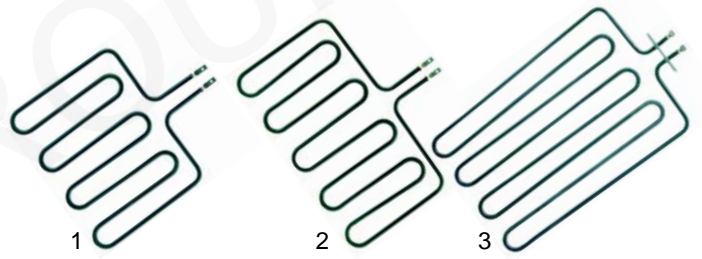

Abb.	Best.-Nr.	Beschreibung	Gerätetyp	Vergl.-Nr.
1	380015	Energiregler	Universal	53695
2	110898	Knebel	SL/_	53694
3	110701	Knebel		03029
4	359031	Signallampe	SE40/60/80	03302
5	380204	Schütz	SE80	-

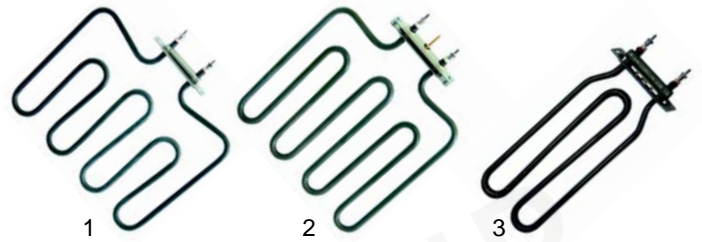