

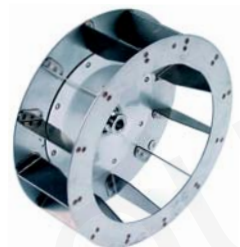

Ersatzteile passend für: LAINOX

Ersatzteile passend für Convectomaten und Combidämpfer



G.E.V. Großküchen-Ersatzteil-Vertrieb GmbH

Robert-Koch-Straße 3a
82152 Planegg/München
Deutschland

Telefon: +49 (0)89 745572-0
Telefax: +49 (0)89 745572-82

info@gev-online.de
www.gev-online.de



GEV GmbH Ersatzteile und Zubehör

Kanalstrasse 14
5745 Safenwil
Schweiz

Telefon: +41 (0)62 797 87 70
Telefax: +41 (0)62 797 25 07

info@gev.ch
www.gev.ch

Members of the GEV GROUP

Bedienblenden



Abb.	Bestell-Nr.	Beschreibung	Gerätetyp	Vergl.-Nr.
1	300010	Wahlschalter		50304020 65080010
2	375261	Thermostat	FE05, FG05, RE_, RG_, PE_, PG_	50304031 65070210
3	350038	Timer		50304580 65090020



Abb.	Bestell-Nr.	Beschreibung	Gerätetyp	Vergl.-Nr.
1	380015	Energieregler		50304011 65080250
2	111771	Knebel	FE05, FG05, RE_, RG_, PE_, PG_	50103130 69030060 69030170
3	359026	Signallampe		50304620 65270220
4	359027	Signallampe		50304630 65270230

Zwei Geschwindigkeiten und Leistungsumschalter

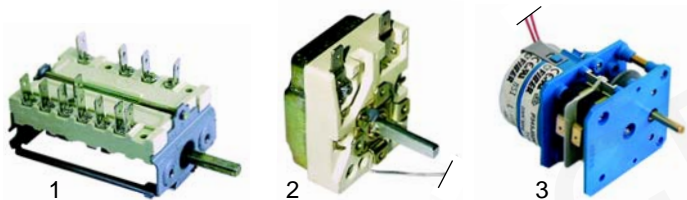

Abb.	Bestell-Nr.	Beschreibung	Gerätetyp	Ver.-Nr.
1	300096	Umschalter		50304471 68085000
2	358521	Überstromauslöser	FE05, FG05, RE_, RG_, PE_, PG_	50304420 65160206
3	301228	Schalter		50304650 65260210

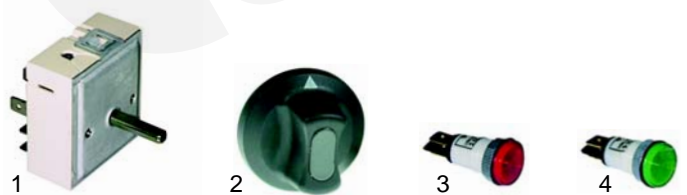
Kerntemperatur



Abb.	Bestell-Nr.	Beschreibung	Gerätetyp	Vergl.-Nr.
1	379268	Elektronikregler		50304860 65340010
2	379054	Trafo	FE05, FG05, RE_, RG_, PE_, PG_	50305010 65180530
3	301228	Schalter		50304650 65260210



Abb.	B.-Nr.	Beschreibung	Gerätetyp	V.-Nr.
1	300071	Wahlschalter	ME004S/L, ME104S/L, M_105S/L, M_106S-220S, VE004S, VE104S, VG105S-10S	65080020
2	301224	Vorsatzkörper	ME_S/L, VE_S/L	65080040
3	301225	Wahlschalter	M_106L-220L, V_106L-210L	65080060



Abb.	B.-Nr.	Beschreibung	Gerätetyp	V.-Nr.
1	301226	Vorsatzschalter	ME_L, MG_L, VE_L, VG_L	65080030
2	400091	Display	ME_S/L, MG_S/L, VE_S/L, VG_S/L	65300220
3	111771	Knebel	Universal	69030080 39030170
4	110139	Dichtung		70050020

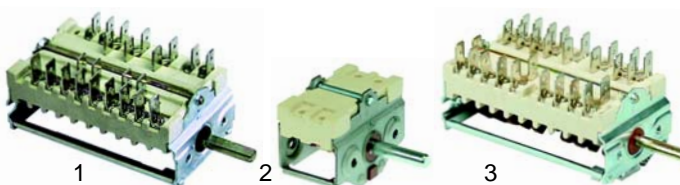

Abb.	B.-Nr.	Beschreibung	Gerätetyp	V.-Nr.
1	379141	Drucktasterplatine	M106_220S/L, V106_220S/L	65300160
2	400194	Resetplatine	MG_	65300150
3	401293	Resetfolie		67010830



Abb.	Bestell-Nr.	Beschreibung	Gerätetyp	Vergl.-Nr.
1	400139	Funktionsplatine	ME_S/L, MG_S/L	65300210
2	400138	Funktionsplatine	ME_S/L	65300215
3	350055	Summer	ME_S/L, MG_S/L, VE_S/L	65330040
4	379143	Fühler PT100	VE_S/L	65325000

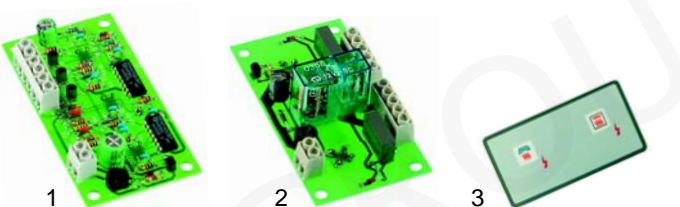

Abb.	B.-Nr.	Beschreibung	Gerätetyp	Ver.-Nr.
1	401300	Frontfolie	ME106-220S, MG106-220S	67010021
2	401301	Frontfolie	ME106-220L, MG106-220L	67010031
3	401293	Frontfolie (Reset)	MG106-220S/L	67010830

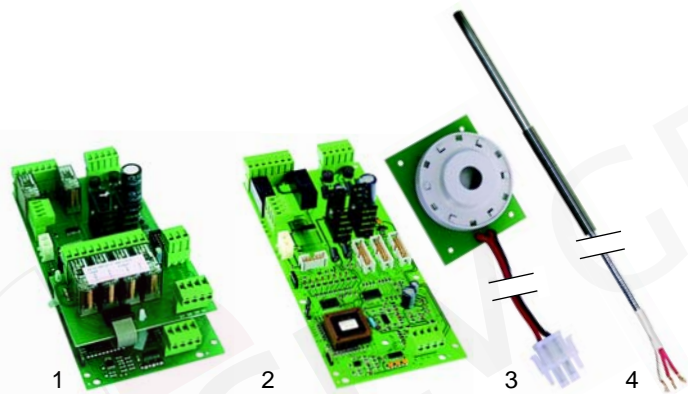

Abb.	Bestell-Nr.	Beschreibung	Gerätetyp	Ver.-Nr.
1	401296	Frontfolie	RE_, RG_, PE_, PG_	50708710 67010010
2	401297	Frontfolie	ME004/S, ME104/S, VE004/S, VE104/S	67010080
3	401298	Frontfolie	ME004/L, ME104/L, VE004/L, VE104/L	67010090

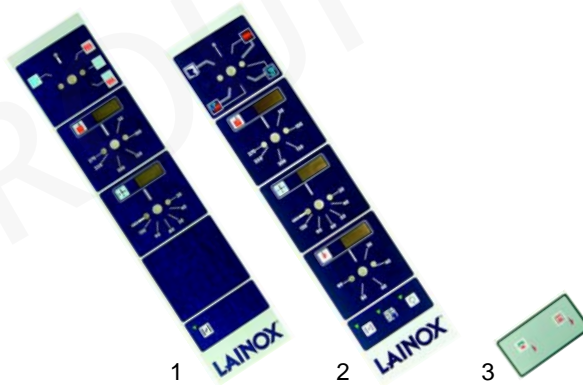

Abb.	B.-Nr.	Beschreibung	Gerätetyp	Ver.-Nr.
1	401302	Frontfolie	VE106-210S, VG106-210S	67010230
2	401303	Frontfolie	VE106-210L, VG106-210L	67010240

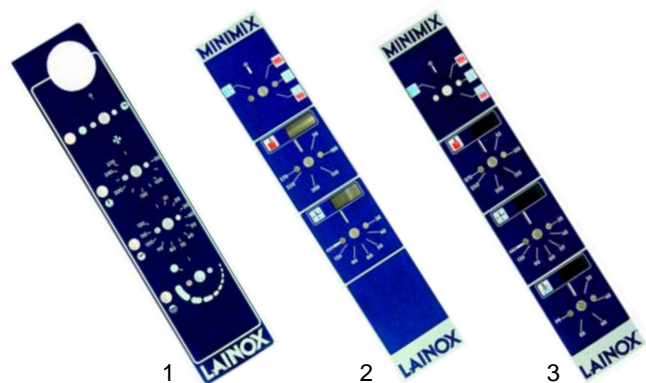

Abb.	Bestell-Nr.	Beschreibung	Gerätetyp	Ver.-Nr.
1	300071	Wahlschalter	VE_M/X, VG_M/X, ME_M/X, ME_M/X	65080020
2	375261	Thermostat	ME_M/X, ME_M/X	65070210
3	350035	Timer		65090200

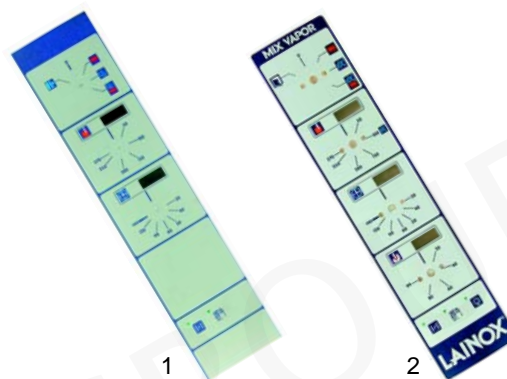

Abb.	Bestell-Nr.	Beschreibung	Gerätetyp	Ver.-Nr.
1	401294	Frontfolie	ME105/S, MG105/S, VE105/S, VG105/S	67010100
2	401295	Frontfolie	ME105/L, MG105/L, VE105/L, VG105/L	67010110

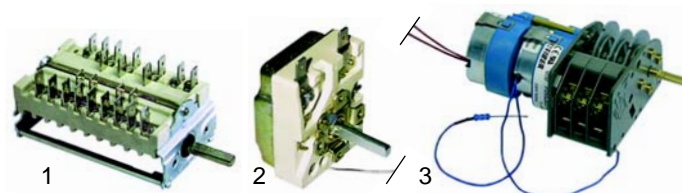

Abb.	Bestell-Nr.	Beschreibung	Gerätetyp	Ver.-Nr.
1	110138	Knebel		69030150
2	110139	Dichtung	VE_M/X, VG_M/X, ME_M/X, ME_M/X	70050020
3	359027	Signallampe/grün	ME_M/X, ME_M/X	65270230
4	359026	Signallampe/gelb		65270220

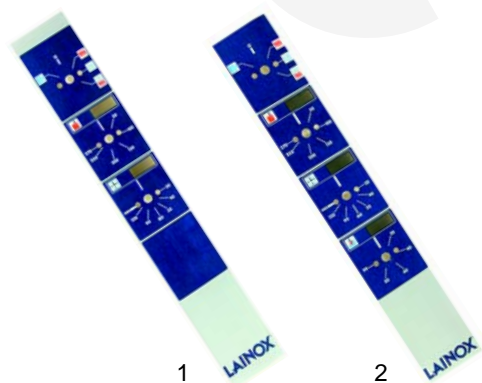

Abb.	B.-Nr.	Beschreibung	Gerätetyp	Ver.-Nr.
1	400149	Tastaturplatine	V_105X	65300580
2	400140	Tastaturplatine	V_106-220M, M_106-220M	65300500
3	400142	Tastaturplatine	V_106-220X, M_106-220X	65300570



Abb.	Bestell-Nr.	Beschreibung	Gerätetyp	Vergl.-Nr.
1	300071	Wahlschalter	M_061M, V_061M, M_101M, V_101M,	65080020
2	375667	Thermostat	M_102M, V_102M, M_201M, V_201M,	65070360
3	350035	Timer	M_202M, V_202M	65090200



Abb.	Bestell-Nr.	Beschreibung	Gerätetyp	Ver.-Nr.
1	400141	Hauptplatine	ME_X, MG_X, VE_X	65300520
2	400148	Hauptplatine	VG_X	65300550

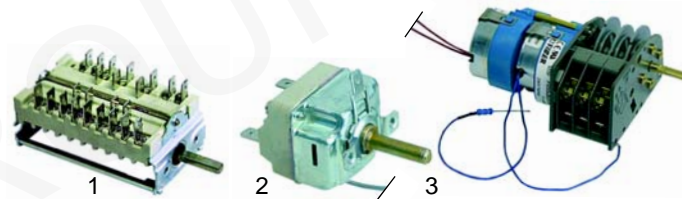

Abb.	B.-Nr.	Beschreibung	Gerätetyp	Ver.-Nr.
1	111138	Knebel (bis 26.04.'05)		69030150
2	111771	Knebel (ab 27.04.'05)		69030170
3	301227	Schalter	M_061M, V_061M, M_101M, V_101M,	65260600
3	301172	Taster	M_102M, V_102M,	65260610
4	359788	Signallampe/grün	M_201M, V_201M,	65270160
5	359789	Signallampe/gelb	M_202M, V_202M	65270150

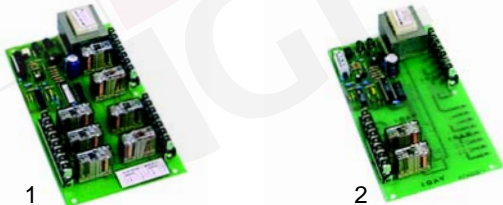

Abb.	Bestell-Nr.	Beschreibung	Gerätetyp	Ver.-Nr.
1	401304	Frontfolie	VE004M, VE104	67010450
2	401305	Frontfolie	VE004X, VE104	67010460
3	401306	Frontfolie	VE105-X, VG105M	67010490
4	401307	Frontfolie	VE105-X, VG105X	67010500

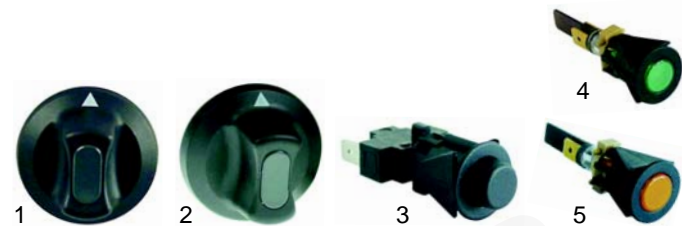

Abb.	B.-Nr.	Beschreibung	Gerätetyp	Ver.-Nr.
1	401332	Tastaturplatine	M_061M, V_061M, M_101M, V_101M, M_102M, V_102M,	65300540
2	401333	Hauptplatine	M_201M, V_201M, M_202M, V_202M, V_-M, M_-M (Kerntemperatur)	65360490

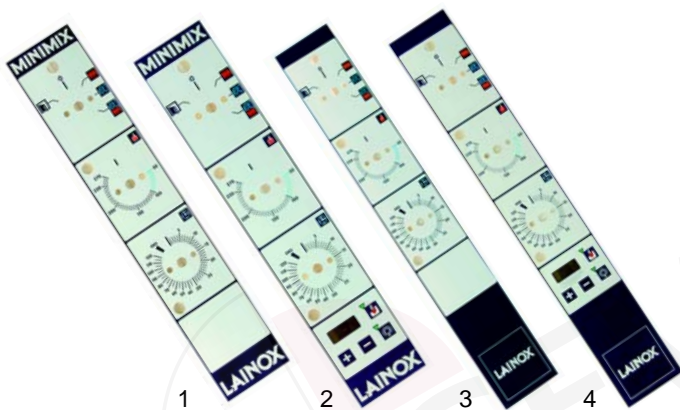

Abb.	B.-Nr.	Beschreibung	Gerätetyp	V.-Nr.
1	401308	Frontfolie	VE106-220M, VG106-220M	67010530
2	401309	Frontfolie	VE106-220X, VG106-220X	67010550
3	401310	Frontfolie	ME106-220M, MG106-220M	67010620
4	401311	Frontfolie	ME106-220X, MG106-220X	67010630

Passend für Lainox

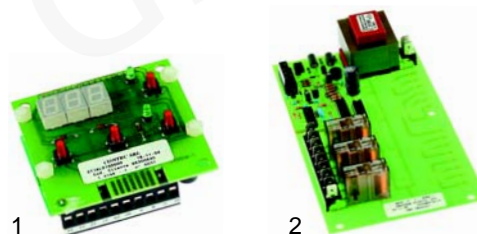

Abb.	Best.-Nr.	Beschreibung	Gerätetyp	Ver.-Nr.
1	401312	Frontfolie (Kerntemperatur)	M_061M, V_061M, M_101M, V_101M, M_102M, V_102M,	67012960
2	401313	Frontfolie	M_201M, V_201M, M_202M, V_202M, V_-M, M_-M (Kerntemperatur)	67012950

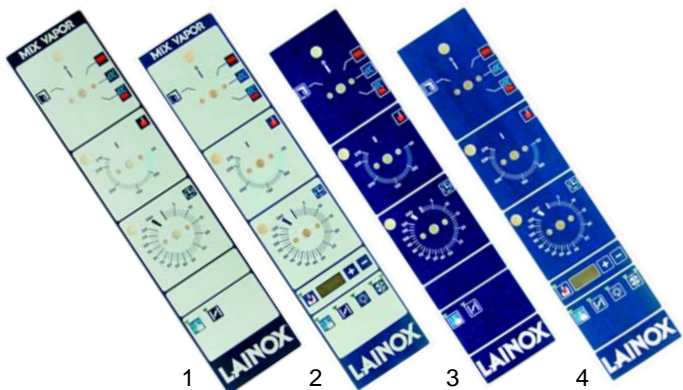

Abb.	Bestell-Nr.	Beschreibung	Gerätetyp	Vergleichs-Nr.
1	401319	Frontfolie	PE_, PG_	50708040 67010810
2	400156	Tastaturplatine		50304920 65300100

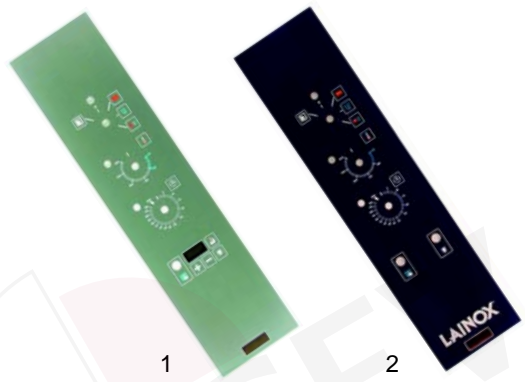

Abb.	Bestell-Nr.	Beschreibung	Gerätetyp	Vergleichs.-Nr.
1	401317	Frontfolie	FV03, FV06	50708100 67010730
2	400154	Tastaturplatine		50304890 65300070
3	400153	Hauptplatine		50304940 65300130

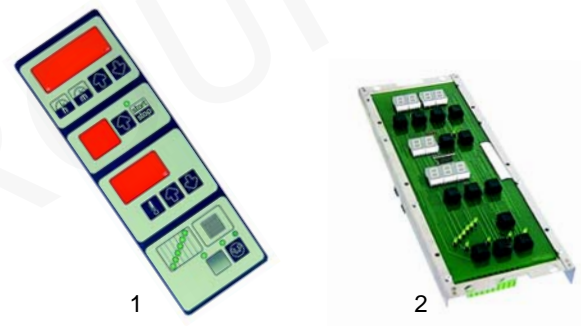

Abb.	Bestell-Nr.	Beschreibung	Gerätetyp	Vergl.-Nr.
1	401314	Frontfolie	ME_, MG_, PE_, PG_	50708400 67012030
2	401315	Frontfolie (2 Geschwindigkeiten)		50708430 67012040
3	401316	Frontfolie (2 Geschwindigkeiten und Leistung)		50708460 67012050

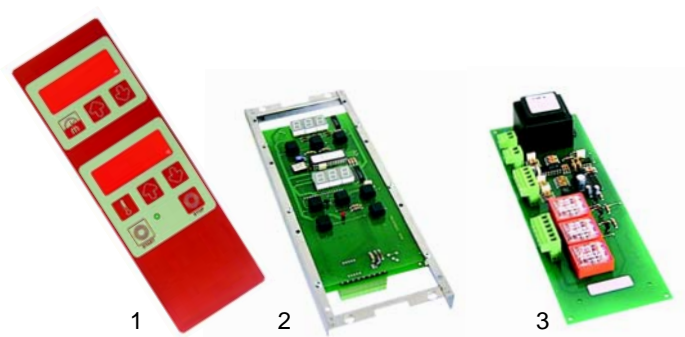

Abb.	Bestell-Nr.	Beschreibung	Gerätetyp	Vergleichs-Nr.
1	401318	Frontfolie	ME_, MG_	50708170 67010760
2	400155	Tastaturplatine		50304930 65300110



Abb.	Bestell-Nr.	Beschreibung	Gerätetyp	Vergleichs-Nr.
1	401320	Frontfolie	ME_T, MG_T	67010780
2	400159	Tastaturplatine		65300200
3	400174	Hauptplatine		65300190

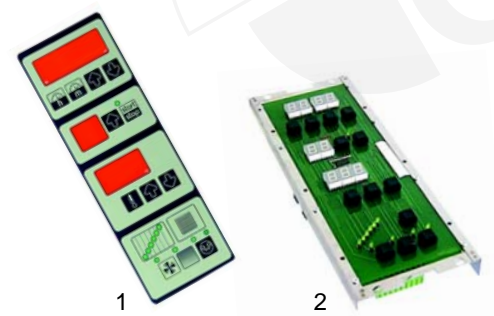

Abb.	Bestell-Nr.	Beschreibung	Gerätetyp	Vergleichs-Nr.
1	401293	Reset-Folie	ME_T, MG_T	67010830
2	400194	Reset-Platine		65300150

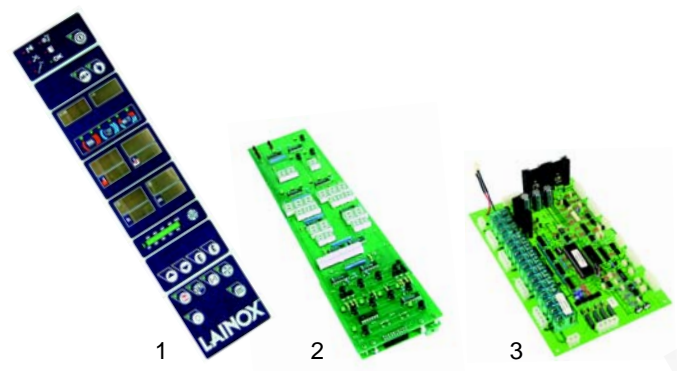

Abb.	Bestell-Nr.	Beschreibung	Gerätetyp	Vergl.-Nr.
1	401324	Frontfolie	ME_H, MG_H	67010660
2	401325	Frontfolie	VE106-220H, VG106-220H	67010940
3	400147	Tastaturplatine		65300820

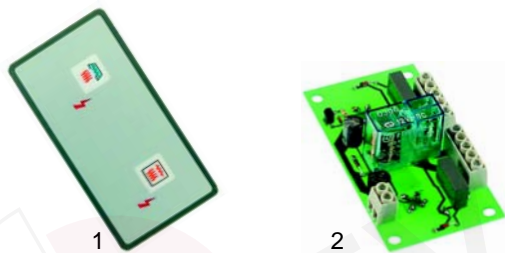

Abb.	Bestell-Nr.	Beschreibung	Gerätetyp	Vergleichs-Nr.
1	401321	Frontfolie	VE_T, VG_T	67010900
2	400159	Tastaturplatine		65300200
3	400174	Hauptplatine		65300190

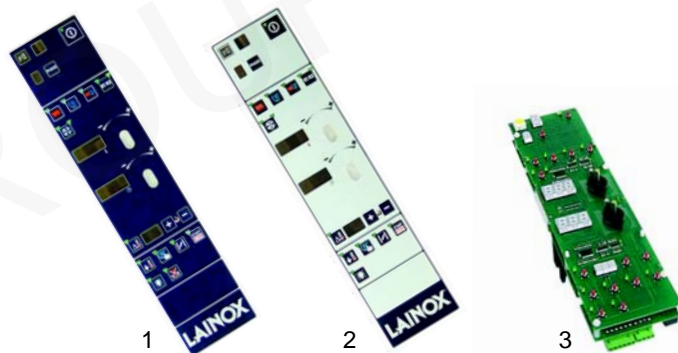

Abb.	Bestell-Nr.	Beschreibung	Gerätetyp	Vergl.-Nr.
1	401326	Frontfolie	ME_P, MG_P	67010920
2	401327	Frontfolie	VE106-220P, VG106-220P	67010950
3	400144	Tastaturplatine		65300710

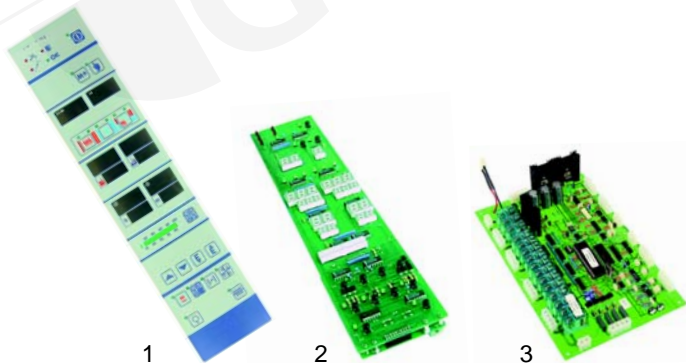

Abb.	Bestell-Nr.	Beschreibung	Gerätetyp	Vergleichs-Nr.
1	350055	Summer	M_T, V_T	65330040
2	379143	Fühler PT100		65325000

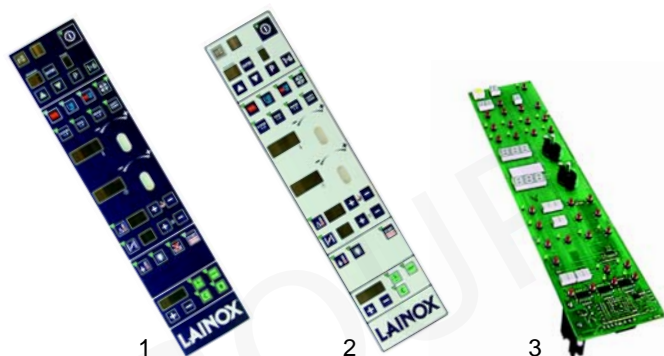

Abb.	Bestell-Nr.	Beschreibung	Gerätetyp	Vergl.-Nr.
1	401328	Frontfolie	VE004-105D, VG105D	67010850
2	401329	Frontfolie	VE004-105H, VG105H	67010870
3	400151	Tastaturplatine	VE004-105D/H, VG105/M	65300840

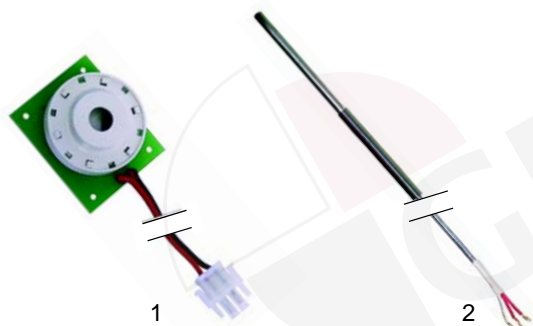

Abb.	Bestell-Nr.	Beschreibung	Gerätetyp	Vergl.-Nr.
1	401322	Frontfolie	ME_D, MG_D	67010650
2	401323	Frontfolie	VE106-220D, VG106-220D	67010930
3	400146	Tastaturplatine		65300800

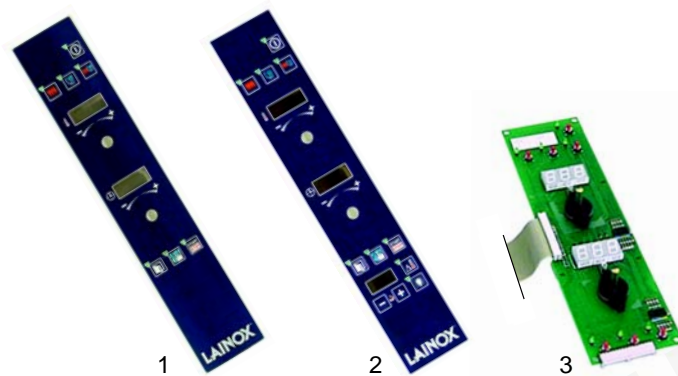

Abb.	Bestell-Nr.	Beschreibung	Gerätetyp	Vergleichs-Nr.
1	400152	Kerntemperaturplatte	VE004-105H, VG105H	65300850
2	400150	Hauptplatine	VE004-105D/H	65300830
3	110138	Knebel		69030150
4	110139	Dichtung		70050020

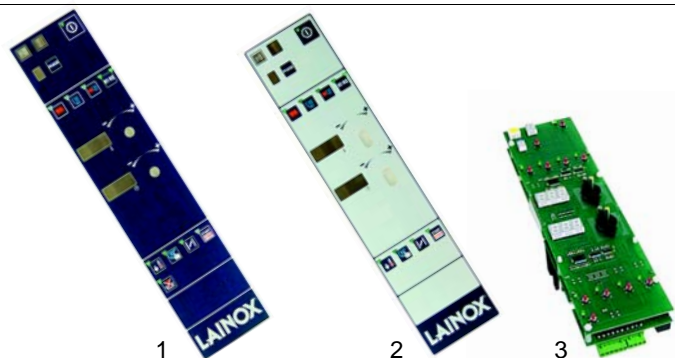

Abb.	Bestell-Nr.	Beschreibung	Gerätetyp	Vergl.-Nr.
1	401331	Frontfolie		67012900
2	401336	Tastaturplatine	M_06IT, M_10IT, M_102T, M_20IT, M_202T	65301420
3	401337	Leistungsplatine		65301410

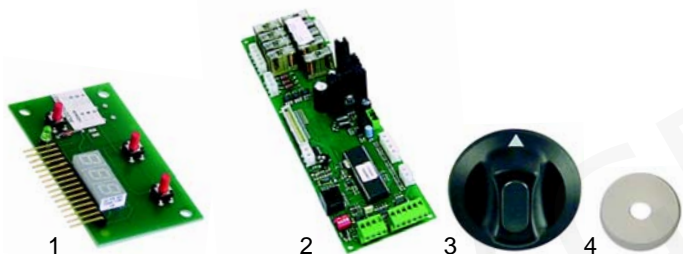

Abb.	Best.-Nr.	Beschreibung	Gerätetyp	Vergl.-Nr.
1	401348	Frontfolie		67012890
2	401352	Tastaturplatine	M_061D, V_061D, M_101D, V_101D, M_102D, V_102D,	
3	401353	Hauptplatine	M_201D, V_201D, M_202D, V_202D	
4	401334	Zusatzplatine		65301480

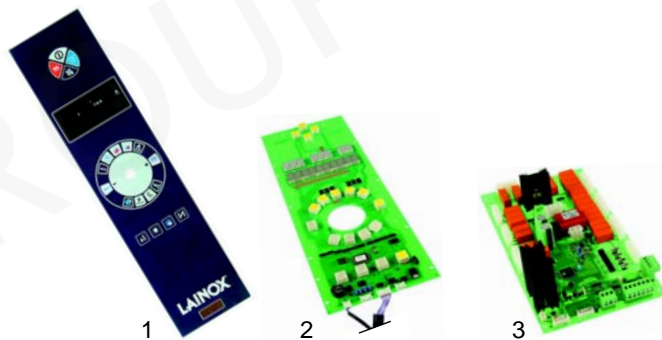

Abb.	Bestell-Nr.	Beschreibung	Gerätetyp	Vergl.-Nr.
1	401349	Frontfolie		67013461
2	401350	Tastaturplatine	VE042P, V_051P, VE055P	65301820
3	401351	Hauptplatine		65301810 65301830

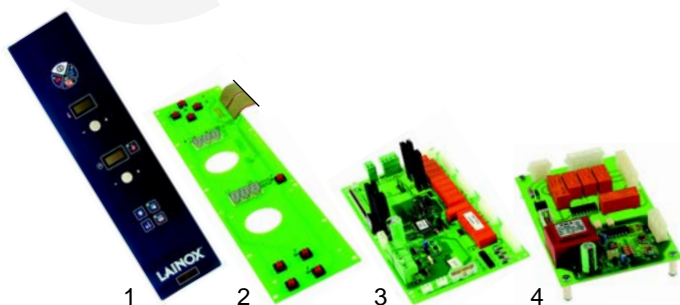

Abb.	Best.-Nr.	Beschreibung	Gerätetyp	Vergl.-Nr.
1	401330	Frontfolie	M_061P/H, V_061P, M_101P/H, V_101P, M_102P/H, V_102P, M_201P/H, V_201P, M_202P/H, V_202P	67012910
2	401335	Tastaturplatine		65301370
3	401334	Zusatzplatine		65301480

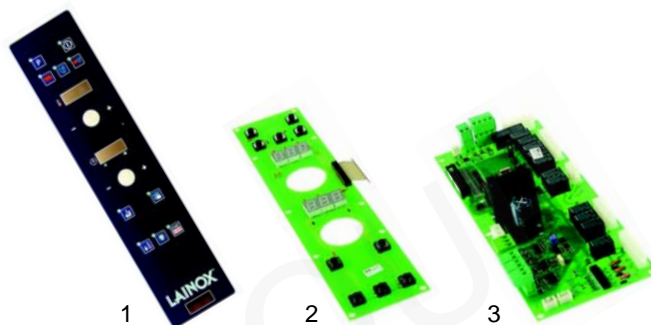

Abb.	Bestell.-Nr.	Beschreibung	Gerätetyp	Vergleichs-Nr.
1	350086	Summer		65321440 65301440
2	401338	Encoder	-D/P/H/T	65321450 65301450
3	111772	Knebel	-D/P/H	69030260
4	111771	Knebel	-T	69030290 69030170

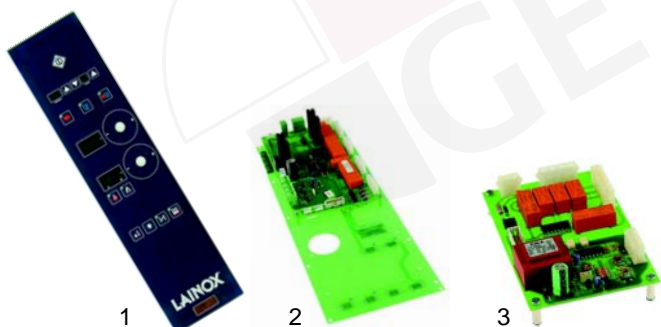

Abb.	B.-Nr.	Beschreibung	Gerätetyp	Ver.-Nr.
1	345350	Mikroschalter	F_, P_, R_, M_ (Alt)	65260530 50304530
2	345351	Mutter		
3	345032	Mikroschalter	V_042-055	65260540
4	345341	Magnetschalter	Universal	65265100

Passend für Lainox

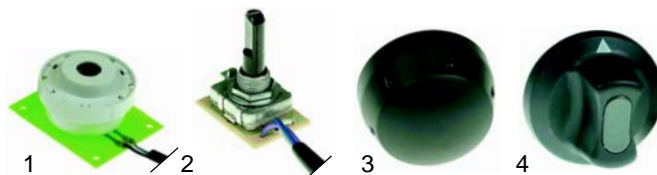

Abb.	Best.-Nr.	Beschreibung	Gerätetyp	Ver.-Nr.
1	390073	Thermostat, 2-polig, Boiler, 55.34122.839	FV03/06, ME_, MG_, PE_, PG_	50304052 65075070
2	375291	Sicherheitsthermostat, 330°C, 55.32562.820	RE_, RG_, ME_, MG_	50304092 65075040
3	375220	Sicherheitsthermostat, 330°C, 55.32562.804	ME-004/104S/L, VE-004/104S, VE-004/104D/H/M/X	65070050

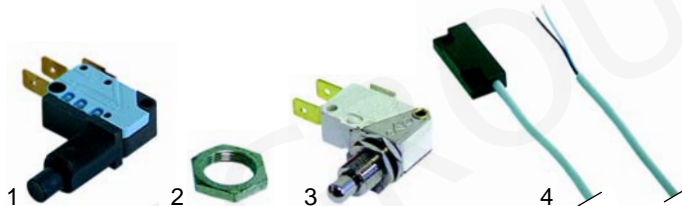

Abb.	B.-Nr.	Beschreibung	Gerätetyp	Ver.-Nr.
1	375684	Sicherheitsthermostat	V_042-202, M_061-202	65070350
2	390159	Sicherheitsthermostat, Boiler	M_061-202	65070081

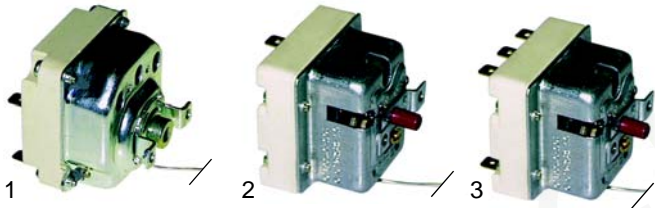

Abb.	Best.-Nr.	Beschreibung	Gerätetyp	Ver.-Nr.
1	375668	Sicherheitsthermostat, Boiler	ME004-104S/L	65075030
2	375669	Thermostat, Wasserablöschung, 55.34312.803	M_004-105S/L	65075010
3	375218	Sicherheitsthermostat, 145°C, 55.10522.801	M_004-220S/L, M_106-220 D/H/M/P/X	65075020 65070080

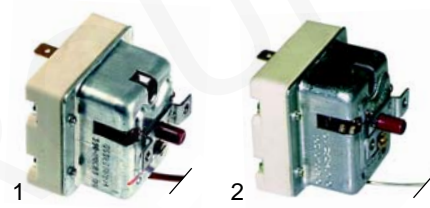

Abb.	Best.-Nr.	Beschreibung	Gerätetyp	Ver.-Nr.
1	350050	Summer	RE_, RG_, ME_, MG_, _E_M/X	50304450 65330010
2	350081	Summer	FV_, ME_, MG_, PE_, PG_	50304480 65330020
3	350055	Summer	_E_S/L/T, _G_S/L/T, _E_D/H/M/P/X, _G_D/H/M/X	65330040

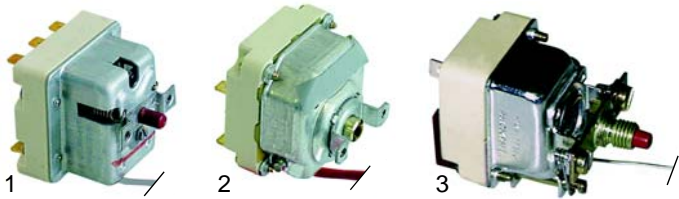

Abb.	B.-Nr.	Beschreibung	Gerätetyp	Ver.-Nr.
1	375167	Sicherheitsthermostat, 320°C, 55.10562.803	M_105-220S/L, M_106-220T, V_106-220T, M_106-220D/H/M/P/X, V_105-220D/H/M/P/X	65070070
2	390159	Sicherheitsthermostat, 120°C, Boiler, 55.32522.852	M_106-220T	65075000
3	375217	Thermostat, Wasserablöschung	M_106-220S/L, V_004-220S/L	65074990

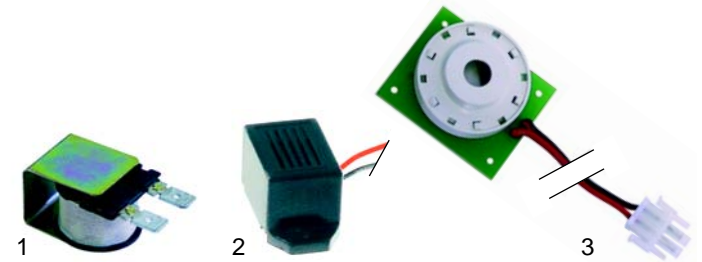

Abb.	Bestell.-Nr.	Beschreibung	Gerätetyp	Vergleichs-Nr.
1	601081	Ventilator	Universal	65060010
2	601080	Ventilator	D/H/M/P/T-, M_061-202	65060050

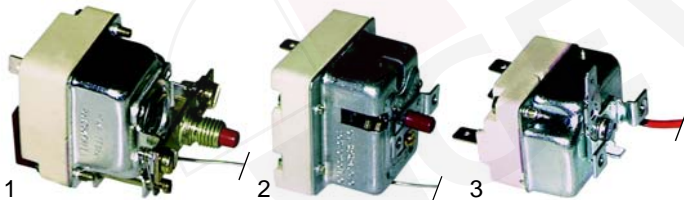

Abb.	Best.-Nr.	Beschreibung	Gerätetyp	Ver.-Nr.
1	300072	Timer, Polwender	_E_S/L/T, _G_S/L/T	65090190
2	400116	Dampfblassmotor	_E_S/L/M/X, _G_S/L/M/X	65095010
3	400115	Dampfblassmotor	_E_D/H/P/T, _G_D/H/P/T	65095000
4	360343	Ablaufstellmotor	MG_D/M/P/T	65090240

Kerntemperaturfühler

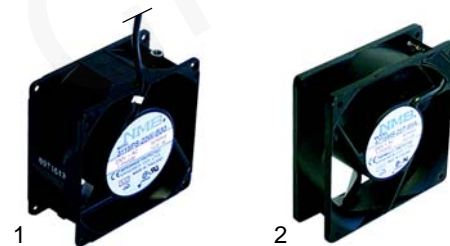

Abb.	Best.-Nr.	Beschreibung	Gerätetyp	Ver.-Nr.
1	379268	Elektronikregler		50304860 65340010
2	379054	Trafo, 2VA	RE_, RG_, ME_, MG_	50305010 65180530

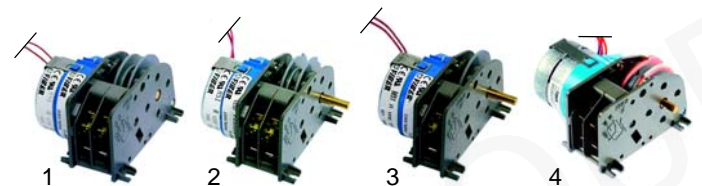

Pos.	Bestell-Nr.	Beschreibung	Gerätetyp	Vergleichs-Nr.
1	379856	Tasche für Fühler		86020420

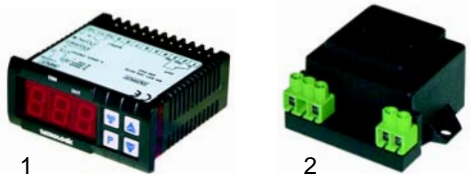
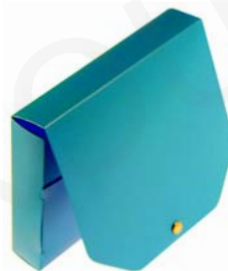

Abb.	Bestell-Nr.	Beschreibung	Gerätetyp	Vergl.-Nr.
1	379132	Fühler PT100	R_05/07/20/24, M_05/07/20/24	50305121 65320180
2	379133	Fühler PT100	R_10, M_15/21/40	50305122 65320190



Abb.	Bestell-Nr.	Beschreibung	Gerätetyp	Vergleichs-Nr.
1	380663	Socket	ME_S/L/T, MG_S/L/T,	65170020
2	380662	Relais, 12V DC	VE_S/L,	
3	380340	Socket	VG_S/L,	65170050
4	380333	Relais, 240V AC	_E_M/X, _G_M/X	

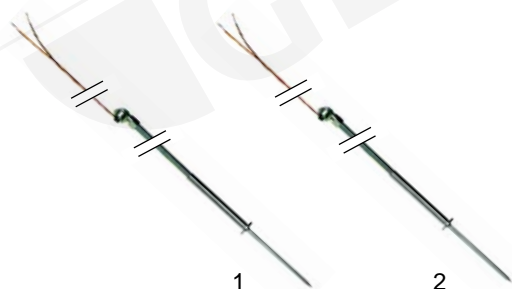

Abb.	Best.-Nr.	Beschreibung	Gerätetyp	Ver.-Nr.
1	n.m.l.	Fühler PT100		65320690 65320730
2	379135	Kerntemperaturfühler kompl. PT100	V_004-210, M_106-210, ME004-104L, M_105L	65320770 65320810 65320850 65325200 65325210 65325800

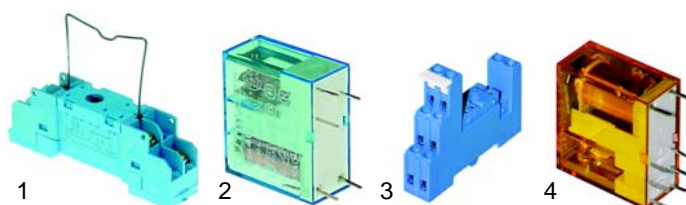

Abb.	Bestell-Nr.	Beschreibung	Gerätetyp	Vergleichs-Nr.
1	380341	Socket	ME_M/X, _G_M/X	65090460
2	380329	Zeitrelais		
3	380336	Relais	VE004-104D/ H, V_042-051P	65170100

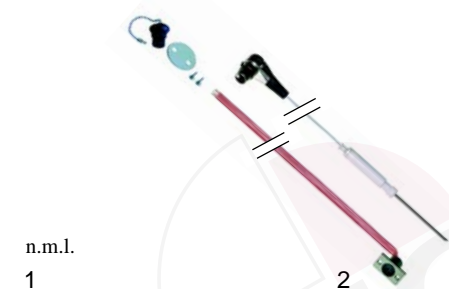

Abb.	Bestell-Nr.	Beschreibung	Gerätetyp	Vergleichs-Nr.
1	379134	Fühler PT100		65320900
2	379140	Steckdose	_E_H/P/X, _G_H/P/X	65320920
3	550423	Deckel		65321020



Abb.	Bestell-Nr.	Beschreibung	Gerätetyp	Vergleichs-Nr.
1	380490	Zeitrelais	VG_D/H/M/X, M_061-202M	65090450
2	380489	Zeitrelais	VE042P	65090480

Passend für Lainox

Niveauregler

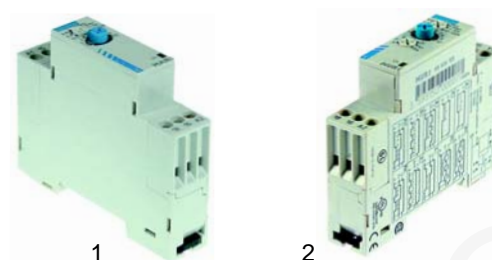

Abb.	Best.-Nr.	Beschreibung	Gerätetyp	Ver.-Nr.
1	400018	Niveauregler	ME_/M/X, MG_M/X	65120010
2	400130	Elektrode	Universal (siehe Tabelle)	65320010 50001910

Lainox	65324600	65324610	65324630	65324620	65324640	65324650	65324660	65324680	65324700	65324710	65324720	65324730	65324750	65324740	65324760	65324770	65324780	65324820	65324840	65320010
Länge (mm)	45	55	60	70	73	75	80	85	90	95	100	105	110	120	125	130	140	145	160	180
Type																				
FV03/06																				X
ME-05-40																				X
MG05-40																				X
ME004-104	X	X																		
ME105				X			X													
ME106				X	X		X													
ME110-220								X	X			X								
MES20/S24/C20/C24								X	X			X								
MES40/C40						X				X										
MG105							X				X									
MG106-110														X	X		X			
MG120-220																				
MGS20/S24/C20/C24																	X	X	X	
ME061			X	X																
ME101/102							X				X									
ME201																			X	X
ME202											X		X							
MG061-202H/T							X				X									
MG061-202M											X			X						
EM06				X			X													
EM010-020								X				X								
GM06							X				X									
GM010-020													X			X				

L

Passend für Lainox

Beleuchtung



Abb.	Bestell-Nr.	Beschreibung	Gerätetyp	Vergl.-Nr.
1	359669	Fassung		50304510 65270400
2	359599	Halogenlampe, 12V/20W	RE_, RG_, ME_, MG:., PE_, PG_	50304520 65270020
3	400095	Transformator		50305050 65180630



Abb.	Bestell-Nr.	Beschreibung	Gerätetyp	Vergleichs-Nr.
1	359670	Glas		71500150
2	359671	Dichtung	M_D/H/M/T	70044200
3	359672	Rahmen		11401450



Abb.	Bestell-Nr.	Beschreibung	Gerätetyp	Ver.-Nr.
1	400126	Transformator, 20VA	M_106S/L/T, V_106S/L/T	65180420
2	400127	Transformator, 40VA	M_110-220S/L/T, V_110-220S/L/T	65180430



Abb.	Bestell-Nr.	Beschreibung	Gerätetyp	Vergleichs-Nr.
1	359673	Fassungshalter		11401440
2	359674	Fassung	M_D/H/M/T	65270450
3	359599	Halogenlampe, 12V/20W		65270020



Abb.	Bestell-Nr.	Beschreibung	Gerätetyp	Ver.-Nr.
1	359667	Abdeckung		10400150
2	359668	Dichtung	M_S/L/T, V_S/L/T, M_H/P/X, V_H/P/X	70040800
3	359669	Fassung		65270400
4	359599	Halogenlampe, 12V/20W		65270020

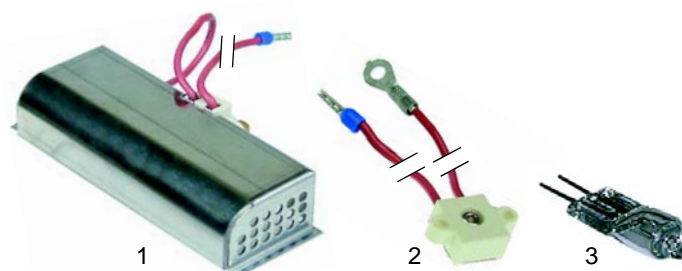

Abb.	Bestell-Nr.	Beschreibung	Gerätetyp	Vergl.-Nr.
1	346388	Lichtkontaktschalter	M_D/H/M/P/T, V_D/M/P	65260750
2	359375	Fassung/kpl.		65270510
3	359612	Lampe, E14, 20W		-



Abb.	Bestell-Nr.	Beschreibung	Gerätetyp	Vergl.-Nr.
1	400126	Trafo, 20VA	M_106H/P/X, V_106H/P/X	65180420
2	400127	Trafo, 40VA		65180430



Abb.	Bestell-Nr.	Beschreibung	Gerätetyp	V.-Nr.
1	400126	Transformator, 20VA	M_061H/M/T	65180420
2	400127	Transformator, 40VA	M_101-202/H/M/T	65180430

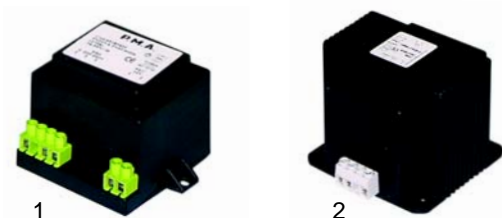

Abb.	Bestell-Nr.	Beschreibung	Gerätetyp	Vergleichs-Nr.
1	379054	Trafo, 3VA/12V	Universal	50305010 65180530
2	401339	Trafo, 6VA/12V	Universal	65180370
3	400096	Trafo, 15VA/12V	Universal	50305030 50305080 65180400
4	400125	Trafo, 16VA/12V	Universal	65180410

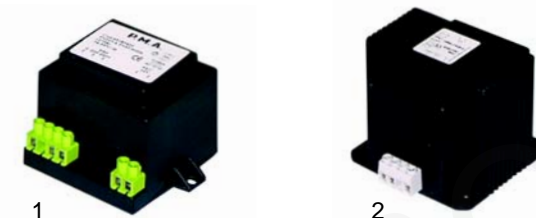

Abb.	Bestell-Nr.	Beschreibung	Gerätetyp	Vergleichs-Nr.
1	400126	Trafo, 20VA/12V	Universal	65180420
2	400128	Trafo, 23VA/12V	Universal	65180650
3	400127	Trafo, 40VA/12V	Universal	65180430



Abb.	Bestell-Nr.	Beschreibung	Gerätetyp	Vergleichs-Nr.
1	401340	Trafo, 50VA/12V	Universal	65180770
2	400095	Trafo, 50VA/12V	Universal	50305050 65180630



Abb.	B.-Nr.	Beschreibung	Gerätetyp	V.-Nr.
1	373017	Magnetventil, 1-fach	FE_, FG_, RE_, RG_, M_105S/L/K, V_106-220S/L/T, M_106-220M/X, V_106-220D/H/M/P/X	50102860 65110010
2	370357	Magnetventil, 2-fach	FV_, ME_, MG_, PE_, PG_, M_106-220S/L/T, V_105S/D/H/M/X, M_106-220D/H/M/P/X	50102891 61115000
3	370358	Magnetventil, 2-fach	ME004/104S/L	65115010

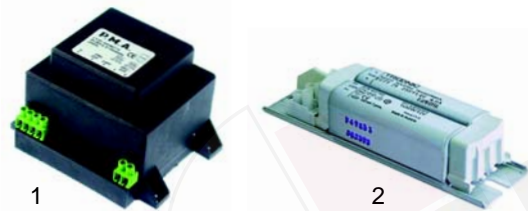

Abb.	Best.-Nr.	Beschreibung	Gerätetyp	Ver.-Nr.
1	373021	Magnetventil, 2-fach	M_106-220S/L/T, M_106-220D/H/P	65110040
2	370359	Magnetventil, 2-fach	VE004/104S, VE004/ 104D/HM/P/X	65115050



Abb.	Best.-Nr.	Beschreibung	Gerätetyp	Ver.-Nr.
1	370360	Magnetventil, 1-fach	V_106-210D/H/P/X	65115040
2	370361	Magnetventil, 2-fach	V_220D/H/M/P/X	65115060



Abb.	Best.-Nr.	Beschreibung	Gerätetyp	Ver.-Nr.
1	374030	Magnetventil, 1-fach	M_061-202M	65110200
2	374031	Magnetventil, 2-fach	M_061-202H/M/T	65110210
3	374032	Magnetventil, 2-fach	M_061-202H/T	65110230

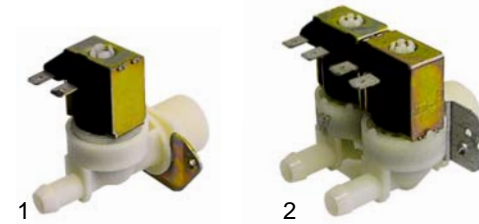

Abb.	Bestell-Nr.	Beschreibung	Gerätetyp	Vergl.-Nr.
1	374033	Magnetventil, 3-fach	M_061-202T	65110240
2	370363	Magnetventil, 1-fach		65110260



Abb.	Best.-Nr.	Beschreibung	Gerätetyp	Vergl.-Nr.
1	400113	Motorkugelventil, 1/2"	Universal	65110540
1	401342	Motorkugelventil, 3/4"	Universal	65110560
2	541074	Pressostat, Wasser, 0,5-0,35bar	Universal	63070050



Abb.	Bestell-Nr.	Beschreibung	Gerätetyp	Vergleichs-Nr.
1	418191	5400W/230V	FE05	50303560 65015830 65011500
2	415871	6000W/230V	RE05, ME05	50303270 65011520 65015910
3	415993	7200W/230V	PE04	50303570 65016010 65010680

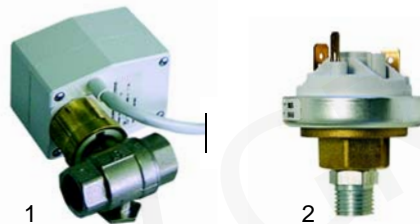

Abb.	Bestell-Nr.	Beschreibung	Gerätetyp	Vergl.-Nr.
1	415845	3150W/230V	ME004, VE004	65010280 65010300 65010320
2	415855	3900W/230V	ME104, VE104D/H/M/X	65010430 65010440 65010450
3	415871	6000W/230V	ME105, VE105, VE042P	65011520



Abb.	Bestell-Nr.	Beschreibung	Gerätetyp	Vergl.-Nr.
1	418196	6000W/230V	VE051P, VE055P	65011530
2	415993	7200W/230V	S/L/T, ME106, VE106	65010680 65010570 65010580
3	415829	7500W/230V	D-H-M-X, ME106, VE106, ME061, VE061	65011540



Abb.	Bestell-Nr.	Beschreibung	Gerätetyp	Vergl.-Nr.
1	415828	15000W/230V	ME110-220, VE110-220, ME101-202, VE101-202	65011310
2	415827	9000W/230V	ME210/220, VE210/220	65011210
3	418197	15000W/230V	ME102/202, VE102/202	65011250



Abb.	Bestell-Nr.	Beschreibung	Gerätetyp	Vergl.-Nr.
1	415388	1500W/230V	RE7	50303850 50303180 65010090 65015100
2	415737	2500W/230V	RE10, PE08, ME10, 21	50303150 65010180 65015300
3	415736	3500W/230V	RE20, 24, ME20, 24, 40	50303170 65015660 65010390
4	415387	1800W/230V	ME15, PE12	50303160 65015210 65010110



Abb.	Best.-Nr.	Beschreibung	Gerätetyp	Vergl.-Nr.
1	418193	7500W/230V, rechts	ME110, VE110, ME120 (0-R, U-L)	65010610 65011580 65010630
2	418192	7500W/230V, links	ME110, VE110, M120 (0-R, U-L)	65011590 65010620 65010640
3	418195	12000W/230V, rechts	ME210, VE210, ME220 (0-R, U-L)	65010870 65011610 65010890
4	418194	12000W/230V, links	ME210, VE210, ME220 (0-R, U-L)	65010880 65011620 65010900

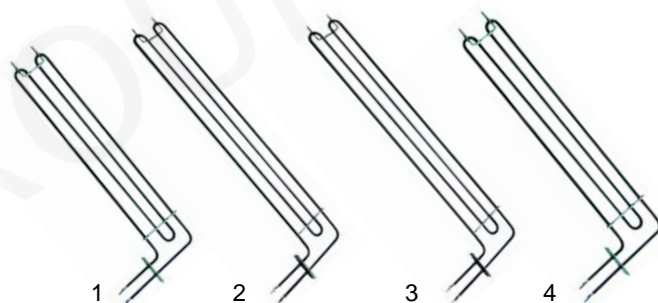

Abb.	Best.-Nr.	Beschreibung	Gerätetyp	Vergl.-Nr.
1	415021	6000W/230V	FV03/06, ME05/40	50303250
2	418198	3150W/230V	ME004	65020110 05020120
3	418199	3900W/230V	ME104	65020180 65020190

Passend für Lainox

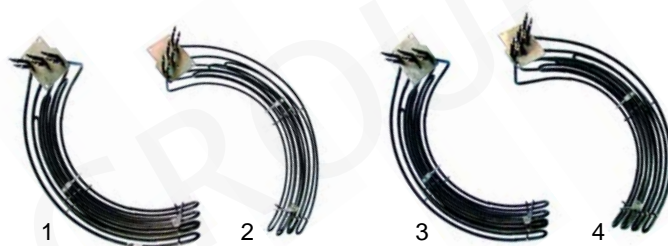

Abb.	Best.-Nr.	Beschreibung	Gerätetyp	Vergl.-Nr.
1	418200	6000W/230V	ME105	65020240 65020280 65020270
2	415848	7500W/230V	ME106-210, D/H/M/X, ME106- 210, ME061-101	65020320 65020350
3	415849	15000W/230V	ME220, D/H/M-X, ME220, ME102-202	65020390 65020400 65020420



Abb.	Best.-Nr.	Beschreibung	Gerätetyp	Vergl.-Nr.
1	500140	0,06PS, 230V	ME004/104, VE004/ 104	50405435 65040101 65040100
2	500139	0,15PS, 230V	FE05, FG05, M105	50405405 50405580 65040310 65400070 65400071
3	601043	0,5/0,1PS, 230V	RE05, RG05, ME05, MG05, PE04, PG04	50405610 65040260

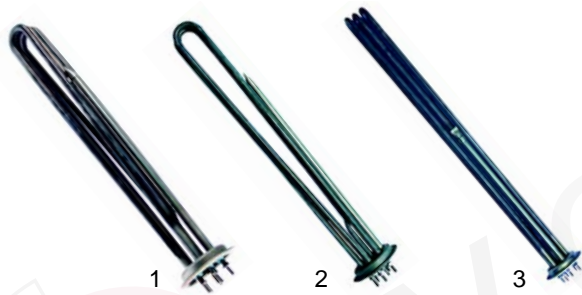

Abb.	Best.-Nr.	Beschreibung	Gerätetyp	Vergl.-Nr.
1	500134	0,25PS	M_106D/M/S, V_106D/M/S	50405225 65040021
2	500133	0,25/0,1PS, 230V	M_106H/P/X/L/T, V_106H/P/X/L/T	30405215 65040011



Abb.	Best.-Nr.	Beschreibung	Gerätetyp	Vergl.-Nr.
1	601046	0,75PS, 1 Geschwindig- keit, 400V3~	M_10-M40, P_08/12	50405510 65040170
2	500655	0,75PS, 2 Geschwindig- keiten, 400V3~	M_10-M40, P_08/12	50405530 65040190

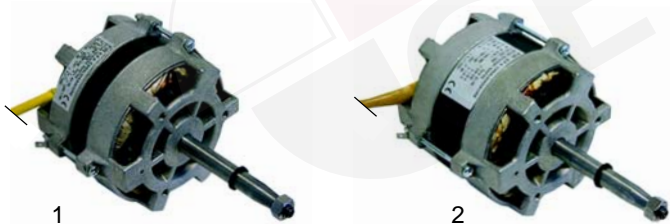

Abb.	Best.-Nr.	Beschreibung	Gerätetyp	Ver.-Nr.
1	500138	1PS, 1 Geschwindigkeit, 400V3~	-D/M/S-, ME110-220, VE110-220, ME102-202H/M/D, VE102-202M/D	65400060 65400061 52405265
2	500137	1/0,3PS, 2 Geschwindigkeiten, 400V3~	-H/P/X/L/T, ME110-220, VG110-220, ME102-202, VE102-202P	65400050 65400051

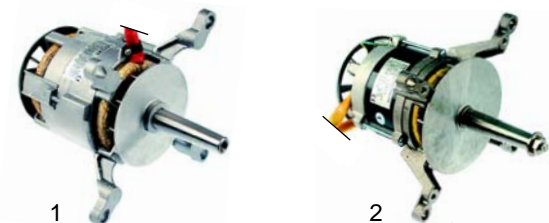

Abb.	Best.-Nr.	Beschreibung	Gerätetyp	Vergl.-Nr.
1	500136	1PS, 1 Geschwindigkeit, 230V	-D/M/S-, MG110-220, VG110-220, MG102-202H/M	65400040 65400041 50405245
2	500135	1/0,3PS, 2 Geschwindigkeiten, 230V	-H/P/X/L/T, MG110-220, VG110-220, MG102-202T	65400030 65400031 50405235



Abb.	Best.-Nr.	Beschreibung	Gerätetyp	Ver.-Nr.
1	500662	1 Geschwindigkeit	VE042P, V_051P, VE055P	65041000
2	500663	1 Geschwindigkeit	M_061M/H/D, V_061M/D	65040421
3	500661	2 Geschwindigkeiten	M_061P/T, V_061P	65040431



Abb.	Bestell-Nr.	Beschreibung	Gerätetyp	Vergl.-Nr.
1	500658	1 Geschwindigkeit	ME101H/M/D, VE101M/D	65040530
2	500656	2 Geschwindigkeiten	ME101P/T, VE101P	65040520



Abb.	Bestell-Nr.	Beschreibung	Gerätetyp	Vergl.-Nr.
1	500659	1 Geschwindigkeit	MG101H/M/D, VG101M/D	65040550
2	500657	2 Geschwindigkeiten	MG101P/T, VG101P	65040540

Lüfterräder

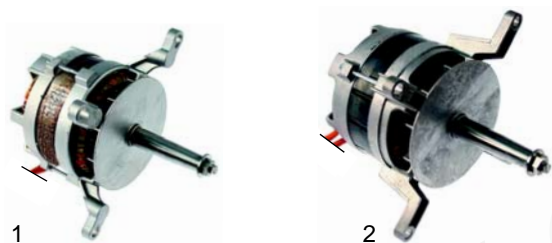

Abb.	Bestell-Nr.	Beschreibung	Gerätetyp	Vergl.-Nr.
1	601067	155x38mm, 36 Schaufeln	ME004/104, VE042, VE004/104	75400040 75400030 50405781 75400510
2	601061	160x60mm, 15 Schaufeln	FE05, FG05	75400060 50405740

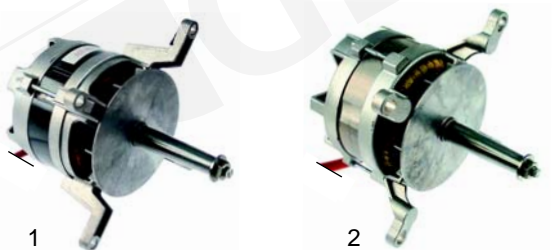

Abb.	Bestell-Nr.	Beschreibung	Gerätetyp	Vergl.-Nr.
1	601068	160x70mm, 16 Schaufeln	VE105	75400080 50405795
2	601060	180x60mm, 16 Schaufeln	ME05, MG05, RE05, RG05, PE04, PG04	75400120 50405730
3	601246	180x77mm, 12 Schaufeln	V_051, VE055	75400410



Abb.	Best.-Nr.	Beschreibung	Gerätetyp	Ver.-Nr.
1	601064	220x78mm, 20 Schaufeln	M_106D/H/M/P/X, V_106D/H/M/P/X	75400230 50405812
2	601243	220x78mm, 12 Schaufeln	M_061, V_061	75400400
3	601062	270x100mm, 24 Schaufeln	RE07, RG07, ME15, MG15, ME21, MG21, PE12, PG12	75400240 50405720

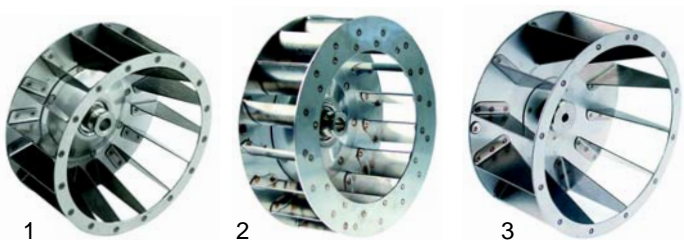

Abb.	Bestell-Nr.	Beschreibung	Gerätetyp	Vergl.-Nr.
1	601065	300x120mm, 20 Schaufeln	M_110/120S/L/T, V_110/120S/L/T -D/H/M/P/X-, M_110/120, V_110/120	75400270 50405820 75400290
2	601063	350x100mm, 24 Schaufeln	R_10/20/24/40, M_10/20/24/40, P_8	75400330 50405710

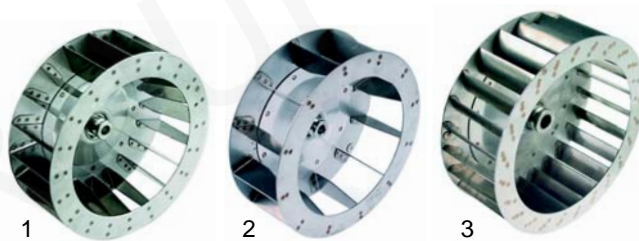

Abb.	Bestell-Nr.	Beschreibung	Gerätetyp	Vergleichs-Nr.
1	601244	350x114mm, 12 Schaufeln	M_101-202, V_101-202	75400440
2	601066	350x120mm, 24 Schaufeln	-D/H/M/P/X-, M_210/220, V_210/220	75400380

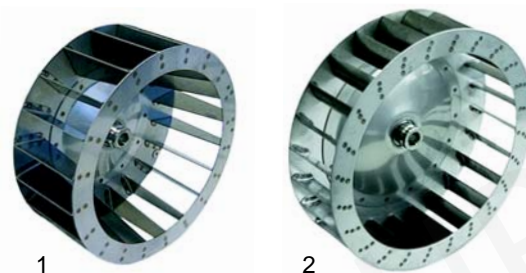

Abb.	Bestell-Nr.	Beschreibung	Gerätetyp	Vergl.-Nr.
1	550855	Flansch		58005510
2	511170	Motordichtung	_004, _104	50505895 70020010
3	550860	Flansch	VE042, V_051,	58005500
4	550861	Motordichtung	VE055	70020020

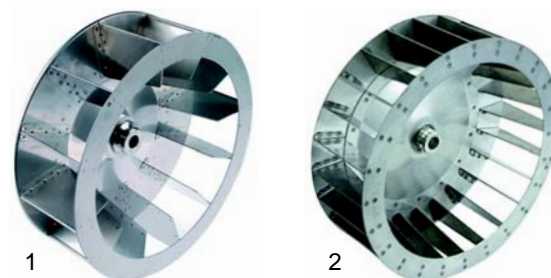

Abb.	Bestell-Nr.	Beschreibung	Gerätetyp	Vergl.-Nr.
1	550856	Flansch		58003860
2	511171	Motordichtung	_105, _106, _05, _04, _061	50505880, 70020040
3	550857	Gegenflansch		58003870



Abb.	Bestell-Nr.	Beschreibung	Gerätetyp	Ver.-Nr.
1	550858	Flansch		58003840
2	511172	Motordichtung	_110/120, _210/220, _10-40, 101/102, 201/202	50505890, 70020050
3	550859	Gegenflansch		58003850



Abb.	Bestell-Nr.	Beschreibung	Gerätetyp	Ver.-Nr.
1	358512	Sicherungshalter		50305160, 65210020
2	550421	Klemmleiste, 3-polig + N + PE, 6mm ²	Universal	50304720, 65220090
3	550420	Klemmleiste		65220080



Abb.	Best.-Nr.	Beschreibung	Gerätetyp	Ver.-Nr.
1	550551	Klemmleiste		50304731, 65220110
2	550422	Klemmleiste, 3-polig + N-PE, 2 x 35mm ²		50304741, 65220130
3	550552	Klemmleiste	ME40	50304742, 65220140

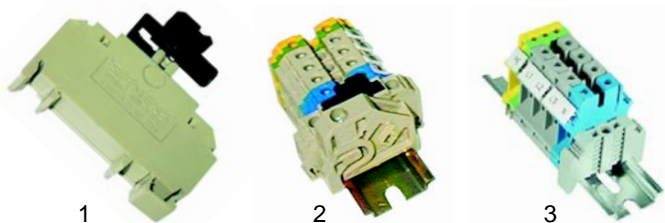

Abb.	Best.-Nr.	Beschreibung	Gerätetyp	Ver.-Nr.
1	358522	Überstromauslöser	FE05, FG05	50304370, 65160400
2	358520	Überstromauslöser, 2,5A	R_05, M_05, P_05	50304400, 65160220
3	358521	Überstromauslöser, 0,7A, 2 Geschwindigkeiten	R_05, M_05, P_05	50304420, 65160200

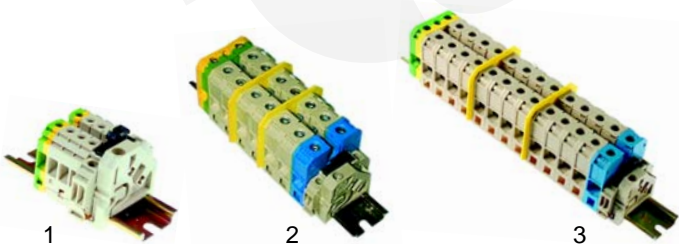

Abb.	Bestell-Nr.	Beschreibung	Gerätetyp	Vergl.-Nr.
1	380644	Schütz		50304251, 65140140
2	380645	Schütz		50304271, 65140230, 65140240
3	380648	Motorschutzschalter		50304170, 65160010
3	380649	Motorschutzschalter		50304190, 65160020
3	380650	Motorschutzschalter		50304180, 65160040
3	380651	Motorschutzschalter		50304200, 65160030
4	380654	Schütz		65140150, 65140170

Brenner (alle Serien)



Abb.	Best.-Nr.	Beschreibung	G.-typ	Ver.-Nr.
1	380655	Überstromauslöser, 0,25A - 0,40A		65160150
1	380656	Überstromauslöser, 0,63A - 1,0A		65160110
1	380657	Überstromauslöser, 1,6A - 2,5A		65160120
2	380658	Halter		65160050

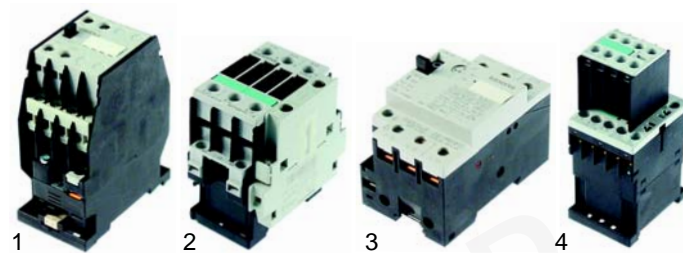

Abb.	Best.-Nr.	Beschreibung	Gerätetyp	Ver.-Nr.
1	380652	Schütz		65140380
2	380646	Schütz		65140400
3	380661	Überlastrelais, 1,4A - 2,0A		65160620
3	380662	0,7A - 1,0A		65160570
3	380663	1,8A - 2,5A		65160580

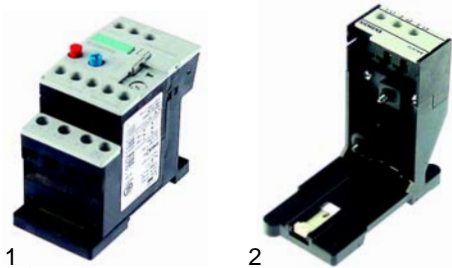

Abb.	Bestell-Nr.	Beschreibung	Gerätetyp	Vergleichs-Nr.
1	380653	Kontaktblock		65140420
2	380647	Kontaktblock		65140430



Abb.	Bestell-Nr.	Beschreibung	Gerätetyp	Ver.-Nr.
1	358514	Überstromauslöser, 0,8A		65160300
2	358515	Überstromauslöser, 2,5A		65160310
3	358516	Überstromauslöser, 2,0A		65160320

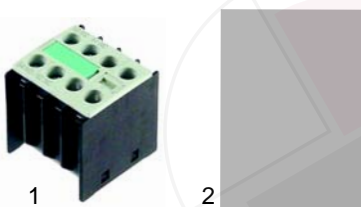

Pos.	Bestell-Nr.	Beschreibung	Gerätetyp	Vergl.-Nr.
1	105838	Brenner (Heißluft)	FG05	50204200
2	105839	Brenner (Heißluft)	RG05, MG05	50204210
3	105840	Brenner (Heißluft)	RG07	50204290
4	105841	Brenner (Heißluft)	RG10, MG10	50204230
5	105842	Brenner (Heißluft)	RG20/24, MG15, PG08	50204240, 63015280
6	105843	Brenner (Heißluft)	RG40, MG40	50204280
7	105844	Brenner (Heißluft)	MG20/24	50204250, 63015290
8	105845	Brenner (Heißluft)	MG21	50204260, 63015300
9	105846	Brenner (Heißluft)	PG04	50204300, 63015270
10	105847	Brenner (Heißluft)	PG12	50204310, 63015260



Pos.	Bestell-Nr.	Beschreibung	Gerätetyp	Vergl.-Nr.
1	105836	Brenner (Boiler)	MG05-21	50204220, 63015470
2	105837	Brenner (Boiler)	MG24-	50204270, 63015480

Serie S/L/T



Pos.	Bestell-Nr.	Beschreibung	Gerätetyp	Vergl.-Nr.
1	105848	Brenner (Heißluft)	MG105, VG105	63014980
2	105849	Brenner (Heißluft)	MG106, VG106	63015000
3	105850	Brenner (Heißluft)	MG110, VG110	63015020
4	105851	Brenner (Heißluft)	MG120, VG120	63015060
5	105852	Brenner (Heißluft)	MG210, VG210	63015040
6	105853	Brenner (Heißluft)	MG220, VG220	63015070

Passend für Lainox



Pos.	Bestell-Nr.	Beschreibung	Gerätetyp	Vergl.-Nr.
1	105854	Brenner (Boiler)	MG105	63014990
2	105855	Brenner (Boiler)	MG106	63015010
3	105856	Brenner (Boiler)	MG110	63015030
4	105857	Brenner (Boiler)	MG120/210	63015050
5	105858	Brenner (Boiler)	MG220	63015080

Serie D/H/M/P/X



Pos.	Bestell-Nr.	Beschreibung	Gerätetyp	Vergl.-Nr.
1	105831	Brenner (Heißluft)	MG106, VG106	63016050
2	105832	Brenner (Heißluft)	MG110, VG190	63016070
3	1058333	Brenner (Heißluft)	MG120, VG120	63016110
4	105834	Brenner (Heißluft)	MG210, VG210	63016090
5	105835	Brenner (Heißluft)	MG220, VG220	63016120



Pos.	Bestell-Nr.	Beschreibung	Gerätetyp	Vergl.-Nr.
1	105827	Brenner (Boiler)	MG106	63016060
2	105828	Brenner (Boiler)	MG110	63016080
3	105829	Brenner (Boiler)	MG120/210	63016100
4	105830	Brenner (Boiler)	MG220	63016130



Abb.	Bestell-Nr.	Beschreibung	Gerätetyp	Vergl.-Nr.
1	101126	Elettrositregler, 1/2"	FG05, RG05, MG05, PG04	50203151, 63025020
2	101127	Elettrositregler, 3/4"	RG07-RG40, MG10-MG40, PG08-PG12	50203161, 63025030



Abb.	Bestell-Nr.	Beschreibung	Gerätetyp	Vergl.-Nr.
1	105755	Frontteil	MG05-10, PG04	50202801, 69130160
2	102756	Frontteil	MG15-40, PG12	50202821, 69130200
3	102757	Frontteil	PG08	50202811, 69130180



Abb.	Bestell-Nr.	Beschreibung	Gerätetyp	Vergl.-Nr.
1	101414	Anzeige		50202830, 65350010
2	101265	Unterbrecher, M9x1		50203130, 63040210
3	101002	Zündgruppe	FG05	50102710, 50102700, 65180280, 65180290



Abb.	Bestell-Nr.	Beschreibung	Gerätetyp	Ver.-Nr.
1	100046	Zündbrenner	FG05, RG05-40, MG05-40, PG04-12	50203220, 63050020
2	100706	Zündkerze		50102720, 63050010
3	102042	Thermoelement, 850mm	FG05, RG05, MG05, PG04	50203230, 63040020
3	102045	Thermoelement, 1500mm	RG07-40, MG05-40, PG08/12	50203240, 63040030
4	102163	Zündkabel, 1500mm	FG05, RG05, MG05, PG04	50707370, 66600410
4	100179	Zündkabel, 1200mm	RG07-40, MG05-40, PG08/12	50707360, 66600400



Abb.	Bestell-Nr.	Beschreibung	Gerätetyp	Vergleichs.-Nr.
1	102363	Elektrode	105 S/L/T	65265020
2	102364	Elektrode	105 S/L/T	65265030
2	102365	Elektrode	105 S/L/T	65265000



Abb.	Best.-Nr.	Beschreibung	Gerätetyp	Ver.-Nr.
1	102366	Elektrode	106 S/L/T	65265050
2	100737	Elektrode	110/120 S/L/T, 210/220 S/L/T	65265070
3	100730	Flammenüberwachung	Serie -D/H/M/P/X-	63050040



Abb.	Bestell-Nr.	Beschreibung	Gerätetyp	Vergl.-Nr.
1	101395	Honeywellventil	_G105_, _G106_,	63020010
2	101426	Magnetspule	_G110_, _G120_,	65150030
3	541073	Pressostat	_G210_, _G220_	63070010



Abb.	Bestell-Nr.	Beschreibung	Gerätetyp	Vergl.-Nr.
1	601245	Gebläse	-G051, _G061,	63130010
2	401341	Platine (Gebläseregelung)	_G101, _G102, _G201, _G202	63130020



Abb.	Bestell-Nr.	Beschreibung	Gerätetyp	Vergl.-Nr.
1	101165	Feuerungsautomat	Serie S/L/T	63060020
2	101377	Feuerungsautomat	Serie D/H/M/P/X	63060080

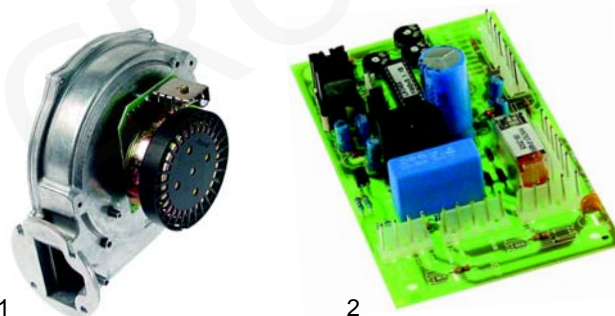

Abb.	Bestell-Nr.	Beschreibung	Gerätetyp	Vergl.-Nr.
1	106012	Ventil		63020170
2	102367	Feuerungsautomat	VG051, _G061,	63060120
3	100737	Elektrode	_G101, _G102, _G201, _G202	63050070
4	541073	Pressostat		63070010



Abb.	Bestell-Nr.	Beschreibung	Gerätetyp	Ver.-Nr.
1	550862	Dichtungssatz		70045090
2	550863	Buchse (Waschen)	M_6IT, M_10IT, M_102T, M_20IT,	58004980
3	550864	Düse, 0,5L/min	M_202T	62210042
4	550865	Düse, 1,32L/min		62210032



Abb.	Bestell-Nr.	Beschreibung	Gerätetyp	Ver.-Nr.
1	690596	Türverschluss	FE05, FG05, R_05-20, P_04-08	50103110, 69050010
2	700081	Türgriff		50103010, 69010030
3	700082	Kloben	FV03, FV06	50103020, 69010500



Abb.	Best.-Nr.	Beschreibung	Gerätetyp	Vergl.-Nr.
1	370363	Magnetventil		65110260
2	374033	Magnetventil, 3-fach	M_6IT, M_10IT, M_102T, M_20IT,	65110240
3	500568	Pumpe	M_202T	65110600
4	361058	Ansaugfilter		65110650



Abb.	Bestell-Nr.	Beschreibung	Gerätetyp	Vergl.-Nr.
1	690588	Griff		50001150, 58003170
2	690589	Buchse		50001140, 58000990
3	690599	Drehstift	RE24, RG24, ME15/21/24/40, MG15/21/24/40	50001170, 03200950
4	690590	Haken		50001160, 58004780
5	690591	Platte		50001190, 03200970

Komponenten (Mechanik)



Abb.	Bestell-Nr.	Beschreibung	Gerätetyp	Vergleichs-Nr.
1	690096	Scharnier (hinten)	106/110/210	10201190
2	690098	Scharnier (hinten)		10201330
3	690592	Stift		58002540
4	690593	Scheibe	210/220	58002570
5	690594	Druckschraube		58002560
6	690595	Gleitstück		58002550
7	690097	Scharnier (oben)	106-220	10201290
8	690099	Scharnierstift		58002150

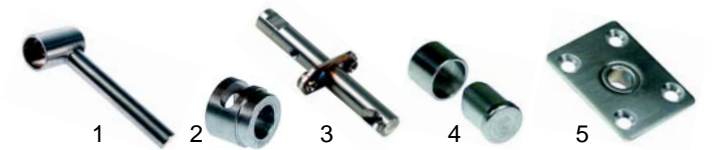

Abb.	Bestell-Nr.	Beschreibung	Gerätetyp	Vergleichs-Nr.
1	690586	Scharnier (unten)		11200560
2	690587	Scharnier (oben)	061/101/102	11200550
3	690099	Scharnierstift		58002150

Passend für Lainox



Abb.	Bestell-Nr.	Beschreibung	Gerätetyp	Vergleichs-Nr.
1	690087	Türgriff/kpl.		69015000
2	690090	Druckknopf		69031150, 50004050
3	690091	Feder		61620041, 50202710
4	690092	Kloben/kpl.	M_004-110,	10100110
5	690095	Feder	M_210, V_004-11, V_210	61620012, 50001196
6	690094	Stift		58002160, 50004040
7	690093	Nabe		58005050, 50004090
8	690597	Haken für Nabe		58002760



Abb.	Bestell-Nr.	Beschreibung	Gerätetyp	Vergl.-Nr.
1	690089	Türgriff/kpl.	M_120/220,	69015050
2	690590	Haken	V_120/220	58004780
3	690598	Platte	(1. Ausführung)	58003150

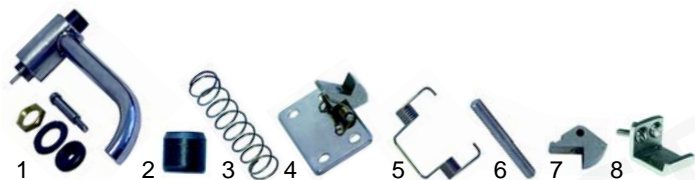

Abb.	Bestell-Nr.	Beschreibung	Gerätetyp	Vergl.-Nr.
1	690561	Türgriff/kpl.	M_15/24/40, P_15/24/40, R_15/24/40	58003171
2	690562	Türgriff/kpl.	M_120/220 (2. Ausführung)	58003180



Abb.	Bestell-Nr.	Beschreibung	Gerätetyp	Vergleichs-Nr.
1	690336	Türgriff		69010250
2	690337	Abdeckung		69010630
3	690338	Kloben, 1 Stufe		69010260
4	690339	Kloben, 2 Stufen		69010270

Türdichtungen

Dichtung kann (je nach Bestell-Nr.) 4-teilig oder als fertiger Rahmen geliefert werden



Pos.	B.-Nr.	Beschreibung	Gerätetyp	Vergleichs-Nr.
1	900136	565 x 365mm	FE05, FG05	70041200, 50505940
2	900138	380 x 320mm	FV03	70041210, 50505953
3	900156	380 x 710mm	FV06	70041220, 50505954
4	900158	565 x 380mm	RE05, RG05, ME05, MG05	70041250, 50505941
5	900485	480 x 650mm	RE07, RG07	70041270, 50505942
6	900159	590 x 710mm	RE10, RG10, ME10, MG10	70041290, 50505943
7	900161	700 x 700mm	RE20, RG20, ME2, MG20	70041330, 50505944
8	900139	710 x 870mm	RE24, RG24, ME24, MG24	70041370, 50505946
9	900165	645 x 1200mm	ME15, MG15	70041780, 50505945
10	900166	720 x 1440mm	ME21, MG21	70041820, 50505948
11	900137	735 x 1440mm	ME40, MG40	70041410, 50505947
12	900157	630 x 370mm	PE04, PG04	70041540, 50505950
13	900486	670 x 710mm	PE08, PG08	70041550, 50505951
14	900487	770 x 1200mm	PE12, PG12	70041560, 50505952
15	900059	Meterware	Universal	70041560, 50505952

Fensterdichtungen

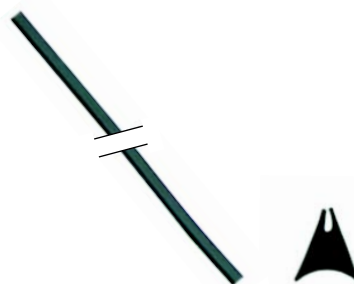

Pos.	Bestell-Nr.	Beschreibung	Gerätetyp	Ver.-Nr.
1	900119	1500mm	FE05, FG05, RE05, RG05, ME05, MG05, PE04, PG05	70040010, 50505821
2	900121	1690mm	RE07, RG07	70040080, 50505822
3	900481	2400mm	R_10/20/24, M_10/20/24, P_08	70040120, 50505823
4	900122	2125mm	RE40, RG40, ME21, MG21, ME40, MG40	70040200, 50505825
5	900482	1800mm	ME15, MG15, PE12, PG12	70040160, 50505824

Passend für Lainox

Türdichtungen

Dichtung kann (je nach Bestell-Nr.) 4-teilig oder als fertiger Rahmen geliefert werden

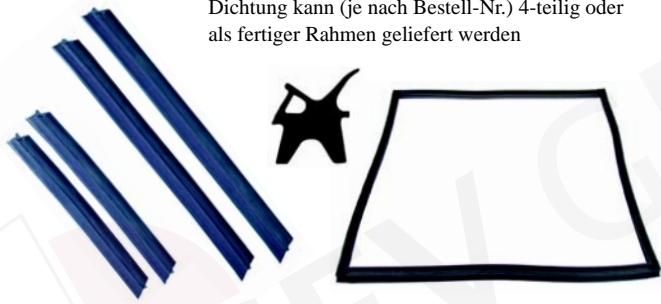

Pos.	Bestell-Nr.	Beschreibung	Gerätetyp	Vergl.-Nr.
1	900115	315 x 420mm	ME004/104, VE004/104	70041990
2	900116	380 x 605mm	M_105, V_105	70042000
3	900123	500 x 635mm	M_106, V_106	70042010
4	900124	625 x 735mm	M_110, V_110	70042020
5	900125	730 x 770mm	M_210, V_210	70042030
6	900126	715 x 1440mm	M_120, V_120	70042040
7	900127	730 x 1430mm	M_220, V_220	70042050
8	900059	Meterware		70041560

Gerätedichtungen



Pos.	Bestell-Nr.	Beschreibung	Gerätetyp	Vergl.-Nr.
1	900131	520 x 610mm	M_106, V_106	70040980
2	900132	625 x 750mm	M_110, V_110	70040990
3	900133	740 x 765mm	M_210, V_210	70041000
4	900134	680 x 1425mm	M_120, V_120	70041010
5	900135	700 x 1410mm	M_220, V_220	70041020
6	900142	Meterware	Universal	80100070

Fensterdichtungen



Pos.	Bestell-Nr.	Beschreibung	Gerätetyp	Vergl.-Nr.
1	900120	1175mm	ME004/104, VE004/104	70040050
1	900119	1500mm	M_105, V_105	70040010
2	900121	1690mm	M_106, V_106	70040080
3	900122	2125mm	M_110-220, V_110-220	70040200

Türdichtungen



Pos.	Bestell-Nr.	Beschreibung	Gerätetyp	Vergl.-Nr.
1	900488	395 x 425mm	VE042	70044330
2	900489	450 x 610mm	V_051	70044340
3	900490	530 x 630mm	M_061, V_061	70044100
4	900491	690 x 820mm	M_101, V_101	70044110
5	900492	710 x 820mm	M_102, V_102	70044120
6	900493	690 x 1550mm	M_201, V_201	70044130
7	900494	720 x 1550mm	M_202, V_202	70044140

Bedienungsblendedichtungen

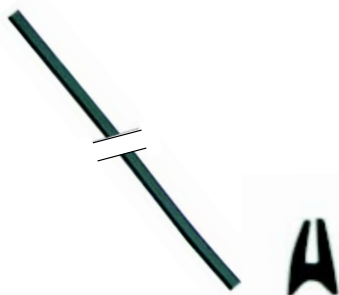

Pos.	Best.-Nr.	Beschreibung	Gerätetyp	V.-Nr.
1	900117	505mm	M_004/104, V_004/104	70040810
2	900118	595mm	M_105, V_105	70040820
3	900128	750mm	M_106, V_106	70040830
4	900129	1015mm	M_110/210, V_110/210	70040840
5	900130	1750mm	M_120/220, V_120/220	70040850
6	900143	Meterware	Universal	80100100

Fensterdichtungen

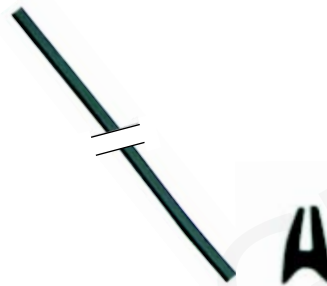

Pos.	Bestell-Nr.	Beschreibung	Gerätetyp	Vergl.-Nr.
1	900483	2400mm	M_061, V_061, M_101, V_101, M_102, V_102	70044150
2	900484	3720mm	M_201, V_201, M_202, V_202	70044160

Bedienungsblendedichtungen



Pos.	Bestell-Nr.	Beschreibung	Gerätetyp	Ver.-Nr.
1	900500	900mm	VE042, V_051/055, M_061, V_061	70044250
2	900501	1200mm	M_101, V_101	70044260
3	900502	1500mm	M_102, V_102	70044270
4	900503	1800mm	M_201, V_201	70044280
5	900504	1950mm	M_202, V_202	70044290
6	900143	Meterware	Universal	80100100



LAINOX®

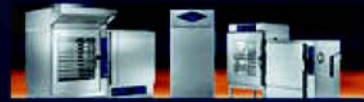

FIRMA UND GRUPPE



Seit über 20 Jahren glaubt Lainox fest an Synergien

1981: in Vittorio Veneto, Treviso – Italien wird die Firma Lainox gegründet. Lainox spezialisiert sich von Anfang an in der Entwicklung und Herstellung von Grossküchengeräten, insbesondere Heissluftdämpfer, zeichnet sich durch starkem unternehmerischen Geist und qualitative Innovationen aus, die es erlauben gleich erfolgreich zu sein und schnell beachtliche Marktquoten sowohl in Italien als auch im Ausland zu gewinnen.

Zu einem späteren Zeitpunkt zieht Lainox in die Ali SpA Gruppe ein, die wichtigste europäische Realität und eine der ersten weltweit im Bereich Grossküchentechnik. Die kontinuierliche Zusammenarbeit mit zahlreichen Spitzenchefs erlauben eine konstante Verbesserung und Vollendung der Produkte

MISSION: EXZELLENZ IN DER KÜCHE

Entwicklung, Innovation und Ausbildung sind die wichtigsten "Zutaten" der Lainox-Philosophie. Eine konsequente Wahl, die das Unternehmen dazu bewegt hat den Erwartungen der eigenen Kunden höchste Achtung zu widmen und ihre Bedürfnisse sogar im Voraus zu wecken. Die Mission "Exzellenz in der Küche" vereinigt in zwei Worten die ständige Verbesserung und den Mut den anspruchsvollsten Herausforderungen des Marktes gerecht zu werden. Lainox verfügt über das passende "Rezept" für alle Leute, die mit Leidenschaft in gewerblichen Küchen arbeiten, um eine gute, gesunde, vielseitige und kreative Küche anzubieten und Ihrer Professionalität und Phantasie stets einen wichtigen Platz gewähren.

DAS WAHRE INTEGRIERTE SYSTEM

Mit einem einzigen Namen, **Lainox Cooking System**, können sämtliche warme und kalte Vorgänge in der Küche bewältigt werden:

- garen → servieren,
- garen → warmhalten → servieren,
- garen → schockkühlen → gekühlt lagern → regenerieren → servieren



Mit seinen Produkten, technisch innovativ, kompatibel und integrierbar wie: HEISSLUFTDÄMPFER, HEISSLUFTÖFEN, SCHOCKKÜHL-SCHOCKGEFRIERGERÄTE, WARMHALTEGERÄTE, REGENERIERGERÄTE und BÄCKEREI-KONDITIONIERGERÄTE ist **Lainox** als einziges Unternehmen in der Lage komplette Garsysteme anzubieten, die integriert und universell arbeiten können und ein Referenzpunkt darstellen für Restaurant, Gastronomie, Catering und Bäckerei/Konditoreibetrieben.

LAINOX ALI SPA

Via Schiapparelli 15, Z.I. San Giacomo di Veglia - 31029 Vittorio Veneto (TV) – ITALY
Tel. +39 0438 9110 - Fax +39 0438 912300 - www.lainox.it - E-mail: lainox@lainox.it

P010105701

