



# Ersatzteile passend für: *Fagor*

## Ersatzteile passend für Blockgeräte



## Ersatzteile passend für Heißluftöfen und Combidämpfer



## Ersatzteile passend für Klein- und Einzelgeräte



**GEV GmbH**  
**Großküchen-Ersatzteil-Vertrieb**  
Robert-Koch-Straße 3a  
82152 Planegg/München  
Deutschland

Telefon: +49 (0)89 745572-0  
Telefax: +49 (0)89 745572-82  
E-Mail: [office@gev.at](mailto:office@gev.at)  
Internet: [www.gev-online.de](http://www.gev-online.de)



**GEV GmbH**  
**Ersatzteile und Zubehör**  
Kanalstrasse 14  
5745 Safenwil  
Schweiz

Telefon: +41 (0)62 797 87 70  
Telefax: +41 (0)62 797 25 07  
E-Mail: [info@gev.ch](mailto:info@gev.ch)  
Internet: [www.gev.ch](http://www.gev.ch)



**GEV Großküchen-**  
**Ersatzteil-Vertriebs GesmbH**  
Austraße 12  
5110 Oberndorf  
Österreich

Telefon: +43 (0)6272 6688-0  
Telefax: +41 (0)6272 6688-14  
E-Mail: [office@gev.at](mailto:office@gev.at)  
Internet: [www.gev.at](http://www.gev.at)

**Members of the GEV GROUP**

# INHALTSVERZEICHNIS

## Offene Kochstellen (Gas/Elektro)



ab Seite 4

## Backöfen (Gas/Elektro)

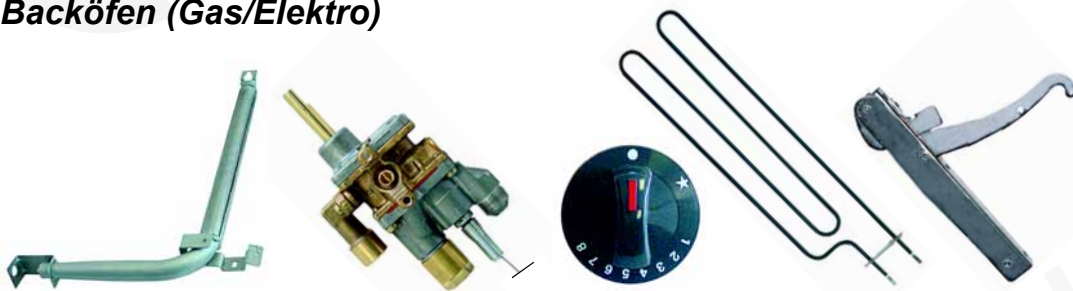

ab Seite 5

## Grillplatten (Gas/Elektro)



ab Seite 7

## Lavasteingrills (Gas)



ab Seite 8

## Bainmarie (Gas/Elektro)

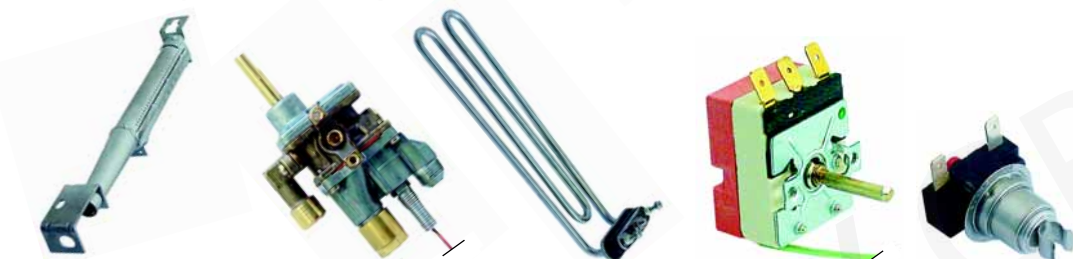

ab Seite 9



# INHALTSVERZEICHNIS

## Friteusen (Gas/Elektro)



ab Seite 10

## Kippbratpfannen (Gas/Elektro)



ab Seite 12

## Kochkessel (Gas/Elektro)



ab Seite 13

## Heißluftöfen und Combidämpfer (Gas/Elektro)

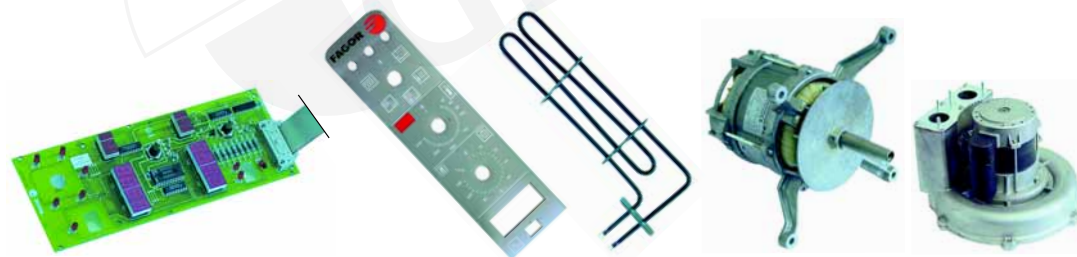

ab Seite 16

## Klein- und Einzelgeräte



ab Seite 22

## Offene Kochstellen (Gas)

Brenner, 4000kcal



Abb.	Bestell-Nr.	Beschreibung	Gerätetyp	Vergl.-Nr.
1	109005	Brennerdeckel	CG720, CG740, CG741, CGE741, CG920, CG940, CG941, CG960, CG961, CG982, CG9-20, CG9-40, CG9-41, CG9-60, CG9-61, CG9-82, CG1002, CG1502, CG9-51, CGE9-41	U445731
2	109004	Brennerpfeife		U445730
3	109001	Mischrohr		U125720
4	109003	Luftmischer		U265702

Brenner, 6000kcal, 8000kcal



Abb.	Bestell-Nr.	Beschreibung	Gerätetyp	Ver.-Nr.
1	109002	Brennerdeckel, 6000	CG720, CG740, CG741, CGE741, CG920, CG940, CG941, CG960, CG961, CG982, CG9-20, CG9-40, CG9-41, CG9-60, CG9-61, CG9-82, CG1002, CG1502, CG9-51, CGE9-41	U135702
1	109028	Brennerdeckel, 8000		U115732
2	109007	Brennerpfeife		U565701
3	109006	Venturirohr		U565700
4	109003	Luftmischer		U265702

Brenner, 10500kcal



Abb.	Bestell-Nr.	Beschreibung	Gerätetyp	Ver.-Nr.
1	109027	Brennerdeckel	CG9-40, CG9-41, CG9-60, CG9-61, CG9-92, CG1002, CG1502, CG9-51, CGE9-41	U235701
2	109026	Brennerpfeife		U235700
3	109025	Venturirohr		U235702
4	109024	Luftmischer		U235704



Abb.	Bestell-Nr.	Beschreibung	Gerätetyp	Vergleichs-Nr.
1	100042	Zündbrenner		U442134
2	102034	Thermoelement, M8 x 1, 600mm		U222100 U222130
2	102036	Thermoelement, M8 x 1, 1000mm		U262130



Abb.	Best.-Nr.	Beschreibung	Gerätetyp	V.-Nr.
1	109500	mit Kleinstelldüse, 0,55	CG720, CG740, CG741, CGE741	U262106
1	109501	mit Kleinstelldüse, 0,90		U262107
2	109503	mit Kleinstelldüse, 0,55	CG920, CG940, CG941, CG960, CG961, CG982, CG9-20, CG9-40, CG9-41, CG9-60, CG9-61, CG9-82, CG1002, CG1502, CG9-51, CGE9-41	U249401
2	109504	mit Kleinstelldüse, 0,60		U249402
2	109505	mit Kleinstelldüse, 1,30		U702101
3	113010	Knebel		U542100 U542101



Abb.	Best.-Nr.	Beschreibung	Gerätetyp	V.-Nr.
1	109702	Sternrost, 4000kcal	Geräte bis 31.08.2000	U745413
1	109701	Sternrost, 6000/8000kcal	CG720, CG740, CG741, CG761, CGE741	U745412
2	109700	Fortkochplatte		U745411



Abb.	Best.-Nr.	Beschreibung	Gerätetyp	V.-Nr.
1	109704	Auffangschale, 4000kcal	Geräte ab 1.7.2000	U745416
1	109703	Auffangschale, 6000kcal	CG720, CG740, CG741, CG761, CGE741	U745417
2	109705	Sternrost, 4000/6000kcal		U745415
3	109700	Fortkochplatte		U745411

Passend für Fagor





Abb.	Bestell-Nr.	Beschreibung	Gerätetyp	V.-Nr.
1	109710	Auffangschale, 4kcal	CG920, CG940, CG941, CG960, CG961, CG982, CG9-20, CG9-40, CG9-41, CG9-60, CG9-61, CG9-82, CG1002, CG1502, CG9-51, CGE9-41	U505408
1	109711	Auffangschale, 8000/10500kcal		U505409
2	109716	Sternrost		U565403
3	109709	Fortkochplatte		U565406
3	109712	Fortkochplatte über 2 Flammen	CG2000 CG2000/2P	U715400

## Offene Kochstellen, Glühplatten (Gas)



Abb.	Bestell-Nr.	Beschreibung	Gerätetyp	Vergl.-Nr.
1	109014	Brennerdeckel		U195701
2	109015	Brenner		U195702
3	109016	Venturi	CG710, CG711, CG910, CG911, CG9-10, CG9-11	U775701
3	109031	Venturi		U195704
4	109017	Düsenhalter		U615700



Abb.	Bestell-Nr.	Beschreibung	Gerätetyp	Vergl.-Nr.
1	100124	Zündbrenner		R202100
2	102034	Thermoelement, M8 x 1, 600mm	CG710, CG711	U222100
3	100139	Zündbrenner	CG910, CG911, CG9-10, CG9-11	U192104
2	102034	Thermoelement, M8 x 1, 600mm		U222130



Abb.	Bestell-Nr.	Beschreibung	Gerätetyp	Vergl.-Nr.
1	100707	Zündkerze		X012101
2	100016	Zündkabel, 900mm	CG910, CG911, CG9-10, CG9-11	U322030
3	100005	Piezozünder		S113034



Abb.	Bestell-Nr.	Beschreibung	Gerätetyp	Vergl.-Nr.
1	109502	Kleinstelldüse, 1,20	CG710, CG711	U772100
2	109508	Kleinstelldüse, 1,20	CG910, CG911, CG9-10, CG9-11	U222101
3	113010	Knebel		U542100 U542101

## Offene Kochstellen (Elektro)



Abb.	Best.-Nr.	Beschreibung	Gerätetyp	V.-Nr.
1	490012	145mm, 1500W/230V	CE740	U803002
1	490020	220mm, 2600W/230V	CE720, CE740, CE741	U803000
2	490070	300x300mm, 3000W/230V	CE9-20, CE9-40, CE9-41, CE920, CE940, CE941	U6733011 U673010
2	490071	300x300mm, 4000W/230V		
2	490073	300x300mm, 3000W/400V	CE920, CE940, CE941	U673012
2	490074	300x300mm, 3000W/400V		U673013

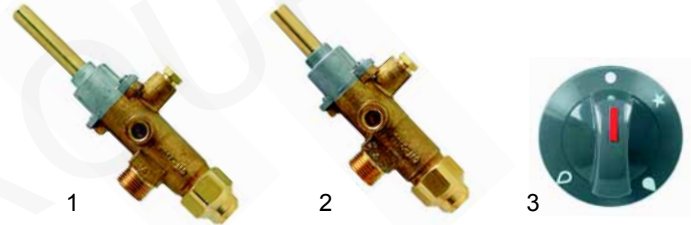

Abb.	Bestell-Nr.	Beschreibung	Gerätetyp	Vergl.-Nr.
1	300031	Siebentaktschalter	CE720, CE740, CE741, CE920, CE940, CE941, CE9-20, CE9-40, CE9-41	U673007 U673003 U673015
2	113012	Knebel		U673015
3	359048	Signallampe/gelb	CE9-41	Z203005

## Backöfen (Gas)



Abb.	Bestell-Nr.	Beschreibg.	Gerätetyp	V.-Nr.
1	109008	Brenner	CG711, CG741, CG761, CG9-41, CG9-61, CG9-82, CG9-51, CG9-11, HG9-10, HG9-20, FTG9-11	U745700
1	109009	Brenner	CG911, CG941, CG961, CG982, CG1002, CG1502	U329201 U855700
1	109010	Brenner	CG2000, CG2000/2P	U705700
2	109012	Brenner	CG1502	U855702
3	109013	Luftmischer		U325707



Abb.	Bestell-Nr.	Beschreibung	Gerätetyp	Vergl.-Nr.
1	100046	Zündbrenner	CG741, CG761, CG711	U322118
2	102038	Thermoelement, M8 x 1, 1500mm		U322130

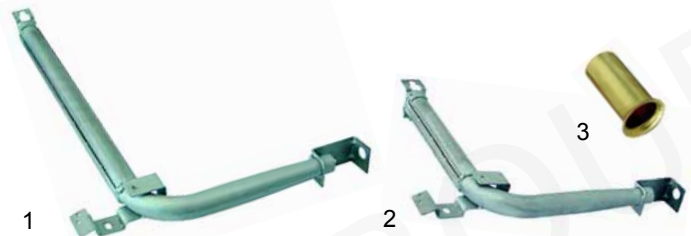

Abb.	Bestell-Nr.	Beschreibung	Gerätetyp	Vergl.-Nr.
1	109534	Gasthermostat		U329200 U742130
2	101537	Dichtung	CG741, CG761, CG711	Q307034
3	101538	Bügel		Z982018
4	113001	Knebel		R202103



Abb.	Bestell-Nr.	Beschreibung	Gerätetyp	Ver.-Nr.
1	100046	Zündbrenner	CG941, CG961, CG982, CG9-41, CG9-61, CG9-82, CG911, CG9-11, CG9-51, CG1002, CG1502, CG2000, CG200/2P, HE9-10, HE9-20	U322118
2	102042	Thermoelement, M9 x 1, 850mm		U562130
2	102043	Thermoelement, M9 x 1, 1000mm		U562120



Abb.	Bestell-Nr.	Beschreibung	Gerätetyp	Ver.-Nr.
1	101435	Minisit, 340°	CG941, CG961, CG982, CG9-41, CG-61, CG9-82, CG911, CG9-11, CG9-51, CG1002, CG1502, CG2000, CG2000/2P	U134316
2	101137	Abdeckung		U134318
3	110068	Knebel		U134317
4	101268	Winkel, 3/8"		U264300
5	100809	O-Ring		Q307041



Abb.	Best.-Nr.	Beschreibg.	Gerätetyp	Ver.-Nr.
1	100707	Zündkerze	CG941, CG961, CG982, CG9-41, CG9-61, CG9-82, CG911, CG9-11, CG9-51, CG1002, CG1502, CG2000, CG200/2P	X012101
2	100016	Zündkabel 900mm		U322030
3	100005	Piezozünder		S113034

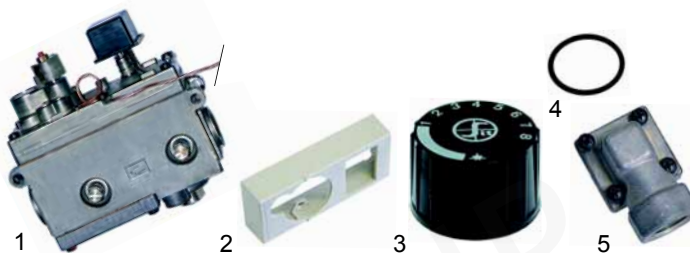

Abb.	Bestell-Nr.	Beschreibung	Gerätetyp	V.-Nr.
1	101125	Eurosit, 340°C	CG9-51, HG9-10, HG9-20	T982100
2	101358	Abdeckung mit Piezo	HG9-10, HG9-20	T982101
3	100006	Piezozünder	GG9-10, HG9-20	T982001
4	113022	Knebeladapter		U842100
5	113019	Knebel	CG9-51	U842101 U842102

## Backöfen (Elektro)



Abb.	Bestell-Nr.	Beschreibung	Gerätetyp	Vergl.-Nr.
1	416018	1000W/230V	CE741, CE9-41, CGE9-41, HE9-10, HE9-20	U803004
2	416608	1000W/230V	CE941	U183030

Passend für Fagor



Abb.	Bestell-Nr.	Beschreibung	Gerätetyp	Ver.-Nr.
1	345409	Schalter		U673006
2	113013	Knebel	CE741, CE941, CE9-41, HE9-10, HE9-20, CGE9-41	U673016 U673004
3	359048	Signallampe/gelb		Z203005
4	359027	Signallampe/grün		Z203004

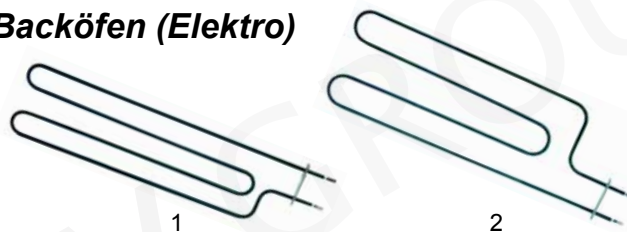

Abb.	Bestell-Nr.	Beschreibung	Gerätetyp	Ver.-Nr.
1	375128	Thermostat, 310°C, 55.13063.160	CE741, CE941, CE9-41, HE9-10, HE9-20, CGE9-41	X153000
2	113014	Knebel		U673005 R212101
3	380237	Schütz		Z213007

## Backöfen (Mechanik)

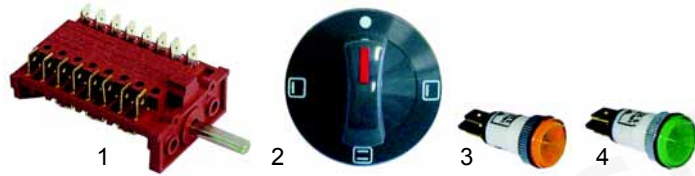

Abb.	Bestell-Nr.	Beschreibung	Gerätetyp	Vergleichs-Nr.
1	700006	Türscharnier/rechts		U010504
2	700007	Türscharnier/links		U010511
3	700001	Gegenstück		U010512
4	691003	Blende		U105100



Pos.	Bestell-Nr.	Beschreibung	Gerätetyp	Vergleichs-Nr.
1	691027	Türdichtung		U745626

## Grillplatten (Gas)



Abb.	Bestell-Nr.	Beschreibung	Gerätetyp	Ver.-Nr.
1	109018	Brenner	FTG705, FTG710	R795700
1	109030	Brenner	FTG905, FTG910, FTG9-05, FTG9-10, FTG9-11	R635700
2	109013	Luftmischer		U325707



Abb.	Bestell-Nr.	Beschreibung	Gerätetyp	Ver.-Nr.
1	100046	Zündbrenner	FTG705, FTG710	U322118
2	102034	Thermoelement, M8 x 1, 600mm	FTG905, FTG910, FTG9-05, FTG9-10, FTG9-11	U222100 U222130



Abb.	Bestell-Nr.	Beschreibung	Gerätetyp	Ver.-Nr.
1	100707	Zündkerze	FTG905, FTG910,	X012101
2	100016	Zündkabel, 900mm	FTG9-05, FTG9-10, FTG9-11	R613030
3	100005	Piezozünder		S113034



Abb.	Bestell-Nr.	Beschreibung	Gerätetyp	Ver.-Nr.
1	109509	Gashahn, mit Kleinbranddüse, 0,8	FTG905, FTG910, FTG9-05, FTG9-10	R612100
2	113010	Knebel		U542100 U542101



## Lavasteingrills (Gas)



Abb.	Bestell-Nr.	Beschreibung	Gerätetyp	Ver.-Nr.
1	109534	Thermostat mit Kleinbranddüse 0,5	FTG705, FTG710	U329200 U741130
1	109514	Thermostat	FTG905, FTG910, FTG9-05, FTG9-10, FTG9-11	R612101
2	101537	Dichtung		Q307034
3	101538	Bügel		Z982018
4	113001	Knebel		R202103



Abb.	Bestell-Nr.	Beschreibung	Gerätetyp	Vergleichs-Nr.
1	109020	Brenner		T035700
2	109707	Rost (Steine)	BG705, BG710	T035406
3	109708	Rost (Fleisch)		T035425
4	109013	Mischhülse		U325707

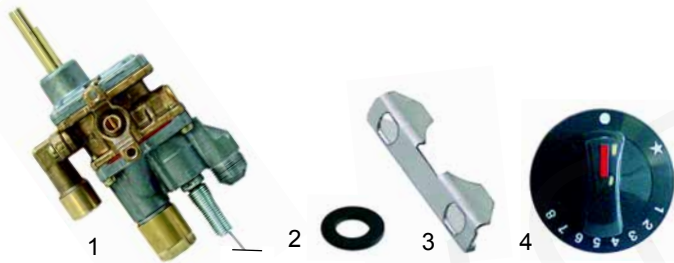

Abb.	Bestell-Nr.	Beschreibung	Gerätetyp	Vergl.-Nr.
1	109034	Brenner		T055701
2	109714	Rost (Steine)	BG9-05, BG9-10	T055405
3	109013	Mischhülse		U325707

## Grillplatten (Elektro)

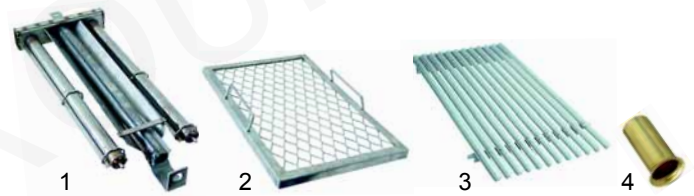

Abb.	Bestell-Nr.	Beschreibung	Gerätetyp	Ver.-Nr.
1	416602	1500W/230V	FTE705, FTE710	R893000
2	416610	1500W/230V	FTE905, FTE910	R573000
2	416633	2000W/230V	FTE9-05, FTE9-10	R573010

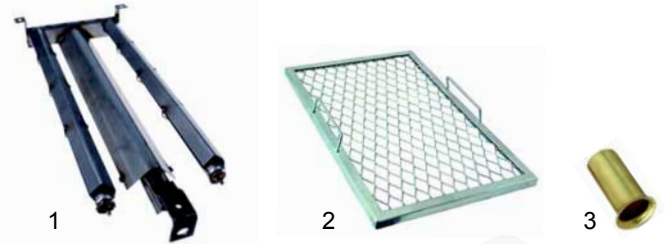

Abb.	Bestell-Nr.	Beschreibung	Gerätetyp	Ver.-Nr.
1	345402	Vorsatzschalter		X163007
2	691005	Bügel		X313001
3	113014	Knebel	FTE705, FTE710, FTE905, FTE910, FTE9-05, FTE9-10	U673005 R212101
4	359048	Signallampe, gelb		Z203005
5	359027	Signallampe, grün		Z203004

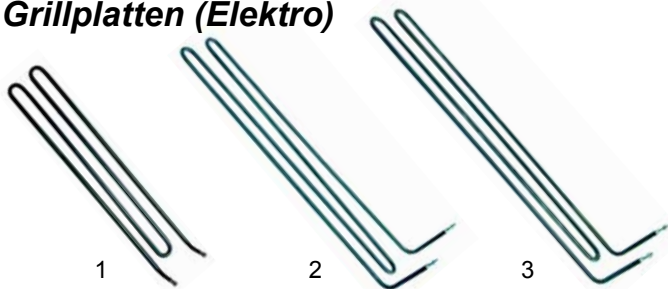

Abb.	Best.-Nr.	Beschreibung	Gerätetyp	Ver.-Nr.
1	375128	Thermostat. 310°C, 55.13063.160		X153000
2	375121	Sicherheitsthermostat, 420°C, 55.13583.010	FTE705, FTE710, FTE905, FTE910, FTE9-05, FTE9-10	R612103
3	380237	Schütz		Z213007
4	550411	Klemmleiste, 6-polig		R253044



Abb.	Bestell-Nr.	Beschreibung	Gerätetyp	Vergleichs-Nr.
1	109715	Griffverlängerung		T055439
2	110703	Griff, M10		T055440 T055434 T055411

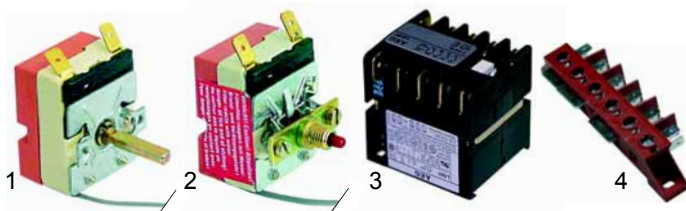

Abb.	Bestell-Nr.	Beschreibung	Gerätetyp	Vergl.-Nr.
1	100046	Zündbrenner	BG705, BG710, BG505, BG510, BG9-05, BG9-10	U322118
2	102034	Thermoelement, M9 x 1, 600mm		U222100

Passend für Fagor

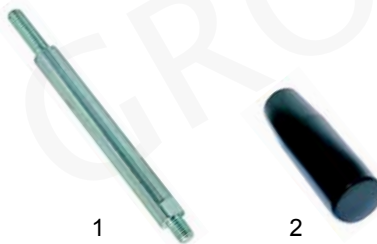



Abb.	Bestell-Nr.	Beschreibung	Gerätetyp	Vergl.-Nr.
1	100707	Zündkerze		X012101
2	100016	Zündkabel, 900mm	BG905, BG910, BG9-05, BG9-10	R613030
3	100005	Piezozünder		S113034



Abb.	Bestell-Nr.	Beschreibung	Gerätetyp	V.-Nr.
1	100707	Zündkerze		X012101
2	100016	Zündkabel, 900mm	BMG905, BMG910, BMG9-05, BMG9-10	U322030
3	100005	Piezozünder		S11034



Abb.	Bestell-Nr.	Beschreibung	Gerätetyp	V.-Nr.
1	109513	Gashahn, PEL22, mit Kleinbranddüse, 1,1	BG705, BG710	T032101
1	109510	Gashahn, PEL22, mit Kleinbranddüse, 1,3	BG905, BG910, BG9-05, BG9-10	T052100
2	113008	Knebel		S312102



Abb.	Bestell-Nr.	Beschreibung	Gerätetyp	Ver.-Nr.
1	101533	Thermostat		R432102
2	101537	Dichtung	BMG710, BMG905, BMG905, BMG9-05, BMG9-10	Q307034
3	101538	Schelle		Z982018
4	113001	Knebel		R202103

## Bainmarie (Gas)

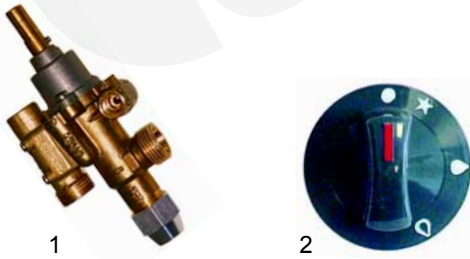

Abb.	Bestell-Nr.	Beschreibung	Gerätetyp	Vergleichs-Nr.
1	109035	Brenner	BMG905, BMG9-05	R495700
2	109021	Brenner	BMG710, BMG910, BMG9-10	R405700

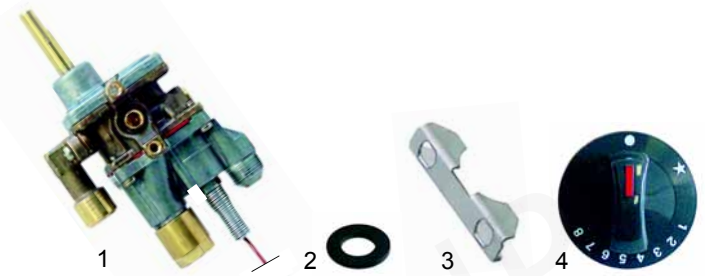
## Bainmarie (Elektro)



Abb.	Bestell-Nr.	Beschreibung	Gerätetyp	Ver.-Nr.
1	416605	2000W/230V	MME705, BME710, BME910, BME9-10, BME905, BME9-05	R223005
2	416382	2800W/230V		Z203601
3	505208	Halter		Z603602



Abb.	Bestell-Nr.	Beschreibung	Gerätetyp	Vergleichs-Nr.
1	100124	Zündbrenner	BMG710, BMG905, BMG905, BMG9-05, BMG9-10	R202100
2	102034	Thermoelement, M8 x 1, 600mm		U222100



Abb.	Bestell-Nr.	Beschreibung	Gerätetyp	Ver.-Nr.
1	345402	Vorsatzschalter		X163007
2	691005	Bügel	BME705, BME710, BME905, BME910, BME9-05, BME9-10	X313001
3	359048	Signallampe, gelb		Z203005
4	359027	Signallampe, grün		Z203004

## Friteusen (Gas)



Abb.	Best.-Nr.	Beschreibung	Gerätetyp	Ver.-Nr.
1	375130	Thermostat, 90°C, 55.13219.320	BME705, BME710, BME905, BME910, BME9-05, BME9-10	Z203014
2	113002	Knebel		R212100
3	390451	Sicherheitsthermostat	BME9-05, BME9-10	R213004
4	505093	Dichtung		N503017



Abb.	Bestell-Nr.	Beschreibung	Gerätetyp	Vergleichs-Nr.
1	109019	Brenner	FG710, FG720, FD920, FG940, FG9-20, FG9-40	X015700

Passend für Fagor

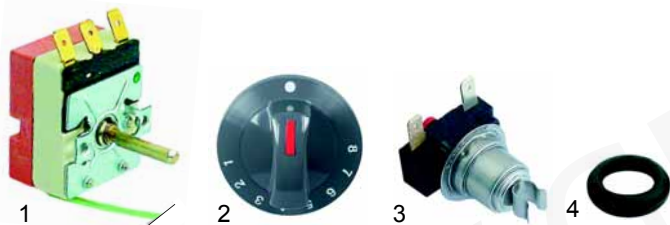

Abb.	Best.-Nr.	Beschreibung	Gerätetyp	Ver.-Nr.
1	550278	Klemmleiste, 3-polig	BME705, BME710, BME905, BME910, BME9-05, BME9-10	U183046
2	550411	Klemmleiste, 6-polig		R253044
3	380237	Schütz		Z213007



Abb.	Bestell-Nr.	Beschreibung	Gerätetyp	V.-Nr.
1	100837	Oberteil		X012117
2	100855	Halter, 3-teilig	FG710, FG720, FD920, FG940, FG9-20, FG9-40	X012126
3	100881	Zündbrenner		U562130
4	102042	Thermoelement, 850mm		X162120

## Bainmarie (Mechanik)

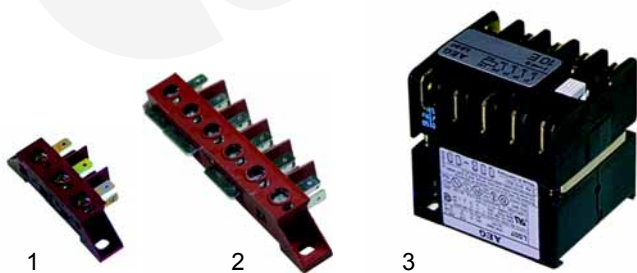

Abb.	Bestell-Nr.	Beschreibung	Gerätetyp	Vergleichs-Nr.
1	691013	Hahn, kpl.		S112151
2	691024	Überlaufrohr		R205018
3	505177	O-Ring		Q307050



Abb.	Bestell-Nr.	Beschreibung	Gerätetyp	Vergl.-Nr.
1	100707	Zündkerze	FG710, FG720, FD920, FG940, FG9-20, FG9-40	X012101
2	100142	Zündkabel		
3	101007	Zündgruppe		R073007



Abb.	Bestell-Nr.	Beschreibung	Gerätetyp	Vergl.-Nr.
1	101162	Novasitregler	FG710, FG720, FD920, FG940, FG9-20, FG9-40	X163000
2	101312	Mikroschalter		R275027
3	101317	Kabel		X163008





Abb.	Bestell-Nr.	Beschreibung	Gerätetyp	Ver.-Nr.
1	345402	Vorsatzschalter	FG710, FG720,	X163007
2	375204	Thermostat, 60-215°C, 55.13042.290	FD920, FG940, FG9-20, FG9-40	X163010
3	113018	Knebel		X313002 X162100



Abb.	Bestell-Nr.	Beschreibung	Gerätetyp	Vergl.-Nr.
1	345402	Vorsatzschalter		X163007
2	375204	Thermostat 55.13042.290	FE710, FE920, FE9-05, FE9-10, FE9-055	X163010
3	113017	Knebel		X183020 X183025

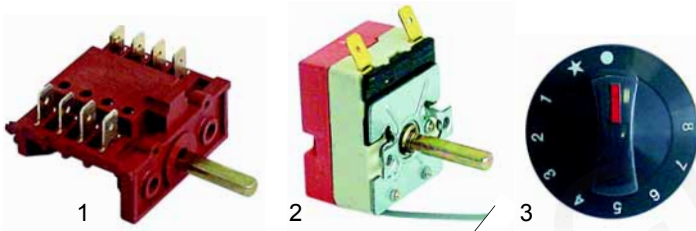

Abb.	Bestell-Nr.	Beschreibung	Gerätetyp	Ver.-Nr.
1	375205	Sicherheitsthermostat, 245°C, 55.13542.110	FG710, FG720,	X012130
2	359048	Signallampe, gelb	FD920, FG940, FG9-20, FG9-40	Z203005
3	359027	Signallampe, grün		Z203004
4	550278	Klemmleiste, 3-polig		U183046

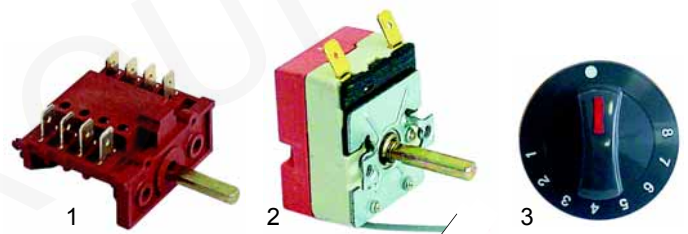

Abb.	Bestell-Nr.	Beschreibung	Gerätetyp	Vergl.-Nr.
1	375205	Sicherheitsthermostat 55.13542.110, 245°C	FE710, FE920	X012130
1	375131	Sicherheitsthermostat 55.13542.250, 245°C	FE9-05, FE9-10, FE9-05S	X163040
2	359048	Signallampe, gelb	FE710, FE920	Z203005
3	359027	Signallampe, grün	FE9-05, FE9-10, FE9-055	Z203004

## Friteusen (Elektro)



Abb.	Bestell-Nr.	Beschreibung	Gerätetyp	Ver.-Nr.
1	416603	4000W/230V, Mitte/rechts	FE710	X323001
2	416604	4000W/230V, Mitte/links		X323002

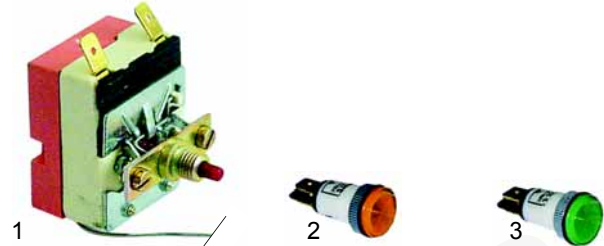

Abb.	Bestell-Nr.	Beschreibung	Gerätetyp	Vergl.-Nr.
1	380244	Schütz	FE710	R663031
2	380264	Schütz	FE920, FE9-05, FE9-10, FE9-055	X183011
3	345250	Mikroschalter	FE710, FE920, FE9-05, FE9-10, FE9-055	R010534

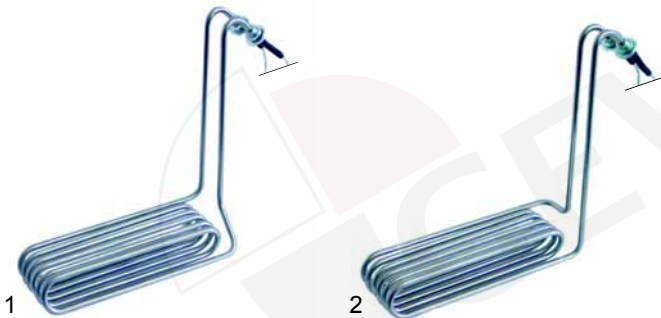

Abb.	Bestell-Nr.	Beschreibung	Gerätetyp	Vergl.-Nr.
1	416611	6000W/230V	FE920	X183000
2	416612	6000W/230V	FE9-20, FE9-10, FE910S	X183021

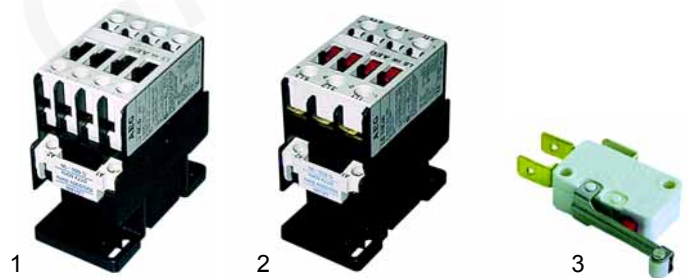

Abb.	Bestell-Nr.	Beschreibung	Gerätetyp	Vergl.-Nr.
1	691023	Friteusenkorb	FG710, FG720, FE710	X316503
2	691007	Sieb		X316502

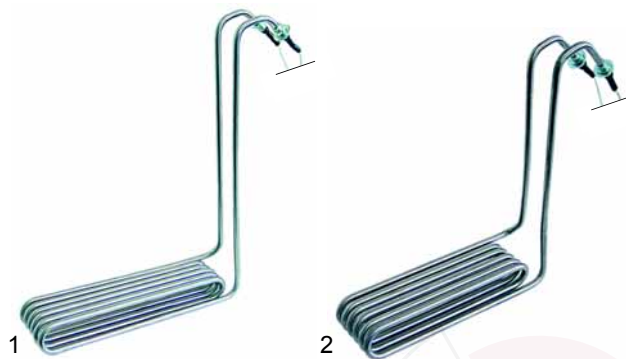

Abb.	Bestell-Nr.	Beschreibung	Gerätetyp	Vergleichs-Nr.
1	101162	Novasit 820 0820010/ 080018		X163000
2	101359	Verlängerung	SBG__	X262100
3	101312	Mikroschalter		R275027

Passend für Fagor

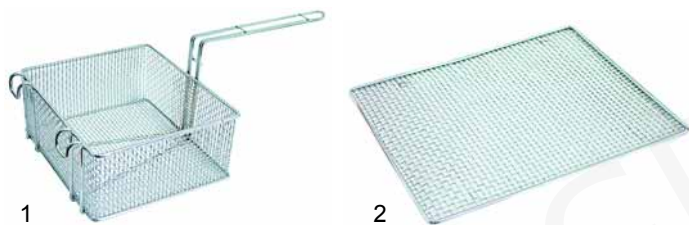

Abb.	Bestell-Nr.	Beschreibung	Gerätetyp	Vergl.-Nr.
1	691020	Friteusenkorb	FG920, FG940, FE920, FG9-05, FE9-10, FE9-05, FE9-10	X066590
2	691009	Friteusenkorb	FG9-10, FE9-05, FE9-10	X066595
3	691021	Sieb	FG920, FG940, FE920	X166503
3	691022	Sieb	FG9-05, FG9-10, FE9-10	X166522
3	505143	Sieb	FE9-05, FE9-10	X186522



Abb.	Bestell-Nr.	Beschreibung	Gerätetyp	Ver.-Nr.
1	101305	Anschluss, gerade, 1/2"		X153005
2	101306	Anschluss, gewinkelt, 1/2"	SBG__	X262100
3	101065	Magnetspule		R275027

## Kippbratpfannen (Gas)



Abb.	Bestell-Nr.	Beschreibung	Gerätetyp	Vergleichs-Nr.
1	100046	Zündbrenner		U322118
2	102042	Thermoelement, M9x1, 850mm	SBG__	X152120 U562130



Abb.	Bestell-Nr.	Beschreibung	Gerätetyp	Vergleichs-Nr.
1	345402	Vorsatzschalter		X163007
2	691005	Bügel	SBG__	X313001
3	113015	Knebel		X152111
4	359048	Signallampe/gelb		Z203005
5	359027	Signallampe/grün		Z203004



Abb.	Bestell-Nr.	Beschreibung	Gerätetyp	Vergl.-Nr.
1	100707	Zündkerze		X012101
2	100015	Zündkabel, 600mm	SBG__	R613030
3	101007	Zündgruppe		R073007



Abb.	Best.-Nr.	Beschreibung	Gerätetyp	Ver.-Nr.
1	375128	Thermostat, 310°C 55.13063.160		X153110
2	375121	Sicherheitsthermostat, 420°C 55.13583.010	SBG__	R612103



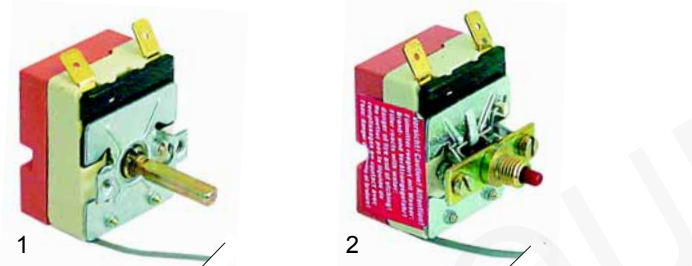

Abb.	Bestell-Nr.	Beschreibung	Gerätetyp	Vergl.-Nr.
1	345427	Mikroschalter	SBG__1	X343015
2	550278	Klemmleiste, 3-polig		U183046

## Kippbratpfannen (Elektro)



Abb.	Bestell-Nr.	Beschreibung	Gerätetyp	Vergleichs-Nr.
1	416607	2000W/230V	SBE710	X27300
2	416615	2000W/230V	SBE910, SBE910__	X143000
3	416616	2000W/230V	SBE9__	143010

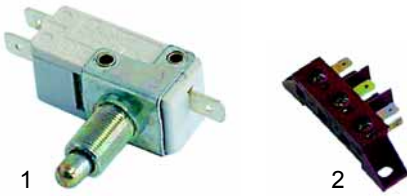

Abb.	Bestell-Nr.	Beschreibung	Gerätetyp	Vergleichs-Nr.
1	345402	Vorsatzschalter		X163007
2	691005	Bügel		X313001
3	113014	Knebel	SBE__	U673005 R212101
4	359048	Signallampe/gelb		Z203005
5	359027	Signallampe/grün		Z203004

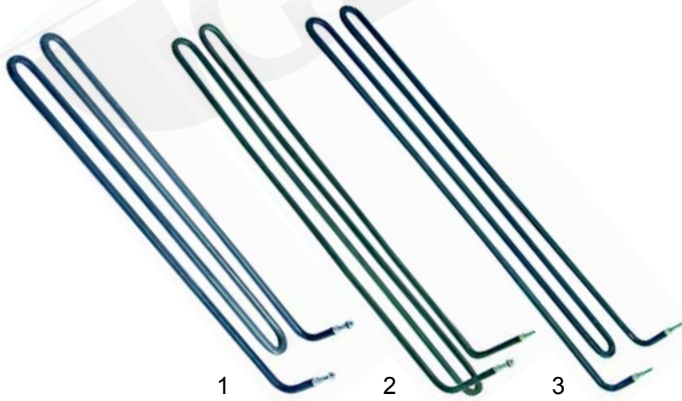

Abb.	Best.-Nr.	Beschreibung	Gerätetyp	Ver.-Nr.
1	375128	Thermostat, 310°C 55.13063.160		X153000
2	375121	Sicherheitsthermostat, 420°C 55.13583.010	SBE	R612103
3	345427	Mikroschalter		X343015

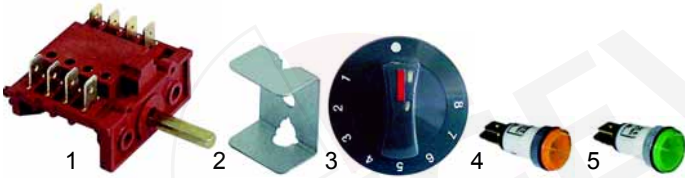

Abb.	Best.-Nr.	Beschreibung	Gerätetyp	Ver.-Nr.
1	380244	Schütz	SBE7__, SBE910__, SBE9-10__, SBE9-15__	R663031
2	380264	Schütz		X183011

## Kippbratpfannen (Mechanik)

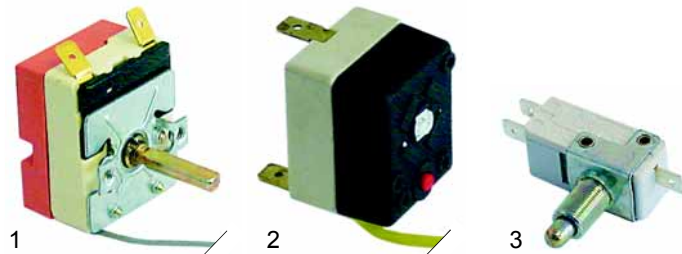

Abb.	Bestell-Nr.	Beschreibung	Gerätetyp	Vergleichs-Nr.
1	345423	Schalter (Kippung)		X343002
2	500348	Motor	SBE__M, SBG__M,	X343000
3	365029	Kondensator, 5µF		X343001



Abb.	Bestell-Nr.	Beschreibung	Gerätetyp	Vergleichs-Nr.
1	691016	Deckelfeder		S116121
2	690085	Handrad	SBE__ SBG__	X156139 X156117
3	691037	Handgriff		X156135

## Kochkessel (Gas)

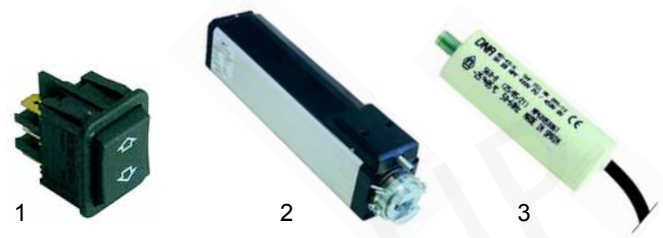

Abb.	Best.-Nr.	Beschreibung	Gerätetyp	Ver.-Nr.
1	109038	Brenner	MG9__BM, MG9__, MPG9__, MPG9__BM	S275705
2	109022	Luftmischhülse		

## Kochkessel (Elektro)



Abb.	Best.-Nr.	Beschreibung	Gerätetyp	Ver.-Nr.
1	100124	Zündbrenner		R202100
2	102124	Thermoelement mit Unterbrechung, M8x1	MG_ , MG_BM, MPG_ , MPG_BM	X022130
3	102034	Thermoelement, M8x1 600mm		U222100



Abb.	B.-Nr.	Beschreibung	Gerätetyp	V.-Nr.
1	416606	3 x 3000W/230V	ME710BM	R143000
2	416614	9600W/230-400V	ME910BM, ME915BM, ME9-10BM, ME9-15BM, MPE9-10BM, MPE9-15BM	Z721701
3	691014	Dichtung		R145012
4	691033	Dichtung		Q307035

F

Passend für Fagor



Abb.	Best.-Nr.	Beschreibung	Gerätetyp	Ver.-Nr.
1	100707	Zündkerze	MG9_ , MG+9_BM, X012101	
2	100016	Zündkabel	MPG9_ , MPG9_BM	U323030
3	100005	Piezozünder		S113034



Abb.	Best.-Nr.	Beschreibung	Gerätetyp	Ver.-Nr.
1	380015	Energieregler		S333001
2	113009	Knebel	ME_BM, ME9_BM, MPE9_BM	S333005, S333006
3	359048	Signallampe, gelb		Z203005
4	359027	Signallampe, grün		Z203004



Abb.	Bestell-Nr.	Beschreibung	Gerätetyp	Vergleichs-Nr.
1	101093	PEL23, mit Kleinbranddüse, 1,40		S312101
2	113008	Knebel	S312102, S312110	



Pos.	B.-Nr.	Beschreibung	Gerätetyp	V.-Nr.
1	375122	Sicherheitsthermostat	MG_BM, MPG_BM	X033001



Abb.	Best.-Nr.	Beschreibung	Gerätetyp	V.-Nr.
1	390453	Sicherheitsthermostat		R343124
2	380264	Schütz	ME_BM, ME9_BM, MPE9_BM	X18301
3	541025	Pressostat		S093000



## Kochkessel (Mechanik)

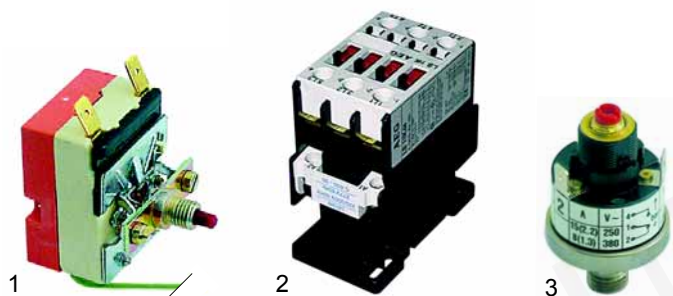

Abb.	Best.-Nr.	Beschreibung	Gerätetyp	Ver.-Nr.
1	691067	Scharnierfeder	MG7_, MG7__BM	S316110
2	691016	Scharnierfeder	MG9_, MG9__BM, MPG9_, MPG9__BM	S116121
3	691032	Scharnierfeder	MPG9__	S136080



Abb.	Bestell-Nr.	Beschreibung	Gerätetyp	Vergl.-Nr.
1	691013	Hahn, kpl., 1/2"	Universal	S112151
2	691012	Probierhahn		S022104
3	691015	Schwenkauslauf, 1/2"		S052100

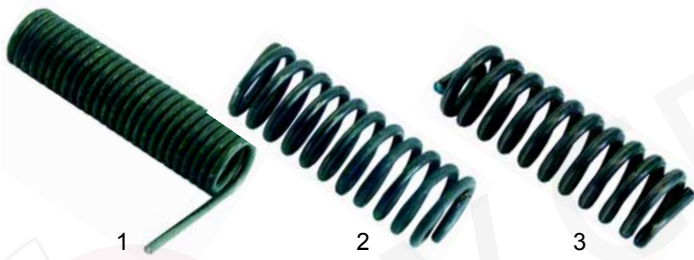

Abb.	Bestell-Nr.	Beschreibung	Gerätetyp	Vergl.-Nr.
1	540132	Entleerhahn, 1 1/2"	Universal	S312100
2	540267	Entleerhahn, 2"		S112150



Abb.	Bestell-Nr.	Beschreibung	Gerätetyp	Vergl.-Nr.
1	691025	Dichtung	Universal	S112150
2	691011	Feder		S112105



Abb.	Bestell-Nr.	Beschreibung	Gerätetyp	Ver.-Nr.
1	540823	Sicherheitsventil, 3/4"	Universal	S022101
2	540827	Be- und Entlüftungsventil		S022103

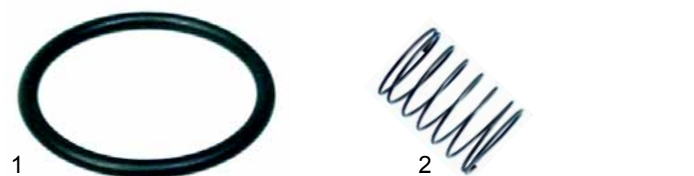

Abb.	Bestell-Nr.	Beschreibung	Gerätetyp	Ver.-Nr.
1	540828	Manometer, Syphon, 3/8"	Universal	S022102
2	541062	Manometer		9220815



Abb.	Bestell-Nr.	Beschreibung	Gerätetyp	Vergleichs-Nr.
1	540832	Armaturträger	Universal	S332100
2	540822	Armaturträger		S022100

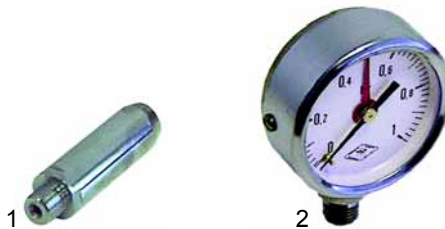

Abb.	Bestell-Nr.	Beschreibung	Gerätetyp	Vergleichs-Nr.
1	691070	Schauglasschutz	Universal	S292600 S042647N
2	691031	Schauglas/kpl.		S082100
3	691071	Schauglas		S042102
4	691072	Winkel-Schauglas		S042101
5	691010	Schauglasdichtung		Q307069

## Komponenten (Elektro)



Abb.	Bestell-Nr.	Beschreibung	Gerätetyp	Vergleichs-Nr.
1	345681	Wahlschalter	HMM- / -	R743002
2	345686	Leistungsschalter		R753000
3	691074	Dichtung		R663046
4	113005	Knebel		R663062

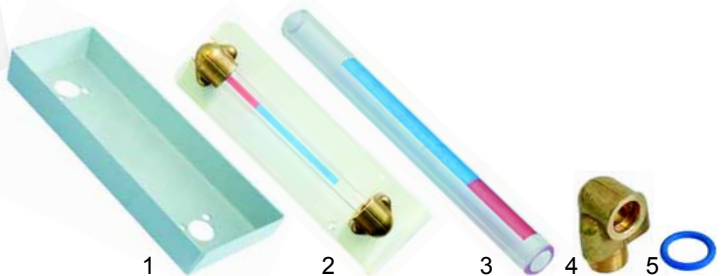

Abb.	Bestell-Nr.	Beschreibung	Gerätetyp	Ver.-Nr.
1	400860	Thermostatplatte, 270°C		R743013
2	113004	Führung	HMM- / -	R662809
3	691075	Scheibe	HMI- / -	R662810
4	691076	Dichtung	HCG- / -	R663045
5	113021	Knebel	HMG- / -	R663063

Passend für Fagor

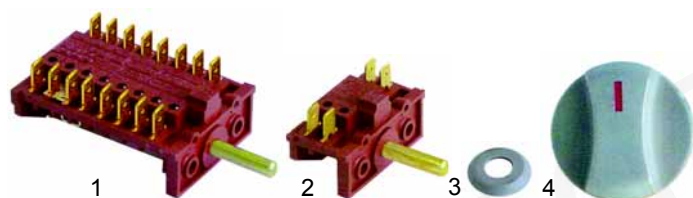

Abb.	Best.-Nr.	Beschreibung	Gerätetyp	Vergl.-Nr.
1	345683	Wahlschalter	HME- / - HMP- / -	R663025
2	345684	Nockenschalter		R663026
3	691074	Dichtung		R663046
4	113005	Knebel		R663062



Abb.	Bestell-Nr.	Beschreibung	Gerätetyp	Vergleichs.-Nr.
1	350066	Zeitschalter	HMM- / -	R723000
2	691074	Dichtung	HMI- / -	R663046
3	113005	Knebel	HCG- / -	R663062

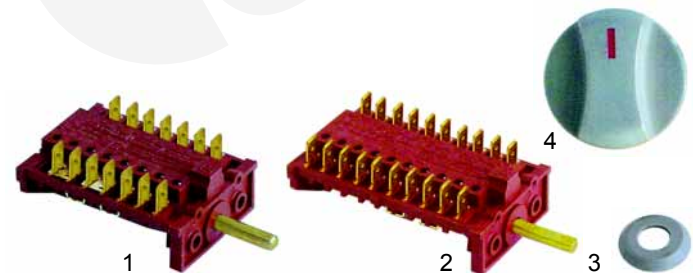

Abb.	Bestell-Nr.	Beschreibung	Gerätetyp	Vergleichs-Nr.
1	345685	Wahlschalter	HMI- / -	R693004
2	345686	Leistungsschalter		R753000
3	691074	Dichtung		R663046
4	113005	Knebel		R663062



Abb.	Bestell-Nr.	Beschreibung	Gerätetyp	Vergleichs.-Nr.
1	379018	Regler, J/12V	HMM- / -	R743005
2	301066	Schalter	HMG- / -	R743008

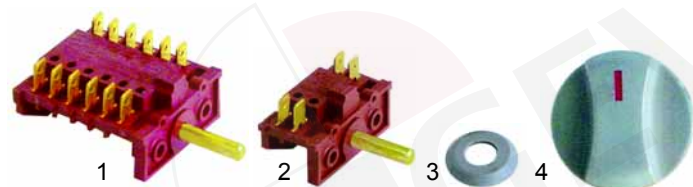

Abb.	Bestell-Nr.	Beschreibung	Gerätetyp	Vergleichs-Nr.
1	345687	Wahlschalter	HCG- / -	T013001
2	345688	Wahlschalter	HMG- / -	R723011
3	691074	Dichtung	HCG- / -	R663046
4	113005	Knebel	HMG- / -	R663062



Abb.	Bestell-Nr.	Beschreibung	Gerätetyp	Ver.-Nr.
1	345689	Wippentaster	HCG- / - HMG- / -	R723270
2	345690	Taster	HME- / - HMI- / - HMG- / -	R663032
3	359048	Signallampe/gelb	HMM- / - HMI- / -	Z203005
4	359027	Signallampe/grün	HCG- / - HMG- / -	Z203004



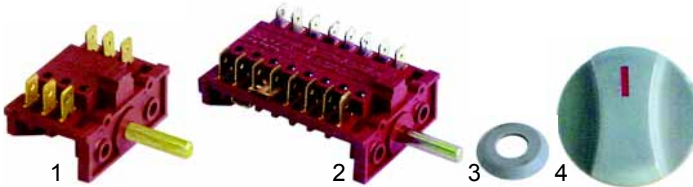

Abb.	Bestell-Nr.	Beschreibung	Gerätetyp	Vergl.-Nr.
1	400861	Bedienplatine		R663050
2	400862	Kontrollplatine	HME-/_/ HMP-/_/_	R663051 R663044 R663085
3	400863	Programmierplatine	HMP-/_/_	R663004

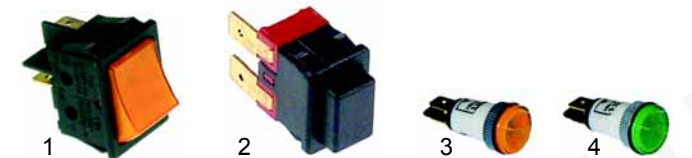

Abb.	Bestell-Nr.	Beschreibung	Gerätetyp	Ver.-Nr.
1	400864	Frontfolie	HMM-/_/HCM/_/_	R743012 R723022
2	400865	Frontfolie	HME-/_/_/HMP-/_/_	R673000

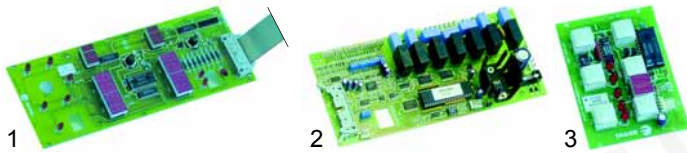

Abb.	Bestell-Nr.	Beschreibung	Gerätetyp	Vergleichs-Nr.
1	400866	Frontfolie	HMI-/_/_	R693030
1	400867	Frontfolie	HCG-/_/_	T013006



Abb.	Bestell-Nr.	Beschreibung	Gerätetyp	Ver.-Nr.
1	400869	Frontfolie	HMM-/_/_/HMI-/_/_	R693000
2	400870	Frontfolie	HMP-/_/_	R663010



Abb.	Bestell-Nr.	Beschreibung	Gerätetyp	Vergleichs-Nr.
1	400871	Frontfolie	HCG-/_/_	R723008
2	400872	Frontfolie	HCM-/_/_	R663014



Abb.	Best.-Nr.	Beschreibung	Gerätetyp	Ver.-Nr.
1	400873	Fühler/ Thermoelement, 2500mm	HMM-/_/_/HME-/_/_/ HMP-/_/_/HMI-/_/_/ HCG-/_/_/HMG-/_/_	R663089
1	400874	Fühler/Thermoelement, 1500mm	HME-/_/_/HMP-/_/_	R663090
2	400875	Kerntemperaturfühler/ Thermoelement J	HMM-6/_/_/HME-6/_/_/ HMP-6/_/_/HMG-6/_/_	R663015 R663059
2	400876	Kerntemperaturfühler/ Thermoelement J	HMM-10/_/_/HME-10/_/_/ HMP-10/_/_/HMG-10/_/_	R673001 R673091
2	400877	Kerntemperaturfühler/ Thermoelement J	HMM-20/_/_/HME-20/_/_/ HMP-20/_/_/HMG-20/_/_	R093012 R093000 R093019



Abb.	Best.-Nr.	Beschreibung	Gerätetyp	Ver.-Nr.
1	691084	Fühlerdurchfüh- rungsplatte	HMM-/_/_/HME-/_/_/ HMP-/_/_/HMI-/_/_/ HCG-/_/_/HCM-/_/_	R662659
2	691085	Doppelkonus		R662652
3	691086	Überwurfschraube		R662629
4	691087	Silikondichtung	HME-/HMP-	R012623

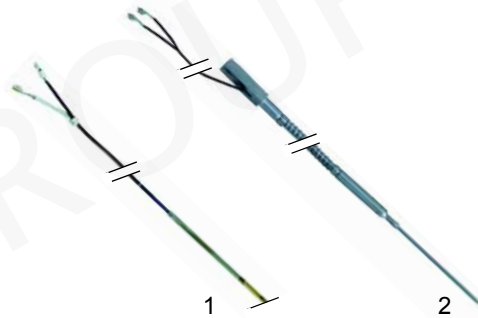

Abb.	Bestell-Nr.	Beschreibung	Gerätetyp	Ver.-Nr.
1	400878	Verbindungskabel	HME-/_/_/HMP-/_/_	R663102
2	400879	Alarmplatine	HCG-/_/_	R723033
3	350067	Summer	HMG-/_/_	R693067



Abb.	Bestell-Nr.	Beschreibung	Gerätetyp	Ver.-Nr.
1	350068	Summer	HMI-/_/_/HMM-/_/_	Z683081
2	380136	Socket, 1-polig		R743009
3	400880	Niveauregler	HMM-/_/_	R343072

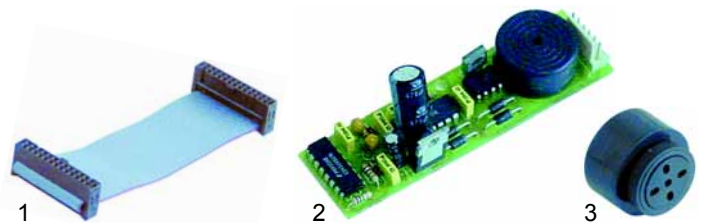

Abb.	Bestell-Nr.	Beschreibung	Gerätetyp	Ver.-Nr.
1	359432	Lampenfassung	HMM- /_, HME- /_, HMP- /_, HMI- /_, HCG- /_, HMG- /_	R663058
2	359596	Halogenlampe, 12V/20W		R663013
3	359433	Dichtung		R663535



Abb.	B.-Nr.	Eingang	Ausgang	Gerätetyp	V.-Nr.
1	400887	230VAC	12VAC	HMM- /_, HME- /_, HMP- /_, HMI- /_, HCB- /_, HMG- /_	R663039
2	400888	230V	230VAC	HCG- /_, HMG- /_	R723044



Abb.	Bestell-Nr.	Beschreibung	Gerätetyp	Vergleichs-Nr.
1	400881	Zeitrelais	HCG- /_, HMG- /_	R013030
2	541304	Pressostat		R663535 660535



Abb.	Bestell-Nr.	Beschreibung	Gerätetyp	Vergl.-Nr.
1	375413	Sicherheitsthermostat 55.13522.380	HMM- /_, HME- /_, HMP- /_	R343124
2	375414	Kondensator-Thermostat 55.13219.310		R343100



Abb.	Bestell-Nr.	Beschreibung	Gerätetyp	Vergleichs-Nr.
1	400882	Verschraubung		R345058
2	400883	Isolierung		R345059
3	400884	Elektrode, 106	HMM- /_, HME- /_, HMP- /_	R345060
4	400885	Elektrode, 116		R345063
5	400886	Elektrode, 131		R345064

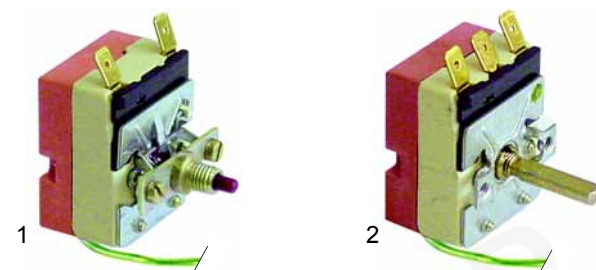

Abb.	Best.-Nr.	Beschreibung	Gerätetyp	Ver.-Nr.
1	375415	Dampf-Thermostat 55.13229.060	HMM- /_, HMI- /_	R343018
2	375416	Sicherheitsthermostat	HMM- /_, HME- /_, HMD- /_, HMI- /_, HCG- /_, HCM- /_	R343016

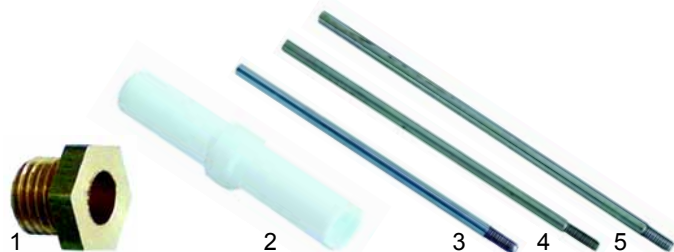

Abb.	Bestell-Nr.	Beschreibung	Gerätetyp	Ver.-Nr.
1	691059	Hubmagnet	HMM, HME, HMP, HMI	R663030
2	691052	Hubmagnet	HMG-6/_ , HMG-10/_	R723012
3	691057	Hubmagnet	HMG-20/_	R723060



Abb.	Bestell-Nr.	Beschreibung	Gerätetyp	Ver.-Nr.
1	691084	Fühlerdurchführungsplatte		R662659
2	691087	Silikondichtung		R012623
3	691086	Überwurfschraube		R662629

Passend für Fagor



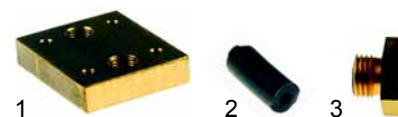

Abb.	Bestell-Nr.	Beschreibung	Gerätetyp	Ver.-Nr.
1	345250	Mikroschalter	HMM- /-, HME- /-, HMP- /-, HMS- /-	R010534
2	691077	Isolierscheibe	HCG- /-, HCM- /-	R010535
3	691078	Druckfeder		Z700603
4	691079	Druckstift		R010533



Abb.	Bestell-Nr.	Beschreibung	Gerätetyp	Ver.-Nr.
1	416606	3 x 3000W/230V	HMM- /-, HME- /-, HMP- /-	R143000
2	691014	Dichtung		R145012

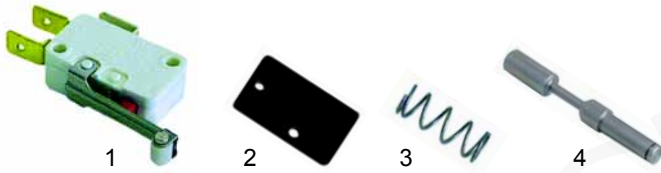

Abb.	Bestell-Nr.	Kontakte	AC1	AC2	Gerätetyp	Ver.-Nr.
1	380244	3S-1S	20A	4kW	HMM- /-, HME- /-, HMP- /-, HMI- /-	R663031
2	380264	3S	45A	11kW	HMM-10 /-, HMM-20 /-, HME-10 /-, HME-20 /-, HMP-10 /-, HMP-20 /-	R673007 R143002
3	380237	3S-1Ö	16A	3kW	HCG- /-, HMG- /-	Z213007



Abb.	B.-Nr.	Beschreibung	Gerätetyp	Ver.-Nr.
1	416634	1500W/230V	HMM-6/11, HME-6/11, HMP-6/11, HMI-6/11	R663016
2	416620	2 x 1500W/230V	HMM-10/11, HME-10/11, HMP-10/11, HMI-10/11	R673002
2	416019	2 x 2000W/230V	HMM-10/11, 10/21 - 20/21 HME-10/11, 10/21 - 20/21 HMP-10/11, 10/21 - 20/21 HMI-10/11, 10/21 - 20/21	R683000
3	416621	2 x 2000W/230V	HMM-20/11, HME-20/11, HMP-20/11	R093002



Abb.	Bestell-Nr.	Beschreibung	Gerätetyp	Ver.-Nr.
1	370017	Einfach, 230V	HMM, HME, HMP, HMI, HCG	Z701135
2	370021	Zweifach, 230V	HME, HMP, HMG	P255001
3	691080	Reduzierung, 3L/min.		P443042
4	691081	Reduzierung, 0,25L/min.		R665041
5	691082	Reduzierung, 8L/min.		Z601156
6	691083	Reduzierung, 0,5L/min.		R715011

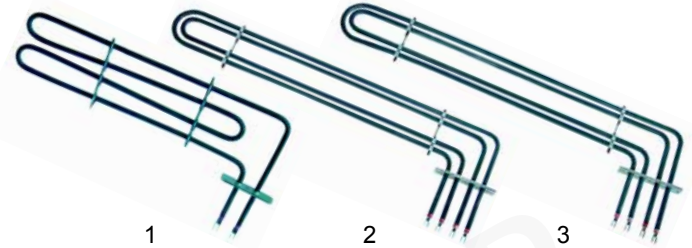

Abb.	Bestell-Nr.	Beschreibung	Gerätetyp	Vergl.-Nr.
1	500505	230V/400V, L72AW4D-014	HMM, HMT, HCG, HMG	R253049
1	500506	230V/3-phasig, L7mW84D-380	HME, HMP	R663034
1	500507	400V/3-phasig, L7mW84D-379 2 Geschwindigkeiten	HME, HMP	R663033
2	691049	Motordichtung		R662627

Passend für Fagor

## Komponenten (Mechanik)

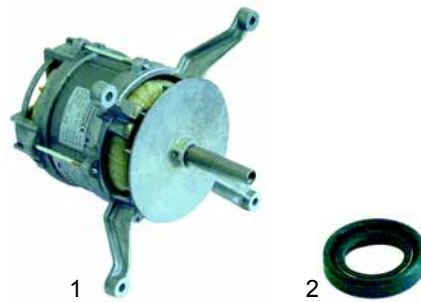

Abb.	Bestell-Nr.	Beschreibung	Gerätetyp	Vergl.-Nr.
1	601080	Ventilator		Z103066
2	550536	Sicherungsklemmleiste		R073005



Abb.	Bestell-Nr.	Beschreibung	Gerätetyp	Vergleichs-Nr.
1	691044	Türgriff		R660532
2	690042	Getriebe		R260543
3	690041	Riegelstück		R260544
4	690040	Kloben		R260545

## Komponenten (Gas)



Abb.	Bestell-Nr.	Beschreibung	Gerätetyp	Ver.-Nr.
1	101684	Ventil-Set 830, 220/240V, Sit.0830034		Z952201
2	101569	Feuerungsautomat, 50A72-250-04		R723032

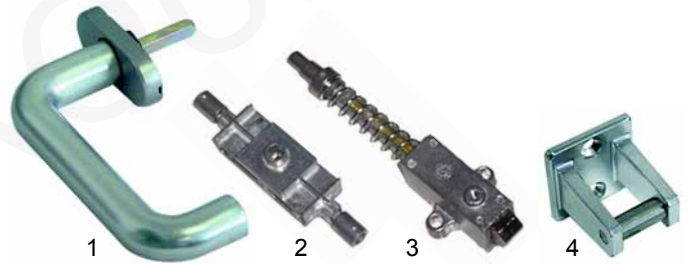

Abb.	Bestell-Nr.	Beschreibung	Gerätetyp	Vergleichs-Nr.
1	691088	Scharnier/oben		R660517
2	691089	Scharnierstift		R660534
3	691090	Feder		Z850519



Abb.	Best.-Nr.	Beschreibung	Gerätetyp	V.-Nr.
1	691053	Brennergebläse	HCG-6/11, HCG-10/11, HCG-10/21, HCG2-10/11, HMG-6/11, HMG-10/11, HMG-10/21, HMG2-10/11	R723003
2	365020	Kondensator, 14µF		R293000
3	691058	Brennergebläse		T093001
4	365035	Kondensator, 30µF	HCG-20/11,	T093005



Abb.	Bestell-Nr.	Beschreibung	Gerätetyp	Vergleichs-Nr.
1	691091	Scharnier/unten		R660507
2	691092	Führung		R660531
3	691093	Scharnierstift		R660504
4	691043	Feder		R010511



Abb.	Bestell-Nr.	Beschreibung	Gerätetyp	V.-Nr.
1	100757	Glühelektrode		R725005
2	100758	Überwachungselektrode	6/11, 10/11, 10/21, 2-10/11	R725014
3	100759	Überwachungselektrode	20/11	T115059 T135705



**Tür**

Türdichtung

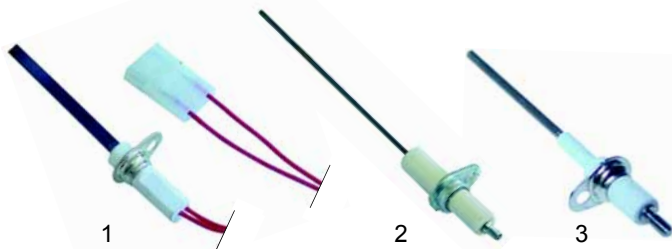

Pos.	Bestell-Nr.	Beschreibung	Gerätetyp	Vergl.-Nr.
1	691035	650 x 465	6/11	R660503
2	691036	705 x 650	10/10	R670500
3	691069	705 x 775	10/21, 2-10/11	R680500
4	691055	1300 x 650	20/11	R090510
5	691062	1300 x 775	20/21	R140506

Fensterdichtung



Abb.	Bestell-Nr.	Beschreibung	Gerätetyp	V.-Nr.
1	691038	Innen, 2500mm	6/11	R660500
1	691096	Innen, 3000mm	10/10	R670529
1	691040	Innen, 3200mm	10/21, 2	R680515
1	691061	Innen, 4100mm	20/11	R090515
1	691063	Innen, 4600mm	20/21	R140508
2	691041	Außen, 1700mm	6/11	R660501
2	691042	Außen, 2000mm	10/11, 10/21, 2-10/11, 20/11, 20/21	R670528



Abb.	Bestell-Nr.	Beschreibung	Gerätetyp	Vergleichs-Nr.
1	691048	Handbrause		R095005
2	691094	Halter		R095007
3	691095	Schlauch		R095006

## Hockerkocher (Gas)

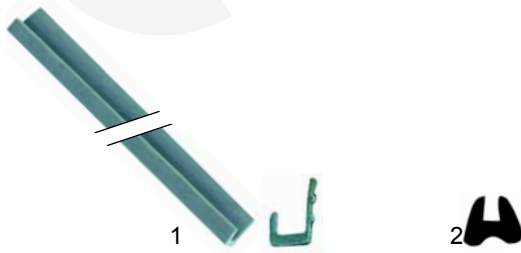

Abb.	Bestell-Nr.	Beschreibung	Gerätetyp	Vergleichs-Nr.
1	109014	Brennerdeckel	HP/G-15	U195701
2	109015	Brenner		U195702
3	109016	Venturi		U775701
4	109017	Düsenhalter		U615700



Abb.	Bestell-Nr.	Beschreibung	Gerätetyp	Vergl.-Nr.
1	301047	Schalter	FE4, FE6, FE8, FE18, FE25	Z853001
2	345427	Mikroschalter		X343015 R703096
3	375123	Thermostat, 215°C, 55.13039.120		X03300

Passend für Fagor



Abb.	Bestell-Nr.	Beschreibung	Gerätetyp	Vergl.-Nr.
1	102806	Zündbrenner	HP/G-15	R302130
2	102034	Thermoelement, 600mm		U222100
3	109508	Gashahn		U222101
4	113010	Knebel		U542100

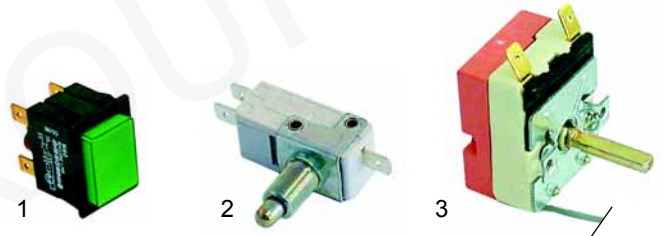

Abb.	Bestell-Nr.	Beschreibung	Gerätetyp	Vergl.-Nr.
1	113003	Knebel	Geräte bis 9.2000 FE4, FE6, FE8, FE18, FE25	R343043
2	550438	Indikator		Z603052
3	359148	Signallampe/gelb		R343123
4	359149	Signallampe/grün		R343125

## Friteusen (Elektro)



Abb.	Bestell-Nr.	Beschreibung	Gerätetyp	Vergleichs-Nr.
1	416622	3000W/230V	FE4	X353005 X353024
2	416627	1500W/230V	FE6	X363005 X363023
3	416628	2000W/230V	FE8	X373005 X373022



Abb.	Bestell-Nr.	Beschreibung	Gerätetyp	Vergl.-Nr.
1	113005	Knebel	ab 10.2000	R663062
2	359027	Signallampe, grün	FE4, FE6, FE8, FE18, FE25	Z203004
3	359048	Signallampe, gelb		Z203005



Abb.	Bestell-Nr.	Beschreibung	Gerätetyp	Vergleichs-Nr.
1	416630	3000W/230V	FE18	X383020 X383005
2	416632	4250W/230V	FE25	X393021 X393010



Abb.	Bestell-Nr.	Beschreibung	Gerätetyp	Ver.-Nr.
1	375122	Sicherheitsthermostat	FE4, FE6, FE8, FE18, FE25	X033001
2	550278	Klemmleiste, 3-polig	FE4	U183046
3	550411	Klemmleiste, 6-polig	FE6, FE8	R253044





1

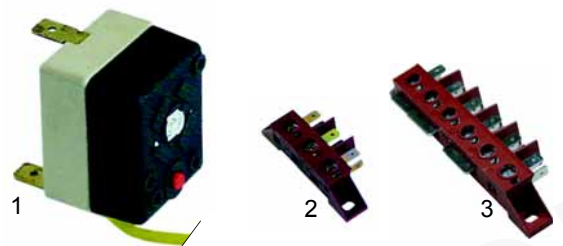

2

Abb.	Bestell-Nr.	Beschreibung	Gerätetyp	Vergleichs-Nr.
1	380212	Schütz	FE6, FE8	P453023
2	380244	Schütz	FE18, FE25	R663031



1



2

Abb.	Bestell-Nr.	Beschreibung	Gerätetyp	Vergl.-Nr.
1	691001	Griff-Kunststoffoberteil	FE4, FE6, FE8	9616402
2	691002	Griff-Kunststoffunterteil		9616401

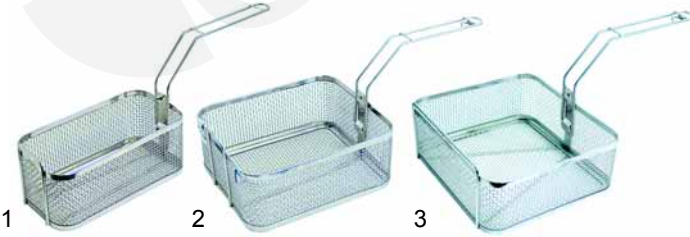

1

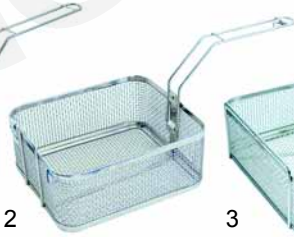

2



3

Abb.	Bestell-Nr.	Beschreibung	Gerätetyp	Vergleichs-Nr.
1	505130	Friteusenkorb	FE4	X356502
2	691065	Friteusenkorb	FE6	X366502
3	691066	Friteusenkorb	FE8	X376502



1



2



3

Abb.	Bestell-Nr.	Beschreibung	Gerätetyp	Vergleichs-Nr.
1	505129	Friteusenkorb	FE18	X386501
2	505131	Friteusenkorb		X399901
3	691006	Friteusenkorb	FE25	X396501

F

Passend für Fagor

