

Bitte ausfüllen und zurück an: info.ch@repagroup.com

ANFRAGE BESTELLUNG

Firma/Adresse
Firmenstempel

Name des Bearbeiters

Kundennummer

Ihre Auftragsnummer/Kommission

Lieferadresse (falls sie von der Rechnungsadresse abweicht)

Maße

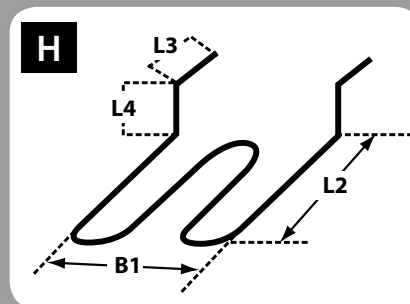
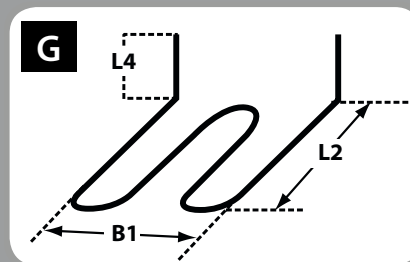
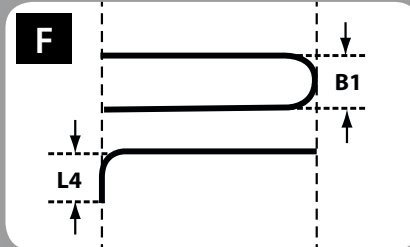
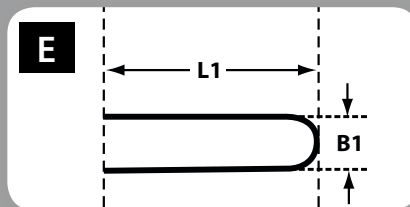
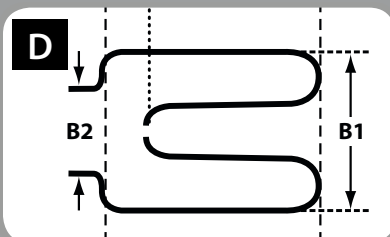
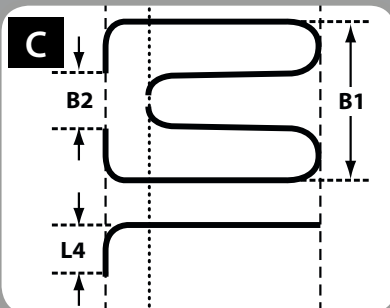
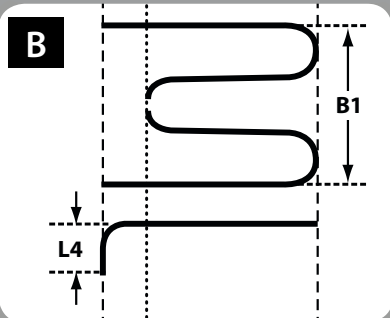
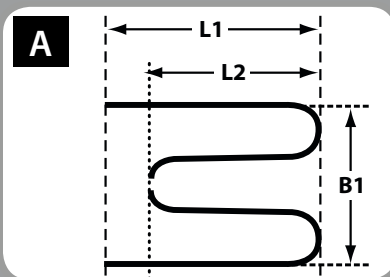

Anzahl:

..... Stück

Version:

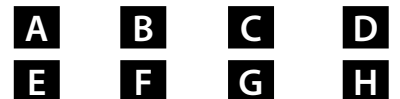

Maße :

(Rohrende – ohne Keramik)

L1: mm

L2: mm

L3: mm

L4: mm

B1: mm

B2: mm

HEIZKÖRPER NACH MASS



Bitte ausfüllen und zurück an: info.ch@repagroup.com

Anschlussstyp

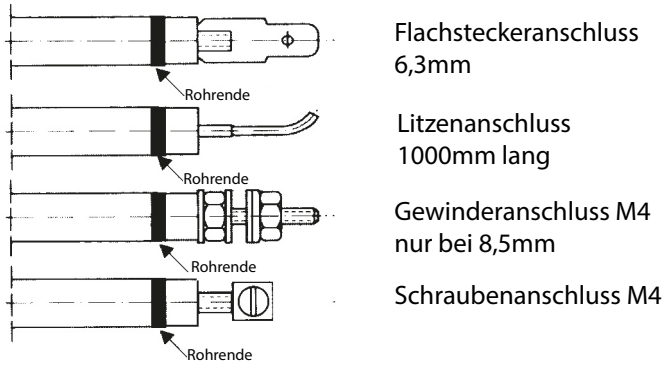

Flachsteckeranschluss
6,3mm

Litzenanschluss
1000mm lang

Gewinderanschluss M4
nur bei 8,5mm

Schraubenanschluss M4

Verschraubungsvariante

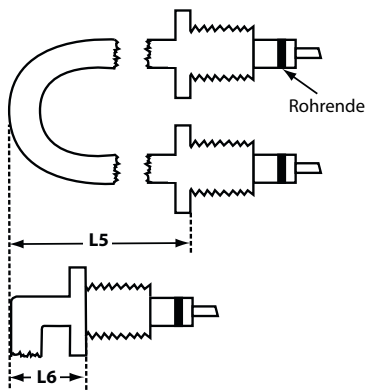

M10 x 1
(nur Ø 6,5mm)

M12 x 1

M14 x 1,5

L5:mm

L6:mm

Technische Daten

MEDIUM:

In Wasser:
Material AISI 316TI 6,5mm 8,5mm

In Öl/Lauge/Salzwasser:
Material INCOLOY 825 6,5mm 8,5mm

In Luft:
Material AISI 309F 6,5mm 8,5mm
Material Kupfer
verchromt

Spannung: 230V 400V

Leistung: W

Anzahl Windungen:
(z. B. E = 1 Windung, A = 2 Windungen)

DEMANDE PRIX

COMMANDE

Société/Adresse
 Tampon de la société

Contact

N° de client

N° de votre commande

Adresse de livraison
 (si différente de l'adresse de facturation)

Dimensions

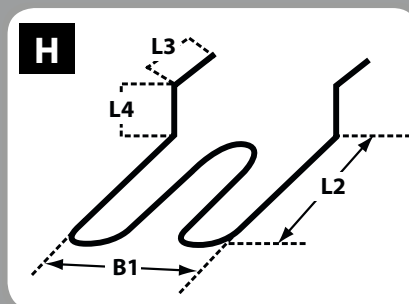
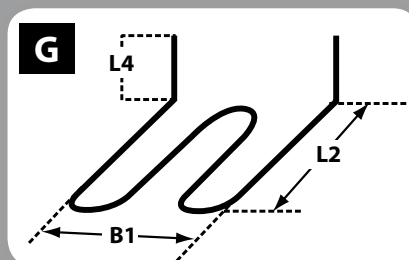
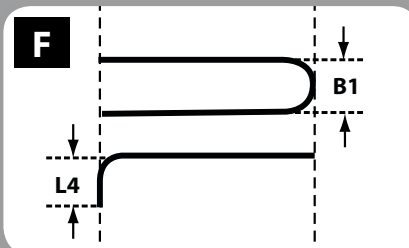
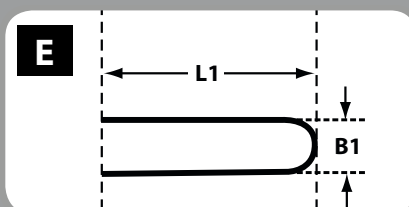
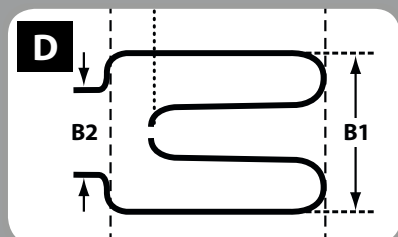
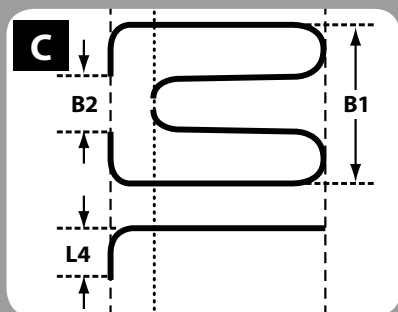
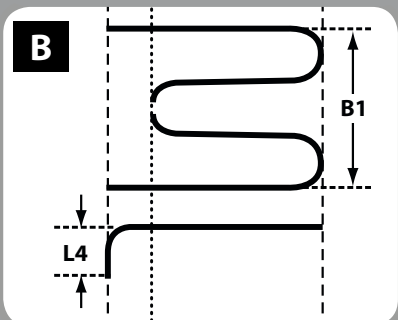
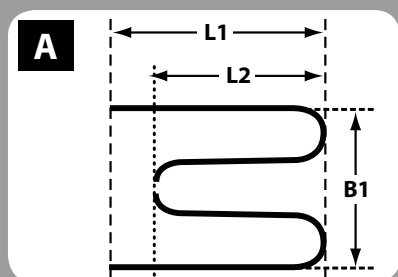

Quantité: pièce(s)

Version:



Dimensions :
 (fin de tube sans céramique)

L1: mm
 L2: mm
 L3: mm
 L4: mm

B1: mm
 B2: mm

type de raccordement

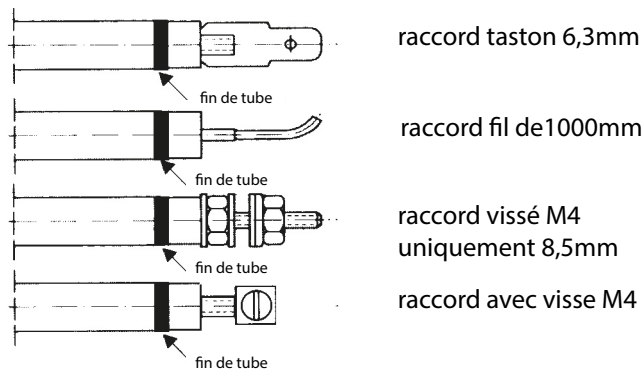

données techniques

MEDIUM:

eau :
matériau AISI 316TI 6,5mm 8,5mm

huile - eau avec détergent-eau salée :
matériau INCOLOY 825 6,5mm 8,5mm

air :
matériau AISI 309F 6,5mm 8,5mm
matériau cuivre chromé 8,5mm

tension : 230V 400V

puissance : W

nombre de boucles:
 (exemple : Modèle E = 1 boucle, A = 2 boucles)

divers raccords à visse

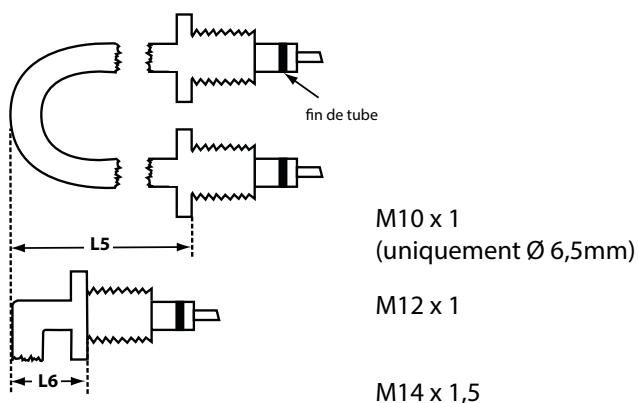

M10 x 1
 (uniquement Ø 6,5mm)

M12 x 1

M14 x 1,5

L5:mm

L6:mm